

UNDERGRADUATE CATALOG: 2003 – 2004



Worcester Polytechnic Institute

The University of Science and Technology. And Life.™

CHRONOLOGY OF ACADEMIC SCHEDULE AND EVENTS

2002-2003 Academic Year

January 6-10	Web Enrollment for Spring Semester
January 8	Deadline for Completion of Degree Requirement Forms for February 2003 Candidates
January 9	First Day of Classes, Term C
January 13	First Day of Classes for Graduate Courses
February 13	Advising Appointment Day (No Undergraduate Classes)
February 28	Reserved for Weather-Cancellation Makeup
February 28-March 10	Spring Recess
March 11	First Day of Classes, Term D
April 15	Project Presentation Day (No Undergraduate Classes)
April 17-18	Project Registration for '03-'04
April 24	Deadline for Completion of Degree Requirement Forms for May 2003 Candidates
April 25	Last Day of Classes for Semester Courses
April 29	Last Day of Classes, Term D
May 1	12 noon - Residence Halls Close
May 16	Baccalaureate Ceremony
May 17	Spring Commencement
May 26	Memorial Day Holiday
May 29	First Day of Classes, Term E (Summer School)
June 6-8	Alumni Reunion
July 3-4	Independence Day Holiday (no classes)
July 18	Last Day of Classes, Term E (Summer School)
August 8	Last Day of Graduate Classes (Summer School)
August 20	Deadline for Completion of Degree Requirement Forms for Fall 2003 Candidates

2003-2004 Academic Year

August 14	Tuition for Terms A and B Due
August 23	Residence Halls Open for NEW Students; New Student Orientation (Freshmen/Transfer) Begins
August 24	Residence Halls and Apartments Open for Returning Students
August 25-29	Web Enrollment for Fall Semester
August 27	Deadline for Completion of Degree Requirement Forms for Fall 2003 Graduation
August 28	First Day of Classes, Term A
August 28	(Thurs.) Follow MONDAY Class Schedule
September 1	Labor Day Holiday (No Classes)
September 2	First Day of Classes for Graduate Courses
September 26	President's IQP Awards Entry Deadline
October 11	Homecoming
October 16	Last Day of Classes, Term A
October 17-27	Fall Recess

October 28	First Day of Classes, Term B
October 28	(Tues.) Follow FRIDAY Class Schedule
November 26-30	Thanksgiving Recess (Last Day of Class - Graduate Students - November 24) (Last Day of Class - Undergraduates - November 25)
December 3	President's IQP Award Competition
December 18	Last Day of B-term Classes
December 19	12 noon - Residence Halls Close For Term Break
December 19-January 14, 2004	Winter Recess
January 5	Tuition for Terms C and D Due
January 11	Residence Halls Open for Term C
January 12-16	Web Enrollment for Spring Semester
January 14	Deadline for Completion of Degree Requirement Forms for February 2004 Candidates
January 15	First Day of Classes, Term C
January 19	First Day of Classes for Graduate Courses
February 19	Advising Appointment Day (No Undergraduate Classes)
March 4	Last Day of Classes, Term C
March 5	Reserved for Weather-Cancellation Makeup
March 5-15	Spring Recess
March 16	First Day of Classes, Term D
April 20	Project Presentation Day (No Undergraduate Classes)
April 22-23	Project Registration for '04-'05
April 29	Deadline for Completion of Degree Requirement Forms for May 2004 Candidates
April 30	Last Day of Classes for Semester Courses
May 4	Last Day of Classes, Term D
May 6	12 noon - Residence Halls Close
May 21	Baccalaureate Ceremony
May 22	Spring Commencement
May 31	Memorial Day Holiday
June 3	First Day of Classes, Term E (Summer School)-tentative
June 10-12	Alumni Reunion
July 22	Last Day of Classes, Term E (Summer School)-tentative
July 5	Independence Day Holiday observed (no classes)
August 13	Last Day of Graduate Classes (Summer School)
August 25	Deadline for Completion of Degree Requirement Forms for Fall 2004 Candidates

UNDERGRADUATE CALENDAR 2003-2004

August 28 =
MONDAY
schedule

Oct. 28 =
FRIDAY
schedule

		S	M	T	W	R	F	S			S	M	T	W	R	F	S		
				27	28	29	30	31			1	2			8	9	10		11
A	AUG	3	4	5	6	7	8	9	FEB	15	16	17	18	19	20	21	MARCH 19 ACAD. ADVISING DAY (PROJ. OPPORTUNITIES)		
		10	11	12	13	14	15	16		22	23	24	25	26	27	28			
		17	18	19	20	21	22	23		29	1	2	3	4	5	6		MARCH 5 SNOW DAY (AS NEEDED)	
		24	25	26	27	28	29	30		7	8	9	10	11	12	13			
		31	1	2	3	4	5	6		14	15	16	17	18	19	20			
	SEPT	7	8	9	10	11	12	13	MAR	21	22	23	24	25	26	27	D		
		14	15	16	17	18	19	20		28	29	30	31	1	2	3			
		21	22	23	24	25	26	27		4	5	6	7	8	9	10			
		28	29	30	1	2	3	4		APR	11	12	13	14	15	16		17	
		5	6	7	8	9	10	11			18	19	20	21	22	23		24	APRIL 20 PROJECT PRES. DAY
OCT	12	13	14	15	16	17	18	MAY	25	26	27	28	29	30	1	E			
	19	20	21	22	23	24	25		2	3	4	5	6	7	8				
	26	27	28	29	30	31	1		9	10	11	12	13	14	15				
	2	3	4	5	6	7	8		16	17	18	19	20	21	22		Graduation		
	9	10	11	12	13	14	15		23	24	25	26	27	28	29				
NOV	16	17	18	19	20	21	22	JUNE	30	31	1	2	3	4	5	MAY 31 MEMORIAL DAY			
	23	24	25	26	27	28	29		6	7	8	9	10	11	12				
	30	1	2	3	4	5	6		13	14	15	16	17	18	19				
	7	8	9	10	11	12	13		20	21	22	23	24	25	26				
	14	15	16	17	18	19	20		27	28	29	30	1	2	3				
DEC	21	22	23	24	25	26	27	JULY	4	5	6	7	8	9	10	JULY 5 INDEPEND. DAY (OBSERVED)			
	28	29	30	31	1	2	3		11	12	13	14	15	16	17				
	4	5	6	7	8	9	10		18	19	20	21	22	23	24				
	11	12	13	14	15	16	17		25	26	27	28	29	30	31				
	18	19	20	21	22	23	24		1	2	3	4	5	6	7				
JAN	25	26	27	28	29	30	31	8	9	10	11	12	13	14	AUG				
	1	2	3	4	5	6	7	15	16	17	18	19	20	21					

GRADUATE CALENDAR 2003-2004

		S	M	T	W	R	F	S			S	M	T	W	R	F	S		
FALL	AUG	27	28	29	30	31	1	2	FEB	8	9	10	11	12	13	14	SPRING		
		3	4	5	6	7	8	9		15	16	17	18	19	20	21			
		10	11	12	13	14	15	16		22	23	24	25	26	27	28			
		17	18	19	20	21	22	23		29	1	2	3	4	5	6			
	24	25	26	27	28	29	30	7	8	9	10	11	12	13					
	SEPTEMBER 1 LABOR DAY	31	1	2	3	4	5	6	MAR	14	15	16	17	18	19	20			
	SEPT	7	8	9	10	11	12	13	21	22	23	24	25	26	27				
		14	15	16	17	18	19	20	APR	28	29	30	31	1	2	3			
		21	22	23	24	25	26	27	4	5	6	7	8	9	10				
		28	29	30	1	2	3	4	11	12	13	14	15	16	17				
	OCT	5	6	7	8	9	10	11	18	19	20	21	22	23	24				
		12	13	14	15	16	17	18	MAY	25	26	27	28	29	30	1			
19		20	21	22	23	24	25	2	3	4	5	6	7	8					
26		27	28	29	30	31	1	9	10	11	12	13	14	15					
NOV	2	3	4	5	6	7	8	16	17	18	19	20	21	22					
	9	10	11	12	13	14	15	JUNE	23	24	25	26	27	28	29				
	16	17	18	19	20	21	22	30	31	1	2	3	4	5					
	23	24	25	26	27	28	29	6	7	8	9	10	11	12					
DEC	30	1	2	3	4	5	6	13	14	15	16	17	18	19					
	7	8	9	10	11	12	13	JULY	20	21	22	23	24	25	26				
	14	15	16	17	18	19	20	27	28	29	30	1	2	3					
	21	22	23	24	25	26	27	4	5	6	7	8	9	10					
JAN	28	29	30	31	1	2	3	11	12	13	14	15	16	17					
	4	5	6	7	8	9	10	18	19	20	21	22	23	24					
	11	12	13	14	15	16	17	AUG	25	26	27	28	29	30	31				
	18	19	20	21	22	23	24	1	2	3	4	5	6	7					
FEB	25	26	27	28	29	30	31	8	9	10	11	12	13	14					
	1	2	3	4	5	6	7	15	16	17	18	19	20	21					

Graduation

MAY 31
MEMORIAL DAY

SUMMER

JULY 5
INDEP. DAY
(OBSERVED)

Chronology of Academic Schedule and Events	IFC
Undergraduate Calendar 2003-2004	i
Graduate Calendar 2003-2004	ii
The Mission of WPI	3
WPI's Commitment to Pluralism	3
The Goal of WPI	4
The Two Towers Tradition: The Second Century	5
The WPI Plan	5
WPI: A Global Technological University	6
Resources Available to Undergraduates	8

**SECTION 1:
THE WPI PLAN 21**

WPI Degree Requirements	22
The Planning Process	23
Academic Advising	24
Major Areas of Study	24
Concentrations	26
Minors	26
Double Majors	27
Minimum Distribution Requirements for Students	28
Courses Qualifying for Engineering	
Distribution Areas	35
Projects	35
Projects Program	37
The Interactive Qualifying Project	39
The Major Qualifying Project	39
Residential Project Programs	47
On-Campus IQP Programs	53
The Sufficiency	54
The Social Science Requirement	61
Awards And Prizes	61

**SECTION 2:
DEPARTMENT AND
PROGRAM DESCRIPTIONS 65**

Air Force Aerospace Studies	66
Biology and Biotechnology	67
Biomedical Engineering	72
Chemical Engineering	79
Chemistry and Biochemistry	83
Civil and Environmental Engineering	88
Computer Science	94
Computer Science Minor	100
Electrical and Computer Engineering	100
Minor in Computer Engineering	110
Engineering Science Courses	111
Engineering Physics	111
Environmental Programs	111
Fire Protection Engineering	113
Humanities and Arts	114
Minor in Foreign Language (German or Spanish)	117
Music Minor	117
Minor In Writing and Rhetoric	118
Industrial Engineering	118
Interdisciplinary Programs	118
Teacher Licensing	119
International Studies	119
Law and Technology Minor	121
Management	122
Entrepreneurship Minor	130
Management Minor	131
Management Information Systems Minor	131
Organizational Leadership Minor	131
Manufacturing Engineering	132
Minor in Manufacturing Engineering	134
Materials Engineering	135
Minor in Materials	135
Mathematical Sciences	136
Statistics Minor	143
Mathematics Minor	143
Mechanical Engineering	144
Military Science	150
Physical Education	152
Physics	153
Physics Minor	157
Pre-Law Programs	158
Pre-MBA Program (Dual Degree)	158
Pre-Medical, Pre-Dental and Pre-Veterinary Programs	158
Social Science and Policy Studies	159

2 CONTENTS

SECTION 3: COURSE DESCRIPTIONS 169

Aerospace Studies	170
Biology and Biotechnology	171
Biomedical Engineering	175
Chemical Engineering	177
Chemistry and Biochemistry	179
Civil and Environmental Engineering	182
Computer Science	184
Electrical and Computer Engineering	187
Engineering Science Interdisciplinary	189
Fire Protection Engineering	190
Geosciences	192
Humanities and Arts	192
Interdisciplinary	201
Management	202
Mathematical Sciences	205
Mechanical Engineering	208
Military Science	212
Physical Education	213
Physics	214
Social Science and Policy Studies	216

SECTION 4: ACADEMIC POLICIES AND PROCEDURES . . 221

Grades	222
Grade Appeal And Grade Change Policy	223
Transfer Students	225
Transcript Fees	225
Degree Audits	225
Designation of Major Area of Study	225
Double Major	225
Designation of Class Year	225
Guidelines for the Determination of Satisfactory Academic Progress, Academic Warning, Academic Probation and Academic Suspension	226
Administrative Obligations	227
Directory Information and Release of Information	227
Registration	227
Project and Independent Study Registration	228
Registration Policy for Degree Requirements	229
Special Students	229
Project Registration Topic Codes	229
Coding of Project Advisors	230

SECTION 5: UNIQUE OPPORTUNITIES AT WPI 233

The Collaborative for Entrepreneurship & Innovation	234
Student Exchanges	234
3-2 Programs	236
Worcester Consortium Course Cross-Registration	236
Cooperative Education Program	236
Summer Study (Term E)	237
Societies, Registration and Licensing	238
Engineering Societies	238

SECTION 6: CAREER DEVELOPMENT AND GRADUATE SCHOOL 239

Career Development	240
Graduate Studies	240
WPI Graduate Program	241

SECTION 7: ADMISSION, EXPENSES, FINANCIAL AID AND HOUSING 244

Admission to WPI	245
Expenses	248
Financial Aid	249
Housing	254

SECTION 8: ADMINISTRATION AND FACULTY 256

Trustees	257
Administration	259
Faculty	269
Faculty Emeriti	279
Index	282
Policies & Practices	285
Accreditation	285
Currency of Information	286
Directions	286
Campus Map	IBC

WPI educates talented men and women in engineering, science, management, and humanities in preparation for careers of professional practice, civic contribution, and leadership, facilitated by active lifelong learning. This educational process is true to the founders' directive to create, to discover, and to convey knowledge at the frontiers of

academic inquiry for the betterment of society. Knowledge is created and discovered in the scholarly activities of faculty and students ranging across educational methodology, professional practice, and basic research. Knowledge is conveyed through scholarly publication and instruction.

Adopted by the Board of Trustees, May 22, 1987

WPI'S COMMITMENT TO PLURALISM

Pluralism, as a social condition, means that several distinct ethnic, religious, and racial communities live side by side, have equitable access to resources, are willing to affirm each other's dignity, are ready to benefit from each other's experiences, and are quick to acknowledge each other's contributions to the common welfare. Recognizing the importance of pluralism to creativity, innovation, and excellence, WPI is dedicated to creating an atmosphere that encourages diversity in all aspects of campus life—from academics, to residence hall living, to social interactions among students, faculty, and staff. The Institute recognizes the special obligation of promoting a multicultural community based on mutual respect and tolerance. This commitment is part of WPI's institutional plan for encouraging pluralism and increasing diversity, a plan that proclaims the importance of having students understand and appreciate other cultures, and prepares them fully to pursue rewarding careers in an increasingly global economy.

Concepts endorsed by the WPI Faculty on April 21, 1994.

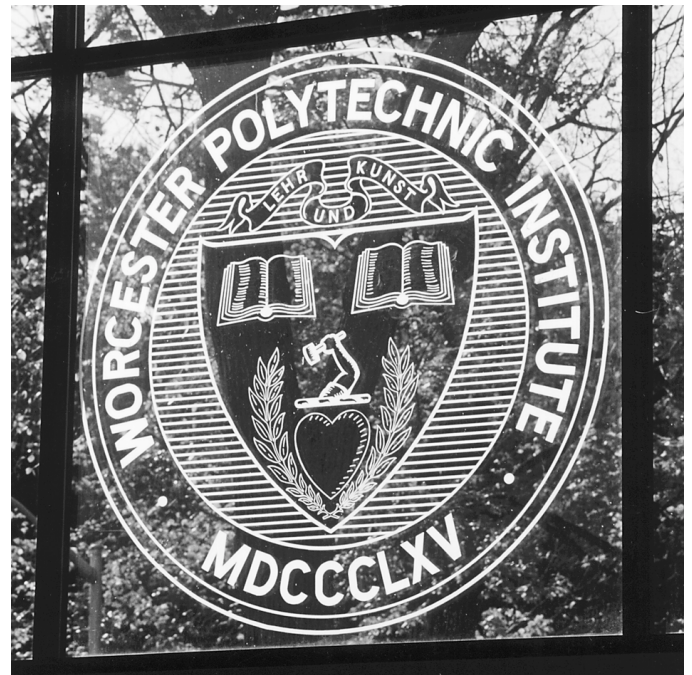

WPI was founded in 1865 to create and convey the latest science and engineering knowledge in ways that would be most useful to the society from which its students came. Since that time, the disciplines of human inquiry have expanded extraordinarily, as have WPI's constituencies. The WPI curriculum, accordingly, has been reshaped numerous times, but it has remained true to its original mission of fusing academic inquiry with social needs, of blending abstraction with immediacy, of linking new knowledge to applications.

The goals of the undergraduate program are to lead students to develop an excellent grasp of fundamental concepts in their principal areas of study; to lay a foundation for life-long renewal of knowledge; to gain a mature understanding of themselves; and, most importantly, to form a deep appreciation of the interrelationships among basic knowledge, technological advance, and human need. These principles are today manifest in the *WPI Plan*, a unique, project-oriented program which emphasizes intensive learning experiences and direct application of knowledge. WPI remains committed to continued educational improvement and innovation.

The goals of WPI's programs of graduate instruction and research are to create and convey knowledge at the frontiers of academic inquiry. These endeavors are founded on the principle that vigorously pursued and rigorously assessed scholarship is the lifeblood of the institution. High quality graduate instruction conveys the arts of scholarship to new generations, and it assists working professionals in maintaining currency in a world where knowledge becomes obsolete with ever-increasing rapidity.

A WPI education encompasses continuous striving for excellence coupled with an examination of the contexts of learning so that knowledge is won not only for its own sake but also for the sake of the human community of which the people of WPI are part.

Endorsed by the WPI Faculty on March 5, 1987, and by the Board of Trustees on October 16, 1987.



WPI, the nation's third oldest private technological university, was established in 1865 by the New England industrialists John Boynton, Ichabod Washburn, and their associates. Boynton and Washburn endowed the first two buildings on campus, as academic classrooms and practical shops. Boynton Hall and the Washburn Shops — renovated today into state-of-the-art facilities — still preserve their distinctive original towers. These “Two Towers” represent WPI's continued commitment to academic excellence through real-life project experience that synthesizes classroom learning.

The “Two Towers” tradition of academic achievement and practical application is reflected in WPI's motto, “Lehr und Kunst” or “Theory and Practice.”

WPI has awarded graduate degrees since 1898, adding new programs regularly in response to the developing needs of the professional world. WPI is among the top 50 science colleges in the nation in terms of the percentage of undergraduates who receive doctorates. Presently, WPI offers the master's degree in 25 disciplines and the doctorate in 14.

The current student body of over 3,600 men and women includes about 1,000 full- and part-time graduate students. Currently, students attend WPI from almost every state and over 60 foreign nations.



THE WPI PLAN

In 1970 WPI adopted a revolutionary new undergraduate program known as the *WPI Plan*. The Plan replaced the traditional rigidly-prescribed curriculum — typical of conventional engineering education — with a flexible, exciting, and academically challenging program aimed at helping students to learn *how to learn*.

The Plan continues the “Two Tower” tradition by synthesizing classroom experience in projects that solve real-world problems. The WPI project program prepares graduates for their future professional lives by helping them learn how to identify, investigate and report on open-ended problems. Alumni indicate that project experiences also prepare them uniquely well for managing team efforts, and for communicating both in oral and written forms according to professional standards.

All WPI students complete three projects. The Major Qualifying Project (or MQP) challenges students to solve problems typical of those to be encountered in their professional discipline. The Interactive Qualifying Project (or IQP) presents an issue at the intersection of science, technology, and culture, and emphasizes the need to learn about how technology affects societal values and structures. Also, students complete a Sufficiency project on a theme emerging from a five-course, self-selected series of courses in Humanities and Arts, thus insuring that WPI students develop an understanding of the humanities as well as of technology. Taken together, the three projects emphasize that technological professionals must learn not only to create technology, but also to assess and manage the social and human consequences of that technology.

Global Program Sites



WPI students must prepare to live and work in the interdependent world of the next century. Professionals no longer can study, and live in ignorance of other countries and cultures, as professional practice and commerce increasingly cross over national boundaries.

WPI thus emphasizes real-world project experience, and provides extensive opportunities for studying the kinds of global issues that will dominate professional and political life in the 2000's.



To support classroom and project work, WPI makes every effort to provide students with hands-on experience with state-of-the-art research and support facilities. Below are a few of the facilities available to WPI undergraduates:

COMPUTER RESOURCES

RESOURCES IN FULLER LABORATORIES

WPI's newest academic building, Fuller Laboratories, is designed to provide dedicated space for faculty, staff and students working in the information sciences. The Computing and Communications Center (CCC) is located in this building, along with the Computer Science Department and the Academic Technology Center.

CCC provides a wide range of services and access to computer resources for the WPI community and manages an array of powerful UNIX workstations. All WPI students, faculty and staff may obtain a login ID from the CCC for academic course works, research and self-education. The ID will remain in force as long as the person continues to be registered as a student or to be employed by WPI. The systems have been configured so that the user will see the same familiar environment no matter which CCC workstation is used.

CCC facilities are accessible from a wide variety of locations on campus or from around the world via the campus connection to the Internet. CCC operates the campus data network and Internet connectivity, including a VPN (Virtual Private Network) to access internal resources remotely. Computer systems operated by academic departments are also on the same CCC communications infrastructure, so they are accessible just as easily. The CCC facilities offer x-terminals with Linux servers, as well as high-end PCs and several Macs. In addition to several computer classrooms and specialized labs, the CCC supports open access labs in every academic building totaling hundreds of stations across the campus. Each of these labs offers the same user interface, software profile, and network access to personal files as does the CCC lab.

PC files servers drive laser printers in the CCC facilities and other locations across campus. Also accessible in the CCC are a color postscript laser printer and scanning devices. Since the campus network distributes computing services across the campus, network-attached PCs in other buildings can use the CCC print service to generate high-quality output for reports and resumes. The servers also provide file service for many software packages including PC-based desktop publishing, spread sheets, databases, programming languages, and department courseware.

CCC supports the residence and fraternity network services. Using their personal PCs, students in residence halls can access the same software and interface available in CCC PC labs across campus. A wireless network,

which has been installed in the Library, Campus Center and academic buildings, has been expanded to Morgan, Daniels, Riley and Founders residence halls. Wireless laptops are available on loan for use in the library and campus center.

In addition to supporting the academic computing system on campus, CCC operates the administrative system that provides data processing services to WPI administrative offices. The WPI information system provides ready access to important registration information. Students update their biographical information, check grades and drop/add courses over the network via the web interface to the administrative system.

CCC manages a computer help desk to answer users' questions on any of the computer platforms and to provide technical support for endorsed software packages. CCC also provides instruction sessions on supported software in the state-of-the-art computer-training classroom that the CCC maintains in the Gordon Library.

GENERAL COMPUTER SCIENCE DEPARTMENT FACILITIES

Fuller 2nd Floor

The department is housed in the new specially designed Fuller Laboratories building, providing substantial office and laboratory space. A wide variety of computing equipment is available for course work, project work, and research in computer science.

The department has multiple Sun UltraSPARC, SGI, and Intel machines running Solaris, IRIX, Linux, and other operating systems, for interactive use. These may be accessed via roughly 70 PC's located in department offices, as well as from any of CCC's publicly available computers.

Every classroom, laboratory and office in Fuller Labs is connected to the campus-wide high speed communications network. The network provides access to other computing resources, including the Computing and Communications Center, and the Internet.

RESOURCES IN HIGGINS LABORATORIES

KECK DESIGN CENTER

[Mechanical Engineering]

The Computer Classroom

2nd Floor

The Keck Design Center contains computer workstations with state-of-the-art computer-aided design software for mechanical devices and is primarily used to support entry-level CAD courses. The software also allows the modeled geometry to be transported to other analysis packages available in the Center.

Laboratory lectures are held in this room which allows the instructor to lecture and the students have hands-on availability of the material being presented.

The Design Studio*2nd Floor*

The Design Studio provides an environment linked by computational equipment and networks to outside manufacturing facilities. High-end Sun Workstations, with software support for video-picture-within-the-monitor teleconferencing, provide two-way communication of audio, video, and data between the Design Studio and to off-campus sites.

In the computationally equipped studio, students have clustered seating around multiple workstations. Design work can be done on the workstations and discussed or analyzed with off-campus sponsors or collaborators in real time as changes are made. Part files can be ported to rapid prototyping machines or lithography units within the Design Studio and beyond. Video cameras at the prototyping stations show the real-time fabrication within a window on the workstations.

RESOURCES IN THE WASHBURN LABORATORIES**HAAS TECHNICAL CENTER FOR COMPUTER-CONTROLLED MACHINING***[Mechanical Engineering] First Floor*

The center is primarily for undergraduate teaching and projects. The eight new CNC machine tools include a lathe with live tooling and a barfeeder, as well as two vertical machining centers with four, and more, axes. They are used in ME 1800, ME 3820, and ES 3323. The machine tools provide for the fabrication, i.e., realization, of parts, especially those designed on computers. The machine tools are important for supporting WPI's project based-education. The machine tools are also used in graduate education and manufacturing engineering research, as well as to produce apparatus to support research efforts in other fields. The center is part of a network of over 30 other colleges and universities in North America which also have Haas Technical Centers designed by Haas Automation, Oxnard, CA.

MANAGEMENT MICROCOMPUTER LABORATORY*[Management] Second Floor*

The Management Microcomputer Lab contains fifteen personal computers that are networked to the University backbone. Spreadsheet, word processing, and database management packages are accessible from the lab, as well as software for simulation, quality control, and management science analyses. Students use the lab for course work and projects. The lab is open during normal business hours for the Department of Management and until 10 pm weekdays only.

THE MANUFACTURING DESIGN STUDIO*[Mechanical Engineering] First Floor*

The eight (8) Sun workstations and 10 PCs, with CAD and CAM software, in the Manufacturing Design Studio are linked through WPI's computer network to the CNC

machine tools in the Haas Technical Center. This provides a modern multi-user design and prototype production facility for student use for projects, research and class/lab work.

MANUFACTURING ENGINEERING RESEARCH CENTER*[Mechanical Engineering] First Floor*

This consists of six laboratories: Haas Technical Center, Manufacturing Laboratory, Computer-aided Manufacturing Lab, Machining Dynamics Lab, Surface Metrology Lab, and the Robotics Lab. These include a wide variety of instrumentation, measurement and computational and facilities for the control and monitoring, modeling and design of manufacturing tools, products and processes. The center also has access to external machine shop facilities.

These labs combine a large machinery bay area with an attached air-conditioned computer laboratory. Equipment in the Robotics Lab includes a number of industrial robots, a Coordinate Measurement Machine (CMM), a machining area with CNC machine tools, and specialized automation equipment interfaced to PLC's. The Surface Metrology Laboratory has scanning laser microscopes, conventional profilers, specialized software for analyzing measured surface fixtures, including fractal analysis. The CAM Lab includes several Unix-based engineering graphics workstations used for CAD, solid modeling, kinematics analysis, FEA, CIM and expert system development, and a number of computers set up for data acquisition and real-time control. Cooperative research is frequently done with faculty in many areas.

MIS/OIE ORACLE/LEAN LAB*[Management] Second Floor*

The Department of Management is a participating member in Oracle Corporation's Oracle Academic Initiative. OAI participants integrate Oracle products in a number of their courses to provide students with real-world experience working with enterprise systems. The MIS/OIE Oracle/Lean Lab is located in WB228. In addition to 24 high-end desktop computers with flat panel screens, the lab houses numerous servers as well as older computers and servers used for test purposes. Each computer is wired to the university backbone through a 100 megabit connection. Additionally, there is an internal network that is used with the Department's servers. In the future, the internal network will also connect to an adjacent classroom, WB229, which will have connections at each seat for that and the university network.

In addition to the computing resources available in the MIS/OIE Oracle/Lean Lab, moveable tables support process-oriented laboratories associated with lean design and the OIE program.

PROJECT AND EDUCATIONAL FACILITIES

ADVANCED CASTING RESEARCH CENTER
(See full description under Research Centers and Institutes on page 11.)

CENTER FOR HEAT TREATING EXCELLENCE (CHTE)
(See full description under Research Centers and Institutes on page 11.)

POWDER METALLURGY RESEARCH CENTER (PMRC)
(See full description under Research Centers and Institutes on page 11.)

COMPUTER SCIENCE PROJECT LABORATORIES
Fuller

Because project work is a significant part of a WPI education, the Computer Science Department has several laboratories devoted to undergraduate and graduate project work. These laboratories have a wide variety of computer equipment available for student use.

DISCOVERY CLASSROOM

[Mechanical Engineering] Higgins: Second Floor

This state-of-the-art classroom provides a non-traditional, discovery-based learning environment that supports learning modules which unify the analytical, computational, and experimental engineering approaches. The room seats 90 and features experimental facilities that allow students to examine the details of physical phenomena during interactive class exercises. A multi-purpose laboratory adjacent to the classroom permits small-group exercises and design work.

ENGINEERING EXPERIMENTATION LABORATORY

[Mechanical Engineering] Higgins: Basement

The Experimental Laboratory provides the support for undergraduate courses designed to develop analytical and experimental skills in modern engineering methods based on current electronic instrumentation and computer-based data acquisition systems. Engineering analysis and design, and the principles of instrumentation are emphasized. The laboratory affords the student an opportunity to use modern devices in actual experiments in areas such as heat transfer, flow measurement and visualization, force/torque/strain measurements, motion and vibration measurements, and laser applications.

HAAS TECHNICAL CENTER FOR COMPUTER-CONTROLLED MACHINING

(See full description under Resources in Washburn Laboratories on page 9.)

MECHANICAL ENGINEERING PROJECT LABORATORY

[Mechanical Engineering] Higgins: Basement

The Project Lab is a dedicated multipurpose laboratory for Major Qualifying Projects, which need construction and storage space. This lab includes a fully staffed machine shop to assist the students in the design, layout and fabrication of components needed for students' experiments.

RESEARCH CENTERS AND INSTITUTES

A number of faculty members have formed multi-disciplinary research centers and institutes at WPI. These active research centers and programs provide excellent and unique interdisciplinary research opportunities. All of these centers and groups conduct outstanding state-of-the-art research sponsored by governmental and industrial agencies.

The centers listed and described below offer opportunities to undergraduates to work with ongoing research activities through MQPs, industrial internships, coop opportunities, summer employment and international project activities.

CENTER FOR HOLOGRAPHIC STUDIES AND LASER TECHNOLOGY (CHSLT)

[Mechanical Engineering] Higgins: First Floor

The CHSLT was founded in 1978 and is furnished with state-of-the-art facilities which are used for research and educational activities. These activities range from fundamental studies of laser light interaction with materials to sophisticated applications in metrology.

The CHSLT research is in areas relating to microelectronics, radar technology, microtechnology, micromechanics, submarine technology, jet engine technology, avionics, biomedicine, modern powder materials, ceramics, composites, energy systems, micro-scale material science and engineering, interconnection technology, and computational modeling. The strength of the CHSLT lies in a comprehensive utilization of laser technology, optics, computational methods, mechanical engineering, materials science and engineering, and computer data acquisition and processing. Building on these strengths, greatly diversified projects in a number of areas of current interest are being conducted using the Center's own technique and innovative methods.

The CHSLT develops and maintains cooperative and exchange programs with leading teaching and research institutions in the United States and abroad.

METAL PROCESSING INSTITUTE (MPI)

[Mechanical Engineering] Washburn: Third Floor

The Metal Processing Institute (MPI) is an industry-university alliance. Its mission is to design and carry out research projects identified in collaboration with MPI's industrial partners in the field of near and net shape manufacturing. MPI creates knowledge that will help enhance the productivity and competitiveness of the metal processing industry, and develops the industry's human resource base through the education of WPI students and the dissemination of new knowledge. More than 130 private manufacturers participate in the institute and their support helps fund fundamental and applied research that addresses technological barriers facing the industry. The MPI researchers also develop and demonstrate best practices and state-of-the-art processing techniques.

MPI offers educational opportunities and corporate resources to both undergraduate and graduate students. Specifically,

- International exchanges and internships with several leading universities around the globe—Europe and Asia.
- MQP opportunities with the industrial sector wherein the students spend the summer months prior to their senior year in industry.
- Graduate internship programs leading to a Masters or Doctoral degree where the research work is carried out at the industrial site.

For further details visit the MPI office on the third floor of Washburn, Room 326, or the MPI website: www.wpi.edu/+mpi.

MPI's research programs are carried out by three distinct research consortia. These are described below:

- Advanced Casting Research Center (ACRC)
- Center for Heat Treating Excellence (CHTE)
- Powder Metallurgy Research Center (PMRC)

ADVANCED CASTING RESEARCH CENTER (ACRC)

[Mechanical Engineering] Washburn: Basement

The laboratory provides experimental facilities for course laboratories and for undergraduate and graduate projects. The laboratory is equipped with extensive melting and casting facilities, computerized data acquisition systems for solidification studies, thermal analysis units, liquid metal filtration apparatus, rheocasting machines and a variety of heat treating furnaces. The laboratory has strong collaborations with industry and students work directly with professional engineers from sponsoring companies. Fifty-five corporate members participate in and support the casting research programs. Student scholarships offered by the Foundry Education Foundation (FEF) are available through the laboratory. The ACRC conducts workshops, seminars, and technical symposiums for national and local industries. The laboratory is available throughout the year for project activity and thesis work as well as summer employment. Project opportunities at international sites are also available through ACRC/MPI.

CENTER FOR HEAT TREATING EXCELLENCE (CHTE)

[Mechanical Engineering] Washburn: Third Floor

The center is an alliance between the industrial sector and researchers to collaboratively address short-term and long-term needs of the heat treating industry. It is the center's intent to enhance the position of the heat treating industry by applying research to solve industrial problems and to advance heat treatment technology. The center's objective is to advance the frontiers of thermal processing through fundamental research and development.

Specifically, the center will pursue research to develop innovative processes to:

- Control microstructure and properties of metallic components
- Reduce energy consumption
- Reduce process time
- Reduce production costs
- Achieve zero distortion
- Increase furnace efficiency
- Achieve zero emissions

Over fifty corporate members participate and support the CHTE research programs. MPI project opportunities, industrial internship, and summer employment are available through CHTE/MPI.

POWDER METALLURGY RESEARCH CENTER (PMRC)

[Mechanical Engineering] Washburn: First Floor

The center addresses the scientific, engineering, and managerial problems of the powder metallurgy industry.

By integrating facilities from different disciplines, the center has developed research programs in engineering and management, addressing new technologies as well as methodologies for their implementation, i.e., valve creation and management issues in a small fragmented industry. The objectives of the PMRC are as follows:

- Establish an educational and research center for the powder metallurgy industry, and to provide a vehicle for manufacturing excellence and competitiveness of the industry.
- Establish long-term relationships between the academic community and members of management, manufacturing, and research in the industry.
- Develop course and project experiences for graduate and undergraduate students that will foster an understanding of the industry.

Twenty-one corporate members participate and support the PMRC research programs. MQP project opportunities, industrial internships, and summer employment are available through PMRC/MPI.

RESEARCH LABORATORIES AND FACILITIES

These labs are MQP and research activity opportunities.

AEROSPACE LABORATORY

[Mechanical Engineering] Higgins: Basement

These experimental facilities provide support for courses, major qualifying projects, faculty and graduate student research. The facilities and instrumentation include a closed-return, high quality 2'x2' wind tunnel, a subsonic open-return wind tunnel with a 18"x24" test section, a supersonic flow facility, laser Doppler velocimeter, hot-wire anemometry system, laser diagnostics, an intensified camera system, and computer data acquisition systems, and an ultrasonic measurement system.

ANALOG/MIXED SIGNAL MICROELECTRONICS LABORATORY

[Electrical and Computer Engineering Department]

Atwater Kent

The Analog/Mixed Signal Microelectronics Research Laboratory comprises instrumentation, workstations, and software for the complete integrated circuit design process. Full CAD software tools are available for schematic capture, simulation, layout, parasitic extraction, and layout-vs.-schematic verification. Fabrication facilities are available through MOSIS and the industry partners. The equipment required to test the fabricated circuits (thereby verifying the design principles and completing the design process) has been purchased with a grant awarded by the National Science Foundation under the CISE Research Instrumentation Grant program. The lab is a tremendous enabling resource for test and evaluation to "complete the loop" for the design process. Since the instrumentation capability extends to 2.5GHz speeds, this lab will be a valuable resource for many years to come.

BIOMECHANICAL ENGINEERING LABORATORIES

[Mechanical Engineering] Higgins: First Floor

This complex provides experimental and computational facilities for the laboratory component of courses, major qualifying projects, and graduate research. The Biomechanical Engineering Laboratory complex includes the following:

The Biomechanics/Biofluids Laboratory: provides experimental facilities in the areas of biomechanics and biofluids. The laboratory has equipment for measuring force, deformation and kinematic variables as well as fluid flow, pressure and velocity. The laboratory contains PC-based computational and data acquisition facilities.

The Biomaterials Laboratory: is equipped for the evaluation of biological tissues, biomedical materials and surgical constructs with a focus on orthopedic and dental applications. The laboratory contains a computer controlled biaxial testing machine for use in these studies.

The Rehabilitation Engineering Laboratory: provides experimental facilities for the design, development and testing of electro-mechanical assistive devices. The Assistive Technology Resource Center is a part of the laboratory.

BIOPROCESS LABORATORY

[Biology and Biotechnology] Salisbury

The Department of Biology and Biotechnology has a 1600 square foot laboratory for courses, projects and research in bioprocess, which is the application of biotechnology and engineering principles to produce valuable products. This lab houses state-of-the-art equipment for fermentation, centrifugation, tangential flow filtration, rheometry, spectrophotometry, and high performance liquid chromatography. The lab is used for courses in Fermentation, Separation of Biological Molecules, Downstream Processing, and a course in Scale-Up that enables students to gain experience in bioprocessing at the 50 liter scale. This combination of facilities and courses gives WPI students experience unmatched by any other university in the country.

CENTER FOR SENSORY AND PHYSIOLOGIC SIGNAL PROCESSING - C(SP)2

[Electrical and Computer Engineering Department]

Atwater Kent

Researchers within the C(SP)2 apply signal processing, mathematical modeling and other electrical and computer engineering skills to study issues related to human sensation and physiology. Currently, our major focus areas are vision, hearing, tactile reception and electromyography (EMG). In our vision research, we have digitally produced pulse code modulated patterns that evoke multi-color sensations from black and white and monochromatic flicker patterns. Hearing research is concentrating on improved signal processing in hearing aid devices to improve speech perception by the hearing impaired. The purpose of the tactile receptor studies is to develop an understanding of the stimulus encoder characteristics of tactile mechanoreceptors. In the area of EMG (the electrical activity of skeletal muscle), we are improving the detection and interpretation of EMG for such uses as the control of powered prosthetic limbs and musculoskeletal modeling.

CENTER FOR WIRELESS INFORMATION NETWORKING STUDIES (CWINS)

[Electrical and Computer Engineering Department]

Atwater Kent

The Center for Wireless Information Network Studies is a renowned compact wireless research laboratory with a successful history of research alliances with other industrial and academic groups. The center has performed research for government agencies and has close ties with the world-leading organizations in the wireless industry.

The core competence of the center is in indoor radio channel propagation measurement modeling and in the development of testbeds and tools for design and performance monitoring of wireless indoor networks.

CERAMIC PROCESSING LABORATORY

[Mechanical Engineering] Washburn: Third Floor

This facility serves the Materials Science and Engineering Program, the Manufacturing Engineering Program, and other departments. The laboratory contains a variety of powder processing and characterization equipment, as well as equipment for green body consolidation and sintering. A specially equipped room houses the electric discharge-machining laboratory.

COMPUTATIONAL GAS AND PLASMA DYNAMICS LABORATORY (CGPL)

[Mechanical Engineering] Higgins: Second Floor

The mission of CGPL is to develop and apply advanced computational methodologies in the modeling of complex gas and plasma flows. Research studies in CGPL are focused on aerospace systems and technologies that include: electric propulsion, spacecraft-induced environment interactions, small thruster internal and plume flows, rarefied gas dynamics, magnetogasdynamics, and crystal growth in microgravity. Strong emphasis is placed in CGPL's participation in space programs and missions. CGPL is equipped with several UNIX and NT workstations, data storage devices and printers.

COMPUTATIONAL FIELDS LABORATORY

[Electrical and Computer Engineering Department]

Atwater Kent

Our laboratory focuses on the fundamental research aspects and practical realizations of electromagnetic and nondestructive testing (NDT) problems of industrial interest. The investigations range from low (static and diffusion) to high-frequency (wave propagation) phenomena and include topics such as:

- NDT and Process Control
 - Electric Resistivity Testing of Powder Metallurgy Compacts
 - Eddy Current Testing of Steel Products
 - Clean Molten Metal Sensing Modeling
- Electromagnetics
 - Radio frequency signal propagation through multi-layer circuit boards
 - Temperature effects in power transistors
 - Pulsed hysteresis graph magnetization of permanent magnetic materials

CONVERGENT TECHNOLOGIES CENTER (CTC)

[Electrical and Computer Engineering Department]

Atwater Kent

The laboratories in this center combine diverse expertise for the exploration of the emerging and converging technologies of computing, communications and cognition. The Polaroid Machine Vision Laboratory (PMVL) and the Network Computing Applications and Multimedia (NETCAM) laboratory focus on the development of new algorithms and moving emergent technologies into commercial, medical and defense related applications for its sponsors.

Research in the NETCAM lab derives from the technologies generated by the success of the Internet, digital multimedia and distributed objects and middleware. Current projects explore the optimization of network protocols for multimedia, distributed object services (CORBA), and virtual reality based user interfaces.

Research in the PMVL lab has resulted in the development of highly efficient algorithms and new theoretical performance bounds for machine vision, automatic target recognition and image fusion for optical, IR, SAR, and SONAR data.

CRYPTOGRAPHY AND INFORMATION SECURITY (CRIS) LABORATORY

[Electrical and Computer Engineering Department]

Atwater Kent

The CRIS Laboratory conducts research and development in cryptography and its applications. One research focus are fast implementations of the next generation of public-key algorithms such as elliptic and hyperelliptic curve schemes. We work on fast software algorithms and efficient hardware architectures. The lab is equipped with industry-standard development tools for ASIC and FPGA target hardware. We also apply Xilinx FPGAs and Altera EPLDs to a new type of crypto systems which allow for a fast switch of private-key encryption algorithms ("algorithm agility").

Another research focus is the integration of cryptography and data security into new communication networks. We work on the design and implementation of security protocols for wireless networks, with an emphasis on wireless LANs. Another network type of interest are high-speed Asynchronous Transfer Mode (ATM) networks. We investigate system design and algorithmic issues.

DATA/KNOWLEDGE BASE RESEARCH LABORATORY

[Computer Science] Fuller

The Data/Knowledge Base Research Laboratory supports research in very large data and knowledge base systems. Current research covers three topics; 1) distributed warehousing; 2) XML data management; and 3) continuous query processing systems. The laboratory is equipped with a number of Intel-based PCs.

DISTRIBUTED PROCESSING LABORATORY

[Computer Science] Fuller

The Distributed Systems Laboratory supports research and project work in distributed processing and distributed systems. The laboratory is equipped with a number of Intel-based PCs.

FIRE SCIENCE LABORATORY

[Fire Protection Engineering] Higgins: Basement

The Fire Science Laboratory supports small-scale and medium-scale experimentation in fire dynamics, combustion/explosion phenomena, detection, and fire and explosion suppression.

Serving as both a teaching and research facility, the lab accommodates undergraduate projects as well as graduate students in fire protection engineering, mechanical engineering, and related disciplines.

FLUID DYNAMICS LABORATORY

[Mechanical Engineering] Higgins: Third Floor

This laboratory provides experimental facilities and instrumentation for experimental activities in the area of fluid dynamics. A small, open-return subsonic wind tunnel is available for use, and small experiments may be set up as required. Separate areas are provided for model preparation and small-scale experiments on space experiment packages.

HEAT TRANSFER LABORATORY*[Mechanical Engineering] Higgins: Third Floor*

This versatile laboratory provides adaptive workstations and experimental facilities for courses and projects in the general areas of heat transfer and combustion. It also includes equipment and computational and experimental set-ups for graduate work in these areas.

HYDRODYNAMICS LABORATORY*[Mechanical Engineering] Higgins: Basement*

This laboratory provides experimental facilities and instrumentation for measurement of liquid flow phenomena. A closed-circuit free surface water tunnel with a 2 ft. by 2 ft. test section and a vertical water tank are available for MQP's and research. These facilities are primarily for flow visualization are supported by data acquisition systems and various flow measurement devices.

LASER LABORATORIES*[Mechanical Engineering] Higgins: First Floor*

The Laser Laboratories are equipped with several systems utilizing He-Ne, Ar-ion, and Nd:YAG lasers. They are supported by a self-contained network of computers including printing and plotting facilities, as well as supporting instrumentation systems. The lasers, computers and supporting instrumentation are used in studies of fundamental phenomena governing high energy-density interactions in thin film imaging, with powder metal materials, plastics, ceramics, and composites, micromachining, underwater propagation, holography, displacement and strain measurement, vibrations, fracture mechanics, mathematical modeling, numerical computations, and applications to other problems of modern science, engineering and technology. This laboratory is available to students for course work, project work, and graduate research.

MANUFACTURING LABORATORY*[Manufacturing Engineering] Washburn: First Floor*

A range of manufacturing processes (sawing, drilling, grinding, bending, MIG and spot welding, and a large selection of manual and Haas CNC machine tools and eight (8) workstations and 10 PCs with CAD/CAM software) are available to support the academic programs in Manufacturing Engineering and Mechanical Engineering. Students can also draw on many other resources available, including a wide variety of robots, a coordinate measuring machine, and CAD/CAM systems.

See the Manufacturing Design Studio and Haas Technical Center for computer-controlled machining, under Resources in Washburn Laboratories on page 9.

MATHEMATICS LABORATORIES*[Mathematical Sciences]*

To complement WPI's math classes, the department has two computer laboratories: The Statistics Multimedia Classroom, an interactive classroom with PCs; The Math Lab with X-terminals. The labs are also supported by a full time Computer Operations Manager and Instructors' Associates who assist students with their mathematical computer needs.

MECHANICAL TESTING LABORATORIES*[Mechanical Engineering] Washburn: First Floor*

Experimental mechanical testing facilities are available for teaching and research related to mechanical properties and deformation of metals, ceramics, and composite materials.

Equipment available includes:

- A computerized Servo-Hydraulic Tension-Compression System with supporting grips, environmental chambers, and furnaces.
- An Instron Computerized Tensile Tester for high accuracy, low load testing of ceramic materials.
- Two 55 kip computer-controlled Servo-Hydraulic Tension-Compression Systems with supportive grips, environmental chambers, and furnaces.
- Two high temperature and three room temperature stress-rupture systems.

NUCLEAR MAGNETIC RESONANCE**(NMR) IMAGING FACILITY***[Biomedical Engineering]*

A Nuclear Magnetic Resonance (NMR) Imaging facility is located at the Central Massachusetts Magnetic Imaging Center (CMMIC) and is part of a joint research program between the Biomedical Engineering Department and the Department of Radiology at UMass Memorial Health Care. This facility houses a General Electric (GE) 2.0 Tesla (T) imaging spectrometer as well as a chemistry/electronics laboratory for sample preparation and radio frequency coil research. In addition to the 2.0 T instrument, two GE 1.5 T clinical imaging instruments are also available at CMMIC for suitable research projects.

OPTICAL AND ELECTRON MICROSCOPY LABORATORIES*[Mechanical Engineering] Washburn: Second Floor*

Two scanning electron microscopes (SEM), an analytical scanning transmission (AEM) electron microscope, optical reflection and transmission microscopes, and supporting sample preparation and photographic equipment are the major facilities available for microstructural analysis. SEM's are available equipped with an Energy Dispersive X-ray (EDX) Analyzer, or equipped with stage-automated digital image analysis, a light element Quantum X-ray detector with a Kevex Delta system and a wavelength dispersive X-ray analyzer. The AEM is equipped with Kevex EDX system. These facilities are used primarily for microstructural analysis and determination of crystal structures of fine phases present in metals and ceramics.

POWER ELECTRONICS AND POWER SYSTEMS LABORATORY*[Electrical and Computer Engineering Department]**Atwater Kent*

This laboratory has been established for simulation of a large variety of linear, non-linear and time-varying loads, including transistor and thyristor controlled loads. It contains transducers and instrumentation for a wide range of voltages, currents and frequencies. Compatible computer equipment and A/D interfaces are available for real-time data acquisition and processing. The laboratory has the

basic facilities for electromechanical energy conversion study, including sets of induction/synchronous/DC machines coupled together.

SATELLITE NAVIGATION LABORATORY

[Electrical and Computer Engineering Department]

Atwater Kent

This laboratory provides facilities for work on civilian uses of satellite systems, especially the Global Positioning System. Receivers, signal processors and computers are provided for work on the utilization of the DOD BPS system for civilian purposes, especially aircraft navigation and landing.

SOFTWARE ENGINEERING RESEARCH LABORATORY

[Computer Science] Fuller

The Software Engineering Research Lab houses the various software engineering projects led by Prof. George Heineman. The coordinating theme behind the projects is a strong emphasis on developing component-based software systems (CBSE) and providing tools and technologies to support CBSE. Professor Heineman actively pursues research in component-based software engineering, refactoring legacy systems to extract reusable software components, and approaches to monitor complex component-based systems.

SURFACE METROLOGY LABORATORY (SURF MET LAB)

[Mechanical Engineering] Washburn Second Floor

The Surf Met Lab is dedicated to supporting product and process design by advancing the understanding of surface topographies (i.e.; roughness) and the processes which make them. Topographic characterization methods are developed for the reduction of large topographic data sets, such as those acquired by atomic probe microscopy, confocal microscopy, scanning interferometric microscopes, and conventional profilers. The Surf Met Lab has: two scanning laser profilers, a scatterometer (ARS), and a conventional profiler. In addition, the Surf Met Lab has access to AFMs and other equipment through collaborations in the US, and Europe. The Surf Met Lab also has the use of sophisticated analysis software which employs fractal geometry principles.

ULTRASOUND RESEARCH LABORATORY

[Electrical and Computer Engineering Department]

Atwater Kent

The Ultrasound Research Laboratory in the Department of Electrical and Computer Engineering is an 800 sq. ft. facility set up for ultrasound experiments, numerical work, and development of electronic circuits. The lab contains measurement tanks, including a scanning tank with stepper motor controlled positioning system for the ultrasound measurements. Instrumentation is available for experimental ultrasound research, including pulser-receivers, a LeCroy 9400 Digitizer, a LeCroy 9100 Arbitrary Function Generator, a 350 MHz Tektronix oscilloscope, a HP 3585A Spectrum Analyzer, frequency synthesizers, and plotters. The Ultrasound Laboratory presently has a

DEC Alpha workstation, three Pentium PCs as well as 486 based computers. The laboratory has two Hewlett-Packard ultrasound scanners. The ImagePoint digital ultrasound system is interfaced with a HP 16554 Logic Analyzer for digital data acquisition of ultrasound data from array transducers.

VIBRATIONS/CONTROL/DYNAMICS LABORATORY

[Mechanical Engineering] Higgins: Basement

The Vibrations Laboratory supports educational, project, and research activities in the areas of vibrations and controls. The equipment housed in this lab includes signal analyzers, a 100-lb. shaker table, and computational hardware and software for various vibrations and controls applications.

VISUALIZATION AND IMAGE SCIENCE LABORATORY

[Computer Science] Fuller

The VIS Laboratory is used for research in visualization, graphics, image processing, and computer vision. Current projects include large-scale multivariate data visualization, volume visualization, multiple object recognition, and model-based vision. The Lab contains an Intel-based server, several SGI workstations (an Octane, 2 O2's, an Indy, and an Indigo 2), and a Pentium 2 PC.

VLSI DESIGN LABORATORY

[Electrical and Computer Engineering Department]

Atwater Kent

The VLSI laboratory supports state of the art design facilities based on both PC and workstation systems. These systems and software are available for the design, testing, simulation, layout and generation of analog, digital and mixed signal integrated circuits.

The software available is based on Tanner Tools for undergraduate and graduate course work, and on Tanner Tools or Cadence Design Systems EDA tools for project and thesis work. Both sets of tools support analog and digital design work. Additionally, the Tanner tools can be used for basic MEMS design work.

Integrated circuits can be fabricated through the MOSIS facility.

X-RAY DIFFRACTION LABORATORY

[Mechanical Engineering] Washburn: Second Floor

Two fully-automated and computerized x-ray diffractometers are available for teaching and research. In addition, a variety of software has been developed to utilize these instruments effectively. Currently, background modeling, peak searching, and curve fitting with deconvolution, are in use for quantitative phase analysis and residual stress analysis. Search of the JCPDS Powder Diffraction File is available. A variety of x-ray cameras and goniometers are available along with the choice of x-ray tubes targets to provide a wide x-ray diffraction capability. Additional support software is shared with the Electron Microscopy Facility to generate diffraction patterns for any crystal system in any desired orientation.

MUSIC AND THEATER FACILITIES

COMPUTER MUSIC LABORATORIES

Alden Memorial: Lower Level

These laboratories support creative and research activity in a variety of music- and sound-related applications including real-time virtual orchestra design and production techniques. The lab contains hardware and software for multi-track digital recording and editing, signal processing, algorithmic composition, sound synthesis, MIDI sequencing, music notation, and music programming.

GREAT HALL OF ALDEN

Alden Memorial: First Floor

The Great Hall is used for major productions in Theatre and Music. It is the venue for the Masque Theatre performances. The Hall is sometimes used, in addition, for festive and gala campus functions.

GREEN ROOM

Alden Memorial: First Floor

Alden Hall houses many of the theatre activities at WPI, both academic and extra-curricular. The Green Room serves as the laboratory for Department of Humanities and Arts, Division of Drama Theatre Performance projects and Sufficiencies. The Masque office on the second floor centralizes activities of the student drama club, one of WPI's largest organizations. The sub-basement contains the scene shop and props-storage area and also holds a major work room for Lens and Lights. Students interested in theatre performance and Lens and Lights activities have many resources in Alden Hall.

SPAULDING RECITAL HALL AND OTHER ROOMS FOR REHEARSAL AND PERFORMANCE

Alden Memorial: Lower Level

Alden Center for the Performing Arts houses the Spaulding Recital Hall, Perreault Chamber Rehearsal Room, the Janet Earle Choral Rehearsal Room, three practice rooms, and the Knight Lecture Room. Available for practice are Steinway grand pianos and the Three Manual Aeolian-Skinner pipe organ in the main Concert Hall. There are three concert grand pianos for recitals, ensemble work and concerts. WPI has some instruments that can be made available to students upon request; others can be rented.

OTHER MUSIC FACILITIES

Music facilities also include The Janet Earle Room, The Perreault Chamber Rehearsal Room, the music classroom, practice rooms, computer music labs and storage facilities.

GEORGE C. GORDON LIBRARY

The George C. Gordon Library invites all WPI students to take advantage of the services and resources that the library offers. The library is open over one hundred hours each week during the academic year and offers a comfortable atmosphere for study or relaxation.

The library's home page on the World Wide Web (<http://www.wpi.edu/+library>) is the focal point for library resources and services. The library catalog; electronic full-text journals; bibliographic databases and indexes; catalogs of remote libraries; and many other reference resources are available to students.

The library collection supports the curriculum and research needs of the WPI community. Currently the library holds over 250,000 volumes and subscribes to over 900 print and over 7,000 electronic periodicals. The library collection also includes undergraduate project reports, graduate theses and dissertations, the WPI archives, and the special collections, most notably the Robert Fellman Dickens Collection. Library materials come in a variety of formats—print, audio, video, and digital. In addition to the many academic resources, the library also maintains a collection of popular books for leisure reading.

WPI students have access to the collections of other libraries in the Worcester area, and they can borrow books directly from the libraries at Anna Maria College, Assumption College, Becker College, Clark University, College of the Holy Cross, University of Massachusetts Medical Center, and Worcester State College. Students also can request materials not held in Gordon Library from other libraries through the interlibrary loan office and document delivery service.

Students will find that the Gordon Library staff is both knowledgeable in the use of library resources and ready to assist them with their information needs. The Reference Department helps students with research problems and questions; offers library instruction and orientation sessions; and provides special help to project groups. Members of the staff will be happy to provide students with additional information about library services and resources.

ACADEMIC TECHNOLOGY CENTER (formerly the Instructional Media Center)

The main office of the Academic Technology Center (ATC) is located in the southwest corner on the 1st floor of Fuller Laboratories. ATC provides a wide variety of technology-based services in support of the teaching and learning needs of students, faculty and staff, and serves as the central coordinating and distribution hub for most of the audio/visual equipment utilized on campus. ATC supports all of the technology available in WPI's electronic classrooms and conference rooms. In addition, instructional technology and audio/visual equipment can be reserved and signed out for short periods of time to

support educational needs. Equipment loans are for valid WPI projects and classes only, and are not for personal use. The ATC's inventory of loan-out equipment includes laptop PCs, video/data projection systems, digital cameras, digital voice recorders, portable video equipment, VCRs, TV/VCR combination units, 35mm slide projectors, overhead projectors, small and large screens, and other miscellaneous items such as portable zip drives, wireless Ethernet cards, tripods, cables, etc.

In addition, the ATC offers graphic design and production services to faculty, staff and students. These include large format poster printing, print and 35mm slide scanning, copystanding, 35mm slide printing, and design assistance. Workshops on using multimedia and presentation graphics software, as well as covering effective design techniques are offered throughout the year.

Through the generosity of the Class of 1956, extensive multimedia development tools are available in the multimedia resource lab located in the Gordon Library, Room 208 (next to the Circulation Desk). The multimedia resource lab (a.k.a. the Movie Lab) contains 15 Multimedia PC's with 100mb Ethernet connections, Logitech web cams, CDR-W's, two flatbed scanners, a PDF scanner, and an instructor station for workshops and classes. Each computer is fully loaded with popular multimedia software, including Photoshop and Illustrator for image editing, Premiere for video editing, Cool Edit 2000 for audio editing, 3D studio max for animation as well as the Microsoft Office Suite and the full version of Acrobat. Students, faculty and staff have the option of producing their own material with or without the assistance of ATC staff.

ATC is also responsible for *myWPI*, the university's learning and information portal. *myWPI* is used in support of WPI's academic programs, but also services the communication and collaboration needs of student organizations, faculty/staff committees, and other campus-wide initiatives. For fastest assistance, please e-mail the *myWPI* support team at myhelp@wpi.edu. A state-of-the-art instructional television classroom/studio and two adjacent control rooms are also available and are used primarily in support of WPI's distance learning program – the Advanced Distance Learning Network (ADLN). Members of the WPI community who wish to produce a video in support of an educational activity can obtain professional assistance from the ATC (advanced notice is required). Production costs are usually covered by ATC. On-location productions using portable equipment can also be arranged but require additional preparation and planning.

The head end of the WPI cable TV network is located in the ATC. Announcements pertaining to campus events can be shown on the WPI Video Bulletin Board (submission forms can be obtained from the ATC website). In addition, the ATC operates and maintains WPI's satellite receiver, capable of receiving both Ku and C-band transmissions; and WPI's ISDN/IP-based videoconferencing systems.

For more information about the services available from the ATC, please refer to the department's website at <http://www.wpi.edu/+ATC>.

ADVISING AND STUDENT SERVICES

STUDENT DEVELOPMENT AND COUNSELING CENTER

The WPI Student Development and Counseling Center (SDCC) provides a wide range of services that are FREE of charge to all students enrolled in classes at WPI. The primary purpose of the SDCC is to provide counseling, educational programming and training, referral, and crisis intervention services to the entire WPI student community focusing on 1) assisting students in their full and complete development as they go through the process of becoming adults so that they may achieve greater levels of personal, academic, and professional success, and 2) assisting students in becoming aware of, and effective in, their roles, relationships, and responsibilities as members of an ever burgeoning global society. The professional staff are trained to help students deal with a variety of issues including:

Situational Problems— poor academic performance; managing stress; time management; relationships with significant others; divorce or other family problems; feelings of loneliness, anger, anxiety, confusion, depression; loss; discrimination; harassment; alcohol or other substance problems; sleep disturbances; medical/physical conditions; learning disabilities.

Crisis-Related Problems— physical and/or sexual assault; impulse control problems; suicidal thoughts or behaviors; traumatizing experiences such as date rape, academic setbacks, or the loss of a loved one.

Developmental Issues— developing self-esteem; establishing personal and/or gender identity; helping to define sexual orientation; managing stress from earlier traumatic events; exploring personal and professional goals.

The SDCC staff can also provide referral services for psychiatric evaluation, psychological and learning disability assessment, or other treatment.

The services of the SDCC are confidential. The mental health professionals and support staff are highly trained and sensitive to students' privacy and personal concerns.

The SDCC is located at West Street House, 157 West Street, near the corner of Institute Road. Appointments may be made during the academic year (A through E terms) in person or by calling (508) 831-5540. Office hours are 8:30 a.m. to 5:00 p.m. Monday-Friday (8:00 a.m. to 4:00 p.m. June to mid-August).

MAJOR SELECTION PROGRAM, A SERVICE OF THE CAREER DEVELOPMENT CENTER

Choosing a college major and its associated careers is one of the most important decisions you will make. The Major/Career Selection Program, or MSP, provides you the means to make that decision in an informed manner.

Why? We know that if you are in the “right major” and knowledgeable about the career paths available to you, you will enjoy your coursework, do better academically, and have a passion for your chosen work following graduation.

How can you select a major or learn more about a particular career path that leads to satisfaction? The answer is easy, through the information and experiences the MSP offers.

Contrary to what most people think, the MSP is not just for first-year students. It can help any WPI student to explore, identify and select a major and/or career field.

MSP activities include, but are not limited to:

- Company tours
- C-term seminar
- Career tests
- Individual Counseling

The CDC is located in the lower level of the Project Center. Appointments may be made in person or by calling 831-5260. Office hours are 8:30am.-5:00pm.

MASH (MATH AND SCIENCE HELP) PROGRAM

MASH is an academic support program for first-year students in mathematics and science courses. Offered to *all* students enrolled in a supported course, MASH provides assistance in regularly-scheduled study sessions beginning the first week of the term.

MASH review sessions are offered for a limited number of courses which students and faculty have identified as difficult. These courses may have heavy homework assignments or they may require understanding of new and difficult concepts. Whatever the reason, some courses are more challenging than others. MASH helps students meet that challenge.

Each study group is guided by a MASH leader, an undergraduate student who has taken the course before and who, therefore, understands the course material and what the instructor expects. MASH leaders attend all class lectures, take notes, complete assigned readings and other assignments, and conduct three or four 50-minute MASH sessions each week. By attending class and demonstrating effective student behavior, MASH leaders can assist students with the language of the discipline, the integration of lecture and readings, and the development of good study habits.

Through the MASH program, students become actively involved with the content material in a supportive environment. Studies show students who attend MASH sessions regularly earn higher grades than students electing not to participate. But even more important, MASH participants master new concepts, learn to put ideas into perspective, and develop a better way to study. MASH is offered by the Office of Academic Advising.

ACADEMIC RESOURCES CENTER

WPI's Academic Resources Center (ARC) provides academic support services that are designed to enrich and enhance the learning experience of all WPI undergraduate students. Its student-based collaborative learning environment offers individualized assistance in a variety of subjects, as well as a comprehensive peer tutoring program, seminars and workshops.

Students may obtain individual counseling in such areas as learning styles, effective study strategies, problem solving and critical thinking skills, and time management. Appointments may be set up with staff members to develop individualized Academic Success Plans which help students set their academic goals, discover their learning strengths and weaknesses, and design the appropriate learning and study strategies that work best for them.

Periodically, students may find that they need some individual assistance with a particular subject or topic. The ARC peer tutors, who are certified by the College of Reading and Learning Association, help students one-on-one in a variety of academic subjects. Appointments are recommended, although tutors are available on a walk-in basis.

The Academic Resources Center is located in Daniels Hall. The hours of the center are 8:00 a.m.-4:30 p.m., Monday through Friday. Students may drop by the Center or call (508) 831-5281 for an appointment.

STUDENT DISABILITY SERVICES OFFICE

The mission of the Disability Services Office is to ensure that all students with disabilities can freely and actively participate in all facets of University life; to provide and coordinate support services that enable students with disabilities to maximize their educational potential; and to increase the level of awareness among members of the University so that students with disabilities are able to perform at a level limited only by their abilities, not their disabilities.

By law, it is the student's responsibility to identify himself/herself to the Student Disability Services Office and to provide documentation of the disability by a licensed professional. (Please note that learning disabled students' documentation must be less than three years old.) All incoming students have the opportunity to self-identify their disability (physical and/or learning) by filling out the bottom portion of the Disabilities Letter (pink form) enclosed in their New Student Orientation Package. Students should send this form, along with the supporting documentation, to the Student Disability Coordinator. Students with disabilities, who are self-identified after their admission to WPI, must also provide appropriate documentation to Student Disability Services Office, if they wish to receive accommodations.

For further information please contact the Student Disability Services coordinator at (508) 831-5235.

WRITING WORKSHOP A Division of the Center for Communication Across The Curriculum (CCAC)

The Writing Workshop offers all WPI students tutorial assistance on writing of any type: course assignments, project work, oral presentations, laboratory reports, proposals, resumes, and letters of application. The workshop is directed by a member of the Humanities and Arts Department faculty and staffed by student peer tutors, all of whom have been trained in a special course on tutoring writing. Students may be referred to the Workshop by faculty, or students may make appointments on their own initiative. The workshop is open according to posted schedules, and its tutorial services are available at no cost.

For more information, visit the Writing Workshop in the Project Center.

WRITING COURSES AND ADVISORS

For information on WPI's writing programs, see Humanities and Arts faculty as follows:

Students for whom English is the native language can consult Prof. J. Trimbur (39 Dean St., Room 258) about these programs.

The WPI advisor for undergraduate students whose native language is not English is Prof. J. Forgeng (SL 08).

WORLD WIDE WEB

The WPI World Wide Web server is the campus information system. It contains a great deal of useful information about people and programs at the university, and is updated frequently. In addition, by using the Web, students gain access to a vast universe of information on any subject imaginable. This is why the web is such a useful research tool for both faculty and students.

WPI's web address, or URL, is: www.wpi.edu. Questions about WPI's website should be directed to the Web Development Office, webmaster@wpi.edu.

THE WPI PLAN

one

WPI Degree Requirements	22
The Planning Process	23
Academic Advising	24
Major Areas of Study	24
Concentrations	26
Minors	26
Double Majors	27
Minimum Distribution Requirements for Students	28
Courses Qualifying for Engineering Distribution Areas	35
Projects	35
Projects Program	37
The Interactive Qualifying Project	39
The Major Qualifying Project	39
Residential Project Programs	47
On-Campus IQP Programs	53
The Sufficiency	54
The Social Science Requirement	61
Awards And Prizes	61

WPI's academic requirements are specifically designed to develop an overall educational experience which meets the goals of the college. Each requirement plays a supporting role as follows:

- To provide intellectual breadth and a better understanding of themselves, their cultures and their heritage, every WPI student must complete a **Humanities and Arts Sufficiency Project**;
- To provide an understanding of the priorities of other sectors of society, develop the ability to communicate effectively with disparate groups, organize and derive solutions to complex problems, and gain an awareness of the interrelationships between technology and people, every WPI student must complete an **Interactive Qualifying Project (IQP)**;
- To provide a capstone experience in the professional discipline, to develop creativity, instill self-confidence and enhance the ability to communicate ideas and synthesize fundamental concepts, every student must complete a **Major Qualifying Project (MQP)**;
- To provide for learning through an academic program with fabric and course balance while encouraging individual student choices within that framework, every student must fulfill **Distribution Requirements**.

WPI TERMS AND CREDIT UNITS

The Bachelor of Science degree from WPI normally is based upon a residency at WPI of 16 terms. WPI operates on a quarterly system with four seven-week *terms*, two in the autumn semester (Terms A and B) and two in the spring semester (Terms C and D). A seven-week summer session, Term E, is also available. The normal academic load for each term is defined as *one unit* of work, usually divided among *three* courses or projects. Thus, the usual credit unit for courses or independent study/projects is 1/3 unit. *Qualifying Projects*, defined on pages 35-37, require one full unit of activity which may be concentrated into a single term (especially if conducted off-campus) or spread throughout an academic year. The degree will be awarded upon completion of the following:

DEGREE REQUIREMENTS

1. **The Humanities and Arts Sufficiency Project** (See page 54)
Qualification by overall evaluation of two units of work in the area. Students majoring in a scientific or engineering field or in business management or the social sciences fulfill the requirement in a humanities and arts area. Students majoring in a humanities and arts area fulfill this requirement in a scientific or engineering area.
 2. **The Interactive Qualifying Project** (See page 39)
Successful completion of a qualifying project relating science and/or technology to society (the Interactive Qualifying Project, or IQP) representing at least one unit of credit in project or independent study work. The format of the documentation is to be in accordance with current WPI policy on such documentation.
- An IQP shall address a topic relating science and/or technology to society. In this context, both "society" and "technology" should be construed as broadly as possible. Technology refers to the application of rational and efficient principles to a body of knowledge or to the control of space, matter and/or human beings. Thus, the IQP encompasses not only techniques of production embodied in tools and machines, but also advances in methods of social and economic organization, in managerial techniques, and in methods of analysis in science, mathematics, and engineering. Society refers not only to a grouping of individuals but also to the culture, values, laws, customs, and institutions shared by these individuals.
3. **The Major Qualifying Project** (See page 39)
Successful completion of a qualifying project in the major area of study (the Major Qualifying Project, or MQP) representing at least one unit of credit in project or independent study work. The format of the documentation is to be in accordance with current WPI policy on such documentation.
 4. **Distribution Requirements** (See page 28)
Satisfaction of published academic activity distribution requirements in or relating to the major area of study. These requirements total no more than ten units (including the MQP) and are specified by general topical subject area, not by specific courses. Completion of distribution requirements will be certified by the appropriate departmental or Interdisciplinary and Global Studies Division (IGSD) Program Review Committee (PRC), upon recommendation by the student's academic advisor. For students desiring designation of a major area for which a determination regarding distribution requirements has not previously been made and published, a faculty committee will be appointed by the department head or IGSD dean to review and approve the student's program of study.
 5. **Social Sciences** (See page 61)
Completion of 2/3 unit of work in the social sciences, exclusive of qualifying project.
 6. **Residency Requirement**
A minimum of eight units *must* be completed satisfactorily in residence at WPI. (It is anticipated the normal residence at WPI will be 16 terms.)
 7. **Minimum Academic Credit**
The minimum academic credit required for the Bachelor of Science Degree is 15 units. Credit accumulated beyond the published distribution requirements shall be accomplished by the addition of "free elective" work.
 8. **Physical Education** (See page 152)
Qualification in physical education shall be established by completing 1/3 unit of course work (four PE classes) or its equivalent. Such an equivalent, for example, may be participation in club or varsity sports. No student may use any 1/12-unit PE courses beyond these four required 1/12 units to satisfy any other requirement, or to meet the 15-unit rule (#7 above).

PLANNING FOR PROFESSIONAL DEVELOPMENT

To prepare fully for the challenges of professional work and further education, during the normal 16 terms (i.e., four years) of residency, WPI students should make the most of the many important and exciting educational programs available under the Plan *in addition to* the formal degree requirements as stated above. Therefore, from the beginning of their education at WPI, all students should consider seriously the following key activities which can enrich the basic program (see below):

- Courses or projects taken to prepare for the IQP.
- Projects taken to explore new fields of interest.
- Participation in one of WPI's foreign exchange programs or international project centers.
- Study in areas of management, economics, or law.
- Expansion of project depth in the IQP or MQP areas.
- Additional advanced courses in your own and related fields, including graduate courses.
- Participation in the WPI B.S./M.S. program—an excellent gateway to the M.S. degree.

- Special course work at a liberal arts college through the Worcester Consortium.
- Exploration of that "other area" of science, computer science, or engineering that you always wondered about.
- Double majors involving both technical and nontechnical fields.
- Special programs of study for Entrepreneurship.
- Pursuit of a minor in an area of interest.

The opportunities at WPI are extraordinary for those who wish to develop the full degree of professional depth and educational breadth which are the hallmarks of WPI's education.

Students are strongly encouraged to discuss the advantages of graduate study with their departmental advisors in the sophomore, junior, and senior years. Excellent opportunities exist to integrate upper level courses with graduate study at WPI through the WPI combined B.S./M.S. program described on pages 73, 92, 129, 158 and 242.

THE PLANNING PROCESS

At WPI, students, with the aid of their advisors, structure their own academic programs within the guidelines of the program distribution requirements. Thus, examples of specific programs presented in this catalog do not have to be followed literally. There can be as many different individual programs as there are students, provided the distribution requirements designated for that program are followed.

An undergraduate program should avoid premature over-specialization. Students must obtain a firm, rigorous understanding of the fundamental concepts of their disciplines. An acquaintance with an aspect of state-of-the-art technology is often best achieved through the MQP. Concentrating too soon on changing technological specialities will deprive students of the broad background necessary to educate themselves in new areas as they emerge. Students in engineering, for example, must obtain a firm grounding in mathematics and science, as well as the engineering sciences. Some study *in at least one other area of engineering outside* the major field is highly valuable for professional practice.

The IQP should be integrated carefully with your overall program, especially the social science requirements. Establish your plans early to take advantage of exciting opportunities WPI offers, at home or abroad. (IQP and exchange opportunities are discussed annually in the fall.)

Information on programs can come from many sources: advisors, other faculty, other students, professionals in the field. As soon as possible in the first year, students will discuss their academic goals with their advisor and plan a general academic program for their entire residence at WPI. If changes in details or even major goals occur, students can integrate them into a cohesive educational pattern which can maximize WPI's unique program. As students mature, their confidence about making decisions for their own education will grow, too. Indeed, accepting responsibility for

program planning is a major and exciting educational effort. Students consult with their advisors, but *the final responsibility for program construction remains with each student.*

Through courses and independent studies in the first two years, students should sample, explore, and learn the basic concepts of the disciplines necessary to their academic goals. This exploration and sampling will provide, first, a base of knowledge to build upon for further learning; and second, an insight into their basic interests for educational development.

In the latter portion of the academic program, students have the opportunity as they mature to explore, in some depth, specific areas within their disciplinary interests. These experiences should develop ability in self-learning and should involve a significant scholarly effort. Students should strive to learn how to educate themselves from a base of fundamental concepts so that they can develop in new intellectual areas throughout their lifetime.

PROFESSIONALLY ACCREDITED PROGRAMS

WPI is accredited as an institution by the New England Association of Schools and Colleges. In addition, six majors at WPI also carry the additional professional accreditation of the Engineering Accreditation Commission of ABET. These majors are *civil engineering, chemical engineering, electrical engineering, industrial engineering, mechanical engineering, and manufacturing engineering*. *Computer Science* is accredited by the Computing Accreditation Commission of ABET. Please note that some departments bearing those particular names may also grant designated majors through their programs that are *not* ABET accredited (e.g., Sanitary Engineering). The titles of majors are carried on the students' transcripts and have a bearing on engineering licensing and other professional activities.

Programs *not* in civil engineering, chemical engineering, computer science, electrical engineering, industrial engineering, mechanical engineering, and manufacturing engineering are *not* ABET accredited.

The program distribution requirements reflect the ABET guidelines for these programs; see pages 28-34 for a review of these guidelines.

Projects and courses carry the same credit weight in establishing all distribution levels. Establishing some engineering breadth and technical literacy *outside* one's own field is an

important element in establishing a versatile background for an unknown future.

The Chemistry and Biochemistry Department and its program at WPI are approved by the American Chemical Society for a major in chemistry. Those chemistry majors who complete a program satisfying the guidelines established by the American Chemical Society are certified to that organization as having received an undergraduate professional education in chemistry.

ACADEMIC ADVISING

As a student, you have the responsibility of choosing your own program of studies. Your advisor can inform you of available academic alternatives. While your advisor will be willing to suggest specific study programs, he or she will not insist that you follow a particular course of study. By the end of the first semester, you and your advisor should agree upon a tentative four-year academic plan.

A successful advising program is based on a cooperative and understanding relationship between student and advisor. Consult your advisor regularly. Drop in and tell your advisor how the term is going. If you add or drop a course, you should notify your advisor. Many advisors post office hours during which they are available for conversation. If you cannot find your advisor in his or her office, leave a note with the appropriate departmental secretary, indicating your wish to make an appointment; in that note, indicate several times when you could meet with your advisor and also indicate the means by which you can be contacted. Above all, do not hesitate to call or e-mail your advisor on campus, to ask questions, or to arrange for an appointment.

FIRST-YEAR ADVISING (PRE DECLARATION OF MAJOR)

Under WPI's Insights Program, first year students are advised by a small number of faculty academic advisors who make a real commitment to working with groups of

students, usually in their residence halls. New students are assigned an Insight advisor who advises a group of 25 to 30 students. These advisors represent all the departments and programs at WPI, and in many cases are the senior faculty members and the most experienced advisors. At WPI, first year advising is much more about mentoring students and much less about course scheduling. Each group is also assigned a peer advisor whose main role is to assist the academic advisor. At the end of the first semester, in December, students officially declare their majors and are assigned an advisor from the department of the declared major.

UPPERCLASS ADVISING

During December or January of the first year, most first-year students wish to be assigned to a new advisor in their major areas of study. Forms to change advisors can be obtained from the office of the Director of Academic Advising at any time during the academic year.

The determination of an appropriate four-year program requires considerable thought and information. Not only your advisor but also departmental consultants, the Projects Office, and the consultants in the Humanities and Arts Department can provide you with assistance in planning for both qualifying projects and a Sufficiency area.

MAJOR AREAS OF STUDY

Guidelines for the construction of the most common major programs are given alphabetically by area in the "Department and Program Descriptions" section beginning on page 65. The exact program of study for any student, however, is developed by the student with the aid of an advisor.

Please note that only areas of study which are accredited at WPI by ABET are civil engineering, chemical engineering, computer science, electrical engineering, industrial engineering, mechanical engineering, manufacturing engineering, or subareas within those disciplines where appropriate as listed below. For further discussion of accredited degrees, see "Professionally Accredited Programs" on page 23.

The WPI student is not restricted to a major whose name coincides with a department name. Under the WPI Plan, students may major in any area in which the WPI faculty is competent both to help them learn and to evaluate their performance on a suitable professional level. Students should not overlook a wide range of possible majors available at WPI in the Social Sciences, Humanities and Arts, Management, and Interdisciplinary Studies areas.

In the examples below, some programs are listed that are developed through the departments indicated in parentheses. In the past, WPI has graduated students in the following fields, but this list should not be interpreted as necessarily putting any restriction on a student's "major:"

Applied Mathematics (MA)
 Actuarial Mathematics (MA)
 Biochemistry (CH) (certified by the American Chemical Society)
 Biology (BB)
 Biomedical Engineering (BE)
 Biomedical Sciences (IGSD)
 Biotechnology (BB)
 Chemical Engineering (accredited by ABET)
 Chemical Engineering with Biomedical Interests
 Chemistry (certified by the American Chemical Society)
 Civil Engineering (accredited by ABET)
 Computer Science (accredited by ABET)
 Computers with Applications (CS)
 Construction Management (CE)
 Economics (MG)
 Economics and Technology (SSPS)
 Electrical Engineering (accredited by ABET)
 Areas within the EE major:
 Aerospace and Control Systems
 Analog Microelectronics
 Biomedical Engineering
 Communications and Signal Analysis
 Computer Engineering
 Power Systems Engineering
 RF Circuits and Microwaves
 Electrical and Computer Engineering (ABET accreditation pending)
 Areas within the ECE major:
 Aerospace and Control Systems
 Analog Microelectronics
 Biomedical Engineering
 Communications and Signal Analysis
 Computer Engineering
 Power Systems Engineering
 RF Circuits and Microwaves
 Engineering Physics (PH)
 Engineering Science (IGSD)
 Environmental Policy & Development (SSPS)
 Environmental Studies (IGSD)
 Fire Protection Engineering* (FPE)
 Humanities and Arts (HU)
 Concentrations in:
 American Studies
 Art History / Architecture
 Drama / Theatre
 Environmental Studies
 German Studies
 Hispanic Studies
 History
 Humanities Studies of Science & Technology
 Literature
 Music
 Philosophy
 Religion
 Writing and Rhetoric

Industrial Engineering (accredited by ABET) (MG)
 Interdisciplinary (by arrangement)
 International Studies (IGSD)
 Management (MG)
 Management Engineering (MG)
 Management Information Systems (MG)
 Manufacturing Engineering (ME; accredited by ABET)
 Materials Engineering* (ME)
 Mathematical Sciences (MA)
 Mechanical Engineering (accredited by ABET)
 Concentrations in:
 Aerospace
 Biomechanical
 Engineering Mechanics
 Mechanical Design
 Manufacturing
 Materials Science
 Thermal-Fluids
 Nuclear Science* (IGSD)
 Operations Research (MA)
 Physics (PH)
 Society, Technology & Policy (SSPS)
 Statistics / Probability (MA)
 Structural and Geotechnical Engineering (CE)
 System Dynamics (SSPS)
 Technical, Scientific, and Professional Communications (HU or IGSD)
 Transportation Systems (CE)

*Usually combined with MS major programs.

Programs for students interested in medicine, law or pre-college education can be readily developed from many of the above majors.

Interdisciplinary (individually-designed) majors (ID) may also be developed; see Interdisciplinary Programs, page 118.

WPI undergraduate diplomas designate "Bachelor of Science" for *all* students. The transcript will list the student's major. If a specialization was completed, this will also be included on the transcript. For example, an entry of "Electrical Engineering with Biomedical Interests" could be made for a student whose course spectrum and qualifying projects substantiate that orientation.

The number of majors associated with a single WPI Bachelor of Science degree is **limited to two**.

CONCENTRATIONS

DEFINITION:

A Concentration is an option associated with a Major which provides recognition for focused and coordinated academic work either within the Major or within an area of study closely related to the Major.

RULES:

1. All Concentrations require completion of two units of integrated academic study plus an MQP with a topic and content appropriate to the given Concentration.
2. Concentrations deemed to belong exclusively or primarily within the stated Major must be accommodated within the distribution requirements of that Major.
3. Concentrations deemed to have a substantial interdisciplinary nature can exceed the normal 10-unit allotment of the Major by as much as 1 unit, provided that the additional requirements do not include or permit academic work designated by the Major prefix or coursework normally taken to satisfy the Major's portion of the distribution requirements. Furthermore, Concentrations of an interdisciplinary nature are permitted to use up to 1 unit of the academic program beyond the distribution requirements of the Major, including the IQP, Sufficiency, Social Science requirement, and Free Electives, as deemed appropriate.
4. The requirements of the Concentration must be designed to offer choices for the student within the Major area and, if relevant, outside the distribution requirements of the Major; however, the Concentration requirements must not preclude meeting the normal distribution requirements for the Major.

5. Rules and guidelines for each Concentration will be formulated by the faculty associated with the governing Major, and must be reviewed by the Committee on Academic Operations (CAO) and subsequently approved by the Faculty. CAO is empowered to rule on whether a proposed Concentration is disciplinary or interdisciplinary.
6. An individual program of study leading to a Major with a Concentration will be planned by a student in consultation with his/her academic advisor. The student's intention to pursue a Concentration will be declared by application to the appropriate Program Review Committee in accordance with that Committee's schedule of deadlines. Application deadlines should be designed to enable Committee review and communication of decisions to students at a sufficiently early point that flexibility of schedule still exists. Extenuating circumstances may be considered at the discretion of the Program Review Committee.
7. Concentrations and minors are additional degree designations. Any credit earned for an additional degree designation must not overlap with credit earned for another additional degree designation by more than one unit. Also, no credit-bearing activity may be triple-counted towards degree designations or degree requirements.

Listings of Concentrations may be found in the "Department and Program Descriptions" section beginning on page 65.

MINORS

DEFINITION:

A Minor is a thematically-related set of academic activities leading to a degree designation in addition to but separate from that granted by the Major. A Minor should be available to students of any Major, with the exception of a Minor which overlaps with a Major area to such an extent that it is not sufficiently distinct from that Major. The Committee on Academic Operations (CAO) is responsible for the review of proposed Minor Programs and decisions regarding allowed Major/Minor combinations.

RULES:

1. A Minor requires completion of two or more units of thematically related activity. The concluding 1/3 unit of the Minor must be a capstone experience that marks completion of the Minor.
2. It is expected that Minor requirements will be structured so that all acceptable Major/Minor combinations can be accommodated within a normal 16 term framework.
3. A Minor may include any portion of the academic program, excluding the MQP and the final Type 5 IS/P of the Sufficiency. Academic activities used in satisfying the regular degree requirements may be double-counted toward meeting all but one unit of the Minor requirements, subject to the following restrictions:

- a. The first unit of double-counted work may include at most 1/3 unit of the IQP, 3/3 units of the Sufficiency (excluding the final Type 5 IS/P), or a combination thereof.
- b. At least one unit of the Minor, including the capstone activity, must be free elective choices.
4. The Program Review Committee for a Minor area will consist of faculty members designated by the sponsoring faculty members.
5. A Minor area must be proposed by a sponsoring group of faculty and must be defined by the purpose of achieving an educational goal beyond those apparent or implicit in the regular degree requirements. Student-initiated Minor Programs must be developed with the approval of a sponsoring group of faculty advisors. Each Minor Program must be reviewed by CAO for its individual merit.
6. Concentrations and minors are additional degree designations. Any credit earned for an additional degree designation must not overlap with credit earned for another additional degree designation by more than one unit. Also, no credit-bearing activity may be triple-counted towards degree designations or degree requirements.

Minors are described in the “Program Description” section of this catalog. Minors sponsored by a department are described following the department. Others are listed alphabetically by title. As of the printing of this catalog, the following *Minors* have been approved:

Computer Science; Entrepreneurship; Foreign Language; International Studies; Law and Technology; Management; Management Information Systems; Manu-

facturing Engineering; Materials; Music; Organizational Leadership; Physics; Social Sciences (Economics, Sociology, Political Science and Law, Psychology, System Dynamics); Statistics.

Interdisciplinary or Individually Designed (ID) minors are approved by the Committee on Academic Operations (CAO).

DOUBLE MAJORS

An option for some students who wish to broaden their WPI experience is the completion of two distinct majors through the double major option. The choice to pursue a double major should be made early in a student’s career. The limit on the number of majors that a student may complete per degree is two.

Students are reminded that WPI offers only one undergraduate degree. Each graduating undergraduate student receives only one diploma, which reads “Bachelor of Science.” For double majors, the diploma may list both majors (in order of preference by the student), either major, or no major as indicated by the student.

The following modifications are made to the degree requirements for students who elect to pursue a double major:

1. THE SUFFICIENCY.

If a major requires the completion of a humanities and arts sufficiency, satisfactory completion of an MQP in Humanities & Arts or International Studies shall satisfy the humanities and arts sufficiency requirement.

If a major requires completion of a technical sufficiency, satisfactory completion of an MQP in a science, engineering, or mathematics discipline shall satisfy the technical sufficiency requirement.

2. THE INTERACTIVE QUALIFYING PROJECT.

If a major is in Social Science and Policy Studies, a single project bearing at least one unit credit may be used to satisfy both the MQP requirement for the SSPS major and the IQP requirement. In order to be used to satisfy both requirements, the combined social science MQP and IQP must meet the goals of both projects. It must be interactive in nature involving an aspect of technology, and must also be an application of social science knowledge and analytical techniques. In order to select a single project that satisfies both the goals of the MQP and the goals of the IQP, the decision to pursue a social science double major needs to be made fairly early in the student’s career.

3. THE MAJOR QUALIFYING PROJECT.

At least one separate and distinct major qualifying project of at least one unit of work must be completed for each major.

4. DISTRIBUTION REQUIREMENTS.

The distribution requirements for each major must be met, but requirements common to both majors only need to be satisfied once. Students pursuing multiple majors, concentrations, and/or minors should also consult the rule on *Credit Overlap for Degree Designations and Requirements* (page 225). The requirements for each individual major must be completed and certified by the Program Review Committee of the department offering that major.

Some departments offer more than one major. A degree may not include more than one major course of study from the same department unless provided for in the list of exceptions below.

Exceptions:

- A student may major in Industrial Engineering and also in either Management, Management Engineering, or Management Information Systems.
- A student may major in Chemistry and also in Biochemistry.
- If a student wishes to complete two Interdisciplinary (Individually-Designed) Major Programs, the double major must be proposed in a single Educational Program Proposal which must be approved by the student’s Program Advisory Committee for each major. The Committees shall ensure that the majors are substantially non-overlapping.

OTHER PROVISIONS.

If a student’s double major includes an Interdisciplinary (Individually-Designed) Major Program, the double major must be described in the Educational Program Proposal for the Interdisciplinary Major.

MATRICULATING AFTER MAY, 2003

The distribution requirements for students who have matriculated before May, 2003 (if different from the requirements printed below) are listed in the individual program descriptions beginning on page 65.

The normal period of residency at WPI is 16 terms. In addition to the WPI requirements applicable to all students (see page 22), distribution requirements apply to 10 units of study in specific areas as listed on the following pages:

ACTUARIAL MATHEMATICS Requirements	Minimum Units
1. Mathematics (including MQP) (See notes 1-6).	7
2. Management (See note 7).	4/3
3. Additional courses or independent studies (except MS, PE courses, and other degree requirements) from any area (See note 8).	5/3

NOTES:

1. Must include MA 3831 and MA 3832, or their equivalents, at least one of MA 3257, MA 3457, or equivalent, and at least one of MA 3631, MA 4632, or equivalent.
2. Must include two of the following: MA 2073, MA 2271, MA 2273, MA 2431, MA 2631, or their equivalents.
3. Must include three of the following: MA 3211, MA 3212, MA 4213, MA 4214, or their equivalents.
4. May not include independent studies directed toward Society of Actuaries exams.
5. May not include either MA 2201 or MA 2210.
6. May not include both MA 2631 and MA 2621.
7. Must include MG 2101 and MG 2200 or their equivalents.
8. Must include 2/3 units of computer science.

BIOCHEMISTRY	Minimum Units
1. Mathematics and Physics (Note 1).	2
2. Chemistry and Biochemistry (Note 2).	4
3. Biology (Note 3).	1 2/3
4. Chemistry and Biochemistry / Biology Laboratory (Note 4).	1
5. Other Natural or Computer Science (Note 5).	1/3
6. MQP	1

Notes:

1. The mathematics in MA 1021-MA 1024 or the equivalent is recommended. The physics in PH 1110-PH 1120 or equivalent is recommended.
2. These four units must include one unit of organic, one unit of biochemistry, and 1/3 unit each of physical (3000 level or higher) and inorganic chemistry (3000 level or higher).
3. These 1 2/3 units must include 1/3 unit of cell biology, 1/3 unit of genetics, and 2/3 unit of advanced work (3000 level or higher).
4. This unit must include a minimum of 1/3 unit in Chemistry and Biochemistry, and a minimum of 1/3 unit in Biology.
5. Any course in the natural sciences (not used to satisfy another requirement) or in computer science may be used to satisfy this requirement.

BIOLOGY and BIOTECHNOLOGY	Minimum Units
1. Mathematical Science, Physics, Computer Science, Engineering	2
2. Chemistry	5/3
3. BB 1000/2000-level	4/3
4. BB Laboratory Fundamentals (see Note 1)	1/3
5. Other Laboratory Experience (see Note 2)	2/3
6. BB 3000/4000-level (see Note 3)	5/3
7. Related Courses (see Note 4)	4/3
8. MQP	1

NOTES:

1. Chosen from among 1000- and 2000-level options, currently BB 2940 and BB 2950.
2. Chosen from among BB 3000/4000 Laboratories or from Laboratory Experience List for all Concentrations.
3. In certain cases, 500-level courses are appropriate for undergraduate credit with explicit permission of the Instructor.
4. Chosen from among the Related Courses Lists for all Concentrations.

BIOLOGY and BIOTECHNOLOGY WITH CONCENTRATION (See Note 1)	Minimum Units
1. Mathematical Science, Physics, Computer Science, Engineering	2
2. Chemistry	5/3
3. BB 1000/2000-level	4/3
4. BB Laboratory Fundamentals (see Note 2)	1/3
5. Other Laboratory Experience (see Note 3)	2/3
6. BB 3000/4000-level (see Note 4)	5/3
7. Related Courses (see Note 5)	4/3
8. MQP (see Note 6)	1

NOTES:

1. Students pursuing a Concentration must fulfill all requirements for that Concentration. Specific rules and course lists for each Concentration follow. No course may count in more than one category, including university and departmental distribution requirements.
2. Chosen from among 1000- and 2000-level options, currently BB 2940 and BB 2950.
3. Chosen from among BB 3000/4000 Laboratories or from Laboratory Experience List. Appropriate courses are suggested for each Concentration.
4. Of these 5/3 Units, 2/3 must come from the appropriate approved Concentration List. In certain cases 500-level courses are appropriate for undergraduate credit with explicit permission of the instructor.
5. Chosen from among courses specified within each concentration's Related Courses List.
6. Must be approved by the MQP advisor of record as appropriate for the Concentration.

BIOMEDICAL ENGINEERING	Minimum Units
1. Mathematics (See Note 1)	2
2. Basic Science (See Note 2)	2
3. Supplemental Science and Engineering (See Note 3)	2/3
4. Laboratory experience with living systems (See Note 4)	1/3
5. Biomedical Engineering and Engineering (See Note 5)	4 1/3
6. MQP (See Note 6)	1

NOTES:

1. Mathematics must include differential and integral calculus, differential equations and statistics.
2. Two courses from each of the following areas: BB, CH and PH.
3. Two courses from BB, CH or PH.
4. Experimental Physiology (BE 3110) or equivalent.
5. Thirteen courses from Biomedical Engineering (BE) or Engineering (CE, CM, EE, ES, or ME) with the following distribution: (1) seven courses from Biomedical Engineering or Engineering as specified in the WPI Catalog "Courses Qualifying for Engineering Department Areas", one of which must be an engineering design course; (2) four courses from Biomedical Engineering or Engineering at the 3000-level or above; (3) two courses in Biomedical Engineering at the 4000-level or above. A minimum of eight of the thirteen courses must be from Biomedical Engineering, not including BE 3110.
6. Must include 1/3 unit Capstone Design Experience.

CHEMICAL ENGINEERING	Minimum Units
1. Mathematics and Basic Science (Notes 1, 2).	4
2. Engineering Science and Design (Notes 3, 4).	6
3. Advanced Chemistry (Note 5).	2

NOTES:

1. Must include differential and integral calculus and differential equations.
2. Must include 2 courses in physics.
3. Must include 1 unit of MQP, 1/3 unit of capstone design experience (e.g., CM 4404), and at least 1/3 unit of engineering study outside the major. Courses used to satisfy this requirement must be at the 2000-level or above.
4. Must include at least 4 units from the following list of core chemical engineering courses: CM 2011, CM 2012, CM 2013, CM 2014, ES 3004, ES 3003, ES 3002, CM 3201, CM 3501, CM 4401, CM 4402, CM 4403, CM 4404, CM 4405.
5. All CH courses qualify except CH 1010, CH 1020, and CH 1030 which are basic science. Up to 1 unit of Advanced Chemistry may be double counted as both Advanced Chemistry and Basic Science. One course of Advanced Natural Science (2000 level and above BB, PH, GE) may be substituted for one Advanced Chemistry course.

CHEMISTRY	Minimum Units
1. Mathematics and Physics (Note 1).	2 1/3
2. Chemistry (Note 2).	4
3. Additional Science/Engineering (Note 3).	3 2/3

NOTES:

1. Must include differential and integral calculus and at least 2/3 units of physics.
2. Must be above the level of general chemistry (2000 level or higher). These 4 units must include courses in experimental chemistry (either 4/3 unit or 3/3 unit), inorganic chemistry (1/3 unit), organic chemistry (3/3 unit), physical chemistry (3/3 unit), and biochemistry (either 1/3 unit or 2/3 unit, depending on the number of experimental chemistry courses taken). At least 2/3 units must be at or higher than the 4000 level.
3. Distributed among the MQP, the natural and physical sciences, computer science, mathematics, and engineering (and including general chemistry, CH 1010-1040).

CIVIL ENGINEERING	Minimum Units
1. Mathematics and Basic Science (Notes 1,2).	4
2. Engineering Science and Design (including the MQP) (Notes 3,4,5,6).*	6

NOTES:

1. Mathematics must include differential and integral calculus and differential equations.
2. Must include both chemistry and physics with a minimum of two courses in either.
3. A minimum of 4 units of work must be within the Civil Engineering area. All CE courses including the MQP, ES 2503, and ES 3004 are acceptable within the Civil Engineering area.
4. The curriculum must include at least one engineering science course outside the major discipline area. Courses acceptable to satisfy the requirement of outside-of-discipline course are those taught in other engineering departments. The course must be a 2000-level or above and cannot include ES 2501, ES 2502, ES 2503, and ES 3004.
5. All students are required to include an appropriate laboratory experience as part of their overall program. This experience can be met by the completion of two undergraduate CE lab courses, selected from among the following: CE 2020, CE 3024, CE 3026, CE 3054, CE 4046, and CE 4060. Alternately, an appropriate laboratory experience could also be accomplished by a student through careful planning of course and laboratory work and approval by petition through the Department Program Review Committee.
6. Must include 1/3 unit of Capstone Design Experience.

COMPUTER SCIENCE	Minimum Units
1. Computer Science (including the MQP) (Notes 1, 2).	6
2. Mathematics (Notes 2, 3, 5).	7/3
3. Basic Science and/or Engineering Science (Notes 2, 4).	5/3

NOTES:

1. a. Only computer science courses at the 2000-level or higher will count towards the computer science requirement.
- b. Must include at least 1/3 unit from each of the following areas: Systems (CS 3013, CS 4513, CS 4514, CS 4515), Theory and Languages (CS 3133, CS 4123, CS 4533), Design (CS 3041, CS 3431, CS 3733, CS 4233), and Social Implications of Computing (CS 3043, SS 2208, SS/ID 2314). (If SS 2208 or SS/ID 2314 is used to satisfy this requirement, it does not count as part of the 6 units of CS.)
- c. At least 5/3 units of the Computer Science requirement must consist of 4000-level courses. These units can also be met by WPI graduate CS courses, with the exception of CS 501 and CS 507.
2. A cross-listed course may be counted toward only one of areas 1, 2, 3, above.
3. Must include at least 1/3 unit from each of the following areas: Probability (MA 2621, MA 2631) and Statistics (MA 2611, MA 2612).
4. Courses satisfying the science requirement must come from the BB, BE, CE, CH, CM, EE, ES, GE, ME, PH disciplines. At least three courses must come from BB, CH, GE, PH, where at least two courses are from one of these disciplines.
5. At most four 1000-level Mathematics courses may be counted towards this requirement.

COMPUTERS WITH APPLICATIONS	Minimum Units
1. Computer Science (including the MQP) (Notes 1, 2).	16/3
2. Mathematics (Note 2).	7/3
3. Basic Science (Notes 2, 3).	2/3
4. Application Area (Notes 2, 4).	5/3

NOTES:

1. a. Only computer science courses at the 2000-level or higher will count towards the computer science requirement.
- b. Must include at least 1/3 unit from each of the following areas: Systems (CS 3013, CS 4513, CS 4514, CS 4515), Theory and Languages (CS 3133, CS 4123, CS 4533), Design (CS 3041, CS 3431, CS 3733, CS 4233), and Social Implications of Computing (CS 3043, SS 2208). (If SS 2208 is used to satisfy this requirement, it does not count as part of the 16/3 units of CS.)
- c. At least 5/3 units of the Computer Science requirement must consist of 4000-level courses. These units can also be met by WPI graduate CS courses, with the exception of CS 501 and CS 507.
- d. The MQP must involve the application of computer science concepts to the Application Area specified in Requirement 4.
2. A cross-listed course may be counted toward only one of areas 1, 2, 3, 4 above.
3. The two courses satisfying the science requirement must both come from one of the following disciplines: BB, CH, GE, PH.
4. This requirement is satisfied by a cohesive set of work from disciplines other than Computer Science. Work used for any other degree requirements cannot be used for the Application Area. At least 3/3 units must be course work at the 3000 level or higher. Independent Study/Project (ISP) work, if any, must be conducted under the supervision of a member of the faculty in that discipline.

ECONOMICS	Minimum Units
1. Economics (Note 1).	3
2. Economics and/or Management (Note 2).	1
3. Other Social Science.	1
4. Mathematics (Note 3).	2
5. Basic Science.	1
6. Electives.	1
7. MQP.	1

NOTES:

1. Must include courses in both micro and macro economic theory at the intermediate level and in international trade and econometrics (available through the Consortium or independent study).
2. Must include financial accounting, MG 1100. May include other relevant management courses as approved by the Departmental Program Review Committee.
3. Must include differential equations, integral calculus, and statistics.

ECONOMICS and TECHNOLOGY	Minimum Units
1. Economics (Note 1).	3
2. Management (Note 2).	2/3
3. Other Social Science.	1
4. Basic Science.	2/3
5. Mathematics (Note 3).	5/3
6. Technical Electives (Note 4).	2
7. MQP (Note 5).	1

NOTES:

1. (a) Must include econometrics, systems analysis, industrial organization and intermediate level microeconomic and macroeconomic theory.
- (b) Must include (1) two courses in environmental economics, the economics of the medical care industry or advanced systems analysis or (2) two courses in fiscal and monetary economics.
2. Must include financial accounting and either financial management or engineering economics.
3. Must include statistics, and differential and integral calculus.
4. Courses must be in science or engineering with a concentration in one discipline.
5. The MQP may be in Economics or in the student's technical field with the approval of the academic advisor and the departmental Program Review Committee.

ELECTRICAL ENGINEERING	Minimum Units
1. Mathematics and Basic Science (Notes 1, 2, 3, 4).	4
2. Engineering Science and Design (ES/D) (including the MQP) (Notes 5, 6, 7).	6

NOTES:

- Basic Science courses have prefixes PH, CH, BB, and GE.
- Mathematics must include differential and integral calculus and differential equations.
- Must include at least 1/3 chemistry and 2/3 physics or 2/3 chemistry and 1/3 physics.
- Must include at least 7/3 units of math.
- The six units of Engineering Science and Design must include at least two courses outside the major area and may include as many as three. All three courses must be at the 2000-level or above. One course requirement must be satisfied by ME 3601 or any course with prefix ES (other than ES 3011). The second course must have the prefix CS (other than CS 2011, CS 2022, CS 3043). If a third course is chosen that does not have the prefix EE, it must be selected from courses having the prefix BE, CE, CM, CS, (other than CS 2011, CS 2022, CS 3043), ES, FP, or ME.
- Must include at least 5 units within the Electrical and Computer Engineering area (including the MQP). All courses designated EE (except EE 3601) are applicable to these 5 units. Also, courses ES 3011, BE 4011, and BE 4201 are applicable to these 5 units.
- Must include 1/3 unit of Capstone Design Experience.
These distribution requirements in Electrical Engineering apply to all students matriculating at WPI after May, 2003. Students who matriculated prior to May, 2003, have the option of satisfying the distribution requirements in the catalog current at the time of their matriculation.

ELECTRICAL AND COMPUTER ENGINEERING	Minimum Units
1. Mathematics and Basic Science (Notes 1a-1d).	4
2. Engineering Science and Design (ES/D) (including the MQP) (Notes 2a-2g).	6

NOTES:

- Mathematics and Basic Science:
 - Must include at least 7/3 units of math (prefix MA). Mathematics must include differential and integral calculus, differential equations, and probability and/or statistics.
 - Must include at least 2/3 units of physics (prefix PH).
 - Must include at least 1/3 units of chemistry (prefix CH) or 1/3 units biology (prefix BB).
 - Must include an additional 2/3 units of math or basic science (prefixes MA, PH, CH, BB, or GE)
- Engineering Science and Design (including the MQP):
 - Must include at least 5 units within the Electrical and Computer Engineering area (including the MQP). All courses with prefix EE (except EE 3601) are applicable to these 5 units. Also, courses ES 3011, BE 4011, and BE 4201 are applicable to these 5 units.
 - The 5 units within the Electrical and Computer Engineering area must include at least 1 unit of courses from an approved list of Electrical Engineering courses (listed in the Electrical and Computer Engineering Department and Program Description section of this catalog)

2c. The 5 units within the Electrical and Computer Engineering area must include at least 2/3 unit of courses from an approved list of Computer Engineering courses (listed in the Electrical and Computer Engineering Department and Program Description section of this catalog)

2d. The 5 units within the Electrical and Computer Engineering area must include 1/3 unit of Capstone Design Experience. (This requirement is typically fulfilled by the MQP.)

2e. Must include at least 1/3 unit of computer science (prefix CS), at the 2000 level or above (other than CS 2011, CS 2022, CS 3043 which cannot be applied to this requirement).

2f. Must include at least 1/3 unit of engineering science (prefix ES) at the 2000 level or above. This requirement may also be satisfied by ME 3601. ES 3011 cannot be applied to this requirement.

2g. Must include an additional 1/3 unit of engineering science and design at the 2000 level or above, selected from courses having the prefix BE, CE, CM, CS (other than CS 2011, CS 2022, CS 3043), EE, ES, FP, or ME.

ENVIRONMENTAL POLICY AND DEVELOPMENT	Minimum Units (Note 1)
1. SS & PS (Note 2).	12/3
2. Mathematics (Note 3).	5/3
3. Basic Science (Note 4).	2/3
4. Technical Concentration (Note 5).	2
5. Department Electives (Note 6).	2/3
6. MQP.	1

NOTES:

- 1/3 unit = 1 course. 15 units are required for graduation.
- Students must complete 5/3 units (5 courses) in *one* of three social science areas: (a) economics, (b) psychology/sociology, (c) political science (includes SS & PS courses in law and policy analysis) and 2/3 unit (2 courses) in *each* of the other two social science areas. The particular courses chosen must include six out of the following nine courses: A Psychological Perspective on Environmental Problem Solving, American Public Policy, Development Economics, Environmental Economics, International Environmental Policy, Introduction to Economic Systems, Legal Regulation of the Environment, Technical Expertise in Governmental Decision Making, and the Society-Technology Debate. Students must also complete three other social science courses (1 unit) of their choosing.
- Must include both calculus and statistics.
- Basic science courses must be selected from the disciplines of Physics, Chemistry, or Biology.
- The technical concentration must include at least six thematically related courses in science, engineering or management that have been approved by the Department's Program Review Committee.
- Departmental electives must be selected from the areas of mathematics, basic science, social science, or the technical concentration.

32 MINIMUM DISTRIBUTION REQUIREMENTS FOR STUDENTS

HUMANITIES AND ARTS	Minimum Units
1. Humanities and Arts (including MQP) (Note 1).	6
2. Electives (Note 2).	4

NOTES:

- Humanities and Arts majors may choose to complete 2 units of work and an MQP in one of the following areas of Concentration: History, Literature, Music, Philosophy, Religion, Drama/Theatre, Writing and Rhetoric, Art History/Architecture, German Studies, Hispanic Studies, American Studies, Environmental Studies, or Humanities Studies of Science and Technology.
- May be from any area except Aerospace Studies, Military Science, or Physical Education. Courses used to satisfy other degree requirements (i.e. the IQP and the Sufficiency) may not be used to fulfill this requirement.

DOUBLE MAJOR IN HUMANITIES AND ARTS

Students may pursue a double major in Humanities and Arts and in an area of science, engineering, or management. To pursue the double major, a student must satisfy all of the degree requirements of the technical discipline including an MQP and Distribution Requirements. In addition, the double major in Humanities and Arts requires 6 units of studies in the Humanities and Arts, including the MQP. Students pursuing a double major in Humanities and Arts are not required to complete a Sufficiency Program in Humanities and Arts, nor are they required to complete a second IQP. Students interested in pursuing this option should contact Prof. B. Addison, 39 Dean St., Room 260, for additional information.

INDUSTRIAL ENGINEERING (Management Department)	Minimum Units
1. Mathematics and Basic Science (Notes 1, 2)	4
2. Industrial Engineering Topics (including the MQP) (Notes 3, 4)	6

NOTES:

- Mathematics must include differential and integral calculus, ordinary differential equations, and 2/3 units in probability and statistics.
- Basic Science must include both chemistry and physics, with a minimum of two courses in either.
- Must include 1/3 unit of Capstone Design Experience.
- Industrial Engineering Topics must include courses in the following three topic areas.
 - 3 units of industrial engineering core courses, including 1/3 unit in each of the following 9 areas: engineering basics outside industrial engineering, deterministic operations research methods, process design, production planning and control, simulation, stochastic methods in operations research, information systems design, financial modeling and organizational science.
 - 1 unit in Industrial Engineering electives. 3000/4000 level MG/IE courses and Operations Research courses in Mathematics qualify with the exception of courses in financial modeling and organizational science.
 - 1 unit in technical electives. Industrial Engineering electives and any other Engineering Science/Design courses qualify.

INTERDISCIPLINARY

By individual arrangement; see pages 118-119.

INTERNATIONAL STUDIES	Minimum Units
1. International Core (Note 1)	1
2. International Fields (Note 2)	4
3. International Experience (Note 3)	0
4. Electives (Note 4)	4
5. MQP	1

NOTES:

- International Core: One course must be selected from each of these categories:
 - An introductory course in international history, such as HI 1341 or HI 1313, HI 1321, HI 1322, HI 1323.
 - A course in understanding cross-cultural differences, such as one of the following: HU 3411 Pro-Seminar in Global Perspectives, or SS 2406 Cross-Cultural Psychology; or SS 1202 Sociological Concepts and Comparative Analysis; or PY 2716 Philosophy of Difference.
 - HU 4411 Senior Seminar in International Studies.
- International Fields: Majors complete at least one unit of work in each of the following areas. They must also complete at least one additional unit of work in one of these areas, which will be considered their primary field.
 - Historical Analysis. These include any courses in European history, world history, or American foreign policy.
 - Language, Literature, and Culture. These include any course in foreign languages, civilization, and literature offered at WPI or in the Consortium with the prior approval of the Program Review Committee; also courses approved by the Program Review Committee in Art History (e.g. AR 1111, AR 2111), English Literature (e.g. EN 2243, EN 3222), Music History (e.g. MU 2615), or Philosophy and Religion (e.g. RE 2721, RE 2724). Majors who designate Language, Literature, and Culture (LLC) as their primary field may not take courses in a second foreign language unless they have achieved 3000-level proficiency in the first. LLC designees should take most of their courses in a single discipline or in a coherent program approved by the Program Review Committee.
 - Social Sciences. These include international courses in the social sciences (e.g. SS 1320, SS 2105, SS 2125, SS 2312, SS 2406). Students may count courses taken for the two-course requirement in Social Sciences.
- International Studies majors are required to have a study-abroad experience. (In very unusual cases, exceptions may be made to this requirement, but only with prior approval of the Director and Program Review Committee). This abroad experience may take the form of a project, exchange, or internship approved by the Program Review Committee. The study-abroad experience should be educational in nature and equivalent in length to at least one WPI term.
- Electives may be from any area except Aerospace Studies, Military Science or Physical Education. Double-majors may count as electives courses taken for their other major. Majors who are not completing a double-major are required to complete a two-unit technical sufficiency in an area of science, engineering, or mathematics apart from these electives.

MANAGEMENT	Minimum Units
1. Management Foundation (Note 1)	11/3
2. Mathematics (Note 2)	4/3
3. Basic Science	2/3
4. Management Major (Note 3)	6/3
5. Management Electives (Note 4)	3/3
6. Computer Science	1/3
7. MQP (Note 5)	3/3

NOTES:

- The Management Foundation must cover the foundation knowledge in the Management functional areas, including at least 1/3 unit of Financial Accounting, Managerial Accounting, Financial Management, Organizational Science, Deterministic Management Science, Operations Management, Marketing Management, Information Systems Management, Microeconomics, Macroeconomics, and Business Law and Ethics.
- Mathematics must include 2/3 units of calculus and 2/3 units of statistics.
- The Management Majors (other than IE) must comprise a department-approved integrated set of courses covering a specific area of: Management, Science, Engineering or Mathematics for MGE; Computer Science or Information Systems for MIS; Management, Social Sciences, or Humanities for MG.
- Management electives must include at least 1/3 unit of 3000/4000 level MG courses. The remaining 2/3 units specified in the requirement may be satisfied with courses from Mathematics, Basic Science, Computer Science, Management, or Social Science, but excluding courses MG 1250, and MG/IE 2850.
- Courses may not be counted more than once in meeting the departmental distribution requirements. The total number of MG (and/or MG/IE) units may not exceed 50% of the total number of units earned for the degree.

MANUFACTURING ENGINEERING	Minimum Units
1. Mathematics and Basic Science (Notes 1,2).	4
2. Engineering Science and Design (including the MQP) (Note 3,4).	6

NOTES:

- Mathematics must include differential and integral calculus and differential equations.
- Science must include both chemistry and physics with a minimum of two courses in either.
- At least one unit from each of the following areas is required:
 - Materials and Processes
 - Product Engineering and Tool Design
 - Computer Control and Manufacturing Systems
 - Production Systems Engineering
- Must include 1/3 unit of Capstone Design Experience.

MATHEMATICAL SCIENCE	Minimum Units
1. Mathematics including MQP (See notes 1-4).	7
2. Courses from other departments that are related to the student's mathematical program. At least 2/3 unit in computer science must be included; the remaining courses are to be selected from science, engineering, computer science or management (except MG 1250) (see Note 5).	2
3. Additional courses or independent studies (except MS, PE courses, and other degree requirements) from any area.	1

NOTES:

- Must include MA 3831-3832, or their equivalents, at least one of MA 3257, MA 3457, or equivalent, and at least one of MA 3823, MA 3825, or equivalent.
- Must include at least three of the following: MA 2073, MA 2271, MA 2273, MA 2431, MA 2631, or their equivalents.
- At least 7/3 units must consist of MA courses at the 3000 level or above.
- May not include both MA 2631 and MA 2621.
- May not include both CS 3043 and CS 2022.

MECHANICAL ENGINEERING	Minimum Units
1. Mathematics and Basic Science (Notes 1, 2, 3).	4
2. Engineering Science and Design (includes MQP) (Notes 3, 4, 5, 6, 7, 8, 9).	6

NOTES:

- Must include a minimum of 5/3 units of mathematics, including differential and integral calculus and differential equations.
- Must include a minimum of 1/3 unit in chemistry and 2/3 unit in physics, or 1/3 unit in physics and 2/3 unit in chemistry.
- Must include an activity that involves basic matrix algebra and the solution of systems of linear equations, and an activity that involves data analysis and applied statistical methods.
- Must include 1/3 unit in each of the following: electrical engineering, materials science, and mechanical engineering experimentation.
- Must include at least one unit of ME courses at the 4000-level.
- May include 1000 level courses only if designated ES or ME.
- Must include two stems of coherent course and/or project offerings as noted below in a and b.
 - A minimum of one unit of work in thermofluid systems that includes the topics of thermodynamics, fluid mechanics and heat transfer, plus an activity that integrates thermofluid design.
 - A minimum of one unit of work in mechanical systems that includes the topics of statics, dynamics, and stress analysis, plus an activity that integrates mechanical design.
- Must include an activity which realizes (constructs) a device or system.
- Must include 1/3 unit of Capstone Design Experience. Items 3, 5, 7a integration, 7b integration, 8, 9 may all be "multiple-counted."

PHYSICS	Minimum Units
1. Mathematics (Note 1).	3
2. Physics (including the MQP; can include ES 3001) (Note 2).	5
3. Other subjects to be selected from mathematics, science, engineering, computer science, and management (Note 2).	2

NOTES:

1. Mathematics must include at least 2/3 unit of mathematics at the MA 3000-level or higher.
2. Either item 2 or 3 must include 1/3 unit of PH 2651, or other laboratory course approved by the department Program Review Committee following petition by the student.

ENGINEERING PHYSICS

1. Same requirements as PHYSICS, with the addition that the 10 units must include 2 units of coordinated engineering and other technical/scientific activities. The 2-unit program must be formulated prior to final year of study by the student in consultation with the academic advisor, and must be certified prior to the final year by the departmental Program Review Committee.

These distribution requirements *in physics* apply to all students matriculating at WPI after May, 2003. Students who matriculated prior to May, 2003, have the option of satisfying the degree requirements in the catalog current at the time of their matriculation.

SOCIETY, TECHNOLOGY and POLICY	Minimum Units
1. Social Science (Notes 1, 2).	4
2. Minimum Basic Science background.	2/3
3. Minimum Mathematics background (Note 3).	1
4. Technical concentration (Note 4).	5/3
5. Electives (Note 5).	5/3
6. MQP	1

NOTES:

1. Students must obtain approval of their proposed program from the Departmental Program Review Committee. Course distribution will focus on a disciplinary specialty and either policy analysis or a society-technology specialization such as Social Impact Analysis or Technology Assessment.
2. Relevant Humanities and Arts or Management courses approved by the Departmental Review Committee may be counted for a maximum of 2/3 of a unit in fulfilling the 4-unit requirement.
3. One course in calculus-based statistics is required.
4. A series of courses in one field of science, engineering, or management or a combination of courses approved by the Departmental Review Committee which focus on issues to be developed in the MQP.
5. These courses are to be approved by the Departmental Review Committee and are meant to broaden the technical concentration and tie it to social concerns.

SYSTEM DYNAMICS	Minimum Units
1. System Dynamics (Note 1)	5/3
2. Other Social Science (Note 2)	5/3
3. Management (Note 3)	2/3
4. Mathematics/basic sciences/engineering (Note 4)	8/3
5. Computer Science (Note 5)	2/3
6. Application Area (Note 6)	5/3
7. MQP	1

NOTES:

1. Only social science courses with a "5" in the second digit of the course number count toward the system dynamics requirement.
2. Must include microeconomics or macroeconomics, cognitive or social psychology, and public policy.
3. Must include organizational science.
4. Must include differential and integral calculus, differential equations, and numerical analysis or statistical analysis.
5. CS 1005 and CS 2005 are recommended.
6. This requirement is satisfied by a cohesive set of work from the fields of social science, management, science, mathematics, computer science, or engineering as specified in the curriculum the guidelines for system dynamics major.

TECHNICAL, SCIENTIFIC, AND PROFESSIONAL COMMUNICATION

	Minimum Units
1. Scientific and/or technical concentration (Note 1)	6
2. Writing and Rhetoric concentration (Note 2)	3
3. MQP	1

NOTES:

1. The student's scientific and/or technical concentration must be a plan of study, approved by the student's program review committee, with a clear underlying rationale in mathematics, basic science, computer science, engineering, and/or management.
2. The Writing and Rhetoric concentration consists of 1 unit in each of the 3 following categories of courses. Courses taken to fulfill these distribution requirements will not include courses that fulfill other degree requirements, such as the Humanities and Arts Sufficiency and the Social Sciences requirement. Exceptions to this restriction, not to exceed 1 unit, must be approved by the student's program review committee, and will be granted only under unusual circumstances.

A. Written communication (1 unit)

Recommended courses:

- EN/WR 2211 Elements of Writing
- EN/WR 3011 Peer Tutoring in Writing
- EN/WR 3214 Writing About Disease and Public Health
- EN/WR 3216 Writing in the Professions or equivalent writing courses or ISPs

B. Rhetoric and communication studies (1 unit)

Recommended courses:

- RH 3111 The Study of Writing
- RH 3112 Rhetorical Theory
- RH 3211 Rhetoric of Visual Design or ISP or any of the courses listed in Category A not used to fulfill that requirement.

C. Electives (1 unit)

The 1 unit of electives must be coherently defined and approved by the student's program review committee. Students may draw on:

Courses in science, technology, and culture studies (such as AR/ID 3150, CS 3041, CS 3043, EN 2252, EN 3235, HI 2331, HI 2332, HI 2333, HI 2334, HI 3331, SS 2207, SS 2208, or SS 2302);

Philosophy and ethics courses (such as PY 2711, PY 2713, PY 2714, PY 2716, PY 2717, PY/RE 2731, PY/RE 3731);

Foreign language courses;

Management courses.

COURSES QUALIFYING FOR ENGINEERING DISTRIBUTION AREAS

Mathematics

All Courses designated "MA."

Advanced placement established by AP exam or through passing WPI advanced courses (see page 246) also qualify.

Basic Science

All courses designated "PH," "CH," "BB," and GE 2341.

Engineering Science/Design

The following courses may be applied to the "Engineering Science and Design" distribution requirement for each respective engineering major:

BE: All courses designated "BE" (except BE 3110) and CE, CM, ECE, and ME courses at the 2000-level or above.

CE: All courses designated "CE" except part of CE 4024.* Also ES 2503 and ES 3004.

CM: All courses designated "CM." Also ES 3002, ES 3003, ES 3004, and other courses approved by the Chemical Engineering Department. See page 79, and consult with your academic advisor for details.

EE: All courses designated "EE" except EE 3601. Also ES 3011, BE 4011, and BE 4201 may be included in the six-unit EE area distribution requirement.

ECE: All courses designated "EE" except EE 3601. Also ES 3011, BE 4011, and BE 4201 may be included in the six-unit ECE area distribution requirement.

ME: All courses designated "ME" except ME 3601.

IE: MG/IE courses including MG/IE 2500, MG/IE 3401, MG/IE 3405, MG/IE 3420, MG/IE 3450, MG/IE 3501, MG/IE 3460, MG/IE 4410, and MG/IE 4460.

In addition, engineering majors selecting "Engineering Science/Design" courses from *outside* their major may choose appropriate activities from any of the following:

All courses designated ES, EE, CM, ME.

All MG/IE courses listed above (for ME majors only).

All courses designated as CE except CE 3022 and part of CE 4024.

All courses designated as CS except CS 1001, CS 1005, and CS 3043.

(Electrical Engineering majors are restricted to these courses at the 2000-level or higher.)

All ABET engineering programs require six units of Engineering Science and Design.

All graduate-level courses may be counted in the appropriate categories.

*Information on the estimated "Engineering Science" or "Design" content of courses is available through your advisor and in engineering department offices.

PROJECTS

Project activity is an integral part of the educational experience for all students under the WPI Plan. The two types of qualifying projects are:

1. A project in the major field of study (the Major Qualifying Project, or MQP).
2. A project which relates technology and science to society or human needs (the Interactive Qualifying Project, or IQP).

Projects should be chosen in consultation with the student's academic advisor and must be accepted by a project advisor before project registration can be completed. Many project opportunities come from off-campus organizations, and provide challenges to solve real-world problems and thus gain experience invaluable for seeking jobs and for professional practice. Students are encouraged to develop their own projects, to solicit support for their ideas from potentially interested faculty, and to form teams to pool resources and share points of view.

The Major Qualifying Project should focus on the synthesis of all previous study to solve problems or perform tasks in the major field with confidence, and communicate the results effectively.

The Interactive Qualifying Project should challenge students to relate social needs or concerns to specific issues raised by technological developments.

PAY AND CREDIT

The WPI Faculty approved the following project policies in 1973:

1. A student may receive pay for related work that is above and beyond the work clearly defined for academic credit for a project.
2. Wherever possible remuneration for this extra work will be paid by WPI to the student from funds directly obtained through grants from the company to the college.
3. Results obtained from paid or unpaid work performed while students are not registered for project credit at WPI may be used in projects only after consultation with the project advisor. When possible such consultation should take place before the work begins.
4. Students who wish to pursue project work off-campus for WPI credit can do so only if 1) they are registered for that term at WPI, 2) their project advisors have established appropriate methods of supervising the off-campus work. Such supervision must make adequate provision for periodic review and advising.

RESOURCES - GETTING STARTED

Students are encouraged to avail themselves of the many resources and advice areas found in the Projects Program web page (www.wpi.edu/Academics/Projects).

In addition, personal advice can be provided by meeting with the Projects Administrator (Projects & Registrar's Office—Boynton Hall) or the project coordinators listed on pages 230-232.

AVAILABLE PROJECTS

Students may obtain information about new or ongoing projects from a variety of sources. Principal sources include discussions with other students, especially those currently involved in a project, the Projects Program web site, department offices, or their web pages. Off-campus projects are discussed annually in the fall. In the spring, "Available Projects" on the Projects Program web site can be used as a directory of specific projects or as a source of ideas for developing your own projects. Some students will find a project listed which fits their needs and interests exactly. In other cases, the listing will serve to lead students to a faculty member with whom project involvement can be negotiated. The proposals in the Projects Program web page are updated periodically to provide an accurate listing of available projects.

PROJECT ADVISOR

Academic advisors can assist students in identifying a project. They are aware of the project interests of many other faculty members, and have a list of faculty interests which will enable a student to find a faculty member who can help to develop a project idea. Faculty associated with the Interdisciplinary and Global Studies Division (IGSD) are available to assist students in interdisciplinary and interactive projects. The Projects & Registrar's Office can also assist in finding an appropriate project advisor. See pages 230-232.

PROJECT PERFORMANCE

A student is normally expected to expend 15-17 hours per week on the average for each 1/3 unit of credit for project work, and expected achievement is based upon that commitment.

A project group, whether it involves one student or more, should have a minimum of one scheduled conference per week with the advisor(s). Additional time should be scheduled when the effort exceeds 1/3 unit per student or when more students are involved.

Students should be prepared to submit written project reports to the advisor each week. Students are also encouraged to complete a proposal at the beginning of the project activity to define the scope and timeline for completion of the effort. In addition, oral reports may be required as determined by the advisor. At the end of the project, a report must be prepared to the satisfaction of the project advisor. For projects sponsored by off-campus organizations, both a written and oral report for the sponsors is normally expected. Written qualifying project reports go on file in Gordon Library for a period of five years.

QUALIFYING PROJECT DOCUMENTATION

In completing the qualifying project degree requirement, students must submit to their project advisors a final document of record. It is expected that the qualifying project documentation will, in most cases, consist of a written report only. In some cases, however, the project documentation may include, in addition to the written report, material in another medium or form, such as software, a video tape, a CD-Rom, or a publication. It is reasonable to expect that the scope of the written report in such instances may be narrower than would be the case if the documentation were by written report only; for example, the objective of a project might be the preparation of a videotape to serve a special purpose, meet a specified need, record a singular event, etc. At the very least, however, the written report portion of the project documentation should provide the reader with a history of the student's involvement with the project, its aims and objectives, its rationale, the role played in the project by the material in the other medium, and the conclusions reached and recommendations framed by the student. All additional forms of documentation must also be submitted with the written report.

FINAL REPORT PROCEDURES

The student will submit the project documentation (the original copy of the written report plus any additional documentary material) to the project advisor. The deadline for the submission of the initial report draft and the final document may be established at the discretion of the project advisor. Drafts and reports need *not* be accepted by the advisor after the established deadline.

The qualifying project advisor will fill out the "Completion of Degree Requirement" form and forward both the form and the project documentation to the Registrar. The Registrar will record the completion of the degree requirement and the evaluation grade only if the project documentation accompanies the form. Otherwise, the Registrar will return the form to the initiator. In the case of a group project report, a separate completion form must be submitted for each student.

The student is responsible for the cost of preparing only the original copy of the written report. The cost of additional copies will be borne by the individual or organization desiring them. It is highly recommended that each student retain a copy of their project for future reference.

GROUP QUALIFYING PROJECT EFFORTS

Students meeting a qualifying project degree requirement by participation in a group, or team effort, will submit, at the discretion of the project advisor, either a single, comprehensive written report from the group, or individual written reports from each member of the group. A single, comprehensive written report must, however, include some means by which each individual's contribution to the group effort may be clearly identified. This identification may take the form of an "authorship page," simply a

list of individual chapters and their respective authors, or of a prefacing statement in which each contributing group member is named as having carried out one or more specific tasks within the overall project effort.

In the case where one or more students leave an ongoing group project after having contributed at least one unit each of project effort, those students, again at the discretion of the project advisor, will submit either a single written report or individual written reports in satisfying the qualifying project documentation requirement. The same means of identifying individual contributions will be employed as described above.

CENTER FOR COMMUNICATION ACROSS THE CURRICULUM

(Upper Level; Project Center)

Accompanying strong emphasis on project work at WPI is strong emphasis on high quality presentation of materials such as proposals, written reports, term papers, and abstracts describing the project work. To assist you in developing your writing and oral presentation skills, WPI has established a Center for Communication Across the Curriculum that offers writing and presentation consultations, style guidelines, writing manuals and presentation videotapes. Style guidelines, writing manuals and spe-

cially prepared handouts concerned with report writing are available. Small group or individual conferences scheduled by appointment with the writing consultants constitute an additional service provided by the Center to help students with their writing skills. For further information, contact the Humanities and Arts Department or IGSD.

DISSEMINATION OF PROJECT REPORTS

MQPs and IQPs completed for off-campus agencies are usually distributed within the sponsoring agency by the agency project liaison. MQP and IQP reports are catalogued for reference in the Gordon Library for five years after being submitted to the faculty advisor. After that period, they are returned to the faculty advisor(s).

Students thus must be responsible for keeping personal copies of project reports for their own permanent professional records. WPI strongly encourages students to prepare MQP and IQP reports in electronic (CD or floppy disk) as well as hard copy formats. In this way, reports can be reviewed for later use by students, and incorporated into a professional portfolio.

Thus, MQPs and IQPs are best viewed as research reports which establish good professional practices as well as being potential sources for further study and research.

PROJECTS PROGRAM

Project opportunities have been established at industrial, institutional, and governmental organizations. Projects are available in nearly all disciplines. Announcements of off-campus project opportunities are made annually in February.

Students work on problems at the off-campus site in cooperation with site personnel and under the overall supervision of WPI faculty. The WPI project centers feature programs *specifically* chosen for the *educational* merit and close relationship to the student's interest.

Students may participate on a full-time basis. Only students who have demonstrated by acceptable work at WPI the necessary aptitude and sense of responsibility will be approved for study at a center. Students and advisors interested in off-campus project opportunities should contact the Projects Office for further information.

OFF-CAMPUS INSURANCE AND LEGAL AGREEMENTS

WPI's insurance program includes a broad range of coverage for students doing projects in cooperation with off-campus organizations. This insurance coverage requires proper documentation of individual student participation. All students doing project work with off-campus organizations must complete the pertinent portion of the project registration form. In certain cases, where the project is included as part of a regular course, the course instructor must submit to the Projects Office a list of the students going off campus and the name(s) and address(es) of the organization(s) involved.

WPI has entered into a variety of agreements with off-campus organizations, covering a wide range of issues common to the projects program. Students agree to abide by these agreements during the registration for the project.

PROJECT CENTERS

Each Project Center has a WPI faculty member as the director, well-defined procedures for completing project work, and selective admissions processes. The Centers tend to be highly structured and require superior performance.

At the present time, the WPI project centers close to campus are:

- Advanced Aeronautics Design.
- General Electric Project Center.
- Gillette Company Project Center.
- UMass Memorial Health Care, University of Massachusetts Medical Center, and Tufts School of Veterinary Medicine Project Centers.
- Worcester Community Project Center.

See also page 47 for residential Project Centers at a distance from WPI.

AEROSPACE PROJECTS PROGRAM

The Aerospace Projects Program provides project opportunities, resources and organization for students interested in Aeronautics and Astronautics. Projects cover diverse areas in Aeronautics and Astronautics and are conducted in the research laboratories of the Mechanical Engineering Department, as well as at NASA Glenn Research Center in Cleveland and the Jet Propulsion Laboratory in Pasadena. Students apply in February for MQPs and IQPs that are announced by the Aerospace faculty. These projects are supported by NASA's Massachusetts Space Grant Consortium, the research programs of the Aerospace faculty and the Mechanical Engineering Department. MQPs are often conducted in collaboration with graduate students. Students completing MQPs are encouraged to present their work in the annual AIAA Northeast Student Conference.

Aeronautics

These project opportunities are for students interested in aircraft and/or aircraft systems design. Central activity in these projects is the design, construction, and testing of remotely piloted aircraft and micro aerial vehicles. Other projects may include topics in aerodynamics, controls, wake flows, gas dynamics, and combustion.

Astronautics

These project opportunities are for students interested in space science and engineering. Topics include electric propulsion and micro-propulsion, design of micro-gravity experiments for the International Space Station, and the design of a shuttle experiment.

Students interested in exploring opportunities should contact the Aerospace Program Director, Professor Nikos A. Gatsonis, gatsonis@wpi.edu.

GENERAL ELECTRIC (GE) COMPANY PROJECT CENTER

General Electric (GE) is a company of diverse businesses, including aircraft engines, financial services, consumer products, industrial systems, and medical systems.

Projects at GE offer students an opportunity to work with a company focusing on leadership. Many major qualifying project opportunities are available, principally in industrial, management, mechanical, and manufacturing engineering as well as management information systems. Projects can range from tooling design, to lean production system design, to the development of information systems to support decision-making. Projects are available in different terms and at different locations. Those interested in exploring project opportunities at GE should contact Professor Sharon Johnson (Industrial Engineering, Management Engineering), Professor Diane Strong (Management Information Systems), and Professor Kevin Rong (Manufacturing, Mechanical Engineering).

GILLETTE COMPANY PROJECT CENTER

Gillette is the world leader in grooming products. Their South Boston Manufacturing Center (SBMC) is their primary location for the manufacture of shaving systems such as the Mach 3 and Venus razors, where over a billion units are produced each year. Many major qualifying project opportunities are available, principally in mechanical and manufacturing engineering. Projects can range from the design of equipment for automated production systems to the analysis and modeling of the kinematics, dynamics, and vibrations of existing systems. Students who do these projects will have the opportunity to solve real engineering problems, interact with professional engineers at one of the most automated assembly facilities in the world, and demonstrate their presentation skills. Those interested in exploring project opportunities at Gillette should contact Professor Robert L. Norton, Mechanical Engineering Department.

UMASS MEMORIAL HEALTH CARE/UNIVERSITY OF MASSACHUSETTS MEDICAL SCHOOL/ TUFTS UNIVERSITY SCHOOL OF VETERINARY MEDICINE PROJECT CENTERS

Biomedical projects (MQP, IQP, PQP, and thesis) are available at UMass Memorial Health Care, University of Massachusetts Medical School (UMMS), and Tufts University School of Veterinary Medicine (TUSVM) for students from all disciplines on campus. Each of these centers is located close to WPI.

It is recommended that students spread their projects over the entire academic year. However, in some cases, full-time activity for a term can be accommodated. Students interested in project opportunities should contact the Biomedical Engineering Department Projects Faculty Coordinator well in advance of their planned project activity.

The qualifying project in the major field of study should demonstrate application of the skills, methods, and knowledge of the discipline to the solution of a problem that would be representative of the type to be encountered in one's career. The project's content area should be carefully selected to complement the student's total educational program. In defining the project area within which a specific topic is to be selected, the student and academic advisor should pay particular attention to the interrelationships that will exist between the bodies of knowledge represented by courses, independent studies, and Preliminary Qualifying Projects; and by the Interactive Qualifying Projects.

MQP activities encompass research, development, and application, involve analysis or synthesis, are experimental or theoretical, emphasize a particular subarea of the major, or combine aspects of several subareas. In many cases, especially in engineering, MQP's involve capstone design activity. Long before final selection of a project topic, serious thought should be given as to which of these types of activities are to be included. Beyond these considerations, the MQP can also be viewed as an opportunity to publish, to gain experience in the business or public sectors, or to utilize special facilities like those listed on pages 8 through 16.

Off-campus MQPs are also very valuable for access to state-of-the-art resources and contacts for future professional work.

GETTING STARTED ON AN MQP

Project topics are originated by students, faculty, or practicing professionals participating in WPI's off-campus project programs. A faculty member in each academic department acts as Project Coordinator for all majors within the department. The Project Coordinator has assembled MQP topic descriptions being proposed and has identified the faculty who will serve as project advisors for each topic. This information can also be reviewed in the reference section of Gordon Library and the Projects Office. Students can also seek the guidance of the Department Project Coordinator or the listed project advisor directly. All project opportunities—MQP, IQP, PQP, on-campus originated and off-campus originated—are made available to the student body through a planned information-sharing program of activities during C and D terms of the academic year prior to the start of the project.

Students should also consult the WPI home page for "WPI Faculty Research and IQP Interests" to determine areas of research interest where students may find opportunities for MQPs. Faculty research thus may lead indirectly to sponsorship of MQPs.

PROJECT PROPOSALS

Students are strongly encouraged to begin their MQPs with a project proposal. A detailed guide to preparing project proposals is available in department offices or on the Projects Program web page.

THE INTERACTIVE QUALIFYING PROJECT

The Interactive Qualifying Project (IQP) challenges students to identify, investigate, and report on a self-selected topic examining how science or technology interacts with societal structures and values. The objective of the IQP is to enable WPI graduates to understand, as citizens and as professionals, how their careers will affect the larger society of which they are part.

The interactive project is a broad and integrative educational experience. The procedure employed to relate the scientific or technological component to a social issue often arises from students' formal work in the social sciences or humanities. The scientific or technological component is not limited to students' major fields, though students can draw upon their own majors in choosing an IQP topic. The IQP provides unique opportunities in engineering education for significant international education and pre-professional experience. (See Residential Project Centers, page 47)

PREPARING FOR THE IQP

While the preparation of most students for the Major Qualifying Project (MQP) involves extensive studies in technology, preparing for the IQP emphasizes the development of an understanding of the concepts and analytical techniques of the social sciences. The social science courses taken to satisfy the 2/3-unit social science requirement should be chosen to support IQP preparation (as explained on pages 163-165). In some cases, this background will include the study of other disciplines relevant

to particular IQP topics. Preparation guidelines are included in the respective IQP division descriptions which follow, pages 40-46.

Students should begin preparing for their IQPs during their first two years at WPI; most of this preparation should be completed prior to work on the project itself. Be sure to discuss IQP opportunities with your first-year advisor. In preparing for specific IQPs, you can seek the assistance of the IQP division coordinators indicated on the following pages by the divisions below.

RESOURCES

To help students decide on an area of study and to identify faculty members who might be potential advisors, the division descriptions that follow indicate the chief areas of IQP interest. The names of faculty who have expressed interest in advising projects in each of these divisions may be determined by scanning the project proposals listed on the web-site, www.wpi.edu/Academics/Projects/. A list of residential project centers, with associated faculty, follows the division descriptions. These consultants can provide you with more information about the areas, and can assist you in finding an advisor. If you have questions or need assistance with your early exploration of interactive project opportunities, see the staff at the Interdisciplinary and Global Studies Division Office in the Project Center. Also, consulting the database of Completed Projects (on the campus computer system) is most helpful in suggesting topics and/or advisors.

PROJECT PROPOSALS

Students are strongly encouraged to begin their IQP activity with a project proposal. A detailed outline on preparing project proposals is available in the Interdisciplinary and Global Studies Division Office in the Project Center. *Only students submitting project proposals and the accompanying budget are eligible for college financial support for their IQPs.*

DIVISION 41, TECHNOLOGY AND ENVIRONMENT

IQPs in the environmental area have dealt with a wide range of subjects, including hazardous waste, open space planning, climate changes, acid rain, aquatic weed control, and environmental impact statements. Topics may be global or a local issue; some projects are experimental and generate new data, while others are more theoretical in nature and apply prior research data. Projects must define an appropriate interaction, and be defined and managed within the allotted time period. Environmental projects require a broad base of interest and knowledge, and therefore should be undertaken by student teams rather than isolated individuals. A faculty advisor familiar with your topic and knowledgeable in its interdisciplinary aspects will be able to help your project group.

A project proposal should be done before the actual project is initiated. This proposal should state the question being examined, review the literature in the area of concern, summarize the methodology to be used in the project, suggest the data which will have to be collected, and describe the intended usefulness of the project. This proposal may be done as the first stage of the project, or as a PQP, depending on the advisor's requirements.

A wide range of environmental problems are available for projects. The solution to some of these problems may be sought by various environmental organizations (such as Massachusetts Audubon Society) or governments (mu-

nicipalities or state agencies); the chance to work on such problems provides the student group with the opportunity to solve a real problem while providing the organization or community with a beneficial report.

PREPARATION GUIDELINES

The following courses may provide some basic skills for projects:

BB 2040	Principles of Ecology
CE 3059	Environmental Engineering
SS 2117	Environmental Economics
SS 2311	Legal Regulation of the Environment

Other courses should be taken, depending upon the particular project selected; for this reason it is helpful to think about the project in your sophomore year.

DIVISION 42, ENERGY AND RESOURCES

This division focuses on the problem of meeting society's needs for energy and other mineral resources. The division seeks to promote interdisciplinary project work on energy and resource use and supply. We are concerned with the technological alternatives, the economic, environmental and human value questions that must be faced in choosing among these alternatives, and the role of our social systems and institutions in determining the choices that are made.

Emergence of energy as a distinct area of project activity began at WPI with the energy crisis of 1973-1974. Since then, the pattern of interests in this area both here and elsewhere have evolved in response to international energy developments. Initially, issues of scarcity — the adequacy of the world's energy resources to meet a growing demand and the sudden massive escalation of energy prices that occurred from 1974-1979 — were a primary concern. This period witnessed much activity in modeling energy markets and forecasting trends in energy demand,

DIVISION GUIDE

Division 41, Technology and Environment	page 40
Division 42, Energy and Resources	page 40
Division 43, Health Care and Technology	page 41
Division 44, Urban and Environmental Planning	page 42
Division 45, Science and Technology: Policy and Management	page 42
Division 46, Social Studies of Science and Technology	page 43
Division 47, Safety Analysis and Liability	page 43
Division 48, Humanistic Studies of Technology	page 44
Division 49, Economic Growth, Stability, and Development	page 44
Division 50, Social and Human Services	page 45
Division 51, Education in a Technological Society	page 45
Division 52, Law and Technology	page 46
Division 53, Historic and Artistic Preservation Technology	page 46

supply, and prices. Similar concerns were raised about the supply of basic metals and minerals. Many studies were undertaken of the markets for these natural resources to identify long-run price trends, the prospects for cartelization, and the need for stockpiles.

More recently, at WPI, the interests of students and faculty alike have shifted to an emphasis on “solutions.” In the last half dozen or so years, most of our interdisciplinary student projects have examined the economic feasibility, the environmental side effects, and the impact on public health and mortality of various resource technologies. Renewable sources of energy such as solar, wind, wood, and hydroelectric have been investigated frequently. More conventional alternatives to high-priced oil such as coal, natural gas, and nuclear power have received their share of attention. Many of these investigations have been of the case study type, examining the feasibility of a new technology in a particular setting. Energy independence at the level of the individual home owner has been a popular theme. But other projects have examined more global issues such as the public’s attitude toward nuclear power and its role in shaping national energy policy.

PREPARATION GUIDELINES

The implementation of government resource policies frequently involves manipulation of resource markets. The decisions our society makes about alternative sources of natural resources and the extent of resource conservation adopted will, to a large extent, be determined by the economic laws of supply and demand operating in these markets. Therefore, an understanding of how the economy functions at the level of individual economic decision makers and individual markets is essential for the effective conduct of many resource IQPs. Appraising the economic viability of alternative means of obtaining resources frequently involves making investment studies; i.e., capital budgeting.

The role of government and public opinion in the formation of our national energy policy can best be understood and analyzed by a student who has a background in sociology or political science.

To obtain information on these subjects a student would take as many of the following courses as possible:

Management

MG 2200	Financial Management
MG/IE 2850	Engineering Economics
MG 3400	Production System Design

Philosophy and Religion

PY 2712	Social and Political Philosophy
PY 2714	Ethics and the Professions: Personal, Professional and Social Dilemmas

Social Sciences

SS 1110	Introductory Microeconomics
SS 1120	Introductory Macroeconomics
SS 1203	Social Problems and Policy Issues
SS 1301	U. S. Government
SS 1303	American Public Policy
SS 2304	Governmental Decision Making and Administrative Law

The SS courses listed above may be counted toward the 2/3-unit social science requirement.

DIVISION 43, HEALTH CARE AND TECHNOLOGY

For much of the period since the advent of Medicare and Medicaid legislation in the mid-1960s, the cost of medical care has grown explosively. Both in inflation adjusted dollars and as a percentage of Gross Domestic Product, medical care in the United States is now at a level greatly exceeding that of the early 1960s. Furthermore, because of the aging of the American population (the over-85 age group — the so-called “frail elderly” — is the fastest growing element of our population) and the growth of expensive medical technology, forces remain strong towards an even higher level of medical expenditures.

Projects in this division address the interaction between health care technologies and the delivery of medical care in the United States. These IQPs focus on major social concerns in medicine (e.g., Magnetic Resonance Imaging — MRI, the potential for computer-based “expert systems” in medical care, new technologies for maintaining the independence of the elderly, managerial systems to control the cost of medical care, laser surgery, etc.) and medical-moral issues (e.g., the living will, the right-to-die controversy, organ transplantation, wrongful-death and wrongful-life issues, human cloning, use of steroids in sports, universal health insurance, abortion, fetal tissue transplants, etc.).

There are several off-campus institutions and project centers available as resources for students interested in projects in this area. They include: St. Vincent Hospital, the University of Massachusetts Medical Center, the Massachusetts Biotechnology Park (located in Worcester), San Francisco General Hospital, and St. Mary’s Hospital, San Francisco. The division coordinators should be contacted for the names of WPI faculty members associated with these institutions.

PREPARATION GUIDELINES

Projects in this division are multidisciplinary and should appeal to students with widely differing backgrounds and interests. Those students planning to do IQPs in this area should develop institutional and methodical background in both the technological and social science areas appropriate to their projects. Examples of courses which introduce social science concepts fundamental to this project area are listed below; course work in more specific topics within this project area (e.g., PY 2713, Bioethics, etc.) is also available.

SS 1110	Introductory Microeconomics
SS 1120	Introductory Macroeconomics
SS 1202	Sociological Concepts and Comparative Analysis
SS 1203	Social Problems and Policy Issues
SS 1301	U. S. Government
SS 1310	Law, Courts and Politics
SS 1402	Introduction to Social Psychology
SS 2302	Science-Technology Policy

The SS courses listed above may also be counted toward the 2/3-unit social science requirement.

DIVISION 44, URBAN AND ENVIRONMENTAL PLANNING

Urban and Environmental Planning IQPs offer the student a wide range of opportunities to investigate and analyze problems that require a systematic and comprehensive approach. IQP topics cover a wide range of areas, including: Environmental analysis—such as the investigation of the “quality of life” or the impact resulting from physical alterations of the environment.

Environmental impact statements.

Resource management programs—such as water management programs for lakes, groundwater, rivers; or forest management programs for fuel, lumber, and recreation.

Redevelopment and renewal of city neighborhoods.

Rehabilitation of historic places and buildings.

Fiscal analysis and program impacts—such as those resulting from the implementation in Massachusetts of Proposition 2 1/2.

Preservation of agricultural lands.

Conservation and open-space planning.

Demographic policies and community facilities planning.

Land use planning.

Impacts of infrastructure development.

Often these problems are complex, requiring the use of concepts and skills provided by a range of professions and disciplines: sociology, economics, political science, physical science, law, and engineering. Ignoring these contributions often leads to environmental and social impact, such as air and water pollution, unexpected fiscal burdens, noise, environmental disasters, and unhealthy living conditions. These now are evident in the “treated” water from our urban areas, in the disposal of solid waste from our consumer society, in the sterility of our “planned” subdivisions, and in the global alteration of fragile environment. Comprehensive planning for our urban and natural environment necessitates a holistic approach to solving specific problems which are faced by our neighborhoods, rural environments, urban areas, and the nation, as well as the world itself. Such problems will become worse unless comprehensive planning is understood and used.

PREPARATION GUIDELINES

The concepts and skills necessary for a planning-project will depend on the specific area. Often these multidisciplinary skills are brought to a project through a team effort, in which individuals share their learned disciplinary skills and concepts to solve the problem together. The following are suggested courses which could be beneficial to students who are interested in doing projects in Area 44:

Civil Engineering

CE 3070 Urban and Environmental Planning
CE 3074 Environmental Analysis
CE 4071 Land Use Development and Controls

Social Science

SS 1203 Social Problems and Policy Issues
SS 2117 Environmental Economics
SS 2311 Legal Regulation of the Environment

The SS courses listed above may be counted toward the 2/3-unit social science requirement.

Humanities

HI 1311 Introduction to American Urban History

DIVISION 45, SCIENCE AND TECHNOLOGY: POLICY AND MANAGEMENT

Projects in this division share a concern for government’s role in solving or preventing a problem related to science and technology. Society must make collective choices about technology; increasingly, it does so through the political process. The politics of nuclear power, impact of urban forests on the environment, consumer needs and their impact upon public policy, the relationship between the educational needs of society and responses in the field of education, health policy, and organizational approaches to information management, examples of the issues addressed by students and their advisors. Frequently, the projects use one of the many techniques of policy analysis, which include statistical measures, interviews, and examination of legal case materials.

Policy analysis is one approach, but other projects have used a slightly different approach by focusing on the organizations that perform research and develop technologies. These projects contribute to the design of successful public and organizational policy by explaining how universities and corporations operate, and by identifying those organizational characteristics that are pertinent to corporate or to public policy. IQPs have analyzed the prospects for university-industry relations, the development of entrepreneurs, the implications of the diffusion of innovations in organizations, the impact of new technologies on jobs, and the government’s role in moderating the social impact of the shift to a high-technology service economy.

PREPARATION GUIDELINES

Students should prepare for these projects by learning about the American political economy, public policy, the legal system, and in some cases the management of organizations.

Political Economy and Public Policy

SS 1203 Social Problems and Policy Issues
SS 1301 U. S. Government
SS 2302 Science-Technology Policy

Legal System

SS 1310 Law, Courts, and Politics
SS 2311 Legal Regulation of the Environment

Management of Organization

SS 2121 Government Budgets and Fiscal Policy

Students are encouraged to blend their technical knowledge with a policy analysis. They could identify a policy issue in their major field and look at it from an economic, political, legal, or management perspective.

DIVISION 46, SOCIAL STUDIES OF SCIENCE AND TECHNOLOGY

Projects in this area cover a variety of specific topics, but are united by a general perspective which is characteristic of the field of Science, Technology and Society studies. S.T.S., as it is called, is known by its emphasis on the critical examination of conventional wisdom about the social implications of science and technology.

When proponents proclaim the dawn of a new era or predict that great social progress will accompany the emergence of a technology, S.T.S. people look for the other side of the coin. When opponents attack technology, due to the alienation, loss of meaning, and control issues it creates, S.T.S. proponents probe to see what new possibilities will emerge. Whether the result will be new freedom or new tyranny often depends on the surrounding social arrangements.

In short, the aim of a S.T.S. project is to put aside traditional thinking about the nature of technology, and really examining the ways in which technologies interact with social systems. One starts by dropping the idea that technology impacts society, rather than vice versa, and by questioning the assumption that technological advances automatically represent social progress. Much follows from this modest beginning.

S.T.S. is sometimes called "the Science of Science," as you adopt an attitude of scientific skepticism and then look at science itself, or a technological issue. The result is a critical, but not negative, perspective on technology which paves the way toward a balanced assessment of the benefits and costs of technical change.

Classic S.T.S. projects might involve analysis of tension between technical experts and democratically-elected leaders, the conditions under which technology seems to become an irresistible social force or the way in which distribution of wealth, power, and status are affected by technological change. Organizational "mindsets" leading to technical accidents have also been good project themes.

Technology is rarely neutral in socio-political terms, but its impact can be subtle. The most challenging and rewarding type of S.T.S. study deals with the way technology affects the way in which we relate to the world or view ourselves. Those interested in the interface of technology and society are often like a fish trying to understand water, the medium in which it lives. The great challenge of this field, but also its greatest reward, is that it seems to require considerable reflection about society and the role of the technologist in it to do a first rate S.T.S. project.

CURRENT PROJECT THEMES

Within this broad field, four general project themes are being developed into continuing project streams. A few illustrations of each type are offered below from the list of completed projects.

1. Technological Literacy and Public Understanding of Science
2. Reception of Scientific and Technical Innovations by Affected Communities and Technical Professions
3. Impact and Equity Issues Related to Gender, Race, Ethnicity or Social Class.
4. Reforms in Science or Engineering Education
5. Processes of Technology Transfer and Product Innovation

PREPARATION GUIDELINES

As one can see, S.T.S. is by its nature an interdisciplinary field. Hence, project preparation could appropriately draw from a range of academic disciplines. However, it is usually best to concentrate on picking up the perspective first, and a variety of courses in social sciences, history, and philosophy are taught from S.T.S. perspective. The courses that do the best job of introducing this approach include:

SS 1202	Sociological Concepts and Comparative Analysis
SS 2208	The Society-Technology Debate
HI 3331	Topics in Science, Technology and Society
ID/AR 3150	Light, Vision, and Understanding
SS 2302	Science-Technology Policy
SS 2304	Governmental Decision Making and Administrative Law
CS 3043	Social Implications of Information Processing
HI 2334	European Technology Development
EN 2252	Science and Scientists in Modern Literature

DIVISION 47, SAFETY ANALYSIS AND LIABILITY

Projects in this division deal with issues of people and property safety and the management of risk associated with the hazards inherent in today's society.

The analysis of risk required two components:

1. a measure of severity, and
2. a probability distribution

Typical measures of severity include deaths, injuries, dollars of property damage and days of business interruption. The probability distribution gives a probability for each value the severity measure can take. Some of the risks that have been studied as part of this project division have included risks due to unwanted fires, the misuse and abuse of consumer products, those risks associated with workplace safety and risks associated with natural disasters. Risk management and analysis tools used have included scenario development, fault tree construction and event tree analysis.

The risk associated with unwanted fires is of special interest because each year fires claim a greater toll than earthquakes, floods, tornadoes, and all other natural disasters combined. In just a few minutes time, a single fire or explosion can have catastrophic consequences in facilities ranging from hotels, hospitals and schools to high-rise

offices and complex manufacturing operations. Projects in this topic have examined fire department operation, investigated the economic consequences of design changes in residential smoke detectors and evaluated firesafety risks in passive solar heated homes.

Liability issues focus on the risk associated with products and the consequences of people's actions. Some recent projects in this have been:

1. *Forensic Investigation of an LP-Gas Cylinder Explosion*
2. *An Injury Investigation of Quadriplegia Resulting from an Automatic Shoulder Seatbelt: Design Failure or Negligent in Use*
3. *Rollover Propensity of the Suzuki Samurai*
4. *Legal, product liability and personal injury issues resulting from the case of Locke vs. Mack Trucking, Inc.*

Some useful courses for preparing for "Safety Analysis and Liability" IQP's include:

FP 3070	Fundamental of Firesafety Analysis
MG 2950	Business Law and Ethics
MA 4213	Risk Theory
SS 1202	Sociological Concepts and Analysis
SS 1203	Social Problems and Policy Issues
SS 1301	U. S. Government
SS 1310	Law, Courts, and Politics
SS 2301	Public Policy Formation and Implementation
SS 2311	Legal Regulation of the Environment

DIVISION 48, HUMANISTIC STUDIES OF TECHNOLOGY

The overall theme of projects in this group is the interaction of science and technology with the humanistic and nonquantitative aspects of culture. Together with the relevant fields in science and technology, the appropriate areas of culture from which the methodologies and substance of the projects will be drawn include philosophy, literature, history, religion, humanistic psychology, and the fine arts, with emphasis on values and ideas. The interaction of all levels of technology with the cultures of traditional and developing societies, as well as developed ones, is within the scope of the group. Thus, projects can range over an enormously broad area to include such diverse topics as the relationship of the literature to technology or science, philosophical analysis of the nature and role of the individual in a high-level technological society, or an historical examination of the reductionist view of man as a machine.

Whenever possible, two faculty members will advise each project, one advisor being drawn from the appropriate humanities or art discipline. Faculty members will explain to students the scientific, technological, and humanistic background necessary to begin the projects for which they will act as advisors.

PREPARATION GUIDELINES

Besides a general familiarity with the basic concepts and ideas in the physical sciences, projects in this area involve historical, cultural, social, psychological, or philosophical analysis. Many projects are aided by a general background and familiarity with the literature and fine arts of the modern era.

EN 2252	Science and Scientists in Modern Literature
HI 2332	American Science and Technology from 1859
HI 2333	History of Science From 1700
HI 2334	European Technological Development
HI 3331	Topics in Science, Technology and Society
ID/AR 3150	Light, Vision, and Understanding
PY 2711	Philosophical Theories of Knowledge and Reality
PY 2713	Bioethics
SS 2207	Creativity and the Scientific Community
SS 2208	The Society - Technology Debate
SS 3278	Technology Assessment and Impact Analysis Seminar

Courses might also be selected from the literature, music, art, and philosophy offerings appropriate for the period and national group being studied (either American, European, or Asian), or the history of architecture.

The SS courses listed above may be counted toward the 2/3-unit social science requirement.

DIVISION 49, ECONOMIC GROWTH, STABILITY AND DEVELOPMENT

There are two major areas of interest in the division:

A. PROBLEMS OF STABILITY AND CHANGE IN MATURE COUNTRIES

This project area is concerned with many of the issues that confront the world's developed economies. These issues include the distribution of income and wealth, the kinds and quantities of available jobs, who obtains or fails to obtain the more desirable jobs, and the causes and consequences of inflation and recession. The analysis can focus upon particular sectors or upon the nation as an aggregate. Emphasis is placed upon the manner in which technological and social changes are integrated into the organization of work in society. Economic, social, psychological, as well as political and technological questions can be raised in this project area.

B. PROBLEMS ASSOCIATED WITH GROWTH IN DEVELOPING NATIONS

This project area is intended to encompass a wide range of problems facing developing nations. Generally, projects analyze the environmental, social, economical, and distributional impacts of growth and development, and the design of policies aimed at eradicating poverty and unemployment. In more specific terms, these projects

address such issues as sustainable development strategies, the choice of sectoral policies, the choice of monetary and fiscal policies, rapid population growth, housing and urbanization, education and training, questions of “appropriate technology” and its transfer, import substitution and export promotion, foreign aid and foreign debt, foreign investment, and the role of international firms.

PREPARATION GUIDELINES

The foci of these project areas are economics, psychology and policy studies. Students anticipating work in these areas should have a background in economics, social science, and psychology, and a familiarity with the techniques of statistical analysis and/or computer simulation. Among the courses suggested for preparation are:

SS 2105	Dynamic Modeling of Economic and Social Systems
SS 1120	Introductory Macroeconomics
SS 2120	Intermediate Macroeconomics
SS 2125	Development Economics
SS 1110	Introductory Microeconomics
SS 2110	Intermediate Microeconomics
SS 2117	Environmental Economics
SS 1402	Introduction to Social Psychology
SS 2405	A Psychological Perspective on Environmental Problem Solving
SS 2406	Cross Cultural Psychology: Human Behavior in a Global Perspective
SS 1303	American Public Policy
SS 1310	Law, Courts, and Politics
SS 2311	Legal Regulation of the Environment
SS 2312	International Environmental Policy

The courses listed above may be counted toward the 2/3-unit social science requirement.

DIVISION 50, SOCIAL AND HUMAN SERVICES

The delivery of social services is one of the most difficult and controversial problems currently faced by our society. In the past, IQPs have examined such issues as services for the mentally or physically handicapped, especially public school students, rehabilitation of juveniles, treatment for alcoholism and drug abuse, consumer information awareness, assessment of college life and student attitudes, and other community service concerns. Many projects in this division will be concerned with the strengths and deficiencies of the systems which the private and the public sectors of our society have established or are proposing to establish for dealing with community problems.

PREPARATION GUIDELINES

Projects in this category are multidisciplinary, and should appeal to students with widely differing backgrounds and interests. Those students who expect to do IQPs in this area should develop analytic backgrounds in the particular social science area(s) appropriate to their project. Examples of courses which introduce concepts fundamental to this division are listed below. Students anticipating IQPs which involve economic analysis should consider course work in that discipline. Also, projects involving surveying of public attitudes will require back-

ground in social analysis as found in SS 1402 and SS 2403. SS 2203 is an excellent introduction to problem-solving in the social sciences. MG 2300 is recommended for projects involving conflict resolution and management of social problems through industrial engineering techniques.

Recommended Courses

MG 2300	Organizational Science—Foundation
SS 1110	Introductory Microeconomics
SS 1120	Introductory Macroeconomics
SS 1202	Sociological Concepts and Analysis
SS 1203	Social Problems and Policy Issues
SS 2311	Legal Regulation of the Environment

The SS courses listed above may be counted towards the 2/3-unit social science requirement.

Examples of IQPs recently completed in this division are:

- A Guide to References That Assist Wheelchair Users in Addressing Concerns That Can Occur During College Careers.
- Alcohol and Youth Culture in Spain and the U.S.
- Computer Adaptations for Visually Impaired.
- Streamlining Communication Systems for Autistic Children

DIVISION 51, EDUCATION IN A TECHNOLOGICAL SOCIETY

Offerings in this area include projects in which WPI students teach and/or develop curricula at all grade levels from K through college in a variety of subjects. In other projects, students apply technology to learning (through research and development of teaching aids and machines), deal with mass media (methods and implications of teaching large segments of the population), or focus on the teaching-learning process (through study and research of learning models and theories).

Many projects are carried out with local regional public and private schools through the “WPI School-College Collaboration in Mathematics and Science Education.” WPI has a close working relationship with the nearby Doherty High School. For details of these programs, contact Assistant Provost Lance Schachterle, Boynton Hall.

PREPARATION GUIDELINES

Education plays a dominant role in the modern, technical society. It is a compulsory, long-term experience for a significant segment of the American population. To prepare for projects in this area, the student should have a perspective on modern American history with emphasis on the development and growth of the present educational system, an understanding of psychological development and theories of learning, and a background in the elementary concepts of social science research.

HI 1311	Introduction to American Urban History
SS 1202	Sociological Concepts and Analysis
SS 1402	Introduction to Social Psychology
SS 1203	Social Problems and Policy Issues
SS 2401	The Social Psychology of Education

The SS courses listed above may be counted toward the 2/3-unit social science requirement.

For students planning to develop science curriculum, the appropriate science and mathematics background is assumed.

TEACHER LICENSING OPTION

Students doing education IQPs may be interested in also qualifying as a secondary school mathematics or science teacher. For information on this option, see "Teacher Licensing" on page 119.

DIVISION 52, LAW AND TECHNOLOGY

Technological developments take place in the context of a complex legal and regulatory environment. For example, courts will apply principles drawn from unwritten common law to restrict land uses by property owners. In contrast, developments in communications, energy, and pharmaceuticals are governed by an interlocking structure of statutes and regulations at both the state and federal levels.

IQPs in this division focus on the interaction between legal and regulatory institutions and technology. Project students study statutes and their history, regulatory systems, agency decision making, and judicial decisions to determine their impact on technology.

In addition, students study the operation of technology in a legal environment to determine whether social goals expressed in law are realized in practice. Will the Clean Air Act clean air? Do regulations for the handling and disposal of toxic materials protect the public? Can regulation effectively promote energy conservation? Do procedures governing drug approval unnecessarily prevent the speedy introduction of new treatment methods?

Aspects of legal and regulatory decision making are also studied. When do courts accept scientific evidence as determinative of facts? Can scientists provide objective, expert advice for governmental decisions or are scientists destined to become partisan policy advocates?

The answers to all these questions are important if technology is to aid us in the achievement of social goals and if courts and regulatory agencies are to succeed in defining and implementing social policy.

PREPARATION GUIDELINES

Successful completion of IQPs on the topics described above depend, in part, on prior preparation in government, law and society-technology issues. The following courses support IQP research in this division:

HI 2317	Law and Society in America, 1865-1910
SS 1110	Introductory Microeconomics
SS 1120	Introductory Macroeconomics
SS 1301	U.S. Government
SS 1303	American Public Policy
SS 1310	Law, Courts, and Politics
SS 2208	The Society-Technology Debate
SS 2302	Science-Technology Policy
SS 2304	Governmental Decision Making and Administrative Law
SS 2310	Constitutional Law
SS 2311	Legal Regulation of the Environment
SS 3278	Technology Assessment and Impact Analysis Seminar

Students should consider combining courses listed above to form sequences in policy studies, law, or society-technology studies. Additional information on sequences appears in the description of social science courses.

DIVISION 53, HISTORIC AND ARTISTIC PRESERVATION TECHNOLOGY

Projects in this division examine the value and policy issues surrounding decisions on which historic and artistic objects such as buildings, battlefields, statues, monuments, prints, drawings, paintings, and sculptures should be preserved and how best to preserve them. They may also deal with the technical issues involved in art conservation and restoration and involve application of the technical methods available for analyzing the composition of historic objects.

PREPARATION GUIDELINES

Ideal preparation for projects in this division would include art history and material science and familiarity with data base management programs.

Recommended Courses:

AR 1111	Introduction to Art History
AR/ID 3150	Light, Vision, and Understanding
AR 2113	Topics in 19th and 20th Century Architecture
HI 1331	Introduction to the History of Science
HI 1332	Introduction to the History of Technology
ES 2001	Introduction to Materials Science
ME 2820	Materials Processing
CM 580	Materials Characterization in the Solid State
CM 508	Catalysis and Surface Science of Materials

In addition to IQP and MQP opportunities on campus, through the Global Perspective Program, WPI students have many opportunities to work for a seven-week term at one of WPI's residential project sites. Project work conducted at these sites provides teams of students with extraordinary opportunities to learn by solving problems provided by professional or government agencies. Most of these programs offer IQPs; MQPs and one-term Sufficiencies (see page 60) are available depending on faculty advisors.

Registration for IQP work in these programs begins in the fall with the Global Opportunities Fair. At the Fair, IQP and exchange program directors will be available to talk with students about these opportunities. Students should apply in the fall of the year preceding the year in which they would like to participate. Further information is available at the Interdisciplinary and Global Studies Division in the Project Center.

RESIDENTIAL PROGRAMS

All programs offer the students the opportunity to complete a project in seven weeks of full-time work. Advance preparation is required. Faculty advisors are in residence at the site.

	TERMS OFFERED				
	A	B	C	D	E
Greenbelt, Maryland*	<input type="checkbox"/>				
Washington, D.C.		<input type="checkbox"/>			
Worcester, Massachusetts		<input type="checkbox"/>	<input type="checkbox"/>	<input type="checkbox"/>	
London, England**/**		<input type="checkbox"/>			
Wall Street, NY**		<input type="checkbox"/>			
Zurich, Switzerland		<input type="checkbox"/>			
Bangkok, Thailand			<input type="checkbox"/>		
Hong Kong			<input type="checkbox"/>		
London, England			<input type="checkbox"/>		
Nancy, France**			<input type="checkbox"/>		
Silicon Valley, California**			<input type="checkbox"/>		
Boston, Massachusetts				<input type="checkbox"/>	
Copenhagen, Denmark				<input type="checkbox"/>	
London, England				<input type="checkbox"/>	
Madrid, Spain**/**				<input type="checkbox"/>	
Melbourne, Australia				<input type="checkbox"/>	
San Juan, Puerto Rico				<input type="checkbox"/>	
Windhoek, Namibia				<input type="checkbox"/>	
London, England					<input type="checkbox"/>
San José, Costa Rica					<input type="checkbox"/>
Venice, Italy					<input type="checkbox"/>

*This site offers MQP program at NASA Goddard Center.

** MQP opportunities only.

***Sufficiency opportunities only.

PROGRAMS IN THE UNITED STATES

WASHINGTON PROJECT CENTER

Director: Prof. D. DiBiasio, Goddard Hall 218A

WPI's Washington Project Center operates in Term B each year. Students, usually juniors and seniors, work in three-member project teams with a variety of federal, private, and nonprofit groups. In the past, projects have been completed with the U.S. Coast Guard, the Office of Patents and Trademarks, the National Science Foundation, the National Academy of Engineering, the National Society of Professional Engineers, the Agency for International Development, the Consumer Product Safety Commission, the Department of Health and Human Services, among many others. Students work on their projects at the sponsoring agency for the entire seven-week term, while living in downtown Washington, D.C., within several blocks of the White House and many government agencies.

There are several qualities that every Washington Project Center applicant should have. Most importantly, students should have a curiosity about how government works and the importance of national action in the areas of the environment, education, health, and defense, for instance, and the importance of U.S. actions on global matters. Washington is one of the information capitols of the world; thus students have the opportunity to conduct interviews with policy makers of many different disciplines and to examine data not available elsewhere. International students would find this experience to be very valuable. Secondly, students should be willing to learn about tools of social science research, which may include conducting surveys by mail, by telephone interviewing, or by face-to-face interviewing.

Living in Washington provides students an endless access to the free national museums that are part of the Smithsonian complex. They include the Air and Space Museum, the Museum of American History, the Natural History Museum, the National Gallery, the museums of African and Oriental Art. In addition there are the Lincoln, Jefferson and Vietnam Memorials; the National Holocaust Museum; the National Archives; the Washington Monument; and of course, the Senate and House hearings, which are open to the public.

All Washington students are required to register for the preparation course ID 2050 in the A Term preceding going to Washington. Students should also be making satisfactory progress in their academic program at WPI.

BOSTON PROJECT PROGRAM

Director: Prof. F. Carrera, Project Center

WPI's Boston Project Program operates in Term D each year. WPI project teams, with a resident WPI faculty member, work on topics offered by government agencies, environmental and community organizations, medical and financial institutions, and private-sector industrial firms.

Boston is a world-class city, with a wealth of cultural, educational, recreational and touristic opportunities. It is an exciting, vital, and stimulating environment. It is, of course, not far from WPI, which minimizes the expense of getting there and back compared to a site half-a-world away.

Students will work in teams of three on projects at the sponsoring organization for the entire seven-week term. Student housing and project assignments are arranged in advance. Selection of students for this program takes place in Term B for the following academic year. All Boston students are required to register for a preparation course offered in the C term preceding the D-Term project.

WORCESTER COMMUNITY PROJECT CENTER

Director: Prof. R. Krueger, Project Center

Students work in offices in central Worcester and commute daily from their WPI base.

Projects are recruited from private and public Worcester agencies focusing on policy issues where recommendations can make significant contributions to improving the city we live in. Sponsorship includes government, public interest, charitable and educational organizations.

Recent examples of projects include: a) a study of community Internet accessibility (sponsor: Worcester Information Technology Project); b) marketing of the Worcester Convention Center and the City Hall Plaza (sponsor: Director of Marketing for the City of Worcester); c) implementing an engineering curriculum at Doherty High School (sponsor: Worcester Public Schools) and d) issues in rehabilitating old commercial properties in the Prescott St. area for new high-tech ventures.

THE WPI/GODDARD SPACE FLIGHT CENTER MQP PROGRAM

Director: Prof. Fred Looft, Atwater Kent 229

The Goddard Space Flight Center Project Program operates in Term A each year and is for students seeking to complete their Major Qualifying Project requirement. Students work in teams of three or four on projects and problems related to unmanned, earth observation space flight systems. Recent and on-going projects have included the design and development of new coatings for next generation mirrors, a prototype of a new star pointing control system

and sensor, software for optimized load sharing on computers used to design spacecraft, and the automation of a very low vacuum test chamber used to test and qualify components and systems for space-flight.

The GSFC Project Program is significant in that it supports both the WPI mission to provide off-campus project experiences to our students, and supports the Goddard mission

"To promote excellence in America's education system through enhancing and expanding scientific and technological competence."

From the WPI perspective, specific objectives incorporated within the development of this program include a focus on a single term (A, 9 weeks) off-campus MQP opportunity, projects in several different engineering and scientific disciplines, opportunities for WPI students to work on an intensive and focused team project in a professional technical environment, and delivering a final project report that is representative of exceptional high quality work and documentation by WPI students.

Students seeking to apply to this program should be majoring in Computer Science, Chemical Engineering, Electrical Engineering, Mechanical Engineering Math, Physics or Humanities. Other majors will be included as projects are identified and worked into the scope of the program. Students typically live in the College Park, MD, area and commute to the Goddard Space Flight Center via automobile. The advantage to this living situation is that the students have access to the Washington area, as well as the Greenbelt area where the Center is located.

Students that are accepted to this program are required to complete a PQP during D term of the previous academic year. During the PQP the student teams will develop a project proposal and start learning the engineering and science background material needed to complete their project. A one-day planning trip to Goddard is also scheduled during the PQP so that the student teams can tour Goddard and visit the facilities where they will be working. Time is set aside during this visit for the student teams to interact with their mentors. Currently students interested in this program must be U.S. citizens.

Further information on this program can be found at <http://www.ece.WPI.EDU/~fjlooft/gsfsc/> or by contacting the program director, Professor Fred Looft (fjlooft@ece.wpi.edu).

SILICON VALLEY PROJECT CENTER

Director: Prof. David Finkel, Fuller Labs 231

Silicon Valley, California, is the home to many of the most dynamic companies in the computer industry and in other related high-technology industries. Established companies, such as Sun, Intel, and Hewlett-Packard, mix with small start-ups to provide an exciting atmosphere of technology and entrepreneurship. The projects will expose students to both the cutting-edge technology and the dynamic entrepreneurship of Silicon Valley.

Students participating in the Silicon Valley project center will participate in a Preliminary Qualifying Project (PQP) during B-Term, 2003. During this PQP, the students will perform background research in the area of their project, learn about the company and the industry where they will be performing their project, and hold discussion with their company mentor about their project work. One of the outcomes of the PQP is a detailed proposal, describing the general era of the project, the specific problem to be addressed, and the approach the students will adopt to solving the problem.

The projects will be conducted during C-Term 2004 in Silicon Valley. The students will work full-time at their sponsor's site for approximately 9 weeks, from early January through early March. The students will work with a mentor from the sponsoring company and with a WPI faculty advisor. The project work will include the completion of an MQP report and a presentation on the project work to the sponsoring organization.

Admission to the Silicon Valley Project Center is based on academic standing and performance, essay response, evidence of maturity and independence, availability of projects in a specific area, qualifications relevant to the project offered, and results of an interview.

Projects may be available in a number of disciplines, including:

Biology/Biotechnology
Chemical Engineering
Computer Science
Electrical Engineering

PROGRAMS IN EUROPE

DENMARK PROJECT CENTER

Directors: Prof. Peder C. Pedersen, Atwater Kent 205
Tom H. Thomsen, International House

What makes Denmark an ideal place for an IQP Project Center is a combination of several factors. The Danish culture is very much open to the kind of interdisciplinary academic questioning which is the foundation of any good IQP project.

The Denmark Project Center, located in Copenhagen, operates in D term each year. In the past, projects have been completed with The National Museum, NOAH (Danish Friends of the Earth), The Engineering College of Copenhagen, The Danish Society for the Blind and the Danish Bicycle Federation. It is expected that future IQP projects in Denmark will be related to disability and environmental issues and work with museums, in addition to continuing to work for not-for-profit organizations.

A WPI faculty advisor remains in residence throughout the 8-week period. Students are required to register for 1/6 PQP in B-term and 1/3 PQP in C term (ID 2050) prior to leaving for Denmark. PQP work consists of project preparation including writing a project proposal and a seminar in Danish history and culture. In addition, students participate in a five-day orientation program in Denmark. The program gives an introduction to Copenhagen, Danish language and contemporary issues.

Housing in Copenhagen will, in most cases, be apartments located near the center of Copenhagen, with stores and public transportation within a few minutes walk.

LIMERICK, IRELAND

Directors: Prof. John McNeill and Richard Vaz

Limerick is Ireland's third largest city, and a center for both tourism and business, yet it retains the charm and feel of a small community in many ways. Limerick's center is located on the River Shannon, and features both medieval and Georgian influences; the outskirts of the city are home to a number of high-technology business parks and a major university. The areas surrounding Limerick are famous for their natural beauty and historical significance; the Republic of Ireland is small enough so that it can be explored from end to end in a series of weekend excursions. Visitors to Ireland encounter spectacular scenery including 3,500 miles of coastline, a rich cultural and literary heritage, vibrant cities and villages, and a warm and friendly populace eager to help visitors feel at home.

MQPs in the Limerick area involve working on-site at local electronics and computer firms and research laboratories. In B term of the preceding year, project opportunities are identified for particular areas within electrical and computer engineering and students are selected. The following A term, students spend 10 weeks in Limerick, living among Irish people and working fulltime in collaboration with engineers at the local firms on the projects.

MQPs in Limerick involve most areas of specialization within electrical and computer engineering, including analog and mixed-signal hardware design, digital design and embedded systems, signal processing and communications, and software engineering. Special project statements are not available until the beginning of the projects, as project sponsors typically provide the opportunity for students to work on cutting-edge problems of immediate interest to the companies.

Admission to the ECE MQP Program in Limerick is based on the following criteria: academic standing and performance, evidence of maturity and independence, qualifications relevant to the anticipated projects, faculty references, and the results of an interview.

LONDON PROJECT CENTER

Directors: Prof. P. Davis, IGSD Project Center
Prof J. Demetry, Atwater Kent

IQPs are available at the London Project Center in terms C, D and E. (Sufficiencies are available in terms D and E; see the accompanying description of the London Sufficiency Program.) Together with a resident WPI faculty adviser, teams of WPI students find solutions to problems posed by British public and private agencies. Housing and project assignments are arranged in advance with the assistance of WPI's London-based Center Coordinator. Many opportunities are available during the term for visits to cultural institutions in and around London. Each term in London also includes a long weekend to permit extended travel outside of London.

Sponsors of London Center IQPs include the Tower of London, the Museum of Science and Industry, the London Borough of Merton, the Victoria and Albert Museum, the Institution for Electrical Engineers, the Association of Chief Executives of National Voluntary Organizations, the Royal Hospital for Neuro-disability, the Dickens House and many other organizations.

Selection of students for the London Center for the following summer and academic year normally begins in term B. Interested students can begin the application process by attending the Global Opportunities Fair in September. All London IQP students are required to enroll in ID 2050 and to complete a PQP in the term preceding their work in London.

LONDON SUFFICIENCY PROGRAM

Coordinator: Prof. P. Hansen, 39 Dean Street

WPI offers Sufficiency Projects in London in Terms B and E. London Sufficiency Projects are interdisciplinary and intended for students with many backgrounds in the humanities and arts. London was once the center of a global empire and its influence continues to radiate throughout the British Isles and well beyond. Sufficiency students in London study topics that might include history, literature, music, theatre, or culture, and work on projects that build on at least three previous courses in humanities and arts. As an interdisciplinary program, the London Sufficiency is not limited to the history or literature of Britain, but all projects take advantage of the unique resources available in London. These include some of the world's most vibrant theatre and the arts, outstanding museums, ambitious architecture, the libraries of the University of London, collections of film or sound recordings, and much more. London Sufficiency Projects are appropriate for students with a background in art history/architecture, drama/theatre, history, literature, music, philosophy, religion, or writing/rhetoric. Students planning a minor or major in International Studies, Humanities and Arts, or Technical Scientific, and Professional Communication, also may study in London in conjunction with this program.

MADRID SUFFICIENCY PROGRAM

Coordinators: Prof. L. Fontanella, Salisbury Labs 17
Prof A. Rivera, Salisbury Labs

Students spend seven weeks in one of the world's most vibrant, fashionable cities. Madrid is home to some of Europe's most active museums, a bull ring, two massive soccer stadiums, grand parks, regional fiestas, and "tapas" bars where samplings of regional foods is the fare. Madrid and nearby El Escorial were once the center of by far the largest empire the world has ever known. Today Madrid is a modern, post-Spanish-Civil War phenomenon of culture and commerce – the acid-test through which business and art must pass in order to prove themselves successful.

Students complete Sufficiency projects on the cultural history of Spain by studying the country's past at different sites in and outside of Madrid, and students are shown access to the things that in contrast define present-day Spain. These projects are appropriate for students who have completed at least the Intermediate II level of Spanish. For these students, the expectation is vast cultural acquisition and notable linguistic improvement. The Madrid Sufficiency will prepare students for later project work at Spanish-speaking sites. For more advanced students planning to minor in Spanish, the Madrid experience can be tailored in the form of independent study projects.

VENICE PROJECT CENTER

Directors: Profs. Fabio Carrera, Project Center
Richard Vaz, Atwater Kent 225

Called the most beautiful city in the world, Venice has a haunting atmosphere which easily evokes the splendor of its past. A city with an outstanding historical, artistic and architectural heritage, much of its uniqueness comes from its symbiotic relationship with the sea and the lagoon. Yet today, this relationship contributes to serious environmental and economic problems. As daily life revolves around the canals, proposed solutions to these problems usually have a direct impact of the inhabitants of Venice.

The IQPs in Venice provide an opportunity for students to see the implementation of their projects put to use for the benefit of an entire city. Projects are conducted for Venetian, American and international organizations and include environmental, socioeconomic, artistic, cultural and technical concerns important to the sustainability of this historic city.

WPI faculty advisors remain in residence throughout the 8-week term. Students are required to register for three preparatory activities: a 1/6 unit on Italian history and culture in Term C; a 1/6 unit on the Italian language in Term D; and a 1/6 unit PQP in Term D. Prior knowledge of the Italian language is not required.

ZURICH, SWITZERLAND

Coordinator: Prof. G. Theyel, Project Center

Switzerland - the Alps, mountain climbing, skiing, trekking, hiking, the world's best chocolate, cheese and watches, trains that run exactly on time—these are all stereotypes that describe one of the world's most beautiful countries. But Switzerland is far more than yodeling and milchmadchen in trocken; it is the most culturally diverse nation in Europe, with 4 official languages and the largest percentage of foreigners. Zurich, the cultural, intellectual and technological heart of German-speaking Switzerland, is one of Europe's most beautiful cities, located on a pristine lake overlooking the Alps. Zurich is home to two major universities, and although it's the largest city in Switzerland, it has the feel of a small town. With a magnificent old town, gothic cathedrals and splendid Swiss architecture, Freud, Marx, Lenin, Jung, Wagner and many others sought out Zurich as a home.

Zurich is an international center of banking and insurance, and Switzerland is the home of the International Olympic Committee, the International Red Cross, many United Nations agencies, and several multinational environmental groups. Its multicultural, multi-linguistic setting is perfect for IQPs, and a sampling of topics includes studying avalanches in the Alps, gauging public perception of cloning and biotechnology, and helping a small village's volunteer fire department determine how well it has done its job.

PROGRAMS IN ASIA

BANGKOK PROJECT CENTER

Director: Prof. S. J. Weininger, Goddard Hall 305

To commemorate the 125th anniversary of the college with its theme of "WPI in the World," WPI established its first Project Center for IQPs in Asia in 1989. Students conduct IQPs in Bangkok, Thailand, in Term C annually. WPI students carrying out IQPs in Bangkok have incomparable opportunities to investigate, first-hand, the rapidly growing technologies and economies of Asia. While all projects are conducted in English, students have many opportunities to encounter Thai culture. Projects are usually sponsored by local universities, government agencies, or by U.S. companies with Asian offices. Numerous projects involving the environment and service to the poor have been carried out in Bangkok since the Center's founding.

IQP topics, housing, and travel arrangements for Bangkok are arranged in advance through resident coordinators in Bangkok, in conjunction with Chulalongkorn University.

HONG KONG, CHINA

Coordinator: Prof. E. Ma, Goddard Hall 121

The Project Program in Hong Kong provides a gateway to the most dynamic and important region on the planet. The wealth of the world has moved to Asia and Hong Kong plays a crucial role in the development of China — historically the most significant actor in Asia. This city radiates energy as it rapidly modernizes and takes the lead in economic development, high-rise building, historic preservation and artistic conservation.

In Hong Kong, WPI is aligned with Caritas, a Catholic Charity and educational institution with a worldwide network of sites. Caritas has advised IQPs since 1990, and, with Hong Kong's reversion, Caritas has expanded its operations to the mainland of China. Caritas maintains resort housing available to WPI students on the outer islands of Hong Kong, and the Bianchi Lodge in Kowloon. WPI is also working with the "Civic Exchange", a newly established think tank in Hong Kong that deals with a vast variety of issues including environmental and energy policies.

IQPs will deal with environmental, energy and social issues, web applications, educational surveys, and other topics as appropriate.

MQPs may be available in a number of disciplines, including:

- Chemical Engineering
- Electrical Engineering
- Civil Engineering
- Other fields as negotiated

PROGRAMS IN LATIN AMERICA

COSTA RICA PROJECT CENTER

Director: Prof. Susan Vernon-Gerstenfeld, IGSD

This project center, located in San Jose, Costa Rica, operates in E-term. In this stable democracy, students have the opportunity to perform IQPs in a variety of settings ranging from rain forests, to local manufacturing plants, to multi-national companies and organizations, to non-profit organizations and to Costa Rican government offices.

Since Costa Rica is a rapidly developing nation, the interactions between technology and social implications are graphic. Working full-time, in each sponsoring organization, students experience the thrill of a new culture and the pleasure of providing needed work for the sponsor. Teamwork is the rule for participating students, who have designed a national GIS system for the fire department, developed a method for removing latex from the processing of bananas so that there can be 100 percent recycling of water, developed an interactive rainforest exhibit in the national science museum, worked to develop an inexpensive fish farming system to supply a means of living for with subsistence farmers in any developing na-

tion, organized a plan for ecological education through a bird watching program for a world renowned botanical garden, developed an environmental policy for a rainforest that operates tourist activities according to sustainable development principles, as well as many others.

Before leaving to go on-site, students participate in a 1/2 unit of preparation. In Costa Rica, students have the opportunity of improving their Spanish, if they have some, or learning enough for survival through a short intensive course taken during the beginning of their stay. They continue their immersion during their off-hours on all of the myriad excursions they will undertake throughout the country or by simply being in Costa Rica. However, most of the projects can take place using English. Housing and transportation are arranged before the students leave.

Costa Rica is the center of bird migration from both South and North America. It hosts live and dormant volcanoes, dense but very explorable jungles and rainforests, and has world-renowned beaches, as well as very amicable people.

PUERTO RICO PROJECT CENTER

Director: Prof. Susan Vernon-Gerstenfeld, IGSD

The Puerto Rico Project Center operates in D-term in San Juan, Puerto Rico, the capital of the Commonwealth of Puerto Rico. As in other off-campus centers, students work full-time, in the offices of the government of the Commonwealth, as well as in industry. Students perform their work under the guidance of a WPI faculty person who accompanies the students to San Juan. In addition, the sponsoring agency or company provides a liaison person to work with the students.

Projects span a wide variety of topics and include governmental concerns including transportation, health, housing, the environment, social welfare, infrastructure, and land use for a few examples. The fact that these concerns apply to a culture different from that of mainland U.S. makes them particularly interesting.

Students interested in this center will have the opportunity to learn some Spanish if they wish or to apply that which they already know. They will also have the opportunity to be immersed in a Latin culture and to having access to a large metropolitan area. There will be abundant opportunities to see other parts of the island and to visit sites such as the Arecibo (outerspace) Observatory, El Junque national rain forest, the phosphorescent bay at La Parguera, the art museum at Ponce, El Moro fortress in San Juan, the white sand beach at Loquillo, and various indigenous people. Housing and transportation are arranged before the students arrive on site.

Students participate in 1/2 unit of preparation prior to leaving campus for the on-site portion of their work.

PROGRAMS IN AUSTRALIA

AUSTRALIA PROJECT PROGRAM

Directors: Prof. M. Ward, Fuller Laboratory 134
Prof. J. Barnett, Higgins Laboratory 105

WPI's Australia Project Program, based in the city of Melbourne, operates in Term D each year. As this is a relatively new project site, the project topics in Melbourne may change significantly from year to year. Current sponsors include the Fire Protection Association of Australia, the Department of Human Services, the Commonwealth Scientific and Industrial Research Organization and Arup Fire, a local engineering consulting firm.

Melbourne, situated along Australia's southeast coast, is the country's second largest city. It is a city of parks and gardens, specializing in arts festivals, sporting events, and fine dining. It was voted "the world's most livable city" in the international survey. Melbourne is also a fine place from which to explore the diversity of Australian life, being a short distance from mountains, deserts, beaches, mining towns, and extensive parklands and wildlife reserves.

It is anticipated that opportunities will exist for some satellite projects, without a resident WPI faculty member, in Darwin and possibly other major Australian cities.

Students will normally complete two 1/6 unit PQP activities. These will normally be completed in terms B and C.

Students will work in teams of three or four with a resident WPI faculty member, on projects at the sponsoring organization for the entire seven-week term. Student housing and project assignments are arranged in advance. Selection of students for this program takes place in Term B for the following academic year.

REQUIREMENTS FOR INDIVIDUALLY SPONSORED RESIDENTIAL PROJECTS (ISRPS)

Many students and faculty augment the educational opportunities available at WPI's formal project centers and programs with individually sponsored residential, off-campus projects. All such programs must adhere to common, carefully structured risk management protocols such as those developed and implemented at established project centers. Otherwise, students, faculty, and WPI are exposed to unnecessary risk.

Hence, the Provost requires completion of the following risk management protocol by all faculty intending to advise students who will earn academic credit while in residence off-campus in individually sponsored projects.

1. Two terms in advance of the off-campus activity: Faculty advisor sends a letter of intent to the Provost's office. The letter describes the scope of the anticipated project, where it will happen, how many students will participate, and the term that the students will be off-campus.
2. Ten weeks prior to departure: Faculty advisor submits a completed ISRP form (PDF) to the Provost's office. The ISRP form is co-signed by the academic department head (MQP or Sufficiency) or Dean of IGSD (IQP).

3. Six weeks prior to departure: Student participant(s) submit the following forms to the faculty advisor: the Acknowledgement of Voluntary Participation, the Off-Campus Students' Health Update and Records Release Form, and the WPI Off-Campus Travel Information Form (PDF).

4. Five weeks prior to departure: The advisor submits these completed forms (item 3) to the IGSD.

Please note that all forms can be located on the Web at <http://www.wpi.edu/Academics/Depts/IGSD/>

Project registration will not be complete until the conditions of this protocol are met.

At the completion of step 2, WPI's risk managers will review the information provided and make a recommendation to the Dean of IGSD, who will assist the Provost in making a final decision to approve or disapprove the activity based on considerations of risk management. The faculty advisor will learn of this decision no later than the first day of the term preceding the proposed activity.

	E Term Away	A Term Away	B Term Away	C Term Away	D Term Away
Proposal made to Provost's Office	By January 10th	By March 10th	By May 10th	By September 10th	By November 10th
Completed ISRP form submitted to Provost's Office	By March 15th	By June 20th	By August 25th	By October 25th	By January 5th
Completed Health & Safety Forms for each student submitted to the IGSD	By April 20th	By July 25th	By September 25th	By December 5th	By February 5th

ON-CAMPUS IQP PROGRAMS

LIVING MUSEUMS PROGRAM

The Living Museums Program provides students with unusual opportunities to carry out IQP projects at various culturally rich museums of New England. Museums synthesize knowledge and combine artifacts with primary and secondary documents, often to create an entire social and physical environment. Thus, as students work with professional staff, documents, and artifacts at museum sites, they gain an understanding of the past and present, and begin to see how distinct aspects of human life fit together to form a specific culture. At the outstanding museums participating in the program, students can select projects from a varied list of areas ranging from medieval warfare at the Higgins Armory Museum in Worcester to the rich history and literary culture of Concord, MA, at the Concord Museum and the Thoreau Lyceum.

Special projects are available each summer in Term E at several museums and historical institutions such as : Mechanics Hall, Worcester, MA; the Worcester Historical Museum; Fruitlands Museum in Harvard, MA, Martha's Vineyard, and Higgins Armory Museum.

GENDER, RACE, AND TECHNOLOGY

Prof. S. Vernon-Gerstenfeld, IGSD

Student projects in this program research issues in two general areas: (a) the participation of women and people of color in engineering and science education and in engineering professions, and (b) the effects of particular technologies on women, African Americans, Hispanics, Native Americans, and other specific racial or ethnic groups.

Projects are often coadvised, with one advisor from humanities or social science, and one advisor from science, engineering, or computer science disciplines.

Past and ongoing project topic areas include:

- effects of automation on office workers
- women in science and engineering professions

- underrepresented groups in science and engineering professions
- sex differences in learning styles in technical subjects
- ethics and reproductive technologies
- science and math education for precollege Native Americans, Hispanics and African Americans.

Project ideas in these or other areas related to gender, race, and technology can be initiated by students or faculty. For more information, contact Prof. Susan Vernon-Gerstenfeld, Project Center 216.

AWARDS AND SCHOLARSHIPS

THE PRESIDENT'S IQP AWARDS

The President's IQP Awards have been established to encourage and recognize meritorious accomplishment in the performance of the Interactive Qualifying Project. To be considered for an award, the IQP, while of overall good quality, should be outstanding in conception, execution, and presentation. There are no predetermined categories for the awards, but the award will recognize the qualities in which the project excels. By thus calling attention to projects which are deemed to be outstanding, the awards help to establish standards for exceptional quality in IQPs.

Each award consists of a certificate of merit to each student and an honorarium. The IQP awards competition is conducted each fall. For further information, see Dean Paul Davis, IGSD Office, Project Center.

THE PROVOST'S MQP AWARDS

The Provost of WPI conducts an annual competition to recognize several project teams in each discipline whose MQPs, in the view of the judges, have been unusually innovative, well executed, and well presented. To qualify as a contestant, the student team must be identified by the department of the team as one of the best presenters in the department oral competition. For more information, contact Assistant Provost Lance Schachterle in Boynton Hall.

The word “Sufficiency” usually designates the WPI humanities and arts degree requirement. It indicates a thematically related course and project sequence “sufficient” to give students an idea of how knowledge is obtained and expressed in a non-technical discipline.

Rather than offer merely an impression of many different areas of the humanities and arts, the WPI Plan calls for a meaningful grasp of a single thematic topic or a single discipline. The Sufficiency is not equivalent to fulfilling a distribution requirement by passing a certain number of unrelated courses. Instead, courses are taken in a chosen area of the humanities or arts, or they are focused on a theme that combines more than one area. They culminate in a final independent study, in which the student begins to do original work in an aspect of the humanities or arts.

The culmination of each student-selected sequence will be an independent study, producing a critical or research essay or, in combination with an analysis, short stories, poems, works of music or musical performances, visual art, or dramatic performances. (See also “Foreign Language Sufficiency” exception.) The final accomplishment must sum up the previous work in the humanities and arts not only by drawing upon what has been learned in previous work, but also by exploring new territory. The goal is to give the student enough background in one area of the humanities and arts so that—just as a student with an engineering or science major gains insight into how human creativity is exercised in such fields—in fulfilling the Sufficiency, the student learns how the mind creates, appreciates and criticizes work in the humanities and arts.

GOALS OF THE SUFFICIENCY

To develop an ability to display increased knowledge and initiate critical thinking and to present arguments in a manner consistent with the type of project.

To develop an ability to communicate clearly, precisely, and accurately about the process, product, or research selected for the project.

To develop an ability to discover and employ appropriate resources or references throughout the project work.

To develop an ability to apply individual creativity and originality in an effort directed toward achieving the goals of the project.

To develop the ability to present the project work in a mode that is consistent with the professional standards for the type of project undertaken.

REQUIREMENT MET BY “OVERALL EVALUATION OF TWO UNITS OF WORK”

Students normally fulfill the humanities and arts degree requirement by completing two units of work consisting of five student-selected, thematically related courses or independent studies (each for 1/3 unit of credit) of increasing complexity. These courses culminate in the final 1/3 unit of independent study dealing with the theme running through the previous work. The theme of the Sufficiency project may derive from a single discipline or may draw upon ideas or use analytic tools from more than one humanities and arts discipline.

The faculty member advising the final independent study will certify that the student’s theme is consistent with previous work. Evaluation of this final independent study, which will be based on a research essay or on creative works or performance accompanied by analysis or participation in a seminar, will result in the final grade for the Sufficiency as a degree requirement. (See “Foreign Language Sufficiency” exception.) Students and faculty members should make clear at the outset of the final independent study what specific means of evaluation will be used for the culmination of the Sufficiency.

Advice and guidelines for the setting up of Sufficiency themes are available from department members as listed on pages 55 and 230. However, responsibility for the selection of specific courses leading to the final independent study rests ultimately with the student. Students are, therefore, urged to consult with a Humanities and Arts Department faculty member about possible final themes for the Sufficiency no later than the beginning of their third course in humanities and arts. Such early discussion of possible thematic topics enables students to plan effectively for additional work and strengthens greatly the cohesiveness of the final independent study.

A file (filed by advisor’s name) of all essays and portfolios accepted in completion of the Sufficiency in the previous academic year is available in the Humanities and Arts Department office. Students wishing to see what kinds of topics have been completed previously and how they relate to course work should examine examples of essays in areas of interest to them.

TRANSFER STUDENTS AND THE SUFFICIENCY REQUIREMENT

Transfer credit in the Humanities and Arts at WPI is granted on a course-for-course basis. All Transfer and 3-2 Program students entering WPI with *fewer than six courses or their equivalent of transfer credit in the Humanities and Arts* must complete thematically-related work in the Humanities and Arts, including a Sufficiency evaluation (#5 Independent Study/Project) to the extent that the overall Humanities and Arts credit totals two units.

No credit toward the Humanities and Arts requirement is given for introductory-level foreign-language courses unless the entire Sufficiency program is in that foreign language. Usually only one transfer course in Freshman English can be applied toward the Sufficiency requirement. In all cases, the Humanities and Arts Consultant who will serve as the advisor of the student’s #5 IS/P (“Sufficiency”) has the final decision on what courses are acceptable within the student’s Sufficiency sequence leading up to the project. Up to one unit (i.e. three courses) of transferred work in the Humanities and Arts that is not credited toward the Humanities and Arts Requirement can be credited toward the fifteen-unit graduation requirement; such courses shall receive credit under the category of EL 1000.

If a Transfer or 3-2 Program student *has completed two units of acceptable college-level work in the Humanities and Arts prior to entering WPI*, a Completion of Degree Requirement form will be submitted by the Humanities and

Arts Department Coordinator for Transfer Students at the request of the student. The grade for such a Humanities and Arts Requirement met by transfer credit is normally a B or C, but a student can request a grade of "CR". Students whose grades on transferred courses average A can submit samples of their course work and may be awarded an A for the Humanities and Arts Sufficiency Requirement. Alternately a transfer student may elect to undertake a #5 Sufficiency IS/P in an effort to achieve an A grade. These evaluation options must be exercised prior to the Department's submission of the Completion of Degree Requirement form to the Registrar.

Decisions concerning credit toward the Humanities and Arts requirement are made by the Humanities and Arts Coordinator for Transfer Students, Professor James Hanlan. He can be contacted in room 26 of Salisbury Laboratories, or at extension 5438, or email jphanlan@wpi.edu.

DEVELOPING A SUFFICIENCY PROGRAM IN HUMANITIES AND ARTS

The Humanities and Arts department offers most of its courses at the 1000-, 2000-, and 3000-level. Students are strongly encouraged to include one 1000-level course, two 2000-level courses, and one or more 3000-level courses in their program of *five* humanities and arts courses prior to their Sufficiency project term. Since the 1000-level courses may prove useful in developing a sense of what constitutes a *theme* in an area of the humanities or arts, the Department will accept two 1000-level courses toward the final Sufficiency project, as long as one of the courses involves material thematically related to that project. This progression through an area of study offers the student an opportunity to build an intellectual understanding of a subject while acquiring a cohesive broadening of knowledge that will lead to a challenging and rewarding Sufficiency program.

1000-Level Courses

Courses on this level introduce a discipline through exploration of available resources and research techniques, identification of critical issues, and examination of major themes, ideas, and interpretations.

2000-Level Courses

Courses on this level enhance both the knowledge and understanding of an area of study through concentration on specific themes, ideas, or approaches and refinement of expressive and analytic skills.

3000-Level Courses

Courses on this level, offered in a seminar format, focus on the application of those critical and analytical skills developed in lower-level courses, leading students to well defined Sufficiency project topics.

AREAS FOR THE SUFFICIENCY IN HUMANITIES AND ARTS

In developing the Sufficiency requirement (see the "Humanities and Arts Sufficiency" section, page 22), students will choose courses from traditional academic disciplines within the broad area of the humanities and arts at WPI. The Sufficiency program may be limited to courses in a single discipline, such as European history or English lit-

erature, or it may include more than one discipline and involve courses, for example, in the history, literature and philosophy of a particular period. In both cases, it is essential that a single "theme," derived from the various courses, be developed in the final Independent Study/Project (IS/P). Students are urged, before or during their third course in the sequence, to consult with a Humanities and Arts faculty member regarding their intended final IS/P.

Humanities and Arts Areas and Consultants

Topics	Project Advisor
Topics in American Studies	S. Bullock (SCB), J. Hanlan (JPH), K. Ljungquist (KPL), J. Manfra (JM), L. Menides (LJM), W. Mott (WTM), J. Trimbur (JOT), J. Zeugner (JFZ)
Topics in Art	M. D. Samson (MDS)
Topics in Drama/Theatre	D. O'Donnell (DMO), S. Vick (SV)
Topics in Foreign Language (German)	D. Dollenmayer (DZD)
Topics in Foreign Language (Other)	A. Rivera (AAR)
Topics in Foreign Language (Spanish)	H. J. Manzari (HJM), A. Rivera (AAR)
Topics in Global Studies	W. Addison (WAA), P. Hansen (PHH), J. Zeugner (JFZ)
Topics in History (American)	W. Baller (WXB), S. Bullock (SCB), D. Gray (DEG), J. Hanlan (JPH), J. Manfra (JM), J. Zeugner (JFZ)
Topics in History (European)	W. Addison (WAA), W. Baller (WXB), J. Forgeng (JLS), P. Hansen (PHH)
Topics in History (Science and Technology)	E. Parkinson (EMP), J. Forgeng (JLS), M. Sokal (MMS)
Topics in International Studies—Humanities (Interrelated)	B. Addison (WAA), P. Hansen (PHH), J. Zeugner (JFZ)
Topics in Literature (American)	T. Code (TWC), K. Ljungquist (KPL), L. Menides (LJM), W. Mott (WTM), J. Trimbur (JOT)
Topics in Literature (Contemporary)	J. Brattin (JYB), T. Code (TWC)
Topics in Literature (English)	M. Ephraim (MKE)
Topics in Music	F. Bianchi (FB), L. Curran (LJC), J. Delorey (JD2), R. Falco (RGF), D. Weeks (DGW)
Topics in Philosophy	R. Gottlieb (RSG), G. Lew (GKL), J. Sanbonmatsu (JS6)
Topics in Religion	R. Smith (RLS), T. Shannon (TAS)
Topics in Writing, Rhetoric, and Communications	J. Trimbur (JOT)

A descriptive listing of the humanities/arts disciplines follows.

AM—AMERICAN STUDIES

Students considering Sufficiencies in American Studies may begin with HU 1411, Introduction to American Studies, or may include that course early in their sequence. American Studies is an interdisciplinary Sufficiency program. Students should select courses from the areas of literature (EN), history (HI), philosophy (PY), religion (RE), art history and architecture (AR), and music (MU) and should, in the final Sufficiency project, investigate an American theme which derives from the courses selected.

AR—ART HISTORY/ARCHITECTURE

Students considering Sufficiencies in the history of art or architecture should begin with AR 1111, Introduction to Art History, or the 2000-level course offerings in modern art or architecture. Another WPI course relevant to an art Sufficiency is AR/ID 3150, Light, Vision, and Understanding, which relates painting to the history and philosophy of science. A variety of independent studies are also available. Students are encouraged to consider studio art courses and some of the more specific upper-level courses in the arts offered elsewhere in the Worcester Consortium, especially at Clark University and the College of the Holy Cross (catalogs available at Gordon Library).

EN—LITERATURE (INCLUDING DRAMA/THEATRE)

Students selecting Sufficiencies in literature may begin by selecting any of the 1000- or 2000-level EN courses. Subsequent courses may emphasize American or British literature, drama/theatre, fiction or poetry, or any mixture of these; or subsequent courses may seek to define themes involving any other humanities and arts disciplines. However, in every case students should consider with care how the first five courses are preparing them to define and develop a theme in their final Sufficiency independent study.

FOREIGN LANGUAGES

For a description of Sufficiencies in German, Spanish, and in other foreign languages, see page 58.

GS—GLOBAL STUDIES

Students considering Sufficiencies in Global Studies may begin with HI 1341 Introduction to Global History, or may include that course early in their sequence. Global Studies is an interdisciplinary Sufficiency program. Students should select courses from the areas of: literature (EN); foreign language, civilization and literature (SP, GN); history (HI); philosophy (PY); religion (RE); art history and architecture (AR); and music (MU). In the final Sufficiency project, they should investigate an issue from a global perspective that derives from the courses selected.

HI—HISTORY (INCLUDING HISTORY OF SCIENCE AND TECHNOLOGY)

Students selecting Sufficiencies in history may begin by taking any of the 1000- or 2000-level HI courses. Subsequent courses may emphasize history in the following categories: general, cultural, diplomatic, intellectual, psychological, social, science and technology, or any mixture of these. Subsequent courses may also seek to define themes involving any other humanities and arts discipline.

In any event, students should consider carefully how the five courses are preparing them to define and develop a theme in their final Sufficiency independent study.

HU—HUMANITIES

Courses in a variety of topics are listed under the general title of Humanities; many of these could be used in interdisciplinary Sufficiency themes or related to conventional disciplinary themes in several areas.

MU—MUSIC

Individual music courses are available to any interested WPI student, and private instruction is available in both voice and musical instruments. However, for those planning a Sufficiency in music (involving five courses and a final IS/P), a minimal level of music capability on the student's part is assumed.

For Sufficiency students, MU 1611 and MU 2611, Fundamentals of Music I and II (or the equivalent knowledge) should be completed early in students' musical course work. The Sufficiency's purpose is to acquaint students with the basic vocabulary of music (in Fundamentals); with aspects of music history (in the 2000 courses), and with areas of special interest, which might include performance work in ensembles or in private lessons, independent study (such as composition or theory, and computer music), or selected work at other Consortium institutions.

Also available to interested students are the following ensembles sponsored by the music faculty. Those listed here currently receive credit toward the music Sufficiency.

Choral	Men's Glee Club Women's Chorale Chamber Choir
Instrumental	Brass Ensemble Concert Band Jazz Band Stage Band Pep Band (football and basketball, athletic credit) Medwin String Ensemble Chamber Orchestra

There is no sequential significance to courses above 2000; however, students should select five courses (or three beyond Fundamentals I and II) which give meaningful sequential significance to their particular musical interests, with the final IS/P reflecting the realization of these goals.

PY AND RE—PHILOSOPHY AND RELIGION

Students can follow a sequence of courses concentrating on either philosophy or religion, though a coherent combination of philosophy and religion courses is also possible. Students doing a Sufficiency in philosophy or religion will normally take three courses below the 3000 level before pursuing more advanced courses at the 3000 level. Since each individual 3000-level course is offered every other year, students should plan early the advanced topics they wish to pursue in order to organize their sequences around the year(s) in which are offered the 3000-level courses of particular interest to them. In planning their Sufficiency sequences, students might find it constructive to take humanities and arts courses outside philosophy or religion that relate to the theme of their Sufficiency.

GETTING STARTED IN HUMANITIES AND ARTS

These are the “1000” or “2000” level courses from which most students select their first Humanities and Arts elective.

Art History and Architecture

AR 1111 Introduction to Art History

English

EN 1221 Introduction to Drama: Theatre on the Page
and on the Stage
EN 1222 Shakespeare in the Age of Elizabeth
EN 1231 American Literature: Beginnings Through
Hawthorne
EN 1242 Introduction to English Poetry
EN 1251 Introduction to Literature
EN 1257 Introduction to African American
Literature and Culture*
EN/WR 2211 Elements of Writing

Foreign Language

GN 1511, 1512 Elementary German I,II
GN 2511, 2512 Intermediate German I,II
SP 1523, 1524 Elementary Spanish I,II
SP 2521, 2522 Intermediate Spanish I,II

History

HI 1311 Introduction to American Urban History
HI 1312 Introduction to American Social History
HI 1313 Introduction to the Study of Foreign
Policy and Diplomatic History
HI 1314 Introduction to Early American History
HI 1321 Introduction to European Social History
HI 1322 Introduction to European Cultural History
HI 1331 Introduction to the History of Science
HI 1332 Introduction to the History of Technology
HI 1341 Introduction to Global History

Interdisciplinary

HU 1411 Introduction to American Studies*
HU 1412 Introduction to Asia

For International Students

IS 1811 Writing for Non-native Speakers of English
IS 1812 Speech for Non-native Speakers of English
IS 1813 American History for International
Students

Music

MU 1611 Fundamentals of Music I

Philosophy and Religion

PY/RE 1731 Introduction to Philosophy and
Religion

*Offered in alternate years.

PERFORMANCE SUFFICIENCY IN MUSIC

The final IS/P in music is available as a performance IS/P only with the written permission of a WPI faculty member in music. Such consent must be obtained before the beginning of the term in which the student is to perform. Performance Sufficiencies will be available only to students who can demonstrate an underlying knowledge of essential music theory and music history.

In addition to their performance, all students in a performance Sufficiency must submit a substantial essay that articulates how their academic knowledge of music was enhanced by the performance. The grade for the Sufficiency will be based on the level of both the performance recital and the essay.

PERFORMANCE SUFFICIENCY IN DRAMA/THEATRE

This type of project emerges when a student or a group of students initiate or take part in a production of a play, either as a part of the regularly scheduled Humanities and Arts Department productions, as a part of the MASQUE season of play productions, or in some alternative manner. In addition to the performance, each student must complete a substantial written document which reflects the performance work and demonstrates considerable knowledge of the area of expertise. Project advisors: Prof. S. Vick and Dean O'Donnell, Humanities and Arts.

The IGSD periodically cosponsors projects at the London Project Center or the Edinburgh International Festival Fringe in conjunction with the Department of Humanities and Arts. For more information on these opportunities, contact the Department of Humanities & Arts, Division of Drama/Theatre.

FOREIGN LANGUAGE SUFFICIENCY

Students who have taken some German or Spanish before coming to WPI should attend the foreign-language placement session during New Student Orientation to determine the appropriate level at which to begin the Sufficiency. Most students complete the Sufficiency in Foreign Language by passing six courses in the language. Students who can begin language study at WPI on or near the advanced level may complete the Sufficiency by writing a final IS/P in German or Spanish.

Students interested in a language other than German and Spanish can complete a Sufficiency in that language by taking courses offered by the Consortium. For further details see Prof. Dollenmayer, Alden Memorial 209.

FOREIGN LANGUAGE AND CIVILIZATION SUFFICIENCY

Students who wish to combine foreign language courses with other fields in the humanities and arts should note the following guidelines:

Students may supplement intermediate or advanced foreign language courses by completing their Sufficien-

cies in related humanities and arts fields that deal with the culture of that language and the countries where it is spoken. The final IS/P must be written in English. Note: Elementary courses in the foreign language do not count towards this Sufficiency.

For further details on foreign language courses and Sufficiencies, see Prof. Dollenmayer, Alden Memorial 209.

GUIDELINES FOR GRANTING TRANSFER CREDIT TO U.S. STUDENTS FOR FOREIGN LANGUAGE STUDY

A. Credit for study on the high school level:

1. Transfer credit of 1/3 unit is given for Advanced Placement with a score of 4 or 5.
2. Students with three or more years of foreign-language study in high school, but who have not taken the Advanced Placement examination in that language, may receive 1/3 unit credit for their high school language study upon satisfactory completion of two courses in the same language on the intermediate level or above. (Note: Courses in German and Spanish in addition to those offered at WPI, as well as courses in other languages, are available at other colleges in the Consortium.)
3. In either case 1. or 2. above, in order to receive 1/3 unit credit, students must begin their WPI course sequence at the Elementary II level or above.

B. Credit for study at other colleges and universities:

1. Language study which is done at other universities and colleges prior to entering WPI, or done with the prior written permission of the student's Humanities and Arts Consultant (not the Department Head) as part of an agreed-upon Sufficiency sequence, transfers on a course-for-course basis.
2. Language study which is done at foreign universities, language institutes, cultural institutes, etc., prior to entering WPI, or done with the prior written permission of the student's Humanities and Arts Consultant (not the Department Head) as part of an agreed-upon Sufficiency sequence, is assessed by the Foreign Languages Consultant on the basis of matriculation papers and the level or work accomplished.

GUIDELINES FOR GRANTING TRANSFER CREDIT TO INTERNATIONAL STUDENTS FOR FOREIGN LANGUAGE STUDY

In order to take full advantage of their opportunity to study in the U.S., international students whose native language is not English must fulfill their Sufficiency requirement through studies conducted in the English language. Therefore, no transfer credit toward the Sufficiency requirement is awarded automatically to such students for knowledge of languages other than English.

The above guidelines for U.S. students apply to international students whose native language is English.

SUFFICIENCY PROGRAM FOR HUMANITIES AND ARTS MAJORS

Students majoring in Humanities and Arts would normally fulfill the Sufficiency requirement in an engineering or science area. One of the primary responsibilities of the Humanities and Arts student will be to devise, with an advisor's help, a substantial program of scientific and technological studies leading to the completion of the Sufficiency requirement. Before developing their programs, students should have clearly in mind what career goals they wish to reach and should be prepared to schedule as many scientific courses as are needed to qualify them as literate in some area of technology. The minimum technological requirement for the student fulfilling the Sufficiency requirement by coursework is two units of study. Many career opportunities may demand more extensive preparation in technological disciplines, and students are strongly advised to take full advantage of WPI's resources in science, technology, and mathematics by pursuing the Sufficiency well beyond the minimum requirement.

Areas Available	Faculty Consultants
Biology and Biotechnology	J. Rulfs
Biomedical Engineering	C. Sotak
Chemical Engineering	R. Datta
Chemistry and Biochemistry	J. Dittami
Civil and Environmental Engineering	F. Hart
Computer Science	L. Becker
Electrical and Computer Engineering	F. Looft
Industrial Engineering	S. Johnson
Interdisciplinary Studies	R. Vaz
Mathematical Sciences	H. Walker
Mechanical Engineering	G. Tryggvason
Physics	T. Keil

SUFFICIENCY FOR INTERNATIONAL STUDENTS

In order to take full advantage of their opportunity to study in the United States, all international students whose native language is not English must fulfill their Sufficiency requirement through studies conducted in the English language. Exceptions to this policy may be made by the Consultant for Sufficiencies for International Students (CSIS), in the case of students who have had extensive educational experience in the English language, e.g., English-speaking secondary school. The actual sequence of courses should be determined with the advice of the Consultant for Sufficiencies for International Students. Two approaches are suggested:

BASIC SUFFICIENCY FOR INTERNATIONAL STUDENTS

Students whose command of the English language is not on the level of that of an undergraduate whose native language is English should begin their program by successfully completing IS 1811 (Writing for Non-native Speakers of English) and IS 1812 (Speech for Non-native Speakers of English). They may then choose three other courses in Art, English, History, Music, or Philosophy / Religion by arrangement with the Consultant (CSIS). Especially appropriate are the various Humanities Concepts courses

and IS 1813, American History for International Students. The final Sufficiency project may be done with any Department member who agrees to advise the topic.

THEMATIC SUFFICIENCY FOR INTERNATIONAL STUDENTS

Students who believe that their command of English is sufficient to begin work on the level of the undergraduate whose native language is English should, with the advice of the Consultant (CSIS), select a first course in an area of their likely interest for the final Sufficiency project. Students passing this first course should proceed through the regular Sufficiency sequence leading to a final project with any Department member who agrees to advise their work. If students do not pass this first course, and the instructor in consultation with the Consultant determines that inadequate proficiency in English was a factor, then such students should proceed through the basic Sufficiency for International students outlined above.

OTHER OPTIONS

SOCIAL SCIENCE COURSES

Humanities and Arts Sufficiency project advisors may allow students to include one social science course in their Sufficiency sequence on the basis of that course's suitability to the development of students' particular humanities themes.

Such a course must be more than "related to" or "in support of" a given theme. It must be at the interface of humanities (normally history) and blend in with certain Humanities and Arts courses. A course in American government, for example, could logically be included in any number of American history sequences.

The inclusion of a social science course in the Humanities and Arts Sufficiency of any student requires the *written* "advice and consent" of his or her Sufficiency project advisor *after* the theme has been determined and *before* the student registers for the course.

One of the following social science courses (and *no* other) may be included in the Humanities and Arts Sufficiency sequence:

SS 1301	U.S. Government
SS 1402	Introduction to Social Psychology
SS 2207	Creativity and the Scientific Community
SS 2208	The Society - Technology Debate

INTERDISCIPLINARY SUFFICIENCY AT THE AMERICAN ANTIQUARIAN SOCIETY

A unique opportunity for interdisciplinary work in the humanities and arts is offered by the American Studies Seminar sponsored each fall by the American Antiquarian Society. Organized in collaboration with Worcester's five undergraduate colleges and universities, this seminar focuses on topics that allow students to investigate the Society's rich holdings in early American history, literature, and culture. The Society's unparalleled collection of documents is a short walk from the campus. Information on application deadlines and academic credit toward this Sufficiency is available from the WPI Campus Representative to the American Antiquarian Society.

OFF-CAMPUS SUFFICIENCY OPTION

WPI offers the option to complete the Humanities and Arts Sufficiency Requirement during one term of study at several Project Centers. Normally, students complete the sufficiency requirement through at least six courses or independent-study projects on campus. However, the “Off-Campus Sufficiency” option allows students to combine at least three courses on campus with one term studying the humanities and arts at a Project Center. Since this one-term project is equivalent to three courses, students may use it to complete the sufficiency requirement.

Off-campus sufficiency projects are available in Spain and Germany for the study of foreign languages and in London for other fields. These off-campus sufficiency programs have a flexible format. Students devote themselves to one term studying the history, literature, language or culture at the project site with a WPI faculty advisor. The program might combine a thematic seminar in an area of the faculty advisor’s expertise with visits to museums, the theatre, musical performances, or cultural excursions. Although themes or areas of emphasis vary from year to year, all off-campus sufficiency projects culminate in a written report in an area of interest to the student.

To be eligible for this one-unit sufficiency project, students must have already completed three courses in humanities and arts before they leave campus. Students may apply to the off-campus sufficiency program before they have taken all three courses. However, students may not participate in the program unless they successfully complete one unit of work in humanities and arts before the term of the project. In addition, students going to any Project Center must complete all of the forms required by the Interdisciplinary and Global Studies Division.

Requirements:

- Students must have completed at least three courses in the Humanities and Arts at WPI, or have earned equivalent course credit approved by the Humanities and Arts Department, before the term of the off-campus sufficiency project. The Department may allow students to count transfer or advanced placement credits toward the three course minimum;
- Students must be accepted into the off-campus sufficiency program by the Humanities and Arts Department, and complete all forms required by the Interdisciplinary and Global Studies Division, in order to register for these projects.
- Students might be required by the faculty advisor to complete a PQP or attend required meetings before the off-campus project;
- Students must submit a written report or paper at the end of the project. Students also may be required to submit written updates at various times in the course of the project. In all cases, the faculty advisor at the project site will determine the precise form of the written requirements.
- Students may be required to give an oral presentation at the end of the project;

- Under normal circumstances, students must complete the project within one term in order to receive the full unit of credit;
- Only members of the Humanities and Arts faculty at WPI may advise off-campus Humanities and Arts sufficiency projects.

Recommendations

All off-campus sufficiency options benefit from advance planning. Discuss the possibility of an off-campus sufficiency with your academic advisor at the beginning of the freshman year. Consult with the WPI faculty who will advise these off-campus projects as early as possible, since they may be able to suggest useful courses or other background resources for the projects. Also keep in mind that three courses are the *minimum* required, but many students find it advantageous to take additional courses before going away.

The *interdisciplinary London sufficiency program* is open to students with a background in areas of the humanities and arts besides foreign languages, including art history and architecture, drama/theatre, history, literature, music, philosophy, religion, or writing/rhetoric. After taking at least three courses in any of these areas on campus, you could then go to London to complete your sufficiency project. Some students also have gone to London with this program to study beyond the sufficiency requirement for international studies, history, literature, music, theatre, or other areas.

WPI offers sufficiency programs in the *Spanish language at Madrid* and in the *German language at Darmstadt*. These programs require completion of foreign language courses through the level of intermediate II or above (2000-level or above) before going abroad. For students who have taken foreign language courses in high school, language placement exams are available during New Student Orientation. Some students with basic foreign language preparation have completed their arts projects in Spain or Germany. We welcome a creative approach to off-campus study.

More advanced students may participate these off-campus programs by doing work toward a minor or major. A student who had already completed their sufficiency requirement on campus, for example, might be able to work in the humanities and arts on an Independent Study Project that could count toward minors. Or a student at one of these sites could work on a Major Qualifying Project in fields such as Humanities and Arts, International Studies, or Technical, Scientific and Professional Communication.

The Humanities and Arts Department advertises upcoming project locations and application deadlines at the Global Opportunities Fair each September. Future project opportunities might include other foreign locations or projects that provide the context for an intensive study of humanistic themes associated with particular locales within the United States. Contact the Department of Humanities and Arts for more information.

Social science deals with the behavior of individuals and groups as well as the functioning of the economic and political systems and institutions that shape and control our lives. As such, it offers a perspective that is essential for anyone desiring a well-rounded education.

Therefore, WPI, in common with other colleges, requires some exposure to the social sciences for its graduates. In satisfying the two-course social science requirement, students are free to take courses in any of the traditional social sciences: economics, political science, sociology, psychology, and anthropology. The social science courses offered at WPI are grouped into two broad categories. The first consists of core courses that introduce students to the social sciences and help them understand the scope and limits of social science approaches and how they might be related to the design of Interactive Qualifying Projects. The second, more advanced, set of courses looks in depth at particular issues and problems, provid-

ing students with a more detailed understanding of social science disciplines and their use in social problem solving and interactive projects. The relationship between the core courses and the more advanced courses in specific areas is illustrated by means of the diagram on page 167.

To obtain maximum benefit from their study of social science, students should choose courses that will provide knowledge and skills relevant to their Interactive Qualifying Project. These courses should be taken prior to or concurrent with undertaking the IQP and should be selected, if possible, after the student has identified the general topic area in which his or her interactive project work will be done.

More information on the alternatives available and the factors that should be considered in choosing courses to satisfy the social science requirement are presented in the Social Science and Policy section of this catalog, page 159.

AWARDS AND PRIZES

Awards and prizes are determined by the academic department or by selected committees.

COLLEGE AWARDS

SALISBURY PRIZE AWARDS

These historic awards are made to 14 highly meritorious seniors. These awards were established by Stephen Salisbury, a WPI founder and former president of the Board of Trustees.

TWO TOWERS PRIZE

This prize is awarded to the student who, through general academic competence, campus leadership, regular course work and special work in research and projects, best exemplifies a combined proficiency in the theoretical and practical union implicit in the Two Towers concept, which is at the heart of WPI's Two Towers tradition.

SIGMA XI AWARDS IN ENGINEERING AND SCIENCE

These awards in engineering and science are given to the students and their advisors for the Major Qualifying Projects which are judged to be the best in originality, contribution to the field, professional competence, and for the most useful applications.

PRESIDENT'S IQP AWARDS

These awards are given to student teams whose conception, performance, and presentation of their Interactive Qualifying Projects have been judged outstanding in focusing on the relationships among science, technology, and the needs of society.

PROVOST'S MQP AWARDS

These awards offer recognition to those students who have completed outstanding Major Qualifying Projects as a demonstration of their competency in a chosen academic discipline. Each academic department conducts its own competition to select the winners.

UNITED TECHNOLOGIES CORPORATION MINORITY AWARD

This award is presented to an outstanding minority undergraduate student.

OUTSTANDING WOMEN STUDENT AWARDS

Marietta E. Anderson Award, an award which is presented to the most outstanding woman student in one of the three lower classes who not only has a superior academic record, but also has been a work-study student, participated in recognized extracurricular activities, and has been a volunteer for college-sponsored activities.

United Technologies Corporation and the Society of Women Engineers Award

This award is presented to an outstanding woman undergraduate student.

Funds from an anonymous donor provide the following awards to women students preparing for careers in engineering or science. Awards are based on academic excellence, contributions to the WPI community, and professional goals. The awards are named each year for women who have played significant roles at WPI.

Bonnie-Blanche Schoonover Award, honoring WPI's former librarian.

Ellen Knott Award, honoring a long-time secretary in the Mechanical Engineering Department.

Gertrude R. Rugg Award, honoring WPI's late Registrar Emerita.

WILMER L. AND MARGARET M. KRANICH PRIZE

Students who are seniors or completing their junior year will be nominated by faculty for the annual award. The award will go to a student majoring in engineering, science or management who best exemplifies excellence in the humanities and in the full integration of humanities into his/her undergraduate experience. Double-majors who fulfill one major in Humanities and Arts are not eligible.

SPECIAL AWARDS**ALPHA PHI OMEGA SERVICE AWARD****AMERICAN INSTITUTE OF CHEMISTS FOUNDATION**

Chemistry and Biochemistry

An award by the New England chapter of the American Institute of Chemists to honor outstanding *seniors majoring in chemistry and biochemistry*.

AMERICAN SOCIETY FOR METALS: CHESTER M. INMAN '14 OUTSTANDING STUDENT AWARD

Mechanical Engineering

The Worcester Chapter of the American Society for Metals presents \$200 to a student for excellence in a Major Qualifying Project dealing with processing or materials science.

HAROLD S. BLACK AWARD

Electrical and Computer Engineering

This award was established in 2001 to honor the memory of inventor Harold S. Black '21. The award is given by the faculty of the Electrical and Computer Engineering (ECE) Department to one or more ECE seniors who have demonstrated outstanding creativity and enthusiasm in engineering problem solving, practical implementation of problem solutions, and exemplary character in their contributions to the welfare of the WPI community.

CENTRAL NEW ENGLAND AIChE AWARD FOR SIGNIFICANT CONTRIBUTION

Chemical Engineering

This award is given to an individual in recognition of significant contributions to the American Institute of Chemical Engineers.

CLASS OF 1879 PRIZE FOR OUTSTANDING PROJECTS IN THE HUMANITIES

Humanities and Arts

This prize is awarded by the Humanities and Arts Department each year to three students for excellent work in Humanities and Arts Sufficiency projects. Sufficiencies must demonstrate exceptional creativity and skill in conceiving, developing and expressing a theme within any discipline in the humanities and arts.

COMMUNITY SERVICE AWARD PRESENTED IN THE MEMORY OF EDWIN B. COGLIN '23

Alumni Office

This award recognizes individuals who have demonstrated an extraordinary personal commitment above and beyond their normal involvement on campus in both academic and extracurricular activities.

COMPUTER SCIENCE OUTSTANDING SENIOR AWARD

Computer Science

This award is presented to one or more computer science seniors who have an outstanding record and who have contributed to the enrichment and professional development of fellow students.

JAMES F. DANIELLI AWARD

Biology and Biotechnology

This award, given by the Department of Biology & Biotechnology, honors the memory of Dr. James F. Danielli, a former department head and world-famous scholar.

FRANK D. DEFALCO AWARD

Civil and Environmental Engineering

Award to WPI undergraduate Civil Engineering students who has completed two and one half years towards a B.S., interested in career constructed facilities and a member of ASCE student chapter.

ETA KAPPA NU OUTSTANDING STUDENT AWARD

Electrical and Computer Engineering

The electrical and computer engineering honor society presents this award to the outstanding senior and junior in recognition of their academic achievement and their service to the WPI community.

GENERAL CHEMISTRY ACHIEVEMENT AWARD

Chemistry and Biochemistry

This award is given to the student who has completed the *freshman* chemistry course with superior academic performance. Department award.

ALLAN GLAZER AWARD

Mechanical Engineering

Established in 1992 by the family and friends of Allan Glazer '47, this award is given to a junior majoring in mechanical engineering who has demonstrated outstanding academic achievement, special ingenuity in problem solving, and enthusiasm for engineering challenges.

GOAT'S HEAD AWARD FOR OUTSTANDING CONTRIBUTION TO THE STUDENT GOVERNMENT ASSOCIATION

Student Government Association

THE ROBERT H. GODDARD AWARD

Physics

Established by the classes of 1908 and 1909 as a memorial to Dr. Goddard, this prize is awarded for outstanding achievement, scholarship, consistent effort and dedication of purpose in both theoretical and experimental areas of physics.

HEALD BROTHERS SCHOLARSHIP*Mechanical Engineering*

This scholarship identifies and supports outstanding young men and women who represent, in modern form, the spirit of "Yankee Ingenuity" that characterizes the evolution of the great manufacturing enterprises from the beginnings of the American Industrial Revolution.

ANDREW HOLT MEMORIAL AWARD*Civil and Environmental Engineering*

This award is presented to a civil engineering senior who has consistently earned academic honors and who shows excellent promise for success.

STEVEN J. KAHN AWARD*Humanities and Arts*

This award is presented to the outstanding senior in the WPI Glee Club in recognition of his contribution, commitment, and unwavering loyalty to the organization.

THE WILLARD ELLIOT LAWTON-SAMUEL**JAMES PLIMPTON AWARD***Physics*

Established in honor of Professors Lawton and Plimpton, this award is presented to a student who has shown improvement in scholarship, not only in grades but also in depth of understanding.

LINCOLN ARC WELDING FOUNDATION AWARD*Civil and Environmental Engineering*

This award recognizes outstanding achievement in solving design, engineering, fabrication, and research problems.

THE ALFRED R. AND JANET H. POTVIN AWARD*Biomedical Engineering*

Separate awards are given to the outstanding undergraduate and graduate student in Biomedical Engineering in recognition of their academic performance and their service to WPI and/or the outside community.

MANAGEMENT EXCELLENCE AWARD*Management*

This award is given to one or more seniors who have demonstrated ability in courses and projects and who exhibits outstanding promise of future success in the field of management engineering.

CARL F. MEYER IMPROVEMENT AWARD IN CIVIL ENGINEERING*Civil and Environmental Engineering*

Established by Professor Emeritus Meyer, this award is presented to the civil engineering senior who has demonstrated the most improvement in academic and professional attitude since entering the department.

RICHARD V. OLSON AWARD*Mathematical Sciences*

Established to honor the memory of mathematics Professor Richard V. Olson, this annual award to a WPI sophomore recognizes outstanding performance in basic mathematics courses.

EDWARD C. PERRY AWARD*Mechanical Engineering*

This award is given annually to an engineering student or students for an outstanding major qualifying project in the area of mechanical design. The award is made possible through a bequest from Miriam Perry Goll and honors the memory of her father, Edward C. Perry '04, a design engineer with General Electric Company throughout his professional career.

PI TAU SIGMA AWARD FOR EXCELLENCE*Mechanical Engineering*

The mechanical engineering honor society, Pi Tau Sigma, presents this award to the outstanding junior mechanical engineering student.

SENIOR MATHEMATICAL SCIENCES MAJOR AWARD*Mathematical Sciences*

This award is presented to the senior mathematical sciences major who has shown outstanding performance and who has made valuable contributions to the WPI mathematical community.

SOCIETY OF MANUFACTURING ENGINEERING SCHOLARS AWARD*ME/Manufacturing Engineering Program*

An MFE senior, recommended by the MFE faculty and confirmed by the officers of SME chapter 25, who has demonstrated excellent scholarship, leadership, service, potential to contribute to the profession of Manufacturing Engineering.

The award includes scholarship assistance (\$900) for full-time study if the winner enrolls in WPI's graduate MFE program.

SOCIETY OF MANUFACTURING ENGINEERING UNDERGRADUATE SCHOLARSHIP AWARD*ME/Manufacturing Engineering Program*

Awarded to a 1st, 2nd, or 3rd year MFE major, recommended by the MFE faculty and confirmed by the officers of SME chapter 25, who has demonstrated excellent scholarship, commitment, and contribution to the Manufacturing Engineering program at WPI.

SOCIETY OF MANUFACTURING ENGINEERS OUTSTANDING STUDENT AWARD*ME/Manufacturing Engineering Program*

The top three MFE majors each year, regardless of year, who have not already received the award.

SOCIETY OF MANUFACTURING ENGINEERS MQP AWARD*ME/Manufacturing Engineering Program*

An MFE major, selected by a panel of practicing manufacturing engineers to have the best MQP in the area of Manufacturing Engineering.

JON CALVERT STRAUSS AWARD FOR EXCELLENCE IN COMPUTER SCIENCE

Computer Science

This award is presented to a computer science junior who has an excellent academic record and who shows promise for continuing success.

STUDENT-ALUMNI INTERACTION AWARD

Alumni Office

This award is presented by the WPI Alumni Association in recognition of individuals who, through their involvement on campus, have facilitated the continuing development of interaction between students and alumni.

Recipients are full-time undergraduate students who have demonstrated extraordinary personal commitment to WPI and the Alumni Association above and beyond the normal involvement on campus.

The award is designed to recognize students who have stepped forward to become leaders in the alumni and student communities and, in doing so, have benefited both WPI students and alumni in a unique and purposeful way.

CHARLES O. THOMPSON SCHOLARS

Academic Advising

Named in honor of the first president of WPI, this honor recognizes outstanding performance by first-year students.

To be eligible for membership, students must receive all A's and B's, with a minimum of six A's, in their academic subjects during the first three terms at WPI. Selections are made in Term D.

ACS UNDERGRADUATE AWARD IN ANALYTICAL CHEMISTRY

Chemistry and Biochemistry

Award which is intended to encourage student interest in analytical chemistry and to recognize a student who displays an aptitude for a career in the field. *This award is for third-year students.*

WALL STREET JOURNAL AWARD

Management

The Wall Street Journal presents this award to a senior with an outstanding record of achievement.

DEPARTMENT AND PROGRAM DESCRIPTIONS

Air Force Aerospace Studies	66
Biology and Biotechnology	67
Biomedical Engineering	71
Chemical Engineering	79
Chemistry and Biochemistry	83
Civil and Environmental Engineering	88
Computer Science	94
Computer Science Minor	99
Electrical and Computer Engineering	100
Minor in Computer Engineering	110
Engineering Science Courses	111
Engineering Physics	111
Environmental Programs	111
Fire Protection Engineering	113
Humanities and Arts	114
Minor in Foreign Language (GN or SP)	117
Minor in Music	117
Minor in Writing and Rhetoric	118
Industrial Engineering	118
Interdisciplinary Programs	118
Teacher Licensing	119
International Studies	119
Law and Technology minor	121
Management	122
Entrepreneurship Minor	130
Management Minor	131
Management Information Systems Minor	131
Organizational Leadership Minor	131
Manufacturing Engineering	132
Minor in Manufacturing Engineering	134
Materials Engineering	135
Minor in Materials	135
Mathematical Sciences	136
Statistics Minor	143
Mathematics Minor	143
Mechanical Engineering	144
Military Science	150
Physical Education	152
Physics	153
Physics Minor	157
Pre-Law Programs	158
Pre-MBA Program (Dual Degree)	158
Pre-Medical, Pre-Dental and Pre-Veterinary Programs	158
Social Science and Policy Studies	159

S E C T I O N

two

AIR FORCE AEROSPACE STUDIES

LTC EDWARD N. IRELAND, HEAD

PROFESSOR: Lt. Col. E. N. Ireland

ASSISTANT PROFESSOR: Capt. J. Maki

INTRODUCTION

The Air Force Reserve Officer Training Corps (AFROTC) program offered at WPI is designed to provide a college student the opportunity to become an Air Force commissioned officer while completing requirements for an undergraduate or graduate degree. Enrollment is voluntary and open to young men and women who are U. S. citizens of good moral character and sound physical condition who seek the challenge of being an officer in the U. S. Air Force upon graduation from college. In addition to WPI students, students at any of the **Worcester Consortium for Higher Education** institutions are also eligible to apply for Air Force ROTC at WPI.

MISSION AND EDUCATIONAL OBJECTIVES

Mission: The mission of AFROTC is to produce leaders for the Air Force and build better citizens for America. Its vision is to be "a highly successful organization, respected throughout the Air Force, the educational community and the nation".

Educational Objectives:

Students who successfully complete the AFROTC program will have:

1. An understanding of the fundamental concepts and principles of Air and Space.
2. A basic understanding of associated professional knowledge.
3. A strong sense of personal integrity, honor, and individual responsibility.
4. An appreciation of the requirements for national security.

AIR FORCE ROTC PROGRAMS

There are two traditional routes to an Air Force commission through Air Force ROTC. Entering students may enroll in the Air Force Four-Year Program. Students with at least two academic years remaining in college may apply for the Two-Year Program. However, there are opportunities for Freshmen, Sophomores, Juniors, in some cases Seniors and Graduate Students, please check with the AFROTC Detachment Staff for these special circumstances.

FOUR-YEAR PROGRAM

The more popular and preferred program is the traditional Four-Year Program. To enroll, simply register for Air Force Aerospace Studies in the fall term of the freshman year in the same manner as other college courses. There is **NO MILITARY OBLIGATION** for the first two years of Air Force ROTC unless you have an Air Force ROTC scholarship.

The first two years are known as the General Military Course (GMC). Classes meet one hour per week and are required for freshmen and sophomores.

Individuals who successfully complete the GMC compete nationwide for entry into the Professional Officers Course (POC). POC classes meet three hours per week and are required for all juniors and seniors. Officer Candidates enrolled in the POC and on scholarship receive a nontaxable subsistence allowance of up to \$400 each month. POC who are not on scholarship are eligible to receive a POC tuition assistance incentive of \$3000 a year.

Qualified Officer candidates will attend the Air Force ROTC field-training program for four weeks between their sophomore and junior years.

TWO-YEAR PROGRAM

The Two-Year Program is available for college students with two years of undergraduate or graduate study remaining. Applicants must apply for the program no later than the beginning of Term C (spring semester) preceding those two final years. The applicant will take the Air Force Officer Qualifying Test, will be given a physical examination at no expense, and will meet a selection board.

Applicants for the Two-Year Program will attend the Air Force ROTC field training for five weeks instead of four at an Air Force base prior to their entry into the Professional Officer Course (POC). Like their four year counterparts, they are paid while at field training and will receive travel pay to and from the Air Force base hosting field training. Students accepted into the Two-Year Program will complete the Professional Officer Course as described above.

SCHOLARSHIP OPPORTUNITIES

By participating in Air Force ROTC, students may compete for Air Force scholarships ranging from two years to three years in duration. Full scholarships cover tuition, most fees, and a textbook allowance. Partial scholarships are also available which contribute up to 80% of fees and tuition, in addition to a textbook allowance. A tax-free subsistence allowance of \$250 to \$400 is paid to all scholarship students each academic month.

Entering freshmen may compete for an Air Force ROTC Four-Year Scholarship during their senior year in high school (deadline Dec. 1 of their high school senior year). Details of this program can be obtained by e-mailing afrotc@wpi.edu, by writing: Department of Aerospace Studies, WPI, 100 Institute Rd., Worcester MA 01609-2280, or through most high school counseling offices.

OTHER ASPECTS OF THE AFROTC PROGRAM

Leadership Laboratory:

Air Force ROTC officer candidates participate in a Leadership Laboratory (LLAB) where the leadership skills and management theories acquired in the classroom are put into practice. The LLAB meets once each week for approximately two hours for GMC with one additional hour for POC.

This formal military training is largely planned and directed by the officer candidates. The freshmen and sophomores are involved in such initial leadership experiences as Air Force customs and courtesies; squadron and flight drill movements; Air Force educational benefits; Air Force career opportunities; and preparation for field training.

The juniors and seniors are involved in more advanced leadership experiences as they become more responsible for the planning and organizing of wing activities, to include conducting the Leadership Laboratory itself.

Field Training:

Field Training is, in most cases, an officer candidate's first exposure to a working Air Force environment. The summer program is designed to develop military leadership, discipline, and to provide Air Force officer orientation and motivation. At the same time, the Air Force can evaluate each student's potential as an officer. Field training includes aircraft and aircrew orientation, Air Force professional development orientation, marksmanship training, officer training, physical fitness, and survival training. Uniforms, lodging, and meals are provided at no cost to the cadet, and travel at Air Force expense is authorized by air or privately owned vehicle to and from the individual's home of record or school. Additionally, after applicable deductions, cadets receive pay of about \$500 for the four-week encampment and about \$625 for the five-week summer camp.

Arnold Air Society:

Each officer candidate can elect to be part of a national society dedicated to conducting service related events for the Air Force and local community. These Arnold Air Society members are involved in a myriad of service projects to include charity works, service to the poor, work with local orphanages, and similar activities. Twice a year, members participate in conventions/conclaves held in various cities and attended by members from all the schools in the country sponsoring AFROTC. Membership is by nomination after completion of a one semester, project-oriented pledge program.

Civil Air Patrol:

All Air Force ROTC officer candidates at AFROTC Detachment 340 have the opportunity to become members of the Civil Air Patrol and to receive up to 8 flight orientation rides on Civil Air Patrol aircraft at Worcester Airport.

Introductory Flight Training:

The Introductory Flight Training (IFT) is a program made available to pilot candidates after the summer of their junior year. This program is designed to give flying experience to those individuals who do not possess a private pilot license. The purpose of this program is to increase the success rate of officers entering Joint Specialized undergraduate Pilot Training (JSUPT). Pilot candidates will receive ground school and 50 hours of flying time from a flight instruction program operating in accordance with Federal Aviation Regulations. At the completion of the program the student will have the opportunity to receive a private pilot license.

Base Visits:

Air Force ROTC officer candidates have the opportunity to visit Air Force bases for firsthand observation of the operating Air Force. These trips are frequently made on weekends or scheduled to coincide with school vacation periods. Officer candidates may be flown by military aircraft to an Air Force base where they spend the day, remain on base overnight, and return to campus the following day.

Other Benefits:

The Air Force provides all Air Force ROTC uniforms and textbooks for on-campus programs and field training. All officer candidates who have received an Air Force scholarship or are enrolled in the Professional Officer Course (POC) may travel free on military aircraft on a space-available basis.

Additional Information:

In addition to formal activities, the Cadet Wing plans and organizes a full schedule of social events throughout the academic year. These include a Dining-In, Military Ball, a Field Day, and intramural sports activities. Professional Development Training Programs, such as Parachute Freefall and Glider Instruction, are also available to selected volunteer officer candidates during the summer

BIOLOGY AND BIOTECHNOLOGY

J. RULFS, HEAD

PROFESSORS: D. S. Adams, J. C. Bagshaw,
R. D. Cheetham, J. Miller, P. J. Weathers

ASSOCIATE PROFESSORS: T. C. Crusberg,
S. M. Politz, J. Rulfs

ASSISTANT PROFESSORS: D. G. Gibson III, E. Ryder,
J. A. Tyler

AFFILIATE PROFESSORS: A. Di Iorio

ADJUNCT ASSISTANT PROFESSOR/SENIOR LAB

INSTRUCTOR: J. Whitefleet-Smith

ADJUNCT ASSISTANT PROFESSOR/LAB

INSTRUCTOR: M. Buckholt

INTRODUCTION

Undergraduates majoring in Biology and Biotechnology have the opportunity to gain extensive knowledge of the scientific basis of biological investigation ranging from biological macromolecules, through genes and cells, to organisms and their interactions with the environment. Students also choose experiences in hands-on laboratory and field techniques in aspects of modern biology, including cell and molecular biology, bioprocess, recombinant DNA methods, microbiology, physiology, and environmental biology. Opportunities also exist to pursue practical exposure to methods of computational biology, including bioinformatics and simulation modeling. Students who major in biology and biotechnology will be uniquely qualified for positions in academic, industrial or governmental research facilities, or for further studies in graduate or professional (medical, dental, veterinary) schools.

MISSION STATEMENT

The Department of Biology and Biotechnology will make scholarly scientific and technological advances that will address the changing needs of society. We will prepare well educated scientists able to approach problems with creativity and flexibility. A key element in this preparation is active participation in the process of scientific discovery.

EDUCATIONAL OBJECTIVES

The educational objectives of the Department of Biology and Biotechnology are to prepare students to function as scientists and educators in a broad array of biological disciplines. We recognize that the well educated scientist needs facility in technology and skill in critical thinking to function effectively in the professional arena as well as in the global community.

EDUCATIONAL OUTCOMES

Students graduating with a Bachelor of Science degree from the Department of Biology and Biotechnology:

- have mastered a broad range of basic lab skills applicable to biology and biotechnology.
- have mastered applied research skills at an advanced level in at least one area of biology and biotechnology.
- know and understand a broad range of basic biological concepts, and can apply and analyze these in at least one speciality area.
- are able to generate hypotheses, design approaches to test them, and interpret the data from those tests to reach valid conclusions.
- have developed the ability to place their own work in a broader scientific context.
- have developed oral and written communication skills relevant to professional positions in biology and biotechnology.
- can find, read and critically evaluate the original scientific literature.
- possess skills necessary for life-long professional learning.
- can function effectively as members of a team.
- demonstrate adherence to accepted standards of professional and ethical behavior.

BIOLOGY AND BIOTECHNOLOGY

Biology, simply stated, is the study of living organisms. Biotechnology is broadly defined as the use of organisms and their components for the manufacture or modification of products, the alteration of animals and plants, and the adaptation of microorganisms to specific tasks. Biotechnology is as old as winemaking, farming, and animal husbandry and as new as methods of DNA recombination. In the modern context, biotechnology is further defined as the use of technological research tools in deciphering questions about living organisms, and the application of engineering principles and methods to these questions.

Students may choose to pursue a generalist degree in biology and biotechnology, or to structure their academic programs within any of five concentrations: bioprocess, cell and molecular biology and genetics, computational biology, ecology and environmental biology, or organismal biology. These concentrations provide not only guidelines for course choices within the department, but also include educational opportunities that cross academic disciplines.

UNDERGRADUATE RESEARCH PROJECTS

The biology and biotechnology facilities offer an exceptional learning opportunity since research in an active laboratory group is the principal teaching tool. Tools for modern biochemistry, molecular biology, tissue culture, fermentation, ecology, microscopy and computer integration are all available to undergraduates.

In conjunction with the faculty, students who wish to expand their educational opportunities pursue many off-campus projects each year. Investigations may take place at institutions that have traditionally worked with WPI, such as the University of Massachusetts Medical School, the Worcester Biotechnology Research Park, Tufts University School of Veterinary Medicine, Woods Hole Marine Biological Laboratories, and the Massachusetts Audubon Society. The department also has established links with several companies that provide opportunities for project work and summer employment in applied biology and biotechnology.

Undergraduate research projects may be proposed by individual students or groups of students, or may be selected from on-going research activities of the faculty. The departmental faculty must be consulted for approval of a project before student work begins.

BASIC CURRICULUM

Programs within the department provide a broad base of scientific information and experience with in-depth laboratory study in personally selected areas of biology and biotechnology. With your faculty advisor, you will plan your own unique program, which will include a variety of course work and research experiences.

A modern biologist also needs exposure to other sciences and mathematics in order to process experimental data, solve problems, and understand the chemical and physical rules under which biological systems operate. Students may select general chemistry, organic chemistry, biochemistry, physics, calculus or statistics to round out their scientific education.

GUIDELINES FOR SELECTION OF BB COURSES

Introductory survey courses are numbered at the 1000-level. Courses at the 2000-level introduce basic concepts in a defined area. Advanced subjects taught mostly from texts are at the 3000-level, and courses at the 4000-level are taught using mostly the original scientific literature.

Program Distribution Requirements for the Biology and Biotechnology Major

BIOLOGY and BIOTECHNOLOGY	Minimum Units
1. Mathematical Science, Physics, Computer Science, Engineering	2
2. Chemistry	5/3
3. BB 1000/2000-level	4/3
4. BB Laboratory Fundamentals (see Note 1)	1/3
5. Other Laboratory Experience (see Note 2)	2/3
6. BB 3000/4000-level (see Note 3)	5/3
7. Related Courses (see Note 4)	4/3
8. MQP	1

NOTES:

1. Chosen from among 1000- and 2000-level options, currently BB 2940 and BB 2950.
2. Chosen from among BB 3000/4000 Laboratories or from Laboratory Experience List for all Concentrations.
3. In certain cases 500-level courses are appropriate for undergraduate credit with explicit permission of the Instructor.
4. Chosen from among the Related Courses Lists for all Concentrations.

BIOLOGY and BIOTECHNOLOGY WITH CONCENTRATIONS (note 1)	Minimum Units
1. Mathematical Science, Physics, Computer Science, Engineering	2
2. Chemistry	5/3
3. BB 1000/2000-level	4/3
4. BB Laboratory Fundamentals (see Note 2)	1/3
5. Other Laboratory Experience (see Note 3)	2/3
6. BB 3000/4000-level (see Note 4)	5/3
7. Related Courses (see Note 5)	4/3
8. MQP (see Note 6)	1

NOTES:

1. Students pursuing a Concentration must fulfill all requirements for that Concentration. Specific rules and course lists for each Concentration follow. No course may count in more than one category, including university and departmental distribution requirements.
2. Chosen from among 1000- and 2000-level options, currently BB 2940 and BB 2950.
3. Chosen from among BB 3000/4000 Laboratories or from Laboratory Experience List. Appropriate courses are suggested for each Concentration.
4. Of these 5/3 Units, 2/3 must come from the appropriate approved Concentration List. In certain cases 500-level courses are appropriate for undergraduate credit with explicit permission of the instructor.
5. Chosen from among courses specified within each concentration's Related Courses List.
6. Must be approved by the MQP advisor of record as appropriate for the Concentration.

APPROVED COURSES FOR THE CONCENTRATION IN BIOPROCESS

OTHER LABORATORY EXPERIENCE

Students concentrating in Bioprocess MUST choose at least 2/3 Units of Laboratory-oriented coursework. These courses may be chosen from any combination of Biology and Biotechnology 3000- or 4000-level courses and Approved "Other Laboratory Options" below.

Suggested Courses:

BB 3513 Cell Culture Techniques for Animal Cells
 BB 3516 Separation Techniques in Biotechnology
 BB 3517 Fermentation
 BB 3519 Protein Purification

Other Laboratory Options:

BB 3511 Nerve and Muscle Physiology
 BB 3512 Molecular Genetics Lab
 BB 3514 Circulatory and Respiratory Physiology
 BB 3518 Molecular Biology
 BB 3520 Recombinant DNA Technology
 BE 562 Small Animal Surgery
 CE 4060 Environmental Engineering Laboratory
 CE 4061 Hydrology
 CH 4150 Experimental Biochemistry
 GE 2341 Geology

BB 3000/4000-LEVEL

Students concentrating in Bioprocess MUST choose 5/3 Units of course work in Biology and Biotechnology at the 3000 or 4000 level. At least 2/3 Units MUST come from the Approved Courses below.

BB 3055 Microbial Physiology
 BB 4008 Cell Culture Theory and Applications
 BB 4070 Separation of Biological Molecules (not available for credit in addition to BB560)
 BB 505 Fermentation Biology
 BB 509 Scale-up of Bioprocessing
 BB 560 Separation of Biological Molecules (not available for credit in addition to BB4070)

RELATED COURSES

Students concentrating in Bioprocess must choose AT LEAST 1/3 Unit in Chemistry from the list below, but MAY NOT COUNT more than 2/3 Units in Chemistry toward this Concentration requirement. Remaining Units must be selected from "Other Courses" below:

Chemistry

CH 3510 Chemical Thermodynamics
 CH 4110 Biochemistry I
 CH 4120 Biochemistry II

Other Courses

CM 2011 Chemical Engineering Fundamentals
 CM 2013 Applied Chemical Engineering Fundamentals
 CS 1001 Introduction to Computers
 CS 1005 Introduction to Programming
 CS 2005 Data Structures and Programming Techniques
 ES 3002 Mass Transfer

**APPROVED COURSES FOR THE
CONCENTRATION IN CELL AND
MOLECULAR BIOLOGY AND GENETICS****OTHER LABORATORY EXPERIENCE**

Students concentrating in Cell and Molecular Biology and Genetics MUST choose at least 2/3 Units of Laboratory-oriented coursework. These courses may be chosen from any combination of Biology and Biotechnology 3000- or 4000-level courses and Approved "Other Laboratory Options" below.

Suggested Courses:

BB 3512 Molecular Genetics Lab
 BB 3513 Cell Culture Techniques for Animal Cells
 BB 3516 Separation Techniques in Biotechnology
 BB 3518 Molecular Biology Lab
 BB 3519 Protein Purification
 BB 3520 Recombinant DNA Technology
 CH 4150 Experimental Biochemistry
Other Laboratory Options:
 BB 3511 Nerve and Muscle Physiology
 BB 3514 Circulatory and Respiratory Physiology
 BB 3517 Fermentation
 BE 562 Small Animal Surgery
 CE 4060 Environmental Engineering Laboratory
 CE 4061 Hydrology
 GE 2341 Geology

BB 3000/4000-LEVEL

Students concentrating in Cell and Molecular Biology and Genetics must choose 5/3 Units of course work in Biology and Biotechnology at the 3000 or 4000 level. At least 2/3 Units MUST come from the Approved Courses below.

BB 3055 Microbial Physiology
 BB 3080 Neurobiology
 BB 3620 Developmental Biology
 BB 3920 Immunology
 BB 4008 Cell Culture Theory and Applications
 BB 4010 Advanced Molecular Genetics
 BB 4065 Virology
 BB 4550 Advanced Cell Biology
 BB 4910 Molecular Biology
 BB 4955 Recombinant DNA

RELATED COURSES

Students concentrating in Cell and Molecular Biology and Genetics must choose at least 2/3 Units in Chemistry from the list below. Remaining Units may be selected either from Chemistry options below, or from "Other Courses" below.

Chemistry

CH 2330 Organic III
 CH 4110 Biochemistry I
 CH 4120 Biochemistry II
 CH 4150 Experimental Biochemistry
 CH 4160 Membrane Biophysics
 CH 4910 Regulation of Gene Expression

Other Courses

BB 3055 Microbial Physiology
 BB 3080 Neurobiology
 BB 3620 Developmental Biology
 BB 3920 Immunology
 BB 4008 Cell Culture Theory and Applications
 BB 4010 Advanced Molecular Genetics
 BB 4065 Virology
 BB 4550 Advanced Cell Biology
 BB 4910 Molecular Biology
 BB 4955 Recombinant DNA

**APPROVED COURSES FOR THE
CONCENTRATION IN COMPUTATIONAL
BIOLOGY****OTHER LABORATORY EXPERIENCE**

Students concentrating in Computational Biology MUST choose at least 2/3 Units of Laboratory-oriented coursework. These courses may be chosen from any combination of Biology and Biotechnology 3000- or 4000-level courses and Approved "Other Laboratory Options" below.

Suggested Courses:

BB 3511 Nerve and Muscle Physiology
 BB 3512 Molecular Genetics Lab
 BB 3514 Circulatory and Respiratory Physiology
 BB 3518 Molecular Biology Lab
 BB 3520 Recombinant DNA Technology
 CE 4061 Hydrology

Other Laboratory Options:

BB 3513 Cell Culture Techniques for Animal Cells
 BB 3516 Separation Techniques in Biotechnology
 BB 3517 Fermentation
 BB 3519 Protein Purification
 BE 562 Small Animal Surgery
 CE 4060 Environmental Engineering Laboratory
 CH 4150 Experimental Biochemistry
 GE 2341 Geology

BB 3000/4000-LEVEL

Students concentrating in Computational Biology must choose 5/3 Units of course work in Biology and Biotechnology at the 3000 or 4000 level. At least 2/3 Units MUST come from the Approved Courses below:

BB 3020 Computational Biology
 BB 3040 Experimental Design and Data Analysis
 BB 4440 Bioinformatics
 BB 542 Ecological Simulation

RELATED COURSES

Students concentrating in Computational Biology must choose at least 4/3 Units from among "Approved Courses" below:

Approved Courses

BB 3020 Computational Biology
 BB 3040 Experimental Design and Data Analysis
 BB 4440 Bioinformatics
 BB 542 Ecological Simulation
 CH 4130 Biochemistry III
 CS 2005 Data Structures and Programming Techniques
 CS 2022/
 MA 2201 Discrete Mathematics
 CS 2135 Programming Language Concepts
 CS 2136 Paradigms of Computation
 CS 2223 Algorithms
 CS 3041 Human-Computer Interaction
 CS 4032 Numerical Methods for Linear and Nonlinear Systems
 CS 4120 Analysis of Algorithms
 MA 2051 Ordinary Differential Equations
 MA 2271 Graph Theory
 MA 2273 Combinatorics
 MA 2431 Mathematical Modeling with ODE
 MA 2621 Probability for Applications
 MA 2631 Probability
 MA 3231 Linear Programming
 MA 3233 Discrete Optimization

APPROVED COURSES FOR THE CONCENTRATION IN ECOLOGY AND ENVIRONMENTAL BIOLOGY

OTHER LABORATORY EXPERIENCE

Students concentrating in Ecology and Environmental Biology MUST choose at least 2/3 Units of Laboratory-oriented coursework. These courses may be chosen from any combination of Biology and Biotechnology 3000- or 4000-level courses and Approved "Other Laboratory Options" below.

Suggested Courses:

BB 3511 Nerve and Muscle Physiology
BB 3514 Circulatory and Respiratory Physiology
BE 562 Small Animal Surgery
CE 4060 Environmental Engineering Laboratory
CE 4061 Hydrology
GE 2341 Geology

Other Laboratory Options:

BB 3512 Molecular Genetics Lab
BB 3513 Cell Culture Techniques for Animal Cells
BB 3516 Separation Techniques in Biotechnology
BB 3517 Fermentation
BB 3518 Molecular Biology Lab
BB 3519 Protein Purification
BB 3520 Recombinant DNA Technology
CH 4150 Experimental Biochemistry

BB 3000/4000-LEVEL

Students concentrating in Ecology and Environmental Biology must choose 5/3 Units of course work in Biology and Biotechnology at the 3000 or 4000 level. At least 2/3 Units MUST come from the Approved Courses below.

BB 3055 Microbial Physiology
BB 3110 Animal Physiology
BB 3120 Plant Physiology and Cell Culture
BB 3140 Evolution: Pattern and Process
BB 3160 Behavioral Ecology
BB 4140 Ecological Management
BB 4150 Population and Community Ecology
BB 542 Ecological Simulation

RELATED COURSES

Students concentrating in Ecology and Environmental Biology must choose 3/3 Units in Science and Engineering and 1/3 Unit in Humanities and Social Sciences from the list below.

Science and Engineering:

BB 3055 Microbial Physiology
BB 3110 Animal Physiology
BB 3120 Plant Physiology and Cell Culture
BB 3140 Evolution: Pattern and Process
BB 3160 Behavioral Ecology
BB 4140 Ecological Management
BB 4150 Population and Community Ecology
BB 542 Ecological Simulation
CE 3059 Environmental Engineering
CE 3061 Waste Water Treatment
CE 3070 Urban and Environmental Planning
CE 3074 Environmental Analysis
CE 4071 Land Use Development and Controls

Humanities and Social Sciences:

EN 3231 New England Supernaturalism
PY 2717 Philosophy and the Environment
SS 2117 Environmental Economics
SS 2311 Legal Regulation of the Environment
SS 2312 International Environmental Policy
SS 2405 The Psychological Study of Environmental Issues

APPROVED COURSES FOR THE CONCENTRATION IN ORGANISMAL BIOLOGY

OTHER LABORATORY EXPERIENCE

Students concentrating in Organismal Biology MUST choose at least 2/3 Units of Laboratory-oriented coursework. These courses may be chosen from any combination of Biology and Biotechnology 3000- or 4000-level courses and Approved "Other Laboratory Options" below.

Suggested Courses:

BB 3511 Nerve and Muscle Physiology
BB 3513 Cell Culture Techniques for Animal Cells
BB 3514 Circulatory and Respiratory Physiology
BB 3517 Fermentation
BE 562 Small Animal Surgery
CH 4150 Experimental Biochemistry

Other Laboratory Options:

BB 3512 Molecular Genetics Lab
BB 3516 Separation Techniques for Biotechnology
BB 3518 Molecular Biology
BB 3519 Protein Purification
BB 3520 Recombinant DNA Technology
CE 4060 Environmental Engineering Laboratory
CE 4061 Hydrology
GE 2341 Geology

BB 3000/4000-LEVEL

Students concentrating in Organismal Biology must choose 5/3 Units of course work in Biology and Biotechnology at the 3000 or 4000 level. At least 2/3 Units MUST come from the Approved Courses below:

BB 3080 Neurobiology
BB 3110 Animal Physiology
BB 3120 Plant Physiology and Cell Culture
BB 3140 Evolution: Pattern and Process
BB 3170 Plant Morphology and Development
BB 3620 Developmental Biology

RELATED COURSES

Students concentrating in Organismal Biology must choose at least 2/3 Units in Biology and Biotechnology from the list below. Remaining Units may be selected from additional Biology and Biotechnology below, or from "Other Courses" below:

Biology and Biotechnology:

BB 3055 Microbial Physiology
BB 3080 Neurobiology
BB 3110 Animal Physiology
BB 3120 Plant Physiology and Cell Culture
BB 3140 Evolution
BB 3160 Behavioral Ecology
BB 3170 Plant Morphology and Development
BB 3620 Developmental Biology
BB 3920 Immunology
BB 4008 Cell Culture Theory and Applications
BB 4065 Virology

Other Courses:

BE 562 Small Animal Surgery
BE 3110 Experimental Physiology
BE 4541 Biological Systems
CH 4110 Biochemistry I
CH 4120 Biochemistry II
SS 1401 Cognitive Psychology

BIOMEDICAL ENGINEERING

C. H. SOTAK, HEAD

Primary BE Faculty

PROFESSORS: R. A. Peura, C. H. Sotak

ASSOCIATE PROFESSOR: Y. Mendelson

ASSISTANT PROFESSORS: K. L. Billiar, G. D. Pins,

R. D. Shonat

RESEARCH ASSISTANT PROFESSOR: K. G. Helmer

Collaborative BE Faculty

PROFESSORS: D. Cyganski, W. W. Durgin,

A. H. Hoffman, F. J. Looft, R. Ludwig, J. A. Orr,

P. C. Pedersen, B. J. Sivilonis, J. M. Sullivan, D. Tang

ASSOCIATE PROFESSORS: H. Ault, S. Shivkumar

ASSISTANT PROFESSORS: T. A. Camesano,

E. A. Clancy, N. A. Whitmal

MISSION STATEMENT

The Biomedical Engineering Department prepares students for rewarding careers in the health care industry or professional programs in biomedical research or medicine.

EDUCATIONAL OBJECTIVES

The educational objectives of the Biomedical Engineering Department are to prepare professionals who possess fundamental knowledge of engineering and basic science and can apply these principles to solve problems in biology and medicine. Through a project-oriented curriculum, which closely embraces the WPI educational philosophy, we prepare students to engage in a lifetime of professionalism and learning.

EDUCATIONAL OUTCOMES

The Biomedical Engineering Department has established 13 educational outcomes in support of our department objectives. Accordingly, students graduating from the Biomedical Engineering Department will demonstrate:

1. An ability to apply knowledge of advanced mathematics (including differential equations and statistics), science, and engineering to solve the problems at the interface of engineering and biology (**general criterion 3a and program criteria**).
2. An ability to design and conduct experiments, as well as to analyze and interpret data from living and non-living systems (**general criterion 3b and program criteria**).
3. An ability to design a system, component, or process to meet desired needs (**general criterion 3c**).
4. An ability to function on multi-disciplinary teams (**general criterion 3d**).
5. An ability to identify, formulate, and solve engineering problems (**general criterion 3e**).
6. An understanding of professional and ethical responsibilities (**general criterion 3f**).
7. An ability to communicate effectively (**general criterion 3g**).

8. The broad education necessary to understand the impact of engineering solutions in a global and societal context (**general criterion 3h**).
9. A recognition of the need for, and an ability to engage in life-long learning (**general criterion 3i**).
10. A knowledge of contemporary issues (**general criterion 3j**).
11. An ability to use the techniques, skills, and modern engineering tools necessary for engineering practice (**general criterion 3k**).
12. An understanding of biology and physiology (**program criteria**).
13. An ability to address the problems associated with the interaction between living and non-living materials and systems (**program criteria**).

Note: The general and specific program criteria indicated above in parenthesis meet the requirements for Biomedical Engineering accreditation by ABET (the Accreditation Board for Engineering and Technology).

Biomedical engineering is the application of engineering principles to the solution of problems in biology and medicine for the enhancement of health care. Students choose this field in order:

- to be of service to people;
- to work with living systems; and
- to apply advanced technology to the complex problems of medicine.

Biomedical Engineers may be called upon to design instruments and devices, to integrate knowledge from many sources in order to develop new procedures, or to pursue research in order to acquire knowledge needed to solve problems. The major culminates in a Major Qualifying Project, which requires that each student apply his or her engineering background to a suitable biomedical problem, generally in association with the University of Massachusetts Medical School, Tufts University School of Veterinary Medicine, one of the local hospitals, or a medical device company.

Each student's program will be developed individually with an advisor to follow the Biomedical Engineering program chart. WPI requirements applicable to all students must also be met. See page 22.

Biomedical Engineering is characterized by the following types of activity in the field:

1. Uncovering new knowledge in areas of biological science and medical practice by applying engineering methods;
2. Studying and solving medical and biological problems through analytical techniques in engineering;
3. Designing and developing patient-related instrumentation, biosensors, prostheses, biocompatible materials, and diagnostic and therapeutic devices; and bioengineered tissues and organs;
4. Analyzing, designing, and implementing improved health-care delivery systems and apparatus in order to improve patient care and reduce health-care costs in contexts ranging from individual doctors' offices to advanced clinical diagnostic and therapeutic centers.

The modeling of biological systems is an example of applying engineering analytical techniques to better understand the dynamic function of biological systems. The body has a complex feedback control system with multiple subsystems that interact with each other. The application of modeling, computer simulation, and control theory provides insights into the function of these bodily processes.

Recently, there has been increased emphasis on the application of the biomedical engineering principles embodied in the third and fourth areas listed above. Examples of the third area include:

- designing and developing tissues and organs;
- development of implantable biomaterials;
- design of an implantable power source;
- design of transducers to monitor the heart's performance;
- development of electronic circuitry to control the system;
- bench and field testing of devices in animals;
- application of new technology to patients.

The fourth area involves closer contact with the patient and health-care delivery system. This area is commonly referred to as Clinical Engineering. The engineer in the clinical environment normally has responsibility for the medical instrumentation and equipment including:

- writing procurement specifications in consultation with medical and hospital staff;
- inspecting equipment for safe operation and conformance with specifications;
- training medical personnel in proper use of equipment;
- testing within hospital for electrical safety; and
- adaptation of instrumentation to specific applications.

Biomedical engineering projects are available in WPI's Salisbury and Higgins Laboratories as well as at the affiliated institutions previously listed.

COMBINED B.S./MASTER'S DEGREE PROGRAM

This program affords an opportunity for outstanding WPI undergraduate students to earn both a B.S. degree and a master's degree in biomedical engineering concurrently, and in less time than would typically be required to earn each degree separately. The principal advantage of this program is that it allows for certain courses to be counted towards both degree requirements, thereby reducing total class time. With careful planning and motivation, the Combined Program typically allows a student to complete requirements for both degrees with only one additional year of full-time study (five years total). However, because a student must still satisfy all graduate degree requirements, the actual time spent in the program may be longer than five years. There are two degree options for students in the Combined Program: a thesis-based master of science (B.S./M.S.) option and a non-thesis master of engineering (B.S./M.E.) option.

Program Distribution Requirements for the Biomedical Engineering Major

The normal period of residency at WPI is 16 terms. In addition to the WPI requirements applicable to all students (see page 22), a biomedical engineer needs a solid background in mathematics, physical and life sciences. The distribution requirements are satisfied as follows:

BIOMEDICAL ENGINEERING	Minimum Units
1. Mathematics (See Note 1)	2
2. Basic Science (See Note 2)	2
3. Supplemental Science and Engineering (See Note 3)	2/3
4. Laboratory experience with living systems (See Note 4)	1/3
5. Biomedical Engineering and Engineering (See Note 5)	4 1/3
6. MQP (See Note 6)	1

NOTES:

1. Mathematics must include differential and integral calculus, differential equations and statistics.
2. Two courses from each of the following areas: BB, CH and PH.
3. Two courses from BB, CH or PH.
4. Experimental Physiology (BE 3110) or equivalent.
5. Thirteen courses from Biomedical Engineering (BE) or Engineering (CE, CM, EE, ES, or ME) with the following distribution: (1) seven courses from Biomedical Engineering or Engineering as specified in the WPI Catalog "Courses Qualifying for Engineering Department Areas", one of which must be an engineering design course; (2) four courses from Biomedical Engineering or Engineering at the 3000-level or above; (3) two courses in Biomedical Engineering at the 4000-level or above. A minimum of eight of the thirteen courses must be from Biomedical Engineering, not including BE 3110.
6. Must include 1/3 unit Capstone Design Experience.

Preparation for Medical, Dental, or Veterinary Schools

Students who wish to prepare for medical, dental, or veterinary school can choose any of the BME specialization areas listed above. These students should select courses that deal with basic science and the principles of engineering; however, special requirements for medical school must be met within the confines of those specialization areas. These include:

SUPPLEMENTAL SCIENCE COURSES:

Since a full year of general chemistry and physics is required, students must take one additional course in both chemistry and physics (preferably CH 1030 and PH 1140) in addition to the two in each area (CH 1010, CH 1020, PH 1110, and PH 1120) required by the BE program.

FREE ELECTIVES:

Because of the requirement of three organic chemistry courses (with labs), it is recommended that students use their two free electives for two (CH 2310 and CH 2320) of the three courses. The third course (CH 2360) would be taken outside of the BE program requirements.

Students should consult the Pre-Health Center, in addition to their BME advisor, for current information about course requirements for admission into medical or veterinary school.

BIOMEDICAL ENGINEERING PROGRAM CHART

	FRESHMAN/SOPHOMORE	JUNIOR	SENIOR
COURSE RECOMMENDATIONS	<p>Mathematics (6 courses) MA 1021 (Calculus I) MA 1024 (Calculus IV) MA 1022 (Calculus II) MA 2051 (Differential Equations) MA 1023 (Calculus III) MA 2611 (Statistics)</p> <p>Biology (2 courses) BB 2550 (Cell Biology) BB 3102 (Physiology: Transport and Maintenance)</p> <p>Chemistry (2 courses) CH 1010 (Molecularity) CH 1020 (Forces and Bonding)</p> <p>Physics (2 courses) PH 1110 (Physics I) PH 1120 (Physics II)</p> <p>Supplemental Science (2 courses) Pick 2 from BB, CH, or PH (See suggested courses from specialization areas listed below)</p> <p>BioMed. Eng. (select 3 courses) BE 1001 (Intro. to Bio. Med. Eng.) BE 2204 (Bioelectric Foundations) BE 2504 (Foundations in Biomechanics) BE 2604 (Foundations in Biol. Transport)</p> <p>H&A Sufficiency (2 Units) Social Science Physical Education</p>	<p>IQP</p> <p>BioMed. Eng. (2 courses) BE 3300 (BME Design) BE 3110 (Exp. Physiol.)</p>	<p>MQP</p>
	<p>Social Science</p> <p>Free Electives</p> <p>Physical Education</p> <p>From the biomedical engineering specialization areas listed below, select nine (9) courses from BME or other engineering disciplines (four of these courses must be at the 3000-level or above, and must include two BME courses at the 4000-level or above).</p>		
	Note: The total minimum number of BME courses, not including BE 3110, is eight (8)		
DEGREE REQUIREMENTS	H&A Sufficiency (2 units)		
		IQP (1 unit)	
	Math/Science (4 units)		
	Supplemental Science (2/3 Unit)		
			MQP (1 unit)
		Biomedical and other Engineering Topics (13/3 Units)	
		BE 3110 Living Systems Lab (1/3 Unit)	
		Social Science (2/3 Units)	
	Free Electives (2/3 Unit)		
	Physical Education (1/3 Units)		

BIOMEDICAL ENGINEERING SPECIALIZATION AREAS

The field of Biomedical Engineering (BME) has a number of subdivisions, or specializations, that are briefly described below. Preferred course listings are given in order to help students plan their program of study in consultation with their academic advisor.

BIOMATERIALS

Students combine biology and physiology coursework with interests in materials science and engineering to understand the development, processing and performance testing of biomaterials used in medical devices. Typical MQP topics include: development of collagen-based biomaterials for orthopedic and applications and tissue engineering, evaluation of surgical adhesives, shape memory polymers in staples, fracture fixation devices and stents, investigation of the effects of sterilization on UHMWPE and growth of hydroxyapatite on collagen.

Supplemental Science (Select two courses)

Preferred choices include:

BB 2940 – Experimental Biology
BB 3101 – Human Physiology: Movement and Communication
CH 2310 – Organic Chemistry I
CH 4110 – Biochemistry I
CH 4550 – Polymer Chemistry

Engineering (Select nine courses)

Select three fundamental engineering courses; preferred choices include:

ES 2001 – Introduction to Materials Science
ES 2501 – Introduction to Static Systems
ES 2502 – Stress Analysis
ES 2503 – Introduction to Dynamic Systems

Select two 3000-level (or higher) engineering courses; preferred choices include:

ES 3001 – Introduction to Thermodynamics
ME 3501 – Continuum Mechanics
ME 3502 – Advanced Mechanics of Materials
ME 4821 – Chemistry, Properties and Processing of Plastics

Select four 3000- and/or 4000-level BE courses; preferred choices include

[Note #2]:

BE/ME 4504 – Biomechanics
BE/ME 4814 – Biological Materials
BE 4828 – Biomaterials-Tissue Interactions
BE/ME 550 – Tissue Engineering

Note #2: At least two of the BE courses must be at the 4000-level or above. Graduate-level courses can substitute for 4000-level courses.

BIOMECHANICS

Students apply biology and physiology coursework with continuum mechanics, biomechanics and thermofluids to understand the mechanical properties of tissues such as bones and blood vessels in both healthy and diseased states. Interactions between tissues and medical devices (e.g. orthopedic, dental) are also characterized. Typical MQP topics include: soft tissue mechanics, flow in blood vessels, joint kinematics, medical device design, sports biomechanics and rehabilitation.

Supplemental Science (Select two courses)

Preferred choices include:

BB 2940 – Experimental Biology
BB 3101 – Human Physiology: Movement and Communication
CH 2310 – Organic Chemistry I
CH 4110 – Biochemistry I
CH 4550 – Polymer Chemistry

Engineering (Select nine courses)

Select three fundamental engineering courses; preferred choices include:

ES 2001 – Introduction to Materials Science
ES 2501 – Introduction to Static Systems
ES 2502 – Stress Analysis
ES 2503 – Introduction to Dynamic Systems

Select two 3000-level (or higher) engineering courses; preferred choices include:

ES 3001 – Introduction to Thermodynamics
ES 3004 – Fluid Mechanics
ME 3310 – Dynamics of Mechanisms and Machines
ME 3501 – Continuum Mechanics
ME 3502 – Advanced Mechanics of Materials
ME 3506 – Rehabilitation Engineering

Select four 3000- and/or 4000-level BE courses; preferred choices include

[Note #2]:

BE/ME 4504 – Biomechanics
BE/ME 4606 – Biofluids
BE/ME 4814 – Biological Materials
BE/ME 552 – Tissue Mechanics
BE/ME 550 – Tissue Engineering

Note #2: At least two of the BE courses must be at the 4000-level or above. Graduate-level courses can substitute for 4000-level courses.

BIOMEDICAL ENGINEERING SPECIALIZATION AREAS

BIOMEDICAL IMAGING

Courses are available to support the development of a student's interest in biomedical imaging, including image acquisition and processing. Students blend the disciplines of physics, chemistry, mathematics, biology, computer science, and engineering according to their individual interests. Typical MQP activities include: imaging instrumentation development, image processing and analysis, diagnosis and testing. Departmental imaging facilities and computer and software support are available.

Supplemental Science (Select two courses)

Preferred choices include:

- BB 3101 – Human Physiology: Movement and Communication
- CH 1030 – Chemistry III (Equilibrium)
- CH 4110 – Biochemistry
- PH 1130 – Introduction to 20th Century Physics
- PH 1140 – Oscillations and Waves
- PH 2501 – Photonics
- PH 2601 – Photonics Laboratory

Engineering (Select nine courses)

Select three fundamental engineering courses; preferred choices include:

- EE 2011 – Introduction to Electrical and Computer Engineering
- EE 2111 – Physical Principles of ECE Applications
- EE 2112 – Electromagnetic Fields
- EE 2311 – Continuous-Time Signal and System Analysis
- ES 2011 – Introduction to Nuclear Technology

Select two 3000-level (or higher) engineering courses; preferred choices include:

- EE 3113 – Introduction to RF Circuit Design
- EE 3204 – Microelectronic Circuits II
- ME 4922 – Theory and Practice of Laser Instrumentation

Select four 3000- and/or 4000-level BE courses; preferred choices include

[Note #2]:

- BE 3011 – Bioinstrumentation and Biosensors
- BE 4011 – Biomedical Signal Analysis
- BE 4201 – Biomedical Imaging
- BE 4541 – Biological Systems
- BE 581 – Medical Imaging Systems
- BE 582 – Principles of In Vivo Nuclear Magnetic Resonance Imaging

Note #2: At least two of the BE courses must be at the 4000-level or above. Graduate-level courses can substitute for 4000-level courses.

BIOMEDICAL SENSORS AND INSTRUMENTATION

Students select courses to develop their ability concerning the principles, applications, and design of biomedical sensors and instrumentation systems. Students should select courses, which deal with basic science, the principles of electrical engineering, biology and physiology, signal analysis, and engineering design. Typical MQP projects include: biopotential instrumentation systems, optical sensors, noninvasive blood analyte measurements, and biological measurement systems.

Supplemental Science (Select two courses)

Preferred courses include:

- BB 2940 – Experimental Biology
- BB 3101 – Human Physiology: Movement and Communication
- PH 1130 – Introduction to 20th Century Physics
- PH 1140 – Oscillations & Waves
- PH 2501 – Photonics

Engineering (Select nine courses)

Select three fundamental ECE courses; preferred choices include:

- EE 2011 – Introduction to Electrical and Computer Engineering
- EE 2022 – Introduction to Digital Circuits & Computer Engineering
- EE 2111 – Physical Principles of ECE Application
- EE 2201 – Microelectronic Circuits I
- EE 2311 – Continuous-Time Signal & System Analysis
- EE 2312 – Discrete-Time Signal & System Analysis
- EE 2799 – Electrical & Computer Engineering Design

Select two 3000-level (or higher) engineering courses; preferred choices include:

- ES 3011 – Control Engineering
- EE 3204 – Microelectronic Circuits II
- EE 3801 – Advanced Logic Design

Select four 3000- and/or 4000-level BE courses; preferred choices include

[Note #2]:

- BE 3011 – Bioinstrumentation and Biosensors (Bioinstrumentation I)
- BE 4011 – Biological Signal Analysis
- BE 4023 – Biomedical Instrumentation I
- BE 4025 – Biomedical Instrumentation II
- BE 4541 – Biological Systems

Note #2: At least two of the BE courses must be at the 4000-level or above. Graduate-level courses can substitute for 4000-level courses.

BIOMEDICAL ENGINEERING SPECIALIZATION AREAS

TISSUE ENGINEERING

Students combine cell biology and physiology coursework with interests in biomaterials, biomechanics or biotransport phenomena to understand the structural, mechanical and biological processes associated with designing and developing living systems to repair or replace damaged tissues or organs. Typical MQP topics include: designing and testing polymer scaffolds, measuring cellular function on scaffolds and designing bioreactors to grow constructs to repair tissues such as tendon, ligament, cartilage, skin and bone.

Supplemental Science (Select two courses)

Preferred choices include:

BB 2940 – Experimental Biology
 BB 3101 – Human Physiology: Movement and Communication
 CH 2310 – Organic Chemistry I
 CH 4110 – Biochemistry I
 CH 4550 – Polymer Chemistry

Engineering (Select nine courses)

Select three fundamental engineering courses; preferred choices include:

ES 2001 – Introduction to Materials Science
 ES 2501 – Introduction to Static Systems
 ES 2502 – Stress Analysis
 ES 2503 – Introduction to Dynamic Systems

Select two 3000-level (or higher) engineering courses; preferred choices include:

ES 3002 – Mass Transfer
 ES 3003 – Heat Transfer
 ES 3004 – Fluid Mechanics
 ME 3502 – Advanced Mechanics of Materials
 ME 4821 – Chemistry, Properties and Processing of Plastics

Select four 3000- and/or 4000-level BE courses; preferred choices include

[Note #2]:

BE/ME 4606 – Biofluids
 BE/ME 4814 – Biological Materials
 BE 4828 – Biomaterials-Tissue Interactions
 BE/ME 550 – Tissue Engineering

Note #2: At least two of the BE courses must be at the 4000-level or above. Graduate-level courses can substitute for 4000-level courses.

PROJECT/RESEARCH AREAS

BIOMATERIALS/TISSUE ENGINEERING

Research focused on understanding the interactions between cells and precisely bioengineered scaffolds that modulate cellular functions such as adhesion, migration, proliferation, differentiation and extracellular matrix remodeling. Understanding cell-matrix interactions that regulate wound healing and tissue remodeling will be used to improve the design of tissue engineered analogs for the repair of soft and hard tissue injuries. Research areas include: 1) studies investigating the roles of micro-fabricated scaffolds on keratinocyte function for tissue engineering of skin 2) development of tissue scaffolds that mimic the microstructural organization and mechanical responsiveness of native tissues 3) development of microfabricated cell culture systems to understand how extracellular matrix molecules regulate epithelial cell growth and differentiation.

SOFT TISSUE BIOMECHANICS/ TISSUE ENGINEERING

Research focused on understanding the growth and development of connective tissues and on the influence of mechanical stimulation on cells in native and engineered three-dimensional constructs. Research areas include: 1) micromechanical characterization of tissues, 2) constitutive modeling, 3) creation of bioartificial tissues in vitro, and 4) the effects of mechanical stimulation on the functional properties of cells and tissues.

BIOMEDICAL SENSORS AND BIOINSTRUMENTATION

The development of integrated biomedical sensors for invasive and noninvasive blood gas and glucose monitoring. Design and in vivo evaluation of reflective pulse oximeter sensors. Microcomputer-based medical instrumentation, fiber-optic sensors for medical instrumentation, application of optics to biomedicine, physiological signal processing.

The development and testing of various invasive and noninvasive biosensors and associated bioinstrumentation. Noninvasive optical sensors for measuring glucose in diabetic individuals, urea in hemodialysis dialysate, other biochemical analytes, as well as reagentless chemistry measurements are being developed.

IN-VIVO OPTICAL IMAGING

Research directed at revealing and understanding fundamental physiologic mechanisms using optical imaging techniques in mouse models. Fluorescence, phosphorescence, absorption, and spectral imaging techniques are employed to probe cellular and physiologic events. Research areas include: 1) metabolic function and oxygenation in the brain; 2) role of oxygen in diabetic retinopathy; 3) physiologic studies in inbred, transgenic, and knockout mouse models; 4) 3-D in-vivo imaging in neural tissues; 5) spectral imaging of neural tissues during functional activation.

NUCLEAR MAGNETIC RESONANCE IMAGING AND SPECTROSCOPY

Research projects in nuclear magnetic resonance (NMR) imaging and spectroscopy stress experimental aspects of NMR and their application in both medical and non-biological areas. Major biological research projects include: (1) development of metabolite imaging and spectroscopy techniques for use in the evaluation of treatment of cancer; (2) development of NMR imaging methods to delineate the "area of risk" following stroke and assess potential therapeutic intervention; and (3) development of non-invasive methods for measuring tissue blood flow, as well as tumor oxygenation, to evaluate the response of neoplasms to radiotherapy and chemotherapy.

BACTERIAL ADHESION TO BIOMATERIALS

The mechanisms governing bacterial adhesion to teeth, contact lenses, and implanted or transdermal devices are poorly understood at this time. However, it is known that the presence of a biofilm on a biomaterial surface will lead to infection and cause an implanted device to fail. Often, removal of the device is the only option since microbes attached to a surface are highly resistant to antibiotics. Research in the laboratory is aimed at characterizing bacterial interaction forces and adhesion to biomaterials, using novel techniques to probe bacterial-surface interactions, in order to design materials that are resistant to microbial colonization.

BIOMECHANICS

Research involving the relationship between the applied stress and the response on neurons located in soft tissues as well as investigation in biotransport phenomena is being conducted at the University of Massachusetts Medical School. Flow-patterns at arterial stenosis are being investigated, and the influence of arteriosclerosis on vasculative and dynamic aortic compliance. Modeling gas transport during high frequency ventilation. Heat and mass transfer in biological systems (and thermodynamic modeling). Evaluation of osteoarthritis and osteoporosis models. Elasticity and continuum mechanics measurements of tissues and their interface with engineered biomaterials as well as biofluid and biosolid interaction.

MEDICAL IMAGING

Contrast agents for nuclear medicine. Dose reduction using new detectors. Development of new detection devices for diagnostic radiology and nuclear medicine. Characterization of image intensifiers, radiation dosimetry. Tomographic image reconstruction; scatter and attenuation correction; restoration filtering; image segmentation.

SENSORY AND PHYSIOLOGIC SIGNAL PROCESSING

Application of signal processing, mathematical modeling and other electrical and computer engineering skills to the study of issues related to human sensation and physiology. Major areas of focus are vision, hearing, tactile reception, and electromyography (EMG). In the area of vision research, digitally produced pulse code modulated patterns that evoke multicolor sensations from black and white and monochromatic flicker patterns have been pro-

duced. Hearing research is concentrating on improved signal processing in hearing aid devices to improve speech perception by the hearing impaired. The purpose of the tactile receptor studies is to develop an understanding of the stimulus encoder characteristics of tactile mechanoreceptors. In the area of EMG (the electrical activity of skeletal muscle), improvements to the detection and interpretation of EMG for such uses as the control of powered prosthetic limbs and musculoskeletal modeling are continuing.

SPECTROSCOPIC MEASUREMENT OF BLOOD AND TISSUE CHEMISTRY

Applications of optical spectroscopy for the noninvasive measurement of blood and tissue chemistry, ultimately to be able to perform chemical analysis and diagnosis without removing a sample from the patient. Currently investigating the use of near infrared spectroscopy in combination with in-vivo chemometric techniques to determine tissue pH, blood hematocrit and electrolyte concentration. Also interested in the application of this technology in the triage and treatment of trauma patients and diagnosis of vulnerable plaque.

TISSUE ENGINEERING

The Center for Tissue Engineering at UMMS focuses on the generation of tissues for clinical applications. Tissues studied include cartilage, bone, tendon, fascia, skin, spinal cord, liver, and pancreas. Of specific interest is mechanical stimulation of cells and mechanisms of mechanotransduction. Particular attention is focused on determining structure-property relationships in engineered tissues.

ULTRASOUND MEASUREMENTS

Applications under current investigation include detection of arteriosclerotic plaque and skin examination, for evaluating injuries, burns, and skin cancer. Several new research projects deal with the generation and application of coherent swept frequency signals for quantifying the medium (such as tissues) that is being examined. Doppler ultrasound is used for detection of motion, and the clinical applications include blood flow imaging and fetal heart rate monitoring. A Doppler project dealing with the detection of blood clots in the leg, a condition called deep vein thrombosis, is presently being carried out.

TEACHING LABORATORIES/FACILITIES

The following facilities are maintained by the Department of Biomedical Engineering to support teaching and project activities.

Bioinstrumentation and Biosignals Laboratory (SL 311)

This teaching laboratory provides the necessary equipment and supplies for the computer-based acquisition and processing of biological signals. It supports the laboratory component of our undergraduate (BE 1001, BE 2204, BE 3011, and BE 4011) and graduate-level (BE 523, BE 525, and BE 551) biomedical engineering courses in bioinstrumentation, biosensors, and bioelectric signals and is also available for project activities and graduate-level research. The laboratory is equipped with digital multimeters, waveform generators, power sup-

plies, oscilloscopes, and the necessary accessories, electronic components, and data books for effective and productive hardware project development.

Biomechanical Engineering Laboratories (Higgins First Floor) *Maintained in cooperation with Mechanical Engineering*
This laboratory complex provides experimental and computational facilities for the laboratory component of BME courses (BE 3101, BE/ME 4504, BE/ME 4606, and BE/ME 552), Major Qualifying Projects, and graduate research. Faculty associated with these facilities include Allen H. Hoffman, (ME, Lab Director), Brian J. Sivilonis (ME), and Holly K. Ault (ME).

Included in this complex are the following individual laboratories:

Biomechanics/Biofluids Laboratory (Higgins First Floor) provides experimental facilities in the areas of biomechanics and biofluids. The laboratory has equipment for measuring force, deformation, and kinematic variables as well as fluid flow, pressure, and velocity. The laboratory contains PC-based computational and data acquisition facilities.

Rehabilitation Engineering Laboratory (Higgins First Floor) provides experimental facilities for the design, development, and testing of electro-mechanical assistive devices. The Assistive Technology Resource Center is part of this laboratory.

Computing and Imaging Facility (SL 412)

This computing facility, maintained by the College Computer Center (CCC), contains network attached PC-based personal computers for use by BME students and the general WPI community. In addition, the facility houses computer-based imaging hardware and software to support our undergraduate- (BE 4011, BE 4201) and graduate-level (BE 551) biomedical engineering courses and projects in biomedical imaging and biomedical signal processing. Multimedia support for most types of traditional and electronic presentations and demonstrations is also available in this facility through the Instructional Media Center (IMC).

MQP/Projects Laboratory (SL 415)

Because project work is a significant component of a WPI education, the department maintains a dedicated laboratory for Major Qualifying Projects (MQPs), Interactive Qualifying Projects (IQPs), and independent projects. The facility contains network-attached PC-based personal computers, computer-based data acquisition systems, general electronic testing equipment, biomechanical and biomaterial testing equipment, and other common laboratory equipment and supplies with which to complete MQPs, IQPs, and independent projects.

Physiology Teaching Facility (SL 313, SL 319)

This teaching facility supports our undergraduate- (BE 3110) and graduate-level (BE 562) biomedical engineering courses in experimental physiology and small animal surgery. The laboratory and associated animal holding quarters, contains all the necessary equipment and supplies for anesthesia, surgery, and physiologic manipulation in small animals.

CHEMICAL ENGINEERING

R. DATTA, HEAD

PROFESSORS: R. Datta, A. G. Dixon, Y. H. Ma, S. L. Matson, R. W. Thompson

ASSOCIATE PROFESSORS: W. M. Clark, D. DiBiasio, F. H. Ribeiro, B. E. Wyslouzil

ASSISTANT PROFESSORS: T. A. Camesano, N. K. Kazantzis

ADJUNCT ASSISTANT PROFESSOR: H. W. Nowick, T. Starr

AFFILIATE ASSISTANT PROFESSOR: K. M. McNamara

MISSION

The Department of Chemical Engineering at WPI is dedicated to providing excellent education to undergraduate and graduate students in chemical engineering, and to vigorously pursuing discovery, creation, and dissemination of knowledge at the frontiers of chemical engineering. Chemical engineers are uniquely positioned to continue to contribute to the betterment of society through advancements in new materials, biomedicine, alternative energy, transportation, environmental pollution abatement, resource conservation, and sustainable development. The Department aspires to contribute to this vision by achieving national distinction in selected areas of scholarly inquiry and by educating men and women to become leaders in industrial practice, civil service, education, and research. The Department strives to produce technically competent and socially aware chemical engineers through project-based, innovative, and rigorous educational programs that promote global and societal awareness, innovative thinking, and life-long learning skills.

OBJECTIVES

The Chemical Engineering Department has established the following objectives of the undergraduate program in support of our mission and that of the Institute.

1. To educate in students in the fundamental principles of chemical engineering.
2. To help students develop the ability to use chemical engineering principles to solve problems of practical importance to society.
3. To help prepare students, through broad education, for a lifetime of success as productive and informed members of society as well as of their professional community.
4. To help students become effective communicators.

OUTCOMES

The Chemical Engineering Department has established fifteen educational outcomes in support of our objectives. The outcomes are grouped under the objectives that they support.

Objective 1

- 1.1 Chemical engineering graduates will possess a working knowledge of the fundamentals of chemistry, physics, and mathematics, including knowledge of advanced elective science subjects such as organic and inorganic chemistry, material science, and biochemistry, etc.

1.2 Chemical engineering graduates will possess a working knowledge of conservation principles and their applications, physical and chemical equilibria, transport and rate processes, separation processes, chemical process control, and reaction engineering.

Objective 2

- 2.1 Chemical engineering graduates will be able to formulate, analyze, and solve practical chemical engineering problems.
- 2.2 Chemical engineering graduates will be able to design experiments, safely gather and analyze data, and apply the results to address practical chemical engineering problems.
- 2.3 Chemical engineering graduates will be able to use appropriate mathematical concepts and methods to solve chemical engineering problems.
- 2.4 Chemical engineering graduates will be able to design a chemical system, process, or component with consideration of realistic constraints including practical, economic, environmental, safety, ethical, social, and political implications.
- 2.5 Chemical engineering graduates will be able to use computers effectively for solving chemical engineering problems.

Objective 3

- 3.1 Chemical engineering graduates will be able to function and work effectively alone and in a team environment, including multidisciplinary teams.
- 3.2 Chemical engineering graduates will possess an appreciation of professional, ethical, and contemporary issues, and the societal and global impact of chemical engineering processes.
- 3.3 Chemical engineering graduates will possess self-learning skills to ensure life-long learning.
- 3.4 Chemical engineering graduates will possess an appreciation for the humanities and social sciences.
- 3.5 Chemical engineering graduates will be able to use their chemical engineering education to serve the chemical engineering profession or a related profession or pursue advanced studies.
- 3.6 Chemical engineering graduates will have selected technical elective courses, concentrations, projects, and minors that satisfy their professional interest or career goals.

Objective 4

- 4.1 Chemical engineering graduates will be able to write coherent, concise, and accurate technical reports.
- 4.2 Chemical engineering graduates will be able to make concise and effective oral presentations.

INTRODUCTION

Chemical engineers solve a wide variety of problems utilizing chemistry and engineering principles. Chemical engineers are vital to a broad range of material technologies such as plastic parts for automobiles, ceramic engine components, high-performance food packaging materials, nanofabrication technology, optoelectronic devices and modern construction materials. The fields of energy and transportation rely heavily on chemical engineering. Chemical engineers have been key contributors in the development of designer gasoline to meet new product performance and emission requirements; liquid fuels

from natural gas, coal, shale; batteries with high energy density; and novel energy-conversion technology such as fuel cells and solar cells. Many technologies to improve public health depend significantly on chemical engineering such as biomaterials, biomedical devices, medical diagnostics, the chemical synthesis of drugs, computer-aided drug design, the genetic engineering of therapeutic proteins, drug delivery systems and medical imaging technology. Finally, chemical engineering plays a dominant role in most environmental technologies. Examples are: atmospheric chemistry, product life cycle analysis, bioremediation, environmental risk and impact analysis, environmental friendly manufacturing technology and products, separation and conversion technologies for waste reduction and the cleanup of contaminated sites. Although the department strives to give all students a broad education, students can learn more in a given area of concentration by directing their course and project work to emphasize those areas.

Program Distribution Requirements for the Chemical Engineering Major

The normal period of residency at WPI is 16 terms. In addition to the WPI requirements applicable to all students (see page 22), students wishing to receive the ABET-accredited degree designated "Chemical Engineering" must satisfy certain distribution requirements. These requirements apply to 10 units of study in the areas of mathematics, basic science, engineering science and design, and 2 units of advanced chemistry as follows:

Requirements	Minimum Units
1. Mathematics and Basic Science (Notes 1, 2).	4
2. Engineering Science and Design (Notes 3, 4).	6
3. Advanced Chemistry (Note 5).	2

NOTES:

1. Must include differential and integral calculus and differential equations.
2. Must include 2 courses in physics.
3. Must include 1 unit of MQP, 1/3 unit of capstone design experience (e.g. CM 4404), and at least 1/3 unit of engineering study outside the major. Courses used to satisfy this requirement must be at the 2000-level or above.
4. Must include at least 4 units from the following list of core chemical engineering courses: CM 2011, CM 2012, CM 2013, CM 2014, ES 3004, ES 3003, ES 3002, CM 3201, CM 3501, CM 4401, CM 4402, CM 4403, CM 4404, CM 4405.
5. All CH courses qualify except CH 1010, CH 1020, and CH 1030 which are basic science. Up to 1 unit of Advanced Chemistry may be double counted as both Advanced Chemistry and Basic Science. One course of Advanced Natural Science (2000 level and above BB, PH, GE) may be substituted for one Advanced Chemistry course.

CAPSTONE DESIGN REQUIREMENT

Students may elect to satisfy WPI's capstone design requirement in Chemical Engineering by either of two routes. The preferred manner for the student to satisfy this degree requirement is to successfully complete the design course, CM 4404, which by its nature is the very essence of capstone design as described by the chemical

CHEMICAL ENGINEERING SUGGESTED COURSE SEQUENCE

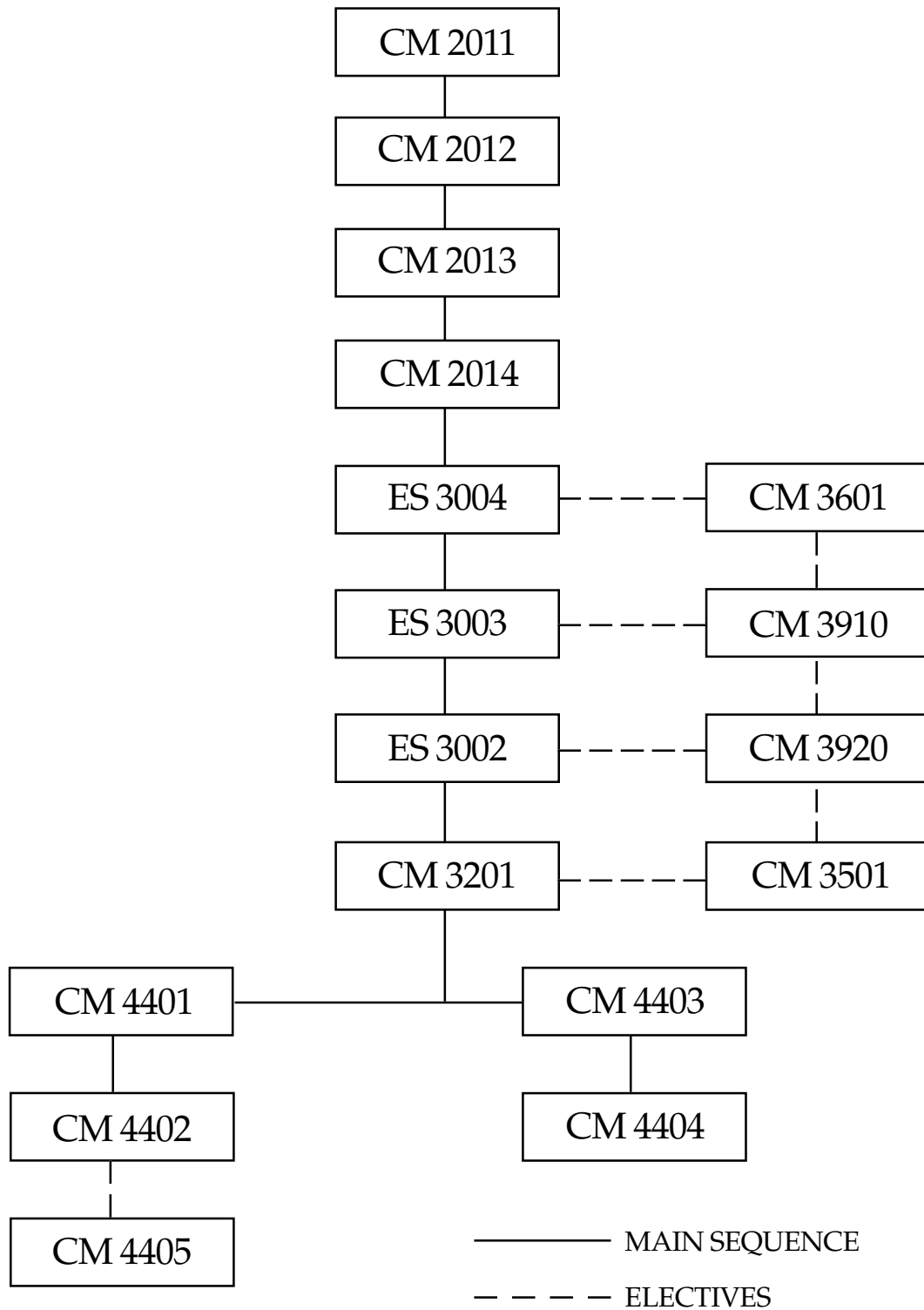

engineering professional society, AIChE. Alternatively, at least 1/3 unit of the MQP may be designated as "capstone design." This option must be chosen at the time the student and the advisor agree to the content and scope of the project, and so noted on the student's project registration form.

CONCENTRATIONS FOR CHEMICAL ENGINEERING MAJORS

Chemical engineering majors may choose to focus their studies by obtaining one of the following Concentrations: Biochemical, Biomedical, Environmental, or Materials.

REQUIREMENTS

Concentrations within the Chemical Engineering Department comply with WPI's requirements for Concentrations. Students must complete an MQP and two units of integrated study in the area of their Concentration. The two units of study will include at least one unit of coursework from a designated list of courses for the Concentration (a). The remaining one unit of work within the concentration area can be selected from additional courses from the designated list (b), or from the IQP, portions of the Sufficiency, or the Social Science requirement, when the course or project work supports a coherent and focused program of study in the subject area of the Concentration.

A coherent and focused program of study must be preapproved by the Department Program Review Committee. It is the student's responsibility to develop an integrated program that satisfies WPI's requirements and his/her own career aspirations. Therefore, students should plan their Concentration work with careful consultation of their Academic Advisor and the Program Review Committee. The Program Review Committee should be notified of plans for completing a Concentration before the student begins work on the Concentration. If IQP or Sufficiency work is to be used it must be certified as pertaining to the Concentration subject area by the IQP or Sufficiency advisor. The written certification should also state how many units (1/3, 2/3, or 1) the project advisor recommends be counted towards the Concentration.

- (a) Experimental CM courses that emphasize the Concentration subject matter may also be used to fulfill this requirement.
 (b) In special cases other courses may be approved by petition to the Program Review Committee.

DESIGNATED LISTS OF COURSES

For each Concentration a minimum of one unit of coursework must be selected from the lists of courses given below. Courses in these lists can also be counted as Basic Science, Advanced Chemistry, or Engineering Science and Design to fulfill distribution requirements as indicated. Students are also reminded that one course of Advanced Natural Science (2000 level and above PH, BB, or GE) may be substituted for one Advanced Chemistry course in meeting the department's distribution requirements. Some courses not on this list may be approved for a Concentration by petition to the Program Review Committee.

CHEMICAL ENGINEERING WITH BIOCHEMICAL CONCENTRATION

Basic Science:

Any BB course. No more than one 1000 level course may be counted, however. Recommended courses include:

BB 2002	Microbiology
BB 3055	Microbial Physiology
BB 4008	Cell Culture Theory and Applications
BB 4070	Separation of Biological Molecules
BB 505	Fermentation Biology
BB 507	Cell Culture
BB 560	Separation of Biological Molecules

Engineering Science and Design:

BB 509	Scale-Up of Bioprocessing
CM 521	Biochemical Engineering
BE 1001	Introduction to Biomedical Engineering

Advanced Chemistry:

CH 4110	Biochemistry I
CH 4120	Biochemistry II
CH 4130	Biochemistry III
BB 4910	Advanced Molecular Biology

CHEMICAL ENGINEERING WITH BIOMEDICAL CONCENTRATION

Basic Science:

<i>(at most, one of these three)</i>	}	BB 1030	Introduction to Biological Macro Molecules
		BB 2550	Cell Biology
		BB 2940	Experimental Biology I
		BB 3110	Animal Physiology
		BB 4065	Virology

Engineering Science and Design:

BE 1001	Introduction to Biomedical Engineering
BE/ME 4504	Biomechanics
BE/ME 4606	Biofluids
BE/ME 4814	Biomedical Materials

CHEMICAL ENGINEERING WITH ENVIRONMENTAL CONCENTRATION

Basic Science:

GE 2341	Geology
BB 2040	Principles of Ecology

Engineering Science and Design:

<i>(at most, one of these three)</i>	}	CM 3910	Chemical and Environmental Technology
		CM 3920	Air Quality Management
		CE 3059	Introduction to Environmental Engineering
		CE 3070	Introduction to Urban and Environmental Planning
		CE 3074	Environmental Analysis
		CE 3060	Water Treatment
		CE 3061	Wastewater Treatment
		CE 4060	Environmental Engineering Lab.
		CE 4061	Hydrology

CHEMICAL ENGINEERING WITH MATERIALS CONCENTRATION

Engineering science and design:

CM 3601	Chemical Materials Engineering
ES 2001	Introduction to Material Science
CM 543	Molecular Sieves
CM 508	Catalysis and Surface Science of Materials
ME 2820	Materials Processing
ME 3811	Microstructure Analysis and Control
ME 4813	Ceramics
ME 4814	Biomedical Materials
ME 4821	Chemistry, Properties, and Processing of Plastics
ME 4840	Physical Metallurgy
ME 4850	Solid State Thermodynamics

Advanced chemistry:

CH 4550	Polymer Chemistry
---------	-------------------

MAJOR SUB-AREAS WITHIN DEPARTMENT

The areas of specialization normally available are closely tied to the research programs pursued by the faculty. Undergraduates can become involved in these areas to the extent they desire by properly selecting MQPs and by pursuing advanced courses or IS/Ps. The areas of specialization are as follows:

Biochemical Engineering
 Bioremediation
 Chemical Kinetics, Catalysis, and Reaction Engineering
 Environmental Engineering
 Fuel Cells
 Material Science and Engineering
 Membrane Technology
 Process Control
 Zeolite Technology

RECOMMENDED PROGRAM

Students who select chemical engineering or related fields will progress through the chemical engineering sequence as shown in the chart on page 81: first, by becoming familiar with the chemical engineering fundamentals; second, by studying the engineering sciences; and third, by becoming involved in chemical engineering design. In addition, specialized science and technology studies are recommended. This progress can be achieved by judicious selection of courses, projects, and IS/Ps.

In all program planning, students should work closely with their academic advisors not only to fulfill their personal interests, but to provide a sound professional background for a successful career in chemical engineering.

RELATED COURSES

Courses are offered either by the department faculty (CM) or by the engineering faculty under the Engineering Science (ES) label to provide the necessary background in each of the areas indicated.

PROJECT OPPORTUNITIES

Projects available to the chemical engineering student are of the widest possible variety. Projects may be of the research type (as would be encountered in graduate school) or of a more developmental, industrial nature. Nonexperimental design projects or theoretical projects are also available. They are available on campus, sometimes with graduate students working on sponsored research; in off-campus governmental laboratories; or in industry.

Areas of specialization in the department currently are:

Adsorption	Nucleation Phenomena
Aerosol Science	Mass Transfer
Biochemical Engineering	Materials Processing in Space
Bioremediation	Process Control
Catalysis	Reaction Engineering
Diffusion	Scientific Computing
Fuel Cells	Separation Processes
Inorganic Membranes	Thermodynamics
Kinetics	Zeolites

CHEMISTRY AND BIOCHEMISTRY**J. P. DITTAMI, HEAD**

PROFESSORS: H. Beall, R.E. Connors, J.P. Dittami, N.K. Kildahl, W.G. McGimpsey, J.W. Pavlik, A.A. Scala, C. Sotak, S.J. Weininger

ASSOCIATE PROFESSORS: J.M. Arguello, W.D. Hobey, K.N. Wobbe

ASSISTANT PROFESSORS: C.D. Fairchild, J.C. MacDonald, V. Thalladi

RESEARCH PROFESSOR OF CHEMISTRY: L.H. Berka

MISSION STATEMENT

Through dynamic and innovative classroom instruction and exciting cutting edge research programs, the Department of Chemistry and Biochemistry strives to provide students with both a broad understanding of the fundamentals of the chemical sciences and an opportunity to create new chemical and biochemical knowledge through original research. We aspire to produce graduates who will enter their scientific careers with the confidence and competence to lead the advance of chemistry and biochemistry in the 21st century.

PROGRAM EDUCATIONAL OBJECTIVES

The Department of Chemistry and Biochemistry will graduate outstanding professionals possessing fundamental knowledge of the chemical sciences. Graduates will be able to apply this knowledge to the solution of problems in chemistry and biochemistry for the advancement of knowledge in these fields and the improvement of the standard of living of all humanity.

EDUCATIONAL OUTCOMES

Students graduating with a major in Chemistry or Biochemistry will be able to demonstrate an ability to

- perform accurate and precise quantitative measurements
- use and understand modern instruments, particularly NMR, IR, and UV-vis spectrometers, chromatographs, electrochemical instruments, and lab computers
- keep legible and complete experimental records
- analyze data statistically and assess reliability of results
- anticipate, recognize, and respond properly to hazards of chemical manipulations
- interpret experimental results and draw reasonable conclusions
- plan and execute experiments through use of the literature
- design experiments
- communicate effectively through oral and written reports
- critically assess their work for reasonableness and self-consistency
- achieve high ethical standards
- learn independently

OVERVIEW

Students in the Department of Chemistry and Biochemistry (CBC) may major in either *chemistry* or *biochemistry*. Chemistry is concerned with the structure and transformations of matter, the design and synthesis of new sub-

stances, and the potential applications of these substances. Biochemistry is concerned with understanding the chemistry of life at the molecular level. Both disciplines create new knowledge that benefits humanity in countless ways. CBC is deeply committed to the advancement of knowledge through the research programs of its faculty. The department is also strongly committed to the communication of this knowledge to its major students and to students in other majors requiring a strong foundation in chemistry. Via its program of major qualifying projects, CBC enables its undergraduate majors to take part in this exciting activity of developing new scientific knowledge at the same time that they are learning the ideas and concepts that allow rationalization of this knowledge at the atomic/molecular level of matter.

It is an exciting time to be a chemist or biochemist. Chemists are becoming adept at creating and manipulating new molecules to achieve desired ends. The blossoming area of nanoscale technology depends directly on the ability of the chemist to create molecules that function in a specific mechanical or electrical way. Molecules can be designed to have one shape under some circumstances and a different shape in others. This suggests the "on" or "off" type application needed in computer memory design. Molecules called carbon nanotubes have been designed that function as molecular wires. Even DNA, the molecule of heredity, has been shown by a chemist to function as a molecular wire. Chemists are now able to design and synthesize in the laboratory molecules that serve as medicines and/or drugs. Further, they can carry out "design changes" on existing medicines or drugs that result in even more effective agents. Chemists can use lasers and coupled spectroscopic methods to "photograph" movements of atoms in individual molecules that occur in less than 1 femtosecond (10^{-15} s). Thus the possibilities for exciting research in today's chemistry laboratory are almost limitless.

At the same time, biochemists have made tremendous advances in understanding the molecular basis for life since the elucidation of the molecular structure of DNA in 1953. Using modern biochemical tools such as restriction enzymes, PCR (polymerase chain reaction) and cloning, biochemists are well on the way to determining the entire human genome (that is, identifying all of the genes present in human chromosomes, and the proteins that these genes encode). Detailed structures of the active sites of enzymes have enabled biochemists to understand the mechanisms by which these fascinating molecules catalyze specific chemical reactions. These studies have in turn made it possible to use enzymes as catalysts for industrial processes. Progress in biochemistry in the last half of the 20th century was remarkable; it will only get better in the 21st.

BIOCHEMISTRY

Biochemistry is a major for students who wish to work at the interfaces of biology, chemistry and medicine. Biochemists seek to understand at the molecular level the complex chemical structures and accompanying reactions that determine biological processes such as metabolism, reproduction and growth, and their regulation through chemical messenger-receptor interactions in the immune, endocrine

and nervous systems. The distribution requirements represent a balance between chemistry and biology, and between lecture and laboratory, while the overall program develops the distinct professional perspective needed to bridge molecular science to physiology.

Students who graduate with a degree in Biochemistry are well qualified for positions as professional biochemists in the pharmaceutical industry and large hospitals in areas such as drug-receptor research, bioanalytical chemistry and drug metabolism, and in the biotechnology field in jobs dealing with protein isolation, purification and modification for medical use, as well as in a variety of other employment opportunities. The program also provides excellent preparation for those who intend to further their studies in Biochemistry or related fields (e.g. Pharmacology or Immunology) at the graduate level.

Since Biochemistry embodies in its distribution requirements all the technical courses needed for admission to medical, dental and veterinary schools, it is the major of choice for prehealth professionals.

Major Qualifying Projects may be carried out under the direction of a member of the Department of Chemistry and Biochemistry or any one of the Associated Faculty listed below; see their respective department descriptions for further details. MQP opportunities are also available at research centers such as the University of Massachusetts Medical Center, Tufts University School of Veterinary Medicine, and St. Vincent Hospital.

Program Distribution Requirements for the Biochemistry Major

In addition to the WPI requirements applicable to all students (see page 22), students wishing to graduate with a degree in biochemistry must meet the *distribution requirements* detailed below.

Requirements	Minimum Units
1. Mathematics and Physics (Note 1).	2
2. Chemistry and Biochemistry (Note 2).	4
3. Biology (Note 3).	1 2/3
4. Chemistry and Biochemistry/ Biology Laboratory (Note 4).	1
5. Other Natural or Computer Science (Note 5).	1/3
6. MQP	1

Notes:

1. The mathematics in MA 1021-MA 1024 or the equivalent is recommended. The physics in PH 1110-PH 1120 or equivalent is recommended.
2. These four units must include one unit of organic, one unit of biochemistry, and 1/3 unit each of physical (3000 level or higher) and inorganic chemistry (3000 level or higher).
3. These 1 2/3 units must include 1/3 unit of cell biology, 1/3 unit of genetics, and 2/3 unit of advanced work (3000 level or higher).
4. This unit must include a minimum of 1/3 unit in Chemistry and Biochemistry, and a minimum of 1/3 unit in Biology.
5. Any course in the natural sciences (not used to satisfy another requirement) or in computer science may be used to satisfy this requirement.

AMERICAN CHEMICAL SOCIETY APPROVAL AND CERTIFICATION

CBC and its biochemistry program are approved by the American Chemical Society (ACS). Graduates who com-

plete a program satisfying the ACS recommendations are certified to the society by the department. Certification signifies that these graduates have completed a program meeting the ACS standards.

The Distribution requirements provided above are considered by CBC to constitute the minimum coursework necessary to achieve a degree in biochemistry. Additional courses are necessary to be eligible for ACS certification. The following section provides detailed recommendations for both non-certified and certified degrees in biochemistry.

RECOMMENDATIONS FOR STUDENTS

A typical Biochemistry curriculum for a non-ACS certified degree is given below.

Premedical students should take three terms of Physics, as well as one of the Organic Chemistry Laboratories (CH 2360 or CH 2660), by the end of their third year. BB 1001 (Term B) is recommended as the initial course for students who need to strengthen their background in biology. Note that a total of one unit designated Elective in the table must be in Biology.

Students should take 1/3 unit of advanced Biology laboratory (BB 3512, 3518, 3519, 3520 are recommended) at their discretion as to the term; however, this should preferably be done before the MQP is commenced.

Year	Term A	Term B	Term C	Term D
First	CH 1010 HU MA	CH 1020 BB 2550 MA	CH 1030 BB 2920 MA	CH 1040 HU MA
Second	CH 3510 CH 2640 HU	CH 2310 PH SS	CH 2320 CH 2660 HU	CH 2330 CH 2670 HU
Third	CH 4110 BB Lab PH	CH 4120 PH IQP	CH 4130 CH 3410 IQP	CH 4150 SS IQP
Fourth	MQP Elective Elective	MQP Elective Elective	MQP CH 4160 Elective	MQP CH 4190 Elective

A typical curriculum for an ACS-certified degree in biochemistry is given below.

Year	Term A	Term B	Term C	Term D
First	CH 1010 HU MA	CH 1020 BB 2550 MA	CH 1030 BB 2920 MA	CH 1040 HU MA
Second	CH 3510 PH HU	CH 2310 PH HU	CH 2320 CH 2660 HU	CH 2330 SS HU
Third	CH 4110 BB Lab SS	CH 4120 Elective IQP	CH 4130 CH 3410 IQP	CH 4150 Elective IQP
Fourth	Elective MQP Elective	Elective MQP Elective	CH 4160 MQP Elective	CH 4190 MQP Elective

Students seeking the ACS certified degree should study calculus through multivariate analysis, linear algebra, and physics (mechanics and electricity/magnetism).

ASSOCIATED BIOCHEMISTRY FACULTY

D. S. Adams (BB), J. C. Bagshaw (BB), T. C. Crusberg (BB), G. D. J. Phillies (PH), S. M. Politz (BB), J. Rulfs (BB), E. Ryder (BB), P. J. Weathers (BB).

CHEMISTRY

Chemistry is a fundamental science concerned with discovering new knowledge about the structure, properties, and reactivities of existing forms of matter; and with the creation of new forms of matter by manipulating atoms and molecules in the laboratory. The ability of chemists to actually make new substances distinguishes chemistry from any other science, in which the practitioners are limited to studying what is already there. The knowledge created by fundamental scientific study allows us to understand our world better and to make it a more hospitable place in which to live.

In addition to its intrinsic value, chemistry is central to other areas of human endeavor, including materials science and engineering, biology, medicine, electronics, law enforcement, and even psychology. Chemistry is inherently experimental, but experiments are performed within a theoretical framework that enables interpretation of experimental results and points the way to new, fruitful areas for investigation.

Many careers are available to a chemistry graduate. Some elect to pursue an advanced degree in graduate school, medical school, veterinary school, or law school. Others decide to seek employment in industry, government, or health care. Still others may choose to pursue a teaching career. Chemistry provides an exceptionally good background for a wide variety of careers not traditionally associated with chemistry, but in which the expertise and thinking patterns of the chemist may be applicable. Examples include oceanography, environmental control, materials science, biology, biomedical engineering, mental health, and patent law. A high percentage of WPI chemistry graduates seek advanced degrees at prestigious graduate schools nationwide, while others pursue careers in many of the areas mentioned above.

Program Distribution Requirements for the Chemistry Major

In addition to the WPI requirements applicable to all students (see page 22), students wishing to graduate with a degree in chemistry must meet the *distribution requirements* detailed below.

Requirements	Minimum Units
1. Mathematics and Physics (Note 1).	2 1/3
2. Chemistry (Note 2).	4
3. Additional Science/Engineering (Note 3).	3 2/3

Notes:

- Must include differential and integral calculus and at least 2/3 units of physics.
- Must be above the level of general chemistry (2000 level or higher). These 4 units must include courses in experimental chemistry (either 4/3 unit or 3/3 unit), inorganic chemistry (1/3 unit), organic chemistry (3/3 unit), physical chemistry (3/3 unit), and biochemistry (either 1/3 unit or 2/3 unit, depending on the number of experimental chemistry courses

taken). At least 2/3 units must be at or higher than the 4000 level.

3. Distributed among the MQP, the natural and physical sciences, computer science, mathematics, and engineering (and including general chemistry, CH 1010-1040).

PREVIOUS DISTRIBUTION REQUIREMENTS FOR CHEMISTRY

The above distribution requirements apply to all students whose matriculation date is after May 1, 2003. Students who matriculated prior to May 1, 2003, should consult the catalog for their year of entry or the Chair of the Chemistry Distribution Review Committee.

AMERICAN CHEMICAL SOCIETY APPROVAL AND CERTIFICATION

CBC and its chemistry program are approved by the American Chemical Society (ACS). Graduates who complete a program satisfying the ACS recommendations are *certified to the society* by the department. Certification signifies that these graduates have completed a program meeting the ACS standards.

The Distribution requirements provided above are considered by CBC to constitute the minimum coursework necessary to achieve a degree in chemistry. Additional courses are necessary to be eligible for ACS certification. The following section provides detailed recommendations for both non-certified and certified degrees in chemistry.

RECOMMENDATIONS FOR STUDENTS

Chemistry utilizes many of the concepts of physics and the tools of mathematics. Thus students should acquire a background in these subjects early in their programs. The material addressed in MA 1021 through MA 1024 is recommended for all chemistry majors. Students will also benefit from knowledge of differential equations, as discussed in MA 2051. Physics background should include mechanics, and electricity and magnetism. Either the PH 1110-1120 or the PH 1111-1121 sequence is recommended. Students seeking more depth in physics are advised to pursue PH 1130 and PH 1140.

The subject matter of chemistry was traditionally divided into the areas of inorganic, organic, physical, and analytical chemistry to aid in the organization and presentation of the subject. Although burgeoning knowledge in and applications of chemistry have made this system of compartmentalization largely obsolete in the research sphere, courses in chemistry are still organized by this older system. Every chemist should have a sound background in each of these traditional areas precisely because new directions in chemistry require an ever-broader grasp of physical and chemical principles. In addition, because chemistry is an experimental (i.e., laboratory-driven) science, familiarity with laboratory operations is essential for understanding the subject matter and for developing the practical skills needed for project work and for the pursuit of further education or a career. Four laboratory courses are designed to fulfill this need. It is strongly recommended that they be taken in the second year to provide the basis for project work in the remaining years. Finally, basic knowledge of biochemistry is considered essential.

The following sequence of courses, recommended to provide fundamental background in chemistry, will result in a non-certified degree in chemistry. Specialization in particular areas of interest is best accomplished via additional courses and projects, generally taken in the third and fourth years.

Recommended CBC Courses for a Non-ACS-Certified Degree in Chemistry

Year	Term A	Term B	Term C	Term D
First	CH 1010	CH 1020	CH 1030	CH 1040
Second	CH 2640 (lab) CH 3510 (phys)	CH 2650 (lab) CH 2310 (org)	CH 2660 (lab) CH 2320 (org)	CH 2670 (lab) CH 2330 (org)
Third		CH 3550 (phys)	CH 3410 (inorg) CH 3530 (phys)	
Fourth	CH 4110 (bioch)			

The following sequence of courses, recommended to provide fundamental background in chemistry, will result in an ACS-certified degree in chemistry. Specialization in particular areas of interest is best accomplished via additional courses and projects, generally taken in the third and fourth years.

Recommended CBC Courses for an ACS-Certified Degree in Chemistry

Year	Term A	Term B	Term C	Term D
First	CH 1010	CH 1020	CH 1030	CH 1040
Second	CH 2640 (lab) CH 3510 (phys)	CH 2650 (lab) CH 2310 (org)	CH 2660 (lab) CH 2320 (org)	CH 2670 (lab) CH 2330 (org)
Third		CH 3550 (phys)	CH 3410 (inorg) CH 3530 (phys)	
Fourth	CH 4110 (bioch)			CH 4420 (inorg)*

*Because this course is offered every other year, some students may have to take it in Term D of the third year.

Students seeking certification should plan to study calculus through multivariate analysis (MA 1021-1024), differential equations (MA 2051) and linear algebra (MA 2071), and should take a minimum of two course in physics (for example, PH 1111 and 1121).

CONCENTRATION IN MEDICINAL CHEMISTRY

Medicinal Chemistry is the application of principles of biology and chemistry to the rational design and synthesis of new drugs for treatment of disease. A medicinal chemist applies knowledge of chemistry, biochemistry and physiology to generate solutions to health-related problems.

A concentration in medicinal chemistry is excellent preparation for students interested in entering health-related professions, such as the pharmaceutical industry, upon graduation. Possible employment positions are numerous and expected to increase in the future.

Course Requirements

In order to be eligible to receive the Medicinal Chemistry designation on their transcripts, chemistry majors need to satisfy the following course requirements:

- Three biomedically oriented courses selected from the following list must be included in the distribution requirements:
 - CH 4110 Biochemistry I
 - CH 4120 Biochemistry II
 - CH 4130 Biochemistry III
 - BB 4910 Advanced Molecular Biology
 - BB 4955 Recombinant DNA Principles and Applications
 - CH 539 Molecular Pharmacology
- Three courses oriented toward structure, synthesis, or mechanisms selected from the following list must be included in the distribution requirements. (All graduate courses in chemistry are open to undergraduates.)
 - CH 4330 Organic Synthesis
 - CH 516 Chemical Spectroscopy
 - CH 533 Physical Organic Chemistry
 - CH 538 Medicinal Chemistry
 - CH 554 Molecular Modeling
- In addition to the above course requirements, chemistry majors must complete an MQP in the medicinal chemistry area, approved by the Program Coordinator. Examples of available projects are:
 - Synthesis of huperzine analogs. New acetylcholinesterase inhibitors for treatment of Alzheimer's.
 - Synthesis of opiate analogs.
 - Synthesis and testing of compounds that influence transport properties of biological membranes.

PROJECT ACTIVITY

A student undertaking a Major Qualifying Project in chemistry and biochemistry chooses a faculty advisor in the department with whom to work. This choice is normally made because the student is interested in the research program directed by the faculty member, and wants to become a part of this activity. The student is given a research problem to work on for a minimum of 20 hours a week for 3 terms. Although most MQP projects in chemistry and biochemistry are individual student efforts, team projects involving up to 3 students are occasionally available, depending on the faculty member concerned. The project culminates in a formal written MQP report and a poster session presentation to the department faculty and students. MQP projects in chemistry and biochemistry require a substantial effort from the student in both the laboratory and writing phases. Many projects result in professional publications and/or presentations at professional meetings. The department offers a variety of areas of specialization (see AREAS OF SPECIALIZATION IN CHEMISTRY AND BIOCHEMISTRY below) in which Major Qualifying Projects may be carried out.

Some students, particularly those in biochemistry, choose to do their MQPs at off-campus laboratories. Biochemistry projects have recently been completed at the University of Massachusetts Medical Center and at St. Vincent's Hospital.

Faculty in the department of chemistry and biochemistry participate in a range of IQP activities involving students from all disciplines. Some recent examples of IQPs supervised by chemistry and biochemistry faculty include

- Soviet science fiction
- Teaching science in the public schools
- Physical environment, human thought, and creativity
- Heavy metal pollution in the Nashua River
- Health effects of radon in Worcester
- Nanotechnology and society

IQP activities are administered through the Projects & Registrar's Office.

INFORMATION FOR NONMAJORS

Chemistry is often called the "central science" because it underlies so much of human activity. Some fundamental understanding of the central science is essential for anyone planning a career in science or technology. The four-course sequence CH 1010-1040 is recommended to provide this fundamental background.

Students interested in physics, chemical engineering, biology, biotechnology, biomedical engineering, medicine, or veterinary science should take more advanced courses in chemistry. The sequence of organic chemistry courses, CH 2310-2330 and CH 2360 (laboratory) provides essential background for biology, biotechnology, plastics, and polymer science. Students planning to attend medical school must take CH 2310, CH 2320, and CH 2360 to satisfy medical school entrance requirements.

Other advanced chemistry and biochemistry courses may be appropriate for particular areas of interest. Students should seek advice from their academic advisors and the chemistry/biochemistry faculty.

AREAS OF SPECIALIZATION IN CHEMISTRY AND BIOCHEMISTRY

Computational Chemistry and Molecular Modeling
 Forensic Studies
 Gene Regulation
 Ion Transport
 Materials
 Medicinal Chemistry
 Membrane Proteins
 Molecular Spectroscopy
 Nanoscale Design
 Natural Products Synthesis
 Plant-Virus Biochemistry
 Photochemistry
 Photophysics
 Sensors
 Supramolecular Chemistry

CIVIL AND ENVIRONMENTAL ENGINEERING

F. L. HART, HEAD

PROFESSORS: J. F. Carney, T. El-Korchi, R. W. Fitzgerald, F. L. Hart, J. C. O'Shaughnessy
 ASSOCIATE PROFESSORS: L. D. Albano, R. A. D'Andrea, M. S. FitzPatrick, P. Jayachandran, P. P. Mathisen, R. Pietroforte, M. Ray, G. F. Salazar
 ASSISTANT PROFESSOR: J. Bergendahl, R. Mallick, J. Plummer

MISSION STATEMENT

The Civil and Environmental Engineering program at WPI prepares graduates for careers in civil engineering, emphasizing professional practice, civic contributions, and leadership, sustained by active life-long learning. The curriculum combines project based learning environment with a broad background in the fundamental principles of civil engineering. Students have the flexibility to explore various civil engineering disciplines and career opportunities.

EDUCATIONAL OBJECTIVES

1. A graduate should be able to apply the fundamental principles of mathematics, science, and civil engineering to analyze and design a component, process or system.
2. A graduate should have the interpersonal and communication skills, an understanding of ethical responsibility, and a professional attitude necessary for a successful engineering career.
3. A graduate should have the ability to engage in life-long learning.
4. A graduate should have an appreciation for the interrelationships among basic knowledge, technology, and society.

CEE PROGRAM OUTCOMES

1. Preparation for engineering practice, including the technical, professional, and ethical components.
2. Preparation for the future changes in civil engineering.
3. A solid understanding of the basic principles of civil engineering
4. An understanding of appropriate scientific concepts, and an ability to apply them to civil engineering.
5. An understanding of the engineering design process and an ability to perform engineering design, which includes the multidisciplinary aspects of the engineering design process, the need for collaboration and communications skills, plus the importance of cost and time management.
6. Demonstration of an ability to set up experiments, gather and analyze data, and apply the data to practical engineering problems.
7. Demonstration of in-depth understanding of at least one specialty within civil engineering.
8. Understanding of options for careers and further education, and the educational preparation necessary to pursue those options.

9. An ability to learn independently.
10. The broad education envisioned by the WPI Plan, and described by the Goal and Mission of WPI.
11. An understanding of civil engineering profession in a societal and global context.

INTRODUCTION

The major designated as "Civil Engineering" is the only program accredited by the Accreditation Board for Engineering and Technology (ABET) within the Department of Civil Engineering.

The broad range of work in civil and environmental engineering practice allows an individual to contribute professionally in a variety of different ways. On the one hand, the engineer may be involved in the broad scope of planning and managing the successful completion of a complex project that benefits our society. Examples of these types of projects include water resources and facilities; wastewater treatment facilities; hazardous or solid waste disposal systems; site design; buildings of all types; or transportation systems, such as highways and bridges, tunnels, mass transportation, airports, or harbor facilities. On the other hand, the engineer may wish to specialize and become expert in the professional activities associated with one of the many subdisciplines, such as structural engineering, environmental engineering, transportation engineering, geotechnical engineering, or materials engineering.

You have enormous flexibility in defining your educational program at WPI, and academic planning is one of the more important activities in which you will engage. With some limitations, you may specialize in one area, or you may develop a broad educational program that involves several subdisciplines. For most students, it is important to develop a program that has a broad overall structure, and, at the same time, has the flexibility to be modified with little disruption as conditions and your growth in understanding evolve. You should work closely with your advisors to develop a program that meets WPI and ABET professional requirements, while at the same time meeting your objectives and providing opportunities for explorations and educational expansion.

In developing your educational program, it is possible, and often desirable, to construct a general civil engineering program with focus on two or more of the subdisciplines. This type of program allows maximum flexibility and employment opportunities upon graduation. It also is possible to develop a program that provides a concentration of studies in one subdiscipline with minimal breadth in related subdisciplines. Each of these types of goals has advantages and limitations from both professional and educational viewpoints. The Civil and Environmental Engineering Department advisors can provide you with a document that provides guidance and sample programs within the context of WPI and ABET requirements.

The professional career opportunities for civil engineers are many and broadly varying. Normally, it is valuable to become a registered professional engineer as early in a career as possible. The usual route to becoming a registered professional engineer involves (a) obtaining a degree from an ABET-accredited program; (b) passing the Fundamentals of Engineering Examination (FEE); (c) acquiring the

necessary amount of professional level engineering experience; and (d) passing the professional engineers examination of the appropriate state licensing board. One can get the ABET accredited program in civil engineering at WPI. It is recommended that you take the Fundamentals of Engineering Examination (FEE) during the last year at WPI. This educational background should prepare you for the entry level engineering work necessary to complete the other professional registration requirements.

It is possible to enter the professional work force after receiving the BS degree. An additional opportunity that should be considered sometime before the final year is the integration of the BS with a MS degree. These degrees can be earned with five complete academic years of education. It is becoming more common to consider the MS degree as the first professional degree. Individuals who have recognized career objectives should consider this opportunity. The integration allows both graduate and undergraduate courses to be incorporated into the programs with possible reductions in costs and time. It is also possible, of course, to obtain advanced degrees in civil engineering specialty disciplines or in other fields concurrently with professional employment through a continuing education program.

Program Distribution Requirements for the Civil Engineering Major

The normal period of undergraduate residency at WPI is 16 terms. In addition to the WPI requirements applicable to all students (see page 22), students wishing to receive the ABET-accredited degree designated "*Civil Engineering*" must satisfy certain distribution units of study in the areas of mathematics, basic science, and engineering science and design as follows:

Requirements	Minimum Units
1. Mathematics and Basic Science (Notes 1,2).	4
2. Engineering Science and Design (including the MQP) (Note 3,4,5,6).*	6

Notes:

1. Mathematics must include differential and integral calculus and differential equations.
2. Must include both chemistry and physics with a minimum of two courses in either.
3. A minimum of 4 units of work must be within the Civil Engineering area. All CE courses including the MQP, ES 2503, and ES 3004 are acceptable within the Civil Engineering area.
4. The curriculum must include at least one engineering science course outside the major discipline area. Courses acceptable to satisfy the requirement of outside-of-discipline course are those taught in other engineering departments. The course must be 2000-level or above and cannot include ES 2501, ES 2502, ES 2503, and ES 3004.
5. All students are required to include an appropriate laboratory experience as part of their overall program. This experience can be met by the completion of two undergraduate CE lab courses, selected from among the following: CE 2020, CE 3024, CE 3026, CE 3054, CE 4046, and CE 4060. Alternately, an appropriate laboratory experience could also be accomplished by a student through careful planning of course, project and laboratory work and approval by petition through the Department Program Review Committee.
6. Must include 1/3 unit of Capstone Design Experience.

RECOMMENDED FUNDAMENTAL BACKGROUND

MATHEMATICS AND BASIC SCIENCE

It is essential that civil engineering students be well grounded in mathematics, the basic language of all engineers. For students with a normal secondary school background, the following courses should be taken: MA 1021, MA 1022, MA 1023, and MA 2051. At least one, and preferably several additional courses are valuable to a civil engineering education and may be selected from the following courses, depending upon the student's interests: MA 1024, MA 2210, MA 2071, or MA 2611. MA 2210, Mathematical Methods in Decision Making, in particular, is useful in working with civil engineering systems. As students progress and begin to develop a keen interest in a specific area of civil engineering, they should be prepared to seek additional mathematical support for advanced-level work. Advanced placement from high school, properly included in the WPI transcript, will be given appropriate credit.

A background in basic sciences is required. The student must include both physics and chemistry with a minimum of two courses in either. Possible basic science courses are PH 1110, PH 1120, PH 1130, CH 1010, CH 1020, CH 1030, CH 1040, GE 2341, BB 1001 and BB 2002. Advanced placement from high school, properly included in the WPI transcript, will be given appropriate credit.

ENGINEERING SCIENCE AND DESIGN

Engineering sciences have their roots in mathematics and basic sciences, but carry knowledge further toward creative application. Courses in engineering science provide a bridge between basic science and engineering practice. A student should select the engineering sciences that are appropriate for advanced professional design courses, and then fill out any additional requirements of engineering science with electives that provide a broad base for engineering practice. Consideration should be given to those engineering sciences required for the Fundamentals of Engineering Examination (FEE). At least one course must be from outside of the major area. Please note that ES 2503 and ES 3004 are regarded as civil engineering courses, and are an important part of the FEE examination. The engineering science requirement can be met by selecting a combination of courses from several disciplines. A partial listing of applicable courses from other disciplines that are useful for civil and environmental engineering students includes ES 3001, EE 3601, and FP 3070. Civil engineering courses that are considered engineering science include: CE 2000, CE 2001, CE 2002, CE 2020, CE 3024, CE 3026, CE 3041, and CE 4007. In addition, other courses designated CE have a significant engineering science component. Students can obtain information on these courses in consultation with their academic advisors.

Engineering design is the process of devising a system, component or process to meet desired needs. It is a decision-making process (often iterative) to convert resources to meet a stated objective. Among the fundamental elements of the design process are the establishment of objectives and criteria, synthesis, analysis, construction, testing, and evaluation. With the exception of those

CIVIL AND ENVIRONMENTAL ENGINEERING PROGRAM CHART

STUDENTS EARNING AN ABET ACCREDITED DEGREE IN CIVIL ENGINEERING MUST COMPLETE A MINIMUM OF 15 UNITS OF STUDY ARRANGED IN ACCORDANCE WITH THE DISTRIBUTION REQUIREMENTS. THIS CHART SUMMARIZES COURSE RECOMMENDATIONS—SEE YOUR ADVISOR TO DEVELOP YOUR PROGRAM SCHEDULE.

MATHEMATICS	SCIENCE †
4 Units Required	
MA1020/1021*	CH 1010
MA 1022*	CH 1020
MA 1023*	CH 1030
MA 1024	PH 1110
MA 2051*	PH 1120
MA 2071	PH 1130
MA 2210	BB 1001
MA 2611	GE 2341

NOTES

Basic math and science courses should be completed early in the curriculum, prior to taking many CE courses. Students may select from other math and science courses in addition to those listed here.

* Mathematics requirements include differential and integral calculus, and differential equations.

† Science: Must include both chemistry and physics with a minimum of two courses in either.

ENGINEERING SCIENCE AND DESIGN						
6 Units Minimum Required						
(Minimum 4 Units in the Civil Engineering area as noted in Distribution Requirements)						
Fundamental Courses	CE 1030 (1), CE 2000 (1), CE 2001 (1), CE 2020 (3), ES 3004 (1), CE 3041					
Background Courses	CE 3030, ES 2503 (1), ES 3001 (1,2), EE 3601 (1,2)					
Area (4,5)	Structural	Geotechnical	Environmental and Hydraulics	Urban and Environmental Planning	Transportation	Construction and Management
Breadth	CE 3010	CE 3041	CE 3059	CE 3070	CE 3050	CE 3020 (1)
Depth	CE 2002 CE 3006 CE 3008 CE 3026 (3) CE 4007 CE 4017	CE 3044 CE 4046 (3) CE 4048	CE 3060 CE 3061 CE 3062 CE 4060 (3) CE 4061	CE 3074 CE 4071	CE 3051 CE 3054 (3)	CE 3021 CE 3022 (1) CE 3023 CE 3024 (3) CE 4024
MQP	1 Unit Emphasizing Design (in area of choice) Should be completed in senior year and meet capstone design requirement.					

NOTES

1. Includes material covered on Fundamentals of Engineering General Exam.
2. Meets the requirement for at least one engineering science course outside of Civil Engineering.
3. Meets the requirement for appropriate laboratory experience (two laboratory courses required).
4. To demonstrate breadth, students must select courses from a minimum of four areas. Courses should also be selected to demonstrate depth in at least one area.
5. Many areas are interrelated. See your advisor for information on depth courses that are related to your area of interest.

ADDITIONAL DEGREE REQUIREMENTS 4 UNITS REQUIRED

Social Science	2/3 Units
Humanities and Arts	2 Units (includes Sufficiency)
IQP	1 Unit
Physical Education	1/3 Unit

CE courses designated engineering science, all other CE courses are design courses or have a significant design component. Students can obtain information on these courses in consultation with their academic advisor. At least two units of engineering design consisting of appropriate civil engineering courses and the MQP are required as part of the ABET six-unit engineering science and design distribution requirement.

SUBAREAS OF CIVIL ENGINEERING

STRUCTURAL AND GEOTECHNICAL ENGINEERING

The practice of structural engineering involves the analysis and design of buildings, bridges and other structures which are generally a part of all civil engineering systems. Geotechnical engineering encompasses a broad spectrum of interests including the design, analysis and construction of foundations for buildings and other structures, highway embankments, dams and waste containment facilities. It also considers tunnels, ground water development and engineering in the ocean environment.

An educational program leading to preparation for a career in structural and geotechnical engineering must necessarily include in-depth studies in the basic sciences, mechanics of materials, structural analysis, and design, computer applications, and engineering properties of construction materials. The important courses in this area are CE 2002, CE 3010, CE 3006, CE 3008, CE 3044, CE 3026, CE 4046, CE 4048 and CE 4007. Structures generally are a part of large engineering projects and systems. A valuable component of an engineering education involves the interface with other engineering areas. Knowledge of subject matter contained in CE 3020, CE 3059, CE 3050 and CE 3070 is useful for the structural or geotechnical engineer. Major Qualifying Projects in this field often focus primarily on either structural or geotechnical aspects, although many projects integrate the two areas, in addition to construction project management. Representative recent MQP topics include comparative building design and integration of design and construction.

ENVIRONMENTAL ENGINEERING

Environmental engineering is that branch of civil engineering involved with environmental quality control. The practicing environmental engineer is concerned with planning, design, construction, operation and regulation of water quality control systems related to water supply and treatment, and waste water collection and treatment. The environmental engineer is also concerned with solid waste management, public health, radiological health, and air pollution control. The Civil Engineering Department at WPI emphasizes water quality aspects of environmental engineering. Key courses of this subarea are CE 3004, CE 3059, CE 3060, CE 3061, CE 3062, and CE 3074. Further depth in this field can be obtained by taking CE 4060, CE 4048, CE 4061 and other appropriate courses in chemistry, biology and biotechnology, chemical engineering, and fluid mechanics. The student should attempt to obtain some social science background, particularly in economics

and possibly in law. Other engineering areas will enhance the environmental component of large projects. Courses such as CE 3010, CE 3020, CE 3050 and CE 3070 will be helpful. Recent MQP topics have focused on multimedia contaminant transport, pollution prevention, water quality issues, biosolids, and environmental impact.

TRANSPORTATION ENGINEERING

Transportation engineering is concerned with finding solutions to transportation problems such as designing and constructing safe, stable and durable pavement to carry large volumes of traffic vehicles that will be used in the 21st century. The highway infrastructure system in the US plays an important role in the commerce, economic development and security of the nation. These systems are deteriorating at a fast pace because of age, heavy increase in use and loading and deferred maintenance. While the highway infrastructure systems needs to be enhanced and maintained in order to provide the mobility needs of the nation, improvements must also be safe, efficient and environmentally benign.

A comprehensive set of courses is offered for providing both basic and in-depth knowledge in transportation engineering. The principal emphasis of transportation engineering at WPI is on traffic engineering, highway design, highway and roadside safety, principles of drainage and construction materials and pavement management. Students can gain basic understanding from breadth courses and in-depth knowledge about specific topics by taking depth courses. Breadth courses in this area are CE 3050 and CE 3026. Depth courses are CE 3051, and CE 3054.

The transportation engineering sub-area offers a wide range of MQP topics, which involve practical application of design principles in solving real-world problems. Recent MQP topics include design of a field permeameter for pavements, development of a mix design system for recycled pavement mixes, design of durable asphalt pavement mixtures, a study of parking needs and options on the WPI campus, an analysis of traffic accidents in Worcester, an economic study of the pros and cons of having trees in highway medians and ride quality study.

URBAN AND ENVIRONMENTAL PLANNING

The principal emphasis of urban design at WPI is the spatial arrangement of sites, neighborhoods, communities and regions, expressed through comprehensive site and development plans. These show the recommended uses of land such as residential, business, industrial, and recreational. The preservation of open space is also a major concern.

Key courses of this subarea are CE 3070, CE 3074, and CE 4071. Further depth in this field can be obtained by taking CE 4046, CE 4048, and selected graduate courses. An understanding of the other engineering areas will enhance the urban design area. Courses such as CE 3010, CE 3059, CE 2020, CE 3026, and CE 4024 will be helpful. Recent MQP topics include highway route selection, highway environmental impact, design of residential area and design of new towns, and GIS applications to planning.

CONSTRUCTION ENGINEERING AND PROJECT MANAGEMENT

The civil engineering program in construction engineering and project management is directed to students whose interests lie in the design engineering process but who are also concerned with the problems in social science, management, business, labor and legal relations, and the interaction of governmental and private interests as they relate to major construction projects.

Because of the multidisciplinary nature of the program, students are encouraged to complete courses in management. Information and control systems are important to construction management, and competence in utilizing computers in these areas is expected. Students are encouraged to work with the profession through projects and other activities. Key courses in the area are CE 3006, CE 3008, CE 3020, CE 3021, CE 3022, CE 3023, CE 3024, CE 3030, and CE 4024. An understanding of other engineering areas will enhance a construction engineering and management program. Courses such as CE 3044, CE 3050, CE 4071, and CE 3059 will be helpful. Typical project topics include computers in construction, prefabricated buildings, rehabilitative construction strategies, scheduling of construction projects, cost evaluation of construction, and integration of design and construction.

MASTER BUILDER PROGRAM

INTRODUCTION

The civil engineering practice is undergoing significant, rapid and revolutionary changes, demanding a much higher level of knowledge and experience of new engineers than in previous generations. Today engineers must have skills in computer applications, information technology, management, communications and foreign languages, as well as fundamental engineering skills. They must also grasp the political economic and social implications of projects. Engineers must have an increased depth of knowledge of specialty areas and keep up with technological advances in methods and materials. A master's degree may become soon the first recognized professional degree leading to professional licensing.

The Master Builder Program is a new Masters of Engineering program created by the Department of Civil and Environmental Engineering to respond to the needs of the profession for the 21st Century. It has been designed within the context of WPI's project-based education and teamwork. It is available through the combined-degree program for those undergraduate students in the civil and environmental department that wish to accelerate their graduate work by careful development of their undergraduate plan of study leading to a B.S. degree and a M.E. degree in five years. The combined-degree requires 16 units for the completion of the B.S. degree. However, students can apply 12 credits counted toward the master's degree to be counted toward the bachelor's degree.

The Master Builder program has been designed to educate engineers with technical competency and management proficiency, able to effectively participate and play a

leadership role in multi-disciplinary teams within the increasingly complex and demanding architectural/engineering/construction industry. These professionals are prepared to effectively integrate the planning, design construction and management of constructed facilities. They should be able to work for clients such as private developers and public agencies, traditional design, construction and facilities management firms as well as with integrated design-build firms.

COMBINED-DEGREE PROGRAM FIVE-YEAR PROGRAM

High school seniors can be admitted to the combined-degree Master Builder Program as freshman, allowing them to complete both a bachelors of science and master of engineering degree in civil and environmental in five years.

GRADUATE INTERNSHIPS AND CO-OP PROGRAM

A unique graduate internship program is available, allowing students to gain important clinical experiences in a practical engineering and research environments. Students are able to earn income, alternating work and on-campus classroom and laboratory activities.

PROJECTS

A great variety of projects are available to civil and environmental engineering students. Students should select project topics which are related to their subarea of emphasis. Project work is an extremely important part of civil engineering education, and the WPI Plan provides an excellent opportunity to strengthen this aspect of undergraduate education. Project activities are a combination of design, sponsored research, laboratory investigations, field work, and internship activities with governmental agencies and private industry. Students may become involved in project work at an early stage of the education program, and should have some Major Qualifying Project activity either under way or well in mind by the end of the junior year. The objectives of such work should include the development of the student's ability to analyze comprehensive situations, consider alternative solutions, define key problems, pick out major variables, and estimate orders of magnitude for reaching decisions. A major objective is the development of sound judgment and skill, incorporating engineering economics and social factors into problem solving.

Each civil engineering student must complete a capstone design experience which draws on past course work, involves significant engineering design, and relates to the practice of civil engineering. Normally, this will be accomplished as part of the MQP. At the time of registration for the MQP, the project advisor will indicate whether this project will meet the capstone requirement. If not, the advisor will provide an additional 1/3 unit of capstone design (not MQP) work to meet the requirement. Alternatively, another MQP which meets the requirement could be selected.

INFORMATION FOR NONMAJORS

Students from other departments find certain civil engineering courses to be valuable in the construction of their individual programs. The specific courses to be taken depend upon the interest of each student. CE 2000, CE 2001, CE 3010, and CE 3041 are useful if the student's program has a need for structures and geotechnical background. CE 3059, CE 3060 and CE 3061 are good courses for students interested in water quality control. Other courses of interest to nonmajors in this field are CE 3062 and CE 4061. CE 2020, CE 3050, CE 3051, CE 3070, and CE 3074 are valuable to students interested in transportation and urban and environmental planning. For students interested in construction engineering and management, the key courses are CE 2020, CE 3020, CE 3021, CE 3022, and CE 3023.

In addition to courses, the Civil and Environmental Engineering Department offers project opportunities for nonmajors as part of a project team.

PROGRAM DEVELOPMENT

The development of broad goals with an advisor is an important early step in the construction of a cohesive educational program that has substantial opportunity for flexibility and changes throughout the undergraduate association at WPI. The program will include mathematics, basic sciences, social sciences, humanities and arts sufficiency, physical education, and engineering science and design. The civil engineering advisors are listed below, organized in the general areas of interests. All of the advisors are available to provide counsel for either specific or general civil engineering programs.

CIVIL ENGINEERING AREA CONSULTANTS

Structural and Geotechnical Engineering

L. Albano
R. D'Andrea
T. El-Korchi
R. Fitzgerald
P. Jayachandran

Environmental Engineering

J. Bergendahl
M. FitzPatrick
F. Hart
P. Mathisen
J. O'Shaughnessy
J. Plummer

Transportation and Urban Planning

T. El-Korchi
M. FitzPatrick
R. Mallick
M. Ray

Construction Engineering and Management

L. Albano
R. D'Andrea
R. Fitzgerald
R. Pietroforte
G. Salazar

The civil engineering part of the program has requirements, although no unique courses are specifically required to complete the program. Nevertheless, certain courses normally are considered a part of a civil engineering education, unless a strong basis for deviation exists. Consultation with an advisor will help an individual to construct a program that both meets WPI and ABET requirements and also provides a breadth and professional training in areas of interest. To provide guidance in structuring a program, the following courses normally should be considered as a basic expectation for all civil engineering programs:

CE 1030	Fundamentals of Computers and Civil Engineering	I
CE 2000	Analytical Mechanics I	I
CE 2001	Analytical Mechanics II	I
ES 3004	Fluid Mechanics	I
CE 2020	Surveying	I
CE 3041	Soil Mechanics	I

The following courses should be considered as fundamental to most civil engineering programs:

CE 2002	Introduction to Analysis and Design	I
CE 3026	Materials of Construction	I
CE 3030	Fundamentals of Civil Engineering AutoCAD	I

The courses listed below are designed to develop a professional base for more advanced work in the specialty areas, as well as to provide a terminal knowledge for students who wish to select areas of concentration in other disciplines. Student programs should include as many of these courses as possible to provide a breadth of understanding across the major civil engineering disciplines.

CE 3010	Structural Engineering	I
CE 3020	Project Management	I
CE 3059	Environmental Engineering	I
CE 3070	Urban and Environmental Planning	I

A cohesive program should include a selection of courses in the professional areas noted below. The student should incorporate courses in as many areas as practicable to develop a program that has both substance and breadth. Many of the courses have interactive applications in two or more engineering disciplines.

Construction Engineering and Management		Category
CE 3021	Cost Estimating, Scheduling, and Cost Control	II
CE 3022	Legal Aspects in Design and Construction	II
CE 3023	Architectural Engineering Systems	I
CE 3024	Control Surveying	II
CE 4024	Real Estate Development	II
Environmental Engineering		
CE 3060	Water Treatment	I
CE 3061	Waste Water Treatment	I
CE 3062	Hydraulics in CE	I
CE 4060	Environmental Engineering Lab	I
CE 4061	Hydrology	I
Geotechnical Engineering		
CE 3044	Foundation Engineering	I
CE 4046	Experimental Soil Mechanics	II
CE 4048	Earth Structures	II

Structural Engineering

CE 3006	Design of Steel Structures	I
CE 3008	Design of Reinforced Concrete Structures	I
CE 4007	Matrix Analysis of Structures	I
CE 4017	Prestressed Concrete Design	I

Transportation and Planning

CE 3050	Highway Engineering and Planning	I
CE 3051	Introduction to Pavement Materials Design and Management	I
CE 3054	Asphalt Technology	I
CE 3070	Urban and Environmental Planning	I
CE 3074	Environmental Analysis	I
CE 4071	Land Use Development and Controls	I

ENVIRONMENTAL ENGINEERING**Civil/Environmental Engineering with Emphasis on Water Quality Control**

COORDINATORS: Profs. O'Shaughnessy, Mathisen, Hart, Plummer, or Bergendahl

The Department of Civil and Environmental Engineering at WPI provides courses leading to an ABET-accredited degree in Civil Engineering. Areas of emphasis include: the planning, design, construction, operation, and regulation of water quality control systems related to water supply and waste treatment. Environmental areas also include: public health, water supply, waste minimization treatment, and management. The engineering focus is in the area of large systems associated with municipal and other public projects.

At the undergraduate level, students often complete study in the areas of hydrology, hydraulics, hydrogeology, water supply, wastewater treatment, environmental analysis, and hazardous waste management. These areas are evaluated using physical, chemical, and biochemical techniques.

In addition to municipal and regional approaches covered in most courses, many MQP projects focus on industrial environmental problems. Typical problems include: ground water and soil contamination, waste minimization, water quality, biosolids, and hazardous waste management.

Students majoring in this program would follow a general curriculum in Civil and Environmental Engineering, with emphasis on the environmental engineering sub-area. Such preparation leads to a degree recognized by the professional accrediting organization, ABET (Accreditation Board of Engineering and Technology), and is an excellent start for entry-level professional placement or graduate study in environmental engineering.

COMPUTER SCIENCE**M. HOFRI, HEAD; L. A. BECKER, ASSOCIATE HEAD**

PROFESSORS: D. C. Brown, D. Dougherty, D. Finkel, M. Hofri, S. M. Selkow, M. O. Ward
 ASSOCIATE PROFESSORS: L. A. Becker, M. A. Gennert, N. I. Hachem, R. E. Kinicki, K. A. Lemone, E. A. Rundensteiner, C. E. Wills
 ASSISTANT PROFESSORS: E. Agu, M. Claypool, K. Fisler, N. Heffernan, G. T. Heineman, C. Ruiz
 PROFESSOR OF PRACTICE: M. Ciaraldi
 AFFILIATED ASSOCIATE PROFESSOR: G. N. Sarkozy
 ASSOCIATE RESEARCH PROFESSOR: F. C. Osorio
 INSTRUCTORS: V. Dobrushkin, G. Hamel

MISSION STATEMENT

The mission of the Computer Science Department at WPI is to provide outstanding education to its undergraduate and graduate students in accordance with the principles of the WPI mission, to advance scholarship in key domains of the computing sciences, and to engage in activities that improve the welfare of society and enhance the reputation of WPI. The Department aims to maintain an environment that promotes innovative thinking; values mutual respect and diversity; encourages and supports scholarship; instills ethical behavior; and engenders life-long learning.

GOALS

- The goals of the WPI Computer Science Program are to:
1. Prepare students to function professionally as computer scientists and software engineers.
 2. Prepare students for graduate studies in computer science and related disciplines.
 3. Develop in students critical thinking and problem-solving skills.
 4. Prepare students to assume responsible positions in society.
 5. Prepare students for life-long learning.
 6. Foster in students a sense of ethical behavior and respect for diversity.

OBJECTIVES

The objectives established by the WPI Computer Science Program in support of its goals and mission are to graduate students with a Computer Science major who:

1. Are prepared technically for computer science and software engineering practice.
2. Understand the basic principles of computer science and software engineering.
3. Understand appropriate mathematical concepts and are able to apply them to computational problems.
4. Have knowledge of computer hardware and architecture.
5. Understand and follow the software engineering process.
6. Are prepared to design and implement software systems.
7. Are prepared to analyze and evaluate software systems.

8. Understand fundamental scientific principles and the scientific method.
9. Can function effectively in diverse teams and situations.
10. Can communicate effectively in speech and in writing.
11. Are able to learn independently and find relevant resources.
12. Are prepared for future changes in computer science and software engineering.
13. Are prepared to uphold professional and ethical standards.
14. Understand and appreciate the role of computer science and software engineering in a societal context.
15. Are aware of career and further educational opportunities.
16. Have a mature understanding of themselves and others.

OUTCOMES

Based on the above objectives, the specific outcomes to be achieved for the WPI Computer Science major are that:

1. All students will demonstrate an understanding of programming language concepts.
2. All students will demonstrate knowledge of computer organization.
3. All students will demonstrate an ability to analyze the behavior of computational systems.
4. All students will demonstrate knowledge of computer operating systems.
5. All students will demonstrate an understanding of the foundations of computer science.
6. Almost all students will demonstrate an understanding of software engineering principles and the ability to apply them to software design.
7. A majority of students will demonstrate an understanding of human-computer interaction.
8. All students will complete a large-scale software project.
9. All students will demonstrate advanced knowledge of computer science topics.
10. All students will demonstrate an understanding of the mathematical foundations of computer science.
11. All students will demonstrate knowledge of probability or statistics.
12. All students will demonstrate an understanding of scientific principles.
13. A majority of students will demonstrate the ability to design experiments and interpret experimental data.
14. All students will demonstrate independent learning.
15. All students will demonstrate the ability to locate and use technical information from multiple sources.
16. All students will demonstrate an understanding of professional ethics.
17. All students will demonstrate an understanding of the links between technology and society.
18. A majority of students will belong to at least one professional organization, including IEEE, ACM, and UPE.
19. All students will participate in a class or project team.
20. Almost all students will demonstrate the ability to communicate effectively in speech.
21. All students will demonstrate the ability to communicate effectively in writing.

INTRODUCTION

Computer scientists should be broadly-educated individuals with a clear understanding of the natural laws and social orders that govern the world around them.

Well-educated individuals in our technical society must be knowledgeable in the areas of mathematics, humanities and social science, science, and engineering. Therefore, a student's program of study should include in-depth studies in several disciplines in addition to computer science. Broad-based education cannot be mandated by simply listing courses or topics to be studied. Instead, the WPI Plan encourages an integration of formal course work, project activity, self-study, and personal experiences. We cannot urge strongly enough that students make the very best use of the diverse educational opportunities available to them.

To be effective in business and society, computer scientists must be able to do more than design computing systems. They must relate to and communicate with people, so as to apply these systems to improving real-life situations. In recognition of the need for technical specialists who also have human-oriented skills, the WPI Plan requires a strong background in the humanities. To ensure breadth within the broad discipline of computer science and a firm grounding in mathematics and science, a student must complete the department's program distribution requirements.

The major designated as "Computer Science" is the only program accredited by the Computing Accreditation Commission of ABET within the Department of Computer Science.

Program Distribution Requirements for the Computer Science Major

The normal period of residency at WPI is 16 terms. In addition to the WPI requirements applicable to all students (see page 22) mathematics, basic science, and related fields as follows:

COMPUTER SCIENCE	Minimum Units
1. Computer Science (including the MQP) (Notes 1, 2).	6
2. Mathematics (Notes 2, 3, 5).	7/3
3. Basic Science and/or Engineering Science (Notes 2, 4).	5/3

NOTES:

1. a. Only computer science courses at the 2000-level or higher will count towards the computer science requirement.
b. Must include at least 1/3 unit from each of the following areas: Systems (CS 3013, CS 4513, CS 4514, CS 4515), Theory and Languages (CS 3133, CS 4123, CS 4533), Design (CS 3041, CS 3431, CS 3733, CS 4233), and Social Implications of Computing (CS 3043, SS 2208, SS/ID 2314). (If SS 2208 or SS/ID 2314 is used to satisfy this requirement, it does not count as part of the 6 units of CS.)
c. At least 5/3 units of the Computer Science requirement must consist of 4000-level courses. These units can also be met by WPI graduate CS courses, with the exception of CS 501 and CS 507.
2. A cross-listed course may be counted toward only one of areas 1, 2, 3, above.
3. Must include at least 1/3 unit from each of the following areas: Probability (MA 2621, MA 2631) and Statistics (MA 2611, MA 2612).

4. Courses satisfying the science requirement must come from the BB, BE, CE, CH, CM, EE, ES, GE, ME, PH disciplines. At least three courses must come from BB, CH, GE, PH, where at least two courses are from one of these disciplines.
5. At most four 1000-level Mathematics courses may be counted towards this requirement.

The Computer Science Department offers a second program not accredited by the Computing Accreditation Commission of ABET and not bearing the title "Computer Science." The distribution requirements for that program are:

Program Distribution Requirements for the Computers with Applications Major

COMPUTERS WITH APPLICATIONS	Minimum Units
1. Computer Science (including the MQP) (Notes 1, 2).	16/3
2. Mathematics (Note 2).	7/3
3. Basic Science (Notes 2, 3).	2/3
4. Application Area (Notes 2, 4).	5/3

NOTES:

- a. Only computer science courses at the 2000-level or higher will count towards the computer science requirement.
 - b. Must include at least 1/3 unit from each of the following areas: Systems (CS 3013, CS 4513, CS 4514, CS 4515), Theory and Languages (CS 3133, CS 4123, CS 4533), Design (CS 3041, CS 3431, CS 3733, CS 4233), and Social Implications of Computing (CS 3043, SS 2208). (If SS 2208 is used to satisfy this requirement, it does not count as part of the 16/3 units of CS.)
 - c. At least 5/3 units of the Computer Science requirement must consist of 4000-level courses. These units can also be met by WPI graduate CS courses, with the exception of CS 501 and CS 507.
 - d. The MQP must involve the application of computer science concepts to the Application Area specified in Requirement 4.
2. A cross-listed course may be counted toward only one of areas 1, 2, 3, 4 above.
 3. The two courses satisfying the science requirement must both come from one of the following disciplines: BB, CH, GE, PH.
 4. This requirement is satisfied by a cohesive set of work from disciplines other than Computer Science. Work used for any other degree requirements cannot be used for the Application Area. At least 3/3 units must be course work at the 3000 level or higher. Independent Study/Project (ISP) work, if any, must be conducted under the supervision of a member of the faculty in that discipline.

PREVIOUS DISTRIBUTION REQUIREMENTS FOR COMPUTER SCIENCE AND COMPUTERS WITH APPLICATIONS MAJOR

The above distribution requirements apply to all students whose matriculation date is after May 1, 2003. Students who matriculated prior to May 1, 2003 should consult the catalog for their year of entry or consult with their academic advisor or the Chair of the Department Distribution Review Committee.

PLANNING A COMPUTER SCIENCE MAJOR

Computer science students, upon completion of their program of study, should have developed a number of areas of competence. This competence is a blend of practical skills and knowledge of applied techniques and theoretical concepts. "Core" courses in computer science provide

a foundation in the areas of programming, data structures, computer organization and operating systems, mathematics and theoretical computer science, and the social impact of computing.

The ability to program is a major practical skill to develop. This is fundamental, of course, to the application of computers for any purpose whatsoever. Programming is not a mere synonym for coding. It includes a skillful evaluation of the problem statement, the development of an efficient algorithm and data structure for the solution of the problem, a clear specification of the algorithm and data structure, an evaluation of the cost of executing the algorithm, the actual coding, and the creation of sufficient test cases to verify the accuracy of the solution. The student must develop a strong programming ability in at least one high-level language as well as an ability to program in an assembler language.

The efficient organization of data into structures of varying complexity is an important part of the solution to most programming problems. Students must study not only the theoretical aspects of such structures but also their applications. In addition, students must become familiar with the techniques of representing various structures within the limitations imposed by the memory and languages available on the computer.

Students should have a clear understanding of the fundamental processes that occur within a general-purpose computing system. Familiarity with the operation of the hardware should be developed, as well as knowledge of the way hardware, operating systems, and user programs interact to form an effective computing system.

The theoretical aspects of computer science depend upon discrete mathematics for their description, so computer scientists should be familiar with this area of mathematics and how it relates to computer science theory.

In today's society the computer is a tool which affects the lives of everyone. The computer scientist cannot, in good conscience, remain blissfully ignorant of the impact caused by his or her own decisions and actions. Therefore, the computer science student is urged to study the relation between individuals, society and the computer.

Majors in computer science should be familiar with material in the following areas, although students are not required to take all of these.

CORE COURSES FOR MAJORS IN COMPUTER SCIENCE

Computer Science

CS 1005	Introduction to Programming
CS 1006	Object-Oriented Introduction to Programming
CS 2005	Techniques of Programming
CS 2011	Introduction to Machine Organization and Assembly Language
CS 2022	Discrete Mathematics
CS 2135	Programming Language Concepts
CS 2136	Paradigms of Computation
CS 2223	Algorithms
CS 3013	Operating Systems
CS 3041	Human-Computer Interaction
CS 3043	Social Implications of Information Processing
CS 3133	Foundations of Computer Science
CS 3733	Software Engineering

Mathematics

MA 1021	Calculus I
MA 1022	Calculus II
MA 1023	Calculus III
MA 1024	Calculus IV
MA 2071	Matrices and Linear Algebra I
MA 2611	Applied Statistics I
MA 2621	Probability

Note that other mathematics courses, such as MA 2051, may be useful background for advanced Computer Science courses.

For students who wish to improve their communication skills, the following courses are recommended: IS 1811, Writing for International Students, IS 1812, Speech for International Students, or EN 2211, Elements of Writing.

There is one noncore language course available. CS 1001, Introduction to Computers, teaches programming using FORTRAN, which has been used in engineering and scientific programming.

ADVANCED COURSES IN COMPUTER SCIENCE

After students have established a firm foundation in computer science, they should explore advanced topics, leading toward MQP work. Students must take at least one course from each of the following areas: Systems (CS 3013, CS 4513, CS 4514, CS 4515), Theory and Languages (CS 3133, CS 4123, CS 4533), Design (CS 3041, CS 3431, CS 3733, CS 4233), and Social Implications of Computing (CS 3043, SS 2208, SS/ID 2314). Other 4000-level courses may be divided among these areas or concentrated in a particular area according to each student's program objectives. The diagram on page 98 indicates how the material presented in each course is used by subsequent courses. Some variation in course order may occur, but the student considering taking courses out of sequence is advised to check the course descriptions for recommended background.

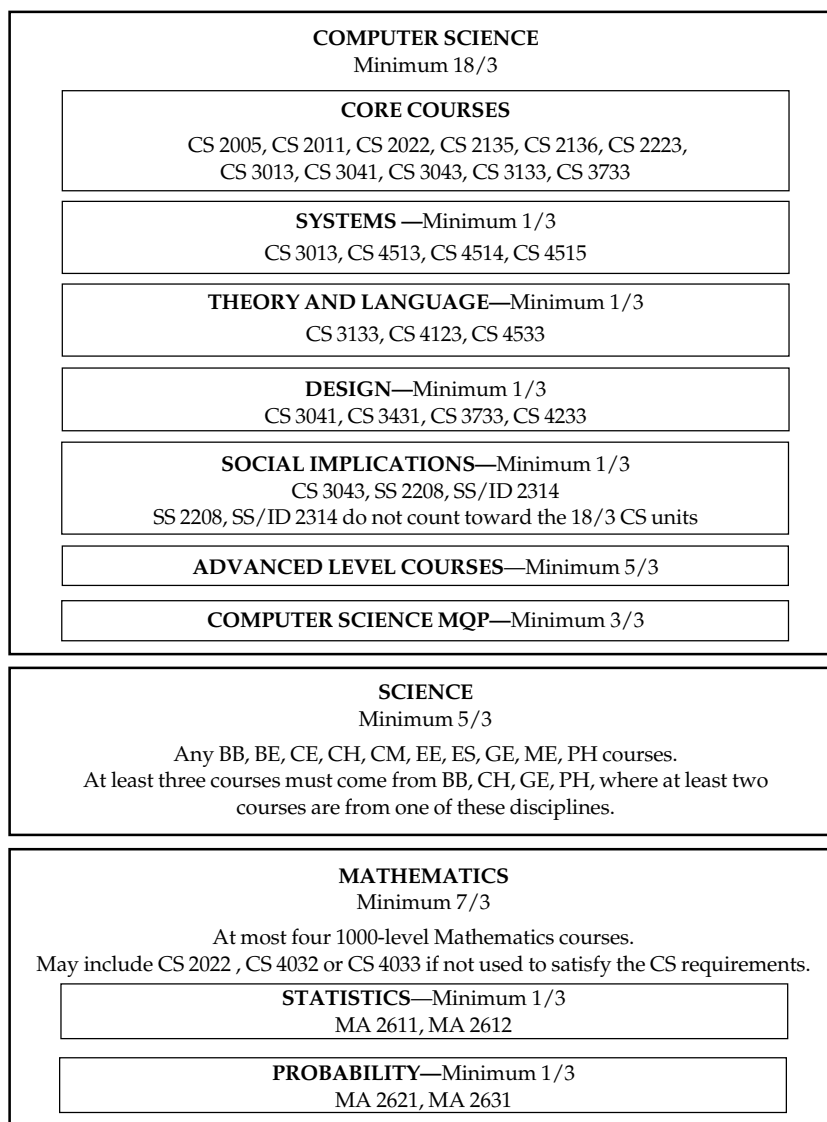
COMPUTER SCIENCE PROGRAM CHART

COMPUTER SCIENCE COURSE FLOW CHART

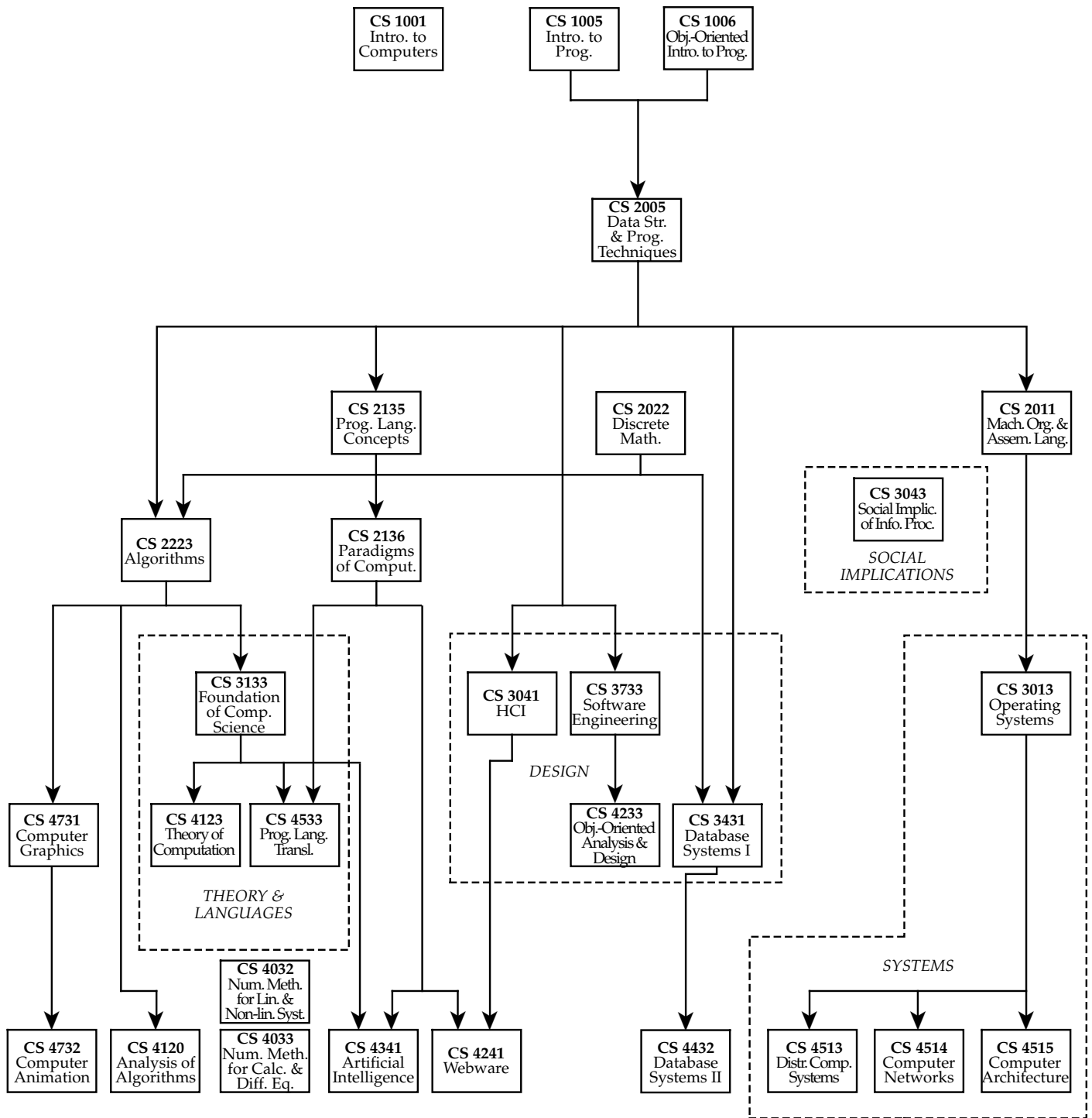

Listed below are several areas of computer science in which the student may wish to specialize, including some courses from other departments. These areas are meant to be illustrative; one should choose the course of study that best meets one's own needs and plans.

Operating Systems

- CS 3013 Operating Systems
- CS 4513 Distributed Computing Systems
- CS 4514 Computer Networks: Architecture and Implementation
- CS 4515 Computer Architecture
- MA 2051 Ordinary Differential Equations
- MA 2621 Probability for Applications

Software Systems

- CS 3041 Human-Computer Interaction
- CS 3431 Database Systems I
- CS 3733 Software Engineering
- CS 4233 Object Oriented Analysis and Design
- CS 4241 Webware

Human-Computer Interaction

- CS 3013 Operating Systems
- CS 3041 Human-Computer Interaction
- CS 3043 Social Implications of Information Processing
- CS 3431 Database Systems I
- CS 3733 Software Engineering
- CS 4241 Webware: Computational Technology for Network Systems
- CS 4341 Introduction to Artificial Intelligence
- CS 4432 Database Systems II
- CS 4731 Computer Graphics

Languages And Compilers

- CS 3041 Human-Computer Interaction
- CS 3133 Foundations of Computer Science
- CS 3733 Software Engineering
- CS 4233 Object-Oriented Analysis and Design
- CS 4533 Techniques of Programming Language Translation

Theoretical Computer Science

- CS 3133 Foundations of Computer Science
- CS 4120 Analysis of Algorithms
- CS 4123 Theory of Computation
- CS 4533 Techniques of Programming Language Translation
- MA 2271 Graph Theory
- MA 2273 Combinatorics
- MA 4631 Probability and Mathematical Statistics I

Scientific Applications

- CS 4032 Numerical Methods for Linear and Non-linear Systems
- CS 4033 Numerical Methods for Calculus and Differential Equations
- CS 4731 Computer Graphics
- MA 1021 Calculus I
- MA 1022 Calculus II
- MA 1023 Calculus III
- MA 1024 Calculus IV
- MA 2051 Ordinary Differential Equations
- MA 2621 Probability for Applications
- MA 3231 Linear Programming
- MA 4411 Numerical Analysis of Differential Equations
- PH 1110 General Physics — Mechanics
- PH 1120 General Physics — Electricity and Magnetism

Hardware Orientation

- CS 4515 Computer Architecture
- EE 3601 Principles of Electrical Engineering
- EE 3801 Advanced Logic Design
- EE 3803 Microprocessor System Design
- EE 3815 Digital System Design with VHDL
- EE 4801 Advanced Computer System Design

Students who are interested in the hardware aspects of computers, yet do not need a strong background in electronics, may omit the introductory electrical engineering courses and begin with EE 3801. Such a decision should be discussed with one's academic advisor.

INDEPENDENT STUDY

Independent study and project work provide the opportunity for students, working under the direction of faculty members, to study or conduct research in an area not covered in courses, or in which the students require a greater depth of knowledge. The background required of a student for independent study work depends on the particular area of study or research.

PROJECT OPPORTUNITIES

Off-campus qualifying projects are available at the Silicon Valley Project Center, the NASA/Goddard Space Center, and the Wall Street Project Center.

Projects are also available on campus, both to support the on-going research activities of the faculty, and to expand and improve the applications of computers for service, education, and administration.

Additionally, the department supports IQPs in a number of areas including assistance with, and development of, computer science education at neighboring area schools.

COMBINED BACHELOR'S/MASTER'S PROGRAM

Computer Science majors are advised to investigate the opportunity to enroll in the Combined Bachelor's/Master's Program described on page 242. For application information, consult the CS department office.

COMPUTER SCIENCE FOR THE NONMAJOR

A knowledge of at least one programming language is virtually essential to professionals in most disciplines. The computer science faculty recommends that all WPI students give serious consideration to one or more of these introductory computer language courses:

- CS 1001 Introduction to Computers
- CS 1005 Introduction to Programming
- CS 1006 Object-Oriented Introduction to Programming
- CS 2005 Techniques of Programming

Most students will need to program in a general purpose language, and therefore will elect to take either CS 1001 to study Fortran or CS 1005 to study the C programming language or CS 1006 to study the Java programming language. Fortran is an older language that was developed for scientific programming requiring arithmetic computations. Current versions of Fortran are suitable for general purpose programs. Consult your academic advisor on whether to learn Fortran, or C, or Java.

Students having a strong interest in computer science should begin their course work in computer science with CS 1005 and CS 1006; these courses provide a rigorous introduction to programming. Either CS 1005 or CS 1006 may be followed by CS 2005. Students who develop interest in computer science after taking CS 1001 are urged to consider taking CS 1005 or CS 1006, followed by CS 2005.

Nonmajors choosing an introductory computer science course are advised to consult with their academic advisor. Also be aware that certain departments have specific recommendations for their majors.

Students who plan to make frequent use of computers in their chosen fields are urged to begin their studies with CS 1005 or CS 1006, followed by CS 2005, and should consider pursuing a minor in Computer Science. The Computer Science minor is described below.

COMPUTER SCIENCE MINOR

The Minor in Computer Science will consist of 2 units from Computer Science, with no more than one course at the 1000-level. The 2 units must conclude with one of the following, each of which provides an integrating capstone experience:

- CS 3013 Operating Systems
- CS 3041 Human-Computer Interaction
- CS 3133 Foundations of Computer Science
- CS 3431 Database Systems I
- CS 3733 Software Engineering
- CS 4120 Analysis of Algorithms
- CS 4123 Theory of Computation
- CS 4233 Object-Oriented Analysis and Design
- CS 4241 Webware: Computational Technology for Network Systems
- CS 4341 Introduction to Artificial Intelligence
- CS 4432 Database Systems II
- CS 4513 Distributed Computing Systems
- CS 4514 Computer Networks: Architecture and Implementation
- CS 4533 Techniques of Programming Language Translation
- CS 4731 Computer Graphics

- any graduate-level CS course, except for CS501, CS505, CS507, CS552, or CS590
- 1/3 unit of another activity, for example an ISP, which is validated by a CS faculty member as a capstone.

Students interested in initiating work on a minor in CS are encouraged to ask the Computer Science Department to identify a faculty member to assist the student in structuring a minor. Prior to the initiation of a capstone experience students must inform the offering professor of their intent to use the experience as a capstone.

Majors in Computer Science and Computers with Applications do not qualify for a Minor in Computer Science.

EE majors and Management Information Science majors should review the Operational Rules of the Minor at WPI to avoid problems with double counting CS courses. For general policy on the Minor, see the description on pages 26-27.

ELECTRICAL AND COMPUTER ENGINEERING

J. A. ORR, HEAD; F. J. LOOFT, ASSOCIATE HEAD

PROFESSORS: K. A. Clements, D. Cyganski, A. E. Emanuel, F. J. Looft, R. Ludwig, J. A. Orr, K. Pahlavan, E. A. Parrish, Jr., P. C. Pedersen
ASSOCIATE PROFESSORS: R. J. Duckworth, H. Hakim, S. Makarov, J. A. McNeill, W. R. Michalson, R. F. Vaz
ASSISTANT PROFESSORS: D. R. Brown, E. A. Clancy, B. King, D.P. Papageorgiou, B. Sunar, N. Whitmal
PROFESSOR OF PRACTICE: R. Labonte
ADJUNCT PROFESSOR: R. H. Campbell
INSTRUCTOR: S. J. Bitar, A. Hatami
EMERITUS PROFESSORS: J. S. Demetry, W. H. Eggimann, W. R. Grogan, O. W. Kennedy, H. P. D. Lanyon, A. K. McCurdy, G. H. Owyang, G. E. Stannard

INTRODUCTION

Since the invention of the transistor in 1947, the field of electrical and computer engineering (ECE) has seen tremendous and continuous growth. From its origins in electric power, the field now ranges from various analog and digital design disciplines to all forms of communication and signal processing systems. Working engineers design the components and systems that, for example: compose computers, computer networks and the Internet; control automobiles, aircraft and shipping vessels; monitor patient vital signs in medical critical care; provide secure and reliable wireless connectivity for telephones and electronic commerce; deliver electricity to our homes and work places; etc.

To be prepared for employment as a contributing engineer and/or for graduate-level education, students within the ECE Department receive instruction that is balanced between theory and practice. In fact, much of our curriculum integrates theory and practice within *each* course. It is common to study new devices and techniques, and then immediately work with these devices/techniques in a laboratory setting. In response to the breadth of ECE, all students work with their academic advisor to develop a broad-based program of study. As with most engineering curricula, ECE study includes a solid foundation of mathematics and science. Discipline-specific study in ECE usually begins early in a student's career — during the second half of the freshman year — with courses providing a broad overview of the entire field. During the sophomore and junior years, students learn the core analysis, design and laboratory skills necessary to a broad range of ECE sub-disciplines. When desired, specialization within ECE occurs during the junior and senior years. In addition, all students complete a major qualifying project (MQP). This project, typically completed in teams during the senior year, is an individualized design or research project that draws from much of the prior instruction. Utilizing the benefit of individualized instruction

from one or more faculty members, students develop, implement and document the solution to a real engineering problem. Many of these projects are sponsored by industry, or are associated with ongoing faculty research. These projects form a unique bridge to the engineering profession.

EDUCATIONAL OBJECTIVES OF ECE DEPARTMENT PROGRAMS

The department educates future leaders of the electrical and computer engineering profession, with a program characterized by curricular flexibility, student project work, and active involvement of students in their learning. Through a balanced, integrated curriculum we provide an education which is strong both in the fundamentals and in state-of-the-art knowledge, appropriate for immediate professional practice as well as graduate study and lifelong learning. Such an education also prepares students broadly for their professional and personal lives, providing the basis for effective leadership and informed citizenship. The curriculum embraces WPI's philosophy of education, and takes advantage of key components such as the Interactive Qualifying Project to develop technical professionals who possess the ability to communicate, work in teams, and understand the broad implications of their work.

MAJORS OFFERED

In the electrical and computer engineering department we currently offer the Bachelor of Science degree in two majors: *Electrical and Computer Engineering* (ECE) and *Electrical Engineering* (EE). The ECE major is new to the department, and was designed to offer greater breadth across the many subdisciplines of ECE. The EE major is the traditional program offered by the department, and includes an optional concentration in Computer Engineering. In the future, we intend to phase out the older EE program, eventually offering only the ECE major.

For either major, students must fulfill the general requirements set forth by WPI (such as the IQP and Sufficiency projects) as well as a set of department-specific "distribution requirements" in order to graduate. The requirements stipulated by the ECE department apply to 10 units of study (out of the 16 units total that a typical student spends at WPI). They differ slightly according to the type of major desired (either ECE or EE). The following sections provide further description of the two majors and their respective distribution requirements. The EE major is accredited by the Accreditation Board for Engineering and Technology (ABET); the ECE major is new and will be considered for ABET accreditation at the earliest opportunity.

BACHELOR OF SCIENCE IN ELECTRICAL AND COMPUTER ENGINEERING

In recent years, the role of computers in electrical engineering has continued to grow. The use of computers has become an essential part of the analysis, design, and implementation of nearly all electrical engineering applications, and as a result, knowledge of computers and computer engineering has become a necessity for any successful electrical engineer. We believe that for any student to be skilled and successful in any area of ECE—whether entering the work force or continuing into graduate edu-

cation—it is necessary that he or she possess a complete understanding of the fundamentals across the breadth of electrical and computer engineering. For these reasons, we recently created a new program that places greater emphasis on attaining a breadth of knowledge across the many sub-disciplines of ECE, particularly by incorporating a more complete balance between computer engineering and other areas of ECE. The ECE major will be evaluated for accreditation by ABET at the earliest opportunity.

Based on the department's educational objectives, students will achieve the following specific educational outcomes within a challenging and supportive environment:

1. Preparation for engineering practice, including the technical, professional, and ethical components
2. Preparation for future changes in electrical and computer engineering
3. A solid understanding of the basic principles of electrical engineering, computer engineering, and the relationship between hardware and software
4. An understanding of appropriate mathematical concepts, and an ability to apply them to ECE
5. An understanding of the engineering design process, and ability to perform engineering design, including the needed teamwork and communications skills.
6. Demonstration of in-depth understanding of at least one specialty within ECE
7. An ability to communicate effectively in written and oral form
8. An understanding of options for careers and further education, and the necessary educational preparation to pursue those options
9. An ability to learn independently
10. The broad education envisioned by the WPI Plan, and described by the Goal and Mission of WPI
11. An understanding of engineering and technology in a societal and global context.

Program Distribution Requirements for the Electrical and Computer Engineering Major

The normal period of residency at WPI is 16 terms. In addition to *WPI requirements applicable to all students*, students wishing to receive the major designated "Electrical and Computer Engineering" must satisfy certain distribution requirements. These requirements apply to 10 units of study in the areas of mathematics, basic science, and engineering science and design as follows:

Requirements	Minimum Units
1. Mathematics and Basic Science (Notes 1a-1d).	4
2. Engineering Science and Design (ES/D) (including the MQP) (Notes 2a-2g).	6

NOTES:

1. Mathematics and Basic Science:
 - 1a. Must include at least 7/3 units of math (prefix MA). Mathematics must include differential and integral calculus, differential equations, and probability and/or statistics.
 - 1b. Must include at least 2/3 units of physics (prefix PH).
 - 1c. Must include at least 1/3 units of chemistry (prefix CH) or 1/3 units biology (prefix BB).
 - 1d. Must include an additional 2/3 units of math or basic science (prefixes MA, PH, CH, BB, or GE)

2. Engineering Science and Design (including the MQP):
- 2a. Must include at least 5 units within the Electrical and Computer Engineering area (including the MQP). All courses with prefix EE (except EE 3601) are applicable to these 5 units. Also, courses ES 3011, BE 4011, and BE 4201 are applicable to these 5 units.
- 2b. The 5 units within the Electrical and Computer Engineering area must include at least 1 unit of courses from an approved list of Electrical Engineering courses (listed in the Electrical and Computer Engineering Department and Program Description section of this catalog)
- 2c. The 5 units within the Electrical and Computer Engineering area must include at least 2/3 unit of courses from an approved list of Computer Engineering courses (listed in the Electrical and Computer Engineering Department and Program Description section of this catalog)
- 2d. The 5 units within the Electrical and Computer Engineering area must include 1/3 unit of Capstone Design Experience. (This requirement is typically fulfilled by the MQP.)
- 2e. Must include at least 1/3 unit of computer science (prefix CS), at the 2000 level or above (other than CS 2011, CS 2022, CS 3043 which cannot be applied to this requirement).
- 2f. Must include at least 1/3 unit of engineering science (prefix ES) at the 2000 level or above. This requirement may also be satisfied by ME 3601. ES 3011 cannot be applied to this requirement.
- 2g. Must include an additional 1/3 unit of engineering science and design at the 2000 level or above, selected from courses having the prefix BE, CE, CM, CS (other than CS 2011, CS 2022, CS 3043), EE, ES, FP, ME, or NE.
- Electrical Engineering courses satisfying requirement 2b: EE 2112, 2201, 2312, 3113, 3204, 3305, 3306, 3311, 3501, 3503, 3703, 3711, 3901, 4304, 4502, and 4902; BE 4011 and 4201; and ES 3011.
- Computer Engineering courses satisfying requirement 2c: EE 2801, 3801, 3803, 3815, 3902 and 4801.

BACHELOR OF SCIENCE IN ELECTRICAL ENGINEERING

The electrical engineering major has traditionally been the only one offered by the ECE department. It currently includes an optional concentration in Computer Engineering. We will continue to offer the EE degree until the ECE degree is accredited, after which point it will no longer be available to incoming classes. Note that even after the EE degree is phased out, any student who matriculated during the time it was still offered retains the option to graduate under its requirements. However, we do encourage all students to consider switching to the new ECE degree.

Based on the department's educational objectives, students will achieve the following specific educational outcomes within a challenging and supportive environment:

1. Preparation for engineering practice, including the technical, professional, and ethical components.
2. Preparation for the future changes in electrical engineering.
3. A solid understanding of the basic principles of electrical engineering.
4. An understanding of appropriate mathematical concepts, and an ability to apply them to EE.
5. An understanding of the engineering design process, and ability to perform engineering design, including the needed teamwork and communications skills.
6. Demonstration of in-depth understanding of at least one specialty within EE.

7. An ability to communicate effectively in written and oral form.
8. An understanding of options for careers and further education, and the necessary educational preparation to pursue those options.
9. An ability to learn independently.
10. The broad education envisioned by the WPI Plan, and described by the Goal and Mission of WPI.
11. An understanding of engineering and technology in a societal and global context.

Program Distribution Requirements for the Electrical Engineering Major

The normal period of residency at WPI is 16 terms. In addition to *WPI requirements applicable to all students*, students wishing to receive the ABET-accredited major designated "Electrical Engineering" must satisfy certain distribution requirements. These requirements apply to 10 units of study in the areas of mathematics, basic science, and engineering science and design as follows:

Requirements	Minimum Units
1. Mathematics and Basic Science (Notes 1, 2, 3, 4).	4
2. Engineering Science and Design (ES/D) (including the MQP) (Notes 5, 6, 7).	6

NOTES:

1. Basic Science courses have prefixes PH, CH, BB, and GE.
2. Mathematics must include differential and integral calculus and differential equations.
3. Must include at least 1/3 chemistry and 2/3 physics or 2/3 chemistry and 1/3 physics.
4. Must include at least 7/3 units of math.
5. The six units of Engineering Science and Design must include at least two courses outside the major area and may include as many as three. All three courses must be at the 2000-level or above. One course requirement must be satisfied by ME 3601 or any course with prefix ES (other than ES 3011). The second course must have the prefix CS (other than CS 2011, CS 2022, CS 3043). If a third course is chosen that does not have the prefix EE, it must be selected from courses having the prefix BE, CE, CM, CS, (other than CS 2011, CS 2022, CS 3043), ES, FP, ME.
6. Must include at least 5 units within the Electrical and Computer Engineering area (including the MQP). All courses designated EE (except EE 3601) are applicable to these 5 units. Also, courses ES 3011, BE 4011, and BE 4201 are applicable to these 5 units.
7. Must include 1/3 unit of Capstone Design Experience.

These distribution requirements in Electrical Engineering apply to all students matriculating at WPI after May, 2003. Students who matriculated prior to May, 2003, have the option of satisfying the distribution requirements in the catalog current at the time of their matriculation.

CONCENTRATION IN COMPUTER ENGINEERING

Within the electrical engineering major, students interested in pursuing a concentration in computer engineering can do so by completing a set of activities as described below. Successful completion results in a B.S. degree in Electrical Engineering with the designation "with concentration in Computer Engineering" noted on the transcript if requested by the student from the Registrar.

This interdisciplinary concentration requires students to develop technical competence in mathematics, basic science, and electrical engineering, with further emphasis in computer engineering, including computer system design, high level languages and operating systems. The Major Qualifying Project provides students with the opportunity to develop in-depth knowledge of some aspect of computer engineering.

In order to be eligible to receive the Computer Engineering designation on their transcripts, students need to satisfy the following course requirements:

- At least six computer engineering related EE or CS courses must be included in the distribution requirements, as follows:
 - At least three of the following EE courses must be included:
 - EE 3803 Microprocessor System Design
 - EE 3815 Digital System Design with VHDL
 - EE 4801 Advanced Computer System Design
 - EE 3902 Introduction to VLSI Design
 - EE 505 Computer Architecture (or CS 4515 Computer Architecture, but not both).
 - At least two 3000 or 4000 level CS courses must be included; CS 3043, Social Implications of Information Processing, cannot be used. The following are particularly recommended:
 - CS 3013 Operating Systems
 - CS 3733 Software Engineering
 - CS 4513 Distributed Computer Systems
 - CS 4514 Computer Networks
 - CS 4515 Computer Architecture (or EE 505 Computer Architecture, but not both).
- In addition to the above course requirements, students must complete an MQP in the computer engineering area approved by the Program Coordinator.

DIFFERENCES BETWEEN THE EE AND ECE MAJORS

The differences between the distribution requirements for the traditional EE major and the new ECE major are fairly modest; many students will find that their programs satisfy both sets of requirements. The primary difference is that the requirements for the ECE major ensure that students achieve greater breadth of knowledge across the discipline than is required by the EE major. The total number of credits in the distribution requirements is the same, as are the numbers of required credits in mathematics and basic science, computer science, and engineering.

The specific differences are:

- ECE majors are required to take at least two courses that focus on computer engineering, and at least three courses that focus on electrical engineering, beyond the basic core level.
- ECE majors must include a course on probability or statistics.
- The minimum basic science requirement for ECE majors is 2/3 units of physics and 1/3 unit in either biology or in chemistry.
- The ECE major does not have any concentration options.

OVERVIEW OF ECE PROGRAM COMPONENTS

The path toward a degree in the ECE Department varies greatly from student to student. To be successful, you must tailor your program to fit your academic needs, working within the boundaries of the major's distribution requirements and WPI's general degree requirements.

This section is intended as a guide to clarify the program components you will need to fulfill the distribution requirements for both ECE and EE majors. It also contains information about general WPI requirements, and advice on how to integrate these elements into your degree plan.

MAJOR QUALIFYING PROJECT (MQP)

In many cases, the pinnacle of a student's undergraduate work at WPI is the MQP, the senior-level design project. Both the ECE and EE degrees require all students to complete an MQP worth 1 unit of study in the major area (the equivalent of 3 courses). Note that this 1 unit is part of the 6 total needed to fulfill the "Engineering Science and Design" distribution requirement. Of the remaining 5 units, 4 units (12 courses) are met by courses in the major area. The breakdown of courses needed is discussed further in the section titled "Other ECE Department Course Work."

Also note that projects that lack a significant engineering design component are typically not approved. Thus, the 1/3 unit of "Capstone Design Experience" required for both ECE and EE majors is almost always a part of the MQP, and need not be fulfilled by a separate course.

The MQP is an extremely important part of your degree program: it is a single project that accounts for the equivalent of three ECE-related courses, and provides some of the most directly relevant preparation you will receive for graduate school or a job in industry. Your MQP can be very rewarding, exciting, and even fun. However, it can also be quite frustrating if you are not adequately prepared. Consequently, when planning your degree program, a good deal of effort should be made to ensure you have developed a solid foundation in all areas of ECE before attempting to begin your project.

SUBDISCIPLINES WITHIN ECE

Given a solid foundation, the MQP will allow you to demonstrate an in-depth understanding of one or more of the subdisciplines that compose the field of electrical and computer engineering. As a guide to the areas of study that can be investigated in an MQP, the ECE Course Flowchart identifies seven subdisciplines as possible areas for in-depth study leading to an MQP. Note that students should not feel constrained by these area designations — this is only one of many possible ways to organize the diverse field of electrical and computer engineering. Many if not most MQPs will incorporate subject matter from several different subdisciplines. The purpose of this list is to guide students interested in a particular area to coursework within a subdiscipline (Area Courses), relevant courses to choose from outside the subdiscipline (Related Courses), and faculty whose research and MQP advising interests fall within the subdiscipline (Area Consultants).

Power Systems Engineering

Area Consultants: Clements, Emanuel, Hakim

Area Courses

- EE 3501 Electrical Energy Conversion
- EE 3503 Power Electronics
- EE 4502 Analysis of Large Scale Power Systems

Related Courses

- ES 3001 Introduction to Thermodynamics
- ES 3011 Control Engineering I
- MG 2850 Engineering Economics
- ME 1800 Materials Selection and Manufacturing Processing

RF Circuits and Microwaves

Area Consultants: Ludwig, Makarov

Area Courses

- EE 2112 Electromagnetic Fields
- EE 3113 RF Circuit Design

Related Courses

- MA 4451 Boundary Value Problems
- PH 3301 Electromagnetic Theory
- PH 3401 Quantum Mechanics I
- PH 3504 Optics

Aerospace and Control Systems

Area Consultants: Labonte, Michalson

Area Courses

- EE 3305 Aerospace Avionics Systems
- ES 3011 Control Engineering I

Related Courses

- EE 2312 Discrete-Time Signal and System Analysis
- EE 3204 Microelectronics II
- EE 3311 Principles of Communication Systems
- EE 3503 Power Electronics
- EE 3801 Advanced Logic Design
- EE 3803 Microprocessor System Design
- EE 4304 Communication Systems Engineering

Communications and Signal Analysis

Area Consultants: Brown, Clancy, Cyganski, Hakim, King, Looft, Makarov, Orr, Pahlavan, Pedersen, Sunar, Vaz, Whitmal

Area Courses

- EE 2312 Discrete-Time Signal and System Analysis
- EE 3311 Principles of Communication Systems
- EE 3703 Real-Time Digital Signal Processing
- EE 3711 Introduction to Electro-Optics
- EE 4304 Communication Systems Engineering

Related Courses

- ES 3011 Control Engineering I
- MA 2071 Matrices and Linear Algebra I
- MA 2621 Probability for Applications
- MA 4291 Applicable Complex Variables

Biomedical Engineering

Area Consultants: Clancy, Pedersen, Papageorgiou, Whitmal

Area Courses

- BE 4011 Biomedical Signal Analysis
- BE 4201 Biomedical Imaging

Related Courses

- EE 2312 Discrete-Time Signal and System Analysis
- BE 3011 Bioinstrumentation and Biosensors
- BE 3110 Experimental Physiology for Engineers
- BE 4101 Bioelectric Phenomena

Analog Microelectronics

Area Consultants: Bitar, Campbell, Labonte, McNeill, Papageorgiou

Area Courses

- EE 2201 Microelectronics I
- EE 3204 Microelectronics II
- EE 3306 Audio Engineering
- EE 3901 Semiconductor Devices
- EE 4902 Analog Integrated Circuit Design

Related Courses

- ES 3011 Control Engineering I
- EE 3801 Advanced Logic Design
- EE 3902 Introduction to VLSI Design

Computer Engineering

Area Consultants: Clancy, Cyganski, Duckworth, Hakim, King, Looft, Michalson, Pahlavan

Area Courses

- EE 2801 Foundations of Embedded Computer Systems
- EE 3801 Advanced Logic Design
- EE 3803 Microprocessor System Design
- EE 3815 Digital System Design with VHDL
- EE 3902 Introduction to VLSI Design
- EE 4801 Advanced Computer System Design

Related Courses

- EE 2201 Microelectronics I
- CS 2223 Algorithms
- CS 3013 Operating Systems
- CS 3733 Software Engineering

OFF-CAMPUS MQP OPPORTUNITIES

The ECE Department offers off-campus MQP opportunities in the following locations: Copenhagen, Denmark; Limerick, Ireland; Silicon Valley, California; and at the NASA Goddard Space Flight Center in Greenbelt, Maryland. These projects are performed as one-term, fulltime MQP experiences; some require a PQP or specific background preparation. Students can submit applications for these programs during B term of the academic year prior to their MQP (typically their junior year). For more information on these and other WPI off-campus programs, please visit the WPI Global Perspective Program website at <http://www.wpi.edu/Academics/Depts/IGSD/Projects>

ECE DESIGN COURSE

The most explicit educational background for the MQP is the course EE 2799, Electrical and Computer Engineering Design. In EE 2799, students spend the term working on a specific design project. The students not only gain experience in the design of a particular system, component, or process, but they also learn a great deal about the design process itself. Moreover, the course is a great opportunity to work on an exciting project with a team of students. (For more information please see the course description.)

Since EE 2799 is direct preparation for the MQP, students are strongly encouraged to successfully complete the course before seeking a senior project. Most ECE faculty will not accept MQP students until they have passed EE 2799.

Before you can pass EE 2799 though, you need to be adequately prepared. As is true for most ECE applications, the projects in EE 2799 require solid background in a variety of sub-disciplines, and thus it is necessary to learn

these fundamentals before taking the course. As background for EE 2799, we strongly recommend (1) all four courses in the “basic core”, and (2) at least one of the four courses in the “advanced core”. These two sets of core courses are explained further in the next section.

Given these recommendations, the best time to take EE 2799 is at the end of your sophomore or beginning of your junior year, once this recommended background has been completed. For more on year-by-year planning, see the section titled “Planning a Program in ECE.”

CORE COURSES

Although electrical and computer engineering is a vast and rapidly expanding field, there remains at its center a core of basic principles. These fundamental concepts, which have changed remarkably little throughout the rich history of electrical engineering, continue to serve as a basis for even the newest technologies. Accordingly, we consider developing a mastery of these fundamentals to be one of your most important tasks as an undergraduate student.

Core courses in the ECE department are divided into two groups: the “basic core” and the “advanced core”. Together, these eight courses represent the bulk of ECE fundamentals, constituting much of what you will need to know as you prepare for EE 2799 and your MQP. The basic core is composed of four courses:

- EE 2011 – Intro to ECE
- EE 2022 – Intro to Digital Circuits and Computer Engineering
- EE 2111 – Physical Principles of ECE Applications
- EE 2311 – Continuous-Time Signal and System Analysis

These courses provide a comprehensive introduction to the fundamentals of ECE. Although you should consult the individual descriptions for each course to obtain detailed information about all the topics covered, the basic core amounts to an overview of central topics in ECE, including basic analog and digital circuits, introductory computer engineering, continuous signals and systems, electric power applications, and basic electromagnetic field theory. Before you attempt EE 2799, we strongly recommend that you take all four of these courses.

The advanced core is composed of another four courses, which are extensions of the material in the basic core:

- EE 2201 – Microelectronic Circuits I
- EE 2801 – Foundations of Embedded Computer Systems
- EE 2112 – Electromagnetic Fields
- EE 2312 – Discrete-Time Signal and System Analysis

Based on preference, you should take at least one of these courses before attempting EE 2799, so you can enter with a greater proficiency in at least one sub-area of ECE. Note, though, that the material in the advanced core is considered fundamental to study in our department, and every student, whether pursuing the ECE or the EE degree, eventually should take all of the courses in the advanced core.

OVERVIEW OF OTHER PROGRAM COMPONENTS

ENGINEERING SCIENCE AND DESIGN

Because modern engineering practice is increasingly interdisciplinary, all students achieve some breadth of study outside of the ECE department by taking a minimum of one Computer Science and one Engineering Science course. Both courses must be at the 2000-level or higher, and certain courses with limited technical content are not credited towards this requirement. (See the formal requirements listed previously in the distribution requirements.) In the Computer Science area, most students will need to complete a CS course at the 1000-level before attempting requirements at the 2000-level or above. Many students find it advantageous to take more than the minimum CS course requirement.

The Engineering Science courses represent cross-disciplinary areas that are applicable to many engineering and science departments. Alternatively, a survey course in Mechanical Engineering (ME 3601) can be taken in place of this Engineering Science requirement, and provides an excellent overview of those Mechanical Engineering topics of interest to ECE students.

MATHEMATICS AND SCIENCE

To succeed in the study of electrical and computer engineering, the necessary foundation far exceeds what can be taught in a few introductory courses. In fact, if you even want to begin to understand what your ECE professors are talking about in lecture, you must begin with a firm basis in mathematics and the natural sciences. Moreover, whether applied to ECE or not, proficiency in mathematics and the sciences is a necessary quality for *any* educated engineer. Consequently, both ECE and EE majors require a total of 4 units (12 courses) as the “Mathematics and Basic Science” distribution requirement.

The first part of this requirement is sufficient education in mathematics. At least 7 of the 12 required courses must be in this area, including coursework in differential calculus, integral calculus, and differential equations. In addition, all ECE majors must take probability and/or statistics, though we recommend this material for EE majors, as well. To see which specific courses fulfill these math requirements, please consult the mathematics course descriptions, the *Planning a Program in ECE* section, and your academic advisor.

The other part of the requirement is coursework in the sciences. A solid understanding of physics is essential to any ECE or EE student, being ultimately necessary for describing the behavior of electricity and magnetism as well as other physical phenomena. Knowledge of chemistry is useful as well, encompassing such topics as atomic and molecular behavior and the chemical properties of materials (such as silicon, which is quite useful in ECE). In recent years, knowledge of biology has also become important to electrical and computer engineers, particularly as biomedical-electrical technologies such as medical imaging continue to advance.

For both majors, we require at least 3 courses in the sciences. For the newer ECE degree, 2 of these courses must be in physics, and the remaining course may be in chemistry or biology depending on preference. The older EE degree requires that the 3 courses be composed of either 2 physics courses and 1 chemistry course, or 1 physics course and 2 chemistry courses.

Finally, note that in both degree programs, the total prescribed mathematics and science courses add up to 3 1/3 units (10 courses). To meet the distribution requirement, you then must take at least 2 more courses in any area of mathematics or science (that is, any other course with the prefix "MA", "PH", "CH", "BB", or "GE").

PLANNING A PROGRAM IN ECE

The following section is intended to be a guide for planning your ECE or EE degree program. Of course, it is by no means a *complete* guide—you should consult several other important sections of this catalog for further information. These sections include WPI's general degree requirements, information regarding the three required projects (Sufficiency, IQP, MQP), and the specific descriptions for any courses we have mentioned. Also, be sure to consult your academic advisor in any matters related to the course scheduling and the fulfillment of degree requirements.

A NOTE ON ACADEMIC ADVISING

Our department—and WPI as a whole—offers you the opportunity of an education that is highly individualized. As no two students are identical in terms of their academic skills, interests, and aspirations, no two students should have identical academic programs. This chance to tailor a degree program to your individual needs is indeed a great opportunity, and the burden of seizing such an opportunity falls primarily on you, the student. However, adapting to WPI's complex system of courses, projects, and other degree requirements is certainly not an easy task.

Fortunately, you possess a great set of resources to help you, including your peers, the faculty and staff of the ECE department—and most importantly—your academic advisor. As you proceed through your years of undergraduate education, always remember that your academic advisor can be of great assistance. He or she is a source of advice and information, helping you with decisions about what courses to take, what projects to pursue, your personal and professional development, and how ultimately to make the most of your WPI experience. Your academic advisor can even help you find a job or get accepted to a graduate program.

As you get to know your academic advisor, remember: though he or she may contribute as much guidance as possible, most of the effort in planning your program must come from you. If, though, you simply cannot work well with your academic advisor for any reason, it is your responsibility to find one with whom you are more comfortable.

FRESHMAN YEAR

Planning your first year at WPI may appear confusing and difficult, especially since there are so many different options. This section will help you make sense of these options, and identify the courses that are most important

to complete freshman year. Always remember, though, that there is no single "perfect" academic program.

As mentioned earlier, before you can begin coursework in the ECE Department, you need a proper foundation in mathematics. You should begin by completing differential and integral calculus as soon as possible. If you have insufficient background in pre-calculus topics, you may begin with the semester-long MA 1020 course. If not, then you should begin with MA 1021. In either case, you should definitely follow with MA 1022. Students with a background in high school calculus (such as an AP course) may skip ahead to begin with MA 1022, MA 1023, or even MA 1024. Consult your advisor to find out which starting point is right for you. Incidentally, note that MA 1020/1021 and MA 1022 fulfill the differential and integral calculus part of the "Mathematics and Basic Science" distribution requirement (for both the ECE and EE majors).

The next step in planning your freshman year is to address the science requirement, especially with one or two physics courses. The physics courses most directly relevant to ECE are PH 1120 or PH 1121 (which deal with electricity and magnetism) and PH 1140 (which deals with oscillations and waves). When choosing physics classes, be sure to pay attention to any recommended background such as calculus. You may also consider taking a chemistry or biology course in your freshman year. We encourage students to investigate further any mathematics or science courses that they find interesting; as always, consult your academic advisor for help.

For many students—in particular those with little experience in programming—freshman year is the best time to address the computer science requirements of the ECE and EE degrees. For students with a moderate background in computers, either CS 1005 or CS 1006 provides a suitable introduction to programming concepts. You may then continue on to more advanced computer science courses such as CS 2005.

If you have planned properly, you should be ready to begin coursework in ECE or EE by the spring semester of your freshman year. The first course for all students should be EE 2011, usually followed by EE 2022. A majority of ECE and EE students begin their major coursework with EE 2011 in C-term of their freshman year, followed by EE 2022 in D-term. If you feel that you are not ready to take EE 2011 by C-term, the course is offered again in D-term, and you can even wait until A-term of your sophomore year. Whenever you begin with your major coursework, be sure to complete the recommended background for EE 2799 in time to take it in your sophomore or junior year.

In addition to all of your major coursework and its related background, do not forget that, at some point, you will need to complete a Sufficiency project! You may want to schedule some Sufficiency-related coursework for your freshman year, especially if you want to complete the project in your sophomore year. Also, as social science courses, such as economics, are typically helpful for the IQP, you may want to take those courses as soon as possible (or at least at some point before your junior year). Finally, do not forget the physical education requirement.

In choosing your courses for freshman year, keep in mind that the WPI degree requirements call for three “free elective” courses; if you pass all of your classes at WPI, you will end up with a total of six courses which you can choose with no restrictions whatsoever. This flexibility can be used for a variety of purposes, such as pursuing another major or minor, delving deeper into your Sufficiency area, honing your skills within your major beyond the minimum courses required, or even just taking a few extra courses that interest you. In other words, do not be afraid early on to take a course simply because it may not be “worth credit” toward your degree. Freshman year is a great time to explore the wide array of topics a WPI education has to offer.

SOPHOMORE YEAR

As you plan for your sophomore year, one important task will be to continue progress in your major. This process is assisted by careful planning on your part, particularly if you want to take EE 2799 by D-term of your second year.

The following tables display two examples of desirable course sequences for an ECE or EE student. Both show series of courses that would allow a student to arrive at EE 2799 in D-term with the proper recommended background (without considering such factors as recommended mathematics or science).

Example #1:

Term		Course
Freshman	C	EE 2011
	D	EE 2022
	A	EE 2111
Sophomore	B	EE 2311
	C	Any course in the advanced core
	D	EE 2799

Example #2:

Term		Course
Freshman	C	EE 2011
	D	EE 2022
Sophomore	A	EE 2801 or EE 2201
	B	EE 2311
	C	EE 2111
	D	EE 2799

Of course, if you desire even greater flexibility in your schedule, there are many paths besides these two. For example, you may take two ECE courses concurrently in a term, provided that one is not recommended background for the other. Also, you may wait until B-term of your junior year to take EE 2799; this decision may be helpful if you chose not to start your ECE classes until later, or if you want to have a stronger background in ECE, math-

ematics, or science before attempting the course. However, we do advise against waiting until the *end* of junior year (or later) to take EE 2799, as it may hinder your ability to find an MQP on time.

By the end of sophomore year, you should have finished taking most of your mathematics and science classes, as these courses serve as background for further work in your major. Also, all ECE and EE students should complete the computer science requirement in this year, if they have not yet done so.

Many students choose to complete their Sufficiency project in the sophomore year. If you have finished the 5 courses requirement for the Sufficiency, then you may consider this option. Before you schedule your project, be sure to find and approach an advisor with whom you would like to work. On the other hand, if you did not make much progress in completing humanities courses as a freshman, you should do so in this year. Do not feel rushed, though—you do not necessarily have to complete your Sufficiency requirement as a sophomore. Some of the best Sufficiency projects at WPI are completed by juniors and seniors, so feel free to schedule your work in the humanities in a way that best suits you.

Another important task in your second year is to investigate WPI’s “Global Perspective Program”. Many WPI students perform their IQP at an off-campus project site; this is especially true in the ECE Department. However, if you are planning to complete your IQP off-campus as a junior, the application process begins in your *sophomore* year. For more information about off-campus projects, see the “Projects” section of this catalog, or contact the Interdisciplinary and Global Studies Division (IGSD).

Finally, keep in mind that by the end of sophomore year, you should be sufficiently educated in ECE to attempt an internship in industry during the following summer, if you so desire. If you are interested, be sure to talk to your academic advisor, and investigate the resources available at WPI’s Career Development Center.

JUNIOR YEAR

With all the freshman- and sophomore-level background finally completed, your third year of education in the ECE department offers you a chance for greater flexibility and control over your degree program. However, if you have yet to do so, your first priority is to complete EE 2799. Also, once the design course is completed, you should finish the remaining courses in the advanced core as soon as possible.

After that, you will finally have a chance to branch out into the many other ECE courses we offer. When choosing major courses for the junior year, be sure to seek a balance between depth and breadth. On one hand, there is a wide selection of 3000-level courses from which to choose, extending the basic and advanced core into even more areas of ECE. These courses will allow you to explore more of the discipline, and gain even greater proficiency in any of the core areas you may have found interesting. On the other hand, if you are particularly interested in a single sub-discipline, you may be ready by the end of junior year to attempt a 4000-level course (depending on course on the specific class and its recommended background).

ELECTRICAL AND COMPUTER ENGINEERING COURSE FLOW CHART

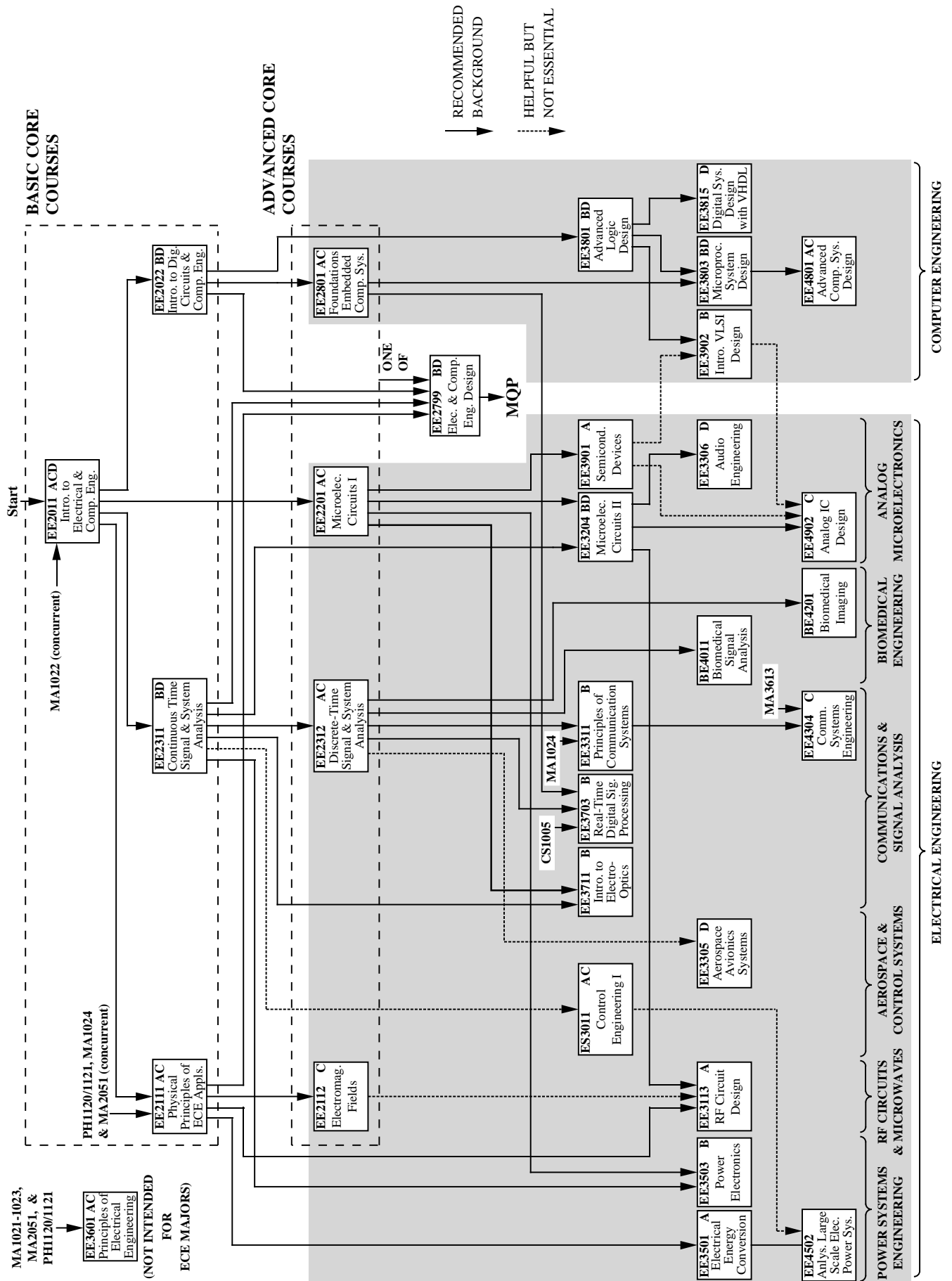

Despite the opportunities available to you in ECE, the most substantial component of your work junior year will most certainly be your Interactive Qualifying Project. If you are planning to complete your IQP off-campus, be sure to take additional care in planning your courses around the term that you will be away. Also, in the term before you leave, off-campus projects typically require 1/3 unit or more of preparatory work. You should take this extra burden into account as part of the workload for that term.

Yet another key undertaking of the junior year is your responsibility to find an MQP. If you are planning to do the project off-campus as a senior, you will need to follow an application procedure similar to that of off-campus IQPs. If you are planning to complete the project on-campus, then the efforts needed to find a project may vary greatly. You may need to apply to and interview for certain industry-sponsored MQP programs, or you might contact a professor in the department who has advertised a specific project he or she wants to advise. Consult with your academic advisor about what types of projects interest you, and what approach is best to secure an MQP for the next year.

Finally, do not forget about your Sufficiency, your social science courses, the ES requirement, and your physical education classes.

SENIOR YEAR

Depending on how well you have done in developing your degree program in the previous three years, planning for senior year can be a breeze—or a disaster. However, even if you are new to the idea of taking academic planning seriously, there is still plenty you can do to ensure that you will be walking across the stage on graduation day.

By far, the most important part of your senior year is your MQP. The ways of scheduling your project are quite varied, depending on the type of project, location, students, and advisors. Off-campus MQPs last for about 1 term, and are offered A-term, B-term, and C-term at various locations (see “Off Campus MQP Opportunities” in the “Overview of ECE Program Components” section). A typical on-campus MQP usually requires 1/3 unit of work in three consecutive terms—commonly A-term through C-term of the senior year. From time to time senior projects may run longer, extending into D-term. Any student wishing to graduate on time, however, must remember two things: (1) all MQP students must be ready to give their final presentations on the annual Project Presentation Day in April, and (2) the final MQP report, with the proper accompanying paperwork, must be submitted by the registrar’s specified deadline.

If your MQP is on the right track, the next step is to choose your remaining ECE courses, which can be accomplished in many different ways. Some students select courses that will directly help them in an upcoming job or graduate program. Other students choose courses to supplement the topics they are covering in their MQP. Some use the remaining courses to expand their breadth of knowledge into an area where they are weak, while others use senior year to take those one or two 4000-level courses in areas where they desire more expertise. All of

these approaches are valid; the important thing is to think critically about your academic goals, and choose a path that best fits your current academic program, while allowing you to explore courses that appear interesting.

Besides your remaining major coursework, your plan for senior year must include everything else you need to complete to graduate. For example, some students choose to do their Sufficiency project senior year. Also, do not forget the many other degree requirements that we have repeatedly mentioned—you certainly do not want to graduate late because you forgot 1/12-unit physical education class! Be sure to have your academic advisor check your course plan at the beginning of senior year, to verify that you have not overlooked anything.

GRADUATION AND BEYOND

There is one essential task of any senior year student that we failed to mention in the previous section. As the year progresses, seniors have to plan for the “next step”—their lives *after* graduation.

A common direction for students to choose upon graduation is full-time employment. The job-seeking process is not always easy, requiring mastery of many important life skills, such as writing a resume or participating in a job interview. Fortunately, there are many resources available to aid you in this process, including the Career Development Center, your academic advisor, other professors, and your peers. One of the best places to network with potential employers is at any of the regularly scheduled “career fairs”, when companies send representatives to WPI to search for qualified applicants. Also, do not forget to utilize the internet as a tool for publishing resumes and investigating potential employers. Since a thorough and comprehensive job search can last several months, be sure to start early.

Another option is to continue with a program of academic study—typically a graduate degree. If you wish to begin study in the fall semester, realize that most graduate schools set their application deadlines in December or January, and the deadlines for many fellowship competitions may occur even earlier. In any case, if you are interested in beginning a graduate program directly after graduation, you should be investigating potential schools, the programs they offer, and any fellowships or scholarships that may be available by the end of your junior year and during the following summer. Once again, the Internet can provide invaluable assistance during this effort. Note that many graduate school and fellowship applications require you to take certain standardized tests, such as the Graduate Record Examinations (GRE’s). Be sure to investigate thoroughly dates of preparation courses, test dates, and the delay time for receiving test results. You must allow time to prepare for and take all the necessary tests, and still receive the results in time to use with your graduate applications. Finally, do not forget that a degree in ECE or EE is useful for far more than a future in engineering. The degrees we offer are excellent preparation for a wide array of graduate studies, including education, business, or law.

When choosing one of these routes, keep in mind that here in the ECE department, we expect from you a commitment to lifelong learning. In other words, even if you choose not to continue immediately with your formal

studies, it does not mean the end of your education! First of all, there is always the chance to learn within a job in industry, through projects, training programs, and other learning opportunities. Furthermore, many students decide to return to graduate school after a few years of working, often finding that such “real-world” experience is a great advantage upon returning to academia. Regardless of the path you choose after leaving the ECE department, always remember that your WPI degree (while extremely valuable) is certainly not the end of your education—it is only a foundation for years of learning yet to come.

STUDENT GROUPS IN ECE

A good way to ensure a commitment to lifelong learning is through membership in engineering-related organizations such as professional societies. Professional societies are a vital aid to the dissemination of technical knowledge, helping engineers in industry remain abreast of recent discoveries. Accordingly, we encourage you to include membership in these kinds of organizations as part of your cocurricular activities.

With more than 350,000 members, the Institute of Electrical and Electronics Engineers (IEEE) is the world’s largest technical professional society. The IEEE supports a number of student chapters, which are responsible for more than 50,000 of its active members. The IEEE student chapter at WPI is particularly active: in addition to managing the undergraduate lounge on the first floor of Atwater-Kent Laboratories, student members host department-wide events such as information sessions, guest speakers, and barbecues. Another student group is WECE (Women in Electrical and Computer Engineering), which offers women students a chance to meet and discuss academics, employment, and other opportunities in ECE.

Students in the ECE department are also eligible for nomination to various honor societies. Eta Kappa Nu (HKN) is the international honor society for students in electrical and computer engineering. In addition to honoring outstanding students in the department, HKN organizes a number of activities, awards, and scholarships. Exceptional students in the ECE department are also eligible to become elected members of Tau Beta Pi (TBP), the international honor society for all engineering students. For both societies, students exhibiting the necessary qualities of scholarship, leadership, and character are approached for membership in either their junior or senior year of study.

TRANSFER STUDENTS

Since the ECE department’s introductory curriculum is different from the traditional program offered at many other schools, transfer students must be sure to confer with their advisor to plan their WPI program. Transfer students with no previous ECE courses should begin the program in the same way as first-year students. Students with some transfer credit may be able to omit one or more of the introductory courses. Those with one or more courses in circuit theory and substantial laboratory experience should consider omitting EE 2011, and possibly one or more of the other basic core courses, but this should only be done after consultation with an academic advisor.

INFORMATION FOR NON-MAJORS

Students who wish to develop a background in electrical and computer engineering are advised to consult with a faculty member in the ECE Department. A basic foundation in electric circuits and electronics may be obtained by taking EE 2011, EE 2111, EE 2201, and EE 2311. A basic foundation in the elements of computer engineering may be obtained by taking EE 2011, EE 2022, EE 2801, and EE 3801. An overview of basic electric circuits can be obtained by taking EE 3601.

Electrical and computer engineering may be coupled with other areas of study to define a unique interdisciplinary program. Students contemplating such an innovative program should contact the Interdisciplinary and Global Studies Division for guidance and approval, especially with regard to the selection of a suitable MQP and arrangements for program-specific distribution requirements; see *Interdisciplinary Programs* for more information.

MINOR IN COMPUTER ENGINEERING

This interdisciplinary minor requires students to develop competence in areas of computer engineering, including both hardware and software aspects of computer systems. This minor is not available to students majoring in EE or ECE. Students majoring in EE may file for a Concentration in Computer Engineering with Prof. Looft.

Selected rules for a Minor include the following:

1. Two or more units of thematically related activity.
2. Concluding 1/3 unit of the Minor must be a capstone experience.
3. A Minor may include any portion of the academic program, excluding the MQP.
4. At least one-unit of the Minor, including the capstone activity, must be free electives.
5. The Program Review Committee for a Minor area will consist of faculty members designated by the sponsoring faculty members.

In order to be eligible to receive the Computer Engineering Minor designation, at least six computer engineering related ECE and CS courses must be included in the distribution requirements, listed below. Other appropriate courses may be substituted with the approval of the Computer Engineering Minor Program Review Committee.

- A. At least three of the following ECE courses must be included.
 - EE 2801 Foundations of Embedded Computer Systems
 - EE 3801 Advanced Logic Design
 - EE 3803 Microprocessor System Design
 - EE 3815 Digital System Design with VHDL
 - EE 3902 Introduction to VLSI Design
 - EE 4801 Advanced Computer System Design
 - EE 505 Computer Architecture
- B. At least three of the following CS courses must be included.
 - CS 2011 Introduction to Machine Organization and Assembly Language
 - CS 3013 Operating Systems
 - CS 3733 Software Engineering

- CS 4513 Distributed Computer Systems
- CS 4514 Computer Networks
- CS 4515 Computer Architecture (can not be counted if EE 505 is selected)

C. Capstone Courses

The following courses may be used to satisfy the Computer Engineering minor capstone requirement: EE 3803, EE 3815, EE 3902, EE 4801, CS 4513, CS 4514, CS 4515.

ENGINEERING SCIENCE COURSES

In the formation of a program of study for any engineering or science student, it is important to emphasize a significant number of interdisciplinary courses which form the fundamental building blocks of so many scientific and engineering activities.

In addition to those courses in science and mathematics which are an important part of every engineer's background at WPI, there are a number of courses containing subject matter common to a variety of disciplinary interests. These courses are known as the "engineering science group" and are often taught jointly by members of more than one department.

Every engineer, for example, needs to have some knowledge of graphics, the communications tool of engineering; of thermodynamics, the consideration of an important aspect of energy and its laws; of mechanics, solid and fluid, static and dynamic, the treatment of forces and their effects on producing motion. These and certain other courses of either basic knowledge or broad application are grouped in the engineering science series to provide special focus on them for all students interested in applied science or engineering. In developing programs to meet engineering science distribution requirements, students and advisors should give careful attention to these engineering science courses.

ENGINEERING PHYSICS

ADVISOR: T. H. KEIL

Programs of study in Engineering Physics are listed under the Physics Department. These programs include specialization in such areas as computational techniques, optics, electromagnetism, materials science and engineering, nuclear science and engineering, and thermal physics.

ENVIRONMENTAL PROGRAMS

Undergraduate students may pursue environmental studies at WPI through a variety of programs and departments.

Students should review these programs as listed below, and talk with their academic advisors and the respective program coordinators, to help make a good choice of environmental major at WPI. In every program, the WPI project requirements, both in the major field and the IQP, will provide unusually strong support for defining specific career directions. Students are also urged to make use of the "Global Perspective Program" to carry out one project abroad, and thus attain a sense of environmental studies at a global, cross-cultural level.

ENVIRONMENTAL ENGINEERING

Civil/Environmental Engineering with Emphasis on Water Quality Control

Coordinators: Profs. O'Shaughnessy, Hart, Mathisen, Plummer, or Bergendahl, Civil Engineering

The Department of Civil Engineering at WPI provides courses leading to an ABET-accredited degree in Civil Engineering. Areas of concentration include the planning, design, construction, operation and regulation of water quality control systems related to water supply and waste treatment. Related issues include public health and solid waste management. The engineering focus is in the area of large systems associated with municipal and other public projects.

Students majoring in this program would follow a general curriculum in Civil Engineering, with emphasis on the environmental engineering subarea. Such preparation leads to a degree recognized by the professional accrediting organization, ABET (Accreditation Board for Engineering and Technology), and is an excellent start for entry-level professional placement or graduate study in environmental engineering.

Chemical/Environmental Engineering with Emphasis on Pollution Prevention and Abatement Technology

Coordinators: Profs. Wyslouzil, Thompson, Ma, Dixon, DiBasio, or Clark, Chemical Engineering

The Department of Chemical Engineering at WPI provides a general curriculum leading to an ABET-accredited degree in chemical engineering. Undergraduates can become involved in a specialty area of environmental engineering through their MQP or other independent projects, and are encouraged to work with faculty in their own areas of research in these fields. Today's chemical engineers are challenged to help maintain industrial competitiveness while ensuring a healthy environment. Chemical engineers with environmental emphasis design and develop environmentally benign chemical processes aimed at preventing pollution at its source by recycling or eliminating all hazardous components. Additionally, they are involved in developing environmentally friendly products like biodegradable packaging materials. Chemical engineers' understanding of the physical and chemical properties of pollutants makes them uniquely qualified to develop technical solutions to current environmental problems of soil, water, and air pollution.

Students majoring in this program would follow a general curriculum in Chemical Engineering, with elective coursework in environmental engineering and environmental related project work. Such preparation leads to a degree recognized by the professional accrediting organization, ABET (Accreditation Board for Engineering Technology), and is an excellent start for entry-level professional placement or graduate study in environmental engineering.

Manufacturing/Environmental Engineering with Emphasis on Environmentally-Conscious Manufacturing

Coordinator: Prof. Sisson, Manufacturing Engineering

The Manufacturing Engineering program at WPI provides a general curriculum leading to an ABET-accredited degree in manufacturing engineering. Undergraduates can become involved in a specialty area of environmental engineering through their MQP or other independent projects, and are encouraged to work with faculty in their own areas of research in these fields. One of the fastest growing research areas within manufacturing engineering is that of design for the environment and environmentally-conscious manufacturing. Since manufacturing engineering is multi-disciplinary by nature, students can join the program with interests in environmental engineering, computer science, management, and electrical or mechanical engineering, or with other interests.

Students majoring in this program would follow a general curriculum in Manufacturing Engineering, with emphasis on environmental engineering course and project work. Such preparation leads to a degree recognized by the professional accrediting organization, ABET (Accreditation Board for Engineering and Technology), and is an excellent start for entry-level professional placement or graduate study in environmental engineering, manufacturing engineering, or management.

ENVIRONMENTAL SCIENCES

Biology-Biotechnology/Environmental Sciences

Coordinator: Prof. T. Crusberg, Biology & Biotechnology

The department of Biology & Biotechnology offers a curriculum leading to a degree in Biology & Biotechnology with a concentration in Ecology and Environmental Biology. Relevant topics under investigation by the departmental faculty include bioremediation, behavioral and conservation ecology, release of genetically altered organisms, and micro environmental regulation of growth and development in bioreactors. Course work in marine ecology is also available off campus through a cooperative arrangement with the Marine Biological Laboratory in Woods Hole. Off campus project work in conservation ecology with the Mass. Audubon Society and the Mass. Div. of Fisheries and Wildlife occurs as demand warrants.

Students with Biology & Biotechnology degrees will be prepared for entry-level professional work, or for graduate studies leading to a master's or doctoral degree.

ENVIRONMENTAL ECONOMICS AND PUBLIC POLICY

Social Sciences and Policy Studies

Coordinators: Profs. Saeed or Rissmiller, Social Sciences and Policy Studies

The Department of Social Sciences and Policy Studies at WPI provides a general curriculum leading to degrees in three separate areas: Economics and Technology, Society-Technology, or Economics. Students interested in careers in environmental studies involving any of these three areas could pursue programs in SSPS, leading to careers in business, research, or government.

Students majoring in one of these three SSPS programs will be prepared for entry-level professional work, or for graduate study either for the MBA or a master's or doctoral research program.

ENVIRONMENTAL STUDIES

Humanities/Environmental Studies

Coordinator: Prof. R. Gottlieb, Humanities & Arts Department

The Humanities Department at WPI offers a general curriculum leading to degrees with concentrations in literature, philosophy and religion, and history. Students interested in humanistically-oriented environmental studies could major in the humanities, and take a specifically designed program involving one or more of these areas. Career possibilities upon graduation would include law, business, government service, environmental activism, journalism, or graduate study in the humanities.

Interdisciplinary Environmental Studies

Coordinator: Prof. Davis, Interdisciplinary and Global Studies Division

Students wishing to design their own unique program in any field of environmental studies at WPI can do so through the Interdisciplinary and Global Studies Division (IGSD). Such a program might, for example, involve roughly equal areas of study in biology and biotechnology, chemical engineering, and social science and policy studies. Many other possible combinations also exist, with differing levels of study in both scientific and technological disciplines, and in social sciences, policy studies or humanities (ethics). Examples of areas for major study include (but are not limited to):

- identification and production of micro-organisms to remove heavy metals from the water supply, and
- technical writing for environmental organizations.

Interdisciplinary programs are coordinated through the IGSD, and advised by a panel of three faculty from different disciplines. Many students also explore the course offerings at Clark University and the College of the Holy Cross, which are available at no cost through the Worcester Consortium. Students with interdisciplinary programs will be prepared for entry-level professional employment or graduate study.

FIRE PROTECTION ENGINEERING

D. A. LUCHT, DIRECTOR;

PROFESSORS: J. R. Barnett, R. W. Fitzgerald,

D. A. Lucht, R. E. Zalosh

ASSOCIATE PROFESSORS: , N.A. Dembsey,

F. Noonan, B. J. Sivilonis

ASSISTANT PROFESSOR: J. P. Woycheese

AFFILIATE PROFESSORS: W. K. Kim, P. J. Pagni,

E. S. Yoon

MISSION STATEMENT

To deliver a high quality fire protection engineering education program for both full-time students and practicing professionals, supported by fire research in selected areas of strength.

EDUCATIONAL GOALS

- To deliver a comprehensive fire protection engineering degree/certificate program that is consistent with changes in technology and the environment.
- To maximize the use of educational technology to deliver for-credit courses to both part time and full time students, on and off campus worldwide.

INTRODUCTION

Fire protection engineering is one of the best kept secrets in career education today. Employers and personnel recruiters consistently report good job opportunities each year. Starting salaries have proved to be competitive and generally above the overall engineering profession average.

Fire protection engineers can be called upon to provide a broad range of services. Some perform firesafety evaluations of buildings and industrial complexes to determine the risk of fire losses and how best to prevent them. Others design systems which automatically detect and suppress fires and explosions as well as fire alarm, smoke control, emergency lighting, communication, and exit systems. Fire protection engineers perform research on materials and consumer products or the computer modeling of fire and smoke behavior. Others investigate fires or explosions, preparing technical reports, or providing expert courtroom testimony in civil litigation cases.

Fire protection engineers work at the nerve centers of large corporations and oversee the design and operational firesafety of complex manufacturing facilities in multinational business networks. They also work for insurance companies, surveying major facilities, and performing research, testing, and analysis.

Fire protection engineers can be found at all levels of government, worldwide. They work for architectural and engineering firms and specialty consulting groups. Interesting jobs are available in trade associations, testing laboratories, and at colleges and universities.

WPI's one-of-a-kind fire protection engineering program offers a variety of educational opportunities to suit most every student need. These include the combined degree program through which the student may earn an undergraduate degree in one of the traditional disciplines and the master's degree in fire protection engineering in as little as five years. The master of science, and doctor of philosophy in fire protection engineering are also available.

For those interested in preparing for a career in this challenging field, we recommend obtaining a B.S. degree in one of the traditional engineering disciplines and developing the experience in solving fire-related problems through qualifying project work under the supervision of faculty from WPI's Center for Firesafety Studies. An introductory undergraduate course (FP 3070 Fundamentals of Firesafety Analysis) makes an excellent companion to the qualifying project.

For advisory information (including a free fire protection engineering careers video or CD-Rom), students may contact Prof. D. Lucht, Director of the Center for Firesafety Studies.

COMBINED-DEGREE PROGRAM

A combined-degree program is available for those undergraduate students having a strong interest in fire protection. This program provides students with the opportunity to accelerate their graduate work by careful development of their undergraduate plan of study leading to a B.S. degree in a field of engineering and a master's degree in fire protection engineering. The combined-degree approach saves time and money since up to 40 percent of course credits counted towards the master's degree can also be counted toward the bachelor's degree. Holders of B.S. degrees in traditional engineering or science disciplines and the master's degree in fire protection engineering enjoy extremely good versatility in the job market.

FIVE-YEAR PROGRAM

High school seniors can be admitted to the combined-degree program as freshmen, allowing them to complete both a bachelor's degree in a selected field of engineering and the master's degree in fire protection engineering in five years.

GRADUATE INTERNSHIPS

A unique graduate internship program is available, allowing students to gain important clinical experiences in practical fire protection engineering and research environments. Students are able to earn income, alternating work and on-campus classroom and laboratory activities.

HUMANITIES AND ARTS

P. J. M. QUINN, HEAD

PROFESSORS: F. Bianchi, J. J. Brattin, S. C. Bullock, D. B. Dollenmayer, R. S. Gottlieb, K. P. Ljungquist, J. Manfra, L. J. Menides, W. T. Mott, P. J. M. Quinn, A. A. Rivera, L. E. Schachterle, T. A. Shannon, M. M. Sokal, J. Trimbur, S. Vick, J. F. Zeugner

ASSOCIATE PROFESSORS: W. A. B. Addison, Jr., L. J. Curran, J. P. Hanlan, P. H. Hansen, E. M. Parkinson, M. D. Samson, R. L. Smith

ASSISTANT PROFESSORS: M. K. Ephraim,

H. J. Manzari, J. Sanbonmatsu

ADJUNCT FACULTY: J. Arend, W. A. Baller, T. W. Code, M. C. Davila, J. Delorey, R. G. Falco, J. L. Forgeng, M. C. Gherardi, D. E. Gray, P. M. Lahey, G. K. Lew, M. Manzari, B. L. McCarthy, C. Merithew, T. Naksa, D. O'Donnell, M. E. Pignataro, J. R. Policelli, S. Runstrom, J. E. Watters, D. G. Weeks

PROFESSORS EMERITUS: D. McKay, E. Hayes, C. Heventhal

MISSION STATEMENT

We are committed to helping students develop both a knowledge of, and an ability to think critically about, the humanities and arts. We also seek to foster the skills and habits of inquiry necessary for such learning: analytical thought, clear communication, and creative expression. Such an education, we believe, provides a crucial foundation for responsible and effective participation in a complex world.

INTRODUCTION

The humanities and arts—art history and architecture, drama/theatre, foreign languages, history, literature, music, philosophy, religion, and writing/rhetoric—are central to WPI's vision of the new "liberal education." All WPI undergraduates devote a significant portion of their academic program to the humanities and arts either through a "Humanities and Arts Sufficiency Program" or through a major, double-major, or minor in the department.

The humanities and arts promote intellectual curiosity and maturity by developing the essential skills for further study and lifelong learning. These include the ability to think critically, to write and speak clearly and persuasively, to appreciate and cultivate the literary and aesthetic arts, and to understand the rich cultural diversity of the world in the past and present. Students in the humanities and arts grapple with fundamental questions of justice, value or meaning through reading, observation, creation, interpretation, and performance. These are, in fact, the activities of the highly productive Humanities and Arts faculty, which is well regarded for research, publication and creative work. Through the humanities and arts, the faculty enable students to gain self-knowledge and to broaden cultural horizons.

The Department of Humanities and Arts offers a variety of opportunities for students to pursue personal interests. The Department offers an interdisciplinary curriculum, in which students may investigate multifaceted topics using a variety of approaches. The major or

double-major in Humanities and Arts is interdisciplinary in scope (see page 117). In addition, the Humanities and Arts Sufficiency Program may culminate in a thematic project that integrates previous courses from several areas of the humanities and arts. The Sufficiency Program also might result in a theatrical or musical performance or in proficiency in a foreign language. Students should also consider unique opportunities to complete a Sufficiency Project at a Global Project Center. (For details of the Sufficiency Program, see page 54.)

The close working relationship among students and faculty in the humanities and arts at WPI promotes academic excellence, innovative thinking, and mutual respect. In short, the Humanities and Arts Department is committed to helping students develop both a knowledge of, and the ability to think critically about, the humanities and arts. We also seek to foster the skills and habits of inquiry necessary for such learning—analytical thought, clear communication, and creative expression. Such an education provides a crucial foundation for responsible and effective participation in a complex world.

HUMANITIES AND ARTS MAJOR

The Humanities and Arts major requires six units of work, including the MQP. Students take courses from across the humanities and arts, but may choose to focus their program of study by completing a Concentration as described below.

The major or double-major in Humanities and Arts is excellent preparation for a variety of careers. Humanities and Arts graduates from WPI have gone to law, business, and medical schools, as well as to graduate programs in the discipline of their Humanities and Arts concentration. Some graduates have pursued careers as writers, teachers, engineers, or scientists. Other students have found work in the theatre as actors, technicians, or playwrights, or in music as composers or performers. The advantages our graduates find in their pursuit of further study and careers are the advantages of a rigorous study of the liberal arts: a good foundation in our cultural traditions and the cultural diversity of the world, and strong skills in research, analysis, writing, literary and musical composition or performance.

In addition, since each Humanities and Arts major completes either a "technical sufficiency" or a double major in a technical field, our graduates receive unique preparation as technological humanists. This educational experience gives them a distinct advantage in many fields in which a solid knowledge of engineering or science is increasingly valuable, such as environmental studies, drama/theatre, or business. The Humanities and Arts major equips students with vital general professional skills and with broad cultural and technical perspectives. Our many courses devoted to international issues or to foreign languages, and the active involvement of Humanities and Arts faculty in the university's global programs provides superb training for technological humanists interested in international issues. Whatever their specific area of concentration, majors in the Humanities and Arts gain an intellectual curiosity and openness to the diversity of human cultural achievements that will enrich their lives and enhance their careers.

Program Distribution Requirements for the Humanities and Arts Major

1. Humanities and Arts (including MQP) (Note 1)	6
2. Electives (Note 2)	4

NOTES:

- Humanities and Arts majors may choose to complete 2 units of work and an MQP in one of the following areas of Concentration: History, Literature, Music, Philosophy, Religion, Drama/Theatre, Writing and Rhetoric, Art History, German Studies, Hispanic Studies, American Studies, Environmental Studies, or Humanities Studies of Science and Technology.
- May be from any area except Aerospace Studies, Military Science, or Physical Education. Courses used to satisfy other degree requirements (i.e. the IQP and the Sufficiency) may not be used to fulfill this requirement.

CONCENTRATIONS FOR HUMANITIES AND ARTS MAJORS

Humanities and Arts majors may focus their studies by choosing a Concentration within a specific area of the Humanities and Arts, or within an interdisciplinary area closely related to the Humanities and Arts. Concentrations within the Humanities and Arts Department comply with WPI's requirements for Concentrations. Students must complete an MQP and two units of integrated study in the area of their Concentration. Concentrations within the Humanities and Arts (History, Literature, Music, Philosophy, Religion, Drama/Theatre, Writing and Rhetoric, Art History, German Studies, Hispanic Studies) require two units of work in an area designated by specific disciplinary course prefixes, as described below. For example, a Concentration in History requires two units of HI courses at the 2000 level or higher and an MQP in history. Concentrations that are interdisciplinary in nature (American Studies, Environmental Studies, and Humanities Studies of Science and Technology) each require that courses be selected from specific lists of designated courses.

All of these Concentrations are excellent preparation for a variety of careers. Graduates of the Humanities and Arts major have gone to law, business, and medical schools, as well as to graduate programs in the discipline of their Humanities and Arts concentration. Some graduates have pursued careers as writers, teachers, engineers, or scientists. Other students have found work in the theatre as actors, technicians, or playwrights, or in music as composers or performers. The advantages our graduates find in their pursuit of further study and careers are the advantages of a rigorous study of the liberal arts: a good foundation in our cultural traditions and the cultural diversity of the world, and strong skills in research, analysis, writing, or performance.

In addition, since each Humanities and Arts major completes a "technical sufficiency" or a double major in a technical field, our graduates receive unique preparation as technological humanists. This educational experience gives them a distinct advantage in many fields in which a solid knowledge of engineering or science is increasingly valuable, such as environmental studies, drama/theatre,

or business. The Humanities and Arts major equips students with vital general professional skills and with broad cultural and technical perspectives. Our many courses devoted to international issues or to foreign languages and the active involvement of Humanities and Arts faculty in the university's global programs provides superb training for technological humanists interested in international issues. Whatever their specific area of concentration, majors in the Humanities and Arts gain an intellectual curiosity and openness to the diversity of human cultural achievements that will enrich their lives and enhance their careers.

REQUIREMENTS

Humanities and Arts with History Concentration

2 units of HI (2000 level or higher) and MQP in History

Humanities and Arts with Literature Concentration

2 units of EN, TH, or RH (2000 level or higher) and MQP in Literature

Humanities and Arts with Music Concentration

2 units of MU (2000 level or higher) and MQP in Music

Humanities and Arts with Philosophy Concentration

2 units of PY (2000 level or higher) and MQP in Philosophy

Humanities and Arts with Religion Concentration

2 units of RE (2000 level or higher) and MQP in Religion

Humanities and Arts with Drama/Theatre Concentration

2 units of TH, EN, or RH (2000 level or higher) and MQP in Drama/Theatre

Humanities and Arts with Writing and Rhetoric Concentration

2 units of RH, EN/WR, or TH (2000 level or higher) and MQP in Writing and Rhetoric

Humanities and Arts with Art History Concentration

2 units of AR or HU and MQP in Art History

Humanities and Arts with German Studies Concentration

2 units of GN (2000 level or higher) and MQP in German Studies

Humanities and Arts with Hispanic Studies Concentration

2 units in SP (2000 level or higher) and MQP in Spanish

HUMANITIES AND ARTS WITH AMERICAN STUDIES CONCENTRATION

This interdisciplinary concentration examines American culture from the multiple perspectives of American history, literature, and politics. American Studies at WPI takes advantage of the unparalleled resources at the American Antiquarian Society.

- 1/3 units: one of the following courses: HU 1411 Introduction to American Studies, EN 1231 Introduction to American Literature, EN 1257 Introduction to African American Literature and Culture, HI 1311 Introduction to American Urban History, HI 1312 Introduction to American Social History, or HI 1314 Introduction to Early American History.

2. 2/3 units from List 1 ("American History")
3. 2/3 units from List 2 ("American Literature")
4. 1/3 units from List 3 ("American Politics, Law, and Policy"). This may not include courses taken to fulfill the Social Science Requirement.

5. MQP in American Studies

List 1. American History:

- HI 2311 American Colonial History
- HI 2313 American History, 1789-1877
- HI 2314 American History, 1877-1920
- HI 2315 The Shaping of Post-1920 America
- HI 2316 American Foreign Policy from Woodrow Wilson to the Present
- HI 2317 Law and Society in America, 1865-1910
- HI 2331 American Science and Technology to 1859
- HI 2332 American Science and Technology from 1859
- HI 3311 American Labor History
- HI 3312 Topics in American Social History
- HI 3314 The American Revolution
- HI 3333 Topics in American Technological Development

List 2. American Literature:

- EN 2221 American Drama
- EN 2231 American Literature: The Raven, the Whale, and the Woodchuck
- EN 2232 American Literature: Twain to the Twentieth Century
- EN 2233 American Literature: Twentieth Century
- EN 2234 Modern American Novel
- EN 2235 The American Dream: Myth in Literature and the Popular Imagination
- EN 2237 American Literature and the Environment
- EN 2238 American Realism
- EN 3221 New England Supernaturalism
- EN 3232 The Concord Writers
- EN 3233 Worcester Between the Covers: Local Writers and Their Works
- EN 3224 Modern American Poetry
- EN 3237 Pursuing Moby-Dick

List 3. American Politics, Law, and Policy:

- SS 1301 U.S. Government
- SS 1303 American Public Policy
- SS 1310 Law, Courts, and Politics
- SS 2121 Government Budgets and Fiscal Policy
- SS 1203 Social Problems and Policy Issues
- SS 2302 Science-Technology Policy
- SS 2304 Governmental Decision Making and Administrative Law
- SS 2310 Constitutional Law
- SS 2311 Legal Regulation of the Environment
- SS 3278 Technology Assessment and Impact Analysis Seminar

HUMANITIES AND ARTS WITH ENVIRONMENTAL STUDIES CONCENTRATION

This interdisciplinary concentration combines course work from the humanities and arts, social sciences, and other areas to examine environmental issues.

1. 3/3 units from List 1 ("Designated Environmental Courses in Humanities")
 2. 2/3 units from List 2 ("Related Environmental Courses in Social Sciences"). These may not include courses taken to fulfill the Social Science Requirement.
 3. 1/3 units from List 3 ("Environmental Courses in Other Areas")
 4. MQP in Environmental Studies
- List 1. Designated Environmental Courses in Humanities:
- AR 2113 Topics in 19th- and 20th-Century Architecture
 - EN 2237 American Literature and the Environment
 - HI 1311 Introduction to American Urban History
 - HI 1341 Introduction to Global History
 - HI 2334 European Technological Development
 - HI 3331 Topics in Science, Technology, and Society
 - HI 3333 American Technological Development
 - PY 2712 Social and Political Philosophy
 - PY 2713 Bioethics
 - PY 2717 Philosophy and the Environment

List 2. Related Environmental Courses in Social Sciences.

- SS 2117 Environmental Economics
- SS 2125 Development Economics
- SS 2311 Legal Regulation of the Environment
- SS 2312 International Environmental Policy
- SS 2405 The Psychological Study of Environmental Issues
- SS 3278 Technological Assessment and Impact Analysis Seminar

List 3. Environmental Courses in Other Areas:

- BB 2040 Principles of Ecology
- CM 3910 Chemical and Environmental Technology
- CM 3920 Air Quality Management
- CE 3059 Environmental Engineering
- CE 3070 Urban and Environmental Planning
- CE 3074 Environmental Analysis
- ME 3422 Environmental Issues and Analysis

HUMANITIES AND ARTS WITH HUMANITIES STUDIES OF SCIENCE AND TECHNOLOGY CONCENTRATION

This interdisciplinary concentration enables students to apply to the methods of the humanities and social sciences to the study of science and technology.

1. 2/3 units from List 1 ("Designated HSST Courses")
 2. 2/3 units from List 1 or List 2 ("Closely Related Courses in Humanities")
 3. 2/3 units from List 3 ("Science-Technology-Studies Courses in Other Areas"). These may not include courses taken to fulfill the Social Science Requirement.
 4. MQP in Humanities Studies of Science and Technology
- List 1: Designated HSST Courses
- AR 2113 Topics in 19th- and 20th-Century Architecture
 - EN 2252 Science and Scientists in Modern Literature
 - EN 3215 Genres of Science Writing

- HI 1331 Introduction to the History of Science
 HI 1332 Introduction to the History of Technology
 HI 2331 American Science and Technology to 1859
 HI 2332 American Science and Technology from 1859
 HI 2333 History of Science from 1700
 HI 2334 European Technological Development
 HI 3331 Topics in Science, Technology, and Society
 PY 2713 Bioethics
 PY 2717 Philosophy and the Environment

List 2: Closely Related Courses in Humanities

- AR 3112 Modernism, Mass Culture, and the Avant-Garde

- HI 1311 Introduction to American Urban History
 HI 2324 Industry and Empire in British History
 HI 3311 American Labor History
 HI 3323 Topics in the Western Intellectual Tradition
 PY 2711 Philosophical Theories of Knowledge and Reality

List 3: Science-Technology-Studies Courses in Other Areas.

- ID 3150 Light, Vision and Understanding and the Scientific Community
 SS 2208 The Science-Technology Debate
 SS 2302 Science-Technology Policy
 SS 2304 Governmental Decision Making and Administrative Law
 SS 2311 Legal Regulation of the Environment
 SS 2312 International Environmental Policy
 SS 3278 Technology Assessment and Impact Seminar

DOUBLE MAJOR IN HUMANITIES AND ARTS

Students may pursue a double major in Humanities and Arts and in an area of science, engineering, or management. To pursue the double major, a student must satisfy all of the degree requirements of the technical discipline including an MQP and Distribution Requirements. In addition, the double major in Humanities and Arts requires 6 units of studies in the Humanities and Arts, including the MQP. Students pursuing a double major, one of which is Humanities and Arts, are not required to complete a Sufficiency Program in Humanities and Arts, nor are they required to complete a second IQP. Students interested in pursuing this option should contact Prof. B. Addison, 39 Dean St., Room 260, for additional information.

The demand for graduates equipped with the background possessed by a WPI student with a double major in the Humanities and Arts is likely to increase. Many fields, including medicine, law, industry, theatre technology, commerce, and public service, will be open to those who have acquired both the skills of humanistic education and technical or managerial knowledge.

OTHER HUMANITIES AND ARTS MINORS

Minors can be arranged in areas other than the above. See Prof. Addison, 39 Dean Street, for further information about minors in other areas and interdisciplinary minors.

MINOR IN FOREIGN LANGUAGE (GERMAN OR SPANISH)

The minor in Foreign Language can be completed in either German or Spanish. It allows students who are well prepared to continue their study of the language and its culture well beyond the advanced level. The minor consists of a total of two units of work, distributed in the following way:

- 1 unit of intermediate and advanced language courses in Spanish or German chosen from the following:

- SP 2522, SP 3521, SP 3522, or higher or
- GN 2512, GN 3511, GN 3512, or higher.

(This unit may be double-counted toward the Sufficiency. No more than one unit may be double-counted in this way.)

2. 2/3 unit of advanced literature and culture courses chosen from the following:

- SP 3523, SP 3524, or Consortium courses approved by a faculty member in Spanish or
- GN 3513, GN 3514, or Consortium courses approved by a faculty member in German.
- Any 3000-level experimental course in GN or SP may also be used.

3. 1/3 unit capstone experience consisting of an IS/P written in the foreign language.

(If, in the future, there are enough German and Spanish minors combined, the capstone independent study will be a team-taught seminar in comparative civilization/literature.) Interested students should see the following professors in the Humanities and Arts Department: Prof. Dollenmayer (for German) or Prof. Rivera and Prof. Fontanella (for Spanish).

MINOR IN MUSIC

The minor in Music is for students who choose to continue their studies in Music beyond the Sufficiency project requirement without majoring in Music. Students who, for personal or career purposes, wish to achieve official recognition of their achievements in Music, yet do not find the time to fulfill the requirements for the major, should consider the Music minor option. Interested students should speak with: F. Bianchi, L. Curran, or D. Weeks, in the Department of Humanities and Arts. Because performance is an integral component of music study with proposed minor will contain performance emphasis and consist of two units of work distributed as follows:

1. 1/3 unit for participation in MU IS/P Ensembles.
2. 1/3 unit Performance IS/P as the capstone experience. Student, with faculty guidance, will present a recital, original composition, or other musical performance that demonstrates the student's skill and knowledge.
3. 1 1/3 units of music courses.
4. If a student completes his/her Sufficiency project in music, 1 unit of that work may be applied to the minor except for the final IS/P.
5. A student who is pursuing a major in Humanities and Arts with music as the major field cannot also receive a minor in music.

MINOR IN WRITING AND RHETORIC

The minor in Writing and Rhetoric offers students the opportunity to extend their study of writing and rhetoric beyond the Sufficiency requirement without majoring in either the Writing and Rhetoric concentration in Humanities and Arts or the Technical, Scientific, and Professional Communication program. The minor consists of two units of work, distributed in the following way:

1. 2/3 unit. Core courses in writing and rhetoric: RH 3111, RH 3112
2. 1 unit. Electives in writing and rhetoric, chosen from the following: EN/WR 2211, EN/WR 3214, EN/WR 3216, EN/WR 3217, EN/WR 3011, and RH 3211. If there is good reason and with the approval of the Program Review Committee, electives may also include courses in art history, literature (in English or other languages), and philosophy and religion.
3. 1/3 unit. Capstone IS/P.
No more than 1 unit of coursework may be double-counted toward the Sufficiency requirement.

INDUSTRIAL ENGINEERING

The Industrial Engineering major is a program of the Management Department. Please refer to page 123 for more information.

INTERDISCIPLINARY PROGRAMS

P. DAVIS, DEAN;
R. F. VAZ, ASSOCIATE DEAN;
N. MELLO, DIRECTOR OF GLOBAL OPERATIONS
S. VERNON-GERSTENFELD, DIRECTOR OF ACADEMIC OPERATIONS
 ADJUNCT ASSISTANT PROFESSORS: F. Carrera, R. Krueger, C. Peet, G. Theyel

The Provost Office, in conjunction with the Interdisciplinary and Global Studies Division (IGSD), operates those academic functions or programs which require an interdisciplinary administrative structure. In addition, the IGSD also provides the support structure for students who construct individually-designed (ID) majors which cannot readily be accommodated in traditional academic departments.

ID majors may be defined in any area of study where WPI's academic strengths can support a program of study, and in which career goals exist. Many combinations of technical and non-technical study are possible. Do not be limited by the example given here; if you have questions about what programs at WPI are possible, please see Prof. R. Vaz in the Project Center to discuss how WPI can assist you in reaching your goals.

Procedure For Establishing an Interdisciplinary (Individually-Designed) Major Program

Students who wish to pursue an individually-designed major program should first discuss their ideas with their academic advisor. The student should then consult with the dean of the IGSD, Prof. Paul Davis, who will determine, with the assistance of other members of the faculty, if the proposed program is feasible, and, if it is, arrange for its evaluation.

The following procedures will be followed for feasible programs:

1. The student must submit to the dean of the IGSD an educational program proposal, including a "definition of scope," and a concise statement of the educational goals of the proposed program. **Goals (such as graduate school or employment) should be specified very clearly.** The proposal must be detailed in terms of anticipated course and project work. The proposal must be submitted no later than one calendar year before the student's expected date of graduation, and normally before the student's third year.
2. The Dean of the Interdisciplinary and Global Studies Division will name a three-member faculty committee, representing those disciplines most involved in the goals of the program, to evaluate the proposal. The committee may request clarification or additional information for its evaluation. The proposal, as finally accepted by the committee and the student, will serve as an informal contract to enable the student to pursue the stated educational goals most effectively.
3. Upon acceptance of the proposal, the student will notify the Office of Academic Advising and the Projects and Registrar's Office of the choice of ID (individually-designed) as the designation of major. The IGSD then becomes the student's academic department for purposes of record-keeping.
4. The three-person faculty committee will serve as the student's program advisory committee, and will devise and certify the distribution requirements (up to a limit of 10 units including the MQP) appropriate to the student's program.

EXAMPLES OF INTERDISCIPLINARY PROGRAMS

In recent years, students have graduated in interdisciplinary programs in the following areas:

Environmental (Water Pollution) - Civil Engineering
 Environmental (Air Pollution) - Chemical Engineering
 Urban and Environmental Planning - Civil Engineering

Courses for these programs are located *primarily in the departments listed above*. Students interested in these programs should read the appropriate departmental descriptions before consulting with the chair of the IGSD about developing an ID major.

The programs below are the established majors administered through IGSD.

TECHNICAL, SCIENTIFIC, AND PROFESSIONAL COMMUNICATION

CO-DIRECTORS: J. Trimbur (HUA), C. Demetry (ME)
ASSOCIATED FACULTY: M. Elmes (MG),
 K. Lemone (CS), A. Rivera (HUA), R. Smith (HUA)

The program in Technical, Scientific, and Professional Communication (TC) is concerned with the theory, ethics, research, and practice of representing information in a variety of communication media—computer documentation, instruction manuals, hypertext, multimedia presentations, graphics, video, brochures, newsletters, public relations, scholarly writing, journalism, and literary non-fiction. The goal of the TC program is to prepare communication professionals who can bridge the gap between technical scientists and engineers and the public by presenting technical information in useful and accessible ways.

The TC program is an interdisciplinary major that combines work in written, oral, and visual communication with a strong concentration in a scientific or technical field. In consultation with a faculty program review committee, majors design a plan of study that fulfills the distribution requirements of the program and best suits their intellectual interests and career aspirations.

The TC major provides excellent preparation for students interested in careers in technical and scientific communication, editing, journalism, public relations, education, and publishing and for students who intend to pursue graduate studies in fields such as communication, education, journalism, and rhetoric and composition.

MQP opportunities are available on campus and with local companies, newspapers, public agencies, and private foundations.

Distribution Requirements

TECHNICAL, SCIENTIFIC, AND PROFESSIONAL COMMUNICATIONS	Minimum Units
1. Scientific and/or technical concentration (Note 1)	6
2. Writing and Rhetoric concentration (Note 2)	3
3. MQP	1

NOTES:

- The student's scientific and/or technical concentration must be a plan of study, approved by the student's program review committee, with a clear underlying rationale in mathematics, basic science, computer science, engineering, and/or management.
- The Writing and Rhetoric concentration consists of 1 unit in each of the 3 following categories of courses. Courses taken to fulfill these distribution requirements will not include courses that fulfill other degree requirements, such as the Humanities and Arts Sufficiency and the Social Sciences requirement. Exceptions to this restriction, not to exceed 1 unit, must be approved by the student's program review committee, and will be granted only under unusual circumstances.

A. Written communication (1 unit)

Recommended courses:

- EN/WR 2211 Elements of Writing
- EN/WR 3011 Peer Tutoring in Writing
- EN/WR 3214 Writing About Disease and Public Health
- EN/WR 3216 Writing in the Professions or equivalent writing courses or ISPs

B. Rhetoric and communication studies (1 unit)

Recommended courses:

- RH 3111 The Study of Writing
- RH 3112 Rhetorical Theory
- RH 3211 Rhetoric of Visual Design or ISP or any of the courses listed in Category A not used to fulfill that requirement.

C. Electives (1 unit)

The 1 unit of electives must be coherently defined and approved by the student's program review committee. Students may draw on:

Courses in science, technology, and culture studies (such as AR/ID 3150, CS 3041, CS 3043, EN 2252, EN 3235, HI 2331, HI 2332, HI 2333, HI 2334, HI 3331, SS 2207, SS 2208, or SS 2302);

Philosophy and ethics courses (such as PY 2711, PY 2713, PY 2714, PY 2716, PY 2717, PY/RE 2731, PY/RE 3731);

Foreign language courses;

Management courses.

TEACHER LICENSING

WPI students wishing to be licensed as middle or high school teachers in Massachusetts or states with reciprocity agreements with Massachusetts in the areas of Mathematics, Biology, Chemistry or Physics can do so by passing the Massachusetts Teacher Test (METL) in English and their subject area, taking a Teaching Methods course (ID 310X), performing observation and practice teaching, and taking courses in the appropriate subject matter meeting State guidelines. Students wishing to discuss or pursue this should see Professor John Goulet (MA).

INTERNATIONAL STUDIES

P.H. HANSEN, DIRECTOR

ASSOCIATED FACULTY: W.A.B. Addison (HU),
 D.B. Dollenmayer (HU), L. Fontanella (HU),
 P.H. Hansen (HU), M.J. Radzicki (SSPS),
 K.J. Rissmiller (SSPS), A. Rivera (HU), and
 J.F. Zeugner (HU)

International Studies prepares men and women for future leadership roles in business and industry, government and public affairs. International Studies integrates WPI's international courses in the humanities and social sciences with its global projects and exchange programs. International Studies courses on-campus prepare students to go abroad. After an experience overseas, students integrate their experiences and explore their career options in a capstone seminar. International Studies at WPI offers a range of options including a minor, major, or double major in International Studies.

MINOR IN INTERNATIONAL STUDIES

The goals of WPI's minor in International Studies are to extend students' global horizons, enhance their disciplinary majors, and expand their career opportunities in the international arena. The program develops a familiarity with global or international issues, an appreciation of cultural differences, and the ability to complete tasks abroad. The minor achieves a basic level of competence in International Studies through a variety of courses, projects, and overseas experiences.

The minor requires a minimum of three units of work related to International Studies as described below. After course work at WPI, students complete their minor through either an international IQP or an international exchange program approved by the Program Review Committee. All students are required to have an international experience off-campus. The program's capstone experience is a Senior Seminar in International Studies. Both options receive the same designation of Minor in International Studies. A student in any major at WPI is eligible to pursue a Minor in International Studies.

Program Requirements for the International Studies Minor

INTERNATIONAL STUDIES IQP OPTION

	Minimum Units
International Core (Note 1)	1
International Electives (Note 2)	1
International IQP (Note 3)	1
International Experience (Note 4)	0
Total	3

INTERNATIONAL STUDIES EXCHANGE PROGRAM OPTION

	Minimum Units
International Core (Note 1)	1
International Electives (Note 2)	2
International Experience (Note 4)	0
Total	3

NOTES:

- International Core. Both options require the same one unit core of international courses. One course must be selected from each of these categories:
 - An introductory course in international history, such as HI 1341, HI 1321, HI 1322, HI 1323, or HI 1313.
 - A course in understanding cross-cultural differences, such as one of the following: HU 3411 Pro-Seminar in Global Perspectives, or SS 2406, Cross-Cultural Psychology; or SS 1202 Sociological Concepts and Comparative Analysis; or PY 2716 Philosophy of Difference.
 - HU 4411 Senior Seminar in International Studies.

Courses in the core may not double-count towards other degree requirements such as the Humanities and Arts Sufficiency requirement or the two course requirement in the Social Sciences. If a student has already counted a course from a) or b) for another requirement, they will be required to take additional courses in International Studies so that at least one unit of their minor does not double-count. The capstone seminar should be the final element of a student's minor.

- International Electives may be selected from among international courses in the Humanities and Social Sciences. They may include any course in European or global history; any course at the intermediate level or above in German or Spanish; any international course in the social sciences; and international courses approved by the Program Review Committee in art history, literature, philosophy and religion. If approved by the Program Review Committee, PQPs for overseas projects may count towards the total. Students may count courses taken to fulfill other degree requirements towards these electives. These electives may not include the MQP or the final 1/3 unit Type 5 IS/P of the Sufficiency Program.
- International IQP: Students who choose the IQP Option must complete an International IQP. All IQPs completed outside of the United States meet this requirement. If approved by the Program Review Committee, IQPs completed on-campus or at Project Centers in the United States may meet this requirement if the IQP is devoted to an international subject and the student also completes a study abroad experience as described in note 4.
- International Experience: All International Studies minors are required to have a study abroad experience. Students who choose the Exchange Option must complete an international project, exchange, or internship approved by the Program Review Committee. The study abroad experience should be educational in nature and equivalent in length to at least one WPI term.

For general policy on the minor, see description on pages 26-27.

MAJOR IN INTERNATIONAL STUDIES

The International Studies Major is an interdisciplinary program that combines rigorous preparation in international studies with competence in an area of science, technology, or management. Under the broad umbrella of the International Studies distribution requirements, students will be able to create their own flexible programs to accommodate their interests and career goals. MQPs may be completed on campus or at one of WPI's global project centers. In consultation with the Program Review Committee, students plan a course of study that may focus on a region of the world, or a thematic issue, or an analytical approach to international studies. International Studies majors are well prepared for careers in business, government, and public affairs.

Distribution Requirements for the International Studies Major

REQUIREMENTS	Minimum Units
International Core (Note 1)	1
International Fields (Note 2)	4
International Experience (Note 3)	0
Electives (Note 4)	4
MQP	1
Total	10

NOTES:

- International Core: One course must be selected from each of these categories:
 - An introductory course in international history, such as HI 1341 or HI 1313, HI 1321, HI 1322, HI 1323.
 - A course in understanding cross-cultural differences, such as one of the following: HU 3411 Pro-Seminar in Global Perspectives, or SS 2406 Cross-Cultural Psychology; or SS 1202 Sociological Concepts and Comparative Analysis; or PY 2716 Philosophy of Difference.
 - HU 4411 Senior Seminar in International Studies.

2. International Fields: Majors complete at least one unit of work in each of the following areas. They must also complete at least one additional unit of work in one of these areas, which will be considered their primary field.
 - a) Historical Analysis. These include any courses in European history, world history, or American foreign policy.
 - b) Language, Literature, and Culture. These include any course in foreign languages, civilization, and literature offered at WPI or in the Consortium with the prior approval of the Program Review Committee; also courses approved by the Program Review Committee in Art History (e.g. AR 1111, AR 2111), English Literature (e.g. EN 2243, EN 3222), Music History (e.g. MU 2615), or Philosophy and Religion (e.g. RE 2721, RE 2724). Majors who designate Language, Literature, and Culture (LLC) as their primary field may not take courses in a second foreign language unless they have achieved 3000-level proficiency in the first. LLC designees should take most of their courses in a single discipline or in a coherent program approved by the Program Review Committee.
 - c) Social Sciences. These include international courses in the social sciences (e.g. SS 1320, SS 2105, SS 2125, SS 2312, SS 2406). Students may count courses taken for the two-course requirement in Social Sciences.
3. International Studies majors are required to have a study-abroad experience. (In very unusual cases exceptions may be made to this requirement but only with prior approval of the Director and Program Review Committee). This abroad experience may take the form of a project, exchange, or internship approved by the Program Review Committee. The study-abroad experience should be educational in nature and equivalent in length to at least one WPI term.
4. Electives may be from any area except Aerospace Studies, Military Science or Physical Education. Double-majors may count as electives courses taken for their other major. Majors who are not completing a double-major are required to complete a two-unit technical sufficiency in an area of science, engineering, or mathematics apart from these electives.

DOUBLE MAJOR IN INTERNATIONAL STUDIES

Students may pursue a double major in International Studies and any area of study at WPI except a major in Humanities and Arts. To pursue the double major, a student must satisfy all of the degree requirements for both disciplines, including an MQP and Distribution Requirements. In addition, the double major in International Studies requires the same distribution of courses in the International Core and International Fields as the major in International Studies and a second MQP in International Studies. Double majors are also required to have an International Experience. Students pursuing the double major in International Studies are not required, however, to complete a Humanities and Arts Sufficiency program.

RECOMMENDATIONS FOR STUDENTS

Students planning an International Studies minor, major, or double major should take their International Core courses in international history and cross-cultural differences before they go abroad. Since many students go off-campus during their Junior year, students should plan to take these Core courses in their Freshman and Sophomore years. Students are also encouraged to take their International Electives before going abroad and on topics that relate to their international experience. The capstone

course, HU 4411, Senior Seminar in International Studies, should be the final element of the minor. Therefore, students may enroll in HU 4411 after they have completed all of the other requirements for the International Studies minor. Students planning an International Studies minor may also wish to consider the possibility of completing a double major in International Studies.

INTERNATIONAL EXPERIENCES

An International Experience may take the form of an international IQP or exchange program. Students often plan their international experience in their Sophomore year. All students are advised to consult the list of projects offered at WPI's Global Project Centers. Each fall, the projects and exchange programs for the following year are widely advertised on campus. For information about student exchange programs, see page 234.

Award-winning projects at WPI are frequently on international topics. Recent examples include studies of a workshop for the blind in London, chemical accidents in Bangkok, the social impact of the building code in New Zealand, and the use of biogas in Botswana. International Studies offers the opportunity not only to complete some of the highest quality projects at WPI, but also to offer solutions to some of the most challenging problems in the world.

Students interested in International Studies may ask any member of the Associated Faculty for more information, or they may consult our page on the World Wide Web: <http://www.wpi.edu/+IN/>.

LAW AND TECHNOLOGY MINOR

As science and technology evolve, there are growing needs for professionals who both understand science and technology and who work within the institutions of the American legal system. At all levels, from federal courts to state regulatory agencies and local planning commissions, policy makers decide issues in an environment of legal rules and principles. Yet to be effective, they must also understand how science and technology can aid their decisions, the methods and conclusions of scientific research, and the social impact of decisions. Without science, environmental regulators cannot decide on measures for hazardous waste disposal, public health officials cannot evaluate new drug therapies, utility regulators cannot authorize new sources of electric power, judges cannot construe the meaning of medical testimony, and attorneys cannot cross examine an expert witness in a product failure case. Decision makers, and those who attempt to influence them, find that they need to understand science and technology.

The Law and Technology Program is an interdisciplinary minor that can be used to supplement a major, introduce students in science and engineering disciplines to legal studies and prepare students to enter law school upon graduation. Students in the program begin their

studies with a foundation in legal institutions and analysis and continue with advanced courses that integrate law and technology. A course in professional communication is also required. Students complete their studies with a capstone research activity either in the sixth course or as a separate independent study.

To attain a Minor in Law and Technology, students must complete two units of study (6 courses) as follows:

1. Two of the following courses in legal fundamentals:

- HI 2317 Law and Society in America, 1865-1910
- SS 1310 Law, Courts and Politics
- SS 2310 Constitutional Law
- MG 2950 Business Law and Ethics

2. Two of the following courses which integrate law and technology:

- CE 3022 Legal Aspects in Design and Construction
 - CE 4071 Land Use Development and Controls
 - SS 2311 Legal Regulation of the Environment
 - SS 2313 Intellectual Property Law
 - SS/ID 2314 Cyberlaw and Policy
- Independent study or experimental courses with the approval of the pre-law advisor

3. One of the following courses in professional communication:

- EN/WR 2211 Elements of Writing
- EN/WR 3214 Writing About Disease and Public Health
- EN/WR 3216 Writing in the Professions
- RH 3112 Rhetorical Theory

4. One of the following courses undertaken as a capstone experience:

- SS 2304 Governmental Decision Making and Administrative Law
- SS 2313 International Environmental Policy

If a student takes both SS 2304 and SS 2313, the first one taken will count among courses that integrate law and technology, point 2., above. Minors enrolled in either course for their capstone experience will be required to complete the usual course requirements and an additional research paper. In the paper, the student will summarize existing law in an area of student interest, identify problems with the law, evaluate proposals for change and recommend legislative changes. As an alternative, students may complete the capstone requirement as an independent study (IS/P) course with the approval and participation of one of the associated faculty.

Students should review their program of study with the associated faculty and/or pre-law advisor. Students are also encouraged to seek IQP opportunities in Division 52, Law and Technology. See page 46. Note: only one of the two units may be counted toward other college requirements.

For general policy on the Minor, see description on pages 26-27.

MANAGEMENT

M. C. BANKS, HEAD

S. A. JOHNSON, DIRECTOR IE PROGRAM

D. M. STRONG, DIRECTOR MIS PROGRAM

PROFESSORS: M. C. Banks, M. B. Elmes, A. Gerstenfeld, J. T. O'Connor, H. G. Vassallo

ASSOCIATE PROFESSORS: S. A. Johnson, C. J. Kasouf, F. Noonan, D. M. Strong

ASSISTANT PROFESSORS: E. Daneels, H. N. Higgins, E. Loiacono, S. McCoy, J. Mistry, K. Mukherjee, S. Taylor, O. Volkoff, K. Wilkens, A. Zeng, J. Zhu

ADJUNCTS: G. Heaton, J. Minasian

VISITING FACULTY: J. Sulej

INTRODUCTION

The Department of Management provides undergraduate and graduate management education designed to help aspiring managers and executives understand how to use technology to help organizations and individuals succeed in their business endeavors. Our courses combine a practical component, which helps our students apply what they learn, and a theoretical component, which helps them understand why it works and how to use it in other settings. Many courses include a strong global component to help our students understand business beyond the borders of the United States. Additionally, most courses include a discussion of ethics and force students to wrestle with right and wrong. That our approach is successful is demonstrated in our strong placement record, the above (national) average salaries of many of our graduates, and that within five years of graduation they earn, on average, more than any other WPI graduates in the same class.

We provide a number of educational opportunities for our students. We offer undergraduate majors in Industrial Engineering (IE), Management (MG), Management Engineering (MGE), and Management Information Systems (MIS), and minors in Entrepreneurship, Management, Management Information Systems, and Organizational Leadership. At the graduate level we offer the MBA, MS in Operations and Information Technology, MS in Marketing and Technological Innovation, our combined BS/MBA program, and our graduate certificates in Technology Marketing, Management of Technology, Information Technology, and Electronic Commerce.

OUR STRATEGIC INTENT

To be the premier provider of undergraduate and graduate education focused on the Management of Technology.

OUR MISSION

The Department of Management at WPI is committed to providing education, research, and outreach that focus on:

- leading and managing technology-based organizations;
- integrating technology into the workplace; and
- creating new processes, products, services, and organizations based on technology.

We emphasize:

- innovative and project-based education that integrates the theory and the practice of management, and prepares students to assume positions of leadership in an increasingly global business environment;
- basic scholarship, while also valuing the scholarship of application and the scholarship of instruction; and
- interaction with the business community focused primarily on technological entrepreneurship.

required to apply to a particular college for admission. Improvement can mean reducing cost, reducing the time required to complete the process, or reducing the number of errors. To be effective, industrial engineers must combine technical knowledge with concerns about how people fit into the systems they design - skills that organizations need a lot right now. Industrial engineers take a systems view, considering all the resources (people, technology, information) that are part of the process. Industrial engineers find jobs in manufacturing firms, hospitals, transportation firms, and government agencies. An industrial engineer might be in charge of quality on a production line, develop computer models to improve service to patients in a hospital clinic, or work to reduce inventory costs. Many industrial engineers move into supervisory or management positions as their career progresses.

INDUSTRIAL ENGINEERING

Industrial engineers focus on process improvement. The process might be a manufacturing line, where each process step is a physical operation that creates a product, or might involve paper and information, such as the steps

INDUSTRIAL ENGINEERING PROGRAM CHART

Note: This chart summarizes recommendations regarding course selection, sequencing, and timing. Students are encouraged to read the Program Distribution Requirements and Curriculum Guidelines for IE for more complete information. Students are also encouraged to arrange their programs to take advantage of global and cooperative education opportunities.

	FRESHMAN/SOPHOMORE	JUNIOR	SENIOR
COURSE RECOMMENDATIONS	Calculus Sequence MA 1021, MA 1022, MA 1023, MA 1024, MA 2051 Statistics Sequence MA 2611; MA 2612 or MA 2621 H&A Sufficiency Physics/Chemistry Sequence PH 1110, PH 1120, CH 1010; or PH 1110, CH 1010, CH 1020 CS 1005 Start IE Core: MG/IE 2500 MG/IE 3400 MG 2720 Social Science 2 Math/Science Electives	IQP Complete IE Core: MG/IE 2850 MG/IE 2300 MG/IE 3401 MG/IE 3420 or MG/IE 3501 MG/IE 3460 Engineering Basics Outside IE 2 IE Electives: Choices: MG/IE 3405, MG/IE 3420, MG/IE 3450, MG/IE 3501, MG/IE 3720, MG/IE 4410, MG/IE 4460, MG/IE 4720, and OR courses in MA 1 Technical Elective Any engineering/science design course (see page 125 for recommendations)	MQP 1 IE Elective 2 Technical Electives At least 3 Free Electives Complete any remaining degree requirements
DEGREE REQUIREMENTS	H&A Sufficiency (2 units)		
		IQP (1 unit)	
	Math/Science (4 units)		
		Industrial Engineering Topics (5 units)	
	Social Science (2/3 units)		MQP (1 unit)
		Free Electives (1 unit)	
		Physical Education (1/3 unit)	

At WPI, the IE program is designed to provide students with the tools to spearhead process improvement efforts and the knowledge to implement and employ new technologies. Industrial engineering majors at WPI complete courses in three major categories: (1) the basic mathematics and science courses that are the foundation for all engineering disciplines, (2) core courses that address the tools that industrial engineers use to effect process improvements, including such things as computer simulation and theories of human behavior, and (3) elective courses that can be tailored to your career objectives.

The Major Qualifying Project (MQP) is an integral part of the education of our majors. In addition to satisfying a significant graduation requirement, the MQP must be focused on industrial engineering design. It is typically performed for a business organization. These two elements of our approach to MQPs result in a very valuable learning experience for all of our students. Examples of the MQP for industrial engineering majors include:

- Lean Manufacturing Cell Development at Teradyne
- Process Improvements for the CFM56-3 at General Electric Engine Services
- Reduction of Quotation Process Cycle Time at Westfield Gage
- Use of SPC Tools in Film Manufacturing
- Quality Function Deployment for Primary Care Physician's Office

MISSION STATEMENT

The mission of the Industrial Engineering (IE) Program at WPI is to prepare undergraduate students for professional engineering practice, providing the foundation for careers of leadership in challenging global and technological environments. We strive to accomplish this through:

- An innovative, project-based curriculum
- An emphasis on core industrial engineering skills with modern applications
- A flexible curriculum responsive to student interests and changes in the competitive environment
- An environment that encourages faculty/student interaction
- A culture that encourages the active involvement of students in their learning.

EDUCATIONAL OBJECTIVES

Educational objectives describe the expected accomplishments of graduates during the first few years after graduation.

(1) **Industrial Engineering Knowledge and Design Skills.** Graduates should be able to support operational decision making and design solutions to address the complex and changing industrial engineering problems faced by organizations, using modern concepts and technology.

(2) **Communication Skills.** Graduates should be able to communicate effectively, both orally and in writing, using electronic tools and graphical information.

(3) **Teamwork and Leadership Skills.** Graduates should be able to serve as change agents in the organizations that employ them, based on strong interpersonal and teamwork skills, an understanding of professional and ethical responsibility and a willingness to take the initiative.

PROGRAM OUTCOMES

Program outcomes describe what students are expected to know and are able to do by the time of graduation, and are linked to the educational objectives described above.

- (1) **Industrial Engineering Knowledge and Design Skills**
- (a) An ability to identify, formulate, and solve industrial engineering problems.
 - (b) An ability to design and conduct experiments, as well as to analyze and interpret data.
 - (c) An ability to design and improve integrated systems of people, materials, information, facilities and technology.
 - (d) An ability to apply core industrial engineering concepts, using the updated techniques, skills and tools necessary for industrial engineering practice.
 - (e) The broad education necessary to understand the impact of engineering solutions in a societal context.
 - (f) An ability to apply knowledge of mathematics, including statistics as well as integral and differential calculus.
 - (g) An understanding of fundamental physical laws.
- (2) **Communication Skills**
- (h) An ability to communicate effectively.
- (3) **Teamwork and Leadership Skills**
- (i) An ability to work effectively on multi-disciplinary teams.
 - (j) An understanding of professional and ethical responsibility.
 - (k) A recognition of the need for and an ability to engage in life-long learning.
 - (l) A knowledge of contemporary issues.
 - (m) An understanding of global issues.
 - (n) An understanding of change management in organizational settings.

Program Distribution Requirements for Industrial Engineering Major (IE)

The normal period of residency at WPI is 16 terms. In addition to the WPI requirements applicable to all students (see page 22), students wishing to receive the ABET accredited degree designated "Industrial Engineering" must complete a minimum of 10 units of study in the areas of mathematics, basic science, and engineering topics as follows:

Requirements	Minimum Units
1. Mathematics and Basic Science (Notes 1, 2)	4
2. Industrial Engineering Topics (including the MQP) (Notes 3,4)	6

NOTES:

1. Mathematics must include differential and integral calculus, ordinary differential equations, and 2/3 units in probability and statistics.
2. Basic Science must include both chemistry and physics, with a minimum of two courses in either.
3. Must include 1/3 unit of Capstone Design Experience.

4. Industrial Engineering Topics must include courses in the following three topic areas.
- 3 units of industrial engineering core courses, including 1/3 unit in each of the following 9 areas: engineering basics outside industrial engineering, deterministic operations research methods, process design, production planning and control, simulation, stochastic methods in operations research, information systems design, financial modeling and organizational science.
 - 1 unit in Industrial Engineering electives. 3000/4000 level MG/IE courses and Operations Research courses in Mathematics qualify with the exception of courses in financial modeling and organizational science.
 - 1 unit in technical electives. Industrial Engineering electives and any other Engineering Science/Design courses qualify.

- *production planning and control*: MG/IE 3401 - Production Planning and Control
- *simulation*: MG/IE 3460 - Simulation Modeling and Analysis
- *stochastic methods*: MG/IE 3420 - Quality Planning, Design, and Control or MG/IE 3501 - Management Science II
- *information systems design*: MG 2720 - Business Application Development Tools or MG 2710 - Business Application Platforms
- *financial modeling*: MG/IE 2850 - Engineering Economics
- *organizational science*: MG/IE 2300 - Organizational Science Foundation or MG/IE 3351 - Organizational Science Management of Change
- *engineering basics outside IE*: the engineering basics course is designed to allow students to explore some of the fundamental engineering knowledge associated with either manufacturing or service systems. Depending on the systems that are most interesting to them, it is recommended that students select one course from the following lists:

Manufacturing: ES 1310 - Engineering Design Graphics, ME1800 - Manufacturing Processes, ES 2001 - Introduction to Materials Science, and ME 2820 - Materials Processing

Service systems: EE 2011 - A Project-Oriented Introduction to Electrical and Computer Engineering, EE 3601 - Principles of Electrical Engineering, CS 2011 - Introduction to Machine Organization and Assembly Language, CS 2135 - Programming Language Concepts, and CS 4032/MA 3257 - Numerical Methods for Linear and Nonlinear Systems.

Industrial Engineering Electives (1 unit)

To achieve depth in their IE program, students are required to take one additional unit of advanced IE courses. Students may choose to focus in operations design and planning, information systems design, or operations research, or to elect a more general program by selecting courses from several areas. A course counted toward the IE core cannot be counted again as an elective. Industrial Engineering courses (listed with an MG/IE designation) and Operations Research courses in Mathematics at the 3000/4000 level qualify with the exception of courses in financial modeling and organizational science.

Technical Electives (1 unit)

Industrial Engineering electives and other Engineering Science/Design courses qualify. Courses that can be counted as Engineering Science/Design are described on page 35.

For students planning on taking the Fundamentals of Engineering examination, the following courses are recommended:

- EE 3601 - Principles of Electrical Engineering
- ES 2001 - Introduction to Materials Science
- ES 2501 - Introduction to Static Systems
- ES 2503 - Introduction to Dynamic Systems
- ES 3004 - Fluid Mechanics

Curriculum Guidelines for IE

Recommendations for complying with program distribution requirements (10 units) are described below. Students are encouraged to use a Program Tracking Sheet to plan their program and document their progress toward meeting degree requirements. Program tracking sheets are available on the IE web page or in the Management Department Office. To earn a Bachelor of Science (B.S.) degree in Industrial Engineering, students must complete 15 units of coursework. In addition to the requirements below, one must complete the Sufficiency requirement (2 units), the Interactive Qualifying Project (1 unit), free electives (1 unit), social sciences (2/3 unit), and physical education (1/3 unit). Students without prior programming experience are encouraged to take CS 1005 in their freshman or sophomore year.

(1) Mathematics and Basic Science (4 units)

Mathematics requirements include differential and integral calculus, ordinary differential equations, and 2/3 units probability and statistics. Mathematics requirements can be satisfied by taking MA 1021, MA 1022, MA 1023, MA 1024, MA 2051, MA 2611, and MA 2612. Other recommended courses include: MA 2071, courses in probability and statistics, and courses in numerical analysis.

Basic science courses can be elected in chemistry, physics, biology, or geology. Students must take both chemistry and physics, with a minimum two-course sequence in one of these areas.

(2) Industrial Engineering Topics (5 units)

Students must choose 1 course in each of nine core areas, then choose one unit of industrial engineering and one unit of technical electives. Students who plan to take the Engineering Fundamentals examination in their senior year or to pursue a graduate degree in an engineering field should select their additional unit of work from the engineering science courses suggested under *Technical Electives*.

Industrial Engineering Core (3 units)

Choose one course from each area of the following nine areas:

- *deterministic operations research methods*: MG/IE 2500 - Management Science I or MA 3231 - Linear Programming
- *process design*: MG/IE 3400 - Production System Design or MG/IE 3405 - Work Systems and Facilities Planning

DEPARTMENT OF MANAGEMENT

SAMPLE STUDENT PROGRAM WITH OVERSEAS IQP AND AN INTERNSHIP

FIRST YEAR Sufficiency 1 Sufficiency 2 Sufficiency 3 Sufficiency 4 MA 1021 MA 1022 MA 2611 MA 2612 SS 1110 SS 1120 Science 1 Science 2 PE 1 PE 2	SECOND YEAR <i>(apply in Fall for IQP abroad next year)</i> Sufficiency 5 Sufficiency 6 MG 1100 (A term) MG 2101 (B term) MG 2200 MG 2300 MG 2500 MG 2950 CS 1005 PE 3 PE 4 Internship	THIRD YEAR IQP (overseas project center) MG 3400 MG 3600 MG 3700 Major Course 1 Major Course 2 Major Course 3 MG Elective (3000 or 4000) MG Elective MG Elective	FOURTH YEAR Major Course 4 Major Course 5 Major Course 6 MQP Free Elective Free Elective Free Elective Free Elective Free Elective
---	---	---	--

SAMPLE STUDENT PROGRAM WITH NO OFF CAMPUS COMPONENTS

FIRST YEAR Sufficiency 1 Sufficiency 2 Sufficiency 3 Sufficiency 4 MA 1021 MA 1022 MA 2611 MA 2612 SS 1110 SS 1120 Science 1 Science 2 PE 1 PE 2	SECOND YEAR Sufficiency 5 Sufficiency 6 MG 1100 (A term) MG 2101 (B term) MG 2200 MG 2300 MG 2500 MG 2950 CS 1005 Free Elective Free Elective Free Elective PE 3 PE 4	THIRD YEAR IQP 1 IQP 2 IQP 3 MG 3400 MG 3600 MG 3700 Major Course 1 Major Course 2 Major Course 3 MG Elective (3000 or 4000) MG Elective MG Elective	FOURTH YEAR Major Course 4 Major Course 5 Major Course 6 MQP Free Elective Free Elective
---	--	--	---

SAMPLE STUDENT PROGRAM INCLUDING SUMMER AND CO-OP

FIRST YEAR Sufficiency 1 Sufficiency 2 Sufficiency 3 Sufficiency 4 MA 1021 MA 1022 MA 2611 MA 2612 SS 1110 SS 1120 Science 1 Science 2 PE 1 PE 2	SECOND YEAR Sufficiency 5 Sufficiency 6 MG 1100 (A term) MG 2101 (B term) MG 2200 MG 2300 MG 2500 MG 2950 CS 1005 MG Elective Free Elective Free Elective PE 3 PE 4	THIRD YEAR IQP 1 IQP 2 IQP 3 MG 3400 MG 3600 MG 3700 Major Course 1 Major Course 2 Major Course 3 Cooperative Education Experience (D- and E-Terms)	FOURTH YEAR Major Course 4 Major Course 5 Major Course 6 MQP MG Elective Free Elective MG 3000- or 4000-level elective
---	--	--	---

FIRST SUMMER 3 Free Electives

(3) Major Qualifying Project (1 unit)

The MQP is expected to provide a capstone design experience for industrial engineering majors. If the MQP does not fulfill this 1/3 unit requirement, the student should speak with the Industrial Engineering Program Director to determine an appropriate method for fulfilling this requirement.

MANAGEMENT (MG)

The Management major at WPI is what many colleges and universities would call "General Business." Our approach is to provide a broad understanding of business through what we refer to as Foundation Courses. These include such courses as Financial and Managerial Accounting, Marketing Management, and Operations Management. On top of the Foundation Courses, each student selects six related courses as the focus of their advanced work. These courses should be selected from the MG list found in the section, Curriculum Guidelines For MG, MGE, MIS. Courses not on this list must be approved by your academic advisor and the Department's Undergraduate Policy & Curriculum Committee (UPCC). This latter option permits you to develop a plan of study that is tailored to your career objectives. Career opportunities for management students can be found in banking and finance, manufacturing management, marketing and sales, research and development, human resources, public or not-for-profit sector management, and many other occupations.

The Major Qualifying Project (MQP) is an integral part of the education of our MG majors. In addition to satisfying a significant graduation requirement, the MQP must be focused in the student's specific focus area. It is typically performed for a business organization. These two elements of our approach to MQPs result in a very valuable learning experience for all of our students. Examples of the MQP for Management majors include:

- Improving a city's permitting process,
- Developing an inventory control system for a university athletics department,
- Evaluating risk in mergers, and
- Reengineering human resources at a hospital.

PROGRAM OBJECTIVES

Objectives of the Management Major are:

To prepare students for management roles in technology based organizations.

Through a flexible curriculum, to provide a solid, broad base of business knowledge and the written communication, oral presentation, decision-making, and leadership skills necessary to succeed in a technology based environment.

To develop student abilities necessary for continued career growth including:

- the ability to integrate theory and practice;
- the ability to integrate technology and change into existing organizations;
- the ability to think critically and analytically, to define and solve business problems, work in teams, and think globally; and
- the ability to learn new skills in response to changing professional requirements.

MANAGEMENT ENGINEERING (MGE)

Management Engineering at WPI combines the best of a business degree with a technical focus. MGE majors develop a broad understanding of business through what we refer to as Foundation Courses. These include such courses as Financial and Managerial Accounting, Marketing Management, and Operations Management. On top of the Foundation Courses, each student selects six related courses as the focus of their advanced work. These courses should be selected from the MGE list found in the section, Curriculum Guidelines For MG, MGE, MIS. Courses not on this list must be approved by your academic advisor and the Department's Undergraduate Policy & Curriculum Committee (UPCC) and usually come from electives in the Department or from areas such as Engineering, Mathematics, or Science. Career opportunities for Management Engineering majors are quite varied. While many become engineers in the focus area (Industrial Engineering, for example), many join management training programs or accept sales positions with technological firms.

The Major Qualifying Project (MQP) is an integral part of the education of our MGE majors. In addition to satisfying a significant graduation requirement, the MQP must be focused in the student's specific focus area. It is typically performed for a business organization. These two elements of our approach to MQPs result in a very valuable learning experience for all of our students. Examples of the MQP for Management Engineering majors include:

- Evaluating Six Sigma,
- Quality function deployment in a healthcare setting,
- Ergonomic evaluation of a manufacturing work center, and
- Evaluation of leased lines and alternative solutions.

PROGRAM OBJECTIVES

Objectives of the Management Engineering Major are:

To prepare students for management challenges in key areas that increasingly require proficiency in the technical aspects of business such as production and service operations.

To provide the knowledge and skills necessary to succeed professionally, including literacy in a technical field, a broad understanding of management issues, written communication, oral presentation, decision-making, and leadership skills required to create new and improved products, processes and control systems.

To develop student abilities necessary for continued career growth including:

- the ability to integrate theory and practice and to apply knowledge of technical issues with the foundations of management;
- the ability to integrate technology and change into existing organizations;
- the ability to think critically and analytically, to define and solve business problems, work in teams, and think globally; and
- the ability to learn new skills in response to changing professional requirements.

MANAGEMENT INFORMATION SYSTEMS (MIS)

Like our other major programs in the Department of Management, the Management Information Systems program combines a broad understanding of business, through what we refer to as Foundation Courses, with specialized education in Information Systems. Foundation Courses include such areas as Financial and Managerial Accounting, Marketing Management, and Operations Management. On top of the Foundation Courses, each student selects six MIS courses as the focus of their advanced work. These courses should be selected from the MIS list found in the section, Curriculum Guidelines For MG, MGE, MIS. Courses not on this list must be approved by your academic advisor and the Department's Undergraduate Policy & Curriculum Committee (UPCC) and usually come from electives in the Department or from areas such as Computer Science or Electrical and Computer Engineering.

Based on the rigorous IS '02 Guidelines for MIS programs, our MIS courses cover such areas as business application development tools, data management, and telecommunications, among others. This program helps students develop strong analytical, problem solving, and communication skills, and a solid understanding of business and computing. Many of our MIS majors join international consulting firms upon graduation, while others take entry-level positions as programmer-analysts, business analysts, end-user support staff, and eventual management training positions in high-technology businesses.

The Major Qualifying Project (MQP) is an integral part of the education of our MIS majors. In addition to satisfying a significant graduation requirement, the MQP must be focused in the student's specific focus area. It is typically performed for a business organization. These two elements of our approach to MQPs result in a very valuable learning experience for all of our students. Typical MQPs for MIS majors include:

- Developing a kiosk system,
- A web-based archeological stratification tool,
- Creating a help desk system, and
- Measuring data quality.

Clients have included both small and large companies as well as manufacturing businesses, financial firms, consulting firms, public sector organizations, and university departments.

PROGRAM OBJECTIVES

The objectives of the Management Information Systems Major are:

To prepare students for positions involving the design and deployment of business applications using a wide variety of advanced information technologies, especially in high technology business, consulting, and service firms, in either start-up or established environments, and to prepare students for rapid advancement to project management and other management positions.

To provide the knowledge and skills consistent with the professionally accepted IS curriculum guidelines. Specifically, this includes providing knowledge and skills related to:

- business application development tools;
- database, web-based and networked applications;
- integrating IT into existing organizations through managing and leading systems analysis and design projects;
- communicating effectively via written and oral presentations.

To develop student abilities necessary for continued career growth including:

- the ability to integrate theory and practice and to apply knowledge of information technology issues with the foundations of management;
- the ability to integrate technology and change into existing organizations;
- the ability to think critically and analytically, to define and solve business problems, work in teams, and think globally; and
- the ability to learn new skills in response to changing professional requirements.

Program Distribution Requirements for Management Degrees (MG, MGE, and MIS)

Requirements (MG, MGE, MIS)	Minimum Units
1. Management Foundation (Note 1)	11/3
2. Mathematics (Note 2)	4/3
3. Basic Science	2/3
4. Management Major (Note 3)	6/3
5. Management Electives (Note 4)	3/3
6. Computer Science	1/3
7. MQP (Note 5)	3/3

NOTES:

1. The Management Foundation must cover the foundation knowledge in the management functional areas, including at least 1/3 unit of financial accounting, managerial accounting, financial management, organizational science, deterministic management science, operations management, marketing management, information systems management, microeconomics, macroeconomics, and business law and ethics.
2. Mathematics must include 2/3 units of calculus and 2/3 units of statistics.
3. The Management Majors (other than IE) must comprise a department-approved integrated set of courses covering a specific area of: management, science, engineering or mathematics for MGE; computer science or information systems for MIS; management, social sciences, or humanities for MG.
4. Management electives must include at least 1/3 unit of 3000/4000 level MG courses. The remaining 2/3 units specified in the requirement may be satisfied with courses from Mathematics, Basic Science, Computer Science, Management, or Social Science, but excluding courses MG 1250, and MG/IE 2850.
5. Courses may not be counted more than once in meeting the departmental distribution requirements. The total number of MG (and/or MG/IE) units may not exceed 50% of the total number of units earned for the degree.

Curriculum Guidelines for MG, MGE, MIS

Specific course recommendations for complying with the distribution requirements are given below. These guidelines are intended to offer flexibility while meeting minimal standards in preparing for careers in MG, MGE, or MIS.

MATHEMATICS-minimum of 4/3 units is required, with 2/3 units in calculus and 2/3 units in statistics. For most students, MA 1021, MA 1022, MA 26111, and MA 2612 will be appropriate.

BASIC SCIENCE-minimum of 2/3 unit is required, where all courses with the prefix PH, CH, and BB, as well as GE 2341 and GE 3050, qualify.

COMPUTER SCIENCE-minimum of 1/3 unit is required where all courses with the prefix CS qualify (except CS 3043). Either CS 1005 or CS 1006 is recommended.

MANAGEMENT-minimum of 4 units is required with 2/3 units in accounting and 2/3 units in economics, and 1/3 unit from each of the 8 remaining management categories designated below. Recommended courses are listed. These courses represent the basic courses in each functional area of Management. It is recommended that courses SS 1100 and SS 1120 be taken during the First Year.

Management Foundation Coursework

Accounting	MG 1100 and MG 2101
Economics	SS 1110 and SS 1120
Finance	MG 2200
Organizational Science	MG/IE 2300
Quantitative Methods	MG/IE 2500
Business Law & Ethics	MG 2950
Production	MG/IE 3400
Marketing	MG 3600
Information Systems	MG 3700
3000- or 4000-level MG elective	

MAJOR-minimum of 2 units of integrated course work is required for students majoring in Management, MIS, or Management Engineering. Other courses may be used but must be approved by the student's academic advisor and the Department's Undergraduate Policy & Curriculum Committee early in the student's program.

MG

Complete six (6) of the following: MG 1900, MG 2250, MG 2260, MG 2720, MG/IE 3351, MG/IE 3400 OR MG/IE 3401, MG 3640, MG 3651, MG 3720, MG 3910, MG 3920, MG 4151, MG 4364, MG 4365, MG 4930. Students wishing to use other courses as part of the Management major should secure the approval of their MG academic advisor and the Department of Management's Undergraduate Policy & Curriculum Committee (UPCC).

MGE

Complete six (6) of the following: MG 2720, MG/IE 3351, MG/IE 3400 OR MG/IE 3401, MG/IE 3420, MG/IE 3501, MG 3640, MG 3651, MG 3720, MG 4151, MG 4364, MG 4365, MG/IE 4410. Students wishing to use other courses as part of the MGE major should secure the approval of their MGE academic advisor and the Department of Management's Undergraduate Policy & Curriculum Committee (UPCC).

MIS

Management Information Systems

MG 2720, MG/IE 3720, MG 3740, MG/IE 4720, and two of the following: MG 4740, MG 4750, CS 2005, CS 2011, CS 3041. Students wishing to use other courses as part of the MIS major should secure the approval of their MIS academic advisor and the Department of Management's Undergraduate Policy & Curriculum Committee (UPCC). **BREADTH**-In addition to the guidelines listed above for Mathematics, Basic Science, Computer Science, and Management, the departmental distribution requirements call for an additional 2/3 units, which may be distributed across these categories as well as social science.

MANAGEMENT NONMAJOR INFORMATION

Often the courses of the Department will be used as a small portion of other degree programs. Since management background is increasingly important, the nonmajor function is selected by many students. Areas for either exposure or focus for the non-management major include marketing, accounting, finance, entrepreneurship, operations, and organization science. Special topics or projects can be arranged on a limited basis. Care should be taken that MG and MG/IE courses do not exceed 25 percent of the total units taken for a degree.

FIVE-YEAR DUAL DEGREE BS/MBA PROGRAM

The combination of a technical undergraduate degree and a graduate degree in business has been cited by many experts as the ideal educational preparation for a career in private industry. For that reason, the Department of Management offers the opportunity for obtaining dual degrees (i.e., the B.S. degree in engineering or science and the Master of Business Administration, MBA). The dual-degree program can be completed within five years, however, the program is demanding, and curriculum planning with the student's advisor and the Department of Management should start by the beginning of the student's third year at WPI at the very latest.

Only registered WPI undergraduates majoring in an engineering (excluding Management Engineering) or science area may enter the Combined B.S./MBA Program. A separate and complete application to the MBA program must be submitted. Admission to the Combined Program is determined by the faculty of the Department of Management. The student should begin the curriculum planning process at the time he/she commences his/her undergraduate studies to ensure that all of the required prerequisite undergraduate courses are completed within the student's four years of undergraduate study. It is recommended that the MBA application be submitted no later than the beginning of the student's Third Year of undergraduate study. A student in the Combined Program continues to be registered as an undergraduate until the bachelor's degree is awarded.

Students wishing to do a combined B.S./MBA must complete the following courses while an undergraduate:

MG 1100	<i>Financial Accounting</i>
MG 2200	<i>Financial Management</i>
MG/IE 2300	<i>Organizational Science</i>
MA2611	<i>Applied Statistics I</i>
MA2612	<i>Applied Statistics II</i>
MG/IE 3400	<i>Production System Design</i>
MG 3600	<i>Marketing Management</i>
MG 3700	<i>Information Systems Management</i>
SS 1110	<i>Introductory Microeconomics</i>
SS 1120	<i>Introductory Macroeconomics</i>

To obtain a bachelor's degree via the Combined Program, the student must satisfy all requirements for the bachelor's degree, including distribution and project requirements.

To obtain an MBA via the Combined Program, the student must satisfy all MBA degree requirements. In addition to the prerequisite undergraduate courses listed above, the student must complete the following graduate courses:

MG 511	<i>Interpersonal and Leadership Skills for Technological Managers</i>
MG 512	<i>Creating and Implementing Strategy for Technological Organizations</i>
MG 513	<i>Creating Processes in Technological Organizations</i>
MG 514	<i>Business Analysis for Technological Managers</i>
MG 515	<i>Legal and Ethical Context of Technological Organizations</i>
MG 516	<i>Graduate Qualifying Project (GQP)</i>
12 Elective Credits	

A student in the Combined Program may, with prior approval, apply the equivalent of a maximum of 12 graduate credits from the same courses toward both the bachelor's and MBA degrees. Students in the Combined Program may not take graduate-level management courses prior to their Fourth Year of undergraduate study, and then only provided the corresponding prerequisites have been satisfied. Students in the Combined Program may use advanced undergraduate major or elective courses (generally classified as 4000-level courses) to satisfy graduate degree elective requirements. The Department of Management decides which courses may be used in this way. Faculty members teaching these advanced undergraduate courses may impose special requirements, appropriate to an undergraduate course being used for graduate credit, on Combined Program students.

The Department of Management may make other requirements as it deems appropriate in any individual case. These requirements take the form of a written agreement between the student and the Department of Management, and must be filed with the registrar before the student may be matriculated in the Combined Program.

The Combined Program is a full-time program of study. Once admitted to the Combined Program, a student must register every fall and spring semester until the MBA is completed. A student in the Combined Program who has no registered activities during a given fall or spring semester is automatically terminated from the Combined Program, and may only be readmitted to the Combined

Program by the Department of Management's Graduate Policy and Curriculum Committee and the Committee for Graduate Studies and Research via petition showing extenuating circumstances. Termination from the Combined Program does not affect a student's ability to continue toward the bachelor's degree.

COURSE AREAS AND NUMBERING

The second digit of undergraduate Management course numbers denotes the subject area as follows:

- 0 - General
- 1 - Accounting
- 2 - Finance
- 3 - Organizational Science
- 4 - Operations Management and Industrial Engineering
- 5 - Management Science
- 6 - Marketing
- 7 - Management Information Systems
- 8 - Managerial Economics
- 9 - Entrepreneurship and Special Topics

ENTREPRENEURSHIP MINOR

All around the world people are starting their own new business ventures. With its strong heritage of entrepreneurship, WPI is committed to encouraging its students to consider that career path. Our dream is that our students will earn a minor in Entrepreneurship, which will provide them with some basic business skills and an understanding of what it takes to start a business, then they will create a new and exciting technology as their MQP that they will then turn into a business upon graduation. Related opportunities include a \$50,000 business plan competition, the WPI Dinner with Entrepreneurs Series, the WPI chapter of CEO (Collegiate Entrepreneurs Organization), the monthly WPI Venture Forum meetings, a variety of speakers and other events related to entrepreneurship, and access to a wide network of entrepreneurs from around the U.S. and abroad.

The Minor in Entrepreneurship is available to all students except those majoring in MG, MGE, or MIS, who may take the courses as part of their major or as free electives.

The minor requires the completion of two units of coursework as noted below.

1. Complete the following course:
MG/IE2850 Engineering Economics
2. Complete two (2) from the following list:
MG1100 Financial Accounting **OR**
MG2101 Management Accounting
MG2950 Business Law & Ethics
MG3400 Production System Design
MG3600 Marketing Management
MG3700 Information Systems Management
3. Complete the following three courses, preferably in order:
MG3910 Identifying & Evaluating New Venture Opportunities
MG3920 Planning & Launching New Ventures
MG4930 Growing and Managing New Ventures

As noted above, students majoring in MG, MGE, or MIS may not minor in Entrepreneurship.

For general policy on the Minor, see the description on pages 26-27.

MANAGEMENT MINOR

Everyone needs management skills. If engineers, scientists, and others hope to advance in their careers, they must learn how to lead projects and manage groups. The Management Minor offers students (other than MG, MGE, or MIS majors, who may take the courses as part of their major or as free electives, as appropriate) the opportunity to learn some of the theory and practice of managing in organizations with material on management concepts and practices commonly encountered in the business world. This program will help students make a transition to the business world and will provide basic skills for operating effectively in business organizations.

To complete the Management Minor, a student must complete two units of work in the Management Area, typically through course work with the following distribution:

1. **One course** from the Social Science Economics area. Any course with course designation SS#1## will qualify.
2. **Three courses** from the group of courses:
 - a. MG1900 Introduction to Business in an International Environment **OR** MG/IE 2300 Organizational Science
AND
 - b. MG1100 Financial Accounting **OR** MG2101 Management Accounting
AND
 - c. One 2000-level course with prefix MG or MG/IE
3. One 3000 or 4000-level course with prefix MG or MG/IE
4. Capstone Experience MG4930:

As noted above, students majoring in MG, MGE, or MIS may not minor in Management.

For general policy on the Minor, see the description on pages 26-27.

MANAGEMENT INFORMATION SYSTEMS MINOR

Information technology has been the driving force behind the new way of doing business. It has enabled companies to make tremendous strides in productivity, it has opened new markets and new channels, and it has created new product and service opportunities. While one part of the information revolution has been advances in hardware, and another has been advances in software, a third major advance has been in the systems-side of information, or how information is organized and used to make effective decisions. That is Management Information Systems (MIS). The Minor in MIS offers students (other than MG, MGE, or MIS majors, who may take the courses as part of their major or as free electives, as appropriate) the opportunity to broaden their disciplinary program with material and skills widely useful in the business world. This program will help students to broaden their exposure to information technology and its use in business and industry.

To complete the Management Information Systems Minor, a student must complete two units of work with the following distribution:

1. **One course** from the group of courses:
 - MG1900: Introduction to Business in an International Environment **OR**
 - MG1100: Financial Accounting **OR**
 - MG2101: Management Accounting **OR**
 - MG/IE2300: Organizational Science
2. **Two CS courses, or their equivalents, from the following courses:**
 - CS1005: Introduction to Programming in C
 - CS1006: Introduction to Programming in Java
 - CS2005: Techniques of Programming
3. **Two courses** from the group of courses:
 - MG 3700: Information Systems Management
 - MG/IE 3720: Management of Data
 - MG/IE 3740: Organizational Application of Telecommunications
4. **Capstone Experience**
 - MG/IE 4720: Systems Analysis and Design

Course MG/IE 4720 is a project-oriented course designed to prepare MIS students and minors for actual information systems design work in business and industry. The course builds and uses MIS concepts for the sound and efficient design of information systems.

Students majoring in MG, MGE, or MIS may not take the MIS Minor.

For general policy of the Minor, see the description on pages 26-27.

ORGANIZATIONAL LEADERSHIP MINOR

One of the critical elements for any person who hopes to succeed in a formal organization is leadership. While some people come by their organizational leadership abilities instinctively or by learning from others at an early age, many others come late to their leadership talents and still others never realize their leadership abilities. It is the purpose of the Department of Management's Organizational Leadership minor to provide students with the theoretical underpinnings of leadership and, in keeping with a WPI education, the knowledge of how that theory applies to practice. Thus, through this minor students will be able to understand and apply leadership theories to their lives and, in the process, make themselves more marketable upon graduation.

The minor in Organizational Leadership consists of three primary components. These components are a choice of Management courses, a choice among three Social Science & Policy Studies courses, and a capstone course in Leadership.

1. **Select four of the following:**
 - MG 1900 Introduction to Business in an International Environment
 - MG/IE 2300 Organizational Science - Foundation
 - MG 2950 Business Law & Ethics
 - MG/IE 3351 Organizational Science - Management of Change
 - MG 4364 Human Resource Management

2. Select one of the following:

- SS 1401 Introduction to Cognitive Psychology
- SS 1402 Introduction to Social Psychology
- SS 2406 Cross-Cultural Psychology: Human Behavior in Global Perspective

3. Required Capstone Experience

MG 4365 Leadership in Groups and Organizations

Note: The minor in Organizational Leadership may not be taken by students majoring in MG, MGE, or MIS. These students may take the courses as part of their major or as free electives, as appropriate.

For general policy on the Minor, see the description on pages 26-27.

MANUFACTURING ENGINEERING

DIRECTOR: C. A. Brown

PROFESSORS: D. Apelian, I. Bar-On, C. A. Brown, R. D. Sisson, J. M. Sullivan, Jr.

ASSOCIATE PROFESSORS: S. Johnson,

M. M. Makhoulf, Y. Rong, S. Shivkumar,

ASSISTANT PROFESSOR: M. Fofana

ADJUNCT ASSISTANT PROFESSOR: W. Weir

LECTURERS: P. D. Cotnoir, K. Stafford

INTRODUCTION

The Manufacturing Engineering Program a multidisciplinary program, relying on faculty and equipment of the departments of Computer Science, Electrical and Computer Engineering, Management, and Mechanical Engineering. Manufacturing Engineering is home to the Robotics Lab, Computer-aided Manufacturing Lab, Machine Dynamics Lab, Surface Metrology Lab, and Haas Technical Center for Computer-controlled Machining.

Manufacturing Engineering integrates basic knowledge of materials, design, processes, computers, engineering analysis, and systems design. This knowledge is used to design, build, operate, and manage production systems. Manufacturing Engineering encompasses a wide range of areas from basic research to technical management. At WPI, Manufacturing Engineers may be involved through courses and MQPs in a wide range of topics including:

Computer-aided Design (CAD)

Computer-aided Manufacturing (CAM)

Surface Metrology

Manufacturing Processes (Casting, Welding,

Machining, Grinding)

Industrial Robotics

Simultaneous/Concurrent Engineering

Lean Manufacturing

CNC Machining

Fixturing

Machine Dynamics

Value Engineering

Axiomatic Design

Materials Programming

Heat Treatment

A scientific "high technology" basis for Manufacturing Engineering is evolving. The MFE program is designed to lace WPI students at the leading edge of this evolution.

BACHELOR OF SCIENCE IN MANUFACTURING ENGINEERING

Manufacturing Engineering students are highly sought by industry, earning more on the average than other engineers do. Manufacturing expertise is essential to all industrialized, developing and even post-industrialized societies.

Manufacturing Engineering studies give a solid understanding of the principles of production systems, processing, manufacturability, and quality that can be applied to a wide variety of products, traditional and non-traditional products, such as aircraft, cars, robots, e-business, software, service, and information.

BACKGROUND

Manufacturing Engineering was the first engineering discipline taught at WPI, supporting for well over a century the technological base of one of the most important manufacturing regions in the world. Central Massachusetts is one of the cradles of the Industrial Revolution.

Manufacturing in Massachusetts has been of critical strategic importance for America since the beginning of the boycott of British goods that preceded the War of Independence. The manufacturing industry in Massachusetts began what is known around the world as the American System for mass production.

New England, Massachusetts and Worcester County continue to lead the nation and world in many critical manufacturing technologies.

In the 1980's WPI appropriately became one of the first schools in the country to offer an ABET accredited BS degree in Manufacturing Engineering (at that time called "Advanced Manufacturing Systems Engineering").

WPI also was one of the first schools in the country to grant a Ph.D. degree in Manufacturing Engineering. Currently WPI offers three degrees in Manufacturing Engineering, including an M. S. Manufacturing Engineering is also one of the seven concentrations in Mechanical Engineering.

Program Distribution Requirements for the Manufacturing Engineering Major

The normal period of residency at WPI is 16 terms. In addition to WPI requirements applicable to all students, students wishing to receive the degree designated "Manufacturing Engineering" must satisfy certain distribution requirements:

Requirements	Minimum Units
1. Mathematics and Basic Science (Notes 1,2)	4
2. Engineering Science and Design (including the MQP) (Note 3,4)	6

Notes:

1. Mathematics must include differential and integral calculus and differential equations.
2. Science must include both chemistry and physics with a minimum of two courses in either.
3. At least one unit from each of the following areas is required:
 - A. Materials and Processes
 - B. Product Engineering
 - C. Computer Control and Manufacturing Systems
 - D. Production Systems Engineering
4. Must include 1/3 unit of Capstone Design Experience.

MANUFACTURING ENGINEERING PROGRAM CHART

BACKGROUND

4 Units

MATHEMATICS	**SCIENCE
*MA 1021	CH 1010
*MA 1022	CH 1020
*MA 1023	PH 1110
*MA 1024	PH 1120
*MA 2051	PH 1130
MA 2071	PH 1140
MA 2611	BB 1001
MA 2612	BB 1002
MA 2621	
MA 3831	
MA 3832	
MA 4631	

* Mathematics requirements include differential and integral calculus and ordinary differential equations. Additional work is strongly encouraged in one or more of the subjects of probability and statistics, linear algebra, and numerical analysis.
 ** Science requirements include chemistry and physics with at least a two course sequence in either.

2/3 Units

SOCIAL SCIENCE
see page 159

2 Units

H&A SUFFICIENCY
see page 54

1 Unit

INTERACTIVE QUALIFYING PROJECT (IQP)
see page 39

1 Unit

FREE ELECTIVE
Refer to catalog

1/3 Unit

PHYSICAL EDUCATION
see page 152

6 Units (Divided approximately 2:1 between Engineering Science: Design)

MANUFACTURING ENGINEERING

One unit per area required }
 Electives }

1 Unit	1 Unit	1 Unit	1 Unit
MATERIALS & PROCESSES	PRODUCT ENGINEERING AND TOOL DESIGN	COMPUTER CONTROL & MANUFACTURING SYSTEMS	PRODUCTION SYSTEMS ENGINEERING
ES 2001 ME 1800 ME 2820 ME 4821 ME 3023 ME 3825 ME 4813 ME/BE 4814 ME 4816 ME 4822	ES 2501 ES 2502 ES 2503 ME 3320 ES 1310 ES 3323 ME 3310 ME 3311 ME 3321 ME 4320	EE 3601 ES 3011 ME 3820 ME 4815 EE 2011 CS 2005 CS 3013 CS 3431 CS 4032 CS 4033	MG/IE 2850 MG/IE 3400 MG/IE 3401 MG/IE 3420 MG/IE 2500 MG/IE 3405 MG/IE 3450 MG/IE 3501 MG/IE 3760 MG/IE 4460
1 Unit Emphasizing Design			
MAJOR QUALIFYING PROJECT (MQP)			

PLANNING A PROGRAM IN MANUFACTURING ENGINEERING

The MFE program is constructed in a manner similar to other engineering programs. Background and competence is developed in mathematics and the basic sciences. Other WPI requirements, including the Humanities and Arts Sufficiency, social science, and IQP, must be completed. Expertise in the four areas of Manufacturing Engineering is developed. Finally, the MQP, a capstone engineering design project that integrates previous WPI education, is completed.

The chart is intended to assist in student planning. The units listed indicate minimum units required. See page 133.

Although the courses listed are appropriate for most students, it is possible to develop programs using other WPI courses. Since the MFE program is multidisciplinary in nature and has a wide range of electives, student programs should be developed in consultation with their academic advisor and the director of the Manufacturing Engineering Program.

MANUFACTURING ENGINEERING FAST TRACK: BS IN MFE IN 3 YEARS, MS IN 4 YEARS

The program is designed to make it possible for good students to complete the BS in MFE in three years. You will need to use E-terms for courses and project work, and to plan on some overloading. Additionally, through the BS/MS program, it is possible to add a MS in one more year. The planning for this program should be completed before the end of D term in the first year. See your advisor or the director of the Manufacturing Engineering Program for details.

ADDING MINORS IN OTHER AREAS: COMPUTER SCIENCE, MANAGEMENT, MATERIALS ENGINEERING, STATISTICS

Adding one of these minors can be an excellent way to get more out of your college experience and make your resume stand out. Because Manufacturing Engineering is an integrating discipline, accessing course work from other departments and programs, it can be relatively easy for MFE majors to add a minor in Computer Science, Management, Materials Engineering, or Statistics. One unit of credit can be double counted for the MFE major and one of the minors. The other unit for the minor can come from the free electives. See the descriptions for the minors under their respective programs.

FOUR- OR FIVE-YEAR DUAL-DEGREE BS/MS PROGRAM

Outstanding undergraduate students in the B.S. program in Manufacturing Engineering and the other engineering and science programs at WPI are encouraged to apply for the four- or five-year BS/MS program in Manufacturing Engineering. This dual-degree program can be completed in five years; however, the program is demanding and curriculum planning with the student's academic advisor and the Director of Manufacturing Engineering should start during the third year at WPI in order to meet both

degree requirements. (See "Combined Bachelor's/ Master's Program" on page 242, and contact the Director of Manufacturing Engineering for details.)

MINOR IN MANUFACTURING ENGINEERING

A minor in Manufacturing Engineering gives students from a variety of majors the opportunity to strengthen their academic preparation and attractiveness to industry, while better preparing them to solve many of problems that will challenge them in their careers. Most engineers are involved directly or indirectly with manufacturing or manufacturing principles. Manufacturing expertise is essential to all industrialized, developing and even post-industrialized societies. The objective of the minor in manufacturing will be to give the students a solid understanding of the principles of production, processing, manufacturability, and quality that can be applied to a wide variety of products, including non-traditional products, such as software, service and information.

The minor requires the completion of **2 units** of work as follows.

- I. **1 unit** of required course work selected from the following list:
 - ME 1800 Material Selection and Manufacturing Processes
 - ME 2820 Materials Processing
 - ME 3820 Computer-Aided Manufacturing
 - ES 3011 Control Engineering I
- II. **2/3 unit** of electives, selected from the following list of courses:
 - ___ any of the courses above, in I., can count if the other three are completed.
 - CS 4032 Numerical Methods for Linear and Nonlinear Systems
 - CS 4341 Introduction to Artificial Intelligence
 - ES 3323 Advanced Computer Aided Design
 - ME 3310 Kinematics of Mechanisms
 - ME 4530 Computational Methods in Mechanical Engineering
 - ME 4815 Industrial Robotics
 - ME 4821 Chemistry, Properties and Processing of Plastic
 - MG/IE 3400 Production System Design
 - MG/IE 3420 Quality Planning, Design and Control
 - MFE 510 Control and Monitoring of Manufacturing Processes
 - MFE 511 Application of Industrial Robotics
 - MFE 520 Design and Analysis of Manufacturing Processes
 - MFE 530 Computer Integrated Manufacturing
 - MFE 540 Design for Manufacturability
- III. **1/3 unit** of capstone experience:
 - ME 4815 Industrial Robotics
 - MFE xxxx Independent Study Project (this must be approved by the MFE minor program committee)

MFE 510	Control and Monitoring of Manufacturing Processes
MFE 511	Application of Industrial Robotics
MFE 520	Design and Analysis of Manufacturing processes
MFE 530	Computer Integrated Manufacturing
MFE 540	Design for Manufacturability

MATERIALS ENGINEERING

Courses and programs of study in materials engineering are included in the Mechanical Engineering Department (page 144). For advisory information, consult that section of the Undergraduate Catalog or members of the materials section of Mechanical Engineering.

MINOR IN MATERIALS

Material properties, material processing issues, or material costs are the limiting factor in the design or performance of almost all systems around us. Engineers, scientists, and managers in all technological sectors often must make material selection decisions based on a variety of considerations, including properties, performance, environmental impact, and cost. A Minor in Materials, feasible within a 15 unit program of study, will benefit students who wish to enhance their disciplinary major with an additional degree designation in the area of materials.

REQUIREMENTS FOR THE MATERIALS MINOR:

The minor requires the completion of 2 units of work^a as described below:

1. ES 2001 Introduction to Material Science (1/3 unit)

2. 1 1/3 units of electives, selected from the following list of courses^{b,c}:

CE 3026	Materials of Construction
CH 3410	Principles of Inorganic Chemistry
CH 2310	Organic Chemistry I
CH 2320	Organic Chemistry II
CH 2330	Organic Chemistry III
CH 4330	Organic Synthesis
CH 4550	Polymer Chemistry
CM 3601	Chemical Materials Engineering
EE 3901	Semiconductor Devices
ME 2820	Materials Processing
ME 3023	Mechanical Behavior and Modeling Properties of Engineering Materials
ME 3811	Microstructure Analysis and Control
ME 3825	Mechanical Metallurgy Laboratory
ME 4813	Ceramics
ME/BE 4814	Biomaterials
ME 4816	Materials Optimization for Engineers
ME 4821	Chemistry, Properties, and Processing of Plastics
ME 4822	Solidification Processes
ME 4832	Corrosion and Corrosion Control
ME 4840	Physical Metallurgy
ME 4850	Solid State Thermodynamics
PH 3502	Solid State Physics

Students who are able to design their undergraduate program of study such that they have sufficient preparation may also use the following graduate courses toward a Materials Minor: all MTE graduate courses; CM 508, Catalysis and Surface Science of Materials; CM 510, Particulate Systems; CM 543, Molecular Sieves; CM 551, Structure and Properties of Polymeric Materials; CH 555, Advanced Topics/Polymer Chemistry and Advanced Topics/Nanotechnology.

3. Capstone Experience (1/3 unit)

The capstone experience requirement for the Minor in Materials must be satisfied by an upper level course or IS/P activity that integrates and synthesizes material processing, structure, and property relationships as they affect performance.

- i) Courses that satisfy the capstone experience requirement currently include ME 4816 and ME 4822. Other courses must be approved in advance by the Program Committee for the Minor in Materials.
- ii) Students may satisfy the capstone experience requirement by completing a 1/3 unit IS/P that receives prior approval from the Program Committee for the Minor in Materials. The IS/P may, for example, take the form of a laboratory experience or may augment the MQP or IQP, considering in depth the materials issues associated with the project topic (see Note d). An IS/P related to the MQP must be distinct from the core 1 unit of the MQP and in most cases would be advised by a faculty member other than the MQP advisor.

NOTES:

- a. In accordance with the Institute-wide policy on Minors, academic activities used in satisfying the regular degree requirements may be double-counted toward meeting all but one unit of the Minor requirements (see pages 26-27 of the Undergraduate Catalog.)
- b. Undergraduates in any major who are considering graduate study in Materials Science and Engineering are advised to include ME 3023, ME 3811, ME 4840, and ME 4850 among their electives.
- c. Physics IS/P courses in Superconductors, Photonics, and Lasers may also be counted toward the Materials Minor. In addition, other new or experimental course offerings in the materials area may be approved by the Materials Minor Program Review Committee.
- d. Examples: An ECE major designing an integrated circuit for her MQP might conduct a separate analysis of the materials issues related to heat management in the device as the capstone experience for the Minor in Materials; a ME major specifying a gear in a design MQP might conduct a separate analysis of the material processing, structure, and property issues affecting fatigue life of the gear.
- e. In accordance with the Institute-wide policy on Minors, the Major Qualifying Project (MQP) cannot be counted toward activity for a Minor. Therefore, a ME, CM, or any other major whose MQP is judged to be predominantly in the materials area by the Program Review Committee may not count an extra 1/3 unit augmentation of their MQP as their capstone experience in the Minor.

f. The following faculty serve as the Program Review Committee for the Minor in Materials and will serve as Minor Advisors: Richard Sisson (ME), Chrys Demetry (ME), Tahar El-Korchi (CEE).

PERMISSIBLE MAJOR-MINOR COMBINATIONS

The Materials Minor is available to students of all majors. Students can earn *either* a Materials Minor designation *or* a Materials Concentration, not both.

MATHEMATICAL SCIENCES

H. F. WALKER, HEAD; W. FARR, ASSOCIATE HEAD

PROFESSORS: P. R. Christopher, P. W. Davis, M. Humi, K. A. Lurie, R. Y. Lui, J. D. Petrucci, D. Tang, B. Vernescu, H. F. Walker

ASSOCIATE PROFESSORS: W. Farr, J. D. Fehribach, A. C. Heinricher, W. J. Martin, B. Nandram, B. Servatius, D. Vermes

ASSISTANT PROFESSORS: B. Doytchinov, C. Larsen, C. Morales, M. Sarkis, S. Weekes, J. Wilbur

VISITING FACULTY: G. Dalakouras, J.-H. Kimn, D. Pasca, D. Shon, A. Swift

ACADEMIC STAFF: J. Goulet, A. Wiedie

INTRODUCTION

What is the best way to route data through a computer network? How can the safety and efficacy of a new AIDS drug be established? Is there a way to combine different materials to form a composite with maximum strength for a given weight? How much should be charged for the option to buy a stock at a certain price in one year's time? How does one put a price tag on the risk presented by a 17-year old male driver? These are just some of the exciting challenges encountered by professionals in the mathematical sciences.

Study in the mathematical sciences requires hard work and discipline to attain the clarity, precision, logic, and economy of thought that recruiters from business, industry and academia value so highly in our graduates. And the rewards are substantial: mathematical science careers such as actuary, statistician and mathematician consistently rank at the top of lists of the most desirable professions. If what we've said so far interests you, read on to learn more about what mathematical scientists do, and particularly about how our programs-Mathematical Sciences and Actuarial Mathematics-can prepare you for a challenging and rewarding career.

PROGRAM IN MATHEMATICAL SCIENCES

Study in the mathematical sciences offers a broad spectrum of opportunities to the prospective major. While filled with open problems and subject to intense research in well-established areas, the mathematical sciences are constantly undergoing renewal as new questions and challenges arise in applications. Indeed, whole new areas of mathematical sciences are continually being born and

existing areas are reinvigorated as surprising connections are discovered to the physical, biological, and social sciences, to computer science, and to engineering, business, industry, and finance. Not surprisingly, many of our majors are double majors who seek to apply mathematics to problems in their other fields. Such students are trained in the modeling, analysis, and computation necessary for solving problems in their other fields of interest.

Career opportunities for majors are many and varied. Recent graduates have embarked on careers in business and industry (e.g., Microsoft Corporation, Raytheon Company, Polaroid Corporation, MITRE Corporation, Fidelity Investments, Aetna Insurance, and Sun Life Financial) or have entered graduate school (e.g., Purdue University, University of California at Berkeley, Harvard University, Stanford University, Northwestern University, WPI) in such diverse disciplines as mathematics, statistics, law, management, physics, nuclear engineering, civil engineering, and education. More on career and employment opportunities can be found at the web sites of the Mathematical Association of America <http://www.maa.org/students/career.html>, or the American Statistical Association <http://www.amstat.org/careers/index.html>.

PROJECTS/INDEPENDENT STUDIES

Some of the most active career directions in the mathematical sciences are reflected in the MQP areas around which the department's offerings are organized: Algebraic and Discrete Mathematics, Computational and Applied Analysis, Operations Research, and Probability and Statistics. As early as practical, and certainly no later than the sophomore year, the mathematical sciences major should begin exploring these different areas. The transition courses, MA 2073, 2271, 2273, 2431, and 2631, are specifically designed to introduce the four MQP areas while preparing the student for advanced courses and the MQP.

While most students choose MQPs in one of the four areas mentioned above, it is possible to design an MQP that does not fit into any one area. In these cases, students will want to take special care to plan their programs carefully with their advisors so that sufficient backgrounds are obtained by the time the students begin their MQPs.

Many MQPs involve the solution of real-world problems proposed by industrial sponsors. Details can be found at <http://www.wpi.edu/~cims>.

A current listing of specific available projects with their descriptions is available at the department office, and at <http://www.wpi.edu/Academics/Projects/available.html>.

Independent studies are a good way for students to learn topics that are not taught in regularly-scheduled courses. Interested students should approach faculty with requests for independent studies. Some independent study areas and faculty advisors are listed below. In what follows, you will find for each MQP area:

- A brief description of the area including the kinds of challenges likely to be encountered by MQP students and mathematical scientists working there.
- Courses of interest.
- MQP and independent study topics and advisors.
- Examples of recent MQPs.

ALGEBRAIC AND DISCRETE MATHEMATICS

Algebraic and discrete mathematics is recognized as an increasingly important and vital area of mathematics. Many of the fundamental ideas of discrete mathematics play an important role in formulating and solving problems in a variety of fields ranging from ecology to computer science. For instance, graph theory has been used to study competition of species in ecosystems, to schedule traffic lights at an intersection, and to synchronize parallel processors in a computer. Coding theory has been applied to problems from the private and public sectors where encoding and decoding information securely is the goal. In turn, the problems to which discrete mathematics is applied often yield new and interesting mathematical questions. The goal of a project in discrete mathematics would be to experience this interaction between theory and application. To begin, a typical project team would assess the current state of a problem and the theory that is relevant. Once this is done, the project team's objective would be to make a contribution to solving the problem by developing new mathematical results.

In working in discrete mathematics, one may be writing algorithms, using the computer as a modeling tool, and using the computer to test conjectures. It is important that a student interested in this area have some computer proficiency. Depending on the project, an understanding of algorithm analysis and computational complexity may be helpful.

Courses of Interest

- MA 2271 Graph Theory
- MA 2273 Combinatorics
- MA 3231 Linear Programming
- MA 3233 Discrete Optimization
- MA 3823 Group Theory
- MA 3825 Rings and Fields
- MA 4891 Topics in Mathematics (when appropriate)
- CS 2005 Data Structures and Programming Techniques
- CS 4120 Analysis of Algorithms
- CS 4123 Theory of Computation

MQP AND INDEPENDENT STUDY TOPICS AND ADVISORS

Topic Area	Faculty Advisor(s)
Coding Theory and Cryptography	W. J. Martin, B. Servatius
Combinatorics	P. R. Christopher, W. J. Martin, B. Servatius
Discrete Optimization	W. J. Martin, B. Servatius
Finite Fields	W. J. Martin, B. Servatius
Graph Theory and Applications	P. R. Christopher, B. Servatius
Group Theory	P. R. Christopher, B. Servatius
Linear Algebra	P. R. Christopher, W. J. Martin, B. Servatius
Number Theory	W. J. Martin, B. Servatius

Some Recent Algebraic and Discrete Mathematics MQPs:

Properties of the Star-Chromatic Number

Student: Peter Minear

Advisor: P. R. Christopher

Given a graph (or "network") and a star with k points, can you assign a point of the star to each node of the graph so that no two adjacent nodes are assigned to points that are too close together? This is the idea of the star-chromatic number of a graph. This recent project examined the star-chromatic number, a recently proposed parameter in graph theory. We explored the relationship between this parameter and the classical, well-studied chromatic number. Also, we reviewed another parameter, the game-chromatic number.

Molecular Computation and Graph Theory

Students: Nathan Gibson, Angela Lusignan

Advisor: B. Servatius

Will the computers of the future incorporate DNA to quickly solve complex combinatorial problems? This interdisciplinary project consisting of graph theory, biology and computer science explored the capability of using DNA Computing to solve the existence of a directed Hamiltonian path. A mathematical model of the problem was designed to analyze the pre-conditioning of digraphs. Additionally, optimization techniques were developed in order to apply biological operations to digraphs efficiently. Results were obtained from each discipline to assess the viability of Molecular Computation.

COMPUTATIONAL AND APPLIED ANALYSIS

This area of mathematics concerns the modeling and analysis of continuous physical or biological processes that occur frequently in science and engineering. Students interested in this area should have a solid background in analysis which includes the ability to analyze ordinary and partial differential equations through both analytical and computational means.

In most circumstances, an applied mathematician does not work alone but is part of a team consisting of scientists and engineers. The mathematician's responsibility is to formulate a mathematical model from the problem, analyze the model, and then interpret the results in light of the experimental evidence. It is, therefore, important for students to have some experience in mathematical modeling and secure a background in one branch of science or engineering through a carefully planned sequence of courses outside of the department.

With the increase in computational power, many models previously too complicated to be solvable, can now be solved numerically. It is, therefore, recommended that students acquire enough computer proficiency to take advantage of this. Computational skill is growing in importance and should be a part of every applied mathematician's training. Students may learn these skills through various numerical analysis courses offered by the department. An MQP in this area will generally involve the modeling of a real-life problem, analyzing it, and solving it numerically.

Courses of Interest

MA 2251	Vector and Tensor Calculus for Engineers
MA 2431	Mathematical Modeling with Ordinary Differential Equations
MA 3231	Linear Programming
MA 3257	Numerical Methods for Linear and Nonlinear Systems
MA 3457	Numerical Methods for Calculus and Differential Equations
MA 3471	Advanced Ordinary Differential Equations
MA 3475	Calculus of Variations
MA 4235	Mathematical Optimization
MA 4291	Applicable Complex Variables
MA 4411	Numerical Analysis of Differential Equations
MA 4451	Boundary Value Problems
MA 4473	Partial Differential Equations

MQP AND INDEPENDENT STUDY TOPICS AND ADVISORS

Topic Area	Faculty Advisor(s)
Calculus of Variations	C. Larsen, K. Lurie, B. Vernescu, M. Sarkis
Chemical Reaction Models	P. W. Davis, W. Farr
Composite Materials	C. Larsen, K. Lurie, B. Vernescu
Fluid Mechanics	M. Humi, D. Tang, S. Weekes
Mathematical Biology	R. Lui, D. Tang
Mathematical Physics	M. Humi, C. Larsen
Numerical Methods for Differential Equations/ Scientific Computation	W. Farr, J. D. Fehribach, M. Humi, M. Sarkis, D. Tang, H. Walker, S. Weekes
Optimal Control/Stochastic Control	A. C. Heinricher, D. Vermes

Some Recent Computational and Applied Analysis MQPs:***Control of Simultaneous Motion in Shoulder Prostheses***

Students: Colleen Fox, Nicole Shivitz, Jason Wening
Advisors: P. W. Davis (MA), F. J. Looft (EE)

When designing a prosthetic arm, a key issue is the simultaneous control of motions in different joints. This project established design parameters of the control unit and predicted the forces that would act on the arm as it underwent different motions. A motion control system was then built, proving that digital signal processing can be used with analog technology to control the simultaneous motions and counteract the predicted inertial forces.

Math Modeling in Metal Processing

Students: Forest Lee-Elkin, William Montbleau,
Stanislav Oks

Advisor: B. M. Vernescu

Sponsor: Morgan Construction Company

The project focused on the wear of a mechanism called a Laying Pipe, which coils steel rod in rolling mills. A mathematical model for the mechanism's wear was de-

veloped through a system of differential equations and was shown to closely match measured data. To improve the wear distribution, the optimal shape was numerically solved using mathematical techniques for minimization (the calculus of variations).

OPERATIONS RESEARCH

Operations research is an area of mathematics which seeks to solve complex problems that arise in conducting and coordinating the operations of modern industry and government. Typically, operations research looks for the best or optimal solutions to a given problem. Problems within the scope of operations research methods are as diverse as finding the lowest cost school bus routing that still satisfies racial guidelines, deciding whether to build a small plant or a large plant when demand is uncertain, or determining how best to allocate timesharing access in a computer network.

Typically, these problems are solved by creating and then analyzing a mathematical model to determine an optimal strategy for the organization to follow. Often the problem requires a statistical model, and nearly always the analysis - whether optimizing through a set of equations or simulating the behavior of a process - involves the use of a computer. Finally, operations researchers must be able to interpret and apply the results of their analyses in an appropriate manner.

In addition to a solid background in calculus, probability and statistics, and the various operations research areas, prospective operations researchers should be familiar with computer programming and managerial techniques.

Courses of Interest

MA 2271	Graph Theory
MA 2273	Combinatorics
MA 3231	Linear Programming
MA 3233	Discrete Optimization
MA 3627	Applied Statistics III
MA 3631	Mathematical Statistics
MA 4235	Mathematical Optimization
MA 4237	Probabilistic Methods in Operations Research
MA 4631	Probability and Mathematical Statistics I
MA 4632	Probability and Mathematical Statistics II
MG 2500	Management Science I: Deterministic Decision Models
MG 3501	Management Science II: Risk Analysis
MG 3760	Simulation Modeling and Analysis

MQP AND INDEPENDENT STUDY TOPICS AND ADVISORS

Topic Area	Faculty Advisor(s)
Control Theory	K. Lurie, A. C. Heinricher
Stochastic Controls	D. Vermes, A. C. Heinricher
Stochastic Differential Equations	B. Doytchinov, A. C. Heinricher, D. Vermes

PROBABILITY AND STATISTICS

In many areas of endeavor, decisions must be made using information which is known only partially or has a degree of uncertainty attached to it. One of the major tasks of the statistician is to provide effective strategies for obtaining the relevant information and for making decisions based on it. Probabilists and statisticians are also deeply involved in stochastic modeling - the development and ap-

MATHEMATICAL SCIENCES MAJOR PROGRAM CHART

UNIVERSITY REQUIREMENTS	
Minimum Academic Credit	15 Units
Residency	8 Units
Sufficiency	2 Units
Interactive Qualifying Project	1 Unit
Major Qualifying Project	1 Unit
Social Science	2/3 Unit
Physical Education	1/3 Unit

FOUNDATION COURSES

INTRODUCTORY COURSES	TRANSITION COURSES (1 Unit Required)	CORE COURSES (4/3 Unit Required)
MA 1021-1024 or MA 1031-1034 MA 2051 MA 2071 MA 2201 MA 2251 MA 2611	MA 2073 MA 2271* MA 2273* MA 2431 MA 2631	Both MA 3831 and MA 3832 One of MA 3257 or MA 3457 One of MA 3823* or MA 3825*

OTHER MA COURSES TO ATTAIN TOTAL OF 6 UNITS:

ACTUARIAL MATH	ANALYSIS	ALGEBRA	DISCRETE MATH	COMPUTATIONAL MATH	OPERATIONS RESEARCH	STATISTICS/PROBABILITY
MA 3211 MA 3212 MA 4213* MA 4214*	MA 2431 MA 3471* MA 3475* MA 4291 MA 4451 MA 4473*	MA 2073 MA 3823* MA 3825*	MA 2271* MA 2273* MA 3233*	MA 3257 MA 3457 MA 4411*	MA 3231 MA 3233* MA 4235* MA 4237*	MA 2612 MA 2621 MA 2631 MA 3627* MA 3631 MA 4214* MA 4631 MA 4632 MA 4658

OTHER REQUIREMENTS	
Computer Science Courses	2/3 Unit

* Category II courses, offered in alternating years.

plication of mathematical models of random phenomena. Applications to such areas as medicine, engineering, and finance abound.

Students interested in becoming probabilists or mathematical statisticians should consider additional study in graduate school. While graduate study is an option for students whose goals are to be applied statisticians, there are also career opportunities in business, industry, and government for holders of a B.S. degree. More information about careers in statistics can be found at the American Statistical Association's web site <http://www.amstat.org/profession/index.html>.

Students planning on graduate studies in this area would be well advised to consider, in addition to the courses of interest listed below, additional independent study or PQP work in probability and statistics, or some of the department's statistics graduate offerings.

Courses of Interest

MA 2611	Applied Statistics I
MA 2612	Applied Statistics II
MA 2631	Probability
MA 3627	Applied Statistics III
MA 3631	Mathematical Statistics
MA 4237	Probabilistic Methods in Operations Research
MA 4631	Probability and Mathematical Statistics I
MA 4632	Probability and Mathematical Statistics II

MQP AND INDEPENDENT STUDY TOPICS AND ADVISORS

Topic Area	Faculty Advisor(s)
Applied Probability	A. C. Heinricher
Bayesian Statistics	B. Nandram
Biostatistics	
Categorical Data Analysis	
Industrial Applications	J. D. Petruccielli
Statistical Computation	
Stochastic Models	B. Nandram, J. D. Petruccielli
Survey Sampling Theory	B. Nandram
Time Series	J. D. Petruccielli

Some Recent Probability and Statistics MQPs:

Assessing Two Models to Map Colon Cancer Rates

Student: Brian Burwick
Advisor: B. Nandram

Previous work by the advisor used several models and three measures to study cancer and chronic obstructive pulmonary disease, and showed that one of the models is surprisingly better than another one. The goal of this project was to investigate how well these models perform for other causes of death, and sparser data sets. For colon cancer, the three measures were applied, and then a fourth measure was developed to compare the models. The project found that one model is still preferable to the other.

Statistical Consulting

Student: Jayson Wilbur
Advisor: J. D. Petruccielli
Sponsor: Bose Corporation

During a three month period, Jayson Wilbur served as a statistical consultant to the manufacturing and R&D divisions of Bose Corporation, a leading manufacturer of au-

dio products. There he provided statistical expertise on four projects. The statistical methods he used included experimental design, data collection, analysis of variance, analysis of covariance, pairwise comparisons of proportions, aliasing structures, confounding patterns, testing for significance and non-parametric methods of analysis.

Program Distribution Requirements for the Mathematical Sciences Major

The normal period of residency at WPI is 16 terms. In addition to the WPI requirements applicable to all students, completion of a minimum of 10 units of study is required as follows:

Requirements	Minimum Units
1. Mathematics including MQP (See notes 1-4).	7
2. Courses from other departments that are related to the student's mathematical program. At least 2/3 unit in computer science must be included; the remaining courses are to be selected from science, engineering, computer science or management (except MG 1250) (see Note 5).	2
3. Additional courses or independent studies (except MS, PE courses, and other degree requirements) from any area.	1

NOTES:

1. Must include MA 3831-3832, or their equivalents, at least one of MA 3257, MA 3457, or equivalent, and at least one of MA 3823, MA 3825, or equivalent.
2. Must include at least three of the following: MA 2073, MA 2271, MA 2273, MA 2431, MA 2631, or their equivalents.
3. At least 7/3 units must consist of MA courses at the 3000 level or above.
4. May not include both MA 2631 and MA 2621.
5. May not include both CS 3043 and CS 2022.

PROGRAM IN ACTUARIAL MATHEMATICS

An actuary is a business professional who uses mathematical skills to define, analyze, and solve financial and social problems. Preparation for a career as an actuary requires mathematical aptitude, but actuarial work involves a practical type of mathematical ability mixed with business skills. An actuary deals with real-life problems rather than theoretical ones, must be curious, have sound judgment, and be able to think logically and creatively. The goal of the program in actuarial mathematics is to prepare students for positions in life and health insurance companies, property and casualty insurance companies, consulting firms, or state or federal government agencies.

The most widely accepted standard of professional qualification to practice as an actuary in the United States is a Fellowship in either the Society of Actuaries (SoA) or the Casualty Actuarial Society (CAS). Each organization administers a series of examinations leading to Fellowship. The first few in this series are mathematical in nature covering topics in calculus and linear algebra, probability, mathematical and applied statistics. Students interested in the actuarial mathematics program should read the latest SoA Associateship Catalog for more information. This catalog may be obtained from the Department of Mathematical Sciences, or at <http://www.soa.org>.

The actuarial mathematics program at WPI provides the first steps in preparing for these examinations and an introduction to fundamentals in business and economics. Students with mathematical aptitude should be able to pass the first two SoA examinations before graduation.

After graduation, most actuarial training is through self-study combined with on-the-job experience. Many employers rotate their actuarial trainees through various assignments exposing them to different aspects of business operations. In addition, companies frequently maintain actuarial libraries, sponsor group study sessions, and give trainees study time during work hours.

Brief descriptions of the project opportunities, distribution requirements, and the actuarial examinations are given below.

PROJECTS/INDEPENDENT STUDIES

Off-campus qualifying projects are regularly done in collaboration with insurance companies, and have in the past been sponsored by Aetna, Allmerica Financial, Blue Cross Blue Shield of Massachusetts, John Hancock Mutual Insurance, Premier Insurance, and Travelers Property Casualty. These projects give real-world experience of the actuarial field by having students involved in solving problems faced by professional actuaries. Instead of choosing a project already posed by a company/advisor team, students may instead seek out industry-sponsored projects on their own (often through internship connections) and propose them to a potential faculty advisor. Alternatively, students may choose to complete any other project in mathematics.

Students should select MQP and independent study topics which are related to their areas of preparation and interest. Some project and independent study areas are given below. In addition, a current listing of specific available projects with their descriptions is available at the department office, and at <http://www.wpi.edu/Academics/Projects/available.html>.

MQP AND INDEPENDENT STUDY TOPICS AND ADVISORS

Topic Area	Faculty Advisor(s)
Actuarial Models (Stochastic and Deterministic)	A. Wiedie
Asset/Liability Management	D. Vermes
Auto Insurance Cession Strategies	A. Heinricher
Interest Rate Modeling	D. Vermes
Mathematical Finance	R. Lui
Pricing Insurance and Annuity Contracts	A. Wiedie
Risk Classification	A. Heinricher
Survival Models	A. Wiedie

Some Recent Actuarial Mathematics MQPs:

Development of a Test Algorithm for Cession Strategies

Students: Kristen Magnifico, Jeremy Olszewski,

Daniele Recore

Advisor: A. C. Heinricher

Sponsor: Premier Insurance Company

New methods for computing and predicting the net gain or loss for a certain cession strategy were explored for the Premier Insurance Company of Massachusetts. (Insurance companies can cede high-risk policies to Commonwealth Auto Reinsurance.) Various one and two-stage strategies were created using different variables. This tool can now be used by Premier to test future strategies. It can be helpful in investigating the sensitivity of the strategies to fluctuation in certain parameters, including CAR's deficit, that help determine Premier's gain or loss.

Pricing Guaranteed MV Life Insurance Policies

Students: Aaron Korthas, Shelby Woods

Advisor: A. Wiedie

Sponsor: John Hancock Life Insurance

By simulating hypothetical Medallion Variable Life Insurance policies, appropriate premiums are determined to guarantee a death benefit for various lengths of time under various investment scenarios. With these premiums there is an estimated high probability of having an adequate account balance by the end of the guarantee periods. As with any guarantee, John Hancock will lose money on policies that fail. Additional fees are calculated to offset the expected losses of failed policies.

Program Distribution Requirements for the Actuarial Mathematics Major

The normal period of residency at WPI is 16 terms. In addition to the WPI requirements applicable to all students, completion of a minimum of 10 units of study is required as follows:

Requirements	Minimum Units
1. Mathematics (including MQP) (See notes 1-6).	7
2. Management (See note 7).	4/3
3. Additional courses or independent studies (except MS, PE courses, and other degree requirements) from any area (See note 8).	5/3

NOTES:

1. Must include MA 3831 and MA 3832, or their equivalents, at least one of MA 3257, MA 3457, or equivalent, and at least one of MA 3631, MA 4632, or equivalent.
2. Must include two of the following: MA 2073, MA 2271, MA 2273, MA 2431, MA 2631, or their equivalents.
3. Must include three of the following: MA 3211, MA 3212, MA 4213, MA 4214, or their equivalents.
4. May not include independent studies directed toward Society of Actuaries exams.
5. May not include either MA 2201 or MA 2210.
6. May not include both MA 2631 and MA 2621.
7. Must include MG 2101 and MG 2200 or their equivalents.
8. Must include 2/3 units of computer science.

WPI COURSES AND THE SOCIETY OF ACTUARIES (SOA) EXAMINATIONS

The formulation of the distribution requirements for the program in actuarial mathematics was in large part motivated by the nature of the sequence of examinations that lead to Fellowship in the SoA or CAS. In particular, there are a number of WPI courses that cover fundamental topics that are included on the first few exams in this sequence.

ACTUARIAL MATHEMATICS MAJOR PROGRAM CHART

UNIVERSITY REQUIREMENTS	
Minimum Academic Credit	15 Units
Residency	8 Units
Sufficiency	2 Units
Interactive Qualifying Project	1 Unit
Major Qualifying Project	1 Unit
Social Science	2/3 Unit
Physical Education	1/3 Unit

FOUNDATION COURSES

INTRODUCTORY COURSES	TRANSITION COURSES (2/3 Unit Required)	CORE COURSES (4/3 Unit Required)	ACTUARIAL COURSES (1 Unit Required)
MA 1021-1024 or MA 1031-1034 MA 2051 MA 2071 MA 2201 MA 2210 MA 2251 MA 2611	MA 2073 MA 2271* MA 2273* MA 2431 MA 2631	Both MA 3831 and MA 3832 One of MA 3257 or MA 3457 One of MA 3631* or MA 4632*	MA 3211 MA 3212 MA 4213* MA4214*

OTHER MA COURSES TO ATTAIN TOTAL OF 6 UNITS:

ACTUARIAL MATH	ANALYSIS	ALGEBRA	DISCRETE MATH	COMPUTATIONAL MATH	OPERATIONS RESEARCH	STATISTICS/PROBABILITY
MA 3211 MA 3212 MA 4213* MA 4214*	MA 2431 MA 3471* MA 3475* MA 4291 MA 4451 MA 4473*	MA 2073 MA 3823* MA 3825*	MA 2271* MA 2273* MA 3233*	MA 3257 MA 3457 MA 4411*	MA 3231 MA 3233* MA 4235* MA 4237*	MA 2612 MA 2621 MA 2631 MA 3627* MA 3631 MA 4214* MA 4631 MA 4632 MA 4658

OTHER REQUIREMENTS

Computer Science (2/3 Unit Required)	Management (4/3 Unit Required)	
	Required MG 2101 MG 2200	Suggested MG 1100 MG 2250* MG 2260 MG 2300 MG 2500 MG 3501 MG 3760

* Category II courses, offered in alternating years.

Society of Actuaries

Examination

1. Mathematical Foundations of Actuarial Science
2. Interest Theory, Economics and Finance
3. Actuarial Models
4. Actuarial Modeling

WPI Courses

- MA 1021 to MA 1024, MA 2631
 MA 3211, SS 1110, SS 1120, MG 1100, MG 2200
 MA 3212, MA 4213, MA 4214, MA 2431, MA 4237
 In addition to topics in 3.: MA 2071, MA 2611, MA 2612, MA 3627

It must be emphasized that course work alone is not sufficient preparation for the examinations listed above; passage requires additional self-study. Several publications of the Society of Actuaries are available in the mathematics department office, and comprehensive information may be found at <http://www.soa.org> and <http://www.casact.org>. In addition, requests for information about the actuarial profession can be sent to the Society of Actuaries, 475 North Martingale Road, Suite 800, Schaumburg, IL 60173-2226.

STATISTICS MINOR

Statistical methods are widely used in science, engineering, business, and industry. The Statistics Minor is appropriate for all WPI students with interests in experimental design, data analysis, or statistical modeling. The minor is designed to enable a student to properly design studies and analyze the resulting data, and to evaluate statistical methods used in their field of study.

The statistics minor consists of completion of at least 2 units of work, which must consist of

1. **At least 5/3 units of coursework**, which must be drawn from the following lists of Foundation and Upper-Level Courses, and which must include successful completion of at least 2/3 units from each list:

Courses for Statistics Minor (5/3 Unit Required)

Foundation Courses (2/3 Unit Required)

- MA 2073 Matrices and Linear Algebra II
 MA 2611 Applied Statistics I
 MA 2612 Applied Statistics II
 MA 2631 Probability, or
 MA 2621 Probability for Applications

Upper-Level Courses (2/3 Unit Required)

- MA 3627 Applied Statistics III
 MA 3631 Mathematical Statistics
 MA 4213 Risk Theory
 MA 4214 Survival Models
 MA 4237 Probabilistic Methods in Operations Research
 MA 4631 Probability and Mathematical Statistics I
 MA 4632 Probability and Mathematical Statistics II
 Any statistics graduate course:
 MA 509 or any course numbered MA 540 through MA 559

2. **Capstone Experience** The capstone experience usually consists of completion of MA 4658, Statistical Consulting. In this course, undergraduate students work with statistics faculty and graduate students to learn statistical practice and provide statistical advice to clients from the WPI community. Alternatively, students may arrange an independent study with one of the statistics faculty.

For information about the Statistics Minor, see any of the statistics faculty: Professors Joseph D. Petruccielli, Balgobin Nandram, Carlos Morales, Ann H. Wiedie, or Jason Wilbur.

MATHEMATICS MINOR

The Minor in Mathematics consists of successful completion of at least 2 units of academic activities in mathematical sciences satisfying the following requirements:

1. At least 5/3 units must be coursework in the Mathematical Sciences Department at the 2000 level or above, of which at least 2/3 units must be upper-level courses, i.e. 3000-level, 4000-level, or graduate mathematics courses. Courses selected at the 2000 level, if any, must include at least one of the following courses:
 MA 2073 Matrices and Linear Algebra II
 MA 2251 Vector and Tensor Calculus
 MA 2271 Graph Theory
 MA 2273 Combinatorics
 MA 2431 Mathematical Modeling with Ordinary Differential Equations
 MA 2631 Probability
2. The final 1/3 unit Capstone Experience: The integrating capstone experience requires prior approval by the Mathematical Sciences Program Review Committee. The experience may be satisfied by certain 3000-level, 4000-level or graduate courses offered by the department (with instructor approval) or by a suitable independent study with a Mathematical Sciences faculty member. At the conclusion of the process, the student will fill out the Mathematics Minor Program Approval Form to be signed by the Capstone Experience instructor and the Program Review Committee.

Students are encouraged to choose thematically-related courses toward their minor so as to gain in-depth knowledge in some sub field of mathematics. The course selection should be discussed in advance with a Mathematical Sciences Department faculty member. Here are some examples of 5/3 units of coursework for four thematically-related minors. Other options are available.

Applied Analysis	Computational Analysis	Differential Equations	Discrete Mathematics	Operations Research
MA 2051	MA 2051	MA 2051	MA 2201	MA 2071
MA 2071	MA 2071	MA 2251	MA 2271	MA 2073
MA 2431	MA 2073	MA 3471	MA 2273	MA 3231
MA 3831	MA 3257	MA 4411	MA 3233	MA 3233
MA 3832	MA 3457	MA 4473	MA 533	MA 4235 or MA 4237

MECHANICAL ENGINEERING

G. TRYGGVASON, HEAD

PROFESSORS: D. Apelian, I. Bar-On, R. R. Biederman, C. A. Brown, M. Dimentberg, W. W. Durgin, R. R. Hagglund, A. H. Hoffman, H. Johari, R. L. Norton, R. J. Pryputniewicz, J. J. Rencis, B. J. Savilonis, R. D. Sisson, Jr., J. M. Sullivan, Jr., G. Tryggvason
 ASSOCIATE PROFESSORS: H. K. Ault, C. Demetry, N. Gatsonis, Z. Hou, M. M. Makhlof, D. J. Olinger, M. W. Richman, Y. Rong, S. Shivkumar
 ASSISTANT PROFESSORS: J. Blandino, M. Demetriou, M. Fofana, Y.-M. Moon
 VISITING ASSISTANT PROFESSOR: E. C. Cobb
 SAINT-GOBAIN PROFESSOR: C. A. Brown
 EMERITUS PROFESSORS: J. M. Boyd, H. T. Grandin, W. A. Kistler, J. A. Mayer, Jr., K. E. Scott, D. N. Zwiep

MISSION STATEMENT

The Mechanical Engineering program at WPI is designed to develop graduates who can deal with real world situations that involve technological and humanistic/societal issues. Students develop literacy and competency in utilizing scientific and engineering methods for devising useful products in an economical way, while considering the impacts on society. The Mechanical Engineering program is in harmony with the WPI Plan philosophy of education, in which each student develops competence, confidence and the skill of self-learning.

EDUCATIONAL PROGRAM OBJECTIVES

The Mechanical Engineering Program seeks to have alumni who:

- are successful professionals because of their mastery of the fundamental engineering sciences, mechanical engineering, and the design process.
- are leaders in society due to a broad preparation in technology, communication, teamwork, globalization, ethics, business acumen and entrepreneurship.
- will use their understanding of the impact of technology on society for the betterment of humankind.

EDUCATIONAL OUTCOME

Graduating students should demonstrate the following at a level equivalent to an entry-level engineer or first year graduate student:

1. An understanding of the fundamental principles of conservation laws, constitutive relations, mechanics and materials science.
2. The ability to apply mathematics, science and engineering to thermofluid and mechanical systems.
3. The ability to design a system, component or process to meet design criteria.
4. The ability to design and conduct experiments and to analyze and interpret the resulting data.

5. The ability to use modern engineering tools for engineering design and analysis.
6. The ability to communicate effectively both verbally and in writing.
7. The ability to function within multidisciplinary teams.
8. The ability to function professionally and ethically.
9. An understanding of contemporary issues and the impact of engineering solutions in a global/societal context.
10. An appreciation for the skills to accomplish life-long learning.
11. Knowledge of chemistry and calculus-based physics with depth in at least one.
12. The ability to apply advanced mathematics through multivariate calculus and differential equations.
13. Familiarity with statistics and linear algebra.

INTRODUCTION

Mechanical engineering uses the basic laws of the physical sciences, life sciences, the social science, and the humanities in their quest to serve mankind.

Airplanes, automobiles, trains, space vehicles, earth-moving equipment, nuclear reactors, plasma generators, heart-lung machines, miniature bearings, machines and machine tools, sewing machines, and power lawn mowers are but a few examples of the products with which mechanical engineering is associated.

Compared with other fields of engineering, mechanical engineering is the broadest in application as well as the most basic. Mechanical engineers design products, supervise production, conduct research and development, and manage businesses or technical operations. In addition, mechanical engineering requires persons who can use the sciences to devise useful products in an economic manner while minimizing the loss of our natural resources.

Looking forward to this wide range of possible careers, mechanical engineering students should get a sound foundation in mathematics and science, plan a sequence of cultural and social studies, aim for a real understanding of the fundamentals of engineering, and achieve a proper balance between theory and application. A working knowledge of computers must be established through formal or informal learning processes. Inspection trips to industrial plants and cooperative education assignments are encouraged.

In this regard, the Mechanical Engineering Department offers extensive, modern, well-equipped facilities in the Higgins and Washburn Laboratories. These laboratories, covering the broad spectrum of mechanical engineering activities, are briefly described in the *Resources available to Undergraduate Students* section of this Catalog. They are widely used by the students enrolled in Mechanical Engineering and related programs.

MECHANICAL ENGINEERING PROGRAM CHART

STUDENTS EARNING A B.S. DEGREE IN MECHANICAL ENGINEERING MUST COMPLETE 15 UNITS OF STUDY, DISTRIBUTED AS FOLLOWS:

4 UNITS OF NON-TECHNICAL ACTIVITIES

2 UNITS H&A SUFFICIENCY	See WPI Requirements
1 UNIT INTERACTIVE QUALIFYING (IQP) PROJECT	See WPI Requirements
2/3 UNIT SOCIAL SCIENCE	See WPI Requirements
1/3 UNIT PHYSICAL EDUCATION	See WPI Requirements

1 UNIT FREE ELECTIVE

1 UNIT FREE ELECTIVE	See Catalog
----------------------	-------------

4 UNITS OF MATHEMATICS AND BASIC SCIENCE

4/3 Units
Student Selected Courses from the General Category of Mathematics and/or Basic Science

5/3 Units
Differential & Integral Calculus and Ordinary Differential Equations

3/3 Units
One Chemistry and Two Physics, OR
One Physics and Two Chemistry

MATHEMATICS	
MA 1021	MA 1023
MA 1022	MA 1024
MA 2051	

SCIENCE	
CH 1010	CH 1020
PH 1110	PH 1120

6 UNITS OF MECHANICAL ENGINEERING (Notes 1 & 2)

1 unit required	1 unit required	1 unit required	1 unit required	2 units required
MECHANICAL SYSTEMS	THERMOFLUID SYSTEMS	OTHER COURSES	MAJOR QUALIFYING PROJECT (MQP)	ELECTIVES
ES 2501 ES 2502 ES 2503	ES 3001 ES 3003 ES 3004	ES 2001 EE 3601 ME 3901		At least one unit must be chosen as ES or ME courses at the 4000-level.

The courses listed above can be replaced by other equivalent courses, with approval by the ME Program Committee.

Note 1: A complete program must include an activity in each of the following six categories. Courses used to satisfy these activities can be multiple-counted. They can be used to simultaneously satisfy the mechanical engineering, mathematics and basic science, and free elective requirements.

OTHER ACTIVITIES					
Linear Algebra	Statistics	Mechanical System Design	Thermofluid System Design	Realization	Capstone Design
MA 2071 ME 3501 MA 2073 ME 4505 MA 4411 ME 4512 ME 3311 ME 4530 ME 3321 ME 4605	MA 2611 MA 2612 MA 2621 ME 3901	ME 3310 ME 4320 ME 3311 ME 4430 ME 3320 ME 4770 ME 3506 ME 4771 ME 4816 MQP (depending on topic)	ME 4429 ME 4430 ME 4770 ME 4771 MQP (depending on topic)	ES 3323 ME 1800 ME 2300 ME 3506 MQP (depending on topic)	ME 4320 ME 4429 ME 4430 ME 4770 ME 4816 MQP (depending on topic)

Note 2: Elective courses from other engineering disciplines may also be selected at the 2000, 3000 or 4000 levels.

Program Distribution Requirements for the Mechanical Engineering Major

The normal period of residency at WPI is 16 terms. In addition to WPI requirements applicable to all students (see page 22), students wishing to receive the ABET-accredited degree designated “Mechanical Engineering” must satisfy certain additional distribution requirements. These requirements apply to 10 units of study in the areas of mathematics, basic science, and engineering science and design as follows:

Requirements	Minimum Units
1. Mathematics and Basic Science (Notes 1, 2, 3).	4
2. Engineering Science and Design (includes MQP) (Notes 3, 4, 5, 6, 7, 8, 9).	6

NOTES:

1. Must include a minimum of 5/3 units of mathematics, including differential and integral calculus and differential equations.
2. Must include a minimum of 1/3 unit in chemistry and 2/3 unit in physics, or 1/3 unit in physics and 2/3 unit in chemistry.
3. Must include an activity that involves basic matrix algebra and the solution of systems of linear equations, and an activity that involves data analysis and applied statistical methods.
4. Must include 1/3 unit in each of the following: electrical engineering, materials science, and mechanical engineering experimentation.
5. Must include at least one unit of ME courses at the 4000-level.
6. May include 1000 level courses only if designated ES or ME.
7. Must include two stems of coherent course and/or project offerings as noted below in a and b.
 - a. A minimum of one unit of work in thermofluid systems that includes the topics of thermodynamics, fluid mechanics and heat transfer, plus an activity that integrates thermofluid design.
 - b. A minimum of one unit of work in mechanical systems that includes the topics of statics, dynamics, and stress analysis, plus an activity that integrates mechanical design.
8. Must include an activity which realizes (constructs) a device or system.
9. Must include 1/3 unit of Capstone Design Experience. Items 3, 5, 7a integration, 7b integration, 8, 9 may all be “multiple-counted.”

Each Mechanical Engineering student must complete a Capstone Design experience requirement. This capstone design experience is partially or fully accomplished by completing a Major Qualifying Project which integrates the past course work and involves significant engineering design. At the time of registration for the MQP, the project advisor will determine whether the MQP will meet the Capstone Design requirement or not. If not, the advisor will identify an additional 1/3 unit of course work in the area of design (ME 4320, ME 4429, ME 4430, ME 4770, or ME 4816) to be taken in order to meet the ABET Capstone Design requirement.

FUNDAMENTALS IN THE MAJOR

The WPI philosophy of education emphasizes the development of competence in students’ abilities in self-learning. In the context of the flexible WPI degree requirements and the breadth of the mechanical engineering profession, it is not possible—or beneficial—to specify a rigid educational pat-

tern. Rather, each student, with advice, should develop a program that best meets personal and professional goals.

It is clear that the profession of mechanical engineering rests on a deep understanding of the concepts of science and mathematics. The distribution requirements establish the minimum framework for meeting the student’s educational goals.

HUMANITIES/SOCIAL SCIENCES

It is difficult for mechanical engineers to design systems without being literate in the disciplines making up the social sciences, for the concerns of people and the flow of capital—economies—are central to technological development. The questions of values and mankind’s cultural experiences as exemplified in the humanities are critical to the study of modern technology. More and more engineering students recognize the need for literacy in the *humanities and social sciences*, and the Humanities and Arts Sufficiency and Social Sciences degree requirements are designed to meet this need. Mechanical engineering students are urged to work closely with their Sufficiency and Social Studies advisors as well as their academic advisor in the Mechanical Engineering Department to develop a program which meets their needs.

DISCIPLINARY LITERACY

In addition to disciplinary literacy, the process of design and problem solving is best met by multidisciplinary, problem-oriented experiences. At WPI, *projects* and *independent studies* are best suited to this educational experience. It may be difficult to generalize as to whether the student should develop literacy in a particular area by course or project experiences. *Courses* are sometimes the optimum mode in developing a disciplinary background, while projects are often effective in multidisciplinary, problem-centered studies. Mechanical engineering students should design programs that take full advantage of *both* of these learning modes.

The academic program of the student should be designed to provide for a continuous development in the scientific and engineering areas, including *analysis, design, and experimental studies*. Students are urged to take the Fundamentals of Engineering Examination, the first step toward becoming a registered professional engineer (P.E.), at the earliest opportunity.

AREAS IN WHICH COMPETENCE SHOULD BE DEVELOPED

The academic program of mechanical engineering students typically progresses from mathematics and basic science in the earliest years, through the engineering sciences, and then to analysis, design and experimentation. An operational capability in the use of computers must be acquired early in students’ programs, as well as an overall skill in graphic, oral, and written communications. *Humanities and arts* and *social science* studies are essential in the program. When applicable, advanced placement from high schools will be given appropriate credit and noted on the WPI transcript.

MECHANICAL ENGINEERING DEPARTMENT CONCENTRATIONS

AEROSPACE ENGINEERING (GATSONIS)

Students are provided with ample opportunity to develop technical competence in low- and high-speed aerodynamics, propulsion systems, structures, and aerospace systems design. Experimental facilities available for course and projects in aerospace engineering include several wind tunnels, vacuum chambers, and controls instrumentation. Modern computational laboratories are also available.

Typical MQPs include: the design, construction, and testing of remotely piloted aircraft and micro aerial vehicles; aerodynamics; flow and structural control; gas dynamics; combustion; electric propulsion; micro-propulsion.

BIOMECHANICAL (HOFFMAN)

Students blend biology and biotechnology coursework with continuum mechanics, biomechanics, biofluids, and biomedical materials to support their individual interest. MQPs are usually developed jointly with off-campus medical facilities, including the University of Massachusetts Medical Center.

Typically MQP topics include: soft tissue mechanics, flow in constricted blood vessels, joint kinematics, prosthetic devices, sports biomechanics, biomaterials, tissue engineering and rehabilitation.

ENGINEERING MECHANICS (RENCIS)

Students select courses to develop the ability to construct models to analyze, predict, and test the performance of solid structures, fluids, and composite materials under various situations.

Typical MQP topics include: mechanical vibrations, stress and strain analysis, computer methods in engineering mechanics, finite element analysis, and vibration isolation. Departmental testing facilities and computer and software support are available.

MECHANICAL DESIGN (NORTON)

Courses are available to support development of student interest in the design, analysis, and optimization of an assembly of components which produce a machine. Computer-based techniques are widely used in support of these activities.

Typical MQP topics are: optimum design of mechanical elements, stress analysis of machine components, evaluation and design of industrial machine components and systems, robotics, and computer-aided design and synthesis.

Aerospace

2 Required

- ME 2713 Astronautics
- ME 3711 Aerodynamics

Select 4

- ME 3410 Flow of Compressible Fluids
- ME 3715 Rocket and Spacecraft Propulsion **or**
- ME 3716 Air Breathing Propulsion
- ME 4605 Computational Fluid Mechanics
- ME 4712 Supersonic Aerodynamics
- ME 4715 Aerospace Structures
- ME 4724 High Speed Flow
- ME 4770 Aircraft Design **or**
- ME 4771 Spacecraft and Mission Design

*Plus Aerospace MQP

Biomechanical

Two (2) Biology and Biotechnology (BB) Courses

Select 4

- ME 3501 Elementary Continuum Mechanics
- ME 3506 Rehabilitation Engineering
- ME 4504 Biomechanics
- ME 4606 Biofluids
- ME 4814 Biomedical Materials
- Any BE course at the 3000-level or higher

* Plus Biomechanical-related MQP

Engineering Mechanics

Select 6

- ME 3023 Mech. Behavior & Modeling Properties of Eng'g Mat'ls
- ME 3501 Elementary Continuum Mechanics
- ME 3502 Advanced Stress Analysis
- ME 3506 Rehabilitation Engineering
- ME 3602 Intermediate Fluid Dynamics
- ME/BE 4504 Biomechanics
- ME 4505 Advanced Dynamics
- ME 4506 Mechanical Vibrations
- ME 4512 Introduction to the Finite Element Method
- ME 4530 Computational Methods in Mechanical Engineering

* Plus Engineering Mechanics MQP

Mechanical Design

2 Required

- ME 3310 Kinematics of Mechanisms
- ME 3320 Design of Machine Elements

Select 4

- ES 1310 Engineering Design Graphics
- ES 3323 Introduction to CAD
- ME 2300 Introduction to Engineering Design
- ME 3311 Dynamics of Mechanisms and Machines
- ME 3321 Dynamic Modeling
- ME 3506 Rehabilitation Engineering
- ME 4320 Advanced Engineering Design
- ME 4815 Industrial Robotics
- ME 4816 Materials Optimization for Engineers

* Plus Mechanical Design MQP

MECHANICAL ENGINEERING DEPARTMENT CONCENTRATIONS

MANUFACTURING (C. A. BROWN)

Courses are available to support student interest in manufacturing engineering, computer-aided design, computer-aided manufacturing, robotics, vision systems, and a variety of manufacturing processes.

Typical MQPs include: robotics, composite materials, factory automation, materials processing, computer-controlled machining, surface metrology, fixturing, machine dynamics, grinding, precision engineering, prototype manufacturing.

See also the Manufacturing Engineering degree program.

Manufacturing

Select 2

- ME 1800 Materials Selection and Manufacturing Processes
- ME 2820 Materials Processing
- ME 3023 Mechanical Behavior and Modeling Properties of Engineering Materials
- ME 4816 Materials Optimization for Engineers
- ME 4821 Chemistry, Properties, and Processing of Plastics
- ME 4822 Solidification Processing

Select 2

- ES 3011 Control Engineering I
- ME 3820 Computer-Aided Manufacturing
- ME 4815 Industrial Robotics

Select 2

- MG 2850 Engineering Economics
- MG 3400 Production System Design
- MG 3401 Production Planning and Control

* Plus Manufacturing MQP

MATERIALS SCIENCE AND ENGINEERING (SISSON)

Students interested in a strong materials science and engineering component can elect course and project activities in metals, ceramics, polymers, and composite materials with laboratory and project experience using facilities in Stoddard Laboratories.

Typical MQP topics include: X-ray diffraction, electron microscopy, computer modeling, mechanical testing and deformation mapping, plastic deformation, ceramic processing, friction, wear, corrosion, and materials processing.

Another option in the materials program is a Minor in Materials, which is described under Materials Engineering in this catalog.

Materials Science

Select 2

- ME 2820 Materials Processing
- ME 4816 Materials Optimization for Engineers
- ME 4822 Solidification Processing

Select 2

- ME 3023 Mech. Behavior and Modeling Properties of Eng'g Mat'ls
- ME 3811 Structure of Materials
- ME 4813 Ceramics
- ME 4814 Biomedical Materials
- ME 4821 Chemistry, Properties, and Processing of Plastics
- ME 4832 Corrosion and Corrosion Control

Select 2

- ME 4840 Physical Metallurgy
- ME 4850 Solid State Thermodynamics
- Any 500-level MTE course

* Plus Materials Science MQP

THERMAL-FLUID ENGINEERING (OLINGER)

Students study the theoretical and empirical bases of thermodynamics, heat transfer, mass transfer, and fluid flow, as well as the application of these fundamental engineering sciences to energy conversion, environmental control, and vehicular systems.

Typical MQPs include: biological fluid mechanics, laminar/turbulent separation, lifting bodies, heat pipes, electronic component cooling, power cycles, fluid component analysis and design, and energy storage.

Thermal-Fluids

Select 6

- ME 3410 Compressible Flow
- ME 3602 Intermediate Fluid Mechanics
- ME 3711 Aerodynamics I
- ME 3716 Air Breathing Propulsion
- ME 4412 Introduction to Combustion
- ME 4429 Thermodynamic Applications and Design
- ME 4605 Computational Fluid Mechanics
- ME 4606 Biofluids
- ME 4724 High Speed Flow

* Plus Thermal-Fluids MQP

Notes:

1. A Concentration area requires a 1 unit of MQP in that area.
2. After consultation with their academic advisor, students may petition the M.E. Dept. Curriculum Committee for approval of a Concentration plan at any time, preferably prior to the middle of their Junior Year.

MATHEMATICS AND BASIC SCIENCES

It is essential that mechanical engineering students establish a solid foundation in *mathematics*, the fundamental language of engineers. It is recommended that mechanical engineering students develop competence, as a minimum, in calculus and differential equations through such courses as: MA 1021, MA 1022, MA 1023, MA 1024, MA 2051. Additional courses are desirable and should be selected in consultation with the student's academic advisor as preparation for advanced-level course and project work.

An adequate background in the *basic sciences* is mandatory for mechanical engineering students and typically includes physics, chemistry, and other sciences. Programs should be planned so that topics related to mechanics, energy, heat, light, sound, optics, and electricity are covered in preparation for the material to be studied in the engineering sciences. Students, in consultation with their advisors, are urged to include in their programs courses from the following list which support their technical interest: PH 1110, PH 1120, PH 1130, CH 1010, CH 1020, CH 1030, BB 1001, BB 2002, GE 2341, GE 3050. Mathematics and basic sciences must include a minimum of four units, include both chemistry and physics with a minimum of two courses in either, and include differential and integral calculus and differential equations.

ENGINEERING SCIENCE AND DESIGN

For mechanical engineering students, the *engineering science and design* will normally require the equivalent of a year and a half of full-time study. In the engineering sciences, graphics; mechanics of solids, including stress analysis and dynamics; thermodynamics; fluid and continuum mechanics; materials science; and materials processing provide a background for the higher-level experiences. Students must also develop competence in closely-related engineering and science areas, such as electrical engineering, control engineering, computer science, and heat and mass transfer. A partial listing of engineering science courses of direct interest to the mechanical engineering student follows: ES 1310, ES 2001, ES 2501, ES 2503, ES 3001, ES 3003, ES 3004, ES 3011, ES 3323, ME 3501, ES 2502, ME 3502, ME 3505, EE 2011, EE 2022, EE 3601, and ES 2011.

With mastery of the basic and engineering sciences, mechanical engineering students are in a strong position to utilize the tools of their profession for the gaining of new knowledge and the solution of significant real-world problems, often termed "design." Their MQP and IQP enable them to specialize in a given area of mechanical engineering in an interdisciplinary setting.

Engineering design is the decision-making experience of an engineer in which the combination of the basic sciences, engineering sciences and mathematics is applied, with judgment, to use resources economically to meet stated objectives. The development of literacy and skill in design may include the establishment of objectives, criteria, synthesis, analysis, construction, experimentation, evaluation, and communication. Students should consult their advisors in selecting appropriate courses, projects and independent studies to meet their design require-

ments. Programs include the equivalent of at least one-half year of a design experience and often involve courses such as ME 2300, ME 3310, ME 3311, ME 3320, ME 3321, ME 4320, and ES 3323 plus the Major and Interactive Qualifying Projects along with independent study. Advanced design courses are available if a student decides to do in-depth study in this area. A minimum of six units of engineering science / design is required, and subdivided between engineering science and design on a 2:1 basis.

The one unit energy stem requirement is normally satisfied by taking courses such as ES 3001, ES 3003, and ES 3004. The one unit mechanical systems stem requirement is normally satisfied by taking courses such as ES 2501, ES 2502, and ES 2503.

Field trips and professional society activities are encouraged as they enhance overall professional perspectives.

MECHANICAL ENGINEERING DEPARTMENT CONCENTRATIONS

After developing competence in the basic engineering and science areas, mechanical engineering students are encouraged to select courses and projects in line with their personal and professional interests.

For those students having broad technical interests, and who wish to select wide-ranging upper-level courses (*see the Mechanical Engineering Program Chart*) and suitable MQP, early and continuing consultation with their academic advisors is encouraged to ensure that suitable preliminary work is completed on an appropriate schedule.

For those students that have an interest in pursuing upper-level activities within a narrow area of mechanical engineering, the Department offers seven specialty areas in which a "Concentration" may be earned. Each requires completion of six courses specified by that area, plus an MQP in that area. A brief description of each Concentration area, the name of a faculty member well versed in all phases of that area, and the particular course options and requirements are noted in the *Mechanical Engineering Concentrations chart*.

Students should note that they may utilize graduate courses if they are appropriate. The academic advisor must approve the course in advance. Integrated undergraduate-graduate programs are encouraged.

ENHANCED PROGRAMS

BS-MS PROGRAM IN MECHANICAL ENGINEERING

Outstanding students are encouraged to combine a master's degree with their undergraduate WPI studies. Details are found in the WPI GRADUATE PROGRAM section of this catalog, and interested students should initiate discussions with their advisor early in their junior year.

COOPERATIVE EDUCATION PROGRAM

The WPI Cooperative Education Program provides an opportunity to integrate "real-world" experience into an educational program. Details are found in the COOPERATIVE EDUCATION PROGRAM section on page 236.

**MECHANICAL ENGINEERING MINOR
(FOR NON-MAJORS)**

Non- ME majors interested in developing a ME minor in conjunction with their major should consult with the Department Head or the lead faculty member in the specific ME sub-area of interest to define a program leading to recognition of the minor. Each individual student minor must then be approved by the Committee on Academic Operations.

MECHANICAL ENGINEERING COURSES

Aerospace Engineering	Category
ME 2713 Astronautics	I
ME 3410 Flow of Compressible Fluids	I
ME 3711 Aerodynamics	I
ME 3715 Rocket and Spacecraft Propulsion or ME 3716 Air Breathing Propulsion	II (03-04) II (04-05)
ME 4712 Supersonic Aerodynamics	II (04-05)
ME 4715 Aerospace Structures	I
ME 4724 High Speed Flow	I
ME 4770 Aircraft Design or ME 4771 Spacecraft and Mission Design	I II (04-05)
Engineering Experimentation	
ME 3901 Engineering Experimentation	I
Engineering Mechanics	
ES 2501 Introduction to Static Systems	I
ES 2502 Stress Analysis	I
ES 2503 Introduction to Dynamic Systems	I
ME 1520 Mechanics of Alpine Skiing	
ME 3023 Mechanical Behavior and Modelling Properties of Engineering Materials	I
ME 3501 Elementary Continuum Mechanics	I
ME 3502 Advanced Mechanics of Materials	I
ME 3506 Rehabilitation Engineering	I
ME/BE 4504 Biomechanics	II (03-04)
ME 4505 Advanced Dynamics	II
ME 4506 Mechanical Vibrations	I
ME 4512 Introduction to the Finite Element Method	I
ME 4530 Computational Methods in Mechanical Engineering	II
ME 4922 Theory and Practice of Laser Instrumentation	I
Manufacturing Engineering	
ME 1800 Material Selection and Manufacturing Processes	I
ME 2820 Materials Processing	I
ME 3820 Computer-Aided Manufacturing	I
ME 4815 Industrial Robotics	I
Materials Science and Engineering	
ES 2001 Introduction to Material Science	I
ME 3023 Mechanical Behavior and Modeling Properties of Engineering Materials	I
ME 3811 Microstructure Analysis and Control	I
ME 4813 Ceramics	II
ME/BE 4814 Biomaterials	I
ME 4816 Materials Optimization for Engineers	II (03-04)
ME 4821 Chemistry, Properties and Processing of Plastics	II
ME 4822 Solidification Process	II (04-05)
ME 4832 Corrosion and Corrosion Control	II (04-05)
ME 4840 Physical Metallurgy	I
ME 4850 Solid State Thermodynamics	I
Mechanical Design	
ES 1310 Engineering Design Graphics	I
ES 3323 Introduction to CAD	I
ME 2300 Introduction to Engineering Design	I
ME 3310 Kinematics of Mechanisms	I
ME 3311 Dynamics of Mechanisms and Machines	I
ME 3320 Design of Machine Elements	I
ME 3321 Dynamic Modeling	I
ME 4320 Advanced Engineering Design	I

Thermal/Fluid Engineering

ES 3000 Classical Thermodynamics	I
ES 3001 Introduction to Thermodynamics	I
ES 3003 Heat Transfer	I
ES 3004 Fluid Mechanics	I
ME 3410 Compressible Flow	I
ME 3422 Environmental Issues and Analysis	II (03-04)
ME 3601 Principles of Mechanical Engineering	I
ME 3602 Intermediate Fluid Dynamics	I
ME 4412 Introduction to Combustion	II (04-05)
ME 4429 Thermofluid Applications and Design	I
ME 4604 Fluid Mechanics of Machines	II (03-04)
ME 4605 Computational Fluid Mechanics	I
ME/BE 4606 Biofluids	II (04-05)

Special Topics

ME 4010 Seminar	I
IS 4 ME Special Topics	I

Independent study topics in mechanical engineering may be arranged. Consult faculty in the specific technical area for details.

MILITARY SCIENCE**LTC RICHARD B. O'CONNOR, HEAD**

ASSISTANT PROFESSORS: MAJ P. Martin,
MAJ Harold Rider, MSG John Veals, Jr.,
SFC John McPhee

INTRODUCTION

The Army Reserve Officer Training Corps (ROTC) is offered by WPI and is available to all male and female students within the Worcester Consortium. Physically qualified American citizens who complete the entire four-year program, concurrent with baccalaureate degree completion, may be commissioned in the United States Army, Army Reserve or Army National Guard. Emphasis throughout is on the development of individual leadership abilities and preparation of the student for a lifetime of service to the nation. The Military Science Department offers several concurrent programs designed to complement the WPI Plan. There are two variations of ROTC available to students who desire to participate:

The four-year program is an on-campus program during which students participate in required Military Science courses and activities. Students attend a six-week National Advanced Leadership Camp (with pay) between the third and fourth year for practical application of classroom instruction.

The two-year ROTC program begins with a six-week Leader Training Course (with pay). Upon successful completion of LTC, the student enters the third year of ROTC and will attend NALC during the following summer. If a student completed Basic and Advanced Individual Training with the U.S. Army, he/she can qualify for the two-year ROTC program.

All Military Science courses are open to any interested student without incurring any military obligation. Military Science courses are an excellent medium for personal enrichment and development of leadership abilities.

MILITARY SCIENCE COURSE FLOW CHART

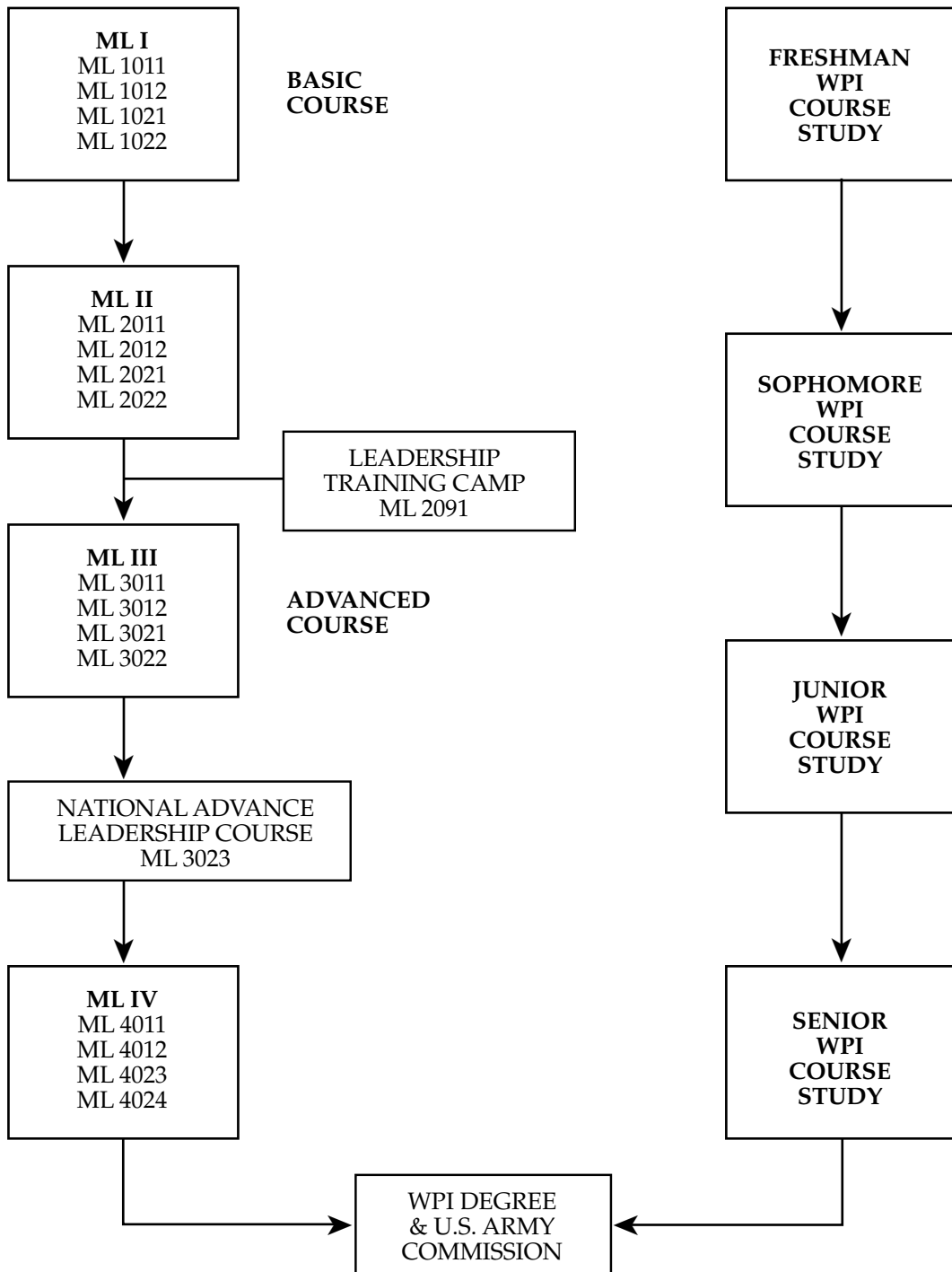

- (1) Required for 2 year ROTC program students.
- (2) Additional requirements: Professional Military Education.
Five Undergraduate Courses.
Leadership Laboratories, weekly.
Physical Training, weekly.
Weekend Field Training Exercise (2 each year).
Social Events.
- (3) Required attendance for all Juniors and Seniors.

BASIC COURSE

The Basic Course includes classroom instruction and practical application opportunities which introduce the student to the Army and the Army to the student. Since all effective leaders must understand the organization in which they will function, initial instruction is intended to create a working knowledge of the Army. Subsequent instruction deals with the study of military leadership, management and technical proficiency.

ADVANCED COURSE

The Advanced Course includes classroom instruction and practical application opportunities taught during the third and fourth years. The objective is to develop leaders; to give the cadet experience in first organizing, then managing a project; to enable the cadet to take charge of any project and to bring it to a successful conclusion. This acquired ability is useful in every human endeavor; it is essential to the military leader. In conjunction with the theoretical approach to leadership studied in class, students are required to apply their knowledge during Leadership Laboratories. The Advanced Course is open to all students who have satisfactorily completed two years in the basic course or the equivalent.

Juniors enrolled in the advanced course receive a tax-free subsistence allowance of \$350 each month; seniors receive \$400 monthly. Pay during the National Advanced Leadership Course (NALC), is as set by Congressional legislation. To enroll in the Advanced Course, students must execute a contract stating they will continue the course of instruction for two years and accept the commission of Second Lieutenant in the United States Army, Army Reserve or Army National Guard upon graduation.

PROFESSIONAL MILITARY EDUCATION

The required professional military education component encompasses the full four years of study. It consists of two essential parts:

1. Completion of a baccalaureate degree;
2. Undergraduate certification in the areas of written communications, military history, and computer literacy.

LEADERSHIP LABORATORY

Leadership Laboratory consists of a monthly four-hour practical exercise in leadership or military skills. It is an integral part of the annual ROTC program. The purpose of Leadership Laboratory is to give each cadet the opportunity to apply practically the theory learned during formal class periods. The senior cadets conduct the laboratory period with underclass students filling subordinate roles; level of responsibility depends upon how far they have advanced in ROTC.

The Military Science Department encourages its cadets to participate in athletics and to join other extracurricular activities in order to practice leadership theories learned in military science.

PHYSICAL EDUCATION

D. L. HARMON, HEAD

ASSOCIATE PROFESSORS: P. J. Grebinar

REQUIREMENTS

Qualification in physical education shall be established by completing 1/3 unit of course work or its equivalency. *Students are urged to complete this requirement in their first two years of residency at WPI.* Such an equivalency may be satisfied through the PE 1100 series. PE 1100 is designed for students who wish to obtain PE credit through any of five different categories as listed below and may be substituted for any 1/12 unit PE course:

1. WPI approved varsity athletic team participation. Student must be registered in advance of participation.
2. Club Sports. Students must be members of a PE approved club prior to becoming eligible for physical education credit. Students must be registered in advance of participation.
3. Approved courses not offered at WPI; advance approval by the head of the Physical Education Department is necessary.
4. Individualized program at WPI; advance approval by the head of the Physical Education Department is necessary.
5. Proficiency testing is available in some areas; arrangements should be made with a Physical Education Department instructor.

Students who wish to obtain PE credit by the above means must be enrolled in a course in the PE 1100 series.

No student may use any 1/12-unit PE courses beyond the four required 1/12 unit to satisfy any other requirement, or to meet the 15-unit rule.

Participation in certain ROTC programs may entitle students to a waiver of the PE requirement.

ATHLETIC PROGRAMS

THE INTERCOLLEGIATE PROGRAM

The intercollegiate athletics program offers competition in 21 varsity sports.

All full-time members of the physical education faculty and staff are involved in coaching, with assistance from other faculty members and part-time coaches from the community who have special skills in athletics.

WPI has excellent facilities and provides the best in protective equipment but, if an injury should occur, a team physician and full-time trainers are available, offering the latest treatment methods and facilities.

Practices are normally held daily, after classes, in the afternoon. Midweek contests involving travel are held to a minimum to avoid missing classes. Every effort is made to avoid conflicts with academic activities, and competitions are generally scheduled with schools with similar standards and objectives.

In recent years, teams and individuals have been sent to regional and national tournaments to allow them to compete at the highest possible level. All-America recognition has been attained recently in football, men's soccer, track and field, and wrestling.

The athletic program forms an important point of contact with other universities and colleges in the East and is an opportunity for our students to compete against conference and independent institutions.

Varsity Sports

Baseball	Soccer (men)
Basketball (men)	Soccer (women)
Basketball (women)	Softball
Crew (men)	Swimming & Diving (men)
Crew (women)	Swimming & Diving (women)
Cross Country (men)	Tennis (men)
Cross Country (women)	Tennis (women)
Field Hockey	Track (men)
Football	Track (women)
Golf (fall and spring)	Volleyball (women)
	Wrestling

THE CLUB SPORTS PROGRAM

The Club Sports Program offers a variety of competitive activities for student participation. Most of the Club Sports listed below compete against teams from other institutions.

Club Sports

Alpine Skiing	Lacrosse (men/women)
Cheerleaders	Martial Arts (SOMA)
Coed Soccer	Rugby
Fencing	Scuba
Free Style Wrestling	Ultimate Frisbee
Ice Hockey	Volleyball (men)
	Water Polo

Club Sports, Class II, are administered through the Department of Physical Education and Athletics and details regarding the activities listed above are available through the Coordinator of Club Sports in Alumni Gymnasium.

THE INTRAMURAL PROGRAM

The Intramural Program is designed as an opportunity for students to enjoy the benefits of recreation and athletic competition even though they may not have the time, talent or desire to compete on the higher intercollegiate level.

Entries are welcome not only from fraternities, sororities and other residential units but also from a variety of independent student groups and individuals, including faculty and staff. Approximately 50% of the student body participate in intramurals.

The program includes flag football, floor hockey, volleyball, cross-country, basketball, swimming, soccer, water polo, softball, bowling, table tennis, and track. The program is ever-expanding, and activities are added as needs arise and time and facilities permit.

The program is administered by the Department of Physical Education and Athletics, and all details regarding scheduling and eligibility are available in the Director of Intramurals located in Alumni Gym.

PHYSICS

T. H. KEIL, HEAD

PROFESSORS: S. N. Jaspersen, T. H. Keil, D. F. Nelson, G. D. J. Phillis, L. R. Ram-Mohan

ASSOCIATE PROFESSORS: P. K. Aravind, N. A. Burnham, R. S. Quimby, S. W. Pierson, L. C. Lew Yan Voon, A. A. Zozulya

ASSISTANT PROFESSORS: G. S. Iannacchione, C. Koleci

MISSION STATEMENT

The Physics Department provides education in physics to both undergraduate and graduate students and contributes to the growth of human knowledge through scholarly work.

OBJECTIVES

The physics department educates students with a program characterized by curricular flexibility, student project work, and active involvement of students in their learning. Through a balanced, integrated curriculum stressing the widely applicable skills and knowledge of physics, we provide an education that is strong both in fundamentals and in applied knowledge, appropriate for immediate use in a variety of fields as well as graduate study and lifelong learning.

EDUCATIONAL OUTCOMES

We expect that physics graduates:

1. Know, understand, and use a broad range of basic physical principles.
2. Have an understanding of appropriate mathematical methods, and an ability to apply them to physics.
3. Have demonstrated oral and written communications skills.
4. Understand options for careers and further education, and have the necessary educational preparation to pursue those options.
5. Have an ability to learn independently.
6. Have acquired the broad education envisioned by the WPI Plan.
7. Are prepared for entry level careers in a variety of fields, and are aware of the technical, professional, and ethical components.
8. Are prepared for graduate study in physics and/or other fields.
9. Can find, read, and critically evaluate selected original scientific literature.

INTRODUCTION

Ask a physicist what physics has to do with, and you are likely to be told: "Everything!" Though oversimplified, this answer does contain a kernel of truth. In their study of nature, physicists concern themselves with interactions involving matter and energy of every form.

Physicists' interests range from the tiny world of subatomic particles to stars, galaxies and the vast cosmic sea of space and time in which they travel. They have devel-

oped intricate tools to assist the human senses in probing these remote extremes of our natural environment. They have distilled their understanding of nature into laws of great generality and elegance, from the mathematical patterns needed to interpret the perfect symmetry and the regularity of atoms and crystals, to the powerful mathematical treatment of chaos and disorder needed to deal with the concept of heat.

Of course, not all physicists work at the very limits of our knowledge of nature. Many use their understanding of physics to develop practical applications that solve more familiar human problems. The pioneering work on semiconductors in the 1940s led to the development of computers, transistor radios and a communication network that is bringing the peoples of the world ever closer together. The laser, invented in the 1960s, has been used in such varied applications as eye surgery and radar, and even in computerized cash registers. The list of problems solved is long; the list of future possibilities is endless. So there is some truth in the statement that "physics has to do with everything."

One of the distinguishing characteristics of the physicist's approach is a cyclical growth pattern. Systematic experiments provide new facts. New theory is developed to summarize these facts and make them manageable. The new theory has as its consequences practical applications and new questions, leading to new experimentation. Along the way, physicists are guided by certain fundamental principles such as symmetry, continuity and conservation laws.

Students come to the study of physics from many backgrounds and for many reasons. Two aspects in particular seem to attract them. The first is the opportunity to choose from a wide range of intriguing subjects of study, both theoretical and experimental, both fundamental and applied. The second is the combination of intuitive ideas and the penetrating style of logical and mathematical problem-solving which students come to realize physics "has to do with."

CAREER OPPORTUNITIES IN PHYSICS

Undergraduate physics programs were once formulated with the expectation that graduating students would enter postgraduate programs, where they would earn an advanced degree under the guidance of a practicing physicist. The long-term career objective was assumed to be a permanent position in an academic physics department, with interests divided between scientific research and teaching. Although this traditional outlook is still valid for many students entering the study of physics today, the unprecedented worldwide growth of science-based industries has led to exciting new career opportunities involving pure physics mixed with engineering and applied science. Many technically oriented students have also a deep interests in pure science; they are attracted to applied physics because it allows them to satisfy their scientific curiosity while at the same time pursuing the practical objectives of an engineer. In recognition of this new career choice the physics department offers a degree in engineering physics

in addition to the traditional physics program. As shown in the sample programs below, students for this degree have great freedom to shape their program to match their individual interests.

AREAS OF FACULTY INTEREST (PROJECT AND INDEPENDENT STUDIES)

P. Aravind	Quantum optics, quantum mechanics, group theory.
N. Burnham	Atomic force microscopy, nanomechanics
G. Iannacchione	Calorimetry, liquid crystals
S. Jaspersen	Optical properties of solids, optical instruments.
T. Keil	Solid state physics, mathematical physics, fluid mechanics.
C. Koleci	Physics education research.
L. Lew Yan Voon	Solid state physics, semiconductors
D. Nelson	Optical and transport properties, solid state physics, lattice dynamics.
G. Phillies	Light scattering spectroscopy, complex fluids, biochemical physics.
S. Pierson	Statistical mechanics, super conductivity.
R. Quimby	Optical properties of solids, laser spectroscopy.
L. Ram-Mohan	Field theory, many body problems, solid state physics, linear and non-linear optical properties of semiconductors, computational physics.
A. Zozulya	Non-linear optics, photo-refractive materials

Program Distribution Requirements for the Physics and Engineering Physics Majors

The normal period of residency at WPI is 16 terms. In addition to the WPI requirements applicable to all students (see page 22), completion of a minimum of 10 units of study is required in the areas of mathematics, physics, and related fields as follows:

PHYSICS

Requirements	Minimum Units
1. Mathematics (Note 1).	3
2. Physics (including the MQP; may include ES 3001) (Note 2).	5
3. Other subjects to be selected from mathematics, science, engineering, computer science, and management (Note 2).	2

Notes:

1. Mathematics must include at least 2/3 unit of mathematics at the level of MA 3000 or higher.
2. Either item 2 or 3 must include 1/3 unit of PH 2651, or other laboratory course approved by the department Program Review Committee following petition by the student.

ENGINEERING PHYSICS

1. Same requirements as PHYSICS, with the addition that the 10 units must include 2 units of coordinated engineering and other technical/scientific activities. The 2-unit program must be formulated prior to final year of study by student in consultation with the academic advisor, and must be certified prior to the final year by the departmental Program Review Committee.

Curriculum Outline — Physics and Engineering-Physics

The programs of study described below are designed to fulfill the needs and interests of students over the range from “pure” to “applied,” or “engineering” science. They are designed to provide, first of all, a foundation in the indispensable principles and techniques of classical and modern physics. Such preparation is necessary and appropriate for any future in science and technology, including that of post-graduate study and research. Moreover, insofar as appropriate within an undergraduate curriculum, programs are offered which allow options of special experience in some of the active areas of applied or engineering physics.

All programs include a common group of recommended core courses which provide the foundation, beginning with the great themes of physics—matter, motion, forces, energy, and the nature and concepts of electricity and magnetism. They build on that basic knowledge and perspective together with progressively more sophisticated mathematical techniques. Beyond this essential core, a student may choose either a more traditional program of physics study or one relating to an area of individual interest with engineering applications. Illustrations of these options are outlined in the section below, “Physics and Engineering-Physics Programs.”

Guidance in the planning of students’ programs will be provided by academic advisors. A departmental engineering-physics coordinator is also available for consultation by students and academic advisors on questions pertaining to curriculum and project matters.

In addition to the courses, the Major Qualifying Project (MQP) has the potential to provide valuable experience and to broaden students’ perspectives in the chosen subject area—this is one of the exceptional opportunities uniquely associated with the WPI Plan. In the case of students concentrating in one of the engineering-physics fields, the project topic would be chosen for its relevance to that area of interest. Additional information about the MQP is presented in the section on page 156, “Project Opportunities in Physics and Engineering-Physics.”

Students who feel that their interests and objectives do not fit naturally into any of the illustrative programs presented here are invited to consult with their academic advisors and with representatives of the Physics Department. It is usually possible to adapt a program to their individual needs.

PHYSICS AND ENGINEERING-PHYSICS PROGRAMS

For a student entering the study of physics, there is a natural progression of subjects which provide a foundation for advanced work within physics and engineering-physics programs. This constitutes a core sequence which embodies the following indispensable basic areas of study: classical mechanics, electromagnetism, a survey of modern physics, statistical and quantum physics, and laboratory experimental methods. Because the language of the exact sciences is mathematics, there is a parallel core sequence of

mathematics courses normally taken either as preparation for or concurrently with the physics courses with which they are paired in the list presented below. In the following table \rightarrow indicates that the mathematics course is strongly recommended; \leftrightarrow indicates that concurrent study is acceptable.

MA 1021 Calculus I	\leftrightarrow	PH 1110 Mechanics
MA 1022 Calculus II	\leftrightarrow	PH 1120 Electricity and Magnetism
MA 1023 Calculus III	\leftrightarrow	PH 1111 Mechanics
MA 1024 Calculus IV	\leftrightarrow	PH 1121 Electricity and Magnetism
MA 1023 Calculus III	\leftrightarrow	PH 1130 Introduction to 20th Century Physics
MA 1024 Calculus IV	\leftrightarrow	PH 1140 Oscillations and Waves
MA 2051 Differential Equations	\leftrightarrow	PH 2202 Intermediate Mechanics II
MA 2071 Linear Algebra		PH 2651 Physics Laboratory
MA 2251 Vector/Tensor Calculus	\rightarrow	PH 2301 Electromagnetic Fields I
MA 4451 Boundary Value Problems	\leftrightarrow	PH 3301 Electromagnetic Theory
	\rightarrow	PH 3401 Quantum Mechanics I
		PH 4206 Statistical Physics
(PH 1110, PH 1120)	}	Students needing a somewhat more gradual introduction and an opportunity to gain mathematical skills concurrently are advised to substitute these courses for PH 1111 and PH 1121.

Physics and engineering-physics students should also reserve part of their undergraduate experience for developing perspective in a range of other science and engineering disciplines. A few of the many possibilities are illustrated by the following examples.

- Chemistry (CH 1010, 1030); Material Science (ES 2001). Choosing appropriate materials is often crucial in the development of new experimental techniques that can further our knowledge of physical phenomena. Conversely, the studies of physicists have had profound effects on the development of new materials.
- Electronics, both analog (EE 2201 and 3204, and digital (EE 2022). Electronics pervades the modern laboratory. It is valuable to learn electronic principles and designs as they are applied in modern “on-line” experimental data collection and data reduction systems.
- Computer science (CS 1005 and CS 2005). Physics students will need to make skillful use of computers in present and future experimental data processing, theoretical analyses, and the storing, retrieving and displaying of scientific information.
- Engineering courses related to science. Some basic knowledge in areas such as heat transfer, control systems, fluid mechanics, stress analysis and similar topics will prove to be of great benefit to the physicist called upon to apply professional knowledge to practical engineering problems.

Building on this core and topical subject coverage, physics students are in a position to turn in any number of directions within the range of physics studies, depending on individual interests and career objectives. Six illustrative examples are outlined below. In each case the outline includes a list of recommended and related courses followed

by a sampling of project opportunities in the respective areas. Selection of specific courses and projects should be determined by students' interests and the guidance of their academic advisors and the engineering-physics coordinator. For courses outside of the physics department, students are advised to discuss the prerequisites with the instructor.

1. Physics

Recommended Courses

PH 3402 Quantum Mechanics II
PH 4201 Advanced Classical Mechanics
PH (IS/P) Selected Readings in Physics

Related Courses

EE 2311 Continuous-Time Signal and System Analysis
EE 2312 Discrete-Time Signal and System Analysis
EE 3801 Advanced Logic Design
EE 3901 Semiconductor Devices
ES 3011 Control Engineering I
PH 3117 Problem Solving Seminar
PH 3501 Relativity
PH 3502 Solid State Physics
PH 3503 Nuclear Physics
PH 3504 Optics
PH (IS/P) Modern Optics
PH 501 (Graduate) Mathematical Methods of Physics I
PH 511 (Graduate) Classical Mechanics
MA 4291 Applicable Complex Variables

2. Computational Physics.

Recommended Courses

MA 3257 Numerical Analysis I
MA 4411 Numerical Solutions of Differential Equations
PH (IS/P) Numerical Techniques in Physics

Related Courses

PH 3117 Problem Solving Seminar
PH 3402 Quantum Mechanics II
PH 3502 Solid State Physics
PH 501/2 (Graduate) Mathematical Physics
MA 4033 Numerical Methods for Calculus and Differential Equations
MA 4291 Applicable Complex Variables
CS 1005 Introduction to Programming
CS 2005 Techniques of Programming
CS 2011 Introduction to Computer Organization and Assembly Language
CS 4731 Computer Graphics
EE 2311 Continuous-Time Signal and System Analysis
EE 2312 Discrete-Time Signal and System Analysis
EE 3801 Advanced Logic Design
ES 3011 Control Engineering I

3. Optics

Recommended Courses

PH 3504 Optics
PH 2501 Photonics
PH 2502 Lasers

Related Courses

PH 3117 Problem Solving Seminar
PH 3402 Quantum Mechanics II
PH 3502 Solid State Physics
PH 542/3 (Graduate) Modern Optics I and II
MA 4291 Applicable Complex Variables
ID 3150 Light, Vision, and Understanding
EE 2311 Continuous-Time Signal and System Analysis
EE 2312 Discrete-Time Signal and System Analysis
ES 3011 Control Engineering I

4. Electromagnetism

Recommended Courses

PH (IS/P) Modern Optics
PH (IS/P) Selected Readings in Electromagnetism

Related Courses

PH 3117 Problem Solving Seminar
PH 3402 Quantum Mechanics II
PH 3502 Solid State Physics
PH 3503 Nuclear Physics
PH 3504 Optics
PH 533 (Graduate) Electromagnetic Theory
PH 514/5 (Graduate) Quantum Mechanics
MA 4291 Applicable Complex Variables
EE 2311 Continuous-Time Signal and System Analysis
EE 2312 Discrete-Time Signal and System Analysis
ES 3011 Control Engineering I

5. Nuclear Science And Engineering

Recommended Courses

ES 2011 Introduction to Nuclear Technology
PH 3503 Nuclear Physics

Related Courses

PH 3117 Problem Solving Seminar
PH 3402 Quantum Mechanics II
PH 3501 Relativity
PH 553 (Graduate) Nuclear Physics
ME 4832 Corrosion and Corrosion Control
EE 3801 Advanced Logic Design
ES 3011 Control Engineering I

6. Thermal Physics

Recommended Courses

ES 3001 The Statistical Development of Classical Thermodynamics
ES 3004 Fluid Mechanics
PH (IS/P) Selected Readings in Thermal Physics

Related Courses

ES 3003 Heat Transfer
ES 3011 Control Engineering I
PH 3117 Problem Solving Seminar
ME 3410 Compressible Flow
PH 3502 Solid State Physics
PH 3504 Optics
ME 4429 Thermodynamic Applications and Design
ME 4602 Intermediate Fluid Dynamics
PH 501/2 (Graduate) Mathematical Physics

Project Opportunities in Physics and Engineering-Physics

Opportunities for physics students to participate in theoretical, computer-aided or experimental research exist in numerous fields, including nuclear and particle physics, modern and classical optics, statistical and solid-state physics, electromagnetism, astrophysics, field theories, and in the great range of subfields within these categories.

In the engineering-physics programs, the MQP subject is generally chosen for its relevance to the particular area of concentration. Students usually obtain the assistance of their academic advisors and of the engineering-physics coordinator in arranging the project. It may also include the participation of a project coadvisor who is a member of the engineering faculty.

Information for the selection of a Major Qualifying Project (MQP) by physics and engineering-physics students can be obtained from physics faculty members at any time during the academic year, and especially during the

Term C project planning period. A project resource booklet, available in the department office, provides MQP subject information, identification of participating faculty and their areas of interest, and data relating to past projects. Physics faculty serve as project advisors on MQPs in their own fields of research, and sometimes in other appropriate scientific areas of mutual student-advisor interest.

For all physics and engineering-physics students, there are opportunities for off-campus projects in industries, hospitals, research institutions, government and other resources in the Worcester vicinity and beyond. Information on these possibilities, which are constantly changing and expanding, is managed and made available to students and faculty on the Projects Program web site.

PHYSICS FOR NONPHYSICS MAJORS

Physics is the scientific underpinning for all engineering work and is therefore considered by prospective engineers, almost without exception, to be a subject which merits serious study. The elementary physics sequence at WPI encompasses the subject areas of classical mechanics (PH 1110/PH 1111), electricity and magnetism (PH 1120/PH 1121), 20th century physics (PH 1130), and oscillation and wave phenomena (PH 1140). The sequence is designed to be taken either in the pattern PH 1110, 1120, 1130, 1140, or PH 1111, 1121, 1130, 1140, although other orderings are possible, depending on special circumstances.

The first two courses in this sequence are offered in two versions because of the diversity of backgrounds and preparation of entering students. PH 1111 and PH 1121 are aimed primarily at freshmen with a solid background in the sciences and in mathematics, including calculus. In particular, students in PH 1111 and PH 1121 should be able to differentiate and integrate elementary trigonometric and polynomial functions, and to interpret these operations in graphical form. PH 1110 and PH 1120 are taught at a mathematically less demanding level and are designed for students concurrently beginning their study of calculus, having had little or no college-level calculus preparation in high school.

The courses in classical mechanics and electricity and magnetism are regarded as essential preparation for many fundamental engineering courses as well as for further work in physics. PH 1130 gives a first introduction to 20th century physics: the theory of relativity, quantum physics, nuclear physics and elementary particles. It is designed to provide a context for the appreciation of present-day advances in physics and high-technology applications. PH 1140 deals in depth with oscillations and waves. Engineering applications of this subject reach all the way from LC circuits and electromagnetic wave propagation in electrical engineering to the vibrations of large scale structures such as machinery and highway bridges in mechanical engineering and civil engineering.

There are several intermediate physics courses that may be of interest to nonphysics majors. PH 2201-2202 give a physicist's view of mechanics which to mechanical engineering majors may be an interesting and useful complement to the engineering courses in statics and dynamics. The physics courses in quantum mechanics, PH 3401-3402, and solid state physics, PH 3502, may be of great interest

to electrical engineering students specializing in solid state electronics. The courses in electromagnetic field theory, PH 2301 and PH 3301, and optics, PH 3504, would provide a valuable background for students in many areas, such as modern communication systems, fiber optics and optical computing. These are just examples; other courses are also available. For specific information on individual courses, students may consult with the course instructor or with the Physics Department head.

PHYSICS MINOR

The Physics Minor offers non-Physics majors the opportunity to broaden their understanding of both the principles of physics and the application of those principles to modern day engineering problems. In these times of rapid technological change, knowledge of fundamental principles is a key to adaptability in a changing workforce.

Two units of coordinated physics activity are required for the Physics Minor, as follows (note that, in accordance with Institute policy, no more than 3/3 of these units may be double-counted toward other degree requirements):

1. Any or all of the following four introductory courses:

- PH 1110 or PH 1111
- PH 1120 or PH 1121
- PH 1130
- PH 1140

2. At least 2/3 unit of upper level physics courses (2000 level or higher), which may include IS/P courses or independent studies approved by the program review committee. Examples of courses of this type which might be selected are (but are not limited to):

- PH 2201 Intermediate Mechanics I
- PH 2301 Electromagnetic Fields
- PH 2651 Physics Laboratory
- PH 3401 Quantum Mechanics I
- PH 3504 Optics
- PH 2501 Photonics
- IS/P Quantum Engineering

Students who have taken the four course introductory sequence should have an adequate physics background for these courses; see, however, the individual course descriptions for the expected mathematical background. Other physics courses may be selected for the physics minor, but the recommended background for such courses often includes one or more of the courses listed above.

3. Capstone Experience

The capstone experience for the physics minor can be satisfied either by an independent study arranged for this purpose, or by one of the upper level courses. IF the second option is chosen, the student must discuss this with the instructor prior to the start of the course. In either case, documentation of the capstone experience will consist of a paper, prepared in consultation with the instructor or independent study advisor, which incorporates and ties together concepts learned in the physics courses selected.

For more information, or assistance in selecting a minor advisor or an independent study advisor, see the Head of the Physics Department in Olin Hall 119.

Majors in Physics or Engineering Physics do not qualify for a Minor in Physics.

PRE-LAW PROGRAMS

ADVISORS: G. HEATON, K. RISSMILLER

Law schools do not require that undergraduates complete any particular course of study. Thus, students who complete degrees in engineering and science may wish to consider careers in law. Undergraduates interested in attending law school are encouraged to choose from among the many courses offered which explore legal topics. For those with greater interest, WPI offers a Minor in Law and Technology described on page 121. Courses with substantial legal content are listed among those courses fulfilling the requirements of the minor.

Enrolling in these courses will introduce students to the fundamentals of legal process and legal analysis. Students will study statutes, regulations and case law. These courses will, therefore, offer the student valuable exposure to the kind of material commonly studied in law schools and they may help demonstrate a student's interest to law school admission committees. IQPs in Division 52, Law and Technology, or other projects that involve library research and extensive writing may also be helpful.

A pre-law advising program in the Social Science Department maintains information on careers in law, law schools, and the law school admission test (LSAT), which is universally required. Students may examine this material independently or make an appointment. Students with an interest in law are also encouraged to join the Pre-Law Society. To do so, contact Professor Rissmiller.

PRE-MBA PROGRAM (DUAL DEGREE)

ADVISOR: N. WILKINSON

A B.S./MBA program is available to outstanding WPI undergraduate students majoring in an engineering or science discipline. A separate and complete application to the MBA program must be submitted. Admission to the Combined Program is determined by the faculty of the Department of Management. The student should begin the curriculum planning process at the time he/she commences his/her undergraduate studies to ensure that all of the required prerequisite undergraduate courses are completed within the student's four years of undergraduate study. It is recommended that the MBA application be submitted at the beginning of the student's junior year of undergraduate study. A student in the Combined Program continues to be registered as an undergraduate until the bachelor's degree is awarded.

Students wishing to do a Combined B.S./MBA must complete the following courses while an undergraduate: MG 1100 *Financial Accounting*; MG 2200 *Financial Management*; MG/IE 2300 *Organizational Science*; MA 2611 *Applied Statistics I*; MA 2612 *Applied Statistics II*; MG/IE 3400 *Production System Design*; MG 3600 *Marketing Management*;

MG 3700 *Information Systems Management*; SS 1110 *Introductory Microeconomics*; SS 1120 *Introductory Macroeconomics*. To obtain a bachelor's degree via the Combined Program, the student must satisfy all requirements for the bachelor's degree, including distribution and project requirements.

To obtain an MBA via the Combined Program, the student must satisfy all MBA degree requirements. In addition to the prerequisite undergraduate courses listed above, the student must complete the following graduate courses: MG 511 *Interpersonal and Leadership Skills for Technological Managers*; MG 512 *Creating and Implementing Strategy in Technological Organizations*; MG 513 *Creating Processes in Technological Organizations*; MG 514 *Business Analysis for Technological Managers*; MG 515 *Legal and Ethical Context of Technological Organizations*; MG 516 *Graduate Qualifying Project (GQP)*; 12 Elective Credits.

For more information on this program, contact N. Wilkinson, Washburn 218, (508) 831-5957.

PRE-MEDICAL, PRE-DENTAL AND PRE-VETERINARY PROGRAMS

ADVISOR: J. RULFS

Planning a program in one of the pre-health professions at WPI should be done in consultation with the WPI faculty pre-health professions advisor, Prof. J. Rulfs, Salisbury Labs 233. Entry into medical or other health professional schools may be accomplished through any major program of study at WPI. However, evidence that the student is interested in medicine and biology must be presented to the professional schools during the application process. For this reason, students, regardless of major, should plan their academic programs to include courses in biology, general and organic chemistry, and physics including laboratory experiences.

Students interested in becoming veterinarians should consider applying for admission to the joint B.S./D.V.M. program offered by WPI and Tufts University School of Veterinary Medicine. Students entering this program are guaranteed admission to veterinary school as early as the high school senior year and in addition can complete the entire program in seven years, rather than the traditional eight.

The formalized WPI projects program offers a tremendous advantage to pre-health professional students. Medical, dental, and veterinary schools view independent study and participation in research with great favor. At WPI, all students, rather than a select few, participate in such activities. The IQP and MQP are excellent examples. Most IQPs and MQPs done by WPI pre-health professions students are health-related, and many are done at off-campus medical settings such as the University of Massachusetts Medical Center or, the Tufts School of Veterinary Medicine.

A typical pre-medical or pre-dental program should include:

Introductory chemistry	3 courses
Organic chemistry	3 courses
Biology	3 courses
Physics	3 courses
Mathematics	3 courses
English Composition	2 courses*

Science courses should include laboratory segments.

*Check with the pre-health advisor for use of Humanities and Arts courses in lieu of composition requirement.

Students should consult medical or other professional school catalogs for specific admissions requirements. Students majoring in certain programs may have to utilize all of their electives to fulfill pre-health course requirements and/or may have to take some courses during summer sessions.

Grades in undergraduate courses, especially science courses, are important to medical, dental, and veterinary schools. Applicants usually have to submit a "cumulative quality point average" calculation. Such a calculation is performed by the Registrar upon written request by the student.

Students aspiring to enter one of the health professions should also plan alternative careers. Nationally only about one out of three qualified applicants is accepted into medical school, and veterinary schools are even more selective. Many WPI pre-health students have been successful in their applications to professional schools. However, it is important to realize that all WPI graduates have a degree in a major program of study and are thus well qualified to pursue a career in that alternative area.

SOCIAL SCIENCE AND POLICY STUDIES

K. SAEED, HEAD

PROFESSORS: J. T. O'Connor, K. Saeed
 ASSOCIATE PROFESSORS: J. K. Doyle, M. J. Radzicki, K. J. Rissmiller, J. M. Wilkes
 ASSISTANT PROFESSOR: O. Pavlov, E. A. Weaver
 PROFESSOR OF PRACTICE: J. Lyneis
 ADJUNCT FACULTY: W. Baller, G. Heaton, B. Karanian
 AFFILIATED FACULTY: D. Meadows

MISSION STATEMENT

SSPS programs are concerned with the substance and the process of socioeconomic problem solving especially as related to technological development, environment and public policy. Most socioeconomic problems - e.g., inflation, unemployment, urban deterioration, environmental pollution, income inequality, or infrastructure creation and maintenance - go beyond the boundaries of the traditional social science disciplines. Hence, the courses offered by the Department of Social Science and Policy Studies attempt to integrate knowledge and research techniques from multiple disciplines. Our curriculum

covers system dynamics, economics, sociology, psychology, law and political science. System dynamics exclusively focuses on a computer modeling and experimental analysis approach to problem solving and policy analysis while other areas employ a variety of modeling and analysis methods including system dynamics. The department also encourages students to view social and economic problems, and the relationship of technology to society, from a variety of perspectives and to become acquainted with different methods of gathering and analyzing social data.

SSPS department offers undergraduate majors in several policy related disciplines. In addition, the department administers WPI's two-course requirement in Social Sciences.

EDUCATIONAL OUTCOMES

Graduates of a social science major must have demonstrated through coursework and projects:

1. An ability to recognize patterns in real world data, qualitative and quantitative, in order to be able to define problems.
2. An ability to formulate hypotheses and models representing problems and understand their logic.
3. An ability to experiment with such models to establish their validity.
4. An ability to carry out exploratory analysis to arrive at remedial instruments addressing the defined problems.
5. Literacy in the technical aspects of a problem in the student's area of concentration.
6. An ability to effectively communicate the results of an analysis.
7. An ability to work with groups.
8. Computer literacy.

The teaching of social sciences differs from engineering in that it must deal with a large variety of empirical manifestations in the face of unreliable and often local theoretical premises. Thus, while a bulk of engineering practice involves applying well known physical principles to the design of physical systems, much time must be spent in social science analysis in recognizing problems, understanding their underlying relationships and developing premises to deal with the stylized facts. Once a problem is recognized, a vehicle of analysis must be developed to understand it and develop a remedial process. The validation of social analysis draws on the well-known principles of the scientific method, although the mechanics of its implementation vary depending on the vehicle of analysis used.

SSPS course offerings attempt to address the above agenda by focusing on description and analysis rather than only on prescription. Methodology and its valid practice are covered extensively in the system dynamics courses, while in other offered courses, research methods are integrated with the discipline-related content. Many courses emphasize group work in one form or the other. Item 5 above is addressed through coursework in other departments offering relevant curricula. Interactive Qualifying Project (IQP) and Major Qualifying Project (MQP) offer opportunities for learning the problem solving process in a real world context.

MAJOR PROGRAMS

The department offers majors in system dynamics, economics, economics and technology, environmental policy and development, and society-technology and policy. Please see the respective program coordinator for advice on the major you are interested in.

SYSTEM DYNAMICS

Coordinator: Prof. James M. Lyneis

The system dynamics major is aimed at developing the craftsmanship and the multi-disciplinary skills needed for computer modeling and experimental analysis of complex socioeconomic and technical problems encountered in private and public organizations. It prepares students for careers in public and private sector organizations maintaining in-house planning and problem solving groups, as well as for careers in public and private sector consulting firms. The fundamental focus of the program is on system dynamics as a problem-solving methodology and on training students to apply system dynamics to a wide range of problems experienced in engineering, economic and societal systems. The application areas of the program are designed to create opportunities for students to apply computer modeling and experimental analysis to specific problems, so that they can develop both expertise in those areas and the methodological skills necessary for applying the technique to other application areas. The major responds to the need for integrating specialized skills to address multidisciplinary problems created by the interaction of society and technology.

ECONOMICS

Coordinators: Prof. Michael J. Radzicki and Prof. Oleg V. Pavlov

Students majoring in economics prepare for careers in public administration, labor-management relations, or the economic, finance, international, sales, and general management areas of industry. This major also provides an excellent foundation for graduate study not only in economics, but in business and law as well. Students majoring in economics would ordinarily begin their studies in the basic theory areas: analysis of macroeconomic problems and public policy, analysis of problems of the firm and market organizations. In addition, to develop a capability in the area of economic modeling, students should study econometrics and system dynamics. Econometrics deals with the techniques used by economists to test hypotheses and to estimate functional relationships quantitatively. System dynamics allows development and testing of theoretical relationships and developing policy scenarios.

In addition to gaining proficiency in general economic analyses by completing the course in basic theory, students will undertake studies and project work in more specialized fields of study. The choice of fields will, of course, reflect the needs and motivation of the individual. It is probable that the interest of many students will fall within one or more of the traditional specialized fields of study, or in one of the new areas of inquiry recently introduced. Several of the more important of these fields are economic growth and stability, industrial organization

and public policy, environmental economics and resource management, economic development, urban and regional planning, and international economic relations.

ECONOMICS AND TECHNOLOGY

Coordinator: Prof. Michael J. Radzicki

Economics has traditionally been viewed as an excellent preparation for careers in law, public service, and general management in business and government. According to the United States Bureau of Labor, employers specifically listed a major in economics as a good background for careers in a wide variety of administrative and sales areas. Students who are beginning careers directly out of college will find that the study of technology will provide an invaluable supplement to their training in economics in many occupations. Future graduates of the department's program in economics and technology will be desired by firms looking for managers possessing the technological knowledge of the engineer and the decision making perspectives and modeling skills of the economist. Examples of such firms include:

1) pharmaceutical companies needing managers to analyze drug markets and interact with chemists and chemical engineers, 2) investment banking houses and brokerage firms needing analysts and brokers with the technological literacy necessary to assess high technology firms and their market prospects, and 3) public utilities needing managers capable of forecasting electricity demands and conducting cost benefit analyses of alternative methods of acquiring generating capacity.

The Economics and Technology major is an ideal preparation for graduate education, particularly the MBA. Study of the functional areas of management and specific managerial skills consume so much of an MBA program that only minimal time remains for study in other important areas including economics. However, a thorough understanding of economics is critical for all types of businesses and government agencies. Moreover, the ability to understand a business firm's technical production processes and products is also important in many areas of Management. Clearly, both halves of the Economics and Technology program complement the preparation for the business world provided by graduate programs in business. The E&T major provides training in areas that are important for success in business but are largely and wholly neglected in graduate business programs. Students enrolled in the Economics and Technology program offered by the Department of Social Science and Policy Studies at WPI will study economic theory and model building at both the micro and macro levels as well as techniques for economic decision making and the collection and analysis of economic data. Macroeconomic theory explains the behavior of the economy in the aggregate, while microeconomic theory deals with the behavior of individual firms, consumers and markets. The economics portion of the program includes courses in economics and related subjects in management and the other social sciences. These cover basic economic theory and its applications in such areas as the environment, health care, industrial organization, fiscal and monetary policy, as well as quantitative methods.

The program's technical component comprises courses roughly evenly divided between basic science and math preparation and courses in an engineering or science major. The aim is to acquaint students with the work of professionals in the technical discipline, ensure that they are conversant with the field, and familiar with its terminology and basic principles. Course sequences providing this preparation have been identified for twelve engineering and science disciplines, including computer science and mathematics.

ENVIRONMENTAL POLICY AND DEVELOPMENT

Coordinators: Prof. Khalid Saeed and Prof. Kent Rissmiller

During the past decade, the daily news has become increasingly filled with stories of economic stagnation and environmental destruction. As a result, interest in the environment and its impact on households, firms, cities, regions, and nations has been rekindled among students, the public at large, and within private firms and the government.

At the university level, environmental issues can be studied in a number of ways. They can, for example, be studied from a technological perspective via the natural and engineering sciences, or from a policy perspective via the management and social sciences. Indeed, environmental programs at many universities examine environmental issues in precisely these ways. It is unusual, however, for an environmental program to offer a strong education from both the technical and policy perspectives. The Department of Social Science & Policy Studies at WPI fills this gap by offering a baccalaureate degree in the area of Environmental Policy and Development (EP&D). This degree program offers students substantial technical and policy education on environmental issues. An important feature of WPI's EP&D major is its focus on the interaction between the environment and the economy. On June 14, 1992, during the so-called "Earth Summit" in Rio de Janeiro, the United Nations Conference on Environment and Development adopted Agenda 21, a document that calls upon the nations of the world to "take a balanced and integrated approach to environment and development questions." The EP&D major has adopted sustainable economic development as one of its organizing themes. That is, many traditional environmental issues are examined through the lens of sustainable development.

The term sustainable development means choosing policies that balance environmental preservation and economic development so as to meet the needs of the present generation without compromising the needs of future generations. The global ecological-economic system is essentially "closed." This means that, except for the receipt of solar energy from outer space and the dispersion of heat to outer space, the system is self-contained. The people living in the global system use both nonrenewable and renewable resources (which are limited) to produce goods and services that sustain and enhance life on the planet. Unfortunately, the process of creating goods and services also generates pollution that must be dispersed into the land, sea, and air. The amount of pollution that these "sinks" can absorb is also limited.

For the global system to sustain itself indefinitely, renewable resources must not be used faster than the rate at which they can be regenerated, nonrenewable resources (taking recycling into account, which is also a limited process) must not be faster than the rate at which they can be substituted for, and pollution must not be generated faster than the rate at which the system can absorb it. WPI's program in EP & D examines the economic, psychological, social, political, legal, and technical issues surrounding the creation of policies aimed at establishing sustainable economic systems at the local, national, and international levels.

SOCIETY, TECHNOLOGY AND POLICY

Coordinator: Prof. John M. Wilkes

The Society Technology and Policy major at WPI is designed for those who wish to prepare for a career in which they will deal with our society's critical problems. Great challenges face our society and many of the major ones stem from the interplay of technology and society. Environment, energy, productivity, population, education, defense, and global competition are all recognized as policy areas in which technological change is playing an important role. To address such problems, policy makers and analysts must be technically literate and familiar with the tools of analysis in the social ills both as a cause and, potentially, as a cure. This is precisely the background and knowledge that the Society, Technology and Policy program seeks to provide. In the STP program students major in social science and minor in a science or engineering discipline of their choice. Over a dozen technological alternatives are available including: biotechnology, computer science, manufacturing engineering, and management. Students take courses in at least two social science disciplines: economics, political science, psychology, and sociology. The social science coursework will emphasize policy issues and the study of the ways in which science and technology shape society and, conversely, the ways in which social forces affect the development of technology.

As a major in this program, a student will benefit from WPI's project oriented approach to learning. Students use project opportunities to engage in in-depth research on social policy issues and the interactions between society and technology. They may carry out their projects on the WPI campus, at any number of local agencies or corporations, or at one of WPI's off campus project programs in the United States and abroad. Through this interdisciplinary program the student will acquire the social science background needed to understand contemporary public policy, to interpret technical materials produced by physical scientists, engineers and social scientists and to be able to synthesize these materials for policy considerations on the part of government and industry. Graduates of this program will be valuable additions to the administrative or research staffs of a variety of businesses, regulatory agencies, government departments or contract research organizations.

Program Distribution Requirements for the System Dynamics, Economics, Economics and Technology, Society Technology and Policy, and Environmental Policy and Development Majors

The normal period of residency at WPI is 16 terms. In addition to the WPI requirements applicable to all students, completion of a minimum of 10 units of study is required in social science, basic science, and mathematics as follows:

SYSTEM DYNAMICS

Requirements	Minimum Units
1. System Dynamics (Note 1)	5/3
2. Other Social Science (Note 2)	5/3
3. Management (Note 3)	2/3
4. Mathematics/basic sciences/engineering (Note 4)	8/3
5. Computer Science (Note 5)	2/3
6. Application Area (Note 6)	5/3
7. MQP	1

NOTES:

- Only social science courses with a "5" in the second digit of the course number count toward the system dynamics requirement.
- Must include microeconomics or macroeconomics, cognitive or social psychology, and public policy.
- Must include organizational science.
- Must include differential and integral calculus, differential equations, and numerical or statistical analysis.
- CS1005 and CS2005 are recommended.
- This requirement is satisfied by a cohesive set of work from the fields of social science, management, science, mathematics, computer science, or engineering as specified in the curriculum the guidelines for system dynamics major.

ECONOMICS

Requirements	Minimum Units
1. Economics (Note 1).	3
2. Economics and/or Management (Note 2).	1
3. Other Social Science.	1
4. Mathematics (Note 3).	2
5. Basic Science.	1
6. Electives.	1
7. MQP.	1

NOTES:

- Must include courses in both micro and macro economic theory at the intermediate level and in international trade and econometrics (available through the Consortium or independent study).
- Must include financial accounting, MG 1100. May include other relevant management courses as approved by the Departmental Program Review Committee.
- Must include differential equations, integral calculus, and statistics.

ECONOMICS AND TECHNOLOGY

Requirements	Minimum Units
1. Economics (Note 1).	3
2. Management (Note 2).	2/3
3. Other Social Science.	1
4. Basic Science.	2/3
5. Mathematics (Note 3).	5/3
6. Technical Electives (Note 4).	2
7. MQP (Note 5).	1

NOTES:

- Must include econometrics, systems analysis, industrial organization and intermediate level microeconomic and macroeconomic theory.
 - Must include (1) two courses in environmental economics, the economics of the medical care industry or advanced systems analysis or (2) two courses in fiscal and monetary economics.
- Must include financial accounting and either financial management or engineering economics.
- Must include statistics, and differential and integral calculus.
- Courses must be in science or engineering with a concentration in one discipline.
- The MQP may be in Economics or in the student's technical field with the approval of the academic advisor and the departmental Program Review Committee.

SOCIETY, TECHNOLOGY AND POLICY

Requirements	Minimum Units
1. Social Science (Notes 1, 2).	4
2. Minimum Basic Science background.	2/3
3. Minimum Mathematics background (Note 3).	1
4. Technical concentration (Note 4).	5/3
5. Electives (Note 5).	5/3
6. MQP	1

NOTES:

- Students must obtain approval of their proposed program from the Departmental Program Review Committee. Course distribution will focus on a disciplinary specialty and either policy analysis or a society-technology specialization such as Social Impact Analysis or Technology Assessment.
- Relevant Humanities or Management courses approved by the Departmental Review Committee may be counted for a maximum of 2/3 of a unit in fulfilling the 4-unit requirement.
- One course in calculus-based statistics is required.
- A series of courses in one field of science, engineering, or management or a combination of courses approved by the departmental review committee which focus on issues to be developed in the MQP.
- These courses are to be approved by the Departmental Review Committee and are meant to broaden the technical concentration and tie it to social concerns.

ENVIRONMENTAL POLICY AND DEVELOPMENT

Requirements	Minimum Units (Note 1)
1. SS & PS (Note 2).	12/3
2. Mathematics (Note 3).	5/3
3. Basic Science (Note 4).	2/3
4. Technical Concentration (Note 5).	2
5. Department Electives (Note 6).	2/3
6. MQP.	1

NOTES:

- 1/3 unit = 1 course. 15 units are required for graduation.
- Students must complete 5/3 units (5 courses) in one of three social science areas: (a) economics, (b) psychology/sociology, (c) political science (includes SS & PS courses in law and policy analysis) and 2/3 unit (2 courses) in each of the other two social science areas. The particular courses chosen must include six out of the following nine courses: A Psychological Perspective on Environmental Problem Solving, American Public Policy, Development Economics, Environmental Economics, International Environmental Policy, Introduction to Economic Systems, Legal Regulation of the Environment, Technical Expertise in Governmental Decision Making, and the Society-Technology Debate. Students must also complete three other social science courses (1 unit) of their choosing.
- Must include both calculus and statistics.
- Basic science courses must be selected from the disciplines of Physics, Chemistry, or Biology.

5. The technical concentration must include at least six thematically related courses in science, engineering or management that have been approved by the Department's Program Review Committee.
6. Departmental electives must be selected from the areas of mathematics, basic science, social science, or the technical concentration.

THE SOCIAL SCIENCE REQUIREMENT

To satisfy WPI's two-course social science requirement, students may take courses in any of the traditional social sciences. They will normally begin by taking one of the introductory core courses listed below:

System Dynamics

- SS 1503 The Psychology of Decision Making and Problem Solving
 SS 1510 Introduction to System Dynamics Modeling

Economics

- SS 1110 Introductory Microeconomics
 SS 1120 Introductory Macroeconomics

Sociology

- SS 1202 Sociological Concepts and Analysis
 SS 1203 Social Problems and Policy Issues

Psychology

- SS 1401 Introduction to Cognitive Psychology
 SS 1402 Introduction to Social Psychology
 SS 1503 The Psychology of Decision Making and Problem Solving

Political Science

- SS 1301 U.S. Government
 SS 1303 American Public Policy
 SS 1310 Law, Courts, and Politics
 SS 1320 Topics in International Politics

THE SECOND COURSE IN SOCIAL SCIENCE

In choosing their second course in social science, students confront a choice between taking a second introductory course in another social science discipline, or a more advanced course in the same social science discipline as the first. The department recommends the latter choice. At least two courses in a given field are essential to achieving a firm understanding of the nature of the discipline: its organization, its basic vocabulary, the way in which it approaches the solution of the problems that are its central focus, and how it seeks to explicate the phenomena with which it is concerned. Moreover, the advanced courses available at WPI have substantial theoretical and empirical components, which provide the student with an opportunity to see how social science is applied to the solution of specific public and private policy problems. These courses are listed below.

System Dynamics

- SS 1520 System Dynamics Modeling
 SS 2530 Advanced Topics in System Dynamics Modeling
 SS 2540 Group Model Building

Economics

- SS 2110 Intermediate Microeconomics
 SS 2117 Environmental Economics
 SS 2120 Intermediate Macroeconomics
 SS 2125 Development Economics

Sociology

- SS 2207 Creativity and the Scientific Community
 SS 2208 The Society - Technology Debate

Political Science and Law

- SS 2302 Science-Technology Policy
 SS 2304 Governmental Decision Making and Administrative Law
 SS 2310 Constitutional Law
 SS 2311 Legal Regulation of the Environment
 SS 2312 International Environmental Policy
 SS 2313 Intellectual Property Law

Psychology

- SS 2401 The Psychology of Education
 SS 2405 The Psychological Study of Environmental Issues
 SS 2406 Cross-Cultural Psychology: Human Behavior in Global Perspective
 SS 2540 Group Model Building

These advanced or depth courses deal with a wide variety of subjects: system dynamics modeling and experimental analysis, government regulation of business, environmental law and economics, educational psychology, technology assessment and environmental policy and decision making, among others. This element of application in the depth courses adds greatly to students' interests in the course and their understanding of the capabilities and usefulness of the subject.

Students are advised to take both of their social science courses in the same discipline so that they may take a depth course that will provide an opportunity to study social science of specific and direct relevance to their Interactive Qualifying Projects (IQPs). Some students prefer, however, to combine courses across disciplines. In particular, a course in social science methodology like SS 1520 System Dynamics Modeling would be suitable to be taken with an introductory course in economics, psychology, sociology and political science and law. The department believes that it is critical for students to forge as close and direct a link as possible between their social science preparation and IQP. The IQP relates science and technology to society. It aims to make students sensitive to general social problems, aware of societal-humanistic-technological interactions, able to analyze these interactions and to make better judgments and policy recommendations. Given the objective of the IQP, it is not surprising that many involve analysis of social problems and the evaluation of policy options. Typically, knowledge of both technology and social science are required for effective handling of such IQPs. But in many cases, the critical skills lie in the area of social science. Technology provides the base-line level of information required to assess an impact or to evaluate options. However, the manner in which society responds to technical change is a function of our economic and political systems, of individual perceptions, attitudes and values, and the interactions of individuals and groups. All of these are the subject matter of social science. Their understanding is essential for projects that analyze societal-technological interactions and examine social policy issues, whether directly linked to technological developments or not.

The most important contribution which the study of social science can make to the education of engineering and science students is to create an awareness that knowledge of social science is vital in analyzing a wide range of problems and in making many types of decisions. It is important that, in the future, engineers and scientists not ap-

proach social impact problems guided solely by their background in technology, ignoring the previous contributions of the social sciences in these areas. The primary goal of the social science requirement is to leave engineering and science students with the recognition that social science knowledge is useful and accessible and that they are capable of mastering its tools, comprehending its approaches and applying these tools to practical problems.

If this goal is to be realized, it is highly advisable that students link their study in social science to their Interactive Qualifying Projects. The department recommends that students begin with an introductory course late in the freshman or early in the sophomore year, and follow that with an applied depth course in the sophomore or early in the junior year when the IQP topic has been identified.

COURSE SEQUENCES IN SOCIAL SCIENCE

To aid students in selecting appropriate sequences of introductory and applied courses to satisfy their social science requirement, the department has identified logical course sequences in the areas listed below.

SYSTEM DYNAMICS

Introduction to System Dynamics Modeling (SS 1510) followed by SS 1520 System Dynamics Modeling provides students with a sequence of two courses in system dynamics. The first course introduces the students to the systems thinking perspective and the techniques of modeling and experimental analysis using computer simulation. The second course deals with problem solving using system dynamics modeling. These two courses provide the basic skills for applying the system dynamics method to IQP or MQP projects. System Dynamics is an expanding process in K-12 education. This course sequence would also greatly help aspiring high school teachers to apply system dynamics in facilitating learning in their respective subject areas. For a more technical treatment of the subject, the two-course sequence may include System Dynamics Modeling (SS 1520) followed by Advanced Topics in System Dynamics Modeling (SS 2530).

ECONOMICS

Several combinations of course offerings in economics can be selected depending on the student's interest. Introductory Microeconomics (SS 1110) followed by Intermediate Microeconomics (SS 2110) would cover microeconomic theory as applied to a firm. Introductory Microeconomics (SS 1110) followed by Environmental Economics (SS 2117) would create a theoretical basis for dealing with environmental regulation and policy. Introductory Macroeconomics (SS 1120) followed by Development Economics (SS 2125) would make a succinct introduction to developmental agendas. Introductory Micro- or Macroeconomics (SS 1110 or SS 1120) followed by System Dynamics Modeling (SS 1520) would create a good window to understanding economic dynamics and disequilibrium growth.

The tools of decision-making developed in these courses find application in a wide range of IQPs. Cost analysis, investment decisions, and the forecasting of trends in consumption, production and prices are required in many IQPs dealing with energy, risk analysis, and economic growth and development.

PSYCHOLOGY

A two-course sequence in Cognitive or Social Psychology is ideal preparation for IQPs that require an understanding of how individuals or groups think when faced with social and technological problems. SS1401 (Introduction to Cognitive Psychology) and SS 1402 (Introduction to Social Psychology) are alternate introductions to experimental psychology. SS 1401 emphasizes the mental processes that individuals apply to perception, memory, learning, judgment, and problem solving tasks and their implications for education and engineering design.

SS 1402 is concerned with how people think about, feel for, and act toward other people, and covers such topics as social influence, altruistic behavior, aggression, gender differences, stereotyping and prejudice, and small group decision making. The Psychology of Decision Making and Problem Solving (SS 1503) provides students an opportunity to improve many of the cognitive skills relevant to IQPs and MQPs, including memory, problem solving, reasoning, decision making, and intelligent criticism.

Either SS 1401 or SS 1402 followed by SS 2401 (The Psychology of Education), provides a solid background for students who plan to conduct IQPs in educational settings, from pre-school through college. SS 2401 covers such topics as student diversity, the learning process, motivation to learn, and techniques for evaluating student learning. Current issues in higher education (particularly technological education) are emphasized.

The two-course sequence SS 1402 and SS 2406 (Cross-Cultural Psychology: Human Behavior in Global Perspective) is especially designed for IQP students preparing to work at international project centers, International Scholars, and students interested in the global aspects of science and technology. SS 2406 introduces students to the wide variety of social and cultural influences that shape human behavior in different parts of the world, with particular attention paid to cultural influences on technology development and transfer.

Students interested in new approaches to environmental problems should consider taking SS 1401 followed by SS 2405 (The Psychological Study of Environmental Issues). Those interested in knowledge solicitation should consider SS 2540 (Group Model Building) as a second course. SS 2405 traces the root causes of environmental problems to basic human thought processes and explores the argument that successful environmental policies must be based on an understanding of how individuals think about the environment, how pro-environmental behavior is related to environmental attitudes, and how people respond to environmental information and policies. The course emphasizes the application of psychological knowledge to the development of innovative solutions to problems such as global warming, ozone depletion, species extinction, and energy and resource conservation. SS 2540 deals with mapping and soliciting experiential information and mental models. It covers team learning, group communication and decision-making processes, and factors that promote or impede group performance.

SOCIOLOGY (SCIENCE, TECHNOLOGY, AND POLICY - STP)

Many IQP projects center on issues of social impact, technology assessment, or addressing a social problem. Some address issues specifically in the society-technology debate regarding the cultural and social trends associated with the emergence of a "technological" or "post-industrial" society. The following courses have been developed as background material for such projects. Many are also core courses in the curriculum designed for Society-Technology Majors.

The typical entry level course for those interested in SS 2208 (The Technology-Society Debate), SS 2207 (Science and Creativity), or SS 1203 (Social Problems and Policy Issues) is SS 1202 (Introduction to Sociological Concepts). However, there are two other courses that are acceptable alternatives in preparing for SS 1203 (Social Problems and Policy Issues). These are SS 1402 (Introduction to Social Psychology) and SS 1301 (U.S. Government). SS 1402 (Introduction to Social Psychology) is also a good alternative preparation for SS 2207 (Science and Creativity).

The two-course sequence, SS 1202 (Sociological Concepts) and SS 3278 (Technology Assessment and Impact Analysis Seminar), is also a fine approach to take if someone is interested specifically in Social Impact Analysis. Those interested in extending SS 1202 (Sociological Concepts) and SS 2208 (Society-Technology Debate) with more work on a related theme should consider taking SS 3278 (Impact and Assessment Seminar) or SS 2302 (Science - Technology Policy).

POLITICAL SCIENCE/PUBLIC POLICY

Three courses introduce students to the analysis of public policy: SS 1301, U.S. Government; SS 1303, American Public Policy; and either SS 2302, Science-Technology Policy, or SS 2304, Governmental Decision Making and Administrative Law. This sequence is designed for students who want to obtain an understanding of American government, its institutions, and the factors affecting public policy. The courses would be especially useful for students whose IQPs will address a public policy issue or some problem that requires a response from government. In addition, the courses will impart an appreciation for our political heritage and the values, which shaped our constitutional structure.

The political environment for science and technology has become extremely complex during the last few decades. Government directly supports over half of the nation's research and development. It also regulates the use of many technologies, including nuclear power, biotechnology, and manufacturing processes, which potentially harm the environment. Moreover, scientists and engineers are frequently called upon to help government solve problems. They often find themselves uncomfortably in the midst of political controversies.

These courses would shed some light on the mysterious processes of government. By enabling students to critically assess the performance of government and to articulate their own policy preferences, the courses would eliminate one barrier preventing WPI students from contributing to the public process.

CURRICULUM GUIDELINES FOR SYSTEM DYNAMICS

Recommendations for complying with the program distribution requirements (10 units) are described below. To earn a Bachelor of Science (B.S.) degree in System Dynamics, students must complete 15 units of coursework. In addition to the requirements below, one must complete the Sufficiency (2 units), the Interactive Qualifying Project (1 unit), free electives (5/3), and physical education (1/3).

Specific course recommendations for complying with the program distribution requirements are given below. These recommendations are intended to offer flexibility while preparing students for careers in system dynamics.

System Dynamics (5/3)

Students can choose from among the following 6 courses in system dynamics:

SS 1510	Introduction to System Dynamics Modeling
SS 1520	System Dynamics Modeling
SS 1503	The Psychology of Decision Making and Problem Solving
SS 2530	Advanced Topics in System Dynamics Modeling
SS 2540	Group Model Building
SS 3550	System Dynamics Seminar

Other Social Science (5/3)

It is recommended that the requirement for microeconomics or macroeconomics be satisfied with either SS 1110 or SS 1120, although higher level economics courses are also possible. It is recommended that the requirement for cognitive or social psychology be satisfied with SS 1401 or SS 1402, although higher level psychology courses are also possible. The public policy requirement can be met by taking one of the following courses: SS 1301, SS 1303, SS 2302, SS 2304, SS 2312. The other two social science courses are free electives and students can take any additional four courses in economics, sociology, political science and law, psychology, and system dynamics.

Management (2/3)

The requirement for organizational science may be met by taking one of MG/IE 2300 or MG/IE 3351. The second management course is a free elective.

Mathematics and Basic/Engineering Science (8/3)

The requirement for differential and integral calculus may be met by completing the calculus sequence through MA 1024. Higher level math courses or other basic science or engineering courses may be substituted if students complete MA 1024 without taking the full sequence MA 1021-MA 1024. It is recommended that the requirement for differential equations be met by MA 2051 and the requirement for numerical analysis be met by MA 3457/CS 4033, and the requirement for statistical analysis by MA 2611 or SS 2130. Once the math requirements are met, students may take any combination of additional math, basic science, or engineering courses to complete the 8/3 unit requirement. Those pursuing computer science as an application area should take CS 2022 to be able to follow upper level courses in the application area. It is recommended, but not required, that students take PH 1110 and PH 1120 as preparation for ES 3011.

Computer Science (2/3)

CS 1005 and CS 2005 are recommended.

Application Area (5/3)

A minimum of 5/3 units of integrated coursework is required to satisfy this requirement. Often students focus their applied courses in a particular area such as those noted below. Other focus areas are possible but must be approved by the student's academic advisor and the Department's Undergraduate Committee early in the student's program. Suggested courses for 12 application areas are given below. There is some flexibility needed in the selection of these courses since system dynamics covers a wide range of policy agenda. The student must take 3 additional courses to get a minor in an application area. Requirements of the respective departments are to be met in the course selection for the minors.

Economics*Select 3*

SS 1110	Introductory Microeconomics
SS 1120	Introductory Macroeconomics
SS 2110	Intermediate Microeconomics
SS 2120	Intermediate Macroeconomics

Select 2

SS 2117	Environmental Economics
SS 2125	Development Economics
MG/IE 2850	Engineering Economics

Project Dynamics*Required*

CE 1030	Civil Engineering and Computer Fundamentals
---------	---

Select 3

MG 2101	Management Accounting
CE 3020	Project Management
CE 3021	Cost Estimating, Scheduling and Control
CE 3022	Legal Aspects in Design and Construction
MG 2200	Financial Management
SS/CE 4000	Independent Studies in Project Management

Engineering Systems*Required*

ME 1800	Materials Selection and Manufacturing Process
---------	---

Select 4

ME 3311	Dynamics of Mechanisms and Machines
ME 3321	Dynamic Modeling
ME 3422	Environmental Issues and Analysis
ME 3820	Computer-Aided Manufacturing
MG/IE 3400	Production System Design
MG/IE 3440	Information Systems Management
MG 3700	Information Systems Management

Public Policy*Select 2*

SS 1301	US Government
SS 1303	American Public Policy
SS 1310	Law Courts and Politics
SS 1320	Topics in International Politics

Select 3

SS 2117	Environmental Economics
SS 2125	Development Economics
SS 2302	Science-Technology Policy
SS 2304	Government Decision Making and Administrative Law
SS 2311	Legal Regulation of Environment
SS 2312	International Environmental Policy

Fire Protection Engineering*Required*

FP 3070	Fundamentals of Fire Safety Analysis
---------	--------------------------------------

Select 4

MG/IE 3501	Management Science II: Risk Analysis
Any other course and Independent Studies in Fire Protection Engineering	

Environmental Policy*Select 2*

BB 2040	Principles of Ecology
CE 3059	Environmental Engineering
CE 3070	Urban and Environmental Planning
CE 3074	Environmental Analysis
CM 3910	Chemical and Environmental Technology
CM 3920	Air Quality Management
ME 3422	Environmental Issues and Analysis

Select 3

PY 2717	Philosophy and Environment
SS 2117	Environmental Economics
SS 2125	Development Economics
SS 2311	Legal Regulation of Environment
SS 2312	International Environmental Policy
SS 2405	The Psychological Study of Environmental Issues

Computer Science*Select 4 or more*

CS 2223	Algorithms
CS 3041	Human Computer Interaction
CS 3431	Database Systems I
CS 3733	Software Engineering
CS 4241	Webware: Network Information Systems
CS 4341	Intro to Artificial Intelligence
Any other course and Independent Studies in Computer Science	

Select 1 or more

MA 2210	Mathematical Methods in Decision Making
MA 3457	Numerical Methods for Calculus and Differential Equations
MA 4411	Numerical Solutions to Differential Equations

Infrastructure Planning*Select 2*

SS 1120	Introductory Macroeconomics
SS 2120	Intermediate Macroeconomics
SS 2125	Development Economics
CE 1030	Civil Engineering and Computer Fundamentals

Select 3

CE 3020	Project Management
CE 3021	Cost Estimating, Scheduling and Project Control
CE 3022	Legal Aspects in Design and Construction
CE 3070	Urban and Environmental Planning
CE 4024	Real Estate Development

Society-Technology Studies*Select 5*

SS 1202	Sociological Concepts and Comparative Analysis
SS 1402	Introduction to Social Psychology
SS 2208	The Society - Technology Debate
SS 2302	Science-Technology Policy
SS 3278	Technology Assessment and Impact Analysis Seminar
CS 3043	Social Implications of Information Processing
HI 2333	History of Science from 1700
HI 3331	Topics in Science, Technology and Society

Transportation Planning*Select 3*

CE 3050	Highway Engineering and Planning
CE 3051	Transportation Systems
CE 3070	Urban and Environmental Planning
CE 3074	Environmental Analysis
CE 4071	Land Use Development and Controls
CE 3020	Project Management

Select 2

SS 1110	Introductory Microeconomics
SS 1120	Introductory Macroeconomics
SS 2110	Intermediate Microeconomics
SS 2117	Environmental Economics
SS 2120	Intermediate Macroeconomics
SS 2125	Development Economics

Electrical Power Systems Planning

Select 2

- SS 1110 Introductory Microeconomics
- SS 1120 Introductory Macroeconomics
- SS 2110 Intermediate Microeconomics
- SS 2120 Intermediate Macroeconomics

Select 3

- EE 3601 Principles of Electrical Engineering
- EE 4502 Analysis of Large Scale Electric Power Systems
- CE 3070 Urban and Environmental Planning
- Independent Studies on Electrical Power Systems Planning

Model Analysis

Select 5

- ES 3011 Control Engineering I
- MA 2210 Mathematical Methods in Decision Making
- MA 3457 Numerical Methods for Calculus and Differential Equations
- MA 4411 Numerical Analysis of Differential Equations
- Independent studies in model analysis

Major Qualifying Project (3/3)

The MQP is expected to provide an integrative capstone experience in system dynamics. Students must complete an MQP that applies system dynamics modeling or methodology to the student's chosen application area.

DOUBLE MAJOR IN SOCIAL SCIENCE AND POLICY STUDIES

Any of the department majors programs outlined above may be taken as part of a double major in which the student majors in an area of science, engineering or management as well as social science. To obtain a double major, the student must satisfy all of the degree requirements of the technical discipline including an MQP and Distribution requirements. In addition, the double major in Social Science and Policy Studies requires four units of study in social science (inclusive of the normal two-course social science requirement) and the completion of a second qualifying project which combines the IQP and social science MQP into a single one-unit project. Unlike other double majors, the double major in Social Science and Policy Studies does not require three qualifying projects: two MQP's and an IQP. However, the combined social science MQP and IQP must meet the goals of both. It must be interactive in nature involving an aspect of technology as well as in application of social science knowledge and analytical techniques. The decision to pursue the social science double major should be made fairly early in the student's academic career, certainly early enough to insure the selection of an appropriate IQP/MQP.

SOCIAL SCIENCE AND POLICY STUDIES—COURSE SEQUENCE CHART

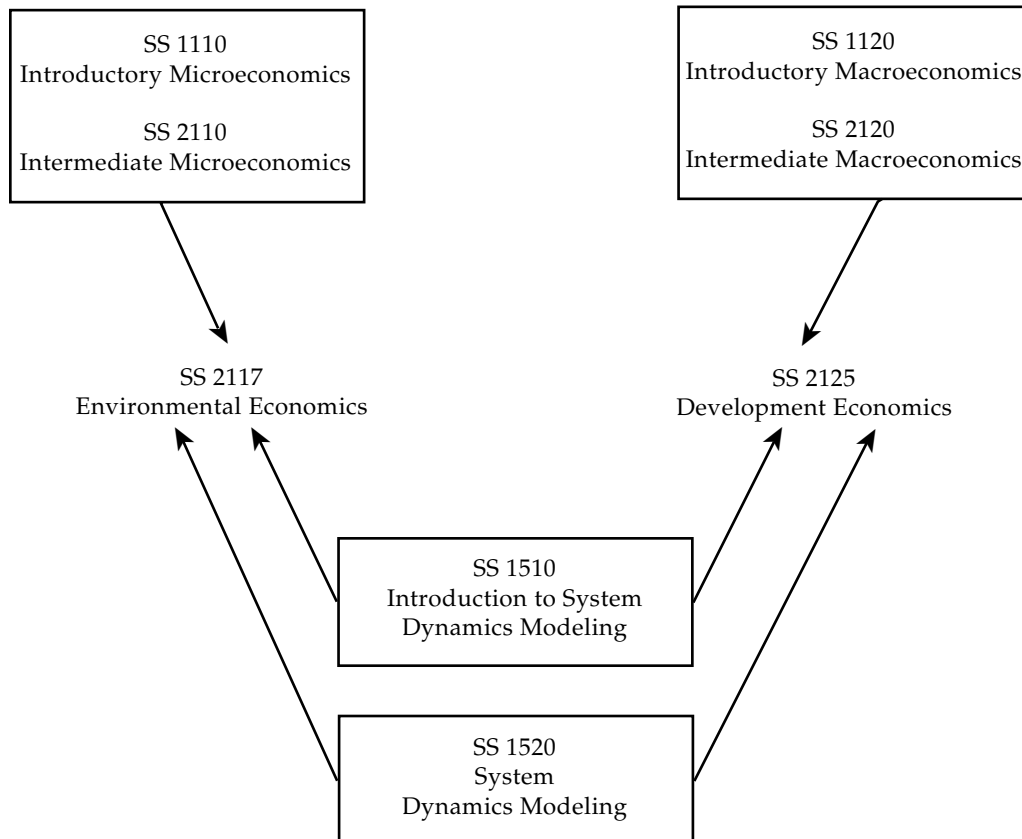

SOCIAL SCIENCE MINORS

A Social Science Minor is available in any of the following disciplines:

Economics
Sociology
Political Science and Law
Psychology
System Dynamics
Social Science

A minor in the Social Sciences consists of 2 units of academic activity satisfying the following conditions:

1. Foundations

Introductory level courses in any one or two social science disciplines taught at WPI: economics, sociology, political science (and law), psychology, and system dynamics. Introductory courses are identified by the first digit of the course number, which must be a 1. The second digit of the course number indicates the discipline (1–economics, 2–sociology, 3–political science and law, 4–psychology, and 5–system dynamics).

2. Applied Courses (At least 1 unit)

Three or more higher level courses in the same social science disciplines as the foundation courses, which involve applications or extensions of the material covered in the introductory courses and list the introductory courses as recommended background. High level courses have either a 2, 3, or 4 as the first digit of the course number.

The capstone experience will consist of a paper in the last applied course taken. The paper must draw upon and integrate material covered in the previous courses. An IQP may provide the capstone experience and substitute for the last applied course provided that the IQP was advised or co-advised by a member of the Social Science & Policy Studies department, and contains appropriate social science analysis.

3. If five or more of the six 1/3 units required for the minor are in a single social science discipline, the title of the minor will be "Minor" in that discipline.* Otherwise the title of the minor will be "Minor in Social Science." Examples of minor programs in economics, sociology, political science (and law), psychology, system dynamics and

interdisciplinary social science are available at the SS & PS department office. The course selected for an interdisciplinary social science minor should follow an identifiable theme, such as the relationship between technology and society or social, political, economic or environmental policies.

Students taking minors in the social sciences are expected to designate a member of the SS & PS department as their SS minor advisor, who will assist them in preparing a program that meets the requirements of the minor. Students can obtain assistance at the SS & PS departmental office in designating an advisor.

Students completing any major in the Social Science and Policy Studies Department may not also complete a minor in social sciences.

* In designating sociology the minor, the course SS 1402, Social Psychology, can be counted as one of the five courses required in Sociology. In designating the economics minor, at least 3 of the 5 required courses must be chosen from among the following four theory courses: SS 1110–Introductory Microeconomics; SS 1120–Introductory Macroeconomics; SS 2210–Intermediate Microeconomics; and SS 2120–Intermediate Macroeconomics.

COURSE DESCRIPTIONS

SECTION

three

Aerospace Studies	170
Biology and Biotechnology	171
Biomedical Engineering	175
Chemical Engineering	177
Chemistry and Biochemistry	179
Civil and Environmental Engineering	182
Computer Science	184
Electrical and Computer Engineering	187
Engineering Science Interdisciplinary	189
Fire Protection Engineering	190
Geosciences	192
Humanities and Arts	192
Interdisciplinary	201
Management	202
Mathematical Sciences	205
Mechanical Engineering	208
Military Science	212
Physical Education	213
Physics	214
Social Science and Policy Studies	216

COURSE CATEGORIES

For purposes of planning programs of study, courses at WPI are divided into two categories.

Category I (Cat. I)

These courses cover core material of interest to large numbers of students. Category I courses are offered at least once a year.

Category II (Cat. II)

Category II courses are usually offered every other year.

BACKGROUND*Recommended*

The course will build on material in the recommended course. Instructors can assume that the student is knowledgeable of the material from the recommended course or from other experiences.

Suggested

The material from this course would be helpful to the student, but it is not assumed background.

CATALOG AND SCHEDULE ON THE WWW

The catalog and course schedule can be found on the world wide web at www.wpi.edu/+ugradcat and www.wpi.edu/+schedules.

COURSE NUMBERING

Each course at WPI is designated by a two-letter prefix identifying the subject area followed by a four digit number. The first digit is coded as follows:

- 1 — Courses for which first-year students will receive priority in registration. Upper class students may register on a space-available basis.
- 2 — Basic level courses.
- 3 — Advanced level undergraduate courses for which no graduate credit is given. (This restriction may be waived at the discretion of the degree department.)
- 4 — Advanced level undergraduate courses for which graduate credit may also be given.
- 5 — Graduate courses.

The last three digits may be used by the departments to indicate subject areas. Many graduate courses are also available to undergraduates.

COURSE CREDIT

Unless otherwise indicated, WPI courses usually carry credit of 1/3 unit. This level of activity suggests at least 17 hours of work per week, including class and laboratory time. The usual workload per term is 1 unit.

AEROSPACE STUDIES**AS 1001. THE FOUNDATIONS OF THE UNITED STATES AIR FORCE I.**

Cat. I (1/9 unit)

The AS 1000 sequence of courses are designed to introduce students to the United State Air Force and Air Force Reserve Officer Training Corps. Featured topics include mission and organization of the Air Force, officership and professionalism, Air Force officer opportunities, military customs and courtesies, and an introduction to communication skills.

The first course focuses on the foundation of officership and customs and courtesies.

The course includes one hour of class work and two hours of mandatory leadership laboratory per week. The AS 1001 Leadership Laboratory includes a study of Air Force customs and courtesies, drill and ceremonies, and military commands.

AS 1002. THE FOUNDATIONS OF THE UNITED STATES AIR FORCE II.

Cat. I (1/9 unit)

The AS 1000 sequence of courses are designed to introduce students to the United State Air Force and Air Force Reserve Officer Training Corps.

A continuation of AS 1001, the second course in this series emphasizes those communication skills needed in today's Air Force. It describes the communication systems, discusses common barriers and enhancements to effective communications. The course includes numerous speaking and written exercises using current Air Force topics.

The course includes one hour of class work and two hours of mandatory leadership laboratory per week. The AS 1002 Leadership Laboratory includes a study of Air Force customs and courtesies, drill and ceremonies, and military commands.

AS 1003. THE FOUNDATIONS OF THE UNITED STATES AIR FORCE III.

Cat. I (1/9 unit)

The AS 1000 sequence of courses are designed to introduce students to the United State Air Force and Air Force Reserve Officer Training Corps.

A continuation of AS 1002, the course outlines the origin of the Air Force and the organizational structure of the Air Force with a focus on the missions of select military organizations. The basic history of the United States military is studied in order to appreciate how military history impacts the Air Force today. Written and oral communication skills are practiced.

The course includes one hour of class work and two hours of mandatory leadership laboratory per week. The AS 1003 Leadership Laboratory includes a study of Air Force customs and courtesies, drill and ceremonies, and military commands.

AS 1004. THE FOUNDATIONS OF THE UNITED STATES AIR FORCE IV.

Cat. I (1/9 unit)

The AS 1000 sequence of courses are designed to introduce students to the United State Air Force and Air Force Reserve Officer Training Corps.

The final course in the AS 1000 sequence, it introduces students to the Air Force installation and her sister services. Written and oral communication skills are practiced.

The course includes one hour of class work and two hours of mandatory leadership laboratory per week. The AS 1004 Leadership Laboratory includes a study of Air Force customs and courtesies, drill and ceremonies, and military commands.

AS 2001. THE EVOLUTION OF USAF AIR AND SPACE POWER I.

Cat. I (1/9 unit)

The AS 2000 sequence of courses are designed to examine general aspects of air and space power through a historical perspective. Utilizing this perspective, the course covers a time period from the first balloons and dirigibles to the space-age global positioning systems of the Persian Gulf War. Historical examples are provided to extrapolate the development of Air Force capabilities (competencies), and missions (functions) to demonstrate the evolution of what has become today's USAF air and space power. As a whole, the AS 2000 sequence of courses provides the student with a knowledge level understanding for the general element and employment of air and space power.

The first course covers the factors leading to the early development of air power through the use of air power during World War II. The development of oral and written communication skills is continued from the AS 1000 classes.

The course includes one hour of class work and two hours of mandatory leadership laboratory per week. The AS 2001 Leadership Laboratory continues a study of Air Force customs and courtesies, drill and ceremonies, military commands, and preparation for Field Training.

AS 2002. THE EVOLUTION OF USAF AIR AND SPACE POWER II.

Cat. I (1/9 unit)

The AS 2000 sequence of courses are designed to examine general aspects of air and space power through a historical perspective. The second course in the series continues with the development of air power from World War II through the development of the Intercontinental Ballistic Missile.

The course includes one hour of class work and two hours of mandatory leadership laboratory per week. The AS 2002 Leadership Laboratory continues a study of Air Force customs and courtesies, drill and ceremonies, military commands, and preparation for field training.

AS 2003. THE EVOLUTION OF USAF AIR AND SPACE POWER III.*Cat. I (1/9 unit)*

The AS 2000 sequence of courses are designed to examine general aspects of air and space power through a historical perspective. The third course in the series begins with a study of air power in the Vietnam war through the Gulf war. Oral and written communications skills will be practiced.

The course includes one hour of class work and two hours of mandatory leadership laboratory per week. The AS 2003 Leadership Laboratory continues a study of Air Force customs and courtesies, drill and ceremonies, military commands, and preparation for field training.

AS 2004. THE EVOLUTION OF USAF AIR AND SPACE POWER IV.*Cat. I (1/9 unit)*

The AS 2000 sequence of courses are designed to examine general aspects of air and space power through a historical perspective. The course examines several fundamental truths associated with war in the third dimension: e.g. Principles of War and Tenets of Air and Space Power. As a whole, this course provides the students with a knowledge level understanding for the general element and employment of air and space power, from an institutional doctrinal and historical perspective. In addition, the students will continue to discuss the importance of the Air Force Core Values with the use of operational examples and historical Air Force leaders and will continue to develop their communication skills. The final course in the series explores the future of the Air Force through 2025.

The course includes one hour of class work and two hours of mandatory leadership laboratory per week. The AS 2004 Leadership Laboratory continues a study of Air Force customs and courtesies, drill and ceremonies, military commands, and preparation for field training.

AS 3001. AIR FORCE LEADERSHIP STUDIES I.*Cat. I (1/6 unit)*

The AS 3000 sequence of courses is a study of leadership, management fundamentals, professional knowledge, Air Force personnel and evaluation systems, leadership ethics, and communication skills required of an Air Force junior officer. Throughout the courses, case studies are used to examine Air Force leadership and management situations as a means of demonstrating and exercising practical application of concepts being studied.

The first course explores different styles of leadership, followership, and management functions.

The course includes three hours of class work and three hours of mandatory leadership laboratory per week. The AS 3001 Leadership Laboratory complements the classroom work by providing advanced leadership experiences in officer-type activities and giving students the opportunity to apply leadership and management principles.

AS 3002. AIR FORCE LEADERSHIP STUDIES II.*Cat. I (1/6 unit)*

The AS 3000 sequence of courses is a study of leadership, management fundamentals, professional knowledge, Air Force personnel and evaluation systems, leadership ethics, and communication skills required of an Air Force junior officer. The second course studies various aspects of leadership, conflict management, counseling, and supervision.

The course includes three hours of class work and three hours of mandatory leadership laboratory per week. The AS 3002 Leadership Laboratory complements the classroom work by providing advanced leadership experiences in officer-type activities and giving students the opportunity to apply leadership and management principles.

AS 3003. AIR FORCE LEADERSHIP STUDIES III.*Cat. I (1/6 unit)*

The AS 3000 sequence of courses is a study of leadership, management fundamentals, professional knowledge, Air Force personnel and evaluation systems, leadership ethics, and communication skills required of an Air Force junior officer. The third course emphasizes teambuilding, improvement process, and military ethics.

The course includes three hours of class work and three hours of mandatory leadership laboratory per week. The AS 3003 Leadership Laboratory complements the classroom work by providing advanced leadership experiences in officer-type activities and giving students the opportunity to apply leadership and management principles.

AS 3004. AIR FORCE LEADERSHIP STUDIES IV.*Cat. I (1/6 unit)*

The AS 3000 sequence of courses is a study of leadership, management fundamentals, professional knowledge, Air Force personnel and evaluation systems, leadership ethics, and communication skills required of an Air Force junior officer. The final course explores officer professional development, and personnel and evaluation systems including practical exercises.

The course includes three hours of class work and three hours of mandatory leadership laboratory per week. The AS 3004 Leadership Laboratory complements the classroom work by providing advanced leadership experiences in officer-type activities and giving students the opportunity to apply leadership and management principles.

AS 4101. NATIONAL SECURITY AFFAIRS I.*Cat. I (1/6 unit)*

The AS 4000 sequence of courses examines the national security process, regional studies, advanced leadership ethics, and Air Force doctrine. Special topics of interest focus the military as a profession, officership, military justice, civilian control of the military, preparation for active duty and current issues affecting military professionalism. Throughout the AS 4000 sequence of courses, briefing and writing exercises will be accomplished with emphasis on refining communication skills.

The first course examines in depth the national security process, principles of war and the Air Force major commands.

The course includes three hours of class work and three hours of mandatory leadership laboratory each week. The AS 4101 Leadership Laboratory complements the classroom work by providing advanced leadership experiences in officer-like activities and giving the students the opportunity to apply leadership and management principles.

AS 4102. NATIONAL SECURITY AFFAIRS II.*Cat. I (1/6 unit)*

The AS 4000 sequence of courses examines the national security process, regional studies, advanced leadership ethics, and Air Force doctrine. The second course provides a detailed examination of Air Force doctrine including a study of the joint doctrine and the roles of the other military services.

The course includes three hours of class work and three hours of mandatory leadership laboratory each week. The AS 4102 Leadership Laboratory complements the classroom work by providing advanced leadership experiences in officer-like activities and giving the students the opportunity to apply leadership and management principles.

AS 4103. NATIONAL SECURITY AFFAIRS III.*Cat. I (1/6 unit)*

The AS 4000 sequence of courses examines the national security process, regional studies, advanced leadership ethics, and Air Force doctrine. The third course provides an extensive study of alliances and regional security issues, including international peacekeeping and terrorism. Continued attention is given to developing the research and communications skills required by junior officers.

The course includes three hours of class work and three hours of mandatory leadership laboratory each week. The AS 4103 Leadership Laboratory complements the classroom work by providing advanced leadership experiences in officer-like activities and giving the students the opportunity to apply leadership and management principles.

AS 4104. PREPARATION FOR ACTIVE DUTY.*Cat. I (1/6 unit)*

The AS 4000 sequence of courses examines the national security process, regional studies, advanced leadership ethics, and Air Force doctrine. The final course in the series examines officership, the military justice system, social responsibilities, current issues affecting the military profession, and various factors that will facilitate a smooth transition from civilian to military life.

The course includes three hours of class work and three hours of mandatory leadership laboratory each week. The AS 4104 Leadership Laboratory complements the classroom work by providing advanced leadership experiences in officer-like activities and giving the students the opportunity to apply leadership and management principles.

BIOLOGY AND BIOTECHNOLOGY

BB 1001. INTRODUCTION TO BIOLOGY.*Cat. I*

This course consists of an overview of the major concepts of Biology, including: cell theory, bioenergetics, molecular biology, reproduction, nutrition, growth, development, homeostatic controls, and ecological issues. This course is intended for students seeking a broad overview of contemporary Biology with emphasis on human issues and current topics.

Recommended background: high school or introductory college level chemistry.

BB 1002. ENVIRONMENTAL BIOLOGY.*Cat. I*

This course provides an introduction to natural ecosystems, population growth, and the interaction between human populations and our environment. Major areas of discussion include Ecosystems, Populations, Biodiversity, Pollution, and Environmental Economics. This course is designed for students seeking a broad overview of ecological systems and the effect of humans on the ecosystems.

Recommended background: High School biology.

BB 1030. INTRODUCTION TO BIOLOGICAL MACROMOLECULES.*Cat. I*

This course is an introductory biology course for Biology and Biotechnology and health science pre-professional majors. The four classes of biologically important macromolecules (lipids, nucleic acids, proteins, and carbohydrates) will be studied, with particular reference to how their structure is appropriate to their function in cell metabolism and reproduction. Current topics in cell and molecular biology will be used as the basis for small group problem solving.

Recommended background: High School Biology, CH 1010 (concurrent).

BB 1040. PLANT DIVERSITY.*Cat. I*

An introductory course stressing general concepts related to the vast array of plant species, taxonomic links, and uses of major plant phyla in both society and industry. Some emphasis will be given to economically important species chosen from agronomic and non-agronomic situations.

Recommended background: high school biology or equivalent.

Students may not receive credit for both BB 2030 and BB 1040.

BB 1050. ZOOLOGY.*Cat. I*

This course is a survey of the animal kingdom with an emphasis on its history and organization. Particular attention is paid to special structures and mechanisms evolved by selected representatives of major phyla for solving problems of life in various environments.

Recommended background: BB 1001 and BB 1030.

Students may not receive credit for both BB 2020 and BB 1050.

BB 2002. MICROBIOLOGY.*Cat. I*

This course will focus on unicellular organisms with special reference to those of the kingdom Bacteria, and describe their taxonomy, morphology, and physiology. Special attention will be given to those organisms that are of ecological concern or serve a useful industrial purpose. The importance of microbes and viruses in public health will be presented. This course is designed for all biology majors and other students who seek a good general education in modern biology.

Recommended background: A basic understanding of cell biology and elementary biochemical processes is desired.

BB 2040. PRINCIPLES OF ECOLOGY.*Cat. I*

This course is designed to give the student a basis for understanding the abundance and distribution of plants and animals from the level of the individual to that of the ecosystem. The course will focus on specific scientific examples of ecological research to elucidate general concepts. The basic concepts covered will be augmented with problem sets designed to get the student comfortable with the mathematics of ecology. The course format will include lectures and discussion sections and may include a field trip to a wildlife sanctuary.

Recommended background: BB 1040, BB 1050, BB 2002, and MA 1021-1022.

BB 2550. CELL BIOLOGY.*Cat. I*

This entry level course, recommended for all BB, BBT, BC, and pre-professional majors, presents the fundamental aspects of cell structure and function, and is the foundation of all fields of modern biology.

Topics include: cell complexity and organizational hierarchy, evolution of the cell, cell surface, plasma membrane, single and double cytoplasmic membrane systems, nuclear fusion and hybridomas, cytoskeleton, cell growth, and differentiation.

Recommended background: BB 1001, BB 1030 or equivalent.

BB 2920. GENETICS.*Cat. I*

This course presents the principles and experimental evidence leading to our understanding of the gene concept and the role of DNA as genetic material. Patterns of inheritance, the relationship between genotype and phenotype, and transmission, coding, and expression of genetic information are considered in a variety of organisms. A quantitative, problem-solving approach and the use of genetic analysis as a tool to study biological phenomena are emphasized throughout the course. The course is designed for all biology and pre-professional majors.

Recommended background: BB 1030 or equivalent.

BB 2940. EXPERIMENTAL BIOLOGY I.*Cat. I*

The lab exercises in this course have been selected to provide the skills needed to study living organisms at the cellular level, and to emphasize the basic principles of Biology. Students will gain experience with procedures, equipment and lab skills common to all Biology fields. Emphasis is on precise data collection, analysis and interpretation of biological data. This course is designed for Biology/Biotechnology majors and other life science preprofessionals. One lecture and lab per week for 2 terms (i.e. 1/3 unit per 14 weeks).

This course may not be taken for less than 1/3 unit of credit except with the prior approval of the instructor.

Recommended background: a college level course in general chemistry and biology, or its equivalent.

BB 2950 EXPERIMENTAL BIOLOGY II*Cat. I*

A continuation of Experimental Biology I with lab exercises selected to emphasize the skills needed to study living organisms and their diversity. These exercises will emphasize the principles and techniques of genetics and microbiology, as well as the diversity of the biological flora and fauna. Unique aspects of living organisms will be featured as opportunities for use in Biotechnology. One lecture and lab per week for 2 terms (i.e. 1/3 unit per 14 weeks). This course may not be taken for less than 1/3 unit of credit except with the prior approval of the instructor.

Recommended background: BB 2940.

BB 3020. MODELING OF BIOLOGICAL SYSTEMS.*Cat. II*

This course will cover the use of mathematical and computational models to understand biological systems. Examples will be chosen from a number of different areas, including ecology, neurobiology, molecular biology and fermentation. In each topic area, we will address the assumptions of the model, how the model can be used to determine optimum behavior of the system, and the stability of the model parameters. No programming experience is necessary; students will use available computer software to explore these questions.

Recommended background: MA 1021 and 1022, and any 3000 or 4000 level BB course.

Offered in 2004-05 and in alternating years thereafter.

BB 3040. EXPERIMENTAL DESIGN AND DATA ANALYSIS.*Cat. II*

This applied course introduces students to the design of experiments and analysis of data. We will cover a number of experimental situations occurring frequently in biology, including testing the fit of data to theoretical distributions, comparisons of groups, and regression analysis. Emphasis will be placed on formulating the hypothesis of interest, designing experiments so that the subsequent analysis will have enough power to test the hypothesis, and choosing the appropriate analysis to perform. We will discuss the importance of pilot studies, and some of the most common errors made in choosing and performing statistical tests. Both parametric and non-parametric tests will be discussed. Students will use computer packages to analyze data from the literature and/or their own experimental data.

Recommended background: MA 2611, and any 3000 or 4000 level BB course.

Offered in 2003-04 and in alternating years thereafter.

Note: Students who have credit for BB 4040 may not receive credit for BB 3040.

BB 3055. MICROBIAL PHYSIOLOGY.*Cat. I*

This course will focus on the metabolic (enzymatic) pathways by which microorganisms obtain, process, and store substances and energy used for synthesis; and on the synthetic pathways by which these substances and energy are utilized. The occurrence of biological reactions in the light of the particular organism and its environment will be emphasized, as will those organisms and metabolic schemes of current or potential usefulness in bioprocess technology.

Recommended background: BB 2002, BB 2550, BB 2920, CH 4110 and CH 4120.

Students who have taken BB 4050 for credit will not receive credit for BB 3055.

BB 3080. NEUROBIOLOGY.*Cat. I*

An introduction to neurobiology, with emphasis on the cellular and molecular basis of neural development and function. Topics will range from electrical and biochemical signaling between neurons, to higher order functions of the nervous system, such as sensation, movement, and memory. Human neurological diseases and disorders will be discussed. Some guided reading of the primary literature will be included.

Recommended background: BB 2550, BB 2920, and BB 3101.

Students may not receive credit for both BB 4080 and BB 3080.

BB 3101. HUMAN ANATOMY & PHYSIOLOGY: MOVEMENT AND COMMUNICATION.*Cat. I*

The form and function of the systems that are responsible for the support, movement, internal communication, and interaction of the human body with its environment will be presented and discussed: Integumentary, Skeletal, Muscular, Nervous (including the senses), and Endocrine.

Recommended background: BB 2550 Cell Biology or BB 1001, Introduction to Biology. Suggested background: Concurrent Laboratory Module: BB 3511 (Nerve and Muscle Physiology). Students who have received credit for BB2130 (Human Anatomy) may not take BB3101 for credit.

BB 3102. HUMAN ANATOMY & PHYSIOLOGY: TRANSPORT AND MAINTENANCE.*Cat. I*

The form and function of the systems of the human body that provide for the intake, distribution, and processing of nutrients, water, and oxygen, and the systems that safeguard health by elimination of wastes, regulation of metabolism, and surveillance against disease will be presented and discussed. Digestive, Respiratory, Circulatory, Lymphatic, Endocrine, Urinary, and Reproductive.

Recommended Background: BB 2550 (Cell Biology); either BB 1001 (Introduction to Biology) or BB 1030 (Introduction to Biological Macromolecules); CH 1010 and CH 1020 (General Chemistry). Suggested background: Concurrent Laboratory Module: BB 3514 (Circulatory and Respiratory Physiology). Students who have received credit for BB3110 (Animal Physiology) may not take BB 3102 for credit.

BB 3120. PLANT PHYSIOLOGY AND CELL CULTURE.

Cat. I

The relationship of structure and function of multicellular plants will be examined at the biochemical level. Topics include (but are not limited to): water relations, mineral nutrition, intra- and inter-cellular transport, hormones, photosynthesis, in vitro culture of plant cells/tissues/organs, and environmental responses.

Recommended background: BB 1040, BB 2550, CH 1020.

BB 3140. EVOLUTION: PATTERN AND PROCESS.

Cat. II

We will explore several theoretical constructs of evolutionary processes. Topics will range from microevolutionary patterns to global extinctions and speciation. We will examine the causes of evolutionary trends from the molecular to the group level. Readings from current research into the units and levels of selection will be included.

Recommended background: BB 2550, BB 2920, at least one of (BB 1040, BB 2040, BB 1050).

This course will be offered in 2003-04 and in alternating years thereafter.

BB 3160. BEHAVIORAL ECOLOGY.

Cat. II

This course is an overview of the biological basis of animal behavior. Topics for the course include animal cognition and communication, foraging and orientation, and evolutionary issues of mate selection, territoriality, and group living. Format for the course is largely text readings and lecture with associated video support materials.

Recommended background: BB 1050, BB 2040.

This course will be offered in 2004-05 and in alternating years thereafter.

BB 3170. PLANT MORPHOLOGY AND DEVELOPMENT.

Cat. II

This course will focus on the form and function of developing plant structures. Beginning with the unique aspects of plant cells, the course will progress to include tissue and organ anatomy and will cover the phenomena responsible for defining the gross morphology of the organism. Coverage of these topics will culminate in an understanding of the integrated development of the whole plant. Some guided reading of the primary literature will be included.

Recommended background: BB 1040 or equivalent, and BB 2550.

This course will be offered in 2003-04 and in alternating years thereafter.

BB 3511. NERVE AND MUSCLE PHYSIOLOGY.

Cat. I (1/6 unit)

Computer and laboratory studies of nerve and muscle function.

Recommended background: BB 2940.

Concurrent or prior registration in BB 3101 is recommended.

BB 3512. MOLECULAR GENETICS LAB.

Cat. I (1/6 unit)

The topic of gene therapy will be used to familiarize the student with computer manipulations of biological sequence information.

Recommended background: BB 2920, BB 2550 and BB 4910/CH 4130.

BB 3513. CELL CULTURE TECHNIQUES FOR ANIMAL CELLS.

Cat. I (1/6 unit)

Basic laboratory skills in mammalian cell culture to include cell counting, freezing and thawing cell lines, culture of suspension and attached cells.

Recommended background: BB 2940, BB 2550 and knowledge of aseptic techniques.

Concurrent or prior registration in BB 4008 is recommended.

BB 3514. CIRCULATORY AND RESPIRATORY PHYSIOLOGY.

Cat. I (1/6 unit)

Computer and laboratory studies of circulatory and respiratory physiology.

Recommended background: BB 2940.

Concurrent or prior registration in BB 3102 is recommended.

BB 3516. SEPARATION TECHNIQUES IN BIOTECHNOLOGY.

Cat. I (1/6 unit)

A laboratory course in chromatographic and electrophoretic separation of proteins; plasmid isolation, restriction digestion and electrophoretic separation of DNA.

Recommended background: BB 2940.

Concurrent or prior registration in Biochemistry (CH 4110) and BB 4910 is recommended.

BB 3517. FERMENTATION.

Cat. I (1/6 unit)

An introductory laboratory course in basic fermentation techniques.

Recommended background: BB 2940, BB 2002, or knowledge of aseptic techniques.

Concurrent or prior registration in BB 3055 is suggested.

BB 3518. MOLECULAR BIOLOGY.

Cat. I (1/6 unit)

Laboratory investigations of select molecular characteristics of proteins and DNA.

Recommended background: BB 2940, BB 2550, CH 4110 and CH 4120.

Concurrent, or prior registration in BB 4910 is recommended.

BB 3519. PROTEIN PURIFICATION.

Cat. I (1/6 unit)

A laboratory course in protein purification techniques.

Recommended background: BB 2940, CH 4110.

Concurrent or prior registration in BB 4070 is recommended.

BB 3520. RECOMBINANT DNA TECHNOLOGY.

Cat. I (1/6 unit)

A laboratory course in the construction, isolation and mapping of recombinants, and use of the polymerase chain reaction.

Recommended background: BB 2940, BB 2550, CH 4110 and BB 4910.

Concurrent or prior registration in BB 4955 is recommended.

BB 3521. MICROSCOPY.

Cat. I (1/6 unit)

A laboratory course in the theory and operation of light and electron microscopes, including specimen preparation, operation of equipment, and microphotography.

Recommended background: BB 2940 and BB 2550.

BB 3522. TRANSMISSION ELECTRON MICROSCOPY.

Cat. I (1/6 unit)

This laboratory module will provide the student with the basic theory and practice of transmission electron microscopy. The course will include sample handling and preparation methods, use of the TEM, and photographic recording of observations made with the instrument.

Recommended background: BB 1001 or BB 2550, and BB 2940 or BB 2950.

BB 3620. DEVELOPMENTAL BIOLOGY.

Cat. II

This advanced level course provides a detailed survey of the processes of animal development, including fertilization, cleavage, gastrulation, and organogenesis. These processes are examined in the context of concepts such as differentiation, determination, induction, intercellular signaling, morphogenesis, and pattern formation. Emphasis is placed on current techniques for studying development, such as genetic analysis of mutations, recombinant DNA technology, molecular probing of gene expression, and gene transfer. The experimental focus is on model organisms such as nematodes, fruit flies, frogs, and mice.

Offered in 2004-05 and in alternating years thereafter.

Recommended background: BB 2002, BB 2550, BB 2920.

BB 3920. IMMUNOLOGY.

Cat. I

This is a survey course in immunology which assumes a background in cell biology, genetics and biochemistry. Topics to be covered will include cells of the immune system, antigen/antibody immunochemistry, immunogenetics and immune responses. Readings from research literature will be assigned.

Recommended background: BB 2550, BB 2920, CH 4110, and CH 4120.

BB 4008. CELL CULTURE THEORY AND APPLICATIONS.

Cat. I

The use of cultured animal cell systems for research and production will be explored. Concepts, including media design, the effects of extracellular matrices, scaling up of cell cultures, and biochemical and morphologic assessment of cell function, will be discussed as a basis for readings from the literature.

Recommended background: BB 2550, BB 2920, CH 4110, and CH 4120.

Students who have received credit for BB 4007 may not take BB 4008 for credit.

BB 4010. ADVANCED MOLECULAR GENETICS.

Cat. I

Topics in molecular genetics are presented using microbial systems as models. The structure, function and synthesis of DNA and the results of mutation, recombination and repair are emphasized. Simple bacteria and their plasmids, transposable elements and phages are discussed as experimental models.

Recommended background: BB 2002, BB 2550, BB 2920, BB 4910.

BB 4065. VIROLOGY.*Cat. I*

This advanced-level course uses a seminar format based on research articles to discuss current topics related to the molecular/cell biology of viral structure, function, and evolution. Particular emphasis is placed on pathological mechanisms of various human disorders, especially emerging diseases, and the use of viruses in research.

Recommended background: BB 2550.

BB 4070. SEPARATION OF BIOLOGICAL MOLECULES.*Cat. I*

This course provides a detailed survey of state-of-the-art methods employed by the biotechnology industry for the purification of products, proteins in particular, from fermentation processes. Focus is on methods which offer the best potential for scale-up. Included are the theory of the design as well as the operation of these methods at the laboratory scale. It is intended for biology/biotechnology majors, chemical engineering and biochemistry students.

Recommended background: knowledge of the topics in CH 4110 and CH 4120. Students who have received credit for BB 4060 may not take BB 4070 for credit.

BB 4140. ECOLOGICAL MANAGEMENT.*Cat. II*

We will take an in-depth look at the development of a management scheme for a natural area. The course focuses on the biological issues of ecological management rather than socio-economic ones. Format will vary from week to week and will include lectures, group discussions, workshops and field trips to a wildlife sanctuary with an established ecological management plan. Basic concepts of population ecology and field techniques of ecological research will be explored to give the student a working knowledge of the biological basis for ecological management.

Recommended background: BB 1040, BB 1050 and BB 2040.

This course will be offered in 2003-04 and in alternating years thereafter.

BB 4150. POPULATION AND COMMUNITY ECOLOGY.*Cat. II*

This course presents a detailed exploration of problems in population change and the interaction between populations and the environment. Topics covered will include single- and multiple-species population models, age/stage structured population growth, metapopulation growth, island bio-geography, community diversity and stability and the evolution of life history strategies. Format will include lectures and group discussion.

Recommended background: BB 1040 or BB 1050, BB 2040, MA 1021, MA 1022.

Suggested background: BB 3020, MA 2071.

Offered in 2004-05 and in alternating years thereafter.

BB 4250. ECOLOGICAL SIMULATION MODELING.*Cat. II*

This course will cover computer simulation models of populations, bioenergetics, behavior of individuals, and ecosystem dynamics. Modeling techniques covered will range from simple linear models of populations and interactions between ecosystem components to individual-based models of populations in complex environments. Students successfully completing the course should be capable of understanding models used in today's study of populations and ecosystems and of developing original models. Knowledge of a programming language is assumed.

Recommended background: BB 2040, BB 3020, MA 1021, MA 1022, CS 1005.

Suggested background: MA 2071 and CS 2005.

Offered in 2003-04 and in alternating years thereafter.

BB 4440. BIOINFORMATICS.*Cat. I*

This course will focus on the field of bioinformatics. After providing an overview of biological data as DNA and protein sequence, genetic markers and providing a summary of population genetics concepts, the course will cover various methods of computational genetic analysis. Students will learn about DNA and protein sequence analysis, gene mapping, evolutionary analysis, molecular biology databases, analysis of expression data and microarray analysis.

Recommended background: BB 2920, MA 2611 and MA 2612 or BB 3040.

BB 4550. ADVANCED CELL BIOLOGY.*Cat. I*

This advanced-level course uses a seminar format based on research articles to discuss current topics related to the molecular biology of cellular function. Particular emphasis is placed on biological mechanisms of autoimmune disorders, cancer, Alzheimers disease, thrombosis, haemostasis, neurotropic factors, and gene therapy.

Recommended background: BB 2550.

BB 4910. ADVANCED MOLECULAR BIOLOGY.*Cat. I*

This advanced level course explores the molecular mechanisms by which cells use genetic information to produce RNAs and proteins. Mechanisms and regulation of transcription in both prokaryotes and eukaryotes will be studied with an emphasis on protein-protein and protein-DNA interactions. The structure, organization, evolution and expression of the eukaryotic genome will be

emphasized. This course is intended for students who seek an in-depth understanding of gene function.

Recommended background: BB 2550, BB 2920, BB 4955, CH 4110, 4120 and 4130.

BB 4955. RECOMBINANT DNA PRINCIPLES AND APPLICATIONS.*Cat. I*

This course surveys both theory and applications in recombinant DNA methodology. Topics covered include enzymology of DNA manipulation; construction and isolation of recombinants; plasmid and bacteriophage vectors; structural analysis of cloned DNA.

Recommended background: prior knowledge of BB 2002, BB 2550, BB 2920, BB 4010, and basic molecular biology will be assumed.

IS4 BB. SPECIAL TOPICS.*Cat. I*

Experimental courses, special conferences and seminars are offered by advance arrangement only.

Graduate Biology and Biotechnology Courses of Interest to Undergraduates

The following courses are open to advanced undergraduates with special written permission of the course instructor and department head.

BB 501. SEMINAR.**BB 502. TECHNIQUES IN ELECTRON MICROSCOPY.**

This course presents the theory of operation, applications, and use of scanning and transmission electron microscopy in biology. Recent original articles from the biological literature illustrate the applications of these techniques to research. Students prepare specimens for both kinds of electron microscopes and employ the standard preparative techniques including fixation, dehydration, staining, critical point drying, vacuum evaporation, embedding and sectioning. Associated photographic methods are also introduced.

BB 505. FERMENTATION BIOLOGY.

Focuses on biological (especially microbiological) systems by which materials and energy can be interconverted (e.g., waste products into useful chemicals or fuels). The processes are dealt with at the physiological and the system level, with emphasis on the means by which useful conversions can be harnessed in a biologically intelligent way. The laboratory focuses on measurements of microbial physiology and on bench-scale process design.

BB 507. CELL CULTURE.

Techniques in animal cell and tissue culture from the excision of the original explant to hybridoma studies. The following topics are discussed: 1) initiation of primary cultures, their maintenance and subculture; 2) the initiation of suspension cultures, their maintenance and subculture; 3) organogenesis; 4) formation of protoplasts, their culture and fusion; and 5) cryopreservation and karyotyping.

BB 509. SCALE-UP OF BIOPROCESSING.

Strategies for optimization of bioprocesses for scale-up applications. In addition to the theory of scaling up unit operations in bioprocessing, students will scale-up a bench scale bioprocess (5 liters) including fermentation and downstream processing to 55 liters. Specific topics include the effects of scaling-up on: mass transfer and bioreactor design, harvesting techniques including tangential flow filtration and centrifugation, and chromatography (open column and HPLC).

Recommended courses include BB 3055 Microbial Physiology and BB 4070/560 Separations of Biological Molecules, as a working knowledge of the bench scale processes will be assumed. Otherwise, instructor permission is required.

BB 510. ADVANCED MICROBIAL GENETICS.

A study of modern molecular genetics as revealed by studies of microbial systems. This course covers detailed structure/function relationships in nucleic acids and proteins; molecular mechanisms of DNA replication and expression; mutagenesis, recombination, transposition, transformation, conjugation and repair; and molecular biology of plasmids and phages.

BB 542. ECOLOGICAL SIMULATION MODELING.

This course will cover computer simulation modeling of populations, bioenergetics, behavior of individuals, and ecosystem dynamics. Modeling techniques covered will range from simple linear models of populations and interactions between ecosystem components to individual-based models of populations in complex environments. Students successfully completing the course should be capable of understanding models used in today's study of populations and ecosystems and of developing original models. Knowledge of a programming language is assumed.

BB 544. BIOINFORMATICS.

This course will focus on the field of Bioinformatics. After providing an overview of biological data such as DNA and protein sequences, genetic markers and providing a summary of population genetics analysis. Students will learn about DNA and protein sequence analysis, gene mapping, evolutionary analysis, molecular biology databases, analysis of expression data and microarray analysis.

BB 545. ADVANCED CELL BIOLOGY.

This advanced-level course uses a seminar format based on research articles to discuss current topics related to the molecular biology of cellular function. Particular emphasis is placed on biological mechanisms of autoimmune disorders, cancer, Alzheimers disease, thrombosis, haemostasis, neurotrophic factors, and gene therapy.

BB 549. MOLECULAR BIOLOGY.

Synthesis of biologically important macromolecules. Selected readings from the scientific literature are used to illustrate the milestones of molecular biology and the development of techniques and experiments. Protein synthesis and ribosome structure lead into a discussion of RNA and finally DNA synthesis, with the chemistry of DNA molecules receiving significant attention.

BB 550. RECOMBINANT DNA BIOCHEMISTRY.

This course presents the theory of recombinant DNA methodology. Topics covered include enzymology of DNA manipulation; construction and isolation of recombinants; plasmid and bacteriophage vectors; structural analysis of cloned DNA.

BB 560. SEPARATION OF BIOLOGICAL MOLECULES.

This course provides a detailed hands-on survey of state-of-the-art methods employed by the biotechnology industry for the purification of products, proteins in particular, from fermentation processes. Focus is on methods which offer the best potential for scale-up. Included are the theory of the design as well as the operation of these methods both at the laboratory scale as well as scaled up. It is intended for biology, biotechnology, chemical engineering, and biochemistry students. A knowledge of basic biochemistry is assumed.

BB 565. VIROLOGY.

This advanced-level course uses a seminar format based on research articles to discuss current topics related to the molecular/cell biology of viral structure, function, and evolution. Particular emphasis is placed on pathological mechanisms of various human disorders, especially emerging diseases, and the use of viruses in research.

BB 570. SPECIAL TOPICS.

Specialty subjects are offered using the research expertise of the department faculty. Content and format varies to suit the interest and needs of the faculty and students. This course may be repeated for different topics covered.

BIOMEDICAL ENGINEERING

The second digit for Biomedical Engineering course numbers is coded as follows:

- 0 — Bioinstrumentation, Biosignals, Introduction
- 1 — Physiology
- 2 — Bioelectric, Bioimaging
- 3 — Design
- 5 — Biomechanics, Biological Systems
- 6 — Biofluids
- 8 — Biomaterials

BE 1001. INTRODUCTION TO BIOMEDICAL ENGINEERING.

Cat. I

Lectures, demonstrations, hands-on experimentation, and scientific literature readings in the major branches of biomedical engineering. A series of laboratory demonstration/experiments are utilized to complement key concepts covered in various lectures.

BE 2204. BIOELECTRIC FOUNDATIONS.

Cat. I

An introduction to the origins and characteristics of the electric and electromagnetic signals that arise in biological tissues. Topics include the behavior of excitable cells and tissues, the intrinsic electrical and magnetic properties of biological tissues, and the response of excitable cells to electric and magnetic field stimulation. Laboratory projects include the measurement of bioelectric signals (EMG, EKG, EEG, EOG, and evoked response) and the fundamentals of data acquisition, analysis, and statistics. The principles of writing and maintaining a laboratory notebook are also developed and used.

Recommended background: BB 2550 or equivalent, PH 1120 or PH 1121.

Students who have received credit for BE 4101 may not receive credit for BE 2204.

BE 2504. FOUNDATIONS IN BIOMECHANICS.

Cat. I

This course is an introduction to the analysis of the musculoskeletal systems using principles of engineering mechanics. Basic principles of mechanics, stress, strain and deformation in beams are presented and used to characterize the

material properties of tissues such as skin, tendon, ligament, bone and cartilage. Principles of biomechanics are also applied to the design of medical devices and bioengineered tissues. Topics include forces, moments of forces, free body diagrams, principal stresses, transverse shear stresses and beam loading.

Recommended background: BB 2550 or equivalent, MA 2051, PH 1110 or PH 1111.

Students who have previously received credit for BE 4504 may not receive credit for BE 2504.

BE 2604. FOUNDATIONS IN BIOLOGICAL TRANSPORT PHENOMENA.

Cat. I

This course is an introduction to the analysis of complex biological systems using principles of transport phenomena. Basic theories of momentum transport, mass transport and energy transport are presented and applied to cellular and mammalian physiology. Principles of transport phenomena are also applied to the design of medical devices and bioengineered tissues. Topics include differential and integral balances, rheology of Newtonian and non-Newtonian fluids, diffusion in reacting systems and homogeneous vs. heterogeneous reaction systems.

Recommended background: BB 2550 or equivalent, MA 2051, PH 1110 or PH 1111.

Students who have received credit for BE 3101 may not receive credit for BE 2604.

BE 3011. BIOINSTRUMENTATION AND BIOSENSORS.

Cat. I

A study of the basic principles of biomedical electronics and measurement with emphasis on the operational performance and selection of transducers, instruments and systems for biomedical data acquisition and processing. Biopotential electrodes. Analysis and selection of physical, optical, electrical, mechanical, thermal transduction mechanisms which form the basis of the sensor design. Clinical laboratory instrumentation. Electrical safety problems in the clinical environment.

Recommended background: MA 2051, EE 3601, or equivalent.

BE 3110. EXPERIMENTAL PHYSIOLOGY FOR ENGINEERS.

Cat. I

A laboratory-based course providing an introduction to experimental physiology for engineers interested in a hands-on exploration of physiologic principles. Emphasis is placed on developing the student's ability to make measurements on and interpret data from living systems. This is achieved with laboratory projects and computer-based physiology simulators. Students are expected to apply relevant mathematical equations, models, and statistics when interpreting data collected in the laboratories. Laboratory projects include: animal care and anesthesia, muscle and nerve physiology, electrophysiology, circulatory physiology, respiratory physiology, and acid-base physiology. The principles of writing and maintaining a laboratory notebook are also developed and used.

Recommended background: BE 2204 and BB 2550 or equivalent.

BE 3300. BIOMEDICAL ENGINEERING DESIGN.

Cat. I

Students are guided through the open-ended, real-world, design process starting with the project definition, specification development, management, team interactions and communication, failure and safety criteria, progress reporting, marketing concepts, documentation and technical presentation of the final project outcome. The course will include a significant writing component, will make use of computers, and hands-on design explorations.

Students who have previously received credit for BE 2300 may not receive credit for BE 3300.

BE 4011. BIOMEDICAL SIGNAL ANALYSIS.

Cat. II

Introduction to biomedical signal processing and analysis. Fundamental techniques to analyze and process signals that originate from biological sources: ECGs, EMGs, EEGs, blood pressure signals, etc. Course integrates physiological knowledge with the information useful for physiologic investigation and medical diagnosis and processing. Biomedical signal characterization, time domain analysis techniques (transfer functions, convolution, auto- and cross-correlation), frequency domain (Fourier analysis), continuous and discrete signals, deterministic and stochastic signal analysis methods. Analog and digital filtering.

Recommended background: EE 2311, BE 3011, or equivalent.

This course will be offered in 2004-05, and in alternating years thereafter.

BE4023. BIOMEDICAL INSTRUMENTATION DESIGN I.

Cat. II

This course builds on the fundamental knowledge of bioinstrumentation and biosensors presented in BE 3011. Lectures and hands-on laboratory experiments cover the principles of designing, building and testing analog instruments to measure biological events. Design laboratories will include biopotential amplifiers and biosensor/bioinstrumentation systems for the measurement of physiological parameters.

Recommended background: BE 2204, and BE 3011.

This course will be offered in the 2004-05 academic year and in alternating years thereafter.

BE 4025. BIOMEDICAL INSTRUMENTATION DESIGN II.*Cat. II*

This course builds on the fundamental knowledge of bioinstrumentation and biosensors presented in BE3011. Lectures and hands-on laboratory experiments cover the principles of biosensor interfacing, low-level measurements, analog-to-digital and digital-to-analog signal conversion, microprocessor and microcontroller based biomedical instrumentation, and programming.

Recommended background: BE2204, and BE3011.

This course will be offered in the 2003-2004 academic year and in alternating years thereafter.

BE 4201. BIOMEDICAL IMAGING.*Cat. I*

This course is a practical introduction to biomedical image processing using examples from various branches of medical imaging. Topics include: point operations, filtering in the image and Fourier domains, image reconstruction in computed tomography and magnetic resonance imaging, and data analysis using image segmentation. Review of linear-systems theory and the relevant principles of physics. Course work uses examples from microscopy, computed tomography, X-ray radiography, and magnetic resonance imaging. A working knowledge of undergraduate signal analysis and linear algebra is desirable. Facility with a high-level programming language is recommended.

The course will be offered in 2004-05, and in alternating years thereafter.

BE/ME 4504. BIOMECHANICS.*Cat. II*

This course emphasizes the applications of mechanics to describe the material properties of living tissues. It is concerned with the description and measurements of these properties as related to their physiological functions. Emphasis on the interrelationship between biomechanics and physiology in medicine, surgery, body injury and prostheses.

Topics covered include: Review of basic mechanics, stress, strain, constitutive equations and the field equations, viscoelastic behavior, and models of material behavior. The measurement and characterization of properties of tendons, skin, muscles and bone. Biomechanics as related to body injury and the design of prosthetic devices.

Recommended background: Mechanics (ES 2501, ES 2502, ME 3501), Mathematics (MA 2051).

This course will be offered in 2003-04, and in alternating years thereafter.

BE 4541. BIOLOGICAL SYSTEMS.*Cat. II*

Review of control theory with applications to biological control systems. Analysis and modeling of physiological systems. Physiological systems identification. Formulation of mathematical models of biological systems and the application of computer techniques in the simulation of these systems. Recommended background: Laplace transforms, transient response, frequency response and system stability analysis.

This course will be offered in 2003-04, and in alternating years thereafter.

BE/ME 4606. BIOFLUIDS.*Cat. II*

This course emphasizes the applications of fluid mechanics to biological problems. The course concentrates primarily on the human circulatory and respiratory systems. Topics covered include: blood flow in the heart, arteries, veins and microcirculation and air flow in the lungs and airways. Mass transfer across the walls of these systems is also presented.

Recommended background: ME 3501 and fluid mechanics equivalent to ES 3004.

This course will be offered in 2004-05, and in alternating years thereafter.

BE/ME 4814. BIOMATERIALS.*Cat. I*

A course discusses various aspects pertaining to the selection, processing, testing (in vitro and in vivo) and performance of biomedical materials. The biocompatibility and surgical applicability of metallic, polymeric and ceramic implants and prosthetic devices are discussed. The physico-chemical interactions between the implant material and the physiological environment will be described. The use of biomaterials in maxillofacial, orthopedic, dental, ophthalmic and neuromuscular applications is presented.

Recommended background: BB 3130 or equivalent introduction to Human Anatomy, ES 2001 or equivalent introduction to Materials Science and Engineering.

BE 4828. BIOMATERIALS-TISSUE INTERACTIONS*Cat. I*

This course examines the principles of materials science and cell biology underlying the design of medical devices, artificial organs and scaffolds for tissue engineering. Molecular and cellular interactions with biomaterials are analyzed in terms of cellular processes such as matrix synthesis, degradation and contraction. Principles of wound healing and tissue remodeling are used to study biological responses to implanted materials and devices. Case studies will be analyzed to compare tissue responses to intact, bioresorbable and bioerodible biomaterials. Additionally, this course will examine criteria for restoring physiological function of tissue and organs and investigate strategies to design implants and prostheses based on control of biomaterial-tissue interactions.

Recommended background: BE 2604, BB 2550 or equivalent, ES 2001 or equivalent, PH 1110 or PH 1111.

Graduate Biomedical Engineering Courses of Interest to Undergraduates**BE 523. BIOMEDICAL INSTRUMENTATION.**

Origins and characteristics of bioelectric signals, recording electrodes, amplifiers, chemical pressure and flow transducers, noninvasive monitoring techniques, and electrical safety. (Prerequisite: Circuits and electronics, control engineering or equivalent.)

BE 525. MICROPROCESSOR-BASED BIOMEDICAL INSTRUMENTATION.

This course provides hands-on laboratory experience with common biomedical transducers and instrumentation used in physiological and clinical evaluation. Lectures and laboratory experiments cover electronic circuit design and construction, analog/digital signal acquisition and processing, and microprocessor-based biomedical instrumentation. The basic principles of hardware and software designs for interfacing biomedical sensors to a general purpose IBM-PC are emphasized. (Prerequisite: Analog and digital electronics.)

BE 541. BIOLOGICAL SYSTEMS.

Review of control theory with applications to biological control systems. Development of mathematical models of selected biological control systems and the application of computer techniques in the simulation of these systems.

BE/ME 550. TISSUE ENGINEERING.

This biomaterials course focuses on the selection, processing, testing and performance of materials used in biomedical applications with special emphasis upon tissue engineering. Topics include: material selection and processing, mechanisms and kinetics of material degradation, cell-material interactions and interfaces; effect of construct architecture on tissue growth; and transport through engineered tissues. Examples of engineering tissues for replacing cartilage, bone, tendons, ligaments, skin and liver will be presented. (Recommended preparation: A first course in biomaterials equivalent to BE/ME 4814 and a basic understanding of physiology and cell biology.)

BE 551. BIOLOGICAL SIGNAL PROCESSING.

Basic principles of digital processing of biological signals, and its application on PC-compatible computers. The theoretical fundamentals and practical examples of signal processing. The major emphasis is on linking the theoretical knowledge with easy to comprehend practical examples. (Prerequisites: Basic signal analysis.)

BE/ME 552. TISSUE MECHANICS.

This biomechanical course focuses on advanced techniques for the characterization of the structure and function of hard and soft tissues and their relationship to physiologic processes. Applications include: tissue injury, wound healing, the effect of pathological conditions upon tissue properties and design of medical devices and prostheses. (Recommended preparation: A first course in biomechanics equivalent to BE/ME 4504.)

BE/ME 554. COMPOSITES WITH BIOMEDICAL AND MATERIALS APPLICATIONS.

Introduction to fiber/particulate reinforced, engineered and biologic materials. This course focuses on the elastic description and application of materials that are made up of a combination of submaterials, i.e., composites. Emphasis will be placed on the development of constitutive equations that define the mechanical behavior of a number of applications, including: biomaterial, tissue, and materials science. (Prerequisites: understanding of stress analysis and basic continuum mechanics.)

BE/ME 558. BIOFLUIDS AND BIOTRANSPORT.

The emphasis of this course is on modeling fluid flow within the cardiovascular and pulmonary systems and the transport processes that take place in these systems. Applications include artificial heart valves, atherosclerosis, arterial impedance matching, clinical diagnosis, respiration, aerosol and particle deposition. Depending upon class interest, additional topics may include: reproductive fluids, animal propulsion in air and water and viscoelastic testing. (Recommended preparation: A first course in biofluids equivalent to BE/ME 4606.)

BE 560. PHYSIOLOGY FOR ENGINEERS.

An introduction to fundamental principles in cell biology and physiology designed to provide the necessary background for advanced work in biomedical engineering. Quantitative methods of engineering and the physical sciences are stressed. Topics include cell biology, DNA technology, and the physiology of major organ systems.

NOTE: This course can be used to satisfy a life science requirement in the biomedical engineering program. It cannot be used to satisfy a biomedical engineering course requirement.

BE 562. LABORATORY ANIMAL SURGERY.

A study of anesthesia, surgical techniques, and postoperative care in small laboratory animals. Anatomy and physiology of species used included as needed. Class limited to 15 students. Approximately 15 surgical exercises are performed by each student.

NOTE: This course can be used to satisfy a life science requirement in the biomedical engineering program. It cannot be used to satisfy a biomedical engineering course requirement.

BE 570. ENGINEERING IN THE CLINICAL ENVIRONMENT.

Examines the responsibilities and functions of the biomedical engineer in the health care complex in the solution of the technical and engineering problems associated with patient care. Topics include equipment management, monitoring systems, electrical safety, prosthetics, technical education for medical personnel, hospital systems engineering, and administrative functions.

BE 581. MEDICAL IMAGING SYSTEMS.

Overview of the physics of medical image analysis. Topics covered include X-Ray tubes, fluoroscopic screens, image intensifiers; nuclear medicine; ultrasound; computer tomography; nuclear magnetic resonance imaging. Image quality of each modality is described mathematically, using linear systems theory (Fourier transforms, convolutions). (Prerequisite: Signal analysis course EE 3303 or equivalent.)

BE 582. PRINCIPLES OF IN VIVO NUCLEAR MAGNETIC RESONANCE IMAGING.

This course emphasizes the applications of Fourier transform nuclear magnetic resonance (FTNMR) imaging and spectroscopy in medicine and biology. Course topics include: review of the basic physical concepts of NMR (including the Bloch equations), theoretical and experimental aspects of FTNMR, theory of relaxation and relaxation mechanisms in FTNMR, instrumentation for FTNMR, NMR imaging techniques (point, line, plane, and volume methods), and in vivo NMR spectroscopy (including volume localization techniques). (Prerequisites: Differential and integral calculus, ordinary differential equations; organic chemistry recommended.)

BE 585. PRINCIPLES OF IN VIVO NUCLEAR MAGNETIC RESONANCE SPECTROSCOPY.

This course emphasizes the applications of Fourier transform nuclear magnetic resonance (FTNMR) spectroscopy in medicine and biology. Course topics include: Review of the basic physical concepts of NMR, review of covalent chemical binding and its relationship to the NMR chemical shift, factors in biological systems that influence the NMR chemical shift, data acquisition and processing techniques in vivo NMR spectroscopy, and the application of NMR spectroscopy to clinical studies. (Prerequisites: BE 582, organic chemistry and biochemistry are strongly recommended.)

BE 595. SPECIAL TOPICS IN BIOMEDICAL ENGINEERING.

Topics in Biomedical Engineering. Presentations and discussions of the current literature in one or more of the following areas: medical imaging, neurosensory systems, bio-statics.

BE 595B. BIOMATERIALS IN THE DESIGN OF MEDICAL DEVICES.

Biomaterials are an integral part of medical devices, implants, controlled drug delivery systems, and tissue engineered constructs. Extensive research efforts have been expended on understanding how biologic systems interact with biomaterials. Meanwhile, controversy has revolved around biomaterials and their availability as a result of the backlash to the huge liability resulting from controversies related to material and processing shortcomings of medical devices. This course specifically addresses the unique role of biomaterials in medical device design and the use of emerging biomaterials technology in medical devices. The need to understand design requirements of medical devices based on safety and efficacy will be addressed. Unexpected device failure can occur if testing fails to account for synergistic interactions from chronic loading, aqueous environments, and biologic interactions. Testing methodologies are readily available to assess accelerated effects of loading in physiologic-like environments. This combined with subchronic effects of animal implants is a potential tool in assessing durability. It is difficult to predict the chronic effects of the total biologic environment. The ultimate determination of safety comes not only from following the details of regulations, but with an understanding of potential failure modes and designs that lowers the risk of these failures. This course will evaluate biomaterials and their properties as related to the design and reliability of medical devices.

BE 595M. MEDICAL DEVICE REGULATION.

This course provides an overview of regulations that guide the Medical Devices industry. Primary focus is on the Food, Drug and Cosmetic Act and its associated regulations. The course covers the FD&C Act, including definitions, prohibited acts, penalties and general authority. The course also covers regulations, including establishment registration, premarket approval (PMA), and current good manufacturing practices. Requirements of other federal agencies (NRC, FCC, EPA) will also be discussed.

CHEMICAL ENGINEERING

CM 2011. CHEMICAL ENGINEERING FUNDAMENTALS.

Cat. I

This first course in chemical engineering is designed to give students the ability to use techniques and solve problems of interest to chemical engineers. Students will learn fundamental material by completing analysis, design, and/or laboratory projects. Topics covered include: material balances and stoichiometry, pressure, volume, and temperature behavior of pure fluids, 1st law of thermodynamics, vapor-liquid equilibria with ideal thermodynamics, and staged separation processes.

Recommended background: Elementary college chemistry and calculus.

Students may not receive credit towards CM distribution requirements for both CM 2011 and CM 2001.

CM 2012. ELEMENTARY CHEMICAL PROCESSES.

Cat. I

This course aims to build a strong foundation in analysis of chemical processes via a project-based approach. Topics covered include analysis and design of stagewise separation processes such as distillation, 1st and 2nd law (of thermodynamics) analysis of power and refrigeration cycles, and application of material and energy balances in industrial chemical processes, including those with recycle and non-ideal systems.

Recommended background: Elementary college chemistry and calculus and some familiarity with the topics listed in CM 2011.

Students may not receive credit towards CM distribution requirements for both CM 2012 and ES 3000.

CM 2013. APPLIED CHEMICAL ENGINEERING THERMODYNAMICS.

Cat. I

This course uses a project-based approach to build confidence and competence in the use of chemical engineering thermodynamics for the analysis and design of chemical processes. Topics covered include extractive separation systems, solution thermodynamics and nonreacting multicomponent mixtures, phase equilibria and property changes on mixing.

Recommended background: Elementary college chemistry and calculus and some familiarity with the topics listed in CM 2011 and CM 2012.

Students may not receive credit towards CM distribution requirements for both CM 2013 and CM 2102.

CM 2014. ADVANCED CHEMICAL PROCESSES.

Cat. I

This course builds on prior work in material and energy balances, chemical engineering thermodynamics, and stagewise separation processes to facilitate student mastery and design of more complex processes. Topics covered include chemical reaction equilibria, material and energy balances for non-steady state systems, combined material and energy balances, humidification, and batch distillation.

Recommended background: Elementary college chemistry and calculus and some familiarity with the topics listed in CM 2011, CM 2012, and CM 2013.

Students may not receive credit towards CM distribution requirements for both CM 2014 and CM 2002.

CM 3201. KINETICS AND REACTOR DESIGN.

Cat. I

Techniques for experimentally determining rate laws for simple and complex chemical reactions, the mechanisms and theories of chemical reactions, the function of catalysts, and the design of isothermal, adiabatic, batch and flow reactors. The course is intended to provide chemists and chemical engineers with the conceptual base needed to study reactions and perform in the design and analysis of reactors.

Recommended background: differential equations, thermodynamics and some organic chemistry.

CM 3501. APPLIED MATHEMATICS IN CHEMICAL ENGINEERING.

Cat. I

The consolidation of the methods of mathematics into a form that can be used for setting up and solving chemical engineering problems. Mathematical formulation of problems corresponding to specific physical situations such as momentum, energy and mass transfer, and chemical reactions. Analytical and numerical techniques for handling the resulting ordinary and partial differential equations and finite difference equations.

Recommended background: ordinary differential equations, partial derivatives and vectors, momentum heat and mass transfer.

CM 3601. CHEMICAL MATERIALS ENGINEERING.

Cat. II

This course is designed to provide a working knowledge in the solving of materials problems encountered by chemical engineers and in the engineering of new and improved materials used in chemical processes. The approach used is the correlation of engineering properties with atomic and microstructures, utilizing the diagnostic techniques of X-ray diffraction and spectrometry, microscopy, and phase relationships.

Topics include surface active materials such as catalysts, sorbents, filtering and separation agents, corrosion resistant materials, metals, refractories and polymers used in construction materials, particularly for pollution control.

Recommended background: basic knowledge of chemistry.

This course will be offered in 2003-04, and in alternating years thereafter.

CM 3910. CHEMICAL AND ENVIRONMENTAL TECHNOLOGY.

Cat. II

Day trips to industrial plants provide an insight into the real world of the chemical industry. Advanced technologies for commercially producing major organic chemicals and the monomers and polymers derived from them are described. Petroleum refining, catalytic and thermal petrochemical processes, soaps and detergents, specialty chemicals, and antibiotic production processes are presented at the industrial level. Large scale unit operations and processes are seen on the plant trips. Students see how plant layout is integrated with process and product control and environmental protection at each facility.

Particular attention is paid to plant scale processes and equipment for control of chemical spills, hazards, and environmental pollution, for safety and accident prevention, and for compliance with local and national laws.

Recommended background: general understanding of Organic Chemistry and Material Balances is assumed.

This course will be offered in 2004-05, and in alternating years thereafter.

CM 3920. AIR QUALITY MANAGEMENT.

Cat. II

This course discusses the sources, sinks, ambient concentrations and effects of major gaseous and particulate air pollutants. The course is problem oriented and applied engineering methods to develop strategies for managing air quality on a local, regional and global scale. Topics include: indoor air quality, regional air shed modelling, global atmospheric change and design and efficiencies of air pollution control devices.

Recommended background: knowledge of chemistry, mathematics and engineering principles.

This course will be offered in 2004-05, and in alternating years thereafter.

CM 4401. UNIT OPERATIONS OF CHEMICAL ENGINEERING I.

Cat. I

Laboratory-application of fundamental theories to practical chemical engineering operations. Emphasis is on building the student's understanding and ability to approach the problems of design and operations of large scale chemical processing equipment.

The course is a combination of lectures and laboratory projects in the area of unit operations. Laboratory projects include experiments in fluid-flow phenomena through various media such as: friction in conduits, filtration, pressure drop in packed towers, fluidization of solids, and spray drying.

Students are expected to carry out the planning and execution of experimental work as well as the analysis and reporting of experimental results in both written and oral format.

Recommended background: knowledge of chemistry, mathematics and engineering principles.

CM 4402. UNIT OPERATIONS OF CHEMICAL ENGINEERING II.

Cat. I

Overall format and procedure are essentially the same as in Unit Operations of Chemical Engineering I.

Laboratory projects include experiments in heat and mass transfer such as: heat transfer in two heaters and a cooler, climbing film evaporation, multiple effect evaporation, absorption, extraction, distillation and rotary drying of solids.

Recommended background: familiarity with techniques and procedures emphasized in CM 4401.

CM 4403. CHEMICAL ENGINEERING DESIGN.

Cat. I

Design of equipment, systems and plants; discussion of factors important in chemical plant design such as: economics, cost estimation, profitability, process selection, materials of construction, process control, plant location and safety. Introduction to optimization and computer-aided design. Principles are illustrated with short industrial-type problems.

Recommended background: thermodynamics; heat, mass and momentum transfer; inorganic and organic chemistry; chemical kinetics and reactor design.

CM 4404. CHEMICAL PLANT DESIGN PROJECT.

Cat. I

Application of Chemical Engineering design principles to the design of a major chemical plant. Students work in groups to produce a preliminary practical process flowsheet, equipment and plant design, and economic analysis.

Recommended background: familiarity with techniques and procedures emphasized in CM 4403.

CM 4405. CHEMICAL PROCESS DYNAMICS AND CONTROL LABORATORY.

Cat. I

This course is intended to provide laboratory application of fundamental principles of chemical process dynamics and feedback control. This includes open-loop dynamics of typical chemical engineering processes such as distillation, fluid flow,

chemical reactors and heated stirred tanks. Closed-loop experiments will involve control loop design, controller tuning, multivariable, and computer control.

Students will be required to design and execute their own experiments based on supplied objectives. Analysis and presentation of the results will be done through oral and written reports.

Recommended background: knowledge of fluid flow and heat transfer, mathematics and chemical engineering principles.

Graduate Chemical Engineering Courses of Interest to Undergraduates

CM 504. MATHEMATICS ANALYSIS IN CHEMICAL ENGINEERING.

Methods of mathematical analysis selected from such topics as vector analysis, matrices, complex variables, Eigenvalue problems, Fourier analysis, Fourier transforms, Laplace transformation, solution of ordinary and partial differential equations, integral equations, calculus of variations, perturbation and asymptotic methods and numerical analysis. Emphasis on application to the solution of chemical engineering problems.

CM 506. KINETICS AND CATALYSIS.

Theories of reaction kinetics and heterogeneous catalysis are developed for both simple and complex reactions. The kinetics and mechanisms of both catalyzed and uncatalyzed reactions are explored, as well as the effects of bulk and pore diffusion. Techniques for experimentation, reaction data treatment, and catalyst preparation and characterization are related to developing a sound approach to studying a chemical reaction.

CM 507. CHEMICAL REACTOR DESIGN.

A review of the design of ideal reactors. Main course topics include: deviations from ideal reactor behavior; transport effects in reacting systems; steady state multiplicity and stability analysis; optimization of reactors; analysis of heterogeneous reactors.

CM 508. CATALYSIS AND SURFACE SCIENCE OF MATERIALS.

The major factors which distinguished catalytic processes for chemicals and fuels from one another are the structure and composition of the materials used as catalysts.

This course examines the detailed structures and reactivities of solid catalysts like zeolites, solid state inorganics, supported metals and metal-support interactions, carbon catalysts, anchored catalysts and others. Several important spectroscopic techniques used in surface science such as X-ray photoelectron spectroscopy (ESCA), electron microprobe, AUGER, scanning electron microscopy, EXAFS, Mossbauer, Fourier-transform infrared, enhanced laser Raman spectroscopy and photoacoustics spectroscopy will be described for characterization of the catalytic surfaces.

The relationship between the structures and reactivities of important catalysts used in hydrocarbon oxidation and functionalization and syngas reactions will be examined to rationalize how they accomplish specific catalytic transformations.

CM 510. DYNAMICS OF PARTICULATE SYSTEMS.

Systems of discrete particles which grow in size or some other characteristic variable (e.g., age, molecular weight, etc.) are analyzed. Both reaction engineering and population balance analyses are introduced for batch and continuous systems. Steady state and transient system dynamics are explored.

Depending on class interest, specific topics may include: crystallization, latex synthesis, polymer molecular weight distribution, fermentation/ecological systems and gas-solid systems.

CM 521. BIOCHEMICAL ENGINEERING.

The course emphasizes the basic concepts of biological systems which are relevant to study by chemical engineers. Topics covered include ligand binding and membrane transport processes; growth kinetics of microorganisms; kinetics of interacting multiple populations; biological reactor design and analysis; soluble and immobilized enzyme kinetics; optimization and control of fermentation; and biological product recovery and separation.

CM 543. MOLECULAR SIEVES.

The structure, natural occurrence, synthesis, properties, and uses of the microporous crystals known as molecular sieves are examined. Emphasis is placed on understanding the relationship of their internal structures and their use as adsorbants and catalysts.

CM 561. ADVANCED THERMODYNAMICS.

An examination of the fundamental concepts of classical thermodynamics and presentation of existence theorems for the thermodynamic properties with study of relations among them. The inequality of Clausius as a criterion for equilibrium in both chemical and physical systems. Examination of thermodynamic equilibrium for a variety of restraining conditions. Applications to fluid mechanics, process systems and chemical systems. Computation of complex equilibria.

CM 571. INTERMEDIATE TRANSPORT PHENOMENA.

Mass, momentum and energy transport; analytic and approximate solutions of the equations of change. Special flow problems such as creeping, potential and laminar boundary-layer flows. Heat and mass transfer in multi-component systems. Estimation of heat and mass transfer rates. Transport with chemical reaction.

CM 572. MASS AND ENERGY TRANSFER.

Advanced treatment of heat and mass transfer. Topics from: forced and natural convection; high-speed and rarefied gas flows; film and dropwise condensation, spray cooling, boiling and two-phase flow; packed and fluidized bed heat and mass transfer; the heat pipe; radiant transfer within enclosures, including radiation from gases and flames; ionic transport and electrochemical systems; combustion and mass transfer; drying and diffusion in porous materials, mass transfer; adsorption; design of heat and mass transfer equipment.

CM 573. SEPARATION PROCESSES.

Thermodynamics of equilibrium separation processes such as distillation, absorption, adsorption and extraction. Multi-staged separations. Principles and processes of some of the less common separations.

CM 574. FLUID MECHANICS.

Advanced treatment of fluid kinematics and dynamics. Stress and strain rate analysis using vectors and tensors as tools. Incompressible and compressible, one-dimensional flows in channels, ducts and nozzles. Nonviscous and viscous flow fields. Boundary layers and turbulence. Flow through porous media such as fixed and fluidized beds. Two-phase flows with drops, bubbles and/or boiling. Introduction to non-Newtonian flows.

CM 580. TRANSFORMATION AND TRANSPORT IN THE ENVIRONMENT.

This course will focus on the transformation and transport of pollutant chemicals, nutrients and colloids in natural and engineered environmental systems. The first part of the course deals with the transfer of chemicals between different environments (water and air, water and solid phases). The second part of the course deals with processes by which a compound is chemically or biologically transformed into one or more products.
Research – as arranged

CHEMISTRY AND BIOCHEMISTRY

GENERAL CHEMISTRY SEQUENCE

The general chemistry sequence, CH 1010–1040, is a unified sequence of courses in which areas of major importance in chemistry are discussed in depth from both the empirical and theoretical viewpoints. Each of the four courses develops a theme, or core idea, of chemistry. The sequence is designed for biology, science and engineering majors.

The format of each course includes four 1-hour classroom meetings and one 3-hour laboratory meeting per week. For reasons of safety, contact lenses may not be worn in the chemical laboratories. Prescription glasses meeting the ANSI standard Z87.1 will be accepted as affording adequate eye protection in the laboratory. Otherwise, goggles meeting these standards must be worn at all times.

CH 1010. MOLECULARITY.*Cat. I*

The theme of CH 1010 is the idea of molecularity: that all matter in the universe is composed of atoms bonded together in a limited number of ways. Molecularity is one of a small number of fundamental themes of chemistry (and of all science); it is important for us to address it immediately because it permeates all of chemistry.

Specific concepts that we will discuss are presented below.

- Introduction to the Molecular View
- Structures of Simple Molecules
- Types of Compounds: The Periodic Table
- Chemical Calculations
- Types of Reactions
- The Quantum Structure of the Atom

CH 1020. FORCES AND BONDING.*Cat. I*

The theme of CH 1020 is forces and bonding. We will examine the origin and strength of electrical forces within molecules (covalent bonds), between positive and negative ions in a lattice (ionic bonds), and between atoms or molecules of a pure substance (intermolecular forces). Energy changes accompanying the rupture or formation of such bonds will be discussed.

Specific concepts that we will discuss are presented below.

- Molecular Structure and Shape
- Gases
- Solids
- Intra- and Intermolecular Forces
- Liquids
- Energy (First Law of Thermodynamics)

CH 1030. EQUILIBRIUM.*Cat. I*

The theme of CH 1030 is equilibrium. We will examine the nature of dynamic equilibrium at the molecular level, and will develop an understanding of the mathematical aspects of equilibrium. Phase equilibrium, further aspects of thermodynamics (entropy, free energy), equilibrium of chemical reactions in the gas phase, and equilibrium of chemical reactions in solution will be discussed.

Specific concepts that we will discuss are presented below:

- Phase Equilibrium
- Chemical Equilibrium of Gas Phase Reactions
- Solutions
- Chemical Equilibrium of Reactions in Solution
- Entropy and Free Energy

CH 1040. DYNAMICS.*Cat. I*

The theme of CH 1040 is dynamics. We will examine the nature of molecular motions and their interaction with light, which provides us with all of our structural information about molecules. Various types of molecular spectroscopy will be discussed. Then we will turn to the dynamics of interactions between molecules, examining the rates of chemical reactions, and discussing the detailed molecular pathways by which they occur.

Specific concepts that we will discuss are presented below.

- NMR Spectroscopy
- Vibrational Spectroscopy
- Electronic Spectroscopy
- Dynamics of Physical Processes (Diffusion, phase changes, phase distribution)
- Dynamics of Chemical Processes

ORGANIC CHEMISTRY COURSES

CH 2310. ORGANIC CHEMISTRY I.*Cat. I*

A systematic survey of the major reaction types and functional groups in organic chemistry. The course will provide a representative collection of characteristic reactions and transformations of a variety of types of organic molecules. Most of the examples will be drawn from aliphatic chemistry. Some theoretical models will be introduced with a view toward establishing a general overview of the material.

The course is intended for chemists, chemical engineers, pre-medical students and all those interested in the biosciences. A familiarity with the material presented in the general chemistry courses is assumed.

CH 2320. ORGANIC CHEMISTRY II.*Cat. I*

Modern theories of aromaticity, including a general assessment of delocalized bonding. The chemistry of some significant functional groups not surveyed in Organic Chemistry I, and the meaning of acidity and basicity in organic chemistry, will be more fully explored. The course will provide an introduction to the systematic synthesis of polyfunctional organic compounds.

Recommended background: CH 2310. The course is intended for chemists, chemical engineers and bio-science majors.

CH 2330. ORGANIC CHEMISTRY III.*Cat. I*

The course will continue the coverage of aromatic chemistry. New topics to be introduced include the chemistry of heterocycles, carbohydrates, amino acids and lipids. Particular attention will be paid to naturally occurring polymers such as polysaccharides, proteins and nucleic acids, as well as to industrial polymers.

This course is concerned with the physical and chemical properties of biomolecules, but not their biochemical behavior. It is therefore a good preparation for but distinctively different from CH 4110.

Recommended background: CH 2310 and CH 2320 topics.

The course is intended for biochemists, chemists, chemical engineers and bio-science majors.

CH 2360. ORGANIC LABORATORY.*Cat. I*

Laboratory experience in the preparation and characterization of organic substances. The course will also contain sufficient training in laboratory technique and data handling so that no previous laboratory experience beyond that of general chemistry will be assumed. (To be taken concurrently or following studies in organic chemistry.) Recommended for chemical engineers, pre-medical students, BB majors, and other nonchemists desiring chemical laboratory experience. One lecture and three three-hour labs.

EXPERIMENTAL CHEMISTRY SEQUENCE

The following four courses provide a full-year laboratory program. The purpose of this sequence is to train students in the most essential laboratory techniques, procedures and instrumentation of experimental chemistry. It aims to develop the skills needed for effective work on future chemical laboratory projects such as the Major Qualifying Project. The work of the year develops sequentially.

CH 2640. EXPERIMENTAL CHEMISTRY I: INSTRUMENTAL ANALYSIS.

Cat. I
This laboratory course focuses on the application of modern instrumental methods of analysis to chemical, biochemical and environmental problems. Practical experience is gained in quantitative ultraviolet-visible spectrophotometry, bioluminescence, high performance liquid chromatography, and capillary electrophoresis. Generally, after a set exercise to illustrate the capabilities and use of a particular instrument, student teams select a chemical, biochemical or environmental problem of interest to them, formulate an approach, conduct the analysis, and present their findings to the class.

Recommended background: CH 1010-CH 1040.

CH 2650. EXPERIMENTAL CHEMISTRY II.

Cat. I
The experiments to be performed this term have been chosen to illustrate important principles and experimental techniques of physical chemistry. Students will gain experience with many of the instruments that they are likely to use in any chemical laboratory setting. These include optical spectrometers, vacuum lines, electrochemical cells and the bomb calorimeter.

Recommended background: CH 2640 and CH 3510.

CH 2660. EXPERIMENTAL CHEMISTRY III.

Cat. I
The emphasis in CH 2660 is on basic techniques essential for the synthesis, isolation, and characterization of inorganic and organic compounds. These include isolation and purification by solvent extraction, crystallization, distillation, and chromatographic techniques, followed by the determination of physical properties and characterization by infrared and nuclear magnetic resonance spectroscopy. Micro-synthetic procedures are introduced. Mastery of the techniques and manipulations emphasized in CH 2640 and CH 2650 would be advantageous.

CH 2670. EXPERIMENTAL CHEMISTRY IV.

Cat. I
The synthesis, isolation, and characterization of inorganic compounds are emphasized. Syntheses of main group compounds, classical transition metal complexes, and organotransition metal compounds are included. In addition to reinforcing and building on standard techniques of synthesis and characterization, several new techniques are introduced: synthesis under inert atmosphere, measurement of magnetic susceptibility by NMR, and cyclic voltammetry. Some exposure to ^{13}C NMR is also provided. The final experiment of the course requires the student to design a synthesis for a compound selected from a list provided, based on strategies learned in the course.

INORGANIC AND PHYSICAL CHEMISTRY COURSES

CH 3410. PRINCIPLES OF INORGANIC CHEMISTRY.

Cat. I
This course offers a unique approach to the descriptive chemistry of the elements. The Lewis acidity of positive centers is the starting point for the development of a series of ideas that includes Bronsted acidity, solubility, and the properties of the oxides of the elements. Redox properties are discussed in terms of Pourbaix diagrams. The often-complex structures of the oxides and halides of the elements are rationalized in terms of radius of the "cation" and "anion". The Lewis acid-base concept is extended in discussions of coordination compounds and the theory of hard and soft acids and bases. Finally, the descriptive chemistry of the compounds of the elements with halogens, sulfur, and nitrogen are discussed.

CH 3510. CHEMICAL THERMODYNAMICS.

Cat. I
The content of this course will be the development of the principles of classical thermodynamics. The laws of thermodynamics will be developed by using a series of increasingly complex model systems and a universal equation of state is formulated which incorporates the relationships illustrated by these model systems. Using this equation it will be possible to appreciate that thermodynamic laws are applicable to all systems of matter, regardless of their complexity. Finally, the principles developed are applied to problems of a chemical nature, focusing on predicting the spontaneity of chemical reactions.

The material in this course will be of greatest interest to those students enrolled in the basic sciences including biology, chemistry, and physics, and in applied fields such as chemical engineering, materials science and biotechnology.

Recommended background: Students should be familiar with the material covered in the freshman general chemistry and math sequences. Familiarity with differential equations would be an asset.

CH 3530. QUANTUM CHEMISTRY.

Cat. I
An introduction to quantum mechanics with applications to atomic and molecular species. The course will be developed systematically beginning with the postulates of quantum mechanics. The Schroedinger equation will be applied to systems such as the particle in a box, the rigid rotor, the harmonic oscillator and the hydrogen atom. Emphasis will be given to a quantum mechanical description of multielectron atoms, molecular bonding and spectroscopy.

Recommended background: a solid foundation in elementary physics and calculus.

This course is normally for students in their third year.

CH 3550. CHEMICAL DYNAMICS.

Cat. I
This course deals in a general way with the interactions between energy and molecules, and considers how energetic and structural considerations affect the outcome of molecular interactions. The manipulation of kinetic data and results is stressed. Selected topics from both organic and inorganic chemistry are analyzed in terms of reaction thermodynamics, rates and mechanisms.

Students are expected to be familiar with thermodynamics, equilibria, reaction rates and the Periodic Table of the elements.

The following three courses, CH 4110, CH 4120, and CH 4130, are a three-term sequence intended to provide a strong emphasis in biochemistry. As background for this sequence, CH 1010, CH 1020, CH 1030, CH 1040, CH 2310, CH 2320, and CH 2330, or their equivalents, are recommended.

BIOCHEMISTRY COURSES

CH 4110. BIOCHEMISTRY I.

Cat. I
The principles of protein structure are presented. Mechanisms of enzymatic catalysis, including those requiring coenzymes, are outlined in detail. The structures and biochemical properties of carbohydrates are reviewed. Bioenergetics, the role of ATP, and its production through glycolysis and the TCA cycle are fully considered.

Recommended background: CH 2310, CH 2320.

Suggested background: CH 2330.

CH 4120. BIOCHEMISTRY II.

Cat. I
Oriented around biological membranes, this course begins with a discussion of electron transport and the aerobic production of ATP followed by a study of photosynthesis. The study of the biosynthesis of lipids and steroids leads to a discussion of the structure and function of biological membranes. Finally the membrane processes in neurotransmission are discussed.

Recommended background: CH 4110.

CH 4130. BIOCHEMISTRY III

Cat. I
This course presents a thorough analysis of the biosynthesis of DNA (replication), RNA (transcription), and proteins (translation) and of their biochemical precursors. Proteins and RNAs have distinct lifetimes within the living cell; thus the destruction of these molecules is an important biochemical process that is also discussed. In addition to mechanistic studies, regulation of these processes is covered.

Students who have received credit for CH 4130 or BB 4910 prior to Term A 2000 may not receive credit for the other course.

CH 4150. EXPERIMENTAL BIOCHEMISTRY.

Cat. I
The experiments in this laboratory course have been designed to acquaint the students with the basic skills necessary to perform biochemical studies. The course will cover, for instance, protein purification from different biological sources, subcellular fractionation, enzyme kinetics (K_m , V_{max} , Hill coefficient; specific activity, effector-protein interaction, etc.), exclusion and ion exchange chromatography, electrophoresis and immunodetection.

Recommended background: CH 4120.

CH 4160. MEMBRANE BIOPHYSICS.

Cat. II
This course will focus on different areas of biophysics with special emphasis on membrane phenomena. The biomedical-biological importance of biophysical phenomena will be stressed. The course will begin with the introduction of the molecular forces relevant in biological media and subsequently develop the following topics: Membrane Structure and Function; Channels, Carriers and Pumps; Nerve Excitation and related topics; and Molecular Biophysics of Motility.

Recommended background: prior knowledge of Biochemistry (CH 4110, CH 4120), Mechanics (PH 1110) and Electricity (PH 1120).

This course will be offered in 2003-04 and in alternating years thereafter.

CH 4190. REGULATION OF GENE EXPRESSION*Cat. I*

This course will cover the biochemical mechanisms involved in regulation of gene expression, modifications of DNA structures that influence transcription rates, transcriptional regulation by protein binding, post-transcriptional modifications of RNA including splicing and editing, regulation of translation including ribosome binding and initiation of translation, and factors that control the half-lives of both mRNA and protein. During the course, common experimental methods will be explored, including a discussion of the information available from each method.

Recommended background CH 4110, CH 4120, CH 4130, BB 4010

ADVANCED CHEMISTRY COURSES**CH 4330. ORGANIC SYNTHESIS.***Cat. II*

A discussion of selected modern synthetic methods including additions, condensations and cyclizations. Emphasis is placed on the logic and strategy of organic synthesis. This course is intended to follow CH 2330.

Recommended background: CH 2310, CH 2320, and CH 2330.

This course will be offered in 2004-05 and in alternating years thereafter.

CH 4420. INORGANIC CHEMISTRY II.*Cat. II*

Complexes of the transition metals are discussed. Covered are the electronic structures of transition metal atoms and ions, and the topological and electronic structures of their complexes. Symmetry concepts are developed early in the course and used throughout to simplify treatments of electronic structure. The molecular orbital approach to bonding is emphasized. The pivotal area of organotransition metal chemistry is introduced, with focus on complexes of carbon monoxide, metal-metal interactions in clusters, and catalysis by metal complexes.

Recommended background: CH 1010 - CH 1040, CH 2640 - CH 2670, CH 3410, CH 3530, and CH 3550.

This course will be offered in 2004-05 and in alternating years thereafter.

CH 4520. CHEMICAL STATISTICAL MECHANICS.*Cat. II*

This course deals with how the electronic, translational, rotational and vibrational energy levels of individual molecules, or of macromolecular systems, are statistically related to the energy, entropy, and free energy of macroscopic systems, taking into account the quantum mechanical properties of the component particles. Ensembles, partition functions, and Boltzmann, Fermi-Dirac, and Bose-Einstein statistics are used. A wealth of physical chemical phenomena, including material related to solids, liquids, gases, spectroscopy and chemical reactions are made understandable by the concepts learned in this course.

Recommended background: CH 3510 and CH 3530, or equivalent, and mathematics through differential and integral calculus.

This course will be offered in 2003-04 and in alternating years thereafter.

CH 4550. POLYMER CHEMISTRY.*Cat. II*

Fundamentals of polymer science and technology based on organic polymers. The principal mechanisms of polymerization including radical, ionic and condensation, are covered in detail. Characterization of polymers by physical means. Mechanical behavior including bulk and solution properties of polymers. Polymer syntheses and modifications including block and graft copolymerization.

Structure, property and end use applications of plastic materials. Plastics processing, testing and technology. Survey of commodity plastics as well as engineering resins including their applications and economic considerations. Presentation of trade and technical literature in the field.

Recommended background: CH 2310 and CH 2320 or equivalent.

This course will be offered in 2004-05 and in alternating years thereafter.

GRADUATE CHEMISTRY COURSES OF INTEREST TO UNDERGRADUATES**CH 501. CHEMISTRY OF THE MAIN GROUP ELEMENTS.**

An advanced course in recent developments in selected areas if the chemistry of the elements other than transition metals. Topics covered may include electron deficient compounds and main group organometallics; the preparation, reactions and physical properties of these compounds.

CH 502. BIOINORGANIC CHEMISTRY.

This graduate course addresses current topics in bioinorganic chemistry, with emphasis on the structure and function of metalloenzymes of d-block metal ions. Active site structures of myoglobin and hemoglobin, blue copper proteins and hemocyanin, iron-sulfur cluster proteins, and the nitrogenase enzyme are discussed. The applications of a variety of physical methods (including electronic absorption spectroscopy, FTIR, multinuclear NMR, EPR, Resonance

Raman spectroscopy, EXAFS, and electrochemical methods) to the elucidation of metalloprotein structure/function are discussed.

Recommended background: Knowledge of the fundamental concepts and theories of d-metal chemistry and of various spectroscopic methods.

CH 516. CHEMICAL SPECTROSCOPY.

Advanced topics in identification of organic species and determination of molecular structure by spectroscopic methods.

Methods covered include ^1H - and ^{13}C -NMR, mass spectrometry and infrared and UV-visible spectroscopy. This course is concerned only with interpretation of spectra and does not cover techniques obtaining them; there is no laboratory.

CH 533. PHYSICAL ORGANIC CHEMISTRY.

Mechanics of representative organic reactions, and the methods used for their evaluation. Structural, electronic, and stereochemical influences on reaction mechanisms are explored. Emphasis is on the various techniques used to obtain insights into mechanisms, and on the interplay of data and interpretation.

CH 534. ORGANIC PHOTOCHEMISTRY.

Introduction to the photophysical and photochemical consequences of light absorption by molecules. Experimental techniques, excited state description, photochemical kinetics and energy transfer are among the topics discussed in relation to the primary photochemical reactions in simple and complex molecules.

CH 538. MEDICINAL CHEMISTRY.

This course will focus on the medicinal chemistry aspects of drug discovery from an industrial pharmaceutical Research and Development perspective. Topics will include Chemotherapeutic Agents (such as antibacterial, antiviral and antitumor agents) and Pharmacodynamic Agents (such as antihypertensive, antiallergic, antiulcer and CNS agents).

Recommended background: CH 2310, CH 2320, and CH 2330.

CH 539. MOLECULAR PHARMACOLOGY.

The course will begin with a review of human physiology emphasizing the endocrine, nervous, and lymphatic systems, and including a discussion of the psychoneuroimmunology controversy. Understanding communication between cells requires study of the variety of chemical messengers, their storage, release, action on their target receptors, and eventual fate. This study will include discussion of the location and nature of the variety of receptors. Understanding the effects of messengers necessitates a detailed study of the molecular structure and function of ion channels which will include an application to the nerve impulse. Intercellular and intracellular communication are brought together by a discussion of the molecular mechanisms of receptor-effector coupling. The molecular structures of the acetylcholine receptor and of rhodospin will be used as illustrations. The concepts of agonist and antagonist will be reinforced by a discussion of selected drugs. Nonreceptor blocking will be illustrated in a study of local anesthesia. Study of the neuroactive peptides will lead to a discussion of drug addiction and alcoholism as receptor mediated pathologies. A segment on the role ion cotransport systems play in bodily regulation will include an analysis of the molecular action of the loop diuretics as another example of nonreceptor blockers. This course is designed to compliment the "Medicinal Chemistry" course and will emphasize general principles and the underlying molecular structures.

Recommended background: knowledge of the material covered in one of the following is recommended: (a) CH 4110 and CH 4120, or (b) CH 538 plus an understanding of protein and membrane structures.

CH 552. STATISTICAL MECHANICS.

Application of the results of the quantum theory to achieve an atomistic physical understanding of the common thermodynamic variables. Maxwell-Boltzmann, Fermi-Dirac, and Bose-Einstein distribution functions are defined using the concepts of phase space and the exclusion principle, and the thermodynamic functions are developed in terms of the distribution functions. Application of the partition function and the theory of fluctuations to common physical systems.

CH 554. MOLECULAR MODELING.

This course is intended to train students in the area of molecular modeling using a variety of quantum mechanical and force field methods. The approach will be towards practical chemists who want to answer specific questions about molecular geometry, transition states, reaction paths, and photoexcited states. No experience in programming is necessary; however, a background at the introductory level in quantum mechanics is highly desirable. Methods to be explored include Extended Huckel Theory, Molecular Mechanics, Semiempirical Molecular Orbital Methods, Ab initio and DFT Methods, Graphical Display of Molecules.

CH 555. ADVANCED TOPICS.

A course of advanced study in selected areas whose content and format to suit the interest and needs of faculty and students.

CH 556. EXPERIMENTAL PHOTOCHEMISTRY.

This course has been designed to illustrate how modern spectroscopic techniques can be used to learn more about the photo-induced chemistry of organic materials. The principles of time-resolved and steady-state spectroscopic methods will be described in lectures and then applied in the laboratory to a variety of chemical systems. The aim will be to show how it is possible to fully describe the ground and excited state photochemical behavior of a chemical system using these techniques. Aspects of the following techniques will be covered:

Florescence emission spectroscopy, including solvent effects, quantum yields, quenching behavior, singlet lifetime determinant, excited singlet state energies and the origin of temperature dependence.

Phosphorescence emission spectroscopy, including triplet state energies, distinguishing between $n\pi$ and π excited states.

Laser-flash photolysis, including generation, detection and identification of transient reaction intermediates, quenching, sensitization, triplet state lifetimes, properties of free radicals and other photochemically-generated reactive species, and the consequences of multiple photon excitation.

Steady-state irradiation coupled with end product analysis and how these studies compliment time-resolved measurement.

Students will gain hands-on experience with the use of UV-visible absorption and fluorescence emission spectrometers as well as the laser flash photolysis research proposal based on one or more of the techniques used.

Although there is no formal requirement for this course, some background and an interest in photochemistry would be an asset.

CIVIL AND ENVIRONMENTAL ENGINEERING

CE 1030. CIVIL ENGINEERING AND COMPUTER FUNDAMENTALS.

Cat. I

This course introduces students to basic fundamentals of civil engineering, group dynamics, oral presentation skills, engineering report writing techniques, and uses of the computer. Basics of structural engineering, geotechnical engineering, environmental engineering, surveying, materials, and construction engineering and management are presented in this course through a collaborative group teaching approach. Background is provided to gain competence in operating systems, editors, and spreadsheets. Student groups complete weekly computer laboratory projects and develop oral presentations and written reports.

No previous computer use skills are required or assumed. This course is recommended for freshman or sophomore students.

CE 2000. ANALYTICAL MECHANICS I.

Cat. I

This fundamental civil engineering course provides an introduction to the analysis of structures in static equilibrium. The focus of this course is a classical analysis of concurrent and non-concurrent equilibrium. A variety of engineering problems including trusses, machines, beams, rigid frames, and hydraulic structures involving concentrated and distributed loading systems are analyzed for external reactions and internal forces.

CE 2001. ANALYTICAL MECHANICS II.

Cat. I

This course provides an introduction to the relationship between analysis, design, and the behavior of materials under load. Theory and applications are developed that utilize simple and combined stress-strain behavior of members subjected to axial, torsional, and flexural loadings, with applications to beams, trusses, rigid frames, shafts, and tension and compression structures.

Recommended background: CE 2000.

CE 2002. INTRODUCTION TO ANALYSIS AND DESIGN.

Cat. I

This course develops an understanding of classical and modern structural analysis. Topics include loading systems, and the analysis of statically determinate and statically indeterminate beams, frames, trusses, structural floor systems for buildings, bridges, and other structural assemblies.

Recommended background: CE 2000 and CE 2001.

Suggested background: CE 1030.

CE 2020. SURVEYING.

Cat. I

This course develops fundamental skills in the theoretical and practical aspects of plane surveying through the use and care of modern instruments and the associated computations. Topics include the classification of errors incurred in observed field data and necessary correction applications, the use and care of surveying equipment, traversing, differential leveling, stadia and mapping, and electronic data transfer. Computer applications are used where appropriate.

CE 3006. DESIGN OF STEEL STRUCTURES.

Cat. I

This course covers the theory and practice of structural steel design. The structural design process for beams, columns, trusses, frames, and connections is based on Load and Resistance Factor Design (LRFD) specifications of the American Institute of Steel Construction.

Recommended background: CE 2002 and CE 3010.

Suggested background: CE 1030.

CE 3008. DESIGN OF REINFORCED CONCRETE STRUCTURES.

Cat. I

This course covers the theory and practice of reinforced concrete design. The structural design process for beams, columns, slabs, frames, flat slabs, footings, and retaining walls uses the ultimate strength design codes of the American Concrete Institute.

Recommended background: CE 2002 and CE 3010.

Suggested background: CE 1030.

CE 3010. STRUCTURAL ENGINEERING.

Cat. I

This course provides an understanding of the practice of structural engineering. It builds upon the fundamental skills developed in CE 2000, CE 2001, and CE 2002 to present the principles of structures and their elements. The course provides a perspective for dealing with the issues of strength, stiffness, and stability. Although wood is the principle material used to develop the study of the interrelationship between analysis and design of structural systems, structural steel and reinforced concrete systems are also discussed. It also introduces students to the use of building codes for design criteria. The role of the structural engineer in the design process and cost factors are also discussed.

Recommended background: CE 2000, CE 2001, and CE 2002.

Suggested background: CE 1030.

CE 3020. PROJECT MANAGEMENT.

Cat. I

This course presents the fundamental concepts and process of project management applied to public and private works. The principle focus of the course is the management of civil engineering projects including planning, scheduling, organization and control, as well as management concepts of leadership, motivation, trust, project team development, division of work, and conflict resolution. Ancillary engineering and construction practices involving financial practices, construction documents, contract negotiation and administration, quality and safety control, insurance and bonding are covered.

Recommended background: CE 1030.

CE 3021. COST ESTIMATING, SCHEDULING AND PROJECT CONTROL.

Cat. II

This course presents the fundamental concepts and processes by which the cost and time of execution of civil engineering projects are established. It emphasizes the importance of decisions made at the early stages of design on final project cost. The relationship between time and cost is examined in detail. Topics include: construction methods, quantity surveying, resource pricing, activity planning, resource allocation, financial analysis, bidding, job cost accounting and cost control with extensions to operating and maintenance costs. Commercial software for project scheduling, cost estimating, and cost control is used in this course.

Recommended background: CE 1030 and CE 3020.

Offered in 2004-05 and in alternating years thereafter.

CE 3022. LEGAL ASPECTS IN DESIGN AND CONSTRUCTION.

Cat. II

This course addresses legal aspects that underpin the planning, design and construction of a project. The principle focus is the contracts, laws, specifications, and design documents needed to conduct civil engineering practice in the United States. Labor, safety, and environmental laws are reviewed, as well as the role of ethics and professional relationships with the client, other professional organizations and groups, the public, and the regulatory system.

Recommended background: CE 3020.

Offered in 2003-04 and in alternating years thereafter.

CE 3023. ARCHITECTURAL ENGINEERING SYSTEMS.

Cat. I

This course introduces the fundamental concepts associated with the design and construction of a building. Major building components, such as foundations, structures, envelopes and environmental systems are presented as subsystems to be integrated. The systems approach is utilized to describe the functional interdependence of building components and the interdisciplinary nature of the design of contemporary buildings. Building components are analyzed in terms of design details and constructability implications. AutoCAD representation and building design exercises as well as case studies are used to illustrate the topic.

CE 3024. CONTROL SURVEYING.

Cat. II

This course presents the principles and field procedures required in the design of vertical and horizontal control networks for large building and construction projects.

Recommended background: CE 2020.

Offered in 2004-05 and in alternating years thereafter.

CE 3026. MATERIALS OF CONSTRUCTION.*Cat. I*

This course provides an understanding of the use and acquisition of engineering properties of construction materials. Topics include relationships between the structure of materials, their engineering properties, and the selection of suitable materials for applications involving strength, durability, and serviceability. Experimental laboratory procedures including design of experiments, data collection, analysis, and representation, and report writing are an integral part of the work.

Recommended background: CE 1030 and CE 2001.

CE 3030. FUNDAMENTALS OF CIVIL ENGINEERING AUTOCAD.*Cat. I*

This course introduces Civil Engineering students to fundamental uses of the AutoCAD software package. Basic two dimensional drawing techniques are covered. Advanced topics that may be covered include three dimensional drawing, rendering and animation. Students are required to become familiar with AutoCAD.

Knowledge of the subject matter in at least two civil engineering design courses is expected background for this course.

CE 3041. SOIL MECHANICS.*Cat. I*

This is an introductory course dealing with the science and technology of earth materials with an emphasis on fundamental concepts of particulate mechanics. The topics which are discussed include fluid flow through porous media, deformation and shear characteristics of soil, consolidation, lateral earth pressure, and slope stability.

Recommended background: CE 2000 and CE 2001.

Suggested background: GE 2341.

CE 3044. FOUNDATION ENGINEERING.*Cat. I*

Foundation engineering is a study of the applications of the principles of soil mechanics and structural theory to the analysis, design and construction of foundations for engineering works with the emphasis on the soil engineering aspects of soil structure interaction. Subsurface exploration techniques, design of rigid and flexible retaining structures, and design of, shallow and deep foundations are considered. Although the course deals mainly with aspects of the design of buildings and bridges, certain parts of the course (design of temporary trench bracing, for example) are very relevant to construction engineering.

Recommended background: CE 3041.

Suggested background: CE 3008.

CE 3050. INTRODUCTION TO TRANSPORTATION ENGINEERING.*Cat. I*

This course provides an introduction to the field of transportation engineering with particular emphasis on traffic engineering and highway design. Topics covered include a description of the transportation industry and transportation modes; characteristics of drivers, pedestrians, vehicles and the roadway; traffic engineering studies, highway safety, principles of traffic flow, intersection design and control, capacity analysis, level of service analysis; geometric design of highways; paving materials and pavement design.

Suggested background: CE 2020.

CE 3051. INTRODUCTION TO PAVEMENT MATERIALS, DESIGN AND MANAGEMENT.*Cat. I*

This course provides an introduction to concepts required for design construction and management of pavements. Topics include Highway Drainage, Soil Engineering for Highway Design, Bituminous Materials, Design of Flexible and Rigid Pavements and Pavement Management. Knowledge of the subject matter in CE 3050 is helpful but not required.

CE 3054. ASPHALT TECHNOLOGY.*Cat. I*

This laboratory-based course introduces the field of asphalt technology, provides an understanding of characterization tests for hot mix asphalt and understanding of production of hot mix asphalt, illustrates typical problems of hot mix asphalt pavements, and helps in developing an interest in asphalt technology. Instruction is provided through lecture, laboratory work and field trips. Students work in groups for preparation of laboratory reports and a term project.

Recommended background: CE 1030 and CE 2001.

CE 3059. ENVIRONMENTAL ENGINEERING.*Cat. I*

This is an introductory course in the area of environmental engineering. The course should also be of interest to students who require an overall understanding of environmental engineering problems. Topics covered include: environmental impact of population growth and energy demand, water resources, water chemistry, water quality standards, environmental microbiology, wastewater characteristics, receiving water quality and dissolved oxygen budgets, water pollution abatement, sludge management, solids and hazardous waste management, and an introduction of air and noise pollution.

Recommended background: CH 1010 and CH 1020 or equivalent.

CE 3060. WATER TREATMENT.*Cat. I*

This course provides in-depth coverage of processes used in water treatment. Topics include: review of water chemistry and drinking water standards, impurities in natural waters, aeration, water softening coagulation, flocculation, sedimentation, filtration, disinfection, taste and odor control, corrosion control, and iron and manganese removal.

Recommended background: CE 3059 and ES 3004.

CE 3061. WASTE WATER TREATMENT.*Cat. I*

This course provides in-depth coverage of processes used in wastewater treatment. Topics include: review of water quality standards, wastewater characteristics, application of biochemical oxygen demand, sources and effects of pollution, physical, chemical, and biological wastewater treatment processes, and waste sludge management.

Recommended background: CE 3059 and ES 3004.

CE 3062. HYDRAULICS IN CIVIL ENGINEERING.*Cat. I*

This course provides a basic background for designing hydraulic systems used in water supply and wastewater transport systems. It is a basic course for students in the sanitary engineering and water resources area. Topics include open channel flow, pipe flow, pumps, sewer design and water supply network design.

Recommended background: ES 3004.

CE 3070. URBAN AND ENVIRONMENTAL PLANNING.*Cat. I*

This course introduces to the student the social, economic, political, and environmental factors that affect the population growth and distribution patterns, and the impact of such patterns to the natural environment. By using the principles and procedures of planning, the optimal growth pattern may be examined, and the infrastructure (roads, water supply systems, waste-water treatment systems, shopping malls, etc.) necessary to support present and future growth patterns may be determined.

The information necessary in planning, which involves conscious procedures of analysis, formulation of alternative solutions, rational assessment and deliberate choice in accordance with evaluation criteria, is obtained through extensive reading. As such the course introduces a variety of topics of concern to engineers and environmentalists. The course is intended not only for civil engineering majors, but also for students preparing for an IQP in areas of urban or environmental concerns.

CE 3074. ENVIRONMENTAL ANALYSIS.*Cat. I*

This course provides a background in the principles and techniques of assessing areas of natural environment and the application of this assessment to evaluate the inherent suitability for urban and resource based uses and facilities. The techniques developed in this course will be useful for land use planning, site design, and the impact of engineering projects on the environment.

Suggested background: CE 3070.

CE 4007. MATRIX ANALYSIS OF STRUCTURES.*Cat. I*

This course presents the principles of matrix analysis of structural elements and systems; fundamentals of matrix algebra, solution of simultaneous equations, matrix inversion; analysis of plane trusses, method of joints; displacement method, principle of virtual work, analysis of continuous beams, analysis of plane frames, plane trusses, analysis of building frames and bridges; computer aided structural analysis and principles of software development.

Recommended background: CE 2002.

CE 4017. PRESTRESSED CONCRETE DESIGN.*Cat. I*

This course covers analysis and design aspects of prestressed concrete structural elements and systems: principles of prestressing, materials for prestressing, high strength steel, flexural analysis and design methods; allowable stress and strength design methods; design of beams, load balancing, partial prestressing and cracking moment; design for shear, partial loss of prestress; deflections of prestressed concrete and precast construction; connections.

Recommended background: CE 2002 and CE 3026.

Suggested background: CE 3008.

CE 4024. REAL ESTATE DEVELOPMENT.*Cat. II*

This course introduces real estate development with an emphasis on the decision-making process from initial concept to final acceptance; organizations, and professions in the development process; time frame for development; capital and operating budget construction; debt and equity finance; principle of planning, scheduling and managing the process.

Suggested background: CE 3020.

Offered in 2003-04 and in alternating years thereafter.

CE 4046. EXPERIMENTAL SOIL MECHANICS.*Cat. II*

The standard laboratory soil testing procedures generally encountered in civil engineering are introduced in this course. It further includes a limited discussion of soil behavior primarily based on the effect of soil's physical and chemical properties on laboratory test results. The tests which are performed include: grain size analysis, Atterberg limits, specific gravity, permeability, compaction, compression and consolidation, and direct and triaxial shear. The student's results of the various tests are integrated within an engineering problem.

Recommended background: CE 3041.

Offered in 2004-05 and in alternating years thereafter.

CE 4048. EARTH STRUCTURES.*Cat. II*

This course provides in-depth study of the geotechnical principles applied to design earth structures including earth dams, waste containment facilities, soil slopes, highway cuts and embankments, and slurry trenches. It includes fundamentals of analysis of flow through porous media by graphical and digital techniques, slope stability, use of geosynthetics, soil stabilization and the design of preloads and drain installations.

Recommended background: CE 3041.

Offered in 2003-04 and in alternating years thereafter.

CE 4060. ENVIRONMENTAL ENGINEERING LABORATORY.*Cat. I*

This course familiarizes students with the laboratory studies used to obtain the design parameters for water and wastewater treatment systems. The topics include laboratory experiments dealing with physical, chemical, and biological treatment systems.

Recommended background: CE 3060 and CE 3061.

CE 4061. HYDROLOGY.*Cat. I*

This course provides a quantitative description of the rainfall and runoff process for use in design of water resource related projects. Topics include: the review of the hydrologic cycle, precipitation, evaporation, transpiration, infiltration, stream flow measurements, flow routing, runoff analysis, show hydrology and development of drainage estimates for development plans. The course involves a stream measurement laboratory and application of model for hydrological and hydraulic engineering applications.

Recommended background: ES 3004.

CE 4071. LAND USE DEVELOPMENT AND CONTROLS.*Cat. I*

The purpose of this course is to provide an understanding of how land use controls may be used to effectively shape our physical, social, and economic development. The quality of our environment depends upon the development which is permitted to take place and the controls which direct that development. Through this course, the student will learn the principles, methods, and techniques which a planner may use to plan the uses and development of land. In particular, the use and limits of zoning, special permits, hammerhead lots, subdivision control, comprehensive permits, and other tools with which a developer of planner board member should be familiar will be examined in detail.

COMPUTER SCIENCE

CS 1001. INTRODUCTION TO COMPUTERS.*Cat. II*

This course introduces computer systems to students who may need to write or use computer programs in their undergraduate engineering, science, or management courses.

Topics include problem-solving and algorithm development, the program development cycle, structured programming design, coding, debugging and documentation.

Students will be expected to implement a variety of programs using the FORTRAN programming language.

Intended audience: noncomputer science majors desiring a practical introduction to programming. This course is not sufficient background for MQPs or IQPs involving extensive programming or most advanced computer science or computer engineering courses. Such background may be obtained by taking CS 1005 or CS 1006 followed by CS 2005.

Recommended background: none.

This course will be offered in 2004-05 and in alternating years thereafter.

CS 1005. INTRODUCTION TO PROGRAMMING.*Cat. I*

This course introduces structured programming with emphasis on modular design and functional decomposition.

Topics include problem solving and algorithm development, the syntax and semantics of sequential, iterative, and conditional control structures, functions, arrays, pointers, and simple I/O.

Students will be expected to design and implement programs in C++.

Intended audience: computer science and computer engineering students and those students desiring a background in computer programming.

Recommended background: none.

Note: Either CS 1005 or CS 1006 will provide sufficient background for further study in Computer Science, including CS 2005.

CS 1006. OBJECT-ORIENTED INTRODUCTION TO PROGRAMMING.*Cat. I*

This course introduces computer programming, with emphasis on object-oriented programs.

Topics include: Problem solving, algorithm development, and debugging; the syntax and semantics of sequential, iterative, conditional, and recursive control structures; primitive and complex data types; and simple I/O.

Outcomes: Students will be expected to design and implement programs as applications and applets in an object-oriented programming language, such as Java.

Intended audience: All students with little or no programming experience who desire to learn an object-oriented programming language.

Recommended background: None.

Note: Either CS 1005 or CS 1006 will provide sufficient background for further study in Computer Science, including CS 2005.

CS 2005. DATA STRUCTURES AND PROGRAMMING TECHNIQUES.*Cat. I*

This course continues the development of discipline in programming design, style, expression, debugging and testing. It provides sufficient programming background for other 2000, 3000, and 4000 level computer science courses.

Topics include object-oriented programming, abstract data types, dynamic memory allocation, elementary data structures, algorithm analysis, recursion, internal sort/search methods, and step-wise refinement of both functions and data.

Students will be expected to design and implement reasonably large and complex programs in C++. Students will learn how to use appropriate high-level tools for program development.

Intended audience: computer science majors who do not have a strong background in these topics and noncomputer science majors who desire further programming experience or who intend to pursue upper-level computer science courses.

Recommended background: CS 1005 or CS 1006 or its equivalent.

CS 2011. INTRODUCTION TO MACHINE ORGANIZATION AND ASSEMBLY LANGUAGE.*Cat. I*

This course introduces students to the structure and behavior of digital computers at several levels of abstraction. Starting with a high-level view of functional components, the course progresses through the system from the point of view assembly language programming, microprogramming, and logic circuits.

Topics include the functional organization of computer hardware, the functions of assemblers, linkers, and loaders, representations of numbers in computers, basic assembly language instruction sets, addressing modes, stacks and procedures, low-level I/O, concepts and examples of microprogramming, and logic circuits.

Students will be expected to write programs in an assembly language.

Intended audience: computer science and computer engineering students, and those desiring a deeper understanding of the low-level functionality of a computer.

Recommended background: CS 2005.

CS 2022/MA 2201. DISCRETE MATHEMATICS.*Cat. I*

This course serves as an introduction to some of the more important concepts, techniques, and structures of discrete mathematics, providing a bridge between computer science and mathematics.

Topics include functions and relations, sets, countability, groups, graphs, propositional and predicate calculus, and permutations and combinations.

Students will be expected to develop simple proofs for problems drawn primarily from computer science and applied mathematics.

Intended audience: computer science and mathematical sciences majors.

Undergraduate credit may not be earned both for this course and for CS 501.

Recommended background: none.

CS 2135. PROGRAMMING LANGUAGE CONCEPTS.*Cat. I*

This course introduces the student to the fundamental concepts of programming languages, models of programming languages, and the basic concepts of language translation.

Topics include syntactic structure, binding, scope, parameter passing, control structures, and run-time environments. Different programming paradigms will be examined to illustrate these principles.

Students will be expected to acquire competence in functional programming.

Intended audience: computer science and computer engineering students, and those desiring a deeper understanding of computer programming.

Recommended background: CS 2005.

CS 2136. PARADIGMS OF COMPUTATION.*Cat. I*

This course introduces students to advanced concepts in computational systems and programming languages and builds upon the functional approach to programming acquired in CS 2135.

Topics covered include object-oriented programming, logic programming, stream programming, and parallel systems and programming.

Students will be expected to write programs in object-oriented and logic-based programming languages.

Intended audience: computer science and computer engineering students, and those desiring a deeper understanding of advanced computational paradigms.

Recommended background: CS 2135.

CS 2223. ALGORITHMS.*Cat. I*

Building on a fundamental knowledge of data structures, data abstraction techniques, and mathematical tools, a number of examples of algorithm design and analysis, worst case and average case, will be developed.

Topics include greedy algorithms, divide-and-conquer, dynamic programming, heuristics, and probabilistic algorithms. Problems will be drawn from areas such as sorting, graph theory, and string processing. The influence of the computational model on algorithm design will be discussed.

Students will be expected to perform analysis on a variety of algorithms.

Intended audience: computer science and computer engineering students, and those desiring a deeper understanding of algorithm design and analysis.

Undergraduate credit may not be earned both for this course and for CS 507.

Recommended background: CS 2005 and CS 2022.

CS 3013. OPERATING SYSTEMS.*Cat. I*

This course provides the student with an understanding of the basic components of a general-purpose operating system.

Topics include processes, process management, synchronization, input/output devices and their programming, interrupts, memory management, resource allocation, and an introduction to file systems.

Students will be expected to design and implement a large piece of system software.

Intended audience: computer science majors and others interested in studying the software and hardware components of computer systems.

Undergraduate credit may not be earned both for this course and for CS 502.

Recommended background: CS 2005 and CS 2011.

CS 3041. HUMAN-COMPUTER INTERACTION.*Cat. I*

This course develops in the student an understanding of the nature and importance of problems concerning the efficiency and effectiveness of human interaction with computer-based systems.

Topics include the design and evaluation of interactive computer systems, basic psychological considerations of interaction, interactive language design, interactive hardware design, and special input/output techniques.

Students will be expected to complete two projects. A project might be a software evaluation, interface development, or an experiment.

Intended audience: computer science majors, especially juniors.

Recommended background: CS 2005.

CS 3043. SOCIAL IMPLICATIONS OF INFORMATION PROCESSING.*Cat. I*

This course makes the student aware of the social, moral, ethical, and philosophical impact of computers and computer-based systems on society, both now and in the future.

Topics include major computer-based applications and their impact, human-machine relationships, and the major problems of controlling the use of computers.

Students will be expected to contribute to classroom discussions and to complete a number of writing assignments.

Intended audience: students interested in the impact of a computer-oriented technology on his or her future way of life and well-being. This course is highly recommended for juniors.

Undergraduate credit may not be earned both for this course and for CS 505.

Recommended background: a general knowledge of computers and computer systems.

CS 3133. FOUNDATIONS OF COMPUTER SCIENCE.*Cat. I*

This course introduces the theoretical foundations of computer science. These form the basis for a more complete understanding of the proficiency in computer science.

Topics include computational models, formal languages, and an introduction to computability and complexity theory, including NP-completeness.

Students will be expected to complete a variety of exercises and proofs.

Intended audience: computer science majors and others desiring an understanding of the theoretical foundations of computer science.

Undergraduate credit may not be earned both for this course and for CS 503.

Recommended Background: CS 2022 and CS 2223.

Students who have credit for CS 4121 cannot receive credit for CS 3133.

Students graduating under the pre-1996 distribution requirements may satisfy the Theory area requirement by taking this course, although it does not count as a 4000-level course.

CS 3431. DATABASE SYSTEMS I.*Cat. I*

This course introduces the student to the design, use, and application of database management systems.

Topics include the relational data model, relational query languages, design theory, and conceptual data design and modeling for relational database design. Techniques that provide for data independence, and minimal redundancy will be discussed.

Outcome: Students will be expected to design and implement database system applications.

Intended audience: computer science majors and others interested in studying the development of software applications with large data management requirements.

Undergraduate credit may not be earned both for this course and for CS 4431 or CS 542.

Recommended background: CS 2005 and CS 2022.

CS 3733. SOFTWARE ENGINEERING.*Cat. I*

This course introduces software design topics pertinent to the waterfall life cycle model.

Topics include requirements analysis and specification, architectural design, module testing, and system integration.

Student groups will be expected to specify, design, partially implement and test a project.

Intended audience: computer science majors and others who expect to design software systems. This course should be taken before any course requiring a large programming project.

Undergraduate credit may not be earned both for this course and for CS 509.

Recommended background: CS 2005.

CS 4032/MA 3257. NUMERICAL METHODS FOR LINEAR AND NONLINEAR SYSTEMS.*Cat. I*

This course provides an introduction to modern computational methods for linear and nonlinear equations and systems and their applications.

Topics covered include: solution of nonlinear scalar equations, direct and iterative algorithms for the solution of systems of linear equations, solution of nonlinear systems, the eigenvalue problem for matrices. Error analysis will be emphasized throughout.

Recommended background: MA 2071. An ability to write computer programs in a scientific language is assumed.

CS 4033/MA 3457. NUMERICAL METHODS FOR CALCULUS AND DIFFERENTIAL EQUATIONS.*Cat. I*

This course provides an introduction to modern computational methods for differential and integral calculus and differential equations.

Topics covered include: interpolation and polynomial approximation, approximation theory, numerical differentiation and integration, numerical solutions of ordinary differential equations. Error analysis will be emphasized throughout.

Recommended background: MA 2051. An ability to write computer programs in a scientific language is assumed. Undergraduate credit may not be earned for both this course and for MA 3255/CS 4031.

CS 4120. ANALYSIS OF ALGORITHMS.*Cat. II*

This course develops the skill of analyzing the behavior of algorithms.

Topics include the analysis, with respect to average and worst case behavior and correctness, of algorithms for internal sorting, pattern matching on strings, graph algorithms, and methods such as recursion elimination, dynamic programming, and program profiling.

Students will be expected to write and analyze programs.

Intended audience: computer science majors.

Undergraduate credit may not be earned both for this course and for CS 504.

Recommended background: CS 2223 and some knowledge of probability.

This course will be offered in 2004-05 and in alternating years thereafter.

CS 4123. THEORY OF COMPUTATION.*Cat. II*

Building on the theoretical foundations from CS 3133, this course addresses the fundamental question of what it means to be "computable," including different characterizations of computable sets and functions.

Topics include the halting program, the Church-Turing thesis, primitive recursive functions, recursive sets, recursively enumerable sets, NP-completeness, and reducibilities.

Students will be expected to complete a variety of exercises and proofs.

Intended audience: computer science majors and others desiring an understanding of the nature of computation.

Undergraduate credit may not be earned both for this course and for CS 553.

Recommended Background: CS 3133.

This course will be offered in 2004-05 and in alternating years thereafter.

CS 4233. OBJECT-ORIENTED ANALYSIS AND DESIGN.*Cat. II*

This Software Engineering course will focus on the process of Object-Oriented Analysis and Design. Students will be expected to complete a large number of exercises in Domain Modeling, Use Case Analysis, and Object-Oriented Design. In addition, the course will investigate Design Patterns, which are elements of reusable object-oriented software designs. This course will survey a set of design patterns and consider how these patterns are described and used to solve design problems.

Recommended Background: CS 3733.

This course will be offered in 2004-05 and in alternating years thereafter.

CS 4241. WEBWARE: COMPUTATIONAL TECHNOLOGY FOR NETWORK INFORMATION SYSTEMS.*Cat. I*

This course explores the computational aspects of network information systems as embodied by the World Wide Web (WWW). Topics include: languages for document design, programming languages for executable content, scripting languages, design of WWW based human/computer interfaces, client/server network architecture models, high level network protocols (e.g., http), WWW network resource discovery and network security issues.

Students in this course will be expected to complete a substantial software project (e.g., Java based user interface, HTML/CGI based information system, WWW search mechanisms, etc.).

Recommended background: CS 2005.

Suggested background: CS 2136 or CS 3041.

CS 4341. INTRODUCTION TO ARTIFICIAL INTELLIGENCE.*Cat. I*

This course studies the problem of making computers act in ways which we call "intelligent".

Topics include major theories, tools and applications of artificial intelligence, aspects of knowledge representation, searching and planning, and natural language understanding.

Students will be expected to complete projects which express problems that require search in state spaces, and to propose appropriate methods for solving the problems.

Intended audience: computer science majors.

Undergraduate credit may not be earned both for this course and for CS 534.

Recommended background: CS 2136 and CS 2223.

Suggested background: CS 3133.

CS 4432. DATABASE SYSTEMS II.*Cat. II*

This course concentrates on the study of the internals of database management systems.

Topics include: principles and theories of physical storage management, advanced query languages, query processing and optimization, index structures for relational databases, transaction processing, concurrency control, distributed databases, and database recovery, security, client server and transaction processing systems.

Outcome: Students may be expected to design and implement software components that make up modern database systems.

Intended audience: computer science and computer engineering majors.

Undergraduate credit may not be earned both for this course and CS 542.

Recommended background: CS 3431 and knowledge of software engineering, such as CS 3733.

This course will be offered in 2003-04 and in alternating years thereafter.

CS 4513. DISTRIBUTED COMPUTING SYSTEMS.*Cat. I*

This course extends the study of the design and implementation of operating systems begun in CS 3013 to distributed and advanced computer systems.

Topics include principles and theories of resource allocation, file systems, protection schemes, and performance evaluation as they relate to distributed and advanced computer systems.

Students may be expected to design and implement programs that emphasize the concepts of file systems and distributed computing systems using current tools and languages.

Intended audience: computer science and computer engineering majors.

Recommended background: CS 3013 and a knowledge of probability, such as provided by MA 2631.

CS 4514. COMPUTER NETWORKS: ARCHITECTURE AND IMPLEMENTATION.*Cat. I*

This course introduces principles and current trends in computer networks. The ISO Reference Model will be used as the framework with the course progressing through the physical, data link, network, transport, session, and presentation layers with specific examples and standards cited throughout for point-to-point, satellite, packet-radio, and local area networks.

Topics include motivation and objectives of computer networks, overview of network architectures, layered architectures, performance analysis, virtual circuits, datagrams, routing flow control, local area networks, internetworking, end-to-end communication, virtual terminal, file transfer protocols, and client-server programming.

Students will be expected to design and implement projects such as simulation of the network/transport layer functions, routing, congestion control, an Ethernet controller, applications using TCP/IP or remote procedure calls.

Intended audience: computer science and computer engineering majors.

Undergraduate credit may not be earned both for this course and for CS 513.

Recommended background: CS 3013 and some knowledge of probability.

CS 4515. COMPUTER ARCHITECTURE.*Cat. II*

This course explores modern computer architectures in terms of instruction sets and the organization of processors, controllers, memories, devices, and communication links.

Topics include an overview of computer systems, theoretical foundations, modern computer system components, pipelining of instruction sets, multifunction pipelines, parallel computer organization.

Students will be expected to design and implement programs which simulate significant components of modern computer architectures.

Intended audience: computer science and computer engineering majors.

Recommended background: CS 2011 or EE 2801, and CS 3013.

This course will be offered in 2003-04 and in alternating years thereafter.

CS 4533. TECHNIQUES OF PROGRAMMING LANGUAGE TRANSLATION.*Cat. II*

This course studies the compiling process for high-level languages.

Topics include lexical analysis, syntax analysis, semantic analysis, symbol tables, intermediate languages, optimization, code generation and run-time systems.

Students will be expected to use compiler tools to implement the front end, and to write a program to implement the back end, of a compiler for a recursive programming language.

Intended Audience: computer science and computer engineering majors

Recommended Background: CS 2136 and CS 3133.

This course will be offered in 2004-05 and in alternating years thereafter.

CS 4731. COMPUTER GRAPHICS.*Cat. I*

This course studies the use of the computer to model and graphically render two- and three-dimensional structures.

Topics include graphics devices and languages, 2- and 3-D object representations, and various aspects of rendering realistic images.

Students will be expected to implement programs which span all stages of the 3-D graphics pipeline, including clipping, projection, arbitrary viewing, hidden surface removal and shading.

Intended audience: computer science majors.

Undergraduate credit may not be earned both for this course and for CS 543.

Recommended background: CS 2223 and MA 2071.

CS 4732. COMPUTER ANIMATION.*Cat. II*

This course provides an in-depth examination of the algorithms, data structures, and techniques used in modeling and rendering dynamic scenes. Topics include animation hardware and software, parametric blending techniques, modeling physical and articulated objects, forward and inverse kinematics, key-frame, procedural, and behavioral animation, and free-form deformation.

Students will be expected to develop programs to implement low-level animation algorithms as well as use commercial animation tools to design and produce small to moderate sized animations.

Intended audience: computer science majors.

Recommended background: CS 4731.

This course will be offered in 2003-04 and in alternating years thereafter.

ELECTRICAL AND COMPUTER ENGINEERING

The second digit in electrical engineering course numbers is coded as follows:

- 0 — Circuits
- 1 — Fields
- 2 — Electronic Circuits and Systems
- 3 — Signals and Communication Systems
- 4 — Available for Future Use
- 5 — Machines, Power Systems
- 6 — Professional and Miscellaneous
- 7 — Projects, Laboratory, Independent Study
- 8 — Computers
- 9 — Electronic Devices

EE 2011. INTRODUCTION TO ELECTRICAL AND COMPUTER ENGINEERING.

Cat. I

The objective of this course is to expose new electrical engineering students (including first year students) to the broad field of electrical engineering, introducing basic concepts of circuits and systems and their applications. Experiments based on practical devices are used to reinforce basic concepts and develop laboratory skills, as well as to provide system-level understanding. The use of circuit simulation tools for analysis and design is introduced.

Topics: Basic concepts of electrical circuits, linear circuit analysis, op-amp circuits, simple transients, phasor analysis, amplifiers, frequency response, filters.

Recommended background: high school physics, and MA 1022 (concurrent).

EE 2022. INTRODUCTION TO DIGITAL CIRCUITS AND COMPUTER ENGINEERING.

Cat. I

The objective of this course is to expose students (including first year students) to basic electrical and mathematical concepts that underlie computer engineering while continuing an introduction to basic concepts of circuits and systems in a hands-on environment. Experiments representing practical devices introduce basic electrical engineering concepts and skills which typify the study and practice of electrical and computer engineering. In the laboratory, the students construct, troubleshoot, and test analog and digital circuits that they have designed. They will also be introduced to the nature of the interface between hardware and software in a typical microprocessor based computer.

Topics: Sets, functions, Boolean algebra, digital switching logic, the transistor as switch, circuit design of logic gates, design of combinational logic circuits, software and hardware interfacing including analog/digital and digital/analog conversion.

Recommended background: EE 2011 and MA 1022.

EE 2111. PHYSICAL PRINCIPLES OF ECE APPLICATIONS.

Cat. I

In this course students will learn the practical aspects of electromagnetics and their relation to basic DC and AC circuit theory.

The meaning of the electric and magnetic field concepts is explained and placed in context with capacitive and inductive circuits. Exploiting those concepts leads to a host of practical devices such as transformers, motors, and generators. In addition, measures to minimize the influence of stray electric and magnetic fields are analyzed as part of various shielding and grounding strategies.

The electric and magnetic circuit aspects are then presented as linear first order systems in the time and frequency domains. Issues such as time constants, impedance, and superposition are explained in detail. Building upon these basic concepts, second order systems consisting of mixed capacitive and inductive systems are analyzed in terms of their resonance effects. The second order system description will then be applied to develop the basic transmission line theory as required in high-speed digital design.

Recommended background: EE 2011, introductory physics courses such as PH 1120 or PH 1121, MA 1024, MA 2051 (concurrent).

EE 2112. ELECTROMAGNETIC FIELDS.

Cat. I

The object of this course is a comprehensive treatment of electromagnetic engineering principles covering the entire application spectrum from static to dynamic field phenomena.

The starting point will be the basic electric and magnetic field definitions of Coulomb and Biot-Savart leading to Gauss's and Ampere's laws. They form the foundation of electro- and magnetostatics fields. Students will examine capacitive and inductive systems and relate them to lumped element circuit models. By introducing temporal and spatial magnetic flux variations, Faraday's law is established. The engineering implications of this law are investigated in terms of transformer and motor actions. Incorporation of the displacement current density into Ampere's law and combining it with Faraday's law will then culminate in the complete set of Maxwell's field equations. As a result of these equations, students will develop the concept of wave propagation in the time and frequency domain with practical applications such as wireless communication, radar, Global Positioning Systems, and microwave circuits.

Recommended background: EE 2111.

EE 2201. MICROELECTRONIC CIRCUITS I.

Cat. I

This course is the first of a two-course sequence in electronic circuit design. It begins with a substantive treatment of the fundamental behavior of semiconductor materials and moves on to the semiconductor diode, the bipolar transistor, and the field-effect transistor. Laboratory exercises are provided to reinforce the theory of operation of these devices. Numerous circuit applications are considered, including: power supplies, transistor amplifiers, and FET switches.

Topics include: the pn junction, diode operation, transducers, rectification, voltage regulation, limiting and clamping circuits, transistor operation, biasing, small-signal and large-signal models, transistors amplifiers, and switching applications.

Recommended background: EE2011.

EE 2311. CONTINUOUS-TIME SIGNAL AND SYSTEM ANALYSIS.

Cat. I

This course provides an introduction to time and frequency domain analysis of continuous time signals and linear systems. Topics include signal characterization and operations; singularity functions; impulse response and convolution; Fourier series; the Fourier transform and its applications; frequency-domain characterization of linear, time-invariant systems such as filters; and the Laplace transform and its applications.

Recommended background: EE 2011, MA 1022.

Suggested background: MA 2051.

EE 2312. DISCRETE-TIME SIGNAL AND SYSTEM ANALYSIS.

Cat. I

This course provides an introduction to the time and frequency domain analysis of discrete-time signals and linear systems. Topics include sampling and quantization, characterization of discrete-time sequences, the discrete-time Fourier transform, the discrete Fourier transform and its applications, the Z transform and its applications, linear and circular convolution, characterization of FIR and IIR discrete-time systems, and the analysis and design of discrete-time filters. Projects include topics such as sampling and quantization; application of the DFT to signal and system analysis and design; and digital filter design and simulation.

Recommended background: EE 2311.

EE 2799. ELECTRICAL AND COMPUTER ENGINEERING DESIGN.

Cat. I

The goal of this course is to provide experience with the design of a system, component, or process. Basic sciences, mathematics, and engineering sciences are applied to convert resources to meet a stated objective. Fundamental steps of the design process are practiced, including the establishment of objectives and criteria, synthesis, analysis, manufacturability, testing, and evaluation. Student work in small teams and are encouraged to use creativity to solve specific but open-ended problems, and then present their results.

EE 2799 is strongly recommended for all students as a preparation for the design element of the MQP. It is anticipated that EE 2799 will be of most benefit to students when taken well in advance of the MQP (late sophomore year or early junior year).

Recommended background: EE 2022, EE 2111, and EE 2311; and at least one of EE 2112, EE 2201, EE 2312, EE 2801.

EE 2801. FOUNDATIONS OF EMBEDDED COMPUTER SYSTEMS.

Cat. I

This course introduces the assembly language programming concepts that are needed to develop microprocessor and microcontroller-based computer systems. Beginning with the fundamentals of computer architecture and organization, students learn assembly language and how assembly language programs running on microprocessors are used to solve problems that require interactions between a computer and the physical world. Students in this course will also learn about the hardware and software structure of a modern computer system and how hardware, software, and the passage of time must be managed in an embedded system design. Other issues that will be addressed as appropriate include overall embedded system development, software maintenance, programming for reliability, and product safety.

Topics: Number systems, basic graph theory and directed graphs, software flow diagrams, models for system state and state transitions, microprocessor and microcontroller architecture and assembly language programming, program development and test tools, operating system interfaces, hardware/software dependencies, and time and resource management.

Recommended background: EE2022 (for ECE students, CS 2011 is acceptable for CS students), MA 1022, and an introductory physics course such as PH 1110 or PH 1111.

EE 3113. INTRODUCTION TO RF CIRCUIT DESIGN.

Cat. I

This course is designed to provide students with the basic principles of radio frequency (RF) circuit design. It concentrates on topics such as designing tuning and matching networks for analog and digital communication, satellite navigation, and radar systems.

After reviewing equivalent circuit representations for RF diodes, transistors, FETs, and their input/output impedance behavior, the course examines the difference between lumped and distributed parameter systems. Characteristics impedance, standing waves, reflection coefficients, insertion loss, and group delay of RF circuits will be explained.

Within the context of Maxwell's theory the course will then focus on the graphical display of the reflection coefficient (Smith Chart) and its importance in designing matching circuits. Students will learn the difference between SPICE and monolithic and microwave integrated circuit analysis, and design (MMICAD) modeling. Biasing and matching networks for single and multistage amplifiers in the 900 to 2,000 MHz range are analyzed and optimized in terms of input/output impedance matching, insertion loss, and groups delays.

Recommended background: EE 2111, EE 3204.

Suggested background: EE 2112.

EE 3204. MICROELECTRONIC CIRCUITS II.

Cat. I

This course is the second of a two-course sequence in electronic circuit design. More complex circuits are analyzed and the effects of frequency and feedback are considered in detail. The course provides a comprehensive treatment of operational amplifier operation and limitations. The use of Bode plots to describe the amplitude and phase performance of circuits as a function of operating frequency is also presented. In addition, the concepts of analog signal sampling, analog-to-digital conversion and digital-to-analog conversion are presented along with techniques for interfacing analog and digital circuitry. Laboratory exercises are provided to reinforce student facility with the application of these concepts to the design of practical circuits.

Topics include: transducers; differential amplifiers, inverting/non-inverting amplifiers, summers, differentiators, integrators, passive and active filters, the Schmitt trigger, monostable and a-stable oscillators, timers, sample-and-hold circuits, A/D converters, and D/A converters.

Recommended background: Introductory electronic-circuit design and analog-signal analysis as found in EE 2201 and EE 2311.

EE 3305. AEROSPACE AVIONICS SYSTEMS.

Cat. I

This course is intended for students interested in obtaining a systems-level perspective of modern aerospace communications, navigation, and radar systems. The fundamental theory of operation of these systems is presented along with current-day applications of them.

Topics: The functional operating principles and techniques of communications, navigation (including GPS) and radar systems; performance expectations for antenna, transmitter, receiver, and transmission-line components; error sources and their effect in combination on both individual component and aggregated system performance; earth-shape approximations and their influence on system design and operation; tropospheric and ionospheric effects of radio-wave propagation; and achievable overall system accuracies.

Recommended background: MA 1022 and PH 1120 or equivalent. With extra work, this course can be successfully completed by non-EE students. The basic concepts of electromagnetic-wave propagation and antennas will be introduced as needed.

Suggested background: EE 2312

EE 3306. AUDIO ENGINEERING.

Cat. I

Intended to provide an advanced student a thorough understanding of the theory and practice of electronic systems used for the recording and reproduction of speech and music, and of the nature and control of acoustic noise.

Topics: sound, applied acoustics, devices and systems associated with the recording and reproduction of speech and music. Feedback amplifiers. Measurement of sound; techniques for the control of acoustic noise. Selected laboratory exercises.

Recommended background: EE 2201, EE 2311, EE 3204 or equivalent.

EE 3311. PRINCIPLES OF COMMUNICATION SYSTEMS.

Cat. I

This course provides an introduction to analog and digital communications systems. The bandpass transmission of analog data is motivated and typical systems are analyzed with respect to bandwidth considerations and implementation techniques. Baseband and passband digital transmission systems are introduced and investigated. Pulse shaping and intersymbol interference criteria are developed in relation to the pulse rate transmission limits of bandlimited channels. Finally, digital carrier systems and line coding are introduced in conjunction with applications to modern modem transmission schemes.

Recommended background: MA 1024, EE 2311 and EE 2312.

EE 3501. ELECTRICAL ENERGY CONVERSION.

Cat. I

This course is designed to provide a cohesive presentation of the principles of electric energy conversion for industrial applications and design. The generation, transmission and conversion of electric energy, as well as basic instrumentation and equipment associated with electric energy flow and conversion are analyzed.

Topics: Review of poly-phase circuits. Transducers and instrumentation for power and energy measurements. Rotating machines. Electromechanical transients and stability. Switchgear equipment. Selected laboratory experiments.

Recommended background: EE 2111.

EE 3503. POWER ELECTRONICS.

Cat. I

This course is an introduction to analysis and design of power semiconductor circuits used in electric motor drives, control systems, robotics and power supply.

Topics: characteristics of thyristors and power transistors. Steady-state performance and operating characteristics, device rating and protection, commutation,

gating circuits, ac voltage controllers, controlled rectifiers, dc/dc converters and dc/ac inverters. Laboratory exercises.

Recommended background: EE 2201, EE 2311 or equivalent.

EE 3601. PRINCIPLES OF ELECTRICAL ENGINEERING.

Cat. I

Intended for students other than electrical engineers, this course is oriented towards developing competence in electrical engineering concepts on the level that the technology interfaces directly with their own discipline. The course is designed specifically to help students meet that challenge through the development of a broad systems perspective and an understanding of the principal elements of electrical engineering technology. The expectation is that students completing the course will be able to handle adequately the electrical aspects of a broad range of application topics. In addition, and most important, they will be prepared to work effectively with electrical engineers on the joint solution of complex problems.

Topics covered during the course include: direct current (DC) circuit analysis and design, alternating current (AC) circuit analysis and design, circuit design using operational amplifiers, and electric machines and power systems. Selected laboratory projects are included to emphasize the direct application of the information presented in lectures.

Recommended background: MA 1021-1023, MA 2051, PH 1120/1121 or equivalent.

EE 3703. REAL-TIME DIGITAL SIGNAL PROCESSING

Cat. I

This course provides a basic introduction to the principles of real-time digital signal processing (DSP). Topics include: structured analysis of real-time systems, design of real-time DSP architectures, sampling and quantization of continuous time signals, design and implementation of FIR and IIR digital filters, and theory and application of the Fast Fourier Transform (FFT). The emphasis of the course is on the design and implementation of DSP algorithms. The algorithms are implemented on personal, portable DSP boards that the students can either program in the lab or purchase for use on their home computers. This course features an interactive studio format with mini-lectures and labs integrated into two-hour sessions. This format allows the students to try out the algorithms and methods shown in class immediately, with the instructor nearby to lend assistance and advice.

Recommended background: EE 2312, EE 2801, CS 1005 or equivalent.

EE 3711. INTRODUCTION TO ELECTRO-OPTICS.

Cat. I

The aim of this course is to give students the opportunity to acquire a fundamental understanding of optoelectronics and principles of optoelectronic device operation.

At the completion of this course the students should achieve an understanding of wave phenomena and an appreciation of basic optical components. The students will obtain a background in modulation of light and a working knowledge of display devices based on photoluminescence and cathodoluminescence, and will gain insight into light emitting diodes, LED materials and liquid crystal display. A review of the concept of lasers will be presented, leading to an appreciation of the different laser types, especially the semiconductor laser. The students will be given a working knowledge of the optical fiber categories and operation as well as critical aspects of fiber optical communication systems. Additional applications may be covered in student projects.

Recommended background: PH 1140, EE 2311, EE 2201.

EE 3801. ADVANCED LOGIC DESIGN.

Cat. I

This course introduces students to the design of the complex logic systems underlying or supporting the operation of computer systems and interfaces. Students learn how to use advanced computer-aided design tools to develop and simulate logic systems consisting of MSI components such as adders, multiplexers, latches, and counters. The concept of synchronous logic is introduced through the design and implementation of Mealy and Moore machines. Students will also learn how to use programmable logic devices to implement customized designs.

Topics: Review of logic gates and design and simplification of combinational circuits. Arithmetic circuits, MSI devices, analysis and design of sequential circuits, synchronous state machines and programmable logic.

Lab exercises: Design, analysis and construction of combinational and sequential circuits, use of computer-aided engineering software for schematic entry and digital analysis, introduction to hardware description languages and programmable logic devices.

Recommended background: EE 2022 (for ECE students) or CS 2011.

EE 3803. MICROPROCESSOR SYSTEM DESIGN (FORMERLY INTRODUCTION TO MICROPROCESSOR SYSTEMS).

Cat. I

This course builds on the computer architecture material presented in EE 2801. It covers the architecture, organization and instruction set of simple 16-bit microprocessors. The interface to memory (RAM and EPROM) and I/O peripherals is described with reference to bus cycles, bus timing, and address decoding. Emphasis is placed on the design, programming and implementation of interfaces to microprocessor systems.

Topics: bus timing analysis, memory devices and systems, IO and control signaling, bi-directional bus interfaces, instruction execution cycles, interrupts and polling, addressing, programmable peripheral devices, interface design issues.

Laboratory exercises: Use of the PC and BIOS/DOS for program design exercises. Use of the PC ISA bus for advanced IO design and programming, advanced use of BIOS/DOS and mixed language programming, standard bus timing, and interface design and implementation.

Recommended background: EE 2801 and EE 3801 or an equivalent background in advanced logic design, microprocessor architecture, and programming.

EE 3815. DIGITAL SYSTEM DESIGN WITH VHDL.

Cat. I.

This is an introductory course on the use of VHDL for the design, synthesis, modeling, and testing of VLSI devices. VHDL is an IEEE standard that is used by engineers to efficiently design and analyze complex digital designs. The course will show how to write VHDL models that can be automatically synthesized into integrated circuits such as FPGAs (Field Programmable Gate Arrays).

Topics include: hardware description languages, VHDL, system modeling and synthesis of digital circuits, VLSI, field programmable gate arrays, simulation and testing.

Laboratory Exercises: Exercises will include writing VHDL models of combinational and sequential circuits, synthesizing these models to FPGAs by automatic place and route, simulating the design, and developing and writing testbenches in VHDL.

Recommended background: EE 3801 and experience with programming in a high-level language such as C (CS 1005 and/or CS 2005) or Pascal.

EE 3901. SEMICONDUCTOR DEVICES.

Cat. I

The purpose of this course is to introduce students to the physics of semiconductor devices and to show how semiconductor devices operate in typical linear and nonlinear circuit applications. This material complements the electronics sequence of courses and will draw illustrative examples of electronic circuit applications from other courses.

Topics: carrier transport processes in semiconductor materials. Carrier lifetime. Theory of p-n junctions. Bipolar transistors internal theory, dc characteristics, charge control, Ebers-Moll relations; high frequency and switching characteristics, hybrid- π model; n- and p-channel MOSFETS, CMOS.

Recommended background: EE 2201.

EE 3902. INTRODUCTION TO VLSI DESIGN.

Cat. I

This course provides an introduction to the fundamental principles of VLSI circuit design. Emphasis is placed on the design of basic building blocks of large-scale digital integrated circuits and systems, where students will acquire hands-on design experience using a professional design platform.

Topics: Overview of VLSI fabrication technology, basic CMOS digital circuits, transistor-level and mask-level design, complex logic gates, modular building blocks, adder arrays, serial and parallel multipliers, data path components, register arrays, clock signal generation and distribution, timing, ASIC design guidelines, system integration, IC testing and testable design strategies.

Laboratory exercises will concentrate on designing full-custom digital building blocks, integrating the modules into functional chip designs, and standard-cell based ASIC design flow.

Recommended background: EE 3801.

Suggested background: EE 3901.

EE 4304. COMMUNICATION SYSTEMS ENGINEERING.

Cat. I

This course introduces the theory and performance analysis of communication in noise. The mathematical treatment of noise as a random process is developed in the context of baseband and passband transmission systems. The performance of analog transmission systems is developed and the tradeoff between bandwidth and performance is exposed. The optimum PCM receiver is derived and introduces the general concept of decision theory and signal space representation of decision systems. A treatment of coding theory for error detection, correction and compression leads to the development of Shannon's information theory and the ultimate performance of digital transmission systems. Finally, concepts that underly modern digital data computer network systems are introduced.

Recommended background: EE 3311 and MA 2621.

EE 4502. ANALYSIS OF LARGE SCALE ELECTRIC POWER SYSTEMS. ISP

This course is designed to provide an introduction to network analysis and optimization techniques that are used in operation and planning for electric power systems.

Topics: Solution of large scale linear networks: nodal analysis and matrix factorization, analysis of symmetrical and unsymmetrical faults, contingency analysis. Solution of large scale nonlinear systems: the Newton-Raphson method, bus modeling, power flow analysis. Optimization problems in power systems: economic dispatch and state estimation.

Students may not receive credit for both EE 4501 and EE 4502.

Recommended background: EE 3501.

EE 4801. ADVANCED COMPUTER SYSTEM DESIGN.

Cat. I

This course continues the development of microprocessor and microcontroller-based systems. This course focuses on the design of standalone embedded and high-performance microprocessor systems. Students are introduced to advanced concepts

in microprocessor architecture and will design, implement, and program a complete embedded computer system. The importance of designing a system suitable for production will be covered, including issues such as Design for Manufacture (DFM), design for test, reliability, and regulatory compliance including product safety.

Topics: advanced microprocessor architecture, microprocessor timing, microcontrollers, embedded systems, interrupts, DMA, CACHE and memory system controllers, real-time system design issues, high-performance system and peripheral buses, DFM, reliability.

Laboratory exercises: Design of a complete, standalone microcontroller based-system, mixed language programming, embedded system debugging, design of systems with real-time requirements.

Recommended background: EE 3803 or equivalent.

EE 4902. ANALOG INTEGRATED CIRCUIT DESIGN.

Cat. I

This course introduces students to the design and analysis of analog integrated circuits such as operational amplifiers, phase-locked loops, and analog multipliers.

Topics: integrated circuit building blocks: current mirrors and sources, differential amplifiers, voltage references and multipliers, output circuits. Computer-aided simulation of circuits. Layout of integrated circuits. Design and analysis of such circuits as operational amplifiers, phase-locked loops, FM detectors, and analog multipliers. Laboratory exercises.

Recommended background: familiarity with the analysis of linear circuits and with the theory of bipolar and MOSFET transistors. Such skills are typically acquired in EE 3204.

Suggested background: EE 3901 and EE 3902.

ENGINEERING SCIENCE INTERDISCIPLINARY

ES 1020. INTRODUCTION TO ENGINEERING.

Cat. I

This course is designed for first year students. Teams of students are assigned several engineering projects of the type typically encountered early in an engineering career. The projects generally involve engineering design concepts, mathematics and physics, such as Newton's Laws of Motion and Kirchoff's Laws. Students will learn to use a general strategy for solving engineering problems. Software for creating technical drawings, plotting data, report writing and equation solvers for performing calculations will be introduced. This course does not require any prior engineering background.

Note: This course can be used towards the Engineering Science and Design distribution requirement in IE, ME and MFE.

ES 1310. INTRODUCTION TO COMPUTER AIDED DESIGN.

Cat. I

This basic course in engineering graphical communications provides a background for all engineering disciplines. The ability to create and interpret standard, well-integrated detail and assembly drawings is a necessity for engineers to communicate ideas. Computer Aided Design software will be used as a tool for creating these engineering design drawings. Multiview and pictorial graphics techniques are integrated with standards for dimensioning, sectioning, and generating detailed engineering drawings. Emphasis is placed on relating drawings to the required manufacturing processes. The design process and aids to creativity are combined with graphics procedures to incorporate functional design requirements in the geometric model.

No prior engineering graphics or software knowledge is assumed.

ES 2001. INTRODUCTION TO MATERIAL SCIENCE.

Cat. I

A beginning course in understanding the structures and properties of metals, ceramics and plastics, in the selection and in the working and heat treating of materials. A course of interest to any engineer, scientist or person involved with materials.

The underlying fundamental theme of materials science is structure-property relationship. Structures covered range from the subatomic, or nuclear level, through the microscopic world to the macroscopic, or gross point of view. Properties investigated may be chemical, mechanical, thermal, nuclear, electrical or optical. The selection, working and thermal treatments of materials are also related to structural changes and thus property alterations.

No formal laboratory, but ample opportunity exists for the student to experiment with the fundamentals presented on a voluntary basis.

Recommended background: prior knowledge of college-level chemistry.

ES 2011. INTRODUCTION TO NUCLEAR TECHNOLOGY.

Cat. II

Overview of the basic phenomena which form the foundation of the field of nuclear engineering, including radioisotope production and utilization, and controlled chain reactions. Familiarization with nuclear laboratory techniques and instrumentation is emphasized.

Topics covered include: structure of the atom and nucleus, decay laws, properties of decay emanations, and nuclear interactions.

Recommended background: Differential and Integral Calculus (MA 1022).

ES 2501. INTRODUCTION TO STATIC SYSTEMS.*Cat. I*

This is an introductory course in the engineering mechanics sequence that serves as a foundation for other courses in mechanical engineering. In this course, students will learn to solve for forces and couples in systems that are not accelerating and which are statically determinate. They will also learn to draw shear and bending moment diagrams for beams and how to calculate the centroid and the moment of inertia for areas.

This course qualifies as one of the three courses that mechanical engineering students must complete in the mechanical systems stem.

Topics normally covered include: forces, moments of forces and couples; free body diagrams; equilibrium; friction; distributed loadings; pin trusses; beams and beam loading; suspended cables; first and second moment of area. Force analysis of submerged bodies is addressed in this course.

Recommended background: Differential and Integral Calculus (MA 1022) and elementary vector algebra.

ES 2502. STRESS ANALYSIS.*Cat. I*

The first course in engineering mechanics that addresses stress analysis of mechanical and structural elements.

Topics covered include: stresses, strains and deformations in bars, beams, and torsional elements; principal stresses, transverse shear stresses, buckling.

Recommended background: Statics (ES 2501) and elementary vector algebra.

ES 2503. INTRODUCTION TO DYNAMIC SYSTEMS.*Cat. I*

Engineers should be able to formulate and solve problems that involve forces that act on bodies which are moving. This course deals with the kinematics and dynamics of particles and rigid bodies which move in a plane.

Topics covered will include: kinematics of particles and rigid bodies, equations of motion, work-energy methods, and impulse and momentum. In this course a basic introduction to mechanical vibration is also discussed. Basic equations will be developed with respect to translating and rotating coordinate systems.

Recommended background: Statics (ES 2501 or CE 2000).

ES 3001. INTRODUCTION TO THERMODYNAMICS.*Cat. I*

This course emphasizes system and control volume modeling using the First and Second Laws of Thermodynamics.

Topics include: properties of simple substances, an introduction to availability, cycle analysis.

ES 3002. MASS TRANSFER.*Cat. I*

This course introduces the student to the phenomena of diffusion and mass transfer. These occur in processes during which a change in chemical composition of one or more phases occurs. Diffusion and mass transfer can take place in living systems, in the environment, and in chemical processes. This course will show how to handle quantitative calculations involving diffusion and/or mass transfer, including design of process equipment.

Topics may include: fundamentals of diffusional transport, diffusion in thin films; unsteady diffusion; diffusion in solids; convective mass transfer; dispersion; transport in membranes; diffusion with chemical reaction; simultaneous heat and mass transfer; selected mass transfer operations such as absorption, drying, humidification, extraction, crystallization, adsorption, etc.

Recommended background: fundamentals of chemical thermodynamics, fluid flow and heat transfer; ordinary differential equations (MA 2051 or equivalent).

ES 3003. HEAT TRANSFER.*Cat. I*

To provide an understanding of fundamental concepts of heat fluxes, to develop understanding of the coupling of fluid mechanics and thermodynamics, and to provide experience in modeling engineering systems and predicting their behavior.

Topics covered include: steady-state and transient conduction exemplified by heat transfer to and from buried pipes, heat losses through furnace walls, response of thermocouple devices, and the effect of adding fins to increase heat transfer rates. Contact resistance. Natural and forced convection. Heat exchanger analysis and design. Convection accompanied by boiling and condensation. Blackbody radiation. Thermal radiation within an enclosure including diffuse and gray surfaces. Radiation accompanied by conduction and with motion.

Recommended background: Ordinary Differential Equations (MA 2051).

ES 3004. FLUID MECHANICS.*Cat. I*

A study of the fundamental laws of statics, kinematics and dynamics applied to fluid mechanics. The course will include fluid properties, conservation of mass, momentum and energy as applied to real and ideal fluids. Laminar and turbulent flows, fluid resistance and basic boundary layer theory will also be considered.

Recommended background: basic physics, basic differential equations and vectors; third year students.

ES 3011. CONTROL ENGINEERING I.*Cat. I*

Characteristics of control systems. Mathematical representation of control components and systems. Laplace transforms, transfer functions, block and signal flow diagrams. Transient response analysis. Introduction to the root-locus method and stability analysis. Frequency response techniques including Bode, polar, and Nichols plots.

This sequence of courses in the field of control engineering (ES 3011) is generally available to all juniors and seniors regardless of department. A good background in mathematics is required; familiarity with Laplace transforms, complex variables and matrices is desirable but not mandatory. All students taking Control Engineering I should have an understanding of ordinary differential equations (MA 2051 or equivalent) and basic physics through electricity and magnetism (PH 1120/1121). Control Engineering I may be considered a terminal course, or it may be the first course for those students wishing to do extensive work in this field. Students taking the sequence of two courses will be prepared for graduate work in the field.

Recommended background: Ordinary Differential Equations (MA 2051) and Electricity and Magnetism (PH 1120, PH 1121).

ES 3323. ADVANCED COMPUTER AIDED DESIGN.*Cat. I*

This course exposes the student to computer aided engineering design and geometric modeling using Unix based graphic workstations. The use of geometric models for applications in computer aided mechanical design, engineering analysis and manufacturing is emphasized. Topics may include mechanical design, solid and feature based modeling, variational and parametric design, physical properties, assembly modeling, numerical control, mechanisms, and other analytical methods in engineering design.

Recommended background: familiarity with drafting standards (ES 1310), mechanical systems (ES 2501 or CE 2000, ES 2503) and kinematics (ME 3310) is assumed. Additional background in strength of materials (ES 2502 or CE 2001), machine design (ME 2300, ME 3320), machining and manufacturing methods (ME 1800) and higher level programming capability (CS 1001 or CS 1005) is helpful.

FIRE PROTECTION ENGINEERING

FP 3070. FUNDAMENTALS OF FIRESAFETY ANALYSIS.*Cat. I*

This course introduces students of different technical disciplines to analytical methods and techniques to address problems of fire, explosions, or hazardous incidents. Emphasis will be placed on understanding the physical concepts of the problem and their interactions. Quantification will adapt existing procedures to appropriate levels of theoretical and empirical methods in the field of fire science and engineering. Computer applications will be incorporated.

Recommended background: mathematics through differential equations; engineering science; fluid mechanics.

Graduate Fire Protection Engineering Courses of Interest to Undergraduates

FPE 510. FLAMMABILITY TESTS, CODES AND STANDARDS.*Cat. I*

Code-related fire test standards will be presented at a level appropriate for fire protection engineers in a format which includes background on perceived need to regulate, analysis of the value and limitation of test methodology and effectiveness of code requirements to control combustible materials and mitigate particular fire hazards.

Fire test standards selected for discussion provide data and results which relate to surface flame spread, fire penetration, smoke obscuration, toxic potency of combustion products and rate of heat release for products and systems including interior finish, wall and floor assemblies, thermal insulation, furniture, bedding and draperies.

FPE 520. FIRE MODELING.*Cat. II*

(Prerequisite: FPE 521 or special permission of the instructor.) Advanced topics in fire dynamics, combustion and compartment fire behavior will be discussed within a framework of modeling fire and its effects. Topics include computer modeling of pre-flashover and post-flashover compartment fires, burning characteristics of polymers and other fuels, the effect of fire retardants, products of combustion generation, flame spread models, plume and ceiling jet models and overall toxicity assessment. Some familiarity with computer programming is recommended.

Offered 2003-04 and alternating years thereafter.

FPE 521. FIRE DYNAMICS I.*Cat. I*

(Prerequisites: Undergraduate chemistry, thermodynamics [or physical chemistry], fluid mechanics and heat transfer.) This course introduces students to fundamentals of fire and combustion and is intended to serve as the first exposure to fire dynamics phenomena. The course includes fundamental topics in fire and combustion such as thermodynamics of combustion, fire chemistry, premixed and diffusion flames, solid and liquid burning, ignition, plumes and ceiling jets. These topics are then used to develop the basic for introducing compartment fire behavior, pre and post-flashover conditions and smoke movement.

FPE 553. FIRE PROTECTION SYSTEMS.*Cat. I*

(Prerequisites: Undergraduate courses in chemistry, fluid mechanics and either thermodynamics or physical chemistry.) This course provides an introduction to automatically activated fire suppression and detection systems. A general overview is presented of relevant physical and chemical phenomena and commonly used hardware in automatic sprinkler, gaseous agent, foam and dry chemical systems. Typical contemporary installations and current installation and approval standards are reviewed.

FPE 554. ADVANCED FIRE SUPPRESSION.*Cat. II*

(Prerequisite: FPE 553 or special permission of instructor.) Advanced topics in suppression systems analysis and design are discussed with an aim toward developing a performance based understanding of suppression technology. Automatic sprinkler systems are covered from the standpoint of predicting actuation times, reviewing numerical methods for hydraulic analyses of pipe flow networks and understanding the phenomenology involved in water spray suppression. Special suppression systems are covered from the standpoint of two phase and non-Newtonian pipe flow and simulations of suppression agent discharge and mixing in an enclosure.

Offered 2004-05 and alternating years thereafter.

FPE 555. DETECTION, ALARM AND SMOKE CONTROL.*Cat. II*

(Prerequisites: FPE 553. Also FPE 521 and FPE 571 which can be taken concurrently.) Principles of fire detection and using flame, heat and smoke detector technology are described. Fire alarm technology and the electrical interface with fire/smoke detectors are reviewed in the context of contemporary equipment and installation standards. Smoke control systems based on buoyancy and HVAC principles are studied in the context of building smoke control for survivability and safe egress.

Offered 2004-05 and alternating years thereafter.

FPE 563 (MG 527). RISK MANAGEMENT.*Cat. I*

Risk Management is highly interdisciplinary drawing upon systems engineering and managerial decision making and finance. The basics of risk management including hazard analysis, risk assessment, risk control and risk financing are covered. The course is self-contained and includes material from engineering economy, risk assessment and decision analysis. Group projects can draw from fire protection engineering, hazardous waste management and product liability. The projects serve to emphasize important techniques for quantifying risk and the challenge of integrating risk assessment with managerial decision making.

FPE 565. FIRESAFETY ENGINEERING EVALUATION.*Cat. II*

(Prerequisites: FPE 521, FPE 553 and FPE 570.) This course develops techniques to evaluate the firesafety performance of a variety of facilities of the built environment and to produce management plans for decision making. The framework for this course is a firesafety engineering method which decomposes the firesafety system into discrete elements that can be used for quantitative evaluation using a variety of fire protection engineering and fire science materials.

Offered 2004-05 and alternating years thereafter.

FPE 570. BUILDING FIRESAFETY I.*Cat. I*

This course focuses on the presentation of qualitative and quantitative means for firesafety analysis in buildings. Fire test methods, fire and building codes and standards of practice are reviewed in the context of a systematic review of firesafety in proposed and existing structures.

FPE 571. PERFORMANCE-BASED DESIGN.*Cat. I*

(Prerequisites: FPE 553, FPE 521 and FPE 570 or special permission of instructor.) This course covers practical applications of fire protection engineering principles to the design of buildings. Both compartmented and non-compartmented buildings will be designed for criteria of life safety, property protection, continuity of operations, operational management and cost. Modern analytical tools as well as traditional codes and standards are utilized. Interaction with architects, code officials and an awareness of other factors in the building design process are incorporated through exercises and a design studio.

FPE 572. FAILURE ANALYSIS.*Cat. I*

(Prerequisites: FPE 570, FPE 521 and FPE 553 or special permission of the instructor.) Development of fire investigation and reconstruction as a basis for evaluating, and improving firesafety design. Accident investigation theory and failure analysis techniques such as fault trees and event sequences are presented. Fire dynamics and computer modeling are applied to assess possible fire scenarios and the effectiveness of fire protection measures. The products liability aspects of failure analysis are presented. Topics include products liability law, use of standard test methods, warnings and safe product design. Application of course materials is developed through projects involving actual case studies.

FPE 573. INDUSTRIAL FIRE PROTECTION.*Cat. I*

(Prerequisites: FPE 553, FPE 521 or special permission of instructor.) Principles of fire dynamics, heat transfer and thermodynamics are combined with a general knowledge of automatic detection and suppression systems to analyze fire protection requirements for generic industrial hazards. Topics covered include safe separation distances, plant layout, hazard isolation, smoke control, warehouse storage and flammable liquid processing and storage. Historical industrial fires influencing current practice on these topics are also discussed.

FPE 574 (CM 594). PROCESS SAFETY MANAGEMENT.*Cat. I*

(Prerequisite: An undergraduate engineering or physical science background.) This course provides basic skills in state-of-the-art process safety management and hazard analysis techniques including Hazard and Operability Studies (HAZOP), Logic Trees, Failure Modes and Effects Analysis (FMEA) and Consequence Analysis. Both qualitative and quantitative evaluation methods will be utilized. Following a case study format, these techniques along with current regulatory requirements will be applied through class projects addressing environmental health, industrial hygiene, hazardous materials, fire or explosion hazard scenarios.

FPE 575. EXPLOSION PROTECTION.*Cat. II*

Principles of combustion explosions are taught along with explosion hazard and protection applications. Topics include a review of flammability limit concentrations for flammable gases and dusts; thermochemical equilibrium calculations of adiabatic closed vessel deflagration pressures and detonation pressures and velocities; pressures development as a function of time for closed vessels and vented enclosures; the current status of explosion suppression technology; and vapor cloud explosion hazards.

Offered 2003-04 and alternating years thereafter.

FPE 580. SPECIAL PROBLEMS.

Individual or group studies on any topic relating to fire protection may be selected by the student and approved by the faculty member who supervises the work.

FPE 581. SEMINAR.

Reports on current advances in the various branches of fire protection.

FPE 587. FIRE SCIENCE LABORATORY.*Cat. II*

(Prerequisite: FPE 521.) This course provides overall instruction and hands-on experience with fire science related experimental measurement techniques. The objective is to expose students to laboratory-scale fire experiments, standard fire tests and state-of-the-art measurement techniques. The Lateral Ignition and Flame Transport (LIFT) apparatus, state-of-the-art smoke detection systems, closed-up flashpoint tests and gas analyzers are among the existing laboratory apparatus. Fire related measurement techniques for temperature, pressure, flow and velocity, gas species and heat fluxes, infrared thermometry, Laser Doppler Velocimetry (LVD) and Laser Induced Fluorescence (LIF) will be reviewed.

Offered 2004-05 and alternating years thereafter.

FPE 590. M. S. THESIS.**FPE 592. GRADUATE PROJECT.**

This activity requires the student to demonstrate the capability to integrate advanced firesafety science and engineering concepts into the professional practice environment. The work may be accomplished by individuals or small groups of students working on the same project. This practicum requires the student to prepare detailed, written technical reports and make oral presentations to communicate the results of their work.

FPE 690. PH.D. DISSERTATION.

GEOSCIENCES

GE 2341. GEOLOGY.

Cat. I

Students of this course will examine the fundamental principles of physical geology including the materials, structures, and surface features of the earth and the processes which produced them. Emphasis will be placed on the interrelationship of people and environment and applications to various fields of technology. The course includes field trips and a significant laboratory component.

HUMANITIES AND ARTS

Art History/Architecture

AR 1111. INTRODUCTION TO ART HISTORY.

Cat. I

How do we understand a work of art? Through readings and the study of objects at the Worcester Art Museum, the student will survey the major developments in world art and be introduced to various critical perspectives in art history. Students will learn how art historians work with primary materials and formulate arguments. No previous knowledge of art is required. (Formerly HU 1014.)

AR 2111. MODERN ART.

Cat. I

The successive phases of modern art, especially painting, are examined in light of the late-19th-century break with the 600-year old tradition of representation.

Topics covered include: non-objective art and abstraction—theory and practice, primitivism in modern art, surrealism and the irrational, the impact of photography on modern painting, cubism and collage, regionalism and abstract expressionism as American art forms, Pop art and popular culture, and the problem of concept versus representation in art. (Formerly AR 2300.)

AR 2113. TOPICS IN 19TH- AND 20TH-CENTURY ARCHITECTURE.

Cat. I

This course considers the built environment in a non-technical way. It explores changes in architectural style as responses to the industrial transformation of Europe and America and to changing ideas about the purpose of art. The focus will vary from year to year and may concentrate on new uses of past styles, the architecture and planning of the industrial city, the careers of the great modern architects from Wright to Mies, or current topics in design. The central topic will remain the development of the Modern Movement in architecture. Students will use local buildings to learn the methods of architectural history and explore the aesthetic effects of architecture.

AR 3112. MODERNISM, MASS CULTURE, AND THE AVANT-GARDE.

Cat. I

What is the role of art to be in the modern world? Can art be a vehicle for social change, or should art be a self-critical discipline that pursues primarily aesthetic ends? What is the relationship between art and mass culture? Using primary sources, this course focuses on some of the theorists and artistic trends since the mid-nineteenth century that have sought to resolve this dilemma. These include: Ruskin, Morris and the Arts and Crafts Movement; Art For Art's Sake; the German Werkbund and the Bauhaus; American industrial design.

AR/ID 3150. LIGHT, VISION AND UNDERSTANDING.

Cat. II

By using material from the sciences and the humanities, this course examines the ways in which ideas of knowledge and of human nature have been fashioned. The specific topics include physical theories about light, biological and psychological theories of visual perception, and artistic theories and practices concerned with representation. The mixing of material from different academic disciplines is deliberate, and meant to counter the notion that human pursuits are "naturally" arranged in the neat packages found in the modern university. The course draws upon the physical and social sciences, and the humanities, to examine how those fields relate to one another, and how they produce knowledge and self-knowledge. Cultural as well as disciplinary factors are assessed in this process.

Light, Vision and Understanding is conducted as a seminar. The diverse collection of reading materials includes a number of primary texts in different fields. In addition, the students keep a journal in which they record the results of numerous individual observations and experiments concerning light and visual perception. The course can fit into several Sufficiency areas as well as serve as a starting point for an IQP. There are no specific requirements for this course, although some knowledge of college-level physics, as well an acquaintance with the visual arts, is helpful.

This course will be offered in 2004-05 and in alternating years thereafter.

English

EN 1221. INTRODUCTION TO DRAMA: THEATRE ON THE PAGE AND ON THE STAGE.

Cat. I

The plays studied will give the student an understanding of the forms of drama, the styles of theatre performance and production, and the emergence of new forms and styles. Types of drama studied could include Greek Tragedy and Comedy, Roman Comedy, Cycles and Pageants of the Middle Ages, Shakespeare, Restoration, Romanticism, Neo-Classicism, French Comedy, Realism, Naturalism, and the eclectic forms in the Twentieth Century. Discussions, research and writing projects, and performance activities will offer the student experience in the theory and practice studied in the course.

EN 1222. SHAKESPEARE IN THE AGE OF ELIZABETH.

Cat. I

This course is an introduction to Shakespeare, his theatre, and some important concepts of his world. Students will have the opportunity to sample representative Shakespearean tragedies, comedies, and histories. In addition to class discussions and scene work, students will be able to enhance their readings by analyzing video recordings of the plays.

EN 1231. AMERICAN LITERATURE: BEGINNINGS THROUGH HAWTHORNE.

Cat. I

This survey course covers American literature from its beginnings in the colonial period through the works of Nathaniel Hawthorne in the early nineteenth century. Students will read literary works in a variety of genres (narratives, poems, sermons, plays, stories, and novels) that reflect the emerging nation's struggle for cultural self-definition. Topics will include the literature of travel and discovery, the faith of the colonial founders, the quest for a distinctive national literature, and the rise of early American fiction.

EN 1242. INTRODUCTION TO ENGLISH POETRY.

Cat. I

This course surveys the poems of our language. From the Anglo-Saxon poems to the popular verse of Tennyson, the songs and the poets are legion: Chaucer, Raleigh, Spenser, Marlowe, Shakespeare, Jonson, Donne, Herrick, Milton, Blake, Wordsworth, Coleridge, Byron, Keats, Tennyson, Browning, and Hopkins. The England that nourished these writers will be viewed through their ballads, lyrics, sonnets, epigrams, and epics. "Not marble nor the gilded monuments of princes shall outlive this powerful rhyme."

EN 1251. INTRODUCTION TO LITERATURE.

Cat. I

This course introduces the student to a variety of critical perspectives necessary to an understanding and appreciation of the major forms, or genres, of literary expression (e.g., novel, short story, poetry, drama, and essay). Writing and class discussion will be integral parts of this course.

EN 1257. INTRODUCTION TO AFRICAN AMERICAN LITERATURE AND CULTURE.

Cat. II

This course examines the formation and history of the African American literary tradition from slave narratives to contemporary forms in black popular culture. The course will explore some genres of African American writing and their relation to American literature and to black cultural expression.

This course will be offered in 2004-05 and in alternating years thereafter.

EN/WR 2211. ELEMENTS OF WRITING.

Cat. I

This course is designed for students who wish to work intensively on their writing. The course will emphasize the processes of composing and revising, the rhetorical strategies of expository prose, and the interaction between writer and audience. In a workshop setting, students will write a sequence of short papers and complete one longer writing project, learn to read critically and respond helpfully to each other's writing, and make oral presentations from written texts.

EN 2221. AMERICAN DRAMA.

Cat. I

An investigation into the development of American drama from its beginnings to the present. The history of the emergence of the legitimate theatre in this country will be followed by reading important plays, including the works of O'Neill, Williams, Mamet, Norman, Henley, and others. Discussion of the growth of regional theatres and their importance to the continuation of theatre as a serious and non-profit art form will be included in the course. The student will investigate the importance of theatre practice in the evolution of the dramatic literature of the country.

EN 2222. THEATRE WORKSHOP.*Cat. I*

A workshop course which offers the student the opportunity to explore theatre through creative involvement with playwriting, design, performance, production, and criticism. Students will work in a laboratory situation functioning as a micro-professional theatre which could develop a production that would be staffed and dramaturged from the group.

EN 2223. SHAKESPEARE: THE UNTUNED STRING.*Cat. II*

A study of the political and moral conflicts in such plays as *Hamlet*, *King Lear* and *Richard III*. The course examines the chaos that results in a society lacking moral and political leadership.

Opportunities will exist in this course for studying the plays as literature, for aspects of production and performance, and for their adaptability to film. The WPI library of video recordings will be available for such work.

This course will be offered in 2003-04 and in alternating years thereafter.

EN 2224. SHAKESPEARE: NOTHING BUT LOVE.*Cat. II*

The course focuses on conflicts between personal desire and societal responsibility in such plays as *As You Like It*, *Antony and Cleopatra*, and *The Winter's Tale*.

Through written work and in-class performances, students will examine how Shakespeare both maintains and subverts traditional ideas about marriage and sexual practice. These analyses will take into account contemporary views on gender roles and identity including the early modern cultural "ideal" of the "chaste, silent, and obedient" woman. Students will study Shakespeare's work as literature and also through performance and film adaptations. The WPI library of video recordings will be available for such work.

This course will be offered in 2004-05 and in alternate years thereafter.

EN 2231. AMERICAN LITERATURE: THE RAVEN, THE WHALE, AND THE WOODCHUCK.*Cat. I*

Emerson challenged the young nation in "The American Scholar" (1837): If our writers were "free and brave," with words "loaded with life," they would usher in a "new age." The incredibly rich literature that soon followed created an "American Renaissance." This was the Age of Reform (1836-65) in more than literature. Writers were caught up in such burning issues as abolitionism, Union vs. secession, and women's rights. Authors studied may include Emerson, Thoreau, Poe, Fuller, Douglass, Melville, Whitman, and Dickinson.

EN 2232. AMERICAN LITERATURE: TWAIN TO WORLD WAR I.*Cat. I*

This survey course covers developments in American literature, particularly the movement towards Realism, during the period of turbulent change between the end of the Civil War and the early years of the twentieth century. Topics will include the rebellion against post bellum sentimentalism, the rise of regional writing, the emerging literature of social protest, and literary responses to advances in science, industry, and urban life. Attention will be given to the works of Mark Twain, a prime exponent of turn-of-the-century literary trends, as well as to other pioneer realists (James and Crane).

EN 2233. AMERICAN LITERATURE: MODERNISM TO THE PRESENT.*Cat. I*

This final survey course in American literature covers the modern and contemporary periods, from World War I to the present. The wide-ranging material represents the literary response to the broad intellectual, social, and cultural changes that mark the history of those years of ferment in the United States. The course includes selected works of fiction, drama, poetry, and essays by such writers as William Faulkner, Toni Morrison, Thornton Wilder, Sylvia Plath, Allen Ginsberg, Joy Harjo, and Michael Harper.

EN 2234. MODERN AMERICAN NOVEL.*Cat. II*

Selected works of fiction which appeared after World War I will be the focus of this course. F. Scott Fitzgerald, Ernest Hemingway, William Faulkner, or other authors of the early modern period will be studied, but significant attention will also be given to contemporary novelists, such as Alice Walker and Kurt Vonnegut. The cultural context and philosophical assumptions of the novels will be studied as well as their form and technique.

This course will be offered in 2003-04 and in alternating years thereafter.

EN 2235. THE AMERICAN DREAM: MYTH IN LITERATURE AND THE POPULAR IMAGINATION.*Cat. I*

American writers from our beginnings have been preoccupied with "The American Dream" as a benchmark for measuring the attainment of our highest ideals as a people. The course examines the political, economic, religious, and rhetorical roots of the concept, assesses its popular and commercial manifestations, and explores the ironies, paradoxes, and continuities that have shaped this national self-image for almost 400 years. Readings include works by Puritan and Revolutionary writers, Native American leaders, Horatio Alger, Jr., William Dean Howells, F. Scott Fitzgerald, Martin Luther King, Jr., Adrienne Rich, Studs Terkel, and Archibald MacLeish.

EN 2237. AMERICAN LITERATURE AND THE ENVIRONMENT.*Cat. II*

This course will examine the many ways in which American essayists, novelists, dramatists, and poets have responded to the natural world, and especially to ecological concerns voiced in contemporary times. Among the topics to be discussed in class and in papers are the changing attitudes towards the wilderness, the effects of technology on the environment, and the presence of the spiritual in nature. Readings may include works by such authors as Ernest Hemingway, Wendell Berry, Mary Oliver, Loren Eiseley, and Gary Snyder.

This course will be offered in 2004-05 and in alternating years thereafter.

EN 2238. AMERICAN REALISM.*Cat. I*

By examining authors who reacted against the so-called "genteel tradition," this course attempts to show how various subjects (death, sex, war, slum life and racial prejudice) were treated more honestly in short stories and novels after the Civil War. Authors may include Mark Twain, Stephen Crane, W. D. Howells, Edith Wharton, Kate Chopin, and Theodore Dreiser.

(Formerly EN 3236. Students who have received credit for this course may not receive credit for EN 2238.)

EN 2241. ENGLISH LITERATURE AFTER SHAKESPEARE.*Cat. II*

Participants in this course will examine outstanding works of eighteenth- and nineteenth-century English literature as these works raise the question: Who is man, and what is his relationship to God, nature, and to his fellow creatures? Writers covered may include Swift, Pope, Keats, Browning, and Dickens.

This course will be offered in 2004-05 and in alternating years thereafter.

EN 2242. POPULAR FICTION: READING IN INSTALLMENTS.*Cat. I*

Students in this course will have the opportunity to read two major masterpieces of English fiction the way they should be read: slowly, carefully, and with relish. Victorian novels are long and the term is short, but by reading novels in the way in which they were read by their original readers—serially—we can experience masterworks by Charles Dickens and George Eliot at comparative leisure, examining one serial installment per class session.

EN 2243. MODERN BRITISH LITERATURE.*Cat. II*

A survey of major modern British authors. The works of many of these writers reflect the political, religious, and social issues of the twentieth century. New psychological insights run parallel with experiments in the use of myth, stream of consciousness, and symbolism. Authors studied may include Hardy, Conrad, Owen, Joyce, Lawrence, Woolf, Eliot, Yeats, and Orwell.

This course will be offered in 2003-04 and in alternating years thereafter.

EN 2251. MORAL ISSUES IN THE MODERN NOVEL.*Cat. I*

This course focuses on the problem of how to live in the modern world. Emphasis will be placed on the way moral issues evolve within the complications of individual lives, as depicted in fiction. Such authors as Conrad, Kesey, Camus and Ellison show characters struggling with the questions of moral responsibility raised by love, religion, death, money, conformity.

EN 2252. SCIENCE AND SCIENTISTS IN MODERN LITERATURE.*Cat. I*

This course surveys the ways in which modern literature has represented science and scientists. Beginning with Mary Shelley's *Frankenstein*, the origin of what Isaac Asimov calls the "damned Frankenstein complex" is examined. More complex presentations of science and scientists occur in twentieth-century works like Brecht's *Galileo*, Huxley's *Brave New World*, and Pirsig's *Zen and the Art of Motorcycle Maintenance*.

The course covers major modern works of fiction and drama, including such literary forms as the play, the novel of ideas, and the utopian novel. Attention is focused on the themes (ideas) in, and the structure of, these works.

EN/WR 3011. PEER TUTORING IN WRITING.*Cat. I*

Peer Tutoring in Writing introduced students to the theory and practice of composition. In this course, students research, read, and write about their own and others' literacy practices. Through reading and writing assignments, peer reviews, interviews, presentations, and a tutoring internship in the CCAC, students hone their communication skills while increasing their ability to examine critically the role of communication in the production of knowledge.

EN/WR 3214. WRITING ABOUT DISEASE AND PUBLIC HEALTH.*Cat. I*

This writing workshop focuses on the purposed and genres of writing about disease and public health. We will consider how biomedical writers communicate technical information about disease and public health to general audiences; how writers capture the human experience of disease and health care; how writers treat the public policy implications of disease; and how writers design

publicity to promote public health. We will examine such genres as the experimental article, news reports, medical advice, profiles, commentary, and public health messages.

Recommended background: EN 2211 or equivalent writing courses.

Students who have taken EN 3215 may not receive credit also for EN/WR 3214.

EN/WR 3216. WRITING IN THE PROFESSIONS.

Cat. I

Studies show that engineers spend 80-90% of their professional time engaged in various kinds of communication. This course emphasizes the management contexts of writing in the professions. Focus is on making informed decisions about approaches, styles, problems, issues, sources, strategies, and human-relations aspects of writing in business, industry, and other institutional settings. Special attention is given to business editing and proposal and grant writing.

Recommended background: EN 2211 or equivalent writing course.

EN/WR 3217. CREATIVE WRITING.

Cat. I

The purpose of this course is to help students develop or improve the skills of written expression. Small groups are formed in which participants present and discuss their original work in either fiction or poetry.

EN 3222. FORMS IN WORLD DRAMA.

Cat. II

The study of the major forms of world drama beginning with the Greeks and ending with contemporary forms. The student will develop the skills to analyze form and structure through dramatic content. The course may include the works of Sophocles, Euripides, Aristophanes, the Renaissance, the Restoration, Moliere, Ibsen, Strindberg, Shaw, Pirandello, and others.

This course will be offered in 2003-04 and in alternating years thereafter.

EN 3223. FORMS IN MODERN DRAMA.

Cat. II

The study of the forms in modern drama and their development from the forms of world drama. Contemporary playwrights studied could include Brecht, Bond, Schaeffer, Handke, and others, and the course will devote some concentration to theatre movements of the twentieth century that have operated with textual revision, minimal text, or no texts. Thus, theatre companies studied might include the work of the Living Theatre, the Open Theatre, and the theatre of Grotowski and Brook.

This course will be offered in 2004-05 and in alternating years thereafter.

EN 3224. SHAKESPEARE SEMINAR.

Cat. II

This course would allow for the study of various Shakespearean topics in different years. Some representative subjects could include: "Shakespeare and the Arts," "Shakespeare's Contemporaries," "Shakespeare and Science," "Shakespearean Tragedy," "Shakespeare's Roman Plays," "Shakespeare's Histories," "Shakespeare on Film." The topics will be announced before the seminar meets.

This course will be offered in 2003-04 and in alternating years thereafter.

EN 3231. NEW ENGLAND SUPERNATURALISM.

Cat. II

From the colonial period to the 20th century, New England writers have endowed the region's people and its settings (fields, forests, buildings, factories, cities) with shapes of fear. This course will explore New England's fascination with the supernatural from Puritan writings to the contemporary tale of terror. A primary focus of the course will be the genre of New England Gothicism and its literary conventions. Authors studied may include Hawthorne, Longfellow, Whittier, Freeman, Wharton, Jackson, Lovecraft, and King.

This course will be offered in 2003-04 and in alternating years thereafter.

EN 3232. THE CONCORD WRITERS.

Cat. II

Rural, mid-19th-century Concord, Massachusetts, witnessed an unprecedented flowering of important and influential American literature. Why Concord? We sample writings of Ralph Waldo Emerson, Henry D. Thoreau, Nathaniel Hawthorne, Bronson Alcott, and Louisa May Alcott to explore matters of cultural background, biography, contemporary events, uses of the past, literary vocation, and sense of place. Emphasis is on these writers' friendships and their creative responses to intellectual and social forces of the day—factors that made Concord a community of highly individualistic writers.

This course will be offered in 2003-04 and in alternating years thereafter.

Students who have received credit for EN 2236 (New England Writers: Concord) may not receive credit for EN 3232.

EN 3233. WORCESTER BETWEEN THE COVERS: LOCAL WRITERS AND THEIR WORKS.

Cat. II

Worcester has had a rich and varied literary history from Isaiah Thomas's founding of the American Antiquarian Society in the early 1800s to the works of S. N. Behrman, Robert Benchley, Elizabeth Bishop, Esther Forbes, Stanley Kunitz, and Charles Olson in the 20th century. This course will examine selections from Worcester area writers in a number of genres (e.g., fiction, drama, poetry, essay, nonfiction memoir). Attention will be given to the local contexts of these writings as well as to each writer's contributions to the larger continuum of American Literature.

This course will be offered in 2004-05 and in alternating years thereafter.

Students who have received credit for EN 2236 (New England Writers: Worcester) may not receive credit for EN 3233.

EN 3234. MODERN AMERICAN POETRY.

Cat. II

This course is a study of selected American poets and their reactions to the ferment of the modern period. A thematic approach to poetry will be emphasized. Included in the course are modern poets such as Robert Frost, T. S. Eliot, E. E. Cummings, and Marianne Moore, as well as contemporary poets such as Rita Dove, Li-Young Lee, and Robert Pinsky.

This course will be offered in 2004-05 and in alternating years thereafter.

EN 3237. PURSUING *MOBY-DICK*.

Cat. II

Since 1851, readers of Herman Melville's masterpiece have joined in the chase for the "meaning" of the White Whale. After briefly examining the philosophical context of Emersonian idealism and the literary example of Hawthorne, the course is devoted solely to a close reading of *Moby-Dick*—one of the most innovative and mysterious novels in the English language. "Whose" book is it, anyway? Captain Ahab's? Ishmael's? The Whale's? The reader's? We conclude by surveying major critical approaches to the novel.

This course will be offered in 2004-05 and in alternating years thereafter.

EN 3248. THE ENGLISH NOVEL.

Cat. I

Participants in this seminar will examine the English novel from its origins in the eighteenth century to its twentieth-century forms, exploring the rich variety of ways a writer may communicate a personal and social vision. The novels treat love, travel, humor, work, adventure, madness, and self-discovery; the novelists may include Fielding, Austen, Dickens, Eliot, Conrad, and Woolf.

EN ----. DRAMA/THEATRE PERFORMANCES.

TH: IS/P

One-sixth unit of credit will be awarded at the conclusion of two successive terms of participation. Performance activities currently receiving credit are:

- TH 1225 Theatre Production Practicum
- TH 2225 Acting
- TH 2227 Advanced Acting
- TH 2229 Advanced Theatre Production Practicum
- TH 3225 Directing
- TH 3227 Advanced Directing
- TH 3229 Dramaturgy
- TH 4225 Theatre Technology Design
- TH 4227 Advanced Theatre Technology Design
- TH 4229 Advanced Dramaturgy

Credit would be given on the condition that the performance takes place in a WPI performance directed or advised by a part- or full-time WPI instructor.

Note: A maximum of two one-sixth credits, or a total of one-third unit, may be applied toward the five courses, or five one-third units, taken prior to the final sufficiency term.

IS 1811. WRITING FOR NON-NATIVE SPEAKERS OF ENGLISH.

Cat. I

This course offers, through conferences, tutorial sessions and extensive writing practice, a review of English composition principles for international students.

The following topics are included: the motivation of the writer; basic grammar; organization of the paragraph, sentence, and overall essay or report; vocabulary and word choice; spelling hints; and style. Much emphasis is given to the development of effective revising techniques. This is a course for those electing the "Basic Sufficiency for International Students."

IS 1812. SPEECH FOR NON-NATIVE SPEAKERS OF ENGLISH.

Cat. I

This course focuses on developing international students' ability to speak effectively, organize ideas logically, improve voice and diction, and use visual aids. Television and audiotapes are used to record competence and poise. This is a course for those electing the "Basic Sufficiency for International Students."

German

GN 1511. ELEMENTARY GERMAN I.*Cat. I*

An intensive language course designed to teach concise expression of ideas in writing and speaking. Basic grammar and significant cultural aspects are introduced through the aid of readings, audio-recordings, video, and oral group interaction. (Formerly GN 2616.)

GN 1512. ELEMENTARY GERMAN II.*Cat. I*

A continuation of Elementary German I.
Recommended background: GN 1511.

GN 2511. INTERMEDIATE GERMAN I.*Cat. I*

A continuation of Elementary German II, with increased emphasis on oral and written expression. Basic textbook is supplemented by a collection of simple literary texts by the Grimm brothers, Brecht, and Bichsel.
Recommended background: Elementary German II.

GN 2512. INTERMEDIATE GERMAN II.*Cat. I*

A continuation of Intermediate German I.
Recommended background: GN 2511.

GN 3511. ADVANCED GERMAN I.*Cat. I*

Reading and in-class discussion of a wide variety of contemporary nonfictional and fictional texts. Some video viewing. Weekly brief writing assignments and continued expansion of vocabulary. Weekly vocabulary quiz. Review of grammar and introduction to advanced stylistic problems.
Recommended background: Intermediate German II.

GN 3512. ADVANCED GERMAN II.*Cat. I*

A continuation of Advanced German I.
Recommended background: GN 3511.

GN 3513. SURVEY OF GERMAN CIVILIZATION AND CULTURE FROM 1871 TO THE PRESENT.*Cat. II*

Conducted entirely in German, the course presents an overview of the development of modern Germany and its culture since the founding of the Second Empire. Background readings in German and English provide the basis for in-class discussion of selected authentic German texts of various kinds: literary works, official documents, political manifestos, letters, and diaries. At least one film will be shown. A number of recurring themes in German culture will inform the content of the course: authoritarianism versus liberalism, idealism versus practicality, private versus public life.

This course will be offered in 2004-05 and in alternating years thereafter.

Recommended background: GN 3511 (Advanced German I) and GN 3512 (Advanced German II) or equivalent.

GN 3514. SEMINAR ON SELECTED TOPICS IN GERMAN LITERATURE.*Cat. II*

The content of the seminar will change from time to time. The course will focus either on an author (e.g., Goethe, Heine, Kafka, Gunter Grass, Christa Wolf), a genre (e.g., lyric poetry, drama, narrative prose), a literary movement (e.g., Romanticism, expressionism), or a particular literary problem (e.g., literature and technology, writing and the Holocaust, writing and the city). The seminar will be conducted entirely in German.

The course will be offered in 2003-04 and in alternating years thereafter.

Recommended background: GN 3511 (Advanced German I) and GN 3512 (Advanced German II) or equivalent.

History

HI 1311. INTRODUCTION TO AMERICAN URBAN HISTORY.*Cat. I*

An introduction to the history of the American city as an important phenomenon in itself and as a reflection of national history. The course will take an interdisciplinary approach to study the political, economic, social, and technological patterns that have shaped the growth of urbanization. In addition to reading historical approaches to the study of American urban history, students may also examine appropriate works by sociologists, economists, political scientists and city planners who provide historical perspective.

HI 1312. INTRODUCTION TO AMERICAN SOCIAL HISTORY.*Cat. I*

An introduction to the historical study of American society. It addresses two questions: What is social history? And how do social historians work?

HI 1313. INTRODUCTION TO THE STUDY OF FOREIGN POLICY AND DIPLOMATIC HISTORY.*Cat. I*

An introduction to the various components of U.S. foreign policy decision-making and the basic techniques of diplomatic history. The course will focus on one or two topics in the history of American foreign relations, using a variety of primary documents and secondary sources.

HI 1314. INTRODUCTION TO EARLY AMERICAN HISTORY.*Cat. I*

An introduction to historical analysis through selected periods or themes in the history of America before the Civil War. A variety of readings will reflect the various ways that historians have attempted to understand the development of America.

HI 1321. INTRODUCTION TO EUROPEAN SOCIAL HISTORY.*Cat. I*

An introduction to the study of modern European social history since the Industrial Revolution. Topics will include industrialization in Britain and Europe, class formation, gender and the condition of women, technology and economy, culture and society. Students will learn to work with historical sources, to formulate arguments, to read critically, and to write clearly.

No prior knowledge of European history is required.

HI 1322. INTRODUCTION TO EUROPEAN CULTURAL HISTORY.*Cat. I*

In this course students think through some of the major intellectual currents that have defined modern Western Civilization. Topics include the philosophical impact of science on modern thought, the development of liberalism and socialism, the crisis of culture in the twentieth century. Students read selections from major thinkers in the Western tradition and develop their skills at critical thinking, analysis, oral and written argument.

No prior knowledge of European history is required.

HI 1331. INTRODUCTION TO THE HISTORY OF SCIENCE.*Cat. I*

An introduction to the methods and source material historians use to study science. Topics covered will range from early Greek science to Newton and the Scientific Revolution in the 17th-century.

Suggested background: elementary knowledge of science.

HI 1332. INTRODUCTION TO THE HISTORY OF TECHNOLOGY.*Cat. I*

An introduction to concepts of historical analysis — i.e., the nature and methodology of scholarly inquiry about the past — through the concentrated examination of selected case studies in the history of technology. Possible topics include: the influence of slavery on the development of technology in the ancient world and the middle ages; the power revolution of the middle ages; the causes of the Industrial Revolution in 18th-century Britain; and the emergence of science-based technology in 19th-century America.

HI 1341. INTRODUCTION TO GLOBAL HISTORY.*Cat. I*

An introduction to the study of global history since 1500. Topics include global expansion, the Columbian exchange, and the slave trade; Renaissance, Reformation, and revolution in Europe; global industrialization, imperialism, and nation building; the world wars and revolutionary movements; decolonization and the Cold War. The course will also discuss case studies of developing nations of interest to students. Especially appropriate as background for students interested in International Studies or any of WPI's global Project Centers.

HI 2311. AMERICAN COLONIAL HISTORY.*Cat. I*

This course surveys early American history up to the ratification of the Constitution. It considers the tragic interactions among Europeans, Indians, and Africans on the North American continent, the growth and development of English colonies, and the revolt against the Empire that culminated in the creation of the United States of America.

HI 2313. AMERICAN HISTORY, 1789-1877.*Cat. I*

This course surveys American history from the Presidency of George Washington to the Civil War and its aftermath. Topics include the rise of American democracy, the emergence of middle-class culture, and the forces that pulled apart the Union and struggled to put it back together.

HI 2314. AMERICAN HISTORY, 1877-1920.*Cat. I*

This course surveys the transformation of the United States into an urban and industrial nation. Topics will include changes in the organization of business and labor, immigration and the development of cities, the peripheral role of the South and West in the industrial economy, politics and government in the age of "laissez-faire," and the diverse sources and nature of late 19th- and early 20th-century reform movements.

HI 2315. THE SHAPING OF POST-1920 AMERICA.*Cat. I*

This course surveys the major political, social, and economic changes of American history from 1920 to the present. Emphasis will be placed on the Great Depression, the New Deal, suburbanization, McCarthyism, the persistence of poverty, the domestic effects of the Vietnam war, and recent demographic trends.

HI 2316. AMERICAN FOREIGN POLICY FROM WOODROW WILSON TO THE PRESENT.*Cat. I*

This survey of American diplomatic history begins with the legacy of Woodrow Wilson, continues through our apparent isolation in the 1920's, American neutrality in the 1930's, World War II, the early and later Cold War periods, and concludes with an overview of the current global involvement of the United States.

HI 2317. LAW AND SOCIETY IN AMERICA, 1865-1910.*Cat. I*

This survey course explores the dramatic expansion of government's role in American life between the Civil War and World War I. It does so by examining the response of constitutional, common, and statutory law to the social, economic, and political change associated with this pivotal period in the nation's history.

HI 2321. EUROPE FROM THE FRENCH REVOLUTION TO WORLD WAR I.*Cat. I*

A survey of the major socio-economic, political, and cultural developments in European history from the Old Regime to World War I. The course will focus upon those factors and events that led to the formation of modern European society: Nation-State building, The French Revolution, industrialization; liberalism, democracy, and socialism; national unification of Italy and Germany; the coming of World War I.

No prior knowledge of European history is required.

HI 2322. EUROPE SINCE WORLD WAR I.*Cat. I*

A survey of the major political, socio-economic, and cultural developments in European history since World War I. The course will focus upon those factors and events that have led to the current world situation: the World Wars, fascism and communism, the Holocaust, the Cold War, the welfare state, decolonization, post-industrial society, popular culture, the collapse of communism, contemporary Europe.

No prior knowledge of European history is required.

HI 2324. INDUSTRY AND EMPIRE IN BRITISH HISTORY.*Cat. I*

A survey of modern Britain from the 18th century to the present. Topics include the British state and national identity, the industrial revolution, political and social reform, the status of women, sport and society, Ireland, the British Empire, the World Wars, the welfare state, economic decline. Especially appropriate as background for students planning IQP's or Sufficiency Projects in London.

No prior knowledge of British history is required.

HI 2325. MODERN FRANCE.*Cat. II*

This course examines the historical origins of modern France and the distinguishing features of French society and culture. Some of the topics covered include: Bourbon absolutism; the cause and effects of the French Revolution; the struggle for democratic liberalism in the 19th century; class and ideological conflict in the Third Republic; Vichy fascism, and present-day politics in the Fifth Republic.

No prior knowledge of French history is required.

This course will be offered in 2004-05 and in alternating years thereafter.

HI 2328. HISTORY OF REVOLUTIONS IN THE TWENTIETH CENTURY.*Cat. I*

A survey of the history of revolutions in the present century including those in Russia, China, Cuba, and "?". The theory of modernization will be used as an analytic tool.

No prior knowledge of the history of revolutions is expected.

HI 2331. AMERICAN SCIENCE AND TECHNOLOGY TO 1859.*Cat. I*

A survey, stressing the development of a scientific community, of the content and character of American science (and, to some degree, American technology) from the first European explorations until just before the publication of *The Origin of Species*. Topics include: medieval science in the new world; the Scientific Revolution and its influence in America; the American Industrial Revolution; the rise of science as a profession; the interplay of science and technology with the state and federal governments.

HI 2332. AMERICAN SCIENCE AND TECHNOLOGY FROM 1859.*Cat. I*

A survey of the content and character of American science (and, to some degree, American technology and medicine) from the publication of *The Origin of Species* through the present. Topics include: Darwinism and Social Darwinism in America; scientific agriculture and the federal government; scientific technology and the rise of an industrial society; scientific education and the new universities; positivism and the growth of the physical sciences; the new biology and medicine; conservation, scientific management, the gospel of efficiency and progressivism; science, World War I and the 1920's; the intellectual migration and its influence; science, technology and World War II; Big Science and the Military-Industrial-Scientific Complex; attacks on Big Science.

HI 2333. HISTORY OF SCIENCE FROM 1700.*Cat. I*

A survey of major developments in science since Newton. Topics may include: 18th century physical science within the context of the Enlightenment; the revolution in biological thought in the 19th century; relativity and the quantum theory; key concepts such as the conservation of energy and the electromagnetic field; the changing structure of the scientific community.

A knowledge of advanced science is not required but would be advantageous.

HI 2334. EUROPEAN TECHNOLOGICAL DEVELOPMENT.*Cat. I*

A survey of the development of technology in Europe from the late medieval period to World War I. Emphasis will be placed on understanding the evolution of technology within its cultural, social, and political contexts. Topics may include the military, mechanical, maritime, and building technologies of the medieval and Renaissance periods; the commonly misunderstood figures of Leonardo da Vinci; the causes and nature of the Industrial Revolution; the effects of the British Industrial Revolution in France and Germany in the 19th century; the transition from craft-based industries to those that are science based such as the dyestuffs and electrical power industries; World War I as a technological conflict.

HI 2341. CONTEMPORARY WORLD ISSUES IN HISTORICAL PERSPECTIVE.*Cat. II*

This course examines the historical origins of contemporary global crises and political transformations. Students keep abreast of on-going current events through periodical literature and explore the underlying long-term causes of these events as analyzed by scholarly historical texts. Topics will vary each time the course is taught but may include such topics as: The European Union, The Israeli-Palestinian Crisis, Democratization in Africa, The Developing World and Debt Relief. No prior knowledge of world history is required.

This course will be offered in 2003-04 and in alternating years thereafter.

HI 2342. CULTURES IN CONTACT: THE WORLD TO 1650.*Cat. II*

This course surveys global history from the adoption of agriculture to the initial stage of global colonialism, focusing on major and informative instances of intercultural contact. The course is organized around case studies that may include the agricultural revolution; the diffusion of religious traditions; Rome as multicultural empire; the Silk Road; exchanges around the Indian Ocean; the expansion of Islam; The Crusades; European encounters with the New World; and Japanese contact with the West.

This course will be offered in 2004-05 and in alternating years thereafter.

HI 3311. AMERICAN LABOR HISTORY.*Cat. I*

This seminar course will deal with the history of organized labor in America as well as with the historic contributions of working people, whether unionized or not, to the growth and development of American ideas, politics, culture, and society.

Among the topics to be covered will be: the origins, growth, and expansion of trade and industrial unionism; the roots and development of working class consciousness; the underlying causes and eventual resolution of labor disturbances; the philosophical and ideological perspectives of the labor movement. Students will explore topics raised by common readings via written papers, seminar presentations, and work with primary source materials.

Suggested background: HI 2314, American History, 1877-1920; or HI 2315, The Shaping of Post-1920 America.

HI 3312. TOPICS IN AMERICAN SOCIAL HISTORY.*Cat. I*

A seminar course on analysis of selected aspects of social organization in American history, with emphasis on the composition and changing societal character of various groups over time, and their relationship to larger social, economic, and political developments. Typical topics include: communities, families, minorities, and women.

Suggested background: Some college-level American history.

HI 3314. THE AMERICAN REVOLUTION.*Cat. I*

This seminar course considers the social, political, and intellectual history of the years surrounding American independence, paying particular attention to the changes in society and ideas that shaped the revolt against Great Britain, the winning of independence, and the creation of new political structures that led to the Constitution.

HI 3321. TOPICS IN MODERN EUROPEAN HISTORY.*Cat. II*

This seminar course examines topics in the cultural, socio-economic and political history of modern Europe, with a focus on Great Britain. Topics may vary each year among the following: nationalism, class and gender, political economy, environmental history, sport and society, film and history. Readings will include primary and secondary sources.

This course will be offered in 2003-04 and in alternating years thereafter.

HI 3323. TOPICS IN THE WESTERN INTELLECTUAL TRADITION.*Cat. II*

This seminar course in the history of ideas focuses each year on a different theme within the intellectual-cultural traditions of Western Civilization. Some topics are the following: The Impact of the New Physics on 20th Century Philosophy; The Social History of Ideas; The Enlightenment and the French Revolution; Sexuality, Psycho-analysis, and Revolution. The course is structured around classroom discussion of major texts on the topic under study and a related research paper.

This course will be offered in 2003-04 and in alternating years thereafter.

HI 3331. TOPICS IN SCIENCE, TECHNOLOGY, AND SOCIETY.*Cat. I*

A seminar course on the relationships among science, technology, and society in Europe through a series of case studies. Topics from which the case studies might be drawn include: the harnessing of science for industrial purposes; the role of the chemical industry in war; the function of the science advisor in government; the military-industrial complex in Nazi Germany; the political views and activities of major scientists such as Einstein. Students will use current theories and critiques of "autonomous technology" to analyze the case studies.

Suggested background: Courses in European history and the history of science and technology.

HI 3333. TOPICS IN AMERICAN TECHNOLOGICAL DEVELOPMENT.*Cat. I*

A seminar course examining selected examples of technological change in the United States. Topics from which these case studies might be chosen include: colonial technology; mechanization of ante-bellum industry; the impact of science on Gilded-Age technology; 20th-century behavioral technologies; the evolution of the military-industrial complex; the Manhattan Project; the exploitation of space; computers and post-World-War-II technology; and the emergence of biotechnology. In addressing these cases, this seminar will employ and seek to evaluate one or more significant historical theses about the nature of technological change.

Suggested background: Some familiarity with the basic outlines and concerns of both American history and the history of American technology.

HI 3341. TOPICS IN IMPERIAL AND POSTCOLONIAL HISTORY.*Cat. II*

This seminar course examines topics in the history of European imperialism, colonialism, and the postcolonial aftermath. Topics vary each year among the following: culture and imperialism, the expansion of Europe, the economics of empire, travel and exploration narratives, imperialism in literature and anthropology, decolonization in Asia and Africa, postcolonial studies. Readings will include primary and secondary sources.

This course will be offered in 2004-05 and in alternating years thereafter.

HI 3342. TOPICS IN COMPARATIVE CIVILIZATIONS.*Cat. II*

This seminar course compares and contrasts major religious, philosophical, social, and political themes in different civilizations. Comparisons will vary each year but may be drawn from Asia, the Indian subcontinent, the Middle East, Africa, and indigenous cultures of the Americas. It examines the historical foundations of these civilizational differences and draws comparisons with common features of Western civilization. One important goal of the course is to enhance student appreciation of non-Western values and traditions.

This course will be offered in 2004-05 and in alternating years thereafter.

IS 1813. AMERICAN HISTORY FOR INTERNATIONAL STUDENTS.*Cat. I*

An introduction to American history designed to provide international students with a basic understanding of the history and culture of the United States.

Written and oral assignments will also help these students gain a more effective command of the English language.

Humanities

The courses listed below are general humanities courses and are intended to provide conceptual introductions to the major disciplines within the humanities. Students will encounter the basic methods of critical analysis and discussion required for the future investigation of the specific area they choose for their humanities and arts Sufficiencies. These courses emphasize patterns of thought, methods of inquiry, appropriate vocabulary, and critical attitudes needed to appreciate most fully various areas in the humanities; they are not intended as surveys or historical overviews. Consequently, in each course the subject matter used to develop and illustrate key concepts and approaches will change regularly. Practice in analytic thinking and writing will be a significant part of each course. The skills generated by these courses will greatly aid students in developing their themes and will be essential for the completion of the Sufficiency in the final IS/P seminar.

HU 1411. INTRODUCTION TO AMERICAN STUDIES.*Cat. II*

This interdisciplinary course introduces students to three or four basic American Studies methodologies. Emphasis will vary according to the instructor, but usually the course will cover the following: the particular historical, cultural context (at the community and/or national level) of a few literary texts; the relationship of American art to literature in a specific time period; analysis of popular culture entertainments in market-and-message terms of production and reception. This course provides a beginning for a Sufficiency in American Studies. For a description of the American Studies sequence and offerings, see the Sufficiency section of the Undergraduate Catalog.

Suggested background: an interest in American history and American expression.

This course will be offered in 2003-04 and in alternating years thereafter.

HU 1412. INTRODUCTION TO ASIA.*Cat. I*

After an introduction to the enormous literature on China and Japan, the course will focus on the historical development of the ASEAN group (Thailand, Singapore, Malaysia, Indonesia, Philippines, Brunei, and Vietnam). This interdisciplinary course will concentrate on common elements within this very diverse association: colonial residues; similar models of economic development; cultural/religious linkages; influences from China, Japan and the U.S. Especially appropriate for Sufficiencies in Global Studies, U.S. Foreign Policy, British Colonial history and literature, or Religion, and as a background for students planning IQPs in Asia.

HU 2441. AFRICAN HISTORY AND CULTURE.*Cat. II*

This survey course uses an interdisciplinary approach to examine fundamental issues in African political, social, and cultural history. The course may include various topics, such as ancient African kingdoms, the influence of Islam, the Atlantic slave trade, imperialism and decolonization, contemporary democratization, or African literature and art.

Suggested background: HI 1341 Introduction to Global History.

This course will be offered in 2003-04 and in alternating years thereafter.

HU 3411. PRO-SEMINAR IN GLOBAL PERSPECTIVES.*Cat. II*

This course examines the fundamentals of intercultural communication to prepare students to live and work with people from other cultures. It explores how different patterns of thinking and behavior, assumptions and values, have arisen from different cultural traditions and divergent histories in the world. Racism, prejudice, and bigotry—often the result of cultural, social, and technological differences in human experience—are among the concerns of the class. This course cannot teach students how to behave and think in all parts of the world, but it raises questions about ethnocentric assumptions often taken for granted by those working or studying in another culture. It is excellent preparation for an international IQP or educational exchange.

Suggested background: Previous courses in Humanities.

This course will be offered in 2003-04 and in alternating years thereafter.

HU 3421. TOPICS IN MEDIEVAL AND RENAISSANCE STUDIES.*Cat. II*

This seminar course examines interdisciplinary topics in the study of the medieval and renaissance world. The course emphasizes various types of primary source material. Topics may include the Roman, Judeo-Christian, and Germanic heritage; warfare and social structure; the emergence of the modern town; folk and popular culture; encounters with the new world; and change and continuity in early modern society. It is appropriate for students with preparation any of several areas of the humanities, including history, literature, history of science and technology, and art history.

This course will be offered in 2003-04 and in alternating years thereafter.

Suggested background: previous courses in humanities such as AR 1111, GN 1222, GN 2223, GN 2224, HI 1322, HI 1331, HI 1341, HI 2334, MU 2612, RE 2723 or equivalent.

HU 4411. SENIOR SEMINAR IN INTERNATIONAL STUDIES.*Cat. I*

This course is designed to integrate each student's international courses, projects, and experiences in a capstone seminar in International Studies. Students will reflect on what they have learned in their previous courses and international experiences. They will assess what happened to them overseas, why it happened, and how it might be understood. They will also prepare a paper with an instructor in their area of international studies that integrates their previous academic courses. Students will also explore how they might translate their courses and experiences into future personal and professional opportunities.

Recommended background: previous courses in international studies, such as HI 1341 and HU 3411, and completion of an international IQP or an international educational exchange.

HU—AAS-50. AMERICAN ANTIQUARIAN SEMINAR.*ISP*

Each fall the American Antiquarian Society and five Worcester colleges sponsor a research seminar at the Antiquarian Society library. The seminar is conducted by a scholar familiar with the Society's holdings in early American history, and the seminar topic is related to his or her field of research.

Selection is highly competitive. The ten participating students are chosen by a screening committee made up of representatives of the five participating colleges: Assumption College, Clark University, College of the Holy Cross, WPI, and Worcester State College.

The seminar topic and research methods combine several disciplines, and students from a wide variety of majors have participated successfully in this unique undergraduate opportunity.

Music

MU 1611. FUNDAMENTALS OF MUSIC I.*Cat. I*

This course concentrates on basic music theory of the common practice period. If time permits, instruction includes ear training, sight singing, and work on scales and intervals.

Recommended background: basic knowledge of reading music.

MU 2611. FUNDAMENTALS OF MUSIC II.*Cat. I*

Fundamentals II is a course on music theory at the advanced level beginning with secondary dominants and modulations and working through 19th-century chromatic harmony.

MU 2612. MUSIC OF THE MEDIEVAL AND RENAISSANCE PERIODS.*Cat. II*

Music of the medieval church and secular troubadours is studied with special attention given to composers such as Machaut, DesPres, Palestrina, Byrd and Gabrieli.

This course will be offered in 2004-05 and in alternating years thereafter.

MU 2613. MUSIC OF THE BAROQUE PERIOD.*Cat. II*

Music is examined from the operas of Monteverdi through the cantatas of Buxtehude, culminating in the works of Bach and Handel.

This course will be offered in 2003-04 and in alternating years thereafter.

MU 2614. MUSIC OF THE CLASSIC PERIOD.*Cat. II*

Music of the classic period concentrates on works by C.P.E. Bach, Haydn, Mozart, and Beethoven.

This course will be offered in 2004-05 and in alternating years thereafter.

MU 2615. MUSIC OF THE ROMANTIC PERIOD.*Cat. II*

Emphasis is on the grandeur and madness of the romantic composers of Europe: Beethoven, Schubert, Berlioz, von Weber, Liszt, Chopin, Brahms, Wagner and Tchaikowsky.

This course will be offered in 2003-04 and in alternating years thereafter.

MU 3611. COMPUTER TECHNIQUES IN MUSIC.*Cat. I*

This course concentrates on both the technical and artistic aspects of computer music. Topics covered include the MIDI protocol and specification, sequencer design, voice editing, synthesizer architecture, and literature.

MU 3612. COMPUTERS AND SYNTHESIZERS IN MUSIC.*Cat. I*

This course focuses on technical and aesthetic problem solving in computer music. Using programming languages, students propose and design creative solutions to contemporary problems which currently have no commercial solutions. Students work with sequencers, signal processors, synthesizers, MIDI controllers, editors, and programming languages.

MU 3613. DIGITAL SOUND DESIGN.*Cat. I*

This course introduces the student to the theory and practice of digital sound design. It focuses on creative problem-solving in applications where digital audio production is a key component. Topics include digital sound recording and editing, creation and synchronization of digital sound tracks for video, theatrical sound design, and multimedia production.

MU 4621. INDEPENDENT INSTRUCTION (LESSONS) IN MUSIC.*IS/P*

Students electing to take their humanities and arts Sufficiency in music may, for one of their five courses, undertake 1/3 unit (normally at 1/12 unit per term) of private vocal or instrumental instruction. (Supplemental ensemble work is also strongly recommended.) The student must receive prior approval by a member of the WPI music faculty, and the instruction must be beyond the elementary level. Lessons involve a separate fee. Note that the maximum of 1/3 unit credit for lessons may be earned in addition to 1/3 unit credit for performance (see condition A or B below). Additional work, either in performance or lessons, may be acknowledged on the WPI transcript but will carry no WPI credit. Private lessons: voice, piano, organ, winds, brass, strings, and percussion.

MU— SEMINARS.*IS/P*

Seminars (taken as #4 type IS/P only) are available in a variety of areas such as the following:

- MU 4623 Introduction to Jazz History
Cat. II. This seminar will be offered in 2004-05.
- MU 4624 Introduction to Jazz Theory
Cat. II. This seminar will be offered in 2003-2004.
- MU 4625 Survey of American Popular Music (Formerly DGW 2444.)
- MU 4626 Counterpoint: An Introduction (Formerly DPM 3341.)
Cat. II. This seminar will be offered in 2004-05.
- MU 4629 Music of the Twentieth-Century
Cat. II. This seminar will be offered in 2003-2004.

MU 4628. PERFORMANCE SUFFICIENCY.*IS/P*

A final (sixth term) Sufficiency in music may be fulfilled by a recital performance in addition to a related paper, provided the music faculty determines that the student's capabilities be of a high order. During this term, the student usually is under private instruction, the cost of which is borne by the student. NOTE: Two 1/3 units credit remain the maximum allowed for all lessons and performance credit.

MU— ENSEMBLES.*IS/P*

One-sixth unit of credit will be awarded at the conclusion of two successive terms of participation. Ensembles currently receiving credit are:

- | | |
|--------------|-------------------------|
| Choral | MU 4631 Men's Glee Club |
| | MU 4632 Women's Chorale |
| Instrumental | MU 4633 Brass Ensemble |
| | MU 4634 Jazz Band |
| | MU 4635 Stage Band |
| | MU 4636 Concert Band |
| | MU 4637 String Ensemble |

Credit would be given only under one of the two conditions below:

- Condition A The performance or experience takes place in a course or ensemble at a college or other institution from which WPI would normally accept transfer credit. The determination of which institutions are acceptable will be made by the WPI Humanities and Arts Department Head in conjunction with the relevant faculty members.
- Condition B The performance or experience takes place in a WPI ensemble taught by a part- or full-time WPI instructor.

Philosophy

PY/RE 1731. INTRODUCTION TO PHILOSOPHY AND RELIGION.

Cat. I

This course provides an overview of key concepts, methods and authors in both fields. These introduce the student to the types of reasoning required for the pursuit of in-depth analysis in each discipline.

Emphasis on topics and authors varies with the particular instructor.

PY 2711. PHILOSOPHICAL THEORIES OF KNOWLEDGE AND REALITY.

Cat. I

This course introduces students to methods of philosophical analysis relating to the classification and conceptualization of entities and the nature of knowledge. The course will focus on a related set of problems or on the elaboration of a philosophical issue of knowledge or reality in the history of philosophy. Among themes and problems considered might be: How has the being of nature and knowledge of nature been represented in Western philosophy and science? What kind of a phenomenon is mind or thought and can entities in addition to human beings, such as computers, be said to have this attribute? What are reliable methods of arriving at and evaluating scientific knowledge, and are these methods identical for the natural and human sciences? Readings might include excerpts from the works of Plato, Aristotle, Bacon, Descartes, Kant, James, Dewey and Heidegger, as well as numerous contemporary philosophers.

Suggested background: familiarity with basic philosophical concepts and terms (as in PY/RE 1731).

PY 2712. SOCIAL AND POLITICAL PHILOSOPHY.

Cat. II

This course examines metaphysical and moral questions that philosophers have raised about social and political life. Among questions treated might be: What are the grounds, if any, of the obligation of a citizen to obey a sovereign? Are there basic principles of justice by which societies, institutions and practices are rightly evaluated? What is democracy, and how can we tell if an institution or practice is democratic? To what degree do economic institutions put limits on the realization of freedom, democracy and self-determination? Readings might include excerpts from the works of Plato, Hobbes, Locke, Rousseau and Marx, as well as numerous contemporary philosophers.

Suggested background: familiarity with basic concepts in philosophy (as in PY/RE 1731).

This course will be offered in 2003-04 and in alternative years thereafter.

PY 2713. BIOETHICS.

Cat. II

The purpose of this course is to evaluate the social impact of technology in the areas of biology/biotechnology, biomedical engineering and chemistry. The focus of the course will be on the human values in these areas and how they are affected by new technological developments. The course will deal with problems such as human experimentation, behavior control, death, genetic engineering and counseling, abortion, and the allocation of scarce medical resources. These problems will be examined through lectures, discussions and papers.

Suggested background: knowledge of key terms and concepts as given in PY/RE 1731 and PY/RE 2731.

This course will be offered in 2003-04 and in alternating years thereafter.

PY 2714. ETHICS AND THE PROFESSIONS: PERSONAL, PROFESSIONAL, AND SOCIAL DILEMMAS.

Cat. II

This course will present a framework by which various ethical dilemmas that arise in the professions, especially the science-related professions, can be identified, examined, and evaluated on the level of personal morality, professional codes of ethics, and social values. The goal is to study the solutions of these dilemmas in each of the three levels to determine what relation there may be between them, and whether or not resolutions of a dilemma on one level are appropriate for another level. Ethical concepts, professional codes of ethics, and policy positions will be used to analyze and evaluate these issues in a case study format. Representatives of appropriate professions will be invited to address specific issues pertaining to ethical dilemmas in their field.

This course will be offered in 2004-05 and in alternating years thereafter.

PY 2715. PHILOSOPHICAL THEORIES OF THE SELF.

Cat. II

This course will focus on philosophical questions concerning the nature of human identity. It will examine arguments from various philosophical traditions on topics such as the nature of personhood, self-deception, the importance or unimportance of everyday concerns, the comparative role of individual decisions and social norms, and the differences between secular and religious, Western and Eastern, political and apolitical approaches to all these issues. Authors may include some of the following: Thoreau, Kierkegaard, Hegel, Camus, Buddha, Plato, Marx, Freud and de Beauvoir.

Suggested background: familiarity with basic ethical concepts and terms (as in PY/RE 1731) and PY/RE 2731 or PY 2712.

This course will be offered in 2003-04 and in alternating years thereafter.

PY 2716. PHILOSOPHY OF DIFFERENCE.

Cat. II

This course examines philosophical presuppositions and questions of value underlying and expressed in the construction of masculinity and femininity in modern society. The course may also examine social identities rooted in race, ethnicity, sexual preference, and ability/disability. Possible topics include: changing conceptions of love, sex, marriage, and parenting; how our conceptions of masculinity and femininity are influenced by and influence (for example) religion, science, politics, work, and art; and the relations between feminist theory and other critical social theories.

This course will be offered in 2004-05 and in alternating years thereafter.

PY 2717. PHILOSOPHY AND THE ENVIRONMENT.

Cat. I

This course will focus on the following questions:

What is the scope of the current environmental crisis? What does this crisis reveal about the philosophical presuppositions and dominant values of our intellectual worldviews and social institutions? How can existing social theories help explain the environmental crisis? What implications does the crisis have for our sense of personal identity? What moral and spiritual resources can help us respond to it?

Readings will be taken from contemporary and historical philosophers and naturalists.

Suggested background: familiarity with basic concepts in philosophy (as in PY/RE 1731).

PY/RE 2731. INTRODUCTORY ETHICS.

Cat. I

This course will review at an introductory level theories of ethics, individual figures in the history of ethics, and selected problems in ethics. The emphasis will be on philosophical or religious ethics depending on the instructor.

PY 3711. TOPICS IN PHILOSOPHY.

Cat. I

The purpose of this course is to expose students to somewhat more advanced and specialized study in philosophy. Its focus will vary, but will typically be one of the following types: a particular philosopher (e.g., Plato, Kant, Mill); a particular philosophical tradition (e.g., Pragmatism, Ordinary Language philosophy, Empiricism); a particular philosophical problem (free will, knowledge of other minds, historical explanation); or a particular philosophical classic (Hegel's *Phenomenology of Mind*, Aristotle's *Ethics*).

Suggested background: three other philosophy courses.

PY 3712. PHILOSOPHY OF RELIGION.

Cat. II

This course will focus on philosophical questions concerning the following topics: the existence and nature of God; the compatibility of God and evil; the nature of religious faith and the relationship between religion, science and ethics; interpretations of the nature of religious language; the philosophically interesting differences between Western and Eastern religions; philosophical critiques of the role of religion in social life. Authors may include: Hume, Kant, Kierkegaard, Buber, Tillich, Daly, Nietzsche and Buddha.

Suggested background: familiarity with basic religious concepts and terms (as in PY/RE 1731).

This course will be offered in 2004-05 and in alternating years thereafter.

PY/RE 3731. PROBLEMS IN ETHICS AND SOCIAL PHILOSOPHY.

Cat. I

This course will examine in depth selected problems in ethical theory and social philosophy. The specific content or emphasis will be determined by the instructor.

Suggested background: knowledge of either PY/RE 2731 or PY 2712.

Religion

RE/PY 1731. INTRODUCTION TO PHILOSOPHY AND RELIGION.

Cat. I

This course provides an overview of key concepts, methods and authors in both fields. These introduce the student to the types of reasoning required for the pursuit of in-depth analysis in each discipline.

Emphasis on topics and authors varies with the particular instructor.

RE 2721. RELIGION AND CULTURE.

Cat. I

The purpose of this course is to examine how the two institutions of religion and culture interact and mutually influence one another. To do this a variety of definitions of religion and culture will be presented as well as an analysis of how religion interacts with such cultural phenomena as economics, politics, the state, war and the basic problem of social change. The purpose of this is to obtain a variety of perspectives on both religion and culture so that one can begin to articulate more clearly the different influences that occur in the development of one's own personal history and the culture in which one lives.

Suggested background: knowledge of key terms and concepts as given in PY/RE 1731.

RE 2722. THE PROBLEM OF EVIL.

Cat. I

Notions of good and evil shape many of our day to day religious and philosophical claims and arguments. This course concerns questions and approaches to what is often called "evil," through a study of classical and contemporary texts and problems. The focus of the course will vary, but will include metaphysical, moral, and political ideas about kinds and relations of goods and evils from different religious and philosophical perspectives. This study takes into account notions of error, ignorance, wrong-doing, freedom and responsibility evident in contemporary religious and philosophical debate.

RE 2723. RELIGIONS OF THE WEST.

Cat. II

The purpose of this course is to examine, from an historical, doctrinal, scriptural and philosophical perspective, major Western religions. The course will focus primarily on Judaism, Christianity and Islam. Other religions will be examined. The course will attend to the social context in which these religions developed and will examine their continuing influence on Western society.

Suggested background: RE/PY 1731 and RE 2721.

This course will be offered in 2004-05 and in alternating years thereafter.

RE 2724. RELIGIONS OF THE EAST.

Cat. II

The purpose of this course is to examine, from the perspectives of history text, practice, and philosophy, some or all of the following religions: Hinduism, Buddhism, Taoism, Confucianism, and Shinto. The course will attend to the social context in which these religions began, their relations with their culture, their rituals and their continuing influences in the East and West.

Suggested background: PY/RE 1731 and RE 2721.

This course will be offered in 2003-04 and in alternating years thereafter.

RE/PY 2731. INTRODUCTORY ETHICS.

Cat. I

This course will review at an introductory level theories of ethics, individual figures in the history of ethics, and selected problems in ethics. The emphasis will be on philosophical or religious ethics depending on the instructor.

RE 3721. TOPICS IN RELIGION.

Cat. I

The purpose of this course is to expose students to somewhat more advanced or specialized study in religion. The focus will vary, but the material will be drawn from a particular religious thinker, a particular religious tradition or a particular historical or contemporary problem.

Suggested background: three other courses in religion.

RE/PY 3731. PROBLEMS IN ETHICS AND SOCIAL PHILOSOPHY.

Cat. I

This course will examine in depth selected problems in ethical theory and social philosophy. The specific content or emphasis will be determined by the instructor.

Suggested background: knowledge of either RE/PY 2731 or PY 2712.

Spanish

SP 1523. ELEMENTARY SPANISH I.

Cat. I

A very intensive course that will introduce the student to the basic grammar of Spanish, emphasizing the four language skills: listening, speaking, reading and writing. It will also introduce the student to different aspects of Hispanic cultures in the U.S. and in Spanish-speaking countries. Students who have taken Spanish in high school are urged to take a placement exam before enrolling in either level of Elementary Spanish. See the instructor.

SP 1524. ELEMENTARY SPANISH II.

Cat. I

A continuation of Elementary Spanish I.

Recommended background: SP 1523.

SP 2521. INTERMEDIATE SPANISH I.

Cat. I

A course designed to allow students to improve their written and oral skills, expand their vocabulary and review some important grammatical structures. Students will also read short stories and poems by some of the most representative Spanish American and Spanish authors, such as Horacio Quiroga, Jorge Luis Borges, Gabriela Mistral and Ana Maria Matute.

Recommended background: Elementary Spanish II.

SP 2522. INTERMEDIATE SPANISH II.

Cat. I

A continuation of Intermediate Spanish I.

Recommended background: SP 2521.

SP 3521. ADVANCED SPANISH I.

Cat. I

A course that continues to improve student's language skills while deepening their understanding of Hispanic cultures. Some of the topics studied are: the origins of Hispanic cultures in Spain and Spanish America; family; men and women in Hispanic societies; education; religion.

Recommended background: Intermediate Spanish II.

SP 3522. ADVANCED SPANISH II.

Cat. I

A continuation of Advanced Spanish I.

Recommended background: SP 3521.

SP 3523. TOPICS IN LATIN AMERICAN CULTURE.

Cat. II

An introduction to various aspects of life in Latin American countries from early times to the present. Focusing on the social and political development of Latin America, the course will reveal the unity and diversity that characterize contemporary Latin American culture. Typical topics for study include: the precolumbian civilizations and their cultural legacy; the conquistadores and the colonial period; the independence movements; the search for and the definition of an American identity; the twentieth-century dictatorships; and the move toward democracy.

Recommended background: SP 3521 (Advanced Spanish I) and SP 3522 (Advanced Spanish II) or equivalent.

This course will be offered in 2004-05 and in alternating years thereafter.

SP 3524. SPANISH-AMERICAN LITERATURE IN THE TWENTIETH CENTURY.

Cat. I

This course, taught in the Spanish language, focuses on the major literary movements in Spanish America, from the "Modernista" movement at the turn of the century to the Latin American "Boom" of the 1960s to the political literature of the '70s and '80s. The work of representative authors, such as Rubén Darío, Julio Cortázar, Rosario Castellanos, Elena Poniatowska, will be discussed.

Recommended background: SP 3521 (Advanced Spanish I) and SP 3522 (Advanced Spanish II) or equivalent.

SP/ID 3525. SPANISH AMERICAN FILM/MEDIA: CULTURAL ISSUES.

Cat. II

Through Latin American and Caribbean films, and other media sources, this course studies images, topics, and cultural and historical issues related to modern Latin American and the Caribbean. Within the context and influence of the New Latin American Cinema and/or within the context of the World Wide Web, radio, newspapers, and television the course teaches students to recognize cinematographic or media strategies of persuasion, and to understand the images and symbols utilized in the development of a national/regional identity. Among the topics to be studied are: immigration, gender issues, national identity, political issues, and cultural hegemonies.

Taught in advanced level Spanish. May be used toward foreign language Sufficiency, Minor, or Major.

Recommended Background: SP 2521 and SP 2522, and SP 3523.

This course will be offered in 2003-04 and in alternating years thereafter.

SP/ID 3526. COMPARATIVE BUSINESS ENVIRONMENTS.*Cat. II*

The basis of this course is a comparative study and analysis of specific Latin American and Caribbean business practices and environments, and the customs informing those practices. ID3052 focuses on countries such as Mexico, Argentina, Chile, Puerto Rico, and Costa Rica. The course's main objective is to study communication strategies, business protocol, and negotiation practices in the countries mentioned above. Through oral presentations and written essays, students will have the opportunity to explore other countries in Latin America and the Caribbean.

Taught in advanced level Spanish. May be used toward foreign language Sufficiency, Minor, or Major.

Recommended Background: SP 2521 and SP 2522.

This course will be offered in 2004-05 and in alternating years thereafter.

SP/ID 3527. TECHNICAL AND BUSINESS SPANISH*Cat. I*

The course focuses on the linguistic concepts, terminology, and grammar involved in business and technical Spanish. Students will be required to produce and edit business documents such as letters, job applications, formal oral and written reports, etc. The objective of this course is to help students develop the basic written and oral communication skills to function in a business environment in Latin America and the Caribbean.

Recommended background: SP 2521 and SP 2522.

Writing**WR/EN 2211. ELEMENTS OF WRITING.***Cat. I*

This course is designed for students who wish to work intensively on their writing. The course will emphasize the processes of composing and revising, the rhetorical strategies of expository prose, and the interaction between writer and audience. In a workshop setting, students will write a sequence of short papers and complete one longer writing project, learn to read critically and respond helpfully to each other's writing, and make oral presentations from written texts.

WR/EN 3011. PEER TUTORING IN WRITING.*Cat. I*

Peer Tutoring in Writing introduced students to the theory and practice of composition. In this course, students research, read, and write about their own and others' literacy practices. Through reading and writing assignments, peer reviews, interviews, presentations, and a tutoring internship in the CCAC, students hone their communication skills while increasing their ability to examine critically the role of communication in the production of knowledge.

WR/EN 3214. WRITING ABOUT DISEASE AND PUBLIC HEALTH.*Cat. I*

This writing workshop focuses on the purposed and genres of writing about disease and public health. We will consider how biomedical writers communicate technical information about disease and public health to general audiences; how writers capture the human experience of disease and health care; how writers treat the public policy implications of disease; and how writers design publicity to promote public health. We will examine such genres as the experimental article, news reports, medical advice, profiles, commentary, and public health messages.

Recommended background: EN 2211 or equivalent writing courses.

Students who have taken EN 3215 may not receive credit also for WR/EN 3214.

WR/EN 3216. WRITING IN THE PROFESSIONS.*Cat. I*

Studies show that engineers spend 80-90% of their professional time engaged in various kinds of communication. This course emphasizes the management contexts of writing in the professions. Focus is on making informed decisions about approaches, styles, problems, issues, sources, strategies, and human-relations aspects of writing in business, industry, and other institutional settings. Special attention is given to business editing and proposal and grant writing.

Recommended background: EN 2211 or equivalent writing course.

WR/EN 3217. CREATIVE WRITING.*Cat. I*

The purpose of this course is to help students develop or improve the skills of written expression. Small groups are formed in which participants present and discuss their original work in either fiction or poetry.

INTERDISCIPLINARY**ID/SS 2050. SOCIAL SCIENCE RESEARCH FOR THE IQP.***Cat. I*

This course is open to students accepted to off-campus IQP centers and programs. The course introduces students to research design, methods for social science research, and analysis. It also provides practice in specific research and field skills using the project topics students have selected in conjunction with sponsoring agencies. Students learn to develop social science hypotheses based upon literature reviews in their topic areas and apply concepts drawn from social psychology, anthropology, sociology, economics and other areas as appropriate. Students make presentations, write an organized project proposal, and develop a communication model for reporting their project findings.

ID/AR 3150. LIGHT, VISION AND UNDERSTANDING.*Cat. II*

By using material from the sciences and the humanities this course examines the ways in which ideas of knowledge and of human nature have been fashioned. The specific topics include physical theories about light, biological and psychological theories of visual perception, and artistic theories and practices concerned with representation. The mixing of material from different academic disciplines is deliberate, and meant to counter the notion that human pursuits are "naturally" arranged in the neat packages found in the modern university. The course draws upon the physical and social sciences, and the humanities, to examine how those fields relate to one another, and how they produce knowledge and self-knowledge. Cultural as well as disciplinary factors are assessed in this process.

Light, Vision and Understanding is conducted as a seminar. The diverse collection of reading materials includes a number of primary texts in different fields. In addition, the students keep a journal in which they record the results of numerous individual observations and experiments concerning light and visual perception. The course can fit into several Sufficiency areas as well as serve as a starting point for an IQP. There are no specific requirements for this course, although some knowledge of college-level physics, as well as an acquaintance with the visual arts, is helpful.

This course will be offered in 2004-05 and in alternating years thereafter.

ID/SP 3525. SPANISH AMERICAN FILM/MEDIA: CULTURAL ISSUES.*Cat. II*

Through Latin American and Caribbean films, and other media sources, this course studies images, topics, and cultural and historical issues related to modern Latin American and the Caribbean. Within the context and influence of the New Latin American Cinema and/or within the context of the World Wide Web, radio, newspapers, and television the course teaches students to recognize cinematographic or media strategies of persuasion, and to understand the images and symbols utilized in the development of a national/regional identity. Among the topics to be studied are: immigration, gender issues, national identity, political issues, and cultural hegemonies.

Taught in advanced level Spanish. May be used toward foreign language Sufficiency, Minor, or Major.

Recommended Background: SP 2521 and SP 2522, and SP 3523.

This course will be offered in 2003-04 and in alternating years thereafter.

ID/SP 3526. COMPARATIVE BUSINESS ENVIRONMENTS.*Cat. II*

The basis of this course is a comparative study and analysis of specific Latin American and Caribbean business practices and environments, and the customs informing those practices. ID3052 focuses on countries such as Mexico, Argentina, Chile, Puerto Rico, and Costa Rica. The course's main objective is to study communication strategies, business protocol, and negotiation practices in the countries mentioned above. Through oral presentations and written essays, students will have the opportunity to explore other countries in Latin America and the Caribbean.

Taught in advanced level Spanish. May be used toward foreign language Sufficiency, Minor, or Major.

Recommended Background: SP 2521 and SP 2522.

This course will be offered in 2004-05 and in alternating years thereafter.

ID/SP 3527. TECHNICAL AND BUSINESS SPANISH*Cat. I*

The course focuses on the linguistic concepts, terminology, and grammar involved in business and technical Spanish. Students will be required to produce and edit business documents such as letters, job applications, formal oral and written reports, etc. The objective of this course is to help students develop the basic written and oral communication skills to function in a business environment in Latin America and the Caribbean.

Recommended background: SP 2521 and SP 2522.

RH 3111. THE STUDY OF WRITING.*Cat. I*

This course introduces students to issues in the study of writing such as the history and uses of literacy, the relationship of thought to language, the role of writing in producing knowledge, and research on composing. The focus of the course will be on professional and academic writing. The course will be organized around a series of interrelated research questions: How do writers in professional and academic settings know when they have something to write about? How do they define a problem to investigate? How do they define or construct an audience to address? How do they locate their work in relation to others' work? How do they know which forms of writing to use? Why do they write in the first place? What functions does writing perform?

RH 3112. RHETORICAL THEORY.*Cat. I*

Rhetoric concerns both the art of mastering the available means of persuasion and the study of how oral, written, and visual communication projects the intentions of individuals and groups, makes meanings, and affects audiences. The purpose of this course therefore is two-fold. It is intended to help students become more effective communicators by learning about the rhetorical situation and various rhetorical techniques. And it is designed to help them understand how various forms of communication work by learning some of the strategies of rhetorical analysis.

RH 3211. RHETORIC OF VISUAL DESIGN.*Cat. I*

This course explores how visual design is used for purposes of identification, information, and persuasion. It looks at many modes of visual communication, such as icons, logos, trademarks, signs, product packaging, infographics, posters, billboards, ads, exhibits, graffiti, page layout, films, television, videogames, and web sites. The course provides an overview of the history of graphic design movements, as well as analytical tools to understand how visual design encodes messages and the role visual communication plays in contemporary culture.

MANAGEMENT

MG 1100. FINANCIAL ACCOUNTING.*Cat. I*

This course provides a tool for business communication, as accounting is an important language of business. Students are introduced to the accounting process, its underlying concepts, and the techniques of preparing and analyzing financial statements. Students are also introduced to issues in accounting for assets, liabilities, and stockholders' equity. The course demonstrates the employment of accounting data by users outside the firm, and the application of accounting numbers in financial analyses and market decisions.

MG 1250. PERSONAL FINANCE.*Cat. I*

This course is designed to help the student make well-informed judgments when faced with personal financial decisions. Such decisions are growing in number and complexity, and both individuals and families need a considerable degree of financial expertise in order to utilize optimally their limited incomes.

Principal topics include: insurance (medical, life, automobile and disability), consumer credit, estate planning, taxation, personal investments (real estate, securities, etc.), social security legislation and personal financial planning.

MG 1900. INTRODUCTION TO BUSINESS IN AN INTERNATIONAL ENVIRONMENT.*Cat. I*

This course focuses on the operation of a company conducting business in an international environment. It addresses cultural differences and their importance in international trade and in such business functions as operations, human resources, marketing and accounting. MG 1900 is an appropriate course for all WPI students regardless of a major.

Students may not receive credit for both MG 1050 and MG 1900.

MG 2101. MANAGEMENT ACCOUNTING.*Cat. I*

This course is intended to familiarize the student with the wide variety of ways in which accounting data are used by management as a tool for the attainment of predetermined organizational objectives. The emphasis of the course is on the application of accounting data, rather than on its preparation, and particular attention is given to the use of financial data both in controlling day-to-day activities and planning future operations. Principal topics include: master budgets, cost analysis and classification systems, cost-volume-profit analysis, standard cost accounting and an introduction to capital budgeting.

Recommended background: MG 1100.

MG 2200. FINANCIAL MANAGEMENT.*Cat. I*

The financial and competitive status of a company at any given point in time can usually be attributed to prior management decisions. In this course, the student will learn how to use several financial models that together, serve as a sound theoretical framework for analyzing the three types of financial decisions faced by the financial manager. These are 1. investing decisions, 2. financing decisions, and 3. working capital management decisions. The impact of managerial decisions on the financial statements is emphasized. In addition, ethical conduct and global issues relating to the core concepts in the course are explored.

Recommended background: MG 1100 and MA 2611.

Students may not receive credit for both MG/IE 2200 and MG 2200.

MG 2250. FINANCIAL SYSTEM OF THE UNITED STATES.*Cat. II*

An analysis of how the financial system of the United States has developed and contributes to the achievement of broad national economic goals as high national income, satisfactory economic growth, stable prices, and equilibrium in balance of payments with other countries. Emphasis is placed on the theory of the supply and demand for short-term money and long-term capital, and the resultant effect on interest rates.

Primary concentration on the sources and uses of funds of the major non-bank financial institutions, such as insurance companies, pension funds, mutual funds, finance companies, savings and loan banks and mutual savings banks. A discussion of the reforms of financial institutions, and of money and capital markets to more efficiently allocate the scarce resources of the country.

This course is intended to serve the business major and other students interested in understanding the role of financial intermediaries in the United States economy.

Suggested background: some knowledge of accounting and economics will be helpful in taking this course.

This course will be offered in 2003-04 and in alternating years thereafter.

MG 2260. INVESTMENT AND SECURITY ANALYSIS.*Cat. I*

This course is designed to provide an introduction to the language and methodology of security analysis. It is intended to serve two different groups of students: those interested in the subject from the viewpoint of intelligent management of their own portfolios, and those students who have a possible career interest in some facet of the securities industry. Principal topics include: institutional structure and language of the securities market; investment research; alternative investment opportunities; financial statement analysis; fundamental evaluation of common stocks, preferred stocks and bonds; technical analysis; and business cycle analysis.

Recommended background: MG 1100 and SS 1120.

MG/IE 2300. ORGANIZATIONAL SCIENCE—FOUNDATION.*Cat. I*

This first course in organizational science provides the foundation for an understanding of organization and management. It is a survey of the social science of work, describing the basic knowledge and processes required of managers, including: motivation, communication, supervision, leadership, the group processes of decision making, conflict, work and organizational design, and reconciliation of the goals of individuals and organizations. Lecture, video presentation, group discussion and group mini-projects will be employed to introduce and illustrate the basic elements of management.

MG/IE 2500. MANAGEMENT SCIENCE I: DETERMINISTIC DECISION MODELS.*Cat. I*

This course is designed to provide an introduction to a variety of tools and techniques found useful by modern industrial engineers, operations researchers and managers. These tools are oriented toward the creation and use of mathematical models to assist in managerial decision making in business and other organizations.

The models discussed in this course deal with deterministic decision-making problems where there are constraints on available actions. Discussion centers on "classical" methods of optimization and basic methods of linear programming. It is expected that the student will develop an ability to recognize situations in which a given technique is appropriate.

Recommended background: knowledge of calculus.

MG 2720. BUSINESS APPLICATION DEVELOPMENT TOOLS.*Cat. I*

This course introduces students to the concepts and principles of visual, object-oriented techniques for the development of business applications. Students will use commercial, computer-based development tools and rapid development and prototyping techniques for the design of small business applications for such areas as customer tracking, order processing, and financial analysis.

Recommended background: CS 1005 or CS 1006, or ability to program in a higher level programming language.

MG/IE 2850. ENGINEERING ECONOMICS.*Cat. I*

To aid all engineering students in understanding economics and business constraints on engineering decision making.

Topics include evaluation of alternative; the six time-value-of-money factors; present worth, annual cash flow and rate-of-return analysis; incremental analysis; depreciation and income taxes; replacement analysis; inflation; handling probabilistic events; public economy; break-even and minimum cost points; and foreign exchange.

MG 2950. BUSINESS LAW AND ETHICS.*Cat. I*

Imparts an understanding of how law, ethics, and public policy affect modern business. Approximately two thirds of the term is devoted to coverage of fundamental substantive areas of business law (torts, contracts, property, business organizations), public policies (regulatory and promotional), and approaches to ethical analysis for decision-making. Particular attention is paid to technology-based enterprises (e.g. intellectual property, environmental regulation). The concluding portion of the course involves all students in examination of current cases in which law, ethics and human, societal and global concerns intersect with business decision-making today.

MG/IE 3351. ORGANIZATIONAL SCIENCE—MANAGEMENT OF CHANGE.*Cat. I*

This second course in organizational science provides experience in applying theories of organization and management to the analysis and implementation of organizational change. The course utilizes readings, experiential activities, and case studies of change management in technology-based organizations to provide a conceptual understanding as well as practical knowledge of the change management process. The course is designed as a seminar and workshop.

Recommended background: MG/IE 2300 or consent of the professor.

MG/IE 3400. PRODUCTION SYSTEM DESIGN.*Cat. I*

This course is an introduction to the planning, analysis and design of production systems. It is designed for students in engineering or management who may wish to assume responsibilities in the production of goods or services. Topics to be covered will include: operations strategy, project management, quality management, process analysis, capacity management, and just-in-time and lean systems.

Recommended background: Differential and integral calculus.

MG/IE 3401. PRODUCTION PLANNING AND CONTROL.*Cat. I*

This course is an introduction to the planning and control of production systems. Topics include: forecasting, scheduling, material management, and statistical process control.

Recommended background: MG/IE 3400, MA 2611, and differential and integral calculus.

MG/IE 3405. WORK SYSTEMS AND FACILITIES PLANNING.*Cat. I*

This course covers the fundamentals of developing efficient layouts for production and service facilities. Methods analysis, work measurement, material handling and material flow analysis are also covered. Mathematical models and computer tools are used to assist decision-making.

Recommended background: MG/IE 2500 and MG/IE 3400.

MG/IE 3420. QUALITY PLANNING, DESIGN AND CONTROL.*Cat. I*

This course focuses on the quality aspects of product design and manufacturing. Topics include: the quality/cost relationship, statistical process control, process capability studies, and design of experiments.

Recommended background: MG/IE 3400 and MA 2612 or consent of the instructor.

MG/IE 3450. HUMAN FACTORS ENGINEERING.*Cat. I*

This course examines the human-machine interface in the workplace, concentrating on how workplace design can influence effectiveness and enhance health, safety, and satisfaction. Human sensory, motor, and decision systems are studied, as well as principles for designing visual and auditory displays, control devices and tools, and work spaces. Problems with repetitive and high physical effort tasks, illumination, noise, and atmospheric conditions, along with relevant governmental regulations, are also considered.

MG/IE 3460. SIMULATION MODELING AND ANALYSIS.*Cat. I*

This course covers the application of simulation to a variety of managerial problems with examples from operations management, industrial engineering and manufacturing engineering. It introduces the student to the concepts of computer

simulation, with an emphasis on the design of a simulation experiment and statistical interpretation of its results. It will discuss simulation of queueing models, inventory and industrial dynamics, and gaming situations. The role and use of computers for the execution of simulations will also be highlighted.

A commercial simulation language such as SIMAN will be used to solve problems from the manufacturing and service industries.

Recommended background: CS 1005, or CS 1006, and MA 2612.

MG/IE 3501. MANAGEMENT SCIENCE II: RISK ANALYSIS.*Cat. I*

This course provides coverage in decision analysis. Decision analysis is a technology that assists decision makers in quantifying consideration of complexity and uncertainty in problems of choice. The course applies decision analysis to problems in risk assessment and risk evaluation. Decision making in risk analysis is examined across a wide set of management engineering problems including case studies in environmental risk, product liability, facilities design, and R and D management. The course is intended to be highly integrative with respect to risk analysis including issues such as business ethics and risk communication.

Suggested background: knowledge of calculus and introductory probability and statistics.

MG 3600. MARKETING MANAGEMENT.*Cat. I*

This class is designed to give students a broad overview of diverse topics in marketing management. After this class, students should have a solid understanding of the main concepts and principles of marketing, and be able to apply them to actual business situations. The course demonstrates the application of various social science concepts and methodologies in the marketing context. Topics include: The Marketing Environment, International Marketing, Market Research, Consumer Behavior, Business-to-Business Marketing, Services Marketing, Market Segmentation, New Product Development, Channels, Marketing Communications, Personal Selling, and Pricing.

MG 3640. MANAGEMENT OF PROCESS AND PRODUCT INNOVATION.*Cat. II*

This course is based on the hypothesis that high performance firms depend on a sustainable pattern of new and innovative processes and products. Successful companies are examined in regard to their strategies for innovation and technology transfer. Technology alliances among industry, universities, and government are considered in order to increase the leverage of the individual firm. Benchmarking and commercialization from research to actualization is discussed through cases and examples.

Recommended background: MG/IE 2200 or MG/IE 2850.

Students may not receive credit for both MG/IE 3440 and MG 3640.

MG 3651. INDUSTRIAL MARKETING.*Cat. II*

Provides an understanding of the industrial marketing process and practices. It presents the latest concepts, tools and techniques for marketing complex products and services to industrial and institutional users. Topics include: product innovation strategies; purchasing management and buyer behavior; major intelligence; pricing strategies and tactics; developing markets for new industrial products; bid proposals; industrial distribution; managing the industrial sales force; marketing controls.

This course will be offered in 2004-05 and in alternating years thereafter.

MG 3700. INFORMATION SYSTEMS MANAGEMENT.*Cat. I*

This course introduces students to the management of information technology within complex organizations. It covers the range of information technologies employed by business organizations and the manner in which they are deployed. The course places special emphasis on the management of information resources from a user and manager point of view and will help students understand how particular technological arrangements can facilitate achievement of organizational goals. The impact of information technology on management control, organizational structure, individual workers, relationships between organizations, and business transformational will be discussed. Students may not receive credit for both MG 2700 and MG 3700.

Recommended background: MG 2101 and MG 2300 or equivalent business background.

MG/IE 3720. BUSINESS DATA MANAGEMENT.*Cat. I*

This course introduces students to the theory and practice of database management and the application of database software to implement business information systems that support managerial and operational decision making. Special topics covered include relational data models, query languages, normalization, locking, concurrency control and recovery. The course covers data administration and the design of data tables for computerized databases. Students will use a commercial database package to design and implement a small business database application. Students may not receive credit for both MG 4700 and MG 3720.

Recommended background: MG 2720 or equivalent knowledge.

MG 3740. ORGANIZATIONAL APPLICATIONS OF TELECOMMUNICATIONS.*Cat. I*

Students taking this course will develop an understanding of how organizations can effectively use telecommunications technology to enhance business functionality. Students will analyze the development of organizational communications infrastructures and their use for the development of "virtual" organizational structures and to support globally-distributed organizations. The course will begin with a survey of the concepts and technologies which form the basis of a business telecommunications system and which allow the merging of voice, data and video in an integrated multimedia communications structures. Students may not receive credit for both MG 4701 and MG 3740.

Recommended background: MG 2710 and MG 3700.

Students may not receive credit for both MG/IE 3740 and MG 3740.

MG 3910. RECOGNIZING AND EVALUATING NEW VENTURE OPPORTUNITIES.*Cat. I*

This course focuses on identifying ideas for new businesses and learning how to evaluate those ideas to determine if they are feasible. Using various opportunity recognition models, students will be expected to come up with a business idea and conduct an analysis of the feasibility of the venture and its fit with the founder.

Recommended background for this course consists of MG/IE 2850 and two of the following: MG 1100, MG 2950, MG 3400, MG 3600, or MG 3700.

Students who completed MG 391X in 1999-2000 may not receive credit for this course.

MG 3920. PLANNING AND LAUNCHING NEW VENTURES.*Cat. I*

This course focuses on business plan development, especially the financial aspects of the plan. The intent is that students will use a feasibility analysis, such as the one completed in MG 3910, and turn that into a complete business plan. Additionally, students will learn about seed capital, venture, and other means of financing new ventures.

Recommended background for this course consists of MG 3910, MG/IE 2850 and two of the following: MG 1100, MG 2950, MG 3400, MG 3600, or MG 3700.

Students may not receive credit for both ID 1050 and MG 3920.

MG 4151. COST ACCOUNTING.*Cat. II*

This course is designed to give basic understanding and skill in the area of cost accumulation to anyone concerned with recording the expenses associated with a given activity or project.

Cost accounting provides data for three major purposes: 1) planning and controlling routine operations, 2) making non-routine decisions, and 3) inventory valuation and income determination. All three are important, but the course stresses the first two as they relate to project activity.

The goal of the course is to put cost accounting in focus as a highly useful technique in any decision-making situation where expense levels are important. While some attention is directed toward accounting systems and procedures for data accumulation, stress is given to the theme that cost accounting is a vital and dynamic tool for problem-solving.

Recommended background: MG 1100.

This course will be offered in 2003-04 and in alternating years thereafter.

MG 4364. HUMAN RESOURCE MANAGEMENT.*Cat. II*

This course in applied organizational sciences introduces concepts and techniques of human resource management. It provides experience in the solution of a variety of human resource problems through classroom exercises and organizational cases, introducing and building upon the basic concepts and techniques of industrial and organizational psychology. The course focuses on changing labor markets, employee recruitment and selection, performance appraisal and compensation, job evaluation, training and development, job design, labor relations, diversity and gender issues in the workplace, government involvement in human resource issues, job satisfaction, and motivation to work.

Recommended background: MG/IE 2300 or agreement of the professor.

This course will be offered in 2004-05 and in alternating years thereafter.

MG 4365. LEADERSHIP IN GROUPS AND ORGANIZATIONS.*Cat. II*

This course considers the essence of leadership in groups and organizations. Specifically, it examines the personal, interpersonal, group, and contextual factors which affect formal and emergent leadership in groups and organizations. It also examines the effectiveness of various leadership approaches and styles under various conditions. Using case studies, simulations, group projects, and selected readings on leadership in groups and organizations, this course will give students an opportunity to assess and develop their own leadership talents.

Recommended background: MG/IE 2300 or consent of the professor.

MG/IE 4410. CASE STUDIES IN INDUSTRIAL ENGINEERING.*Cat. I*

A number of in-depth case studies in operations and industrial engineering are analyzed. The cases will cover both manufacturing and service systems ranging from production system design to operations planning and control.

Recommended background: MG/IE 3400, MG/IE 3401, MG/IE 2500 and MG/IE 3501.

Students may not receive credit for both MG/IE 3410 and MG/IE 4410.

MG/IE 4460. GLOBAL PLANNING AND LOGISTICS.*Cat. II*

This case-based course will examine methods and strategies for managing and controlling material movement, with particular emphasis on international operations, from the purchase of production materials to the control of work in process to the distribution of the finished product. Strategies that will be discussed include the design of international distribution networks, the use of third-party logistics providers, and the creation of links between logistic systems and marketing to create competitive advantage. The course will also explore tactical issues that must be managed to pursue a logistics strategy successfully, including choices regarding means of transportation, packaging, and inventory policies. Underlying themes of the course will be the use of information technologies (such as electronic data interchange and bar coding) and mathematical models to support logistics decision-making.

Recommended background: MG/IE 3400 and MG/IE 2200 or MG/IE 3400 and MG/IE 2850 or consent of professor.

MG/IE 4720. SYSTEMS ANALYSIS AND DESIGN.*Cat. I*

This course integrates students' background in MIS in a one-term project focusing on development of creative solutions to open-ended business and manufacturing problems. The project will utilize systems analysis and design tools such as systems development life cycle, feasibility study, cost-benefit analysis, structured analysis and design. Students will acquire the skills necessary to analyze, develop, implement, and document real-life information systems. Students must be able to organize themselves and the project to complete their work within a seven week term. It is recommended that MIS majors take this course in preparation for their MQP. Students may not receive credit for both MG 3750 and MG 4720.

Recommended background: MG 3720.

MG 4740. E-BUSINESS STRATEGY, ARCHITECTURE AND DESIGN.*Cat. II*

The course focuses on the linkage between organizational strategy and networked information techniques to implement a rich variety of business models in the national and global contexts connecting individuals, businesses, governments, and other organizations to each other. It provides an introduction to e-business strategy and the development and architecture of e-business solutions and their technical components. The course will cover how businesses and consumers use the Internet to exchange information and initiate transactions. Both theoretical concepts and practical skills with appropriate development tools will be addressed within the scope of the class. Students will develop a business plan and put that plan into action through development of an e-business website using commercially available development tools.

Recommended background: CS 1005, CS 1006 or MG 2720 or ability to program in a higher level programming language

This course will be offered 2004-05 and in alternating years thereafter.

MG 4750. MANAGEMENT OF THE IS FUNCTION.*Cat. II*

This course integrates students' background in management policy and business analysis and addresses the practical problems of developing and running an IS organization. It focuses on the planning and management required to assure systems performance and monitoring, systems reliability and quality change management, backup and recovery, security, new technology assessment and implementation, staffing and staff development. Through case studies and mini-projects students will analyze existing structures in industry IS organizations.

Recommended background: MG 3700.

MG 4930. GROWING AND MANAGING NEW VENTURES.*Cat. I*

One of the most troublesome aspects of entrepreneurship is running the business once it is started. This course focuses on techniques to grow the new venture and how to manage both the growth and operations. Considerable emphasis will be placed on expanding existing markets, finding new markets, anticipating the next generation of products, and managing cash flow. This course is the capstone course for both the Entrepreneurship Minor and the Management Minor.

Recommended background for this course consists of five of the following: MG 1100, MG 1900, MG 2101, MG/IE 2300, MG/IE 2850, MG 2950, MG 3400, MG 3600, MG 3700, MG 3910, MG 3920.

Students may not receive credit for both MG 3960 and MG 4930.

IS4-MG SEMINAR*:

Current developments in management seminars will be organized periodically and announced in the *Undergraduate Catalog*. No more than 1/3 credit will be available for this type #4 IS/P.

*Initials of instructors in charge will appear in *Undergraduate Catalog* in addition to a description of seminar to be offered.

MATHEMATICAL SCIENCES

The second digit in mathematical sciences course numbers is coded as follows:

- 0 — Basic
- 2 — Applied mathematics (general)
- 4 — Applied mathematics (differential equations)
- 6 — Statistics and probability
- 8 — Mathematics (general)

MA 1020. CALCULUS I WITH PRELIMINARY TOPICS.

Cat. I (14-week course)

This course includes the topics of MA 1021 and also presents selected topics from algebra, trigonometry, and analytic geometry.

This course, which extends for 14 weeks and offers 1/3 unit of credit, is designed for students whose precalculus mathematics is not adequate for MA 1021.

Although the course will make use of computers, no programming experience is assumed.

MA 1021. CALCULUS I.

Cat. I

This course provides an introduction to differentiation and its applications.

Topics covered include: functions and their graphs, limits, continuity, differentiation, linear approximation, chain rule, min/max problems, and applications of derivatives.

Recommended background: Algebra, trigonometry and analytic geometry.

Although the course will make use of computers, no programming experience is assumed.

MA 1022. CALCULUS II.

Cat. I

This course provides an introduction to integration and its applications.

Topics covered include: inverse trigonometric functions, Riemann sums, fundamental theorem of calculus, basic techniques of integration, volumes of revolution, arc length, exponential and logarithmic functions, and applications.

Recommended background: MA 1021. Although the course will make use of computers, no programming experience is assumed.

MA 1023. CALCULUS III.

Cat. I

This course provides an introduction to series, parametric curves and vector algebra.

Topics covered include: numerical methods, indeterminate forms, improper integrals, sequences, Taylor's theorem with remainder, convergence of series and power series, polar coordinates, parametric curves and vector algebra.

Recommended background: MA 1022. Although the course will make use of computers, no programming experience is assumed.

MA 1024. CALCULUS IV.

Cat. I

This course provides an introduction to multivariable calculus.

Topics covered include: vector functions, partial derivatives and gradient, multivariable optimization, double and triple integrals, polar coordinates, other coordinate systems and applications.

Recommended background: MA 1023. Although the course will make use of computers, no programming experience is assumed.

MA 1031. INTRODUCTION TO ANALYSIS I.

Cat. I

This course provides the fundamentals of mathematical thinking and writing for mathematical proof in analysis. Topics covered include mathematical logic, set theory, functions, cardinality, topology of the real line, limits of sequences.

MA 1032. INTRODUCTION TO ANALYSIS II.

Cat. I

This course uses the tools developed in MA 1031 to explore the theory of differentiability and introduces the Riemann integral. Topics covered include limits and continuity of functions, the intermediate value theorem, differentiation, mean value theorems, l'Hopital's rule, antiderivatives, the Riemann integral, Riemann integrability.

Recommended background: MA 1031

MA 1033. INTRODUCTION TO ANALYSIS III.

Cat. I

This course develops the theory of integration and provides an introduction to series of numbers and series of functions. Topics covered include the Fundamental Theorem of Calculus, integration by parts, change of variable, series, convergence tests, rearrangements

of series, sequences and series of functions, power series, Taylor series.

Recommended background: MA 1032

MA 1034. INTRODUCTION TO ANALYSIS IV.

Cat. I

The course provides a rigorous introduction to multivariable analysis. Topics covered include vector algebra, functions of several variables, partial derivatives, gradient, multiple integrals, Green's theorem, Stokes' theorem, divergence theorem. Recommended background: MA 1033

MA 2051. ORDINARY DIFFERENTIAL EQUATIONS.

Cat. I

This course develops techniques for solving ordinary differential equations.

Topics covered include: introduction to modeling using first-order differential equations, solution methods for linear higher-order equations, qualitative behavior of nonlinear first-order equations, oscillatory phenomena including spring-mass system and RLC-circuits and Laplace transform. Additional topics may be chosen from power series method, methods for solving systems of equations and numerical methods for solving ordinary differential equations.

Recommended background: MA 1024.

MA 2071. MATRICES AND LINEAR ALGEBRA I.

Cat. I

This course provides a study of computational techniques of matrix algebra and an introduction to vector spaces.

Topics covered include: matrix algebra, systems of linear equations, eigenvalues and eigenvectors, least squares, vector spaces, inner products, and introduction to numerical techniques, and applications of linear algebra.

Recommended background: None.

MA 2073. MATRICES AND LINEAR ALGEBRA II.

Cat. I

This course provides a deeper understanding of topics introduced in MA 2071 and also continues the development of those topics. Topics covered include: abstract vector spaces, linear transformations, matrix representations of a linear transformation, characteristics and minimal polynomials, diagonalization, eigenvalues and eigenvectors, inner product spaces.

This course is design primarily for Mathematical Science majors and those interested in the deeper mathematical issues underlying linear algebra.

Undergraduate credit may not be earned both for this course and for MA 3071.

Recommended background: MA 2071.

MA 2201/CS 2022. DISCRETE MATHEMATICS.

Cat. I

This course serves as an introduction to some of the more important concepts, techniques, and structures of discrete mathematics providing a bridge between computer science and mathematics.

Topics include functions and relations, sets, countability, groups, graphs, propositional and predicate calculus, and permutations and combinations.

Students will be expected to develop simple proofs for problems drawn primarily from computer science and applied mathematics.

Intended audience: computer science and mathematical sciences majors.

Recommended background: None.

MA 2210. MATHEMATICAL METHODS IN DECISION MAKING.

Cat. I

This course introduces students to the principles of decision theory as applied to the planning, design and management of complex projects. It will be useful to students in all areas of engineering, actuarial mathematics as well as those in such interdisciplinary areas as environmental studies. It emphasizes quantitative, analytic approaches to decision making using the tools of applied mathematics, operations research, probability and computations. Topics covered include: the systems approach, mathematical modeling, optimization and decision analyses. Case studies from various areas of engineering or actuarial mathematics are used to illustrate applications of the materials covered in this course.

Recommended background: MA 1024. Suggested background: Familiarity with vectors and matrices. Although the course makes use of computers, no programming experience is assumed. Students who have received credit for CE 2010 may not receive credit for MA 2210.

MA 2251. VECTOR AND TENSOR CALCULUS.

Cat. I

This course provides an introduction to tensor and vector calculus, an essential tool for applied mathematicians, scientists, and engineers.

Topics covered include: scalar and vector functions and fields, tensors, basic differential operations for vectors and tensors, line and surface integrals, change of variable theorem in integration, integral theorems of vector and tensor calculus. The theory will be illustrated by applications to areas such as electrostatics, theory of heat, electromagnetics, elasticity and fluid mechanics.

Recommended background: MA 1024.

MA 2271. GRAPH THEORY.

Cat. II

This course introduces the concepts and techniques of graph theory—a part of mathematics finding increasing application to diverse areas such as management, computer science and electrical engineering. Topics covered include:

graphs and digraphs, paths and circuits, graph and digraph algorithms, trees, cliques, planarity, duality and colorability.

This course is designed primarily for Mathematical Science majors and those interested in the deeper mathematical issues underlying graph theory.

Undergraduate credit may not be earned both for this course and for MA 3271.

Recommended background: MA 2071. This course will be offered in 2004-05 and in alternating years thereafter.

MA 2273. COMBINATORICS.

Cat. II

This course introduces the concepts and techniques of combinatorics—a part of mathematics with applications in computer science and in the social, biological, and physical sciences. Emphasis will be given to problem solving. Topics will be selected from: basic counting methods, inclusion-exclusion principle, generating functions, recurrence relations, systems of distinct representatives, combinatorial designs, combinatorial algorithms and applications of combinatorics.

This course is designed primarily for Mathematical Sciences majors and those interested in the deeper mathematical issues underlying combinatorics.

Undergraduate credit may not be earned both for this course and for MA 3273.

Recommended background: MA 2071. This course will be offered in 2003-04 and in alternating years thereafter.

MA 2431. MATHEMATICAL MODELING WITH ORDINARY DIFFERENTIAL EQUATIONS.

Cat. I

This course focuses on the theoretical foundations of ordinary equations while building models for physical and biological systems. Mathematical topics may include methods for solving systems of ordinary differential equations, existence and uniqueness theory, stability theory, phase-plane analysis and limit cycles. Examples will be chosen from electrical and mechanical oscillations, control theory, ecological models and reaction kinetics. Students will learn how to turn a real-life physical or biological problem into a mathematical one and to interpret the mathematical results.

This course is designed primarily for Mathematical Sciences majors and those interested in the deeper mathematical issues underlying mathematical modeling.

Undergraduate credit may not be earned both for this course and for MA 3431.

Recommended background: MA 1024, MA 2051 and MA 2071.

MA 2611. APPLIED STATISTICS I.

Cat. I

This course is designed to introduce the student to data analytic and applied statistical methods commonly used in industrial and scientific applications as well as in course and project work at WPI. Emphasis will be on the practical aspects of statistics with students analyzing real data sets on an interactive computer package.

Topics covered include analytic and graphical representation of data, exploratory data analysis, basic issues in the design and conduct of experimental and observational studies, discrete and continuous probability models, the central limit theorem, and one and two sample point and interval estimation.

Recommended background: MA 1022.

MA 2612. APPLIED STATISTICS II.

Cat. I

This course is a continuation of MA 2611.

Topics covered include tests of hypotheses, simple and multiple regression, one and two-way tables for categorical data, and design and analysis of one factor experiments.

Recommended background: MA 2611.

MA 2621. PROBABILITY FOR APPLICATIONS.

Cat. I

This course is designed to introduce the student to probability.

Topics to be covered are: basic probability theory including Bayes theorem; discrete and continuous random variables; special distributions including the Bernoulli, Binomial, Geometric, Poisson, Uniform, Normal, Exponential, Chi-square, Gamma, Weibull, and Beta distributions; multivariate distributions; conditional and marginal distributions; independence; expectation; transformations of univariate random variables.

Recommended background: MA 1024.

MA 2631. PROBABILITY.

Cat. I

The purpose of this course is twofold:

- To introduce the student to probability. Topics to be covered will be chosen from: axiomatic development of probability; independence; Bayes theorem; discrete and continuous random variables; expectation; special distributions including the binomial and normal; moment generating functions; multivariate distributions; conditional and marginal distributions; independence of random variables; transformations of random variables; limit theorems.
- To introduce fundamental ideas and methods of mathematics using the study of probability as the vehicle. These ideas and methods may include systematic theorem-proof development starting with basic axioms; mathematical induction; set theory; applications of univariate and multivariate calculus.

This course is designed primarily for Mathematical Sciences majors and those interested in the deeper mathematical issues underlying probability theory.

Recommended background: MA 1024.

Undergraduate credit may not be earned both for this course and for MA 2621.

MA 3211. THEORY OF INTEREST.

Cat. I

An introduction to actuarial mathematics is provided for those who may be interested in the actuarial profession.

Topics usually included are: measurement of interest, including accumulated and present value factors; annuities certain; amortization schedules and sinking funds; and bonds.

Recommended background: MA 1024 and the ability to write computer programs.

MA 3212. LIFE CONTINGENCIES.

Cat. I

A continuation of a study of actuarial mathematics with emphasis on the theory and application of contingency mathematics in the areas of life insurance and annuities.

Topics usually included are: survival functions and life tables; life insurance; life annuities; net premiums; and premium reserves.

Recommended background: MA 3211 and MA 2621, or MA 2631.

MA 3231. LINEAR PROGRAMMING.

Cat. I

This course considers the formulation of real-world optimization problems as linear programs, the most important algorithms for their solution, and techniques for their analysis.

Topics covered include: the primal and dual simplex algorithms, duality theory, parametric analysis, network flow models and, as time permits, bounded variable linear programs or interior methods.

Undergraduate credit may not be earned both for this course and for MA 4231.

Recommended background: MA 2071.

MA 3233. DISCRETE OPTIMIZATION.

Cat. II

Discrete optimization is a lively field of applied mathematics in which techniques from combinatorics, linear programming, and the theory of algorithms are used to solve optimization problems over discrete structures, such as networks or graphs.

The course will emphasize algorithmic solutions to general problems, their complexity, and their application to real-world problems drawn from such areas as VLSI design, telecommunications, airline crew scheduling, and product distribution.

Topics will be selected from: Network flow, optimal matching, integrality of polyhedra, matroids, and NP-completeness.

Undergraduate credit may not be earned both for this course and for MA 4233.

Recommended background: At least one of MA 2271, MA 2273 or MA 3231.

This course will be offered in 2004-05 and in alternating years thereafter.

MA 3257/CS 4032. NUMERICAL METHODS FOR LINEAR AND NONLINEAR SYSTEMS.

Cat. I

This course provides an introduction to modern computational methods for linear and nonlinear equations and systems and their applications.

Topics covered include: solution of nonlinear scalar equations, direct and iterative algorithms for the solution of systems of linear equations, solution of nonlinear systems, the eigenvalue problem for matrices. Error analysis will be emphasized throughout.

Recommended background: MA 2071. An ability to write computer programs in a scientific language is assumed.

MA 3457/CS 4033. NUMERICAL METHODS FOR CALCULUS AND DIFFERENTIAL EQUATIONS.

Cat. I

This course provides an introduction to modern computational methods for differential and integral calculus and differential equations.

Topics covered include: interpolation and polynomial approximation, approximation theory, numerical differentiation and integration, numerical solutions of ordinary differential equations. Error analysis will be emphasized throughout.

Recommended background: MA 2051. An ability to write computer programs in a scientific language is assumed. Undergraduate credit may not be earned for both this course and for MA 3255/CS 4031.

MA 3471. ADVANCED ORDINARY DIFFERENTIAL EQUATIONS.

Cat. II

The first part of the course will cover existence and uniqueness of solutions, continuous dependence of solutions on parameters and initial conditions, maximal interval of existence of solutions, Gronwall's inequality, linear systems and the variation of constants formula, Floquet theory, stability of linear and perturbed linear systems. The second part of the course will cover material selected by the instructor. Possible topics include: Introduction to dynamical

systems, stability by Lyapunov's direct method, study of periodic solutions, singular perturbation theory and nonlinear oscillation theory.

Undergraduate credit may not be earned both for this course and for MA 4471.

Recommended background: MA 2431 and MA 3832.

This course will be offered in 2003-04 and in alternating years thereafter.

MA 3475. CALCULUS OF VARIATIONS.

Cat. II.

This course covers the calculus of variations and select topics from optimal control theory. The purpose of the course is to expose students to mathematical concepts and techniques needed to handle various problems of design encountered in many fields, e. g. electrical engineering, structural mechanics and manufacturing.

Topics covered will include: derivation of the necessary conditions of a minimum for simple variational problems and problems with constraints, variational principles of mechanics and physics, direct methods of minimization of functions, Pontryagin's maximum principle in the theory of optimal control and elements of dynamic programming.

Undergraduate credit may not be earned both for this course and for MA 4475.

Recommended background: MA 2051.

This course will be offered in 2004-05 and in alternating years thereafter.

MA 3627. APPLIED STATISTICS III.

Cat. II

This course continues the exploration of statistics for scientific and industrial applications, begun in MA 2611 and MA 2612. Topics will be chosen from distribution-free methods, the design and analysis of general factorial experiments, two-level factorial and fractional factorial experiments, Taguchi methods, response surface analysis, and statistical quality control.

Recommended background: MA 2612.

This course will be offered in 2003-04, and in alternating years thereafter.

MA 3631. MATHEMATICAL STATISTICS.

Cat. I

This course introduces students to the mathematical principles of statistics. Topics will be chosen from: Sampling distributions, limit theorems, point and interval estimation, sufficiency, completeness, efficiency, consistency; the Rao-Blackwell theorem and the Cramer-Rao bound; minimum variance unbiased estimators and maximum likelihood estimators; tests of hypotheses including the Neyman-Pearson lemma, uniformly most powerful and likelihood ratio tests.

Recommended background: MA 2631.

MA 3823. GROUP THEORY.

Cat. II

This course provides an introduction to one of the major areas of modern algebra. Topics covered include: groups, subgroups, permutation groups, normal subgroups, factor groups, homomorphisms, isomorphisms and the fundamental homomorphism theorem. Recommended background: MA 2073.

This course will be offered in 2004-05 and in alternating years thereafter.

Undergraduate credit may not be earned both for this course and for MA 3821.

MA 3825. RINGS AND FIELDS.

Cat. II

This course provides an introduction to one of the major areas of modern algebra. Topics covered include: rings, integral domains, ideals, quotient rings, ring homomorphisms, polynomial rings, polynomial factorization, extension fields and properties of finite fields. Recommended background: MA 2073.

This course will be offered in 2003-04 and in alternating years thereafter.

Undergraduate credit may not be earned both for this course and for MA 3821.

MA 3831. ADVANCED CALCULUS I.

Cat. I

Advanced Calculus is a two-part course giving a rigorous presentation of the important concepts of classical real analysis.

Topics covered in the two-course sequence include: basic set theory, elementary topology of Euclidean spaces, limits and continuity, differentiation Riemann-Stieltjes integration, infinite series, sequences of functions, and topics in multivariate calculus.

Recommended background: MA 2051 and MA 2071.

MA 3832. ADVANCED CALCULUS II.

Cat. I

MA 3832 is a continuation of MA 3831.

For the contents of this course, see the description given for MA 3831.

Recommended background: MA 3831.

MA 4213. RISK THEORY.

Cat. II

This course covers topics in risk theory as it is applied, under specified assumptions, to insurance.

Topics covered include: economics of insurance, short term individual risk models, single period and extended period collective risk models, and applications.

Recommended background: MA 2631.

This course will be offered in 2003-04 and in alternating years thereafter.

MA 4214. SURVIVAL MODELS.

Cat. II

Survival models are statistical models of times to occurrence of some event. They are widely used in areas such as the life sciences and actuarial science (where they model such events as time to death, or to the development or recurrence of a disease), and engineering (where they model the reliability or useful life of products or processes). This course introduces the nature and properties of survival models, and considers techniques for estimation and testing of such models using realistic data.

Topics covered will be chosen from: parametric and nonparametric survival models, censoring and truncation, nonparametric estimation (including confidence intervals and hypothesis testing) using right-, left-, and otherwise censored or truncated data.

Recommended background: MA 3631.

This course will be offered in 2004-05, and in alternating years thereafter.

MA 4235. MATHEMATICAL OPTIMIZATION.

Cat. II

This course explores theoretical conditions for the existence of solutions and effective computational procedures to find these solutions for optimization problems involving nonlinear functions.

Topics covered include: classical optimization techniques, Lagrange multipliers and Kuhn-Tucker theory, duality in nonlinear programming, and algorithms for constrained and unconstrained problems.

Recommended background: Vector calculus at the level of MA 2251.

This course will be offered in 2003-04 and in alternating years thereafter.

MA 4237. PROBABILISTIC METHODS IN OPERATIONS RESEARCH.

Cat. II

This course develops probabilistic methods useful to planners and decision makers in such areas as strategic planning, service facilities design, and failure of complex systems.

Topics covered include: decisions theory, inventory theory, queuing theory, reliability theory, and simulation.

Recommended background: Probability theory at the level of MA 2621 or MA 2631.

This course will be offered in 2003-04 and in alternating years thereafter.

MA 4291. APPLICABLE COMPLEX VARIABLES.

Cat. I

This course provides an introduction to the ideas and techniques of complex analysis that are frequently used by scientists and engineers. The presentation will follow a middle ground between rigor and intuition.

Topics covered include: complex numbers, analytic functions, Taylor and Laurent expansions, Cauchy integral theorem, residue theory, and conformal mappings.

Recommended background: MA 1024 and MA 2051.

MA 4411. NUMERICAL ANALYSIS OF DIFFERENTIAL EQUATIONS.

Cat. II

This course is concerned with the development and analysis of numerical methods for differential equations.

Topics covered include: well-posedness of initial value problems, analysis of Euler's method, local and global truncation error, Runge-Kutta methods, higher order equations and systems of equations, convergence and stability analysis of one-step methods, multistep methods, methods for stiff differential equations and absolute stability, introduction to methods for partial differential equations.

Recommended background: MA 2071 and MA 3457/CS 4033. An ability to write computer programs in a scientific language is assumed.

This course will be offered in 2004-05, and in alternating years thereafter.

MA 4451. BOUNDARY VALUE PROBLEMS.

Cat. I

Science and engineering majors often encounter partial differential equations in the study of heat flow, vibrations, electric circuits and similar areas. Solution techniques for these types of problems will be emphasized in this course.

Topics covered include: derivation of partial differential equations as models of prototype problems in the areas mentioned above, Fourier Series, solution of linear partial differential equations by separation of variables, Fourier integrals and a study of Bessel functions.

Recommended background: MA 1024 or and MA 2051.

MA 4473. PARTIAL DIFFERENTIAL EQUATIONS.

Cat. II

The first part of the course will cover the following topics: classification of partial differential equations, solving single first order equations by the method of characteristics, solutions of Laplace's and Poisson's equations including the construction of Green's function, solutions of the heat equation including the construction of the fundamental solution, maximum principles for elliptic and parabolic equations. For the second part of the course, the instructor may choose to expand on any one of the above topics.

Recommended background: MA 2251 and MA 3832.

This course will be offered in 2004-05 and in alternating years thereafter.

MA 4631. PROBABILITY AND MATHEMATICAL STATISTICS I.*Cat. I (14 week course)*

Intended for advanced undergraduates and beginning graduate students in the mathematical sciences and for others intending to pursue the mathematical study of probability and statistics, this course begins by covering the material of MA 3613 at a more advanced level. Additional topics covered are: one-to-one and many-to-one transformations of random variables; sampling distributions; order statistics, limit theorems.

Recommended background: MA 2631 or MA 3613, MA 3831 - MA 3832.

MA 4632. PROBABILITY AND MATHEMATICAL STATISTICS II.*Cat. I (14 week course)*

This course is designed to complement MA 4631 and provide background in principles of statistics.

Topics covered include: point and interval estimation; sufficiency, completeness, efficiency, consistency; the Rao-Blackwell theorem and the Cramer-Rao bound; minimum variance unbiased estimators, maximum likelihood estimators and Bayes estimators; tests of hypothesis including uniformly most powerful, likelihood ratio, minimax and bayesian tests.

Recommended background: MA 3631 or MA 4631.

MA 4658. STATISTICAL CONSULTING.*Cat. I (14 week course)*

After suitable preparation through readings and discussion, undergraduate students will learn about statistical practice as part of a statistical consulting team consisting of undergraduate and graduate students. The team will provide statistical expertise to clients from the WPI community under faculty supervision. There are no formal prerequisites, but knowledge of a range of statistical methodology, such as that supplied by MA 2611-12 and MA 3627, is strongly recommended.

MA 4891. TOPICS IN MATHEMATICS.*Cat. I*

MECHANICAL ENGINEERING

For a detailed description of each of these courses, check the video tape index at the Gordon Library.

The second digit in mechanical engineering course numbers is coded as follows:

- 0 — General mechanical engineering
- 1 —
- 2 —
- 3 — Design
- 4 — Thermal—fluids
- 5 — Engineering mechanics
- 6 — Fluid mechanics—hydraulics
- 7 — Aerospace
- 8 — Materials
- 9 — Engineering experimentation

ME 1520. THE TECHNOLOGY OF ALPINE SKIING.*Cat. II*

This course explores science and engineering issues associated with equipment and technique for alpine skiing, particularly racing. A diverse group of technical subjects related to engineering mechanics are discussed: tribology, beams, rigid body motion, material science, machining and biomechanics. Specifically we will examine: ski-snow interactions, technique for gliding, turning and stepping, selection of line in racing; equipment design, testing and performance; and ski injuries. We will also address issues in the epidemiology of skiing injuries, the calculation of the cost of ski injuries to society, the impact of ski equipment technology on litigation and the impact of litigation on equipment and trail design.

This course will be offered in 2003-04, and in alternating years thereafter.

ME 1800. MATERIALS SELECTION AND MANUFACTURING PROCESSES.*Cat. I*

This course is designed to introduce the student to the engineering fundamentals of the most commonly encountered manufacturing processes. A thorough treatment of manufacturing processes including forging, rolling, drawing, EDM, PM, welding, casting, and machining are developed through a combination of class work and manufacturing laboratory experience. The laboratory experience includes an experimental component measuring and analyzing a manufacturing process and system. Each student is required to fabricate and assemble his/her own Stirling engine.

This course is recommended for all majors, for students who plan to utilize the manufacturing laboratory facilities as part of their MQP work, or for those students who wish a fundamental background in materials processing.

ME 2300. INTRODUCTION TO ENGINEERING DESIGN.*Cat. I*

Real world engineering design problems usually have more than one correct solution. This course utilizes a realistic design process to introduce students to the methods and techniques for solving engineering problems. Lectures will support the design projects and may cover engineering economics, fluid dynamics, heat transfer, mechanics, statistics, and basic circuits. No prior knowledge of fluids, heat transfer, economics, statistics or electrical circuits is required. Laboratory sessions will be used to build, test and demonstrate various designs.

This course is designed for sophomores and juniors to provide a broad overview of engineering design.

The course includes a significant writing component and makes extensive use of PCs for word processing, spread sheet calculations and programming.

Recommended background: Calculus, MA 2051, PH 1110, ES 2501, and any programming language (BASIC, Fortran, Pascal, C).

Recommended background: Ordinary Differential Equations (MA 2051), mechanics (PH 1110), statics (ES 2501), any programming language.

ME 2713. ASTRONAUTICS.*Cat. I*

Topics studied: Orbital mechanics including spacecraft maneuvering and station keeping, transfer orbits, and interplanetary transfers; space environment including characteristics of low earth highly elliptical and geosynchronous orbits; ascent and reentry trajectories.

Recommended background: Dynamics (ES 2503).

ME 2820. MATERIALS PROCESSING.*Cat. I*

An introduction to material processing in manufacturing. This course provides important background for anyone interested in manufacturing, design engineering design, sales, or management.

Processing of polymers, ceramics, metals and composites is discussed. Processes covered include: rolling, injection molding, forging, powder metallurgy, joining and machining. The relationships between materials, processes, processing parameters and the properties of manufactured parts are developed. During the course the students should develop the ability to choose materials, processes, and processing parameters for designing manufacturing procedures to take a prototype part to production.

Recommended background: ME 1800 Materials Selection and Manufacturing Processes, and ES 2001 Introduction to Materials Science.

ME 3023. MECHANICAL BEHAVIOR AND MODELING PROPERTIES OF ENGINEERING MATERIALS.*Cat. I*

This course is concerned with different types of material response to mechanical loads. The course studies the constitutive equations that are used to model the properties of engineering materials. The behavior of elastic, plastic, composite and visco-elastic materials is considered. Experiments describing materials behaviors will be conducted and the behavior will be modeled.

Topics include: descriptions of material behavior, methods of determining the material parameters from experimental tests, behavior of different types of materials under simple states of loading and deformation such as tensile stress-strain response (elastic and plastic), and time-dependent behavior at room and elevated temperature (viscoelasticity and creep) are studied. Theories of failure and failure modes under monotonic and cyclic loading, fracture and fracture mechanics, and methods of modifying material behavior are discussed. These topics will be integrated in several material selection projects.

Recommended background: statics (ES 2501), stress analysis (ES 2502), continuum mechanics (ES 3501), materials (ES 2001).

ME 3310. KINEMATICS OF MECHANISMS.*Cat. I*

An introduction to the synthesis and analysis of linkages, cams and gear trains is presented. The design process is introduced and used to solve unstructured design problems in linkage and cam design. Algebraic and graphical techniques to analyze the displacement, velocity and acceleration of linkages and cams are developed. Computer programs for the design and analysis of linkages are used by students. Results of student design projects are presented in professional engineering reports.

Recommended background: Ordinary Differential Equations (MA 2051), statics (ES 2501), dynamics (ES 2503).

ME 3311. DYNAMICS OF MECHANISMS AND MACHINES.*Cat. I*

This course provides an in-depth study of forces in dynamic systems. Dynamic force analysis is developed using matrix methods. Computer programs are used to solve the sets of simultaneous equations derived by students for realistic, unstructured design problems. Inertial and shaking forces, elementary mechanical vibrations, torque-time functions, rotational and reciprocating balance and cam dynamics are covered using the internal combustion engine as a design example. Students execute unstructured design projects and prepare professional engineering reports on the results. Computers are used extensively to solve the dynamic equations.

Recommended background: Ordinary Differential Equations (MA 2051), statics (ES 2501), dynamics (ES 2503), kinematics (ME 3310), linear algebra.

ME 3320. DESIGN OF MACHINE ELEMENTS.*Cat. I*

This is an introductory course in mechanical design analysis, and it examines stress and fatigue in many machine elements. Common machine elements are studied and methods of selection and design are related to the associated hardware.

Topics covered include: combined stresses, fatigue analysis, design of shafts, springs, gears, bearings and miscellaneous machine elements.

Recommended background: mechanics (ES 2501, ES 2502, ES 2503), materials (ME 1800, ME 2820), computer programming (CS 1001).

ME 3321. DYNAMIC MODELING.*Cat. I*

This course introduces students to the modeling and analysis of dynamic systems. A unified treatment of mechanical, electrical, fluid and thermal systems is presented using the bond graph modeling language. The creation of dynamic models and the analysis of model response is emphasized.

Lecture topics include energy storage and dissipation elements, transducers, transformers, formulation of equations for a dynamic system and time response of linear systems. Computers are used extensively for both system modeling and analysis.

Recommended background: mathematics (MA 2051, MA 2071), fluids (ES 3004), mechanics (ES 2501, ES 2503).

ME 3410. COMPRESSIBLE FLOW.*Cat. I*

The application of basic thermodynamics and fluid mechanics to model the flow phenomena of compressible fluids. The assumptions leading to various flow models and the limits of these models are emphasized. The approach is, in the main, a one-dimensional control volume analysis, and the course is designed for engineering students.

Topics covered include: reversible flow, flow with heat transfer, flow with friction, normal and oblique shock waves, flow with chemical reaction, and flow with applied electric and magnetic fields.

Recommended background: thermodynamics (ES 3001), fluids (ES 3004).

ME 3501. ELEMENTARY CONTINUUM MECHANICS.*Cat. I*

In typical mathematics courses, students learn principles and techniques by solving many short and specially prepared problems. They rarely gain experience in formulating and solving mathematical equations that apply to real life engineering problems. This course will give students this type of applied mathematical experience.

The course emphasizes the application of basic laws of nature as they apply to differential elements which lead to differential equations that need to be solved; all of these ideas are used in higher level engineering science courses such as fluid mechanics, heat transfer, elasticity, etc. Emphasis will be placed on understanding the physical concepts in a problem, selecting appropriate differential elements, developing differential equations, and finding ways to solve these equations. Limitations on the mathematical solutions due to assumptions made will be considered.

Recommended background: Ordinary Differential Equations (MA 2051), statics (ES 2501), dynamics (ES 2503).

ME 3502. ADVANCED MECHANICS OF MATERIALS.*Cat. I*

An intermediate level course in stress analysis suitable for students in engineering mechanics, design, and materials sciences.

Topics included are: non-symmetric bending, torsion of non-circular bars, pressure vessels, elastic stability, energy methods in mechanics, beams on elastic foundations and other advanced topics in stress analysis.

Recommended background: Ordinary Differential Equations (MA 2051), statics (ES 2501), stress analysis (ES 2502).

ME 3506. REHABILITATION ENGINEERING.*Cat. I*

The course exposes the students to the use of technology to design devices to ameliorate the handicaps of individuals with disabilities. This course focuses on the design process for assistive devices including defining the problem, setting design criteria, developing preliminary designs, selecting, analyzing and testing a final design. Human factors are integrated into all phases of the design process.

Topics include: ergonomics, physical and cognitive parameters that effect the user interface, safety, economics, reliability and esthetics. Design and analysis of devices used for mobility and in daily activities in residential, educational and vocational settings. Laboratory sessions will be used to develop conceptual designs that solve real problems.

Recommended background: mechanics (ES 2501, ES 2502, ES 2503), kinematics (ME 3310), design (ME 2300), materials (ME 1800, ME 2820), electrical engineering (EE 3601).

ME 3601. PRINCIPLES OF MECHANICAL ENGINEERING*Cat. I*

Intended for students other than mechanical or manufacturing engineering students, this course is oriented towards developing competence in mechanical engineering concepts on the level that the technology interfaces directly with their own discipline. The course is designed specifically to help students meet that challenge through the development of a broad systems perspective and an understanding of the principal elements of mechanical engineering technology. The expectation is that students completing this course will be able to handle adequately the mechanical aspects of a broad range of application topics. In addition, and most important, they will be prepared to work effectively with mechanical engineers on the joint solution of complex problems.

Topics covered during the course include, but are not limited to, the fundamentals of: statics, dynamics, kinematics, kinetics, materials, heat transfer, fluid dynamics, thermodynamics, stress analysis, vibrations, error and uncertainty analysis, as well as current trends and future directions in solution methodologies, and will be illustrated with representative applications, such as, electro-thermo-mechanical and viscoelastic systems, electronic packaging, and MEMS. Selected projects are included to emphasize the direct application of the information presented in lectures.

Intended for non-Mechanical Engineering or non-Manufacturing Engineering majors.

Recommended background: MA 1021-1024, MA 2051, CH 1010, PH 1110/1111-PH1120/1121, or equivalent. Intended audience, non-mechanical and manufacturing majors.

ME 3602. INTERMEDIATE FLUID DYNAMICS.*Cat. I*

A second course in fluid mechanics concerned with the application of basic principles. Applications include velocity potentials and stream functions, fluid machinery, pipe networks and unsteady flow. The equations of viscous flow are developed with applications including exact solutions, energy, dissipation and introductory boundary layer theory.

Recommended background: fluids (ES 3004).

ME 3711. AERODYNAMICS.*Cat. I*

A first course in the science and engineering of heavier-than-air flight vehicles.

Topics covered include: application of fluid mechanic and thermodynamic principles to study lift and drag, the effects of viscosity and compressibility, methods of estimating performance, and the elements of stability. The theory of airfoil circulation is developed and used to examine induced drag, downwash, ground effect and vortex wake turbulence.

Methods of characterizing and presenting airfoil performance data are developed and utilized to examine the performance of wings. Propulsion systems, including propellers and their effects on flight performance are discussed. Longitudinal, lateral and turning stability of aircraft are considered for both static and dynamic conditions.

Recommended background: thermodynamics (ES 3001), fluids (ES 3004).

ME 3715. ROCKET AND SPACECRAFT PROPULSION.*Cat. II*

This course provides an introductory study of propulsion systems for launch vehicles and spacecraft. Rocket propulsion systems discussed include solid, liquid-biopropellant and hybrid. Spacecraft propulsion systems discussed include cold gas, solid, liquid and electric. Advanced propulsion and micropropulsion concepts are introduced. Issues associated with combustor, nozzle, and propellant storage and feed systems are discussed.

Recommended background: thermodynamics (ES 3001), fluid mechanics (ES 3004), heat transfer (ES 3003), astronautics (ME 2713), intermediate fluid mechanics (ME 3602), compressible flow (ME 3410) or supersonic aerodynamics (ME 4712).

This course will be offered in 2003-04 and in alternating years thereafter.

ME 3716. AIR BREATHING PROPULSION.*Cat. II*

This course provides a study of air breathing engines for aircraft and ground-based applications. Topics covered include: Thermodynamic cycles and fluid dynamics of aero engines, including gas turbines (turbojets, turbofans, turboprops), ramjets, and scramjets. Performance of specific engine components such as inlets, combustors, nozzles, as well as axial compressors and turbines will be addressed.

Recommended background: thermodynamics (ES 3001), fluid mechanics (ES 3004), aerodynamics I (ME 3711), and compressible flow (ME 3410).

This course will be offered in 2004-05 and in alternating years thereafter.

ME 3811. MICROSTRUCTURE ANALYSIS AND CONTROL.*Cat. I*

An in-depth study of the microstructure and properties of alloy systems in current use.

Topics covered include: interpretation of microstructure and its relationship to engineering properties, and the design of microstructures. Among the alloy systems studied are low alloy steels, alloyed steels, cast irons, copper base alloys, aluminum alloys, titanium alloys, nickel base superalloys and composites.

Recommended background: materials science (ES 2001).

ME 3820. COMPUTER-AIDED MANUFACTURING.*Cat. I*

This introductory course in modern control systems will give students an understanding of the basic techniques, and the range of equipment used in most computer controlled manufacturing operations. The class work is reinforced by hands-on laboratories in the Robotics/CAM lab. Modeling and analysis of machining processes, and applications of PLC (programmable logic control) are included.

Class topics include: Manufacturing Automation, Microcomputers for Process Monitoring and Control, Computer Numerical Control, Switching Theory and Ladder Logic, Transducers and Signal Conditioning, and Closed Loop Digital Control. The laboratories allow students to program and implement several types of the controllers, and will provide an introduction to the topic of industrial robotics.

Recommended background: manufacturing (ME 1800), materials processing (ME 2820), elementary computer/logic device programming.

ME 3901. ENGINEERING EXPERIMENTATION.*Cat. I*

A course designed to develop analytical and experimental skills in modern engineering measurement methods, based on electronic instrumentation and computer-based data acquisition systems. The lectures are concerned with the engineering analysis and design as well as the principles of instrumentation, whereas the laboratory periods afford the student an opportunity to use modern devices in actual experiments.

Lecture topics include: review of engineering fundamentals and, among others, discussions of standards, measurement and sensing devices, experiment planning, data acquisition, analysis of experimental data, and report writing.

Laboratory experiments address both mechanical and thermal systems and instrumentation in either traditional mechanical engineering (heat transfer, flow measurement/visualization, force/torque/strain measurement, motion/vibration measurement) or materials engineering (temperature and pressure measurements in materials processing, measurement of strain and position in mechanical testing of materials). Each year students will be notified which type of experiments will be used in each term offering. Students may also consult with their academic advisor or the Mechanical Engineering department office.

Recommended background: mathematics (MA 2051), thermo-fluids (ES 3001, ES 3003, ES 3004), mechanics (ES 2501, ES 2502, ES 2503), materials (ES 2001).

ME 4010. MECHANICAL ENGINEERING SENIOR SEMINAR.*Cat. I*

For students who will soon be entering the engineering profession.

Current thought on mechanical engineering and related engineering problems presented by staff members and visiting lecturers from the engineering profession. Emphasis is placed on the transition from engineering student to professional engineer.

Registration as a junior or senior is assumed; not for credit.

ME 4320. ADVANCED ENGINEERING DESIGN.*Cat. I*

This course integrates students' background in ME in a one-term design project that is usually taken from a local company. Students must organize themselves and the project to successfully realize a product that meets customer needs. Activities include problem definition, design analysis, mathematical modelling, CAD modelling, manufacturing, testing, liaison to vendors, customer relations, marketing, technical management, purchasing, report writing, and oral presentations.

Recommended background: mechanisms (ME 3310, ME 3311), stress analysis (ES 3502), design (ME 3320), thermo-fluids (ES 3001, ES 3003, ES 3004), materials (ES 2001), manufacturing (ME 1800).

ME 4412. INTRODUCTION TO COMBUSTION.*Cat. II*

This course will be an introduction to chemical and physical aspects of combustion.

Topics covered include thermodynamics of combustion, chemical kinetics, premixed flames, diffusion flames, ignition, detonation, pollutant formation, advanced and conventional combustion systems and combustion measurement techniques.

Course emphasis will be on developing basic understanding of combustion phenomena relevant to engineering applications of combustion. Computer programming and available software may be employed to solve combustion problems.

This course may be used toward a graduate degree by submission of an additional report based on a review of research literature as arranged with the instructor.

Recommended background: thermodynamics (ES 3001), fluids (ES 3004).

This course will be offered in 2003-04 and in alternating years thereafter.

ME 4429. THERMOFLUID APPLICATION AND DESIGN.*Cat. I*

This course integrates thermodynamics, fluid mechanics and heat transfer through the use of design projects involving modern technologies, such as electronic cooling, vapor compression power cycles, and turbines. Activities include problem definition, design creation and analysis, mathematical modeling, cost analysis and optimization.

Recommended background: thermofluids (ES 3001, ES 3003, ES 3004) and an introduction to design.

ME 4430. INTEGRATED THERMOMECHANICAL DESIGN AND ANALYSIS.*Cat. II*

Current state-of-the-art computer based methodologies used in the design and analysis of thermomechanical systems will be presented and illustrated by selected laboratory demonstrations, and used in projects. Projects will include thermal, mechanical, electronic, and photonic loads of steady state and dynamic nature and will integrate design, analysis, and testing. Students will prepare a technical report and present their results. Topics will include, but not be limited to, thermomechanics of fiber optic telecommunication cables, high-energy beam interactions with materials, shape memory alloys, microelectronics, MEMS and mechatronics.

Recommended background: MA 2051, ES 2001, ES 2502, ES 3003, EE 3601, ME 3901, and an introduction to design.

This course will be offered in 2003-04 and in alternating years thereafter.

ME/BE 4504. BIOMECHANICS.*Cat. II*

This course emphasizes the applications of mechanics to describe the material properties of living tissues. It is concerned with the description and measurements of these properties as related to their physiological functions. Emphasis on the interrelationship between biomechanics and physiology in medicine, surgery, body injury and prostheses.

Topics covered include: review of basic mechanics, stress, strain, constitutive equations and the field equations, viscoelastic behavior, and models of material behavior. The measurement and characterization of properties of tendons, skin, muscles and bone. Biomechanics as related to body injury and the design of prosthetic devices.

Recommended background: mechanics (ES 2501, ES 2502, ES 2503, ME 3501), mathematics (MA 2051).

This course will be offered in 2003-04 and in alternating years thereafter.

ME 4505. ADVANCED DYNAMICS.*Cat. II*

This course completes a sequence of sophomore, junior and senior courses in Dynamic Systems, i.e., ES 2503, ME 3505, and ME 4505, which are essential in an undergraduate Mechanical Engineering curriculum. An advanced course intended to emphasize the development and applications of dynamics in three-dimensional space. Problem solutions emphasize the use of vector algebra, matrix methods and differential equations with a goal of developing the student's ability to translate physical problems into mathematical models.

Topics covered include: three-dimensional kinematics using rotating and stationary frames of reference, development of force, energy and momentum equations governing general particle and rigid body systems. Applications of equations to rigid, elastic, and fluid problems.

Recommended background: dynamics (ES 2503).

ME 4506. MECHANICAL VIBRATIONS.*Cat. I*

This course is an introduction to the fundamental concepts of mechanical vibrations, which are important for design and analysis of mechanical and structural systems subjected to time-varying loads. The objective of the course is to expose the students to mathematical modeling and analysis of such systems

Topics covered include: formulation of the equations of motion using Newton's Laws, D'Alembert's Principle and energy methods; prediction of natural frequency for single-degree-of-freedom systems; modeling stiffness characteristics, damping and other vibrational properties of mechanical systems; basic solution techniques by frequency response analysis and convolution integral methods. Examples may include analysis and design for transient passage through resonance; analysis and design of vibration measurement devices; introductory rotordynamics. The course is mainly focused on analysis of single-degree-of-freedom systems, however a basic introduction into multidegree-of-freedom systems is also presented. Computer-based project may be suggested.

Recommended background: Ordinary Differential Equations (MA 2501), Statics (ES 2501), Dynamics (ES 2503).

ME 4512. INTRODUCTION TO THE FINITE ELEMENT METHOD.*Cat. I*

This course serves as an introduction to finite element analysis (FEA) for stress analysis problems. Finite element equations are developed for several element types from stiffness and energy approaches and used to solve simple problems. Element types considered include spring, truss, beam, two-dimensional (plane stress/strain and axisymmetric solid), three-dimensional and plates. Stress concentrations, static failures, and fatigue failures are considered for each element type. Emphasis will be placed on knowing the behavior and usage of each element type, being able to select a suitable finite element model for a given problem, and being able to interpret and evaluate the solution quality. A commercial, general-purpose finite element computer program is used to solve problems that are more complex. Projects are used to introduce the use of FEA in the iterative design process.

Recommended background: Mathematics (MA 2051, MA 2071), Mechanics (ES2501 & ES 2502 or CE2000 & CE2001).

ME 4530. COMPUTATIONAL METHODS IN MECHANICAL ENGINEERING.*Cat. II*

This course teaches the students how to analyze and solve complicated mechanical engineering problems utilizing state-of-the-art numerical analysis methods and digital computer. Some fundamental numerical schemes such as roots of algebraic and transcendental equations; solution of simultaneous algebraic equations; matrix analysis; curve fitting and data interpolation; numerical integration and differentiation; numerical solution of differential equations; symbolic manipulation and numerical solution of linear and nonlinear differential equations; Fourier and frequency response analysis; eigenvalue problems; and other numerical analysis problems are considered. Emphasis will be on modeling, numerical formulation and numerical and symbolic solution of practical problems in mechanical engineering. Fundamentals of FORTRAN programming are also included.

Recommended background: mechanics (ES 2501, ES 2502, ES 2503), mathematics (MA 2051, MA 2071).

ME 4605. COMPUTATIONAL FLUID MECHANICS.*Cat. I*

This course serves as an introduction to the use of finite-difference methods to solve fluid flow problems.

Topics covered include: difference approximations; truncation error and consistency; the development of finite-difference equations from partial differential equations using Taylor series, polynomial fitting, integral methods, and control volumes; algebraic mapping and irregular grid generation; stability; inviscid flow solutions using Gaussian elimination, Thomas' algorithm, Gauss-Seidel, and Successive Over-Relaxation; boundary layer solutions using Dufort-Frankel and Crank-Nicolson; Navier-Stokes solutions using the vorticity transport-stream function and primitive variable approaches.

Recommended background: fluids (ME 3602).

ME/BE 4606. BIOFLUIDS.*Cat. II*

This course emphasizes the applications of fluid mechanics to biological problems. The course concentrates primarily on the human circulatory and respiratory systems. Topics covered include: blood flow in the heart, arteries, veins and microcirculation and air flow in the lungs and airways. Mass transfer across the walls of these systems is also presented.

Recommended background: continuum mechanics (ME 3501), fluids (ES 3004).

This course will be offered in 2004-05 and in alternating years thereafter.

ME 4712. SUPERSONIC AERODYNAMICS.*Cat. II*

This course introduces the study of performance and dynamic behavior of vehicles moving through fluids.

Topics covered include: subsonic and supersonic performance of aircraft and rockets, external flow fields, aerodynamic heating, shock and expansion patterns, control surface interaction, and real gas effects, aerodynamic stability including interaction with structural dynamics. Applications to flutter, dynamic stability, and control system performance.

Recommended background: aerodynamics (ME 3711).

This course will be offered in 2004-05 and in alternating years thereafter.

ME 4715. AEROSPACE STRUCTURES.*Cat. I*

Aircraft and space vehicle structural design including finite element analysis, modal analysis, and thermal loading along with traditional and composite material characteristics and selection for atmospheric and space environment are studied. Flutter, transient response, and large structure dynamics are typical examples used.

Recommended background: mechanics (ES 2501, ES 2502, ES 2503), aerodynamics (ME 3711).

ME 4724. HIGH SPEED FLOW.*Cat. II*

This course will introduce the students to the physical phenomena associated with flows at supersonic/hypersonic speeds. Emphasis will be placed on the hypersonic limit and various models developed to treat the continuum flow at this limit.

Topics covered include: characterization of hypersonic flow, normal shock relations, the piston analogy and shock tube equations, oblique shock waves and expansion fans at the hypersonic limit, similarity methods, the Newtonian model, Mach number independence of the inviscid equations, small disturbance theory for planar and axially symmetric bodies, lift and drag coefficients, dynamics of the viscous portion of the flow, and real gas effects.

Recommended background: thermodynamics (ES 3001), compressible flow (ME 3410), fluid dynamics (ES 3004, ME 3602), aerodynamics (ME 3711).

This course will be offered in 2003-04 and in alternating years thereafter.

ME 4770. AIRCRAFT DESIGN.*Cat. II*

This course introduces students to design of aircraft systems. Students complete a conceptual design of an aircraft in a term-long project. Students must establish design specifications, develop and analyze alternative designs, and justify their design in a written report. The design project incorporates fundamentals of aerodynamics, structures, aircraft performance, aircraft stability, and propulsion into a capstone design experience. The design project culminates in a Conceptual Design Review with oral presentations and a written final report. Design teams, software tools, and technical communication are emphasized.

Recommended background: intermediate fluid mechanics (ME 3602), aerodynamics I (ME 3711), air breathing propulsion (ME 3716), aerospace structures (ME 4715).

This course will be offered in 2003-04 and in alternating years thereafter.

ME 4771. SPACECRAFT AND MISSION DESIGN.*Cat. II*

This course introduces students to design of spacecraft, spacecraft subsystem and space missions. Topics covered in lectures address mission classification and the space environment, the design of subsystems that include spacecraft power and propulsion, attitude dynamics and control, structural, thermal, and communication. Lectures are in parallel with a term-long conceptual design of a spacecraft, spacecraft subsystem or space mission. The design project culminates in a Conceptual Design Review with oral presentations and a written final report. Design teams, software tools, and technical communication are emphasized.

Recommended background: fluid mechanics (ES 3004), heat transfer (ES 3003), control engineering (ES 3011), astronautics (ME 2713), rocket and spacecraft propulsion (ME 3715), aerospace structures (ME 4715).

This course will be offered in 2004-05 and in alternating years thereafter.

ME 4813. CERAMICS.*Cat. II*

A course which develops an understanding of the structure-property relationships in ceramic materials. Content of interest to individuals interested in selecting and using ceramics as engineering materials. Limited material included on theory and practice of producing the initial shape.

Topics covered include: bonding and configuration of atoms in crystalline and noncrystalline materials, phase diagrams, microstructures, and macrostructures. Mechanical, optical and thermal properties as related to structure.

Recommended background: materials (ES 2001).

ME/BE 4814. BIOMATERIALS.*Cat. I*

A course specializing in material selection and special problems associated with biomedical engineering.

Topics covered include: fundamentals of metals, plastics, and ceramics and how they can be applied to biomedical applications. Case histories of successful and unsuccessful material selections. Current literature is the primary source of material.

Recommended background: materials (ES 2001).

ME 4815. INDUSTRIAL ROBOTICS.*Cat. I*

This course introduces students to robotics within manufacturing systems.

Topics include: classification of robots, robot kinematics, motion generation and transmission, end effectors, motion accuracy, sensors, robot control and automation. This course is a combination of lecture, laboratory and project work, and utilizes industrial robots. Through the laboratory work, students will become familiar with robotic programming (using a robotic programming language VAL II) and the robotic teaching mode. The experimental component of the laboratory exercise measures the motion and positioning capabilities of robots as a function of several robotic variables and levels, and it includes the use of experimental design techniques and analysis of variance.

Recommended background: manufacturing (ME 1800), kinematics (ME 3310), control (ES 3011), and computer programming.

ME 4816. MATERIALS OPTIMIZATION FOR ENGINEERS.*Cat. II*

A course designed to synthesize the students' background in materials science and engineering for selecting materials and processing methods in realistic applications. Case studies will cover a wide range of applied problems encountered in materials engineering. Current literature for newer materials and processes will be used.

Recommended background: materials (ME 2820, ME 3811, ME 3823).

This course will be offered in 2004-05 and in alternating years thereafter.

ME 4821. CHEMISTRY, PROPERTIES, AND PROCESSING OF PLASTICS.*Cat. II*

Topics covered include: polymer chemistry, physical and chemical properties, processing methods, selection of materials, comparisons of plastics with metals, design considerations, and new materials. Laboratory studies are included. Use of current literature is stressed.

Recommended background: materials (ES 2001, ME 2820).

ME 4822. SOLIDIFICATION PROCESSES.*Cat. II*

A course designed for in-depth study of industrial processes based on liquid-solid transformation. Fundamentals are developed and applied to commercial processes.

Topics covered include: quantitative treatment of casting and processes, semi-solid forming, laser welding, rapid solidification, spray forming, compocasting and other emerging technologies, which utilize liquid-solid transformations. Library and laboratory work are included.

Suggested background: General understanding of heat flow, fluid flow, diffusion, and metallography.

This course will be offered in 2004-05 and in alternating years thereafter.

ME 4832. CORROSION AND CORROSION CONTROL.*Cat. II*

An introductory course designed to acquaint the student with the different forms of corrosion and the fundamentals of oxidation and electro-chemical corrosion.

Topics covered include: corrosion principles, environmental effects, metallurgical aspects, galvanic corrosion, crevice corrosion, pitting, intergranular corrosion, erosion corrosion, stress corrosion, cracking and hydrogen embrittlement, corrosion testing, corrosion prevention, oxidation and other high-temperature metal-gas reactions.

Recommended background: materials (ES 2001).

This course will be offered in 2004-05 and in alternating years thereafter.

ME 4840. PHYSICAL METALLURGY.*Cat. I*

Fundamental relationships between the structure and properties of engineering materials are studied. Principles of diffusion and phase transformation are applied to the strengthening of commercial alloy systems. Role of crystal lattice defects on material properties and fracture are presented.

Strongly recommended as a senior-graduate level course for students interested in pursuing a graduate program in materials or materials engineering at WPI, or other schools.

Recommended background: materials (ES 2001, ME 2820, ME 3811).

ME 4850. SOLID STATE THERMODYNAMICS.*Cat. I*

Classical and atomistic thermodynamics are developed and applied to the behavior of solids, liquids and gases. Phase equilibria and phase diagrams are discussed. Emphasis is placed on the gas phase reactions and reactions between solids and gases as well as the behavior or solutions. Applications to Materials Engineering processes and phenomena are discussed.

Recommended background: materials (ES 2001), chemistry (CH 1020).

ME 4922. THEORY AND PRACTICE OF LASER INSTRUMENTATION.*Cat. II*

This course introduces and analyzes the fundamentals of optical and image processing techniques applicable to engineering measurements. Optical instrumentation is widely used in high precision position, vibration, and inspection applications in the industrial environment. The goal of this course is to provide a rigorous background in the basic principles preparing the student for the more advanced courses on laser instrumentation. The course will include both in-class lectures and laboratories. Topics to be covered include: accelerated review of light, waves, and polarization; basic building blocks including lenses, detectors, optical components, and fiber optics; interferometry and coherence; basic holography and speckle; infrared temperature measurement; stress birefringence; basic video, imaging, and digital image processing.

Recommended background: mathematics (MA 2051), experimentation (ME 3901).

Suggested background: physics (PH 1140).

This course will be offered in 2004-05 and in alternating years thereafter.

IS/P. SPECIAL TOPICS.*Cat. I*

For students who wish to pursue in depth various mechanical engineering topics.

Topics covered include: theoretical or experimental studies in subjects of interest to mechanical engineers.

Registration as a junior or senior is assumed.

MILITARY SCIENCE

The intent of the Military Science program of courses is that they be taken in sequential order. Any student who wishes to depart from this recommendation must consult with the Military Science department head.

MS 1011 and MS 1021 will appear on the WPI transcript as a zero credit course with a grade. Successful completion of MS 1011 and MS 1012 earns 1/9 unit in MS 1012. Successful completion of MS 1021 and MS 1022 earns 1/9 unit in MS 1022.

ML 1011. FOUNDATIONS OF OFFICERSHIP I.*Cat. I (0 units w/grade)*

Introduction to issues and competencies that are central to a commissioned officer's responsibilities. Establishes a framework for understanding officership, leadership, and Army values. Additionally, the semester addresses "life skills" including fitness and time management.

Participation in leadership laboratories and participation in off-campus training sessions (field training exercise) is also required.

ML 1012. FOUNDATIONS OF OFFICERSHIP II.*Cat. I (1/9 unit after completion of 1011 and 1012)*

This course continues the studies begun in ML 1011. Students make oral presentations on the elements of leadership, enhancing effective communication. Students begin to develop leadership potential by instilling self-confidence and fostering teamwork through basic survival techniques (e.g., water survival).

Participation in leadership laboratories and participation in off-campus training sessions (field training exercise) is also required.

ML 1021. BASIC LEADERSHIP I.*Cat. I (0 units w/grade)*

ML 1021 expands upon the fundamentals introduced in the previous term by focusing on communications, leadership, and problem solving. "Life skills" lessons in this semester include: problem solving, goal setting, interpersonal communication skills, and assertiveness skills.

Participation in leadership laboratories and participation in off-campus training sessions (field training exercise) is also required.

ML 1022. BASIC LEADERSHIP II.*Cat. I (1/9 unit after completion of 1021 and 1022)*

ML 1022 continues by providing cadets with interesting lessons yielding immediately useful skills. The course also gives accurate information about life in the Army, including the organization of the Army, employment benefits, and work experiences of junior officers.

ML 2011. INDIVIDUAL LEADERSHIP STUDIES I*Cat. I (1/12 unit)*

Introduces students to team building techniques. Students build upon the basic leader principals and leadership development methodologies to refine their understanding of leadership. How to build teams, how to influence, how to communicate, how and when to make decision, and creative problem-solving.

Participation in leadership laboratories and participation in off-campus training session (field training exercise) is also required

Recommended background: ML1022

ML 2012. INDIVIDUAL LEADERSHIP STUDIES II.*Cat. I (1/12 unit)*

The curriculum focuses on building character. Where years one, three and four focus on mastering definitions, concepts, ideas and principles, year two focuses on direct, physical experiences. Year two centers on giving cadets the opportunity to apply, practice and experience leadership principles. Cadets are asked to reflect upon their actions and those of others.

Participation in leadership laboratories and participation in off-campus training session (field training exercise) is also required.

Recommended background: ML 2011

ML 2021. LEADERSHIP AND TEAMWORK I.*Cat. I (1/12 unit)*

Students continue the study of leader principals and are introduced to formal policies such as equal opportunity, ethics, and values. Military communication skills are trained along with the principles of camouflage. Complex cases of risk management are studied. Students will submit a written information paper.

Participation in leadership laboratories and participation in off-campus training session (field training exercise) is also required.

Recommended background: ML2012

ML 2022. LEADERSHIP AND TEAMWORK II.*Cat. I (1/12 unit)*

This course covers small unit movement and military tactics. It combines previous study in weapons, movement and communications to teach the combination of firepower and maneuver to the student. This course also teaches the student

the elements of how the military trains its personnel. A written decision paper and practical exercise in conducting training is included in this course.

Participation in leadership laboratories and participation in off-campus training session (field training exercise) is also required.

Recommended background: ML 2021

ML 2091. LEADERSHIP TRAINING COURSE.

Cat. I (1/6 unit)

LTC puts each cadet through 24 days of pushing themselves to the mental and physical limits, while enhancing leadership, problem solving and teamwork skills. Cadets are put through extensive leadership training, which includes leadership reaction scenarios; Land Navigation exercises, first aid training. Cadets must pass the Army Fitness Test (APFT) in order to graduate.

ML 3011. LEADERSHIP AND PROBLEM SOLVING I.

Cat. I (1/6 unit)

This course focuses on development of individual leadership abilities. This course reviews leadership styles, management strategies and training techniques for leaders of small units. Promoting and developing communication skills and teamwork are addressed. Examines leadership of small units conducting conventional combat operations and tactical employment of weapon systems. Development of oral communication skills through military briefings and issuance of operations orders. Special attention is placed on evaluations through practical exercises

Participation in leadership labs and participation in an off-campus training session (field training exercise) is also required.

Recommended background: Students must have completed the basic course or ROTC Leadership Training course and have signed a personal contract with the US Army. Department Head approval is required.

ML 3012. LEADERSHIP AND PROBLEM SOLVING II.

Cat. I (1/6 unit)

Student learns how to conduct crisis planning and management. Discussion of roles and functions of combat arms, combat support, and combat service support branches. Case studies of small-unit operations are studied. Introduction to Army special operations, military operations other than war, and trends in the military. Students write self-evaluations throughout this course. Students are graded on their performance during leadership practical exercises.

Attendance at monthly labs and formal social functions is required. Students write self-evaluations through this course. Students are graded on their performance during leadership practical exercises.

Recommended background: ML 3011

ML 3021. LEADERSHIP AND ETHICS I.

Cat. I (1/6 unit)

ML 3021 is designed to continue the development as leaders by presenting instruction in the three foundational areas of leadership, interpersonal communication, and values and ethics. The leadership module contains an examination of Army leadership doctrine followed by expansion on key leadership concepts and provide feedback for cadet leadership self-development efforts.

ML 3022. LEADERSHIP AND ETHICS II.

Cat. I (1/6 unit)

The main thrust of the communication module is the opportunity for cadets to present an information briefing and receive feedback from both instructor and fellow students. The last module of the term contains lessons that focus on values, ethics, ethical decision-making, consideration of others, and spiritual needs.

Attendance at monthly labs, attendance at formal social functions and an off-campus weekend leadership exercise is required.

Recommended background: ML 3021

ML 3023. NATIONAL ADVANCED LEADERSHIP CAMP.

Cat. I (1/6 unit)

NALC puts each cadet through 32 days of intensive individual, squad and platoon-level training to assess his/her leadership potential. Each cadet is measured against 23 leadership dimensions in such subjects as physical stamina, technical competence, delegation, decisiveness, problem analysis and the several Army values, among others. Instruction and evaluation at NALC is progressive, building skills in individual subjects like the Army Physical Fitness Test, basic military skills and land navigation, followed by such skill-building exercises as Individual Tactical Training.

ML 4011. LEADERSHIP AND MANAGEMENT I.

Cat. I (1/6 unit)

ML 4011 begins with a series of lessons designed to enable the cadets to make informed career decisions as they prepare their accessions documents. Lessons concentrate on Army operations and training management, communications and leadership skills and support the beginning of the final transition from cadet to lieutenant. The course focuses cadets, early in the year, on attaining knowledge and proficiency in several critical areas they will need to operate effectively as Army officers. These areas include: the Army's training management system, coordinating activities with staffs, and counseling skills. While the proficiency attained in each of these areas will initially be at the apprentice level,

cadets will continue to sharpen these skills as they perform their roles as cadet officers in the ROTC battalion and as new lieutenants after commissioning. At the end of this semester cadets should possess the fundamental skills, attributes, and abilities to operate as competent leaders in the cadet battalion and confidently shoulder the responsibilities entrusted to them.

ML 4022. LEADERSHIP AND MANAGEMENT II.

Cat. I (1/6 unit)

This Course focuses on completing the transition from cadet to lieutenant. As an expansion of the Ethics instruction in ML 3021, the course starts with an examination of unit ethical climate and the commander's role as the moral anchor of the unit. This is followed by a module addressing military law and leadership. The next module reinforces previous instruction on the organization of the Army and introduces how the Army organizes for operations from the tactical to strategic level. This is followed by instruction on administrative and logistical management that focuses on the fundamentals of soldier and unit level support. Next is a short module that focuses on preparing cadets for their forthcoming commissioning and military service. At the core of this semester is the Advanced Course's Capstone Exercise. This twelve-lesson exercise directly reinforces all modules from this term, and also incorporates and reinforces many learning objectives from modules throughout the entire curriculum. The Capstone Exercise requires cadets, both individually and collectively, to apply their knowledge to solve problems and confront situations commonly faced by junior officers. Upon completion of this course the cadets will be prepared to shoulder the responsibility of being a commissioned officer in the United States Army.

Three lab exercises and participation in the military staff ride is required.

ML 4023. OFFICERSHIP.

Cat. I (1/6 unit)

This course is a continuation of ML 4022.

ML 4024. TRANSITION TO LIEUTENANT.

Cat. I (1/6 unit)

Cadets organize and lead all the junior cadets. This course covers the military legal system, personnel actions and personal finances. It certifies fundamental competencies in land navigation, tactics, counseling, and interpersonal communications.

This course requires three hours of class work and three hours of physical fitness per week. Three lab exercises and a formal military ball are required.

Recommended background: ML4023

PHYSICAL EDUCATION

PE 1001. INTRO TO GOLF & TENNIS.

Cat. I (1/12 unit)

Introduction to the sports through skill development and play.

PE 1002. INTRO TO VOLLEYBALL & SQUASH.

Cat. I (1/12 unit)

Introduction to the sports through skill development and play.

PE 1003. INTRO TO BOWLING & BADMINTON.

Cat. I (1/12 unit)

Introduction to the sports through skill development and play.

PE 1004. INTRO TO TABLE TENNIS, GOLF, & TENNIS.

Cat. I (1/12 unit)

Introduction to the sports through skill development and play.

PE 1005. INTRO TO RECREATIONAL SPORTS.

Cat. I (1/12 unit)

This summer course introduces students to various sports through skill development and play. Possible sports taught include badminton, bowling, golf, racquetball, squash, swimming, table tennis, tennis, and volleyball.

PE 1006. WELLNESS.

Cat. I (1/12 unit)

Introductory course designed to acquaint students with knowledge and skills necessary to make choices that foster health and well-being.

PE 1007. BASIC WATER SAFETY.

Cat. I (1/12 unit)

For the beginner and intermediate swimmer. Students will learn about water recreational activities and how to remain safe while participating in them. Opportunity to learn the necessary means for safety in/near water and basic rescue techniques. Fee required.

PE 1011. TOUCH FOOTBALL.

Cat. I (1/12 unit)

Introduction to basic rules and individual/team skill development with practical application through game competition.

PE 1012. BASKETBALL.*Cat. I (1/12 unit)*

Introduction to basic rules and individual/team skill development with practical application through game competition.

PE 1013. SOFTBALL.*Cat. I (1/12 unit)*

Introduction to basic rules and individual/team skill development with practical application through game competition.

PE 1014. BEGINNING TENNIS.*Cat. I (1/12 unit)*

Instruction will focus on basic strokes and techniques. Rules, strategy and play will be integrated as students' skills develop.

PE 1015. BADMINTON & TABLE TENNIS.*Cat. I (1/12 unit)*

Instruction will focus on basic strokes and techniques. Rules, strategy and play will be integrated as students' skills develop.

PE 1016. SQUASH & RACQUETBALL.*Cat. I (1/12 unit)*

Instruction will focus on basic strokes and techniques. Rules, strategy and play will be integrated as students' skills develop.

PE 1017. BEGINNING SWIMMING.*Cat. I (1/12 unit)*

For the non-swimmer to intermediate swimmer. Instruction in the basic stroke techniques to learn to swim, improve skills and develop survival skills.

PE 1018. CO-ED VOLLEYBALL.*Cat. I (1/12 unit)*

Introduction to basic rules and individual/team skill development with practical application through game competition.

PE 1021. BOWLING.*Cat. I (1/12 unit)*

Introductory course designed to acquaint students with the basic skills, knowledge and practical experience.

PE 1024. INTERMEDIATE TENNIS.*Cat. I (1/12 unit)*

Designed for the student with basic skills in tennis. In-depth instruction in skill development and strategy with game competition.

PE 1027. INTERMEDIATE SWIMMING.*Cat. I (1/12 unit)*

For the intermediate to advanced swimmer. Class will offer instruction geared toward creating efficient swimming. Swimming for Fitness will be introduced. Completion of Beginning Swimming (PE 1017) is recommended for this class; however students who pass a competency test administered by the instructor will be admitted.

PE 1055. PHYSICAL CONDITIONING.*Cat. I (1/2 unit)*

This course will teach basic strength training principles and techniques. Students will develop and implement an individualized conditioning program.

PE 1056. LIFEGUARDING I.*Cat. I (1/12 unit)*

PE 1057. LIFEGUARDING II.
Cat. I (1/12 unit)
This class is based on the Red Cross Manual for Lifeguarding. Red Cross fee and books are required. The Lifeguard I course is the first part of a two course requirement (Lifeguarding I and II) for a student to be certified in CPR for the Professional Rescuer, First Aid, AED, Oxygen Administration and Lifeguarding.
Recommended background: PE 1007

PE 1059. WEIGHT TRAINING PROGRAM FOR WOMEN.*Cat. I (1/2 unit)*

This introductory course is designed to acquaint women with circuit training and free weight programs.

PE 1070. LEISURE EDUCATION: REDEFINING SOCIAL NORMS.*Cat. I (1/12 unit)*

Introductory course designed to explore various leisure education alternatives.

PE 1077. SWIMMING FOR FITNESS.*Cat. I (1/12 unit)*

For the intermediate to advanced swimmer. This class is geared toward swimming for fitness purposes. Workouts will be administered each class period with students developing the knowledge to create workouts for themselves.

PE 1100. PHYSICAL EDUCATION EQUIVALENCY.*Cat. I (1/12 unit)*

Credit by equivalent activity in one of five categories: 1) WPI athletic team participation, 2) club sports, 3) approved courses not offered at WPI, 4) individualized program at WPI, 5) Proficiency testing. Advanced approval by the Physical Education Department Head is necessary.

PHYSICS

The second digit in physics course numbers is coded as follows.

- 1 — General physics
- 2 — Theoretical mechanics, statistical physics, kinetic theory, etc.
- 3 — Electricity and magnetism, electromagnetic theory
- 4 — Quantum mechanics
- 5 — Particular topics
- 6 — Laboratory

INTRODUCTORY PHYSICS SEQUENCE

There are four course topics in the introductory physics sequence. The four topics are Classical Mechanics (PH 1110/PH 1111), Electricity and Magnetism (PH 1120/PH 1121), 20th Century Physics (PH 1130), and Oscillations and Waves (PH 1140). Each course includes a laboratory component.

Students should take either PH 1110 or PH 1111, but not both; similarly, either PH 1120 or PH 1121, but not both. The primary difference between the PH 1110-PH 1120 option and PH 1111-PH 1121 is that the material in PH 1111-PH 1121 is treated somewhat more formally and rigorously than in PH 1110-PH 1120, thus presuming a better-than-average mathematics background. The recommended mathematics background for each course is indicated in the respective course description and should be considered carefully in each case.

Because the topics covered in the two mechanics and in the two electricity and magnetism courses are the same, it is possible to cross over from one sequence to the other. For example, PH 1120 could be taken after PH 1111, or, upon consulting with the course instructor, PH 1121 could be taken after successful completion of PH 1110. Finally, it should be noted that any combination of the first two introductory courses provides adequate preparation for both of the remaining courses in 20th Century Physics (PH 1130), and Oscillations and Waves (PH 1140).

The courses in classical mechanics and electricity and magnetism are regarded as essential preparation for many fundamental engineering courses as well as for further work in physics. PH 1130 gives a first introduction to 20th century physics and is designed to provide a context for the appreciation of present-day advances in physics and high-technology applications. PH 1140 deals in depth with oscillating systems, a topic area of fundamental importance in physics, and whose engineering applications span the range from electromagnetic oscillations to the mechanical vibrations of machinery and structures.

PH 1110. GENERAL PHYSICS—MECHANICS.*Cat. I*

Introductory course in Newtonian mechanics.

Topics include: kinematics of motion, vectors, Newton's laws, friction, work-energy, impulse-momentum, for both translational and rotational motion.

Recommended background: concurrent study of MA 1021.

PH 1111. PRINCIPLES OF PHYSICS—MECHANICS.*Cat. I*

An introductory course in Newtonian mechanics that stresses invariance principles and the associated conservation laws.

Topics include: kinematics of motion, vectors and their application to physical problems, dynamics of particles and rigid bodies, energy and momentum conservation, rotational motion.

Recommended background: concurrent study of MA 1023 (or higher).

Students with limited prior college-level calculus preparation are advised to take PH 1110.

PH 1120. GENERAL PHYSICS—ELECTRICITY AND MAGNETISM.*Cat. I*

An introduction to the theory of electricity and magnetism.

Topics include: Coulomb's law, electric and magnetic fields, capacitance, electrical current and resistance, and electromagnetic induction.

Recommended background: working knowledge of the material presented in PH 1110 or PH 1111 and concurrent study of MA 1022.

PH 1121. PRINCIPLES OF PHYSICS—ELECTRICITY AND MAGNETISM.*Cat. I*

An introduction to electricity and magnetism, at a somewhat higher mathematical level than PH 1120.

Topics include: Coulomb's Law, electric fields and potentials, capacitance, electric current and resistance, magnetism, and electromagnetic induction.

Recommended background: working knowledge of material covered in PH 1111 and concurrent study of MA 1024 (or higher). Students concurrently taking MA 1022 or MA 1023 are advised to take PH 1120.

PH 1130. INTRODUCTION TO 20TH CENTURY PHYSICS.*Cat. I*

An introduction to the pivotal ideas and developments of twentieth-century physics.

Topics include: special relativity, photoelectric effect, X-rays, Compton scattering, blackbody radiation, DeBroglie waves, uncertainty principle, Bohr theory of the atom, atomic nuclei, radioactivity, and elementary particles.

Recommended background: familiarity with material covered in PH 1110 and PH 1120 (or PH 1111 and PH 1121) and completion of MA 1021 and MA 1022.

PH 1140. OSCILLATIONS, AND WAVES.*Cat. I*

An introduction to oscillating systems and waves.

Topics include: free, clamped forced, and coupled oscillations of physical systems, traveling waves and wave packets, reflection, and interference phenomena.

Recommended background: working knowledge of the material covered in PH 1110 and PH 1120 (or PH 1111 and PH 1121) and completion of MA 1021, MA 1022 and MA 1023.

PH 2201. INTERMEDIATE MECHANICS I.*Cat. I*

This course emphasizes a systematic approach to the mathematical formulation of mechanics problems and to the physical interpretation of the mathematical solutions.

Topics covered include: Newton's laws of motion, kinematics and dynamics of a single particle, vector analysis, motion of particles, rigid body rotation about an axis.

Recommended background: PH 1110, PH 1120, PH 1130, PH 1140, MA 1021, MA 1022, MA 1023, MA 1024 and concurrent registration in or completion of MA 2051.

PH 2202. INTERMEDIATE MECHANICS II.*Cat. I*

This course is a continuation of the treatment of mechanics started in PH 2201.

Topics covered include: rigid-body dynamics, rotating coordinate systems, Newton's law of gravitation, central-force problem, driven harmonic oscillator, an introduction to generalized coordinates, and the Lagrangian and Hamiltonian formulation of mechanics.

PH 2301. ELECTROMAGNETIC FIELDS.*Cat. I*

Introduction to the theory and application of electromagnetic fields, appropriate as a basis for further study in electromagnetism, optics, and solid-state physics.

Topics: electric field produced by charge distributions, electrostatic potential, electrostatic energy, magnetic force and field produced by currents and by magnetic dipoles, introduction to Maxwell's equations and electromagnetic waves.

Recommended background: introductory electricity and magnetism, vector algebra, integral theorems of vector calculus as covered in MA 2251.

PH 2501. PHOTONICS.*Cat. II*

An introduction to the use of optics for transmission and processing of information. The emphasis is on understanding principles underlying practical photonic devices. Topics include lasers, light emitting diodes, optical fiber communications, fiber lasers and fiber amplifiers, planar optical waveguides, light modulators and photodetectors. Recommended background is PH 1110, PH 1120, PH 1130 and PH 1140 (or their equivalents).

This course will be offered in 2004-05 and in alternating years thereafter.

PH 2502. LASERS.*Cat. II*

An introduction to the physical principles underlying lasers and their applications. Topics will include the coherent nature of laser light, optical cavities, beam optics, atomic radiation, conditions for laser oscillation, optical amplifiers (including fiber amplifiers), pulsed lasers (Q switching and mode locking), laser excitation (optical and electrical), and selected laser applications. Recommended background is PH 1110, PH 1120, PH 1130 and PH 1140 (or their equivalents).

This course will be offered in 2003-04 and in alternating years thereafter.

PH 2601. PHOTONICS LABORATORY.*Cat. II*

This course provides an experimental approach to concepts covered in Photonics (PH 2501), Lasers (PH 2502), and Optics (PH 3504). Through a series of individually tailored experiments, students will reinforce their knowledge in one or more of these areas, while at the same time gaining exposure to modern photonics laboratory equipment. Experiments available include properties of optical fibers, optical fiber diagnostics, optical communications systems, properties of photodetectors, mode structure and threshold behavior of lasers, coherence properties of laser light, characterization of fiber amplifiers, diffraction of light, polarization of light, interferometry.

Recommended background: PH 1110/1111, PH 1120/1121, PH 1130, PH 1140, and one or more of the courses PH 2501, PH 2502, or PH 3504. No prior laboratory background is expected.

This course will be offered in 2004-05 and in alternating years thereafter.

PH 2651. INTERMEDIATE PHYSICS LABORATORY.*Cat. I*

This course offers experience in experimentation and observation for students of the sciences and others. In a series of subject units, students learn or review the physical principles underlying the phenomena to be observed and the basis for the measurement techniques employed. Principles and uses of laboratory

instruments including the cathode-ray oscilloscope, meters for frequency, time, electrical and other quantities are stressed. In addition to systematic measurement procedures and data recording, strong emphasis is placed on processing of the data, preparation and interpretation of graphical presentations, and analysis of precision and accuracy, including determination and interpretation of best value, measures of error and uncertainty, linear best fit to data, and identification of systematic and random errors. Preparation of high-quality experiment reports is also emphasized. Representative experiment subjects are: mechanical motions and vibrations; free and driven electrical oscillations; electric fields and potential; magnetic materials and fields; electron beam dynamics; optics; diffraction-grating spectroscopy; radioactive decay and nuclear energy measurements.

Recommended background: the Introductory Physics course sequence or equivalent. No prior laboratory background beyond that experience is required.

Students who have received credit for PH 2600 or PH 3600 may not receive credit for PH 2651.

PH 3117. PROBLEM SOLVING SEMINAR.*Cat. I*

This course is intended to give students some experience in solving the kinds of problems that form the daily diet of a working physicist. Small groups of students will be presented with a series of problems, which they will solve under the guidance of one or more faculty members.

Topics will be selected from a wide variety of physical disciplines.

This course is intended for third- and fourth-year physics majors, after completion of intermediate-level classical mechanics, electromagnetism, and quantum mechanics.

PH 3301. ELECTROMAGNETIC THEORY.*Cat. I*

A continuation of PH 2301, this course deals with more advanced subjects in electromagnetism, as well as study of basic subjects with a more advanced level of mathematical analysis. Fundamentals of electric and magnetic fields, dielectric and magnetic properties of matter, quasi-static time-dependent phenomena, and generation and propagation of electromagnetic waves are investigated from the point of view of the classical Maxwell's equations.

PH 3401. QUANTUM MECHANICS I.*Cat. I*

This course includes a study of the basic postulates of quantum mechanics, its mathematical language and applications to one-dimensional problems. The course is recommended for physics majors and other students whose future work will involve the application of quantum mechanics.

Topics include wave packets, the uncertainty principle, introduction to operator algebra, application of the Schrodinger equation to the simple harmonic oscillator, barrier penetration and potential wells.

Recommended background: Junior standing, MA 4451, and completion of the introductory physics sequence, including the introduction to the 20th century physics.

Suggested background: knowledge (or concurrent study) of linear algebra, Fourier series, and Fourier transformers.

PH 3402. QUANTUM MECHANICS II.*Cat. I*

This course represents a continuation of PH 3401 and includes a study of three-dimensional systems and the application of quantum mechanics in selected fields.

Topics include: the hydrogen atom, angular momentum, spin, perturbation theory and examples of the application of quantum mechanics in fields such as atomic and molecular physics, solid state physics, optics, and nuclear physics.

Recommended background: PH 3401.

PH 3501. RELATIVITY.*Cat. II*

This course is designed to help the student acquire an understanding of the formalism and concepts of relativity as well as its application to physical problems.

Topics include the Lorentz transformation, 4-vectors and tensors, covariance of the equations of physics, transformation of electromagnetic fields, particle kinematics and dynamics.

Recommended background: knowledge of mechanics and electrodynamics at the intermediate level.

This course will be offered in 2004-05 and in alternating years thereafter.

PH 3502. SOLID STATE PHYSICS.*Cat. II*

An introduction to solid state physics.

Topics include: crystallography, lattice vibrations, electron band structure, metals, semiconductors, dielectric and magnetic properties.

Recommended background: prior knowledge of quantum mechanics at an intermediate level.

Suggested background: knowledge of statistical physics is helpful.

This course will be offered in 2004-05 and in alternating years thereafter.

PH 3503. NUCLEAR PHYSICS.*Cat. II*

This course is intended to acquaint the student with the measurable properties of nuclei and the principles necessary to perform these measurements. The major part of the course will be an introduction to the theory of nuclei.

The principal topics will include binding energy, nuclear models and nuclear reactions. The deuteron will be discussed in detail and the nuclear shell model will be treated as well as the nuclear optical model.

Recommended background: some knowledge of the phenomena of modern physics at the level of an introductory physics course and knowledge of intermediate level quantum mechanics.

This course will be offered in 2003-04 and in alternating years thereafter.

PH 3504. OPTICS.*Cat. II*

This course provides an introduction to classical physical optics, in particular interference, diffraction and polarization, and to the elementary theory of lenses. The theory covered will be applied in the analysis of one or more modern optical instruments.

Recommended background: knowledge of introductory electricity and magnetism and of differential equations.

Suggested background: PH 2301.

This course will be offered in 2003-04 and in alternating years thereafter.

PH 4201. ADVANCED CLASSICAL MECHANICS.*Cat. I*

A review of the basic principles and introduction to advanced methods of mechanics, emphasizing the relationship between dynamical symmetries and conserved quantities, as well as classical mechanics as a background to quantum mechanics.

Topics include: Lagrangian mechanics and the variational principle, central force motion, theory of small oscillations, Hamiltonian mechanics, canonical transformations, Hamilton-Jacobi Theory, rigid body motion, and continuous systems.

Recommended background: PH 2201 and PH 2202.

This is a 14-week course.

PH 4206. STATISTICAL PHYSICS.*Cat. I*

An introduction to the basic principles of thermodynamics and statistical physics.

Topics covered include: basic ideas of probability theory, statistical description of systems of particles, thermodynamic laws, entropy, microcanonical and canonical ensembles, ideal and real gases, ensembles of weakly interacting spin 1/2 systems.

Recommended background: knowledge of quantum mechanics at the level of PH 3401-3402 and of thermodynamics at the level of ES 3001.

Graduate Physics Courses of Interest to Undergraduates

PH 511/PH 4201. CLASSICAL MECHANICS.

Lagrangian and Hamiltonian formulations. Central force motion. Rigid body dynamics. Theory of small oscillations. Poisson brackets, Hamilton-Jacobi theory. Continuous systems.

PH 514. QUANTUM MECHANICS I.

Schrodinger wave equation. Harmonic oscillator, hydrogen atom, potential wells, approximation methods.

PH 515. QUANTUM MECHANICS II.

Perturbation theory. Angular momentum. Spin. Scattering theory. Dirac equation.

PH 522. THERMODYNAMICS AND STATISTICAL MECHANICS.

Quantum concepts applied to thermodynamics. Bose-Einstein and Fermi-Dirac statistics.

PH 533. ADVANCED ELECTROMAGNETIC THEORY.

Classical electrodynamics and radiation theory.

SOCIAL SCIENCE AND POLICY STUDIES

The second digit for courses in this department has the following meaning:

- 1 — Economics
- 2 — Sociology
- 3 — Political Science and Law
- 4 — Psychology
- 5 — System Dynamic

SS 1110. INTRODUCTORY MICROECONOMICS.*Cat. I*

The course focuses upon the implications of reliance upon markets for the allocation of resources in a society, at the household, firm, and community level. Outcomes of current market systems are examined in terms of the efficient use of natural and other economic resources, as well as their impact upon the environment, fairness, and social welfare. Of special interest in these analyses is the role of prices in the determination of what commodities are produced, their means of production, and distribution among households. In cases where current market outcomes have features subject to widespread criticism, such as the presence of excessive pollution, risk, discrimination, and poverty, the analysis is extended to suggest economic solutions. There are no prerequisites for the course.

SS 1120. INTRODUCTORY MACROECONOMICS.*Cat. I*

This course is designed to acquaint students with the ways in which macroeconomic variables such as national income, employment and the general level of prices are determined in an economic system. It also includes a study of how the techniques of monetary policy and fiscal policy attempt to achieve stability in the general price level and growth in national income and employment. The problems of achieving these national goals (simultaneously) are also analyzed. The latter half of the course stresses economic issues in public policy and international trade.

SS 1202. SOCIOLOGICAL CONCEPTS AND COMPARATIVE ANALYSIS.*Cat. I*

The aim of this course is to give students a general idea of the nature of sociology while illustrating concepts using examples from a variety of societies to enhance one's comparative perspective. The secondary theme of the course is to focus on what the field of sociology can offer those interested in the social implications of technological change and the social processes that shape science and technology. The course begins with a review of the debate over the nature of technology, whether it is more properly viewed as an aspect of social structure or culture, an integral part of society or a force external to it. Cases drawn from around the world and different technical fields are then developed both to address these questions and to illustrate various ways in which one might go about studying society-technology interaction effects. Classic sociological issues such as the distribution of wealth and power, intergroup relations, family structures and the nature of community are all covered as the cases unfold. The cases covered range from the impact of disasters on different kinds of communities to a comparative analysis of the space agencies of Europe, the U.S. and Japan, and the different kinds of technology they tend to produce. Such observations are placed in the context of their differing processes of modernization and international positions. This course is appropriate preparation for many types of IQP's.

SS 1203. SOCIAL PROBLEMS AND POLICY ISSUES.*Cat. II*

The goal of this course is to examine various problematic features of the emerging post-modern social organization and contemporary social issues. The course involves an examination of both the process whereby public consensus is shaped and of the "life cycle" of a social problem. Social movements, cultural values, institutional structures, media interpretation and political authorities all get attention in the study of this process whereby some objective conditions come to be considered social problems requiring public action and others do not. Attention is also given to the warring conservative, liberal and radical perspectives on the nature of each social problem, their relative importance and what a proper response to them would be.

Several specific problem areas are addressed in detail as illustrations. These may include subsets of energy, welfare, environmental racism, homelessness, the crisis in education, environmental problems, international conflict, the end of work debate, changes in unionism and advanced capitalism, the role and limitations of national government, global environmental issues, the challenges facing the American family and the relationship between drugs and crime. These issues have all been featured in one or more offering of the course in recent years. The students in each class will be given some choice as to which topics are covered as illustrations so long as they are in text.

The course requirements generally include an individual or group (your choice) project and an oral presentation. The topics are selected by the student with the approval of the instructor. This course will be offered in 2003-04 and in alternating years thereafter.

SS 1301. U.S. GOVERNMENT.*Cat. I*

This course is an introduction to the fundamental principles, institutions, and processes of the constitutional democracy of the United States. It examines the formal structure of the Federal system of government, including Congress, the presidency, the judiciary, and the various departments, agencies, and commissions which comprise the executive branch. Emphasis is placed on the relationships among Federal, state and local governments in the formulation and administration of domestic policies, and on the interactions among interest groups, elected officials and the public at large with administrators in the policy process. The various topics covered in the survey are linked by consideration of fiscal and budgetary issues, executive management, legislative oversight, administrative discretion, policy analysis and evaluation and democratic accountability.

May be included in certain Humanities and Arts Sufficiency programs. See page 54.

SS 1303. AMERICAN PUBLIC POLICY.*Cat. I*

American Public Policy focuses on the outcomes or products of political institutions and political controversy. The course first addresses the dynamics of policy formations and stalemate, the identification of policy goals, success and failure in implementation, and techniques of policy analysis. Students are then encouraged to apply these concepts in the study of a specific policy area of their choosing, such as foreign, social, urban, energy or environmental policy. This course is an important first step for students wishing to complete IQPs in public policy research. Students are encouraged to complete SS 1303 prior to enrolling in upper level policy courses such as SS 2303, SS 2304 or SS 2311. There is no specific preparation for this course, but a basic understanding of American political institutions is assumed.

SS 1310. LAW, COURTS, AND POLITICS.*Cat. II*

This course is an introduction to law and the role courts play in society. The course examines the structure of judicial systems, the nature of civil and criminal law, police practice in the enforcement of criminal law, and the responsibilities of judges, attorneys and prosecutors. Additional topics for discussion include the interpretation of precedent and statute in a common law system and how judicial discretion enables interest groups to use courts for social change. The student is expected to complete the course with an understanding of how courts exercise and thereby control the power of the state. As such, courts function as political actors in a complex system of governance. It is recommended that students complete this course before enrolling in SS 2310, Constitutional Law.

This course will be offered in 2003-04 and in alternating years thereafter.

SS 1320. TOPICS IN INTERNATIONAL POLITICS.*Cat. II*

SS 1320 is a survey course designed to introduce students to the basic concepts of international relations: power and influence, nations and states, sovereignty and law. These concepts will be explored through the study of issues such as diplomacy and its uses, theories of collective security and conflict, and international order and development. The study of international organizations such as the UN, the European Union or the Organization of American States will also supplement the students' understanding of the basic concepts. The course may also include comparative political analysis of states or regions. It is designed to provide the basic background materials for students who wish to complete IQPs on topics that involve international relations or comparative political systems.

This course will be offered in 2004-05, and in alternating years thereafter.

SS 1401. INTRODUCTION TO COGNITIVE PSYCHOLOGY.*Cat. I*

This course is concerned with understanding and explaining the mental processes and strategies underlying human behavior. The ways in which sensory input is transformed, reduced, elaborated, stored, and recovered will be examined in order to develop a picture of the human mind as an active processor of information. Topics will include perception, memory, problem-solving, judgment and decision making, human-computer interaction, and artificial intelligence. Special attention will be paid to defining the limitations of the human cognitive system. Students will undertake a project which employs one of the experimental techniques of cognitive psychology to collect and analyze data on a topic of their own choosing.

SS 1402. INTRODUCTION TO SOCIAL PSYCHOLOGY.*Cat. I*

Social psychology is concerned with how people think about, feel for, and act toward other people. Social psychologists study how people interact by focusing on the individual (not society as a whole) as the unit of analysis, by emphasizing the effect on the individual of the situation or circumstances in which behavior occurs, and by acquiring knowledge through empirical scientific investigation. This course will examine the cause of human behavior in a variety of domains of social life. Topics will include, but not be limited to, person perception, attitude formation and change, interpersonal attraction, stereotyping and prejudice, and small group behavior. Special attention will be given to applied topics: How can

the research methods of social psychology be used to help solve social problems? Students will work together in small groups to explore in depth topics in social psychology of their own choosing.

May be included in certain Humanities and Arts Sufficiency programs. See page 54.

SS 1503. THE PSYCHOLOGY OF DECISION MAKING AND PROBLEM SOLVING.*Cat. II*

This course provides the psychological background and practical skills needed to improve both professional and personal decision making and problem solving. Topics will include memory improvement, creativity, methods of problem solving, group problem solving and decision making, multiattribute utility models, social judgment theory, expert-novice differences, risky decision making, dynamic decision making, and human ability to manage complex systems. Special attention will be paid to the rationale for and appropriate use of decision support tools, including system dynamics software.

This course will be offered in 2003-04 and in alternating years thereafter.

SS 1510. INTRODUCTION TO SYSTEM DYNAMICS MODELING.*Cat. I*

The goal of this course is to provide students with an introduction to the field of system dynamics computer simulation modeling.

The course begins with the history of system dynamics and the study of why policy makers can benefit from its use. Next, students systematically examine the various types of dynamic behavior that socioeconomic systems exhibit and learn to identify and model the underlying nonlinear stock-flow-feedback loop structures that cause them. The course concludes with an examination of a set of well-known system dynamics models that have been created to address a variety of socioeconomic problems. Emphasis is placed on how the system dynamics modeling process is used to test proposed policy changes and how the implementation of model-based results can improve the behavior of socioeconomic systems.

SS 1520. SYSTEM DYNAMICS MODELING.*Cat. I*

The purpose of this course is to prepare students to produce original system dynamics computer simulation models of economic and social systems. Models of this type can be used to examine the possible impacts of policy changes and technological innovations on socioeconomic systems.

The curriculum in this course is divided into three distinct parts. First, a detailed examination of the steps of the system dynamics modeling process: problem identification (including data collection), feedback structure conceptualization, model formulation, model testing and analysis, model documentation and presentation, and policy implementation. Second, a survey of the "nuts and bolts" of continuous simulation modeling: information and material delays, time constants, the use of noise and numerical integration techniques, control theory heuristics, and software details (both simulation and model presentation and documentation software). Third, a step-by-step, in-class production of a model, involving the construction, testing, and assembly of sub-sections. Students will be required to complete modeling assignments working in groups and take in-class quizzes on modeling issues.

Recommended background: SS1510, or permission of instructor.

SS/ID 2050. SOCIAL SCIENCE RESEARCH FOR THE IQP.*Cat. I*

This course is open to students accepted to off-campus IQP centers and programs. The course introduces students to research design, methods for social science research, and analysis. It also provides practice in specific research and field skills using the project topics students have selected in conjunction with sponsoring agencies. Students learn to develop social science hypotheses based upon literature reviews in their topic areas and apply concepts drawn from social psychology, anthropology, sociology, economics and other areas as appropriate. Students make presentations, write an organized project proposal, and develop a communication model for reporting their project findings.

SS 2110. INTERMEDIATE MICROECONOMICS.*Cat. II*

The topics addressed in this course are similar to those covered in SS 1110 (Introductory Microeconomics) but the treatment proceeds in a more rigorous and theoretical fashion to provide a firm platform for students majoring in Economics or Management, or those having a strong interest in economics. Mathematics at a level comparable to that taught in MA 1021-MA 1024 is frequently applied to lend precision to the analysis. The course rigorously develops the microeconomic foundations of the theory of the firm, the theory of the consumer, the theory of markets, and the conditions required for efficiency in economic systems.

Recommended background: SS 1110.

This course will be offered in 2003-04 and in alternating years thereafter.

SS 2117. ENVIRONMENTAL ECONOMICS.*Cat. II*

This course investigates the effect of human activity upon the environment as well as the effect of the environment on human well-being. It pays special attention to the impact of production and consumption of material goods upon the quantity and quality of environmental goods. The analysis focuses on

the challenges presented in mixed economics where markets are combined with government intervention to manage pollution and scarcity. The course reviews efforts to measure the costs and benefits of improving environmental conditions and evaluates current and potential policies in terms of the costs of the environmental improvements they may yield. Attention is also paid to the special difficulties which arise when the impacts of pollution spill across traditional political boundaries.

Recommended background: SS 1110.

This course will be offered in 2004-05 and in alternating years thereafter.

SS 2120. INTERMEDIATE MACROECONOMICS.

Cat. II

This course is an advanced treatment of macroeconomic theory well suited for students majoring in Economics or Management, or others with a strong interest in economics. The topics addressed in SS 2120 are similar to those covered in SS 1120, however the presentation of the material will proceed in a more rigorous and theoretical fashion.

Recommended background: SS 1110.

This course will be offered in 2004-05 and in alternating years thereafter.

SS 2121. GOVERNMENT BUDGETS AND FISCAL POLICY.

IS/P only

A study of the functions and impact of government expenditures and revenues on the economic system. An analysis of the rationale of governmental budgets in allocating scarce resources between private and public goods and services using cost-benefit techniques. More specifically, the effect of various types of government spending, taxation, and user charges on factor supplies and distribution of national income. An analysis of intergovernmental fiscal relations, and the relationship between fiscal and monetary policies to achieve full employment, reasonable price stability and economic growth. This course is designed for the economics major who has opted for the specialty area of economic growth and stability and for students interested in understanding the role of government spending and taxation in the economy.

Recommended background: SS 1120 and SS 1301.

SS 2125. DEVELOPMENT ECONOMICS.

Cat. II

This course is a general introduction to the field of development economics. The focus is on ways in which a developing country can increase its productive capacity, both agricultural and industrial, in order to achieve sustained economic growth. The course proceeds by first examining how economic growth and economic development are measured and how the various nations of the world compare according to well-known social and economic indicators. Theories of economic growth and theories of economic development are then examined, as are the various social and cultural structures that are thought to influence economic progress. The inputs to economic growth and development (land, labor, capital, entrepreneurial ability, education, technical change), and the possible distributions of income and levels of employment that result from their use, is considered next. Domestic economic problems and policies such as development planning, the choice of sectorial policies, the choice of monetary and fiscal policies, rapid population growth, and urbanization and urban economic development are then examined. The course concludes with a consideration of international problems and policies such as import substitution and export promotion, foreign debt, foreign investment, and the role of international firms. In conjunction with a traditional presentation of the above topics, the course curriculum will include the use of computer simulation models and games. These materials have been formulated with a simulation technique, system dynamics, that has its origins in control engineering and the theory of servomechanisms. As a result, students will find them complementary to their work in engineering and science. In addition, the various development theories and simulation and gaming results will be related, where possible, to specific developing nations where WPI has on-going project activities (e.g., Costa Rica and Thailand). This course is recommended for those students wishing to do an IQP or MQP in a developing nation.

Recommended background: SS 1120.

This course will be offered in 2003-04 and in alternating years thereafter.

SS 2207. CREATIVITY AND THE SCIENTIFIC COMMUNITY.

Cat. II

An interdisciplinary course that examines the continuing tension between individual originality and the research community. It provides an introduction to some interesting strands in the psychological literature on creativity and materials from the sociology and philosophy of science focusing on the process of discovery and its relationship to scientific advance. Research findings on innovation and the nature of science are introduced. Examples are taken from studies of industrial research and development, academic science, the history of technology and history of science. A focal concern is to explore the effect that the growing interdependence of science with political and economic systems has had on the fragile balance between the individual researcher and the scientific community.

Recommended background: SS 1402 or permission of the instructor.

This course will be offered in 2004-05 and in alternating years thereafter.

May be included in certain Humanities and Arts Sufficiency programs. See page 54.

SS 2208. THE SOCIETY - TECHNOLOGY DEBATE.

Cat. II

A course which considers what one means when they say that we live in a technological society, focusing on the characteristics of technology that humanistic critics find problematic or objectionable. In the course of the analysis, the nature of technology, its connection to scientific advance, as well as its relationship to the state, and the social role of scientists and technologists will be considered. Special attention is given to the behavior of experts in scientific and technological controversies, and to the debate about the "technological mentality" said to pervade western societies. Utopian, Dystopian and Marxist interpretations of where technological development is taking us will be examined in an effort to understand the major themes in the larger debate about the social impact of technology.

Computer science majors can take this course in place of CS 3043 if they write a term paper on a computer-related topic.

Recommended background: SS 1202.

This course will be offered in 2003-04 and in alternating years thereafter.

May be included in certain Humanities and Arts Sufficiency programs. See page 54.

SS 2302. SCIENCE-TECHNOLOGY POLICY.

Cat. II

This course is an examination of the relationship between science-technology and government. It reviews the history of public policy for science and technology, theories and opinions about the proper role of government and several current issues on the national political agenda. Examples of these issues include genetic engineering, the environment and engineering education. It also examines the formation of science policy, the politics of science and technology, the science bureaucracy, enduring controversies such as public participation in scientific debates, the most effective means for supporting research, and the regulation of technology. Throughout the course we will pay particular attention to the fundamental theme: the tension between government demands for accountability and the scientific community's commitment to autonomy and self-regulation.

Recommended background: SS 1301 or SS 1303.

This course will be offered in 2004-05 and in alternating years thereafter.

SS 2304. GOVERNMENTAL DECISION MAKING AND ADMINISTRATIVE LAW.

Cat. II

The course addresses the role of technical expertise in political decision making. Politicians and public administrators rely on the expert knowledge of scientists and engineers to "bring reason" to otherwise political decisions. The course specifically addresses decision making in the administrative context including the value of expert knowledge, circumstances of inadequate information and the need to accommodate the political agenda. The context for the discussion will be the problems of regulated industries (for example, energy or those industries subject to environmental regulation). Legal review of administrative decision making will also be addressed.

Recommended background: SS 1301 or SS 1303 or SS 2310.

This course will be offered in 2003-04 and in alternating years thereafter.

SS 2310. CONSTITUTIONAL LAW.

Cat. II

Constitutional Law is a study of those Supreme Court decisions which interpret the foundation of American governance, the U.S. Constitution. These decisions address a wide variety of questions of historic and contemporary significance. For example: What are the limits on the powers of the President? How are the powers of the Congress restricted? How are legislative powers to be shared with the state and local governments? Other questions focus on the rights of individuals. What is the right to privacy and where is it found in law? Does the Constitution protect women who desire abortions, prevent discrimination against homosexuals, provide support for affirmative action programs? These and many other questions of great social and political importance are answered by the Supreme Court as it interprets the words of the founders. It is only through the decisions of the Court that we can come to have a complete understanding of the "living Constitution."

Recommended background: SS 1310. (Formerly Dynamics and Limits of Law.)

This course will be offered in 2004-05 and in alternating years thereafter.

SS 2311. LEGAL REGULATION OF THE ENVIRONMENT.

Cat. I

This course deals with environmental law as it relates to people, pollution and land use in our society. A case method approach will be used to illustrate how the courts and legislators have dealt with these social-legal problems. The course is designed to have the student consider: 1) the legal framework within which environmental law operates; 2) the governmental institutions involved in the formulation, interpretation and application of environmental law; 3) the nature of the legal procedures and substantive principles currently being invoked to resolve environmental problems; 4) the types of hazards to the environment presently subject to legal constraints; 5) the impact that the mandates of environmental law have had, and will have, on personal liberties and property rights; 6) the role individuals and groups can play within the context of our legal system to protect and improve man's terrestrial habitat and the earth's atmosphere; and 7) some methods and sources for legal research that they may use on their own.

Recommended background: SS 1303 or SS 1310.

SS 2312. INTERNATIONAL ENVIRONMENTAL POLICY.*Cat. II*

Environmental issues present some of the major international problems and opportunities facing the world today. Worst-case scenarios envision irrevocable degradation of the earth's natural systems, but virtually every analysis sees the need for major change worldwide to cope with problems such as global warming, deforestation, ozone layer depletion, loss of biodiversity, and population growth, not to mention exponential increases in "conventional" pollutants in newly industrialized countries. The global environment issues represent a "second-generation" of environmental policy in which the focus of concern has moved from national regulations to international law and institutions. In addition, the environment has emerged as a major aspect of international trade, conditioning corporate investment and accounting for some \$200 billion in sales of pollution control equipment in 1991. Exploration of the genesis and implications of these phenomena is the essence of the course. Topically, the material begins with the nature of global environmental problems, drawing on literature from large-scale global modeling as well as particular analyses of the problems mentioned above. Approximately half the course focuses on international laws and institutions, including multilateral treaties (e.g., the Montreal Protocol limiting CFC use, ocean dumping, biodiversity), international institutions (UNEP, the Rio Convention, the OECD) and private initiatives (international standards organizations, ICOLP (Industry Committee for Ozone Layer Protection), etc.) In addition, US policy toward global environmental issues will be compared with that in Japan, Europe and developing countries, from which it differs significantly. Students will design and undertake term projects that address particular issues in detail in an interdisciplinary manner.

Recommended background: SS 1303.

This course will be offered in 2003-04 and in alternating years thereafter.

SS 2313. INTELLECTUAL PROPERTY LAW.*Cat. II*

Intellectual property includes ideas, and the works of inventors, authors, composers and other creative people. Patents, copyrights and trademarks establish legal rights in intellectual property. Alternatively, control over the use of an idea might be maintained by treating it as a trade secret. In these ways, the ideas of inventors and creators are protected and others are prohibited from appropriating the ideas and creative works of others. This course addresses the concept of intellectual property and the public policies that support the law of patent, copyright and trademark. Subjects include the process of obtaining patents, trademarks and copyrights; requirements of originality and, for patents, utility; infringement issues; and the problems posed by international trade and efforts to address them through the World Intellectual Property Organization.

Recommended background: SS 1310 or SS 2310.

This course will be offered in 2003-04 and in alternating years thereafter.

SS 2401. THE PSYCHOLOGY OF EDUCATION.*Cat. II*

This course is concerned with the learning of persons in educational settings from pre-school through college. Material in the course will be organized into five units covering a wide range of topics: Unit 1: Understanding Student Characteristics — Cognitive, Personality, Social, and Moral Development; Unit 2: Understanding the Learning Process — Behavioral, Humanistic, and Cognitive Theories of Learning; Unit 3: Understanding Motivation to Learn; Unit 4: Understanding Student Diversity — Cultural, Economic, and Gender Effects upon Learning; Unit 5: Evaluating Student Learning — Standardized Tests, Intelligence, Grades, and other Assessment Issues. Students planning IQPs in educational settings will find this course particularly useful. Instructional methods will include: lecture, discussion, demonstration, and project work. Course will also focus on current issues in technological education and international higher education.

Recommended background: SS 1401.

This course will be offered in 2003-04, and in alternating years thereafter.

SS 2405. THE PSYCHOLOGICAL STUDY OF ENVIRONMENTAL ISSUES.*Cat. II*

Environmental policymakers are increasingly coming to the realization that, in order to be effective, their policies must be based on an understanding of how people think. In this course the fields of social and cognitive psychology will provide the background and methodology for an examination of the thought processes of individuals and groups when they are faced with environmental problems in the course of their daily lives. This evaluating alternative public policies in such areas as global warming, hazardous waste disposal, cancer prevention, and species extinct. Topics will include, but not be limited to: (1) Environmental values (How do people decide what a cleaner environment is worth to them?); (2) Environmental perception and judgment (How do people decide that an environmental problem is severe enough to warrant remedial action?); (3) Environmental education (How accurate are people's mental conceptions of environmental problems and how can accuracy be improved by educational programs?); (4) Environmental attitudes and behavior (What is the relationship between what people say they should do about the environment and what they actually end up doing?). Students considering or planning IQP projects on environmental topics will find this course to be particularly valuable.

Recommended background: SS 1401 or SS 1402.

This course will be offered in 2003-04 and in alternating years thereafter.

SS 2406. CROSS-CULTURAL PSYCHOLOGY: HUMAN BEHAVIOR IN GLOBAL PERSPECTIVE.*Cat. II*

This course is an introduction to the study of the ways in which social and cultural forces shape human behavior. Cross-Cultural psychology takes a global perspective of human behavior that acknowledges both the uniqueness and interdependence of peoples of the world. Traditional topics of psychology (learning, cognition, personality development) as well as topics central to social psychology, such as intergroup relations and the impact of changing cultural settings, will be explored. Cultural influences on technology development and transfer, as they relate to and impact upon individual behavior, will also be investigated. Students preparing to work at international project centers, International Scholars, and students interested in the global aspects of science and technology will find the material presented in this course especially useful.

Recommended background: SS 1402.

This course will be offered in 2004-05 and in alternating years thereafter.

SS 2530. ADVANCED TOPICS IN SYSTEM DYNAMICS MODELING.*Cat. II*

This course will focus on advanced issues and topics in system dynamics computer simulation modeling. A variety of options for dealing with complexity through the development of models of large-scale systems and the partitioning complex problems will be discussed. Topics will include an extended discussion of model analysis, the use of summary statistics and sensitivity measures, the model validation process, and policy design. The application of system Dynamics to theory building and social policy are also reviewed. Complex nonlinear dynamics and the chaotic behavior of systems will be discussed. Students will be assigned group exercises centering on model analysis and policy design.

Recommended background: SS1520.

This course will be offered in 2003-04 and in alternating years thereafter.

SS 2540. GROUP MODEL BUILDING.*Cat. II*

This course will review the system dynamics practice of group model building, in which a system dynamics model is created through close interaction with a team of policy makers or managers. Topics will include theories of mental models, alternate techniques for eliciting, mapping, and sharing mental models for use in model building, procedures for group facilitation, individual and team learning, group communication and decision making processes, and factors that promote or impede group performance. Special attention will be paid to the rigorous assessment of learning and group performance.

Recommended background: SS1520.

This course will be offered in 2003-04 and in alternating years thereafter.

SS 3278. TECHNOLOGY ASSESSMENT AND IMPACT ANALYSIS SEMINAR.*Cat. II*

The Indicators, Impact and Assessment Seminar is a specialized concepts and methods course designed primarily for Society-Technology Majors and students presently engaged in planning projects to carry out such analyses. It is run "seminar" style with one third of the sessions being reserved for student presentations. The course includes a laboratory experience and will stress the assessment of the research designs of existing and proposed social impact and reception of innovation studies. One focus of attention will be the national effort to devise "science indicators" by the National Science Foundation to monitor the vitality of the research enterprise in the United States. Prospective and retrospective technology assessments will also be compared. Typical of the case studies to be considered would be an examination of the predicted impact of nuclear power 30 years ago and assessments of its promise today. Assessment of the promise and problems of computers, robotics and space technology being made today are possible topics of discussion, depending on class interest. The "Creativity and Scientific Community" or "The Technology-Society Debate" courses would be a good preparation for this seminar. Students with background in social science research methods and at least one social concepts course would be fully prepared for participation.

Recommended background: SS 2208.

This course will be offered in 2003-04 and in alternating years thereafter.

SS 3550. SYSTEM DYNAMICS SEMINAR.*Cat. II*

This special topics course is designed primarily for system dynamics majors and students presently engaged in planning system dynamics projects. The course will be conducted as a research seminar, with many sessions being reserved for student presentations. Classical system dynamics models will be replicated and discussed. Students will read, evaluate, and report on research papers representing the latest developments in the field of system dynamics. They will also complete a term project that addresses a specific problem using the system dynamics method.

Recommended background: SS 1520 and SS 2530.

This course will be offered in 2003-04 and in alternating years thereafter.

ACADEMIC POLICIES AND PROCEDURES

SECTION

four

Grades	222
Grade Appeal And Grade Change Policy	223
Transfer Students	225
Transcript Fees	225
Degree Audits	225
Designation of Major Area of Study	225
Double Major	225
Designation of Class Year	225
Guidelines for the Determination of Satisfactory Academic Progress, Academic Warning, Academic Probation and Academic Suspension	226
Administrative Obligations	227
Directory Information and Release of Information	227
Registration	227
Project and Independent Study Registration.	228
Registration Policy for Degree Requirements	229
Special Students	229
Project Registration Topic Codes	229
Coding of Project Advisors	230

GRADES

DISTRIBUTION OF GRADES

Academic grades may be released legally to the parents of dependent students. In accordance with affirming legal opinion, effective August 1, 1986, WPI assumes that all undergraduates have dependent status unless they inform the Projects and Registrar's Office in writing that they are independent. Petition forms are available in the Projects and Registrar's Office. Such a declaration may be filed by a student at any time. After receipt of such notice, the Registrar will not release grades to parents unless legal evidence of dependency is presented to the contrary.

(The listing of a student as a dependent on the parent's IRS 1040 Form is the accepted legal evidence of dependency under the Privacy Act or Buckley Amendment. Information on file with the Financial Aid Office will remain confidential within that office and will not be used in any manner relative to this issue).

GRADE SYSTEM SELECTION

The PLAN grading system applies only to admitted, degree-seeking undergraduate students. All other students such as Consortium (CO), nondegree-seeking Special Students (SX), and Graduate students will receive traditional A, B, C, D, F, Withdrawal and Pass/Fail grades.

The AD, AC grading system applies to all degree candidates who matriculated prior to May 1, 1986, and who have not exercised the one-time option to change to the A, B, C system.

PLAN (Current system)

Projects: The following term grades are possible: A, B, C, SP (Satisfactory Progress), NAC (Not Acceptable) and NR (No record).

Courses: The following grades are possible: A, B, C, NR, and I (Incomplete). An instructor may also assign an "I" in an Independent Study course. AT (attended) is used to denote participation in seminars or college-sponsored programs.

TRADITIONAL (System before mid-1970's)

Courses: The following grades are possible: A, B, C, D, F, Withdrawal, and I (Incomplete).

GRADES FOR COMPLETION OF DEGREE REQUIREMENTS

The overall evaluation of degree requirements (for the MQP, the IQP and the Sufficiency) will be graded in the student's respective grade system. The transcript will contain an abstract describing the content of the completed project.

NO RECORD (NR)

The NR (No Record) grade is assigned by a faculty member for course or project work for which credit has not been earned. This grade applies to PLAN students (admitted, degree-seeking) only. The NR grade does not appear on the students' transcripts or grade reports, nor is it used in the calculation of satisfactory academic progress.

INCOMPLETE (I)

An I grade, when assigned, will be changed to NR after one term unless extended in writing by the instructor to the Projects and Registrar's Office. The I grade is not assigned for Qualifying Projects or the Sufficiency.

SATISFACTORY PROGRESS (SP)

In project work (IQP, MQP only) extending beyond one term for which a grade is not yet assigned, an interim grade of SP (Satisfactory Progress) may be used on grade sheets. In such cases, the SP evaluation will count as units earned toward meeting the 15-unit rule, the distribution requirements, and the minimum standards for satisfactory academic progress. SP grades remain on the transcript until changed to the final grade as submitted on the Completion of Degree Requirement Form or through the grade change form procedure.

OTHER GRADES

A ? or Q signifies a grade that has not been submitted.

PROJECT GRADING

The Faculty of WPI have endorsed the following grading guidelines for project activity:

1. Each term a student is registered for a project, the student receives a grade reflecting judgment of accomplishments for that term.
2. Upon completion of the project, students will receive an overall project grade. It is important to note that this grade reflects not only the final products of the project (e.g., results, reports, etc.), but also the **process** by which they were attained. No amount of last-minute effort should turn a mediocre project effort into an A.
3. The available grades and their interpretations are as follows:
 - **A:** a grade denoting a consistently excellent effort, and attaining the stated project goals.
 - **B:** a grade denoting a consistently good effort, and attaining the stated project goals.
 - **C:** a grade denoting an acceptable effort, and partially attaining the stated project goals.
 - **SP:** a grade denoting an effort sufficient for the granting of the credit for which the student is registered. This grade provides students with no feedback, and its use is discouraged except for circumstances in which the faculty member is unable to judge the quality of the work (yet can still determine that the granting of credit is appropriate).
 - **NAC:** a grade denoting an effort unacceptable for the credit for which the student is registered. Note that this grade is entered into the student's transcript.
 - **NR:** a grade denoting an effort insufficient for the credit for which the student is registered. This grade is appropriate when the project has not proceeded due to circumstances beyond the control of the student, or for project extensions which do not represent the full amount of credit for which the student is registered.
4. The results of a project should be such that an outside reviewer would reasonably deem the project as being worthy of the credit and grade given, based on evidence such as the project report.
5. In light of the above grading criteria, it is strongly suggested that a formal project proposal or contract be developed early in the project activity, so that all participants in the activity have a clear understanding of the project goals, and advisor and student expectations.

CUMULATIVE POINT AVERAGE

WPI does not maintain a Cumulative Grade Point Average for undergraduate students. A student who needs a cumulative point average for external use may apply to the Registrar and receive a *numerical equivalent*. This information is usually provided only for students applying to graduate or professional schools when the application process requires a translation. Cumulative point averages will *not* be printed on student's transcripts nor shall class rankings be developed from them.

When requested by the student, the numerical equivalent of the cumulative point average will be based on a point assignment of A = 4.0, B = 3.0, C = 2.0 while DIST and AC grades will be 4.0 and 2.75 respectively.

TRANSFER CREDIT

WPI encourages qualified transfer students to apply for admission to WPI. Transfer students bring to WPI an added richness of experience, educational background, and diversity that serves to strengthen the educational experience of all students at WPI.

After a student has been accepted and final transcripts received, the Office of Academic Advising coordinates the formal evaluation of credit accepted toward a WPI degree. Courses taken at regionally accredited post-secondary institutions which satisfy a WPI departmental review of course content and level and which are comparable to courses offered at WPI will be granted credit if a grade of C or better is achieved. Formal transfer credit evaluations are provided only to applicants who have been admitted.

Free elective credit may be awarded through the office of academic advising for courses with no WPI equivalent. However, any courses considered for transfer must be relevant to WPI's educational mission. Vocational, correspondence, pre college or review courses are not transferable. Also, noncredit CEU courses, adult enrichment or refresher courses, and CLEP examinations are not recognized for transfer credit.

WPI reserves the right not to award credit for courses which were taken more than eight years prior to the date when the student applies for transfer when, in the opinion of the department, the knowledge attained in such courses is deemed to be out of date and/or in need of verification.

Students may petition the Committee on Academic Operations (CAO) for cases involving procedural irregularity.

The policy does not apply for students attending WPI who subsequently take courses elsewhere.

If you are currently a WPI student: Students who wish to take courses at an accredited post-secondary institution should obtain a WPI Transfer Credit Authorization form from the Projects and Registrar's Office. This form and the course description should be taken to the WPI department head and academic advisor for approval.

If the transfer credit is to be used toward the Sufficiency requirement, the Sufficiency advisor must also approve the transfer-credit authorization.

The completed form should be returned to the Projects and Registrar's Office. After successful completion of the course, an official transcript should be sent to WPI. Students will be notified when the transcript has been received and credit posted.

GRADUATION WITH HONORS

For all degree candidate students graduating from WPI after May 1, 1986, graduation honors will be determined as follows:

Graduation With High Distinction

An A or DIST grade on any *four* of the following:

- MQP
- IQP
- Sufficiency
- Six units of work registered at WPI (exclusive of PE and of the MQP, IQP or the SUFF/Independent Study component of the Sufficiency)

Graduation With Distinction

An A or DIST grade on any *three* of the above.

CREDIT OVERLAP FOR DEGREE DESIGNATIONS AND REQUIREMENTS

If a student wishes to complete two Interdisciplinary (individually designed) Majors Programs, the double major must be proposed in a single Educational Program Proposal, which must be approved by the student's Program Advisory Committee for each major. The Committees shall ensure that the majors are substantially nonoverlapping.

If a student's double major includes an Interdisciplinary (individually designed) Major Program, the double majors must be described in the Educational Program Proposal for the Interdisciplinary Major.

For students completing a double major, the rules regarding graduation with honors (above) are modified so that both MQPs are included in the list of items counted towards graduation with honors. High Distinction shall require an A grade on any five items in the list. Distinction shall require an A grade on any four items in the list. If a single project is used to satisfy a requirement for both majors, then an A grade on that project shall count twice in the list of items counted towards graduation with honors.

GRADE APPEAL AND GRADE CHANGE POLICY

The purpose of the Grade Appeal Policy is to provide the student with a safeguard against receiving an unfair final grade, while respecting the academic responsibility of the instructor. Thus, this procedure recognizes that,

- Every student has a right to receive a grade assigned upon a fair and unprejudiced evaluation based on a method that is neither arbitrary nor capricious; and,
- Instructors have the right to assign a grade based on any method that is professionally acceptable, submitted in writing to all students, and applied equally.

Instructors have the responsibility to provide careful evaluation and timely assignment of appropriate grades. Course and project grading methods should be explained to students at the beginning of the term. WPI presumes that the judgment of the instructor of record is authoritative, and the final grades assigned are correct.

A grade appeal shall be confined to charges of unfair action toward an individual student and may not involve a challenge of an instructor's grading standard. A student has a right to expect thoughtful and clearly defined approaches to course and project grading, but it must be

recognized that varied standards and individual approaches to grading are valid. The grade appeal considers whether a grade was determined in a fair and appropriate manner; it does not attempt to grade or re-grade individual assignments or projects. It is incumbent on the student to substantiate the claim that his or her final grade represents unfair treatment, compared to the standard applied to other students. Only the final grade in a course or project may be appealed. In the absence of compelling reasons, such as clerical error, prejudice, or capriciousness, the grade assigned by the instructor of record is to be considered final.

In a grade appeal, *only arbitrariness, prejudice, and/or error* will be considered as legitimate grounds for an appeal.

Arbitrariness: The grade awarded represents such a substantial departure from accepted academic norms as to demonstrate that the instructor did not actually exercise professional judgment.

Prejudice: The grade awarded was motivated by ill will, and is not indicative of the student's academic performance.

Error: The instructor made a mistake in fact.

This grade appeal procedure applies only when a student initiates a grade appeal and not when the instructor decides to change a grade on his or her own initiative. This procedure does not cover instances where students have been assigned grades based on academic dishonesty or academic misconduct, which are included in WPI's Academic Honesty Policy. Also excluded from this procedure are grade appeals alleging discrimination, harassment or retaliation in violation of WPI's Sexual Harassment Policy, which shall be referred to the appropriate office at WPI as required by law and by WPI policy.

The Grade Appeal Procedure strives to resolve a disagreement between student and instructor concerning the assignment of a grade in a collegial manner. The intent is to provide a mechanism for the informal discussion of differences of opinion, and for the formal adjudication by faculty only when necessary. In all instances, students who believe that an appropriate grade has not been assigned must first seek to resolve the matter informally with the instructor of record. If the matter cannot be resolved informally, the student must present his or her case in a timely fashion in the procedure outlined below. Under normal circumstances, the grade appeal process must be started near the beginning of the next regular academic term after the disputed grade is received.

STUDENT GRADE APPEAL PROCEDURE

1. A student who wishes to question a grade must discuss the matter first with the instructor of record as soon as possible, preferably no later than one week after the start of the next regular academic term after receiving the grade. In most cases, the discussion between the student and the instructor should suffice and the matter will not need to be carried further. The student should be aware that the only valid basis for grade appeal beyond Step One is to establish that an instructor assigned a grade that was arbitrary, prejudiced, or in error.

2. If the student's concerns remain unresolved after the discussion with the instructor, the student may submit a written request to meet with the appropriate Department Head, within one week of speaking with the instructor. For a grade in a course, independent study, Sufficiency Project, or Major Qualifying Project (MQP), the appropriate person is the instructor's Department Head. For a grade in an Interactive Qualifying Project (IQP), the appropriate person is the Dean of the Interdisciplinary and Global Studies Division (IGSD). If the instructor of record is a Department Head or the Dean of the IGSD, then the student should request to meet with the Associate Provost, who will serve as the appropriate Department Head in this step. The appropriate Department Head will meet within one week with the student, and, if he or she believes that the complaint may have merit, with the instructor. After consultation with the Department Head, the instructor may choose to let the grade remain, to change a course grade, or to petition the Committee on Academic Operations to change a grade for a Degree Requirement (MQP, IQP, or Sufficiency). The Department Head will communicate the result of these discussions to the student.
3. If the matter remains unresolved after Step Two, the student should submit a written request within one week to the Provost's Office to request an *ad hoc* Faculty Committee for Appeal of a Grade. The Associate Provost will meet with the student, and will ask the Faculty Review Committee to appoint the *ad hoc* Committee for Appeal of a Grade. The FRC, in consultation with the Associate Provost, will select the members of the *ad hoc* committee. The Chair of the FRC will convene the *ad hoc* committee and serve as its non-voting chair. The *ad hoc* committee for appeal of a grade in a course, independent study, Sufficiency Project, or MQP will be composed of three faculty members chosen in the instructor's department or in closely allied fields. The *ad hoc* committee for appeal of a grade in an IQP will be composed of the instructor of record's Department Head and two faculty members who are experienced advisors of IQPs chosen from any department. Appointees to the *ad hoc* committee must not have any apparent conflicts of interest with the instructor of record (which might include but are not limited to frequent co-advising or research collaboration). The committee would examine available written information on the dispute, would be available for meetings with the student and with the instructor, and would meet with others as it sees fit.
4. Through its inquiries and deliberations, the *ad hoc* committee is charged to determine whether the grade was assigned in a fair and appropriate manner, or whether clear and convincing evidence of unfair treatment such as arbitrariness, prejudice, and/or error might justify changing the grade. The *ad hoc* committee will make its decisions based on a majority vote. If the committee concludes that the grade was assigned in a fair and appropriate manner, the *ad hoc* committee will report its conclusion in writing to the student and instructor and the matter will be considered closed. If the *ad hoc* faculty committee determines that compelling reasons ex-

ist for changing the grade, it would request that the instructor make the change, providing the instructor with a written explanation of its reasons. Should the instructor decline, he or she must provide a written explanation for refusing.

5. The *ad hoc* faculty committee, after considering the instructor's explanation and upon again concluding that it would be unjust to allow the original grade to stand, will then determine what grade is to be assigned. The new grade may be higher than, the same as, or lower than the original grade. Having made this determination, the three members of the committee will sign the grade change form and transmit it to the Registrar. The instructor and student will be advised of the new grade. Under no circumstances may persons other than the original faculty member or the review committee change a grade. Should the *ad hoc* faculty committee feel that the instructor's written explanation justifies the original grade, the *ad hoc* committee will report this in writing to the student and instructor and the matter will be closed.

FACULTY GRADE CHANGE PROCEDURE

The Student Grade Appeal Procedure affirms the principle that grades should be considered final. The principle that grades for courses or projects should be considered final does not excuse an instructor from the responsibility to explain his or her grading standards to students and to assign grades in a fair and appropriate manner. The appeal procedure also provides an instructor with the opportunity to change a grade for a course or project on his or her own initiative. The appeal procedure recognizes that errors can be made and that an instructor who decides that it would be unfair to allow a final grade to stand due to error, prejudice or arbitrariness may request a change of grade for a course or project without the formation of an *ad hoc* committee. An instructor may request a grade change in one of two ways. First, for courses, an instructor may submit a course grade change in writing to the Registrar at any time prior to a student's graduation. Second, for Degree Requirements (MQP, IQP, and Sufficiency), an instructor must submit a petition to the Committee on Academic Operations (CAO) to change the grade.

TRANSFER STUDENTS

Transfer students should check with the Projects and Registrar's Office to determine whether their course grades would qualify for WPI honors.

TRANSCRIPT FEES

Transcripts are furnished upon written request to the Projects and Registrar's Office. Each student is allowed one free transcript. Each additional transcript is subject to a fee established by the college administration. Official transcripts cannot be faxed.

The college reserves the right to withhold the release of transcript information for students with administrative obligations.

DEGREE AUDITS

WPI has developed a computerized degree audit which lists students' courses as they apply to the respective department distribution requirements. The degree audit is available online.

Any course substitutions or exceptions to the degree audit must be forwarded to the Registrar IN WRITING from the Department Program Review Committee.

DESIGNATION OF MAJOR AREA OF STUDY

Designation of a student's major area of study on the transcript is determined by his or her completion of published academic activity distribution requirements, as well as by the Major Qualifying Project. The authority and responsibility of certification of the disciplinary or interdisciplinary area will lie with the appropriate departmental or IGSD Program Review Committee (PRC) in consultation with the student and his or her academic advisor.

For examples of major areas of study, please see page 24.

DOUBLE MAJOR

DISTRIBUTION REQUIREMENTS

The distribution requirements of each major must be met, but requirements common to both majors may have to be met only once. A minimum of three units of qualifying project work is thus required for fulfillment of the project portion of the double major requirements: one unit in each of the two major areas of study, and one unit of an IQP. It is the intent of this policy that the three units of project activity requirement be interpreted to mean three *distinct* project activities, each bearing *at least* one unit of credit.

For students wishing to pursue double majors not involving social science, the program audit for each intended major must be completed and certified by the review committee of each department involved. Academic activities appropriate to both majors may be counted in both majors.

The number of majors associated with a single WPI Bachelor of Science degree shall be **limited to two**.

For the policy in the special situation of double majors involving the social sciences, see page 167.

DESIGNATION OF CLASS YEAR

Class year will normally be designated as year of matriculation plus four with the additional requirement that the accumulation of 30/3 units is necessary for fourth-year status, 19/3 units for third-year status, and 8/3 units for second-year status. The class year of transfer students will be determined on an individual basis. Class year designations will be reviewed at the end of Term E each year and changed if the credit accumulation does not meet the above specifications. After Term E, students may petition to be redesignated in their original class if they meet the minimum unit requirements.

GUIDELINES FOR THE DETERMINATION OF SATISFACTORY ACADEMIC PROGRESS, ACADEMIC WARNING, ACADEMIC PROBATION AND ACADEMIC SUSPENSION

SATISFACTORY ACADEMIC PROGRESS

In order to assist both the student, parents and the academic advisor in determining whether a student is making academic progress, WPI has adopted both of the following guidelines, effective Term A, 1989.

1. The student must complete at least 4/3 units of work in two successive terms, including Military Science, Physical Education and Consortium courses.
2. The student must complete at least 8/3 units of work in four successive terms, including Military Science, Physical Education and Consortium courses.

Note: Term E (Summer School) will be included if the student is registered full time.

ACADEMIC WARNING

Each student's academic record will be reviewed at the conclusion of terms B and D according to the guidelines above. If a student's performance falls short of either guideline 1 or 2, the student, parent and academic advisor will be notified that the student is not making satisfactory progress. The notification will place the student on *Academic Warning*. At this time, the student is urged, with the help of his/her advisor, to identify the nature of the academic difficulty and to formulate a course of action for overcoming the difficulty.

ACADEMIC PROBATION

During the next review of academic progress, should the student fail, once again, to maintain satisfactory academic progress, the student, parent and academic advisor will be notified. This notification will place the student on *Academic Probation* for two terms. Academic Probation will prevent the student from receiving financial aid, will result in loss of eligibility for team sports, will prevent the student from obtaining undergraduate employment in the Co-op Program and will prevent participation in the Global Perspectives Program.

Students who obtain no academic credit (exclusive of Physical Education or ROTC-related courses) in either Term A or Term C shall be sent a letter by the Director of Academic Advising informing them of the following change of academic status if they earn no academic credit for the next term for which they are registered.

Students who fail to obtain credit for two consecutive terms shall:

- a) be placed on Academic Probation if currently they are classified as making satisfactory progress, or
- b) be placed on Academic Suspension if currently they are on the list of students on Academic Warning or on Academic Probation.

Subsequent academic review shall follow the rules for all students.

This amendment shall be incorporated in the Undergraduate Catalog and shall be implemented as of the Fall semester of 1994. Students affected by this rule retain the right to petition the Committee on Academic Operations for a waiver for extenuating circumstances.

ACADEMIC SUSPENSION

Should a student on Academic Probation fail to make satisfactory academic progress during the next review period, the student will be *suspended* from WPI. The notification will prevent the student from enrolling as a full-time student or a special student for at least the next two terms. Subsequent readmission is subject to approval (with possible conditions) of a petition through the Registrar to the Committee on Academic Operations (CAO). As a general rule, a student readmitted after suspension will be placed on an Academic Probation status.

IMPROVEMENT IN STATUS

Students on Academic Warning or Academic Probation have the opportunity to improve their status by progressing through the levels in reverse order. If a student on Academic Probation satisfactorily meets the guidelines at the end of the next review period, he or she will be moved to the list of students on Academic Warning. A student on Academic Warning would be moved back to Satisfactory Academic Progress status.

TERM E REVIEW PERIOD

An exception to the guidelines stated above can occur when a student registers full time for Term E. At the conclusion of Term E, a review will be conducted which will include the previous five terms. If the student has completed 10/3 units acceptable work, the student's academic progress status will improve. Thus, a student on Warning status after the Term D review will start terms A and B on Satisfactory Academic Progress. A student placed on Academic Probation after the Term D review will be on Warning status for terms A and B. A student on Suspension status after the Term D review will be able to register for terms A and B on Academic Probation.

SUMMER BRIDGE PROGRAM

Students who finish the academic year on Academic Warning or Academic Probation status, but who have passed at least 2 units of academic work during the previous four terms, are eligible to participate in the Summer Bridge Program. Students who participate in the program enroll in Term E for two courses and also take a four-week study skills program. Successful completion of the courses and the study skills program will result in the academic status rising one level (Academic Probation to Academic Warning, or Academic Warning to Satisfactory Academic Progress), and eligibility for financial aid restored. The Office of Academic Advising coordinates the Summer Bridge Program.

SPECIAL STUDENTS

Students pursuing the bachelor's degree as special students will be subject to the same review schedule and standards as full-time students except that, during any review period, the student's academic record from the *four* most recent terms will be checked to ensure the student has satisfactorily completed at least two-thirds of the academic activities for which he/she has registered.

PETITIONS

Students may petition through the Projects and Registrar's Office to the Committee on Academic Operations (CAO) for reconsideration of the status of any of the following:

- Academic Warning
- Academic Probation
- Academic Suspension
- Readmission after Suspension
- Other unusual situations

Students who petition for reconsideration of status must accomplish the following:

1. Go to the Projects and Registrar's Office and obtain a petition form.
2. Complete form with advisor and obtain advisor's approval and signature.
3. Submit form to the Projects and Registrar's Office within *three* weeks of the issuance of grades for B, D, or E term reviews except for readmission after suspension. For readmission after suspension, petitions must be submitted to the Projects and Registrar's Office at least three weeks prior to the start of classes.

READMISSION AFTER SUSPENSION

Deadlines for petitions:

July 15 for Term A

November 15 for Term C

ADMINISTRATIVE OBLIGATIONS

The college reserves the right to hold grades, transcripts, registration and/or diploma for any student who has an outstanding administrative obligation with the college.

REGISTRATION

A calendar is published by the Registrar prior to the enrollment course-change period which specifies the time periods and fees for late changes. Students are responsible for the dates and should contact the Projects and Registrar's Office if they need information to avoid late fees. Requests for exceptions to published deadlines must be submitted in writing and approved by the Registrar prior to Enrollment Day, and will be granted based on documented extenuating circumstances, i.e., medical, military obligations.

REGISTRATION

During the spring, students will receive information regarding course offerings for the following academic year. After consulting with academic advisors, students will make course selections via the online registration system. Students with holds may be prevented from registering until the obligation is met.

ENROLLMENT

At the beginning of terms A and C, students will receive enrollment information. **All students must enroll whether or not course changes are to be made.**

DIRECTORY INFORMATION AND RELEASE OF INFORMATION

The items listed below are designated as Directory Information and may be released at the discretion of the institution. Under the provisions of the Family Educational Rights and Privacy Act of 1974, as amended, students have the right to withhold the disclosure of any or all of the categories of Directory Information. Written notification to withhold directory information must be received by the Projects and Registrar's Office during the first week of the fall semester. Forms are available at registration and in the Projects and Registrar's Office. A request to withhold directory information in no way restricts internal use of the material by the college.

Directory information will include the student's campus mailbox, full name, year, major codes, advisor code, e-mail address, home address, local address, local phone, date and place of birth, dates of attendance, degrees and awards received, and most recent or previous educational agency or institution.

Unless a student notifies the Projects and Registrar's Office in writing to the contrary, the college considers all undergraduate students to be dependents of their parents. In compliance with the Family Educational Rights and Privacy Act, the college reserves the right to disclose information about the status of dependent students to their parents without the students' written consent. Petition forms for Declaration of Independent Status are available in the Projects and Registrar's Office upon request (see information under Distribution of Grades, page 222).

COURSE CHANGES

Course changes can be made online (<http://registrar.wpi.edu>) until 4 p.m. on the second day of classes for each term.

APPLICATION FOR DEGREE

Each student must file an application for degree with the Projects and Registrar's Office in accordance with the following schedule:

To graduate in:

May	Beginning of preceding Term B
October	Beginning of preceding Term D
February	Beginning of preceding Term A

WAIT LISTS

When a seat in a class becomes available to a student on the wait list, he or she will be notified via e-mail. The e-mail contains instructions on how to claim the available seat.

If a student does not receive an e-mail, it means no seat is available for him/her in the wait-listed class. Wait lists for an upcoming term are abolished on the first day of classes for that term. Students are automatically removed from the list at that time.

OVERLOADS OF COURSES

The standard course load for WPI students is one unit per term (exclusive of courses for ROTC, and Physical Education, which do not count towards overloads). Students may register in advance for a maximum of one unit in any term.

Registration for courses which will result in an overload may take place, on a space-available basis, as of the first day of the term in which that course is offered.

A student may not include any portion of qualifying work (project or Sufficiency) as part of an overload without the approval of both the academic and project advisors. Written approval will be requested before registration can be completed in such cases.

Overload charges will be computed each semester based on the course and project load included in the student's final term registration.

To compute overload charges, see Expenses, page 248.

WITHDRAWAL FROM COURSES

Students on the WPI Plan who wish to withdraw from a course or project will be assigned a grade of NR (No Record) by the instructor. The student should contact the instructor and indicate that he/she will not be continuing in the class.

WITHDRAWAL FROM WPI

Students wishing to withdraw from WPI should initiate that procedure by consulting the Director of Academic Advising. Any tuition refund is directly dependent on the date the student officially withdraws and formally files his/her paperwork with the Projects and Registrar's Office.

PROJECT AND INDEPENDENT STUDY REGISTRATION

PLANNING

During the academic planning period, which starts in February, students who intend to conduct project work during the following year should set aside time to plan their projects, meet with faculty, and form project teams. The faculty will list project opportunities on the Projects Program web page in February. (Some Project Centers and special programs may have an application process before that.) Each academic department typically will hold a projects information meeting for students in their major. Students are also encouraged to meet with faculty individually.

The most important and difficult part of a project is the planning which precedes the execution. The planning phase of your project will involve developing a background, talking to people in the field, finding out what has already been done in the area, and determining what your goals are and what you need to do to accomplish them. If any special equipment, financing, or resources will be needed for execution of the project, it is especially important to make this known early to ensure that it will be available to you. In addition, most faculty members require a project proposal before registration of the project.

REGISTRATION

Students who intend to do project work next year should complete a registration form during the Project Registration Period. During other times of the year, registration for project or independent study work must be completed within the course-change period of any term. The Project Registration Form is available at the Projects and Registrar's Office.

For registration, the following information is needed: project title, advisor(s), discipline(s), name and address of off-campus organization (if any), and type (major qualifying, interactive qualifying or pre/postqualifying project). Projects involving an off-campus organization carry the further obligation of compliance with the rules and regulations of the organization. Often, these are specified in a formal contract between the organization and WPI and are legally binding. At the time of registration, students will be required to review the legal documents in the Projects Office and sign an agreement and release form.

Students may not receive pay from an off-campus organization and project credit for the same work.

Students must note that where the major area of study is a recognized disciplinary area of the college, either the MQP advisor or an associate advisor must be a member of the faculty in that discipline.

Additional information regarding project registration will be available through the Projects and Registrar's Office prior to the registration period.

CHANGE OF REGISTRATION INFORMATION

For all changes in projects, use the Project Registration Form. Students may change the title, the type or the discipline of the project with the approval of the project advisor but without having to secure the approval of the academic advisor. The student must obtain the project advisor's written approval and the academic advisor's approval before changing the number of units in the current or future terms.

All project changes are to be made only during the course-change period of each term.

CHANGING PROJECT ADVISOR

To change the project advisor for a degree-required project, students must obtain the authorizing signatures of both the existing and new project advisors and of the academic advisor and submit the form during a course change period.

PROJECT CONFERENCES

Students should report to their project advisor's office at the beginning of the term to make arrangements for subsequent meetings.

OVERLOADS

If a part of the work in a given term involves qualifying project work, students may not register for an overload without the written approval of both the academic and project advisors on a project overload petition form. This form is available at the Projects & Registrar's Office.

PROJECT COMPLETION

During the final term of registration for the project and sufficiently prior to the deadline for submittal of Completion of Degree Requirement Forms, students must submit their completed project report to the project advisors.

Students are also required to submit a copy of the document to the participating off-campus organization sufficiently prior to the end of the term so that proprietary and confidential information in the report can be identified and removed. Most off-campus organizations require 30 days for this review, and the grade and final report cannot be submitted to the Registrar by the project advisor until this review has been done.

The project report must contain a title page similar in format to that specified on the Projects Program web page, in the area entitled, "Finishing Up." The report itself must be submitted in a hard binding equivalent to the pressboard binders available in the WPI Bookstore. (See Documentation and Final Report Procedures on page 36.)

REGISTRATION POLICY FOR DEGREE REQUIREMENTS

The completion of a degree requirement (MQP, IQP or Sufficiency) will *not* be recorded in the Projects and Registrar's Office on or after the first day of classes of a term unless the student is registered for a minimum of 1/6 unit of the same activity in that term. The deadline for receipt of the Completion Form (and reports for projects) is the last working day *prior* to the first day of classes for the next term. *Any* exceptions to this policy must be handled by written petition from the project advisor.

NOTE: Candidates for degrees must meet graduation deadlines if they differ from the above. Deadlines for degree candidates will be strictly enforced!

Only Completion of Degree Requirement (CDR) forms which are complete, correct and consistent with the student's registration records will be accepted by the Projects and Registrar's Office. The CDR must be accompanied by the written report or other appropriate documentation. (See PROJECTS section, page 35.)

SPECIAL STUDENTS

The status of Special Student during the regular academic year is granted only to those who meet one or more of the following qualifications:

1. Persons holding a baccalaureate degree before the start of a semester.
2. Persons wishing to take a specific course and who are not pursuing a degree program at WPI.
3. Persons pursuing a degree program over an extended period of time and who have a planned program which involves a *maximum* of one unit per semester (August through December; January through May) *throughout* the academic year.
4. Students who have completed four full years of undergraduate work, satisfied the residency requirement, and must complete a limited amount of additional work to complete their degree requirements.

Special students pay tuition on the basis of \$2,183 (2002-03 figure) per 1/3 unit at the start of each term. All other undergraduate students will pay full tuition (\$26,200 for the 2002-03 academic year) and will be considered regular students with full resident privileges.

(Special students may not engage in varsity / club sports, may not participate in any extracurricular activities, may be required to register for courses on a space-available basis, and *are not eligible for financial aid or any form of on-campus student employment.*)

The following registration procedures apply:

- Students who wish to enroll as special students must apply for such status before Enrollment Day, Term A. Such status will allow a maximum of one unit per each semester of the academic year. Students who enroll as regular students in the fall may *not transfer to or from* special student status until the following fall or until all degree requirements have been certified with the Projects and Registrar's Office as having been satisfactorily completed.
- Reduction from full-time to part-time status is not allowed at midsemester.
- Special students wishing to return as full-time students must be readmitted according to the procedures specified under Readmission in the Admissions section of this catalog, page 247.

For the Guidelines for Determination of Satisfactory Progress for Special Students, see page 226.

PROJECT REGISTRATION TOPIC CODES

MQP Majors and Coordinators

	Majors	Coordinators
BIO	Biology and Biotechnology	J. Rulfs
BBC	Biology and Biotechnology with Concentration	J. Rulfs
BC	Biochemistry	W. Hobey
BE	Biomedical Engineering	R. Peura
CA	Computers with Applications	L. Becker
CE	Civil Engineering	F. Hart
CH	Chemistry	W. McGimpsey
CM	Chemical Engineering	W. Clark
CS	Computer Science	L. Becker
EC	Economics	K. Saeed
ECE	Electrical and Computer Engineering	R. Labonte
EE	Electrical Engineering	R. Labonte
EP	Environmental Policy and Development	K. Saeed
ET	Economics & Technology	K. Saeed
EV	Environmental Engineering	L. Schachterle
HU	Humanities	M. Parkinson
ID	Interdisciplinary	P. Davis
IE	Industrial Engineering	S. Johnson
IS	International Studies	P. Hansen
MA	Mathematical Sciences	W. Farr
MAC	Actuarial Mathematics	A. Heinricher
ME	Mechanical Engineering	B. Savilonis
MFE	Manufacturing Engineering	M. Demetriou
MG	Management	M. Banks
MGE	Management Engineering	M. Banks
MIS	Management Information Systems	M. Banks
PH	Physics	T. Keil
PHE	Engineering Physics	T. Keil
SD	System Dynamics	K. Saeed
ST	Society, Technology & Policy	K. Saeed
TC	Technical, Scientific & Professional Communication	J. Trimbur

Humanities and Arts Sufficiency

Topics	Project Advisor
Topics in American Studies	S. Bullock (SCB), J. Hanlan (JPH), K.Ljungquist (KPL), J. Manfra (JM), L. Menides (LJM), W. Mott (WTM), J. Trimbur (JOT), J. Zeugner (JFZ)
Topics in Art	M. D. Samson (MDS)
Topics in Drama/Theatre	D. O'Donnell (DMO), S. Vick (SV)
Topics in Foreign Language (German)	D. Dollenmayer (DZD)
Topics in Foreign Language (Other)	A. Rivera (AAR)
Topics in Foreign Language (Spanish)	H. J. Manzari (HJM), A. Rivera (AAR)
Topics in Global Studies	W. Addison (WAA), P. Hansen (PHH), J. Zeugner (JFZ)
Topics in History (American)	W. Baller (WXB), S. Bullock(SCB), D. Gray (DEG), J. Hanlan (JPH), J. Manfra (JM), J. Zeugner (JFZ)
Topics in History (European)	W. Addison (WAA), W. Baller (WXB), J. Forngeng (JLS), P. Hansen (PHH)
Topics in History (Science and Technology)	E. Parkinson (EMP), J. Forngeng (JLS), M. Sokal (MMS)
Topics in International Studies- Humanities (Interrelated)	B. Addison (WAA), P. Hansen (PHH), J. Zeugner (JFZ)
Topics in Literature (American)	T. Code (TWC), K. Ljungquist (KPL), L. Menides (LJM), W. Mott (WTM) J. Trimbur (JOT)
Topics in Literature (Contemporary)	J. Brattin (JYB), T. Code (TWC)
Topics in Literature (English)	M. Ephraim (MKE)
Topics in Music	F. Bianchi (FB), L. Curran (LJC), J. Delorey (JD2), R. Falco (RGF), D. Weeks (DGW)
Topics in Philosophy	R. Gottlieb (RSG), G. Lew (GKL), J. Sanbonmatsu (JS6)
Topics in Religion	R. Smith (RLS), T. Shannon (TAS)
Topics in Writing, Rhetoric, and Communications	J. Trimbur (JOT)

CODING OF PROJECT ADVISORS

Code	Advisor	Department
DSA	Adams, D. S.	BB
WAA	Addison, W. A. B.	HU
EOA	Agu, E. O.	CS
LDA	Albano, L. D.	CE
SAA	Alvarez, S. A.	CS
DA	Apelian, D.	ME
PKA	Aravind, P. K.	PH
JMA	Arguello, J. M.	CH
HXA	Ault, H. K.	ME/BE
JCB	Bagshaw, J. C.	BB
WXB	Baller, W. A.	HU
MCB	Banks, M. C.	MG
JRB	Barnett, J. R.	FPE
IB	Bar-On, I.	ME
LAB	Becker, L. A.	CS
JIB	Bergendahl, J.	CE
FB	Bianchi, F.	HU
RRB	Biederman, R. R.	ME
KLB	Billiar, K. L.	BE
SJB	Bitar, S. J.	EE
JB3	Blandino, J. J.	ME
JYB	Brattin, J. J.	HU
MQB	Bromberg, M. C.	EE
CAB	Brown, C. A.	ME
DCB	Brown, D. C.	CS
DRB	Brown, D. R.	EE
SCB	Bullock, S. C.	HU
NAB	Burnham, N. A.	PH
TAC	Camesano, T. A.	CM
RDC	Cheetham, R. D.	BB
PRC	Christopher, P. R.	MA
MXC	Ciaraldi, M. J.	CS
EXC	Clancy, E. A.	EE
WMC	Clark, W. M.	CM/BE
MLC	Claypool, M.	CS
KAC	Clements, K. A.	EE
REC	Connors, R. E.	CH
TCC	Crusberg, T. C.	BB/BE
LJC	Curran, L. J.	HU
DC	Cyganski, D.	EE/BE
RAD	D'Andrea, R. A.	CE
GVD	Dalakouras, G. V.	MA
ED	Daneels, E.	MG
RYD	Datta, R.	CM
PWD	Davis, P. W.	MA
NAD	Dembsey, N. A.	FPE
MAD	Demetriou, M.	ME
CXD	Demetry, C.	ME
DDB	DiBiasio, D.	CM/BE
MFD	Dimentberg, M.	ME
JPD	Dittami, J. P.	CH
AGD	Dixon, A. G.	CM
DZD	Dollenmayer, D. B.	HU
DJD	Dougherty, D. J.	CS
JKD	Doyle, J. K.	SS
BDD	Doytchonov, B. D.	MA
RJD	Duckworth, R. J.	EE
WWD	Durgin, W. W.	ME/BE
TEL	El-Korchi, T.	CE
MBE	Elmes, M. B.	MG
AEE	Emanuel, A. E.	EE
MKE	Ephraim, M. K.	HU

Code	Advisor	Department	Code	Advisor	Department
CDF	Fairchild, C. D.	CH	PPM	Mathisen, P. P.	CE
WWF	Farr, W. W.	MA	SLM	Matson, S. L.	CM
JDF	Fehribach, J. D.	MA	SYM	McCoy, S.	MG
DXF	Finkel, D.	CS	WGM	McGimpsey, W. G.	CH
KXF	Fisler, K.	CS	JKM	McNeill, J.	EE
RWF	Fitzgerald, R. W.	CE	YXM	Mendelson, Y.	BE
MSF	FitzPatrick, M. S.	CE	LJM	Menides, L. J.	HU
MQF	Fofana, M.	ME	WZM	Michalson, W. R.	EE
			JEM	Miller, J. E.	BB
NAG	Gatsonis, N.	ME	JGM	Mistry, J. J.	MG
MXG	Gennert, M. A.	CS/BE	YMM	Moon, Y.-M.	ME
AG	Gerstenfeld, A.	MG	CJM	Morales, C. J.	MA
DVG	Gibson, D. G.	BB/BE	WTM	Mott, W. T.	HU
RSG	Gottlieb, R. S.	HU	KM	Mukherjee, K.	MG
PJG	Grebinar, P. J.	PE			
			BN	Nandram, B.	MA
NNH	Hachem, N.	CS	FN	Noonan, F.	MG
RRH	Hagglund, R. R.	ME	RLN	Norton, R. L.	ME
HH	Hakim, H.	EE			
JPH	Hanlan, J. P.	HU	JTO	O'Connor, J. T.	SS/MG
PHH	Hansen, P. H.	HU	DJO	Olinger, D. J.	ME
FLH	Hart, F. L.	CE	JAO	Orr, J. A.	EE
NTH	Heffernan, N.	CS	JCO	O'Shaughnessy, J. C.	CE
GTH	Heineman, G. T.	CS			
ACH	Heinricher, A. C.	MA	CP	Paar, C.	EE
HNH	Higgins, H. N.	MG	KZP	Pahlavan, K.	EE
WDH	Hobey, W. D.	CH	DPP	Papageorgiou, D. P.	EE
AHH	Hoffman, A. H.	ME	EMP	Parkinson, E. M.	HU
MKH	Hofri, M.	CS	JWP	Pavlik, J. W.	CH
ZWH	Hou, Z.	ME	OVP	Pavlov, O. V.	SS
MH	Humi, M.	MA	PCP	Pedersen, P.	EE
			JP	Petrucelli, J. D.	MA
GSI	Iannacchione, G. S.	PH	RAP	Peura, R. A.	BE/EE
			GDP	Phillies, G. D. J.	PH
SNJ	Jaspersen, S. N.	PH	SWP	Pierson, S. W.	PH
PJ	Jayachandran, P.	CE	RP	Pietroforte, R.	CE
HJ	Johari, H.	ME	GXP	Pins, G.D.	BE
SAJ	Johnson, S. A.	MG	JYP	Plummer, J. D.	CE
			SMP	Politz, S. M.	BB
CJK	Kasouf, C. J.	MG	RJP	Pryputniewicz, R. J.	ME
NKK	Kazantzis, N.	CM			
SCK	Kazin, S.	MG	RSQ	Quimby, R. S.	PH/BE
THK	Keil, T. H.	PH	PJQ	Quinn, P. J. M.	HU
NK	Kildahl, N.	CH			
REK	Kinicki, R. E.	CS	MJR	Radzicki, M. J.	SS
BYK	King, B. M.	EE	LRR	Ram-Mohan, L. R.	PH/EE
CK	Koleci, C.	PH	MHR	Ray, M. H.	CE
			JJR	Rencis, J. J.	ME
RQL	Labonte, R. C.	EE	FHR	Ribeiro, F. H.	CM
CJL	Larsen, C. J.	MA	MWR	Richman, M. W.	ME
KAL	Lemone, K. A.	CS	KJR	Rissmiller, K. J.	SS
LCL	Lew Yan Voon, L. C.	PH	AR	Rivera, A.	HU
KPL	Ljungquist, K. P.	HU	YR	Rong, Y.	ME
ETL	Loiacono, E. T.	MG	CR	Ruiz, C.	CS
FJL	Looft, F. J.	EE	JXR	Rulfs, J.	BB
DAL	Lucht, D. A.	FPE	EAR	Rundensteiner, E. A.	CS
REL	Ludwig, R.	EE	EFR	Ryder, E. F.	BB
RYL	Lui, R. Y. M.	MA			
KKL	Lurie, K. A.	MA	KQS	Saeed, K.	SS
			GFS	Salazar, G. F.	CE
YHM	Ma, Y. H.	CM	MDS	Samson, M. D.	HU
JM8	MacDonald, J. C.	CH	JS6	Sanbonmatsu, J.	HU
MVM	Makhlouf, M. M.	ME	MOS	Sarkis, M.	MA
SNM	Makarov, S. N.	EE	BJS	Savilonis, B. J.	ME/BE
RBM	Mallick, R. B.	CE	AAS	Scala, A. A.	CH
JM	Manfra, J.	HU	LES	Schachterle, L. E.	HU
HJM	Manzari, H. J.	HU	SMS	Selkow, S. M.	CS
WJM	Martin, W. J.	MA	BZS	Servatius, B. I.	MA

Code	Advisor	Department	Code	Advisor	Department
TAS	Shannon, T. A.	HU	HFW	Walker, H. F.	MA
YBS	Shin, Y. B.	MG	MOW	Ward, M. O.	CS/BE
SYS	Shivkumar, S.	ME/BE	JEW	Watters, J. E.	HU
RKS	Shonath, R. D.	BE	PZW	Weathers, P. J.	BB
RDS	Sisson, R. D.	ME	EAW	Weaver, E. A.	SS
RLS	Smith, R. L.	HU	SW	Weekes, S. L.	MA
MMS	Sokal, M. M.	HU	DGW	Weeks, D. G.	HU
CYS	Sotak, C. H.	BE	SJW	Weininger, S. J.	CH
MS	Strong, D. M.	MG	NAW	Whitmal, N. A.	EE
JMS	Sullivan, J. M.	ME/BE	JDW	Wilbur, J. D.	MA
BS2	Sunar, B.	EE	KAW	Wilkins, K. A.	MG
			JMW	Wilkes, J. M.	SS
DZT	Tang, D.	MA	CEW	Wills, C. E.	CS
SST	Taylor, S. S.	MG	KNW	Wobbe, K. N.	CH
VRT	Thalladi, V. R.	CH	JPW	Woycheese, J. P.	FPE
RWT	Thompson, R. W.	CM	BEW	Wyslouzil, B. E.	CM
JOT	Trimbur, J. M.	HU			
GT	Tryggvason, G.	ME	RZ	Zalosh, R. G.	FP
JAT	Tyler, Jeffrey A.	BB	ZAZ	Zeng, Z. A.	MG
			JFZ	Zeugner, J. F.	HU
HGV	Vassallo, H. G.	MG	JZ	Zhu, J.	MG
RXV	Vaz, R. F.	EE			
DV	Vermes, D.	MA			
BMV	Vernescu, B. M.	MA			
SZG	Vernon-Gerstenfeld, S.	ISD			
SV	Vick, S.	HU			
OV	Volkoff, O.	MG			

UNIQUE OPPORTUNITIES AT WPI

SECTION

five

The Collaborative for Entrepreneurship & Innovation	234
Student Exchanges	234
3-2 Programs	236
Worcester Consortium Course Cross-Registration	236
Cooperative Education Program	236
Summer Study (Term E)	237
Societies, Registration and Licensing	238
Engineering Societies	238

THE COLLABORATIVE FOR ENTREPRENEURSHIP & INNOVATION

Today, it would be hard to find a high school student in the U.S. (and many other nations) who is not aware of the possibilities of starting and owning a business. Everyday, the newspaper, radio, television, and Worldwide Web are full of stories about people who have started their own businesses and become wildly successful. Considerably less attention is paid to the point that virtually every one of those successful businesses was founded through innovation, the act of commercializing an invention.

At WPI, we know that most inventions come from the engineers and scientists of the world. Of course, we want to attract students and faculty members who want to be inventors. But we want more for them, too. We want them to understand the innovation process so they can turn their inventions into businesses. That is why we developed the COLLABORATIVE FOR ENTREPRENEURSHIP & INNOVATION.

The Collaborative for Entrepreneurship and Innovation (CEI) at WPI is part of the Department of Management. It coordinates opportunities for undergraduate and graduate students within WPI, such as the WPI chapter of the international organization, Collegiate Entrepreneurs Organization (CEO), and is available for consultation on Intellectual Property issues and concerns that students and faculty members might have related to projects. The other major component of the CEI, the WPI VENTURE FORUM, coordinates the outreach opportunities for WPI students and faculty members, as well as those outside of WPI.

Everything we do in the CEI is driven by our mission and goals, which you will find below. That is because we are providing our students with an integrated experience that will help them become the very best entrepreneurs in the world.

OUR MISSION

The Collaborative for Entrepreneurship and Innovation inspires and nurtures people to discover, create, and commercialize new technological products and services, and to create new organizations based on those products and services, thereby advancing economic development and improving society.

OUR GOALS

We will:

- Attract students and faculty members to WPI who are interested in using inventions and technology to foster new businesses;
- Foster informed risk-taking among our undergraduate and graduate students and others wishing to pursue the dream of entrepreneurship;
- Build bridges between WPI students, staff, faculty, and alumni, and the wider entrepreneurial business community;
- Encourage corporations to develop an environment that celebrates entrepreneurship as a combined act of discovery, creativity, and innovation; and

- Achieve a leadership role among the preeminent entrepreneurship programs in the U.S.
- Currently the CEI offers a number of opportunities to WPI students. These include:
- A minor in Entrepreneurship through our parent organization, the Department of Management.
 - Courses in Entrepreneurship for those who do not wish to take a minor.
 - MQP and IQP opportunities in Entrepreneurship.
 - An Entrepreneur-in-Residence, a rotating position staffed by an entrepreneur who offers a course in entrepreneurship once a year.
 - An external advising team of entrepreneurs and investors who are available to mentor aspiring entrepreneurs among our students.
 - The New England Collegiate Entrepreneur Award, which students can apply for if they have their own business while still undergraduates. Even though it is a region-wide competition, it has thus far been won only by WPI students.
 - Networking opportunities through activities with our community outreach arm, the WPI Venture Forum.
 - A student organization, the Collegiate Entrepreneurs Organization (CEO) at WPI, part of a nationwide organization that supports and fosters entrepreneurial intentions among college students.

The CEI@WPI ALL-OUT Business Plan Challenge. All WPI students are eligible to compete for \$50,000 in prizes and the opportunity to advance to other competitions.

For more information on the Collaborative for Entrepreneurship and Innovation, please contact Gina Betti, Associate Director, CEI, 226 Washburn at 508-831-5075; gbetti@wpi.edu.

STUDENT EXCHANGES

As technology and commerce become increasingly international in outlook, students in engineering, science and management must learn about countries and cultures other than their own. To respond to this need, WPI offers its students an extensive range of opportunities to broaden their academic and cultural perspectives through study in a foreign country. Unlike many other exchanges, the WPI program is structured to allow students to work directly with foreign students, faculty, and professionals, and to live in residences with the students of the host institution. For WPI students on these exchanges, time is usually available for additional travel, before or after the formal academic period.

WPI presently offers undergraduate exchanges with universities in Canada, Germany, Mexico, Sweden and Switzerland as described in detail below.

These exchange programs typically involve third-year students, though qualified sophomores and seniors have been accepted. Students could go on these exchanges for a semester or a full year. Where perfecting a foreign language is part of the program, as in Switzerland, Germany, or Sweden, a full year abroad is more common.

The principal academic emphasis in all exchanges is upon course work. In such programs, students must work closely with their advisor, the academic advisor of the exchange program, and the program coordinator at the site to design an individual program of study. Students have the responsibility of obtaining prior tentative approval from their department that courses taken abroad will count towards departmental distribution requirements. For final transfer credit evaluation, students must provide upon return the necessary detailed information on the content of courses taken abroad and the satisfactory completion of all work. In some exchanges, opportunities exist to complete project work (IQP, MQP, and Sufficiency). The exchanges offer exceptional possibilities for projects comparing American and overseas applications of technology and the impact of technology on society.

For more information on these programs, consult with Natalie Mello in the Project Center or the academic advisor listed for each program.

LANGUAGE REQUIREMENTS

The usual language of instruction at most of the exchange institutions is the official language of the host country. While these institutions may offer a few courses taught in English, most lectures will be given in a foreign language. Thus, exchange students who intend to complete substantial course work must acquire the necessary language background. In some cases intensive language instruction can be arranged on site. In other cases, students acquire the language background through courses taught at WPI or other collages, or by self study. A few exceptions exist at some technical universities where the official language of instruction may be English. For information about language requirements, inquire with the academic advisor listed for each program or Pam O'Bryant in the Project Center.

ECOLE POLYTECHNIQUE; MONTREAL, QUEBEC, CANADA; EXCHANGE

Coordinator: Pam O'Bryant, Project Center
Academic Advisor: Prof. W. A. Bland Addison,
Salisbury Labs 02

The Ecole Polytechnique de Montreal provides WPI students with the opportunity to study in French without incurring the cost of transatlantic travel. École Polytechnique is located in the beautiful cosmopolitan city of Montréal, known for a rich variety of cultural activities and easy access to winter sports. This program offers a unique opportunity for an inside look at the cultural and political struggles for francophone identity within Québec today. Students reside among French speaking students in the residence halls of Ecole Polytechnique. Students can work on both projects and courses in Montreal, including French language courses at the University of Montreal and courses in English at McGill University.

FEDERAL TECHNICAL INSTITUTE; ZURICH, SWITZERLAND; EXCHANGE

Coordinator: Pam O'Bryant, Project Center
Academic Advisor: Prof. David Dollenmayer, Alden 209

WPI and the Federal Technical Institute (Eidgenoessische Technische Hochschule, ETH) in Zurich, Switzerland, have arranged an exchange for WPI students learning German. ETH is a technical university of international reputation offering degree programs in agriculture, architecture, astronomy, botany, chemical engineering, chemistry, civil engineering, computer science, crystallography, electrical engineering, forestry, geography, geology, mathematics, mechanical engineering, meteorology, microbiology, petrography and physics. ETH is located in Zurich, the largest city in Switzerland, and has a student population of approximately 6,000 undergraduates and 1,000 doctoral students.

MONTERREY INSTITUTE OF TECHNOLOGY; MONTERREY, MEXICO; EXCHANGE

Coordinator: Pam O'Bryant, Project Center
Academic Advisor: Angel Rivera, Salisbury Labs 15

WPI has established an exchange agreement with Monterrey Institute of Technology (The Instituto Tecnológico y de Estudios Superiores de Monterrey, ITESM). ITESM was founded in 1943 and is the foremost private technological and management university in Mexico, with programs available in Spanish at the main campus in Monterrey in northern Mexico. Some opportunities also exist for study at selected ITESM satellite campuses at 25 other locations in Mexico, by special arrangement in advance. WPI students have excellent opportunities to study engineering, science, and management in this leading Spanish-speaking university. In addition, ITESM offers special courses for North Americans wanting to learn how to do business in Latin America, and a full program of residential and academic study for English-speaking students seeking to increase their knowledge of Spanish language and culture.

ROYAL INSTITUTE OF TECHNOLOGY; STOCKHOLM, SWEDEN; EXCHANGE

Coordinator: Pam O'Bryant, Project Center
Academic Advisor: Holly Ault, Higgins Labs 207

WPI and the Kungliga Tekniska Hogskolan (Royal Institute of Technology, KTH) in Stockholm, Sweden, have arranged an exchange for WPI students learning Swedish. KTH is a four-year technical university which is divided into ten different schools of engineering which are relatively independent of each other and control their own admissions.

The academic year, approximately August 25 to May 31, is divided into eight periods of four weeks (three weeks of classes and one week of unscheduled activities). Most

courses last three to four periods; others may be shorter or longer. Final examinations for courses are normally given three to four times a year and can be taken repeatedly without having to repeat a course. There are some courses with regular examinations. Many students live in rooms and apartments in the city of Stockholm; some live in accommodations provided by the student union. Some scholarship aid is available, and students may fulfill their Sufficiency requirement through the exchange.

TECHNICAL COLLEGE; MUNICH, GERMANY; EXCHANGE

Coordinator: Pam O'Bryant, Project Center
Academic Advisor: Prof. David Dollenmayer, Alden 209

The "Technical College" is an institute for applied technology studies. Located in Munich, the FHSM has approximately 10,000 students. It offers degree programs in civil engineering, mechanical engineering, electrical engineering and computer science/engineering. For students who have developed adequate proficiency in German, the FHSM offers the possibility of completing a co-op assignment in Germany.

TECHNICAL UNIVERSITY; DARMSTADT, GERMANY; EXCHANGE

Coordinator: Pam O'Bryant, Project Center
Academic Advisor: Prof. David Dollenmayer, Alden 209

WPI established a student exchange program with the Technische Hochschule in Darmstadt (THD) in 1989. The THD, one of the oldest in Germany, is located in central Germany, close to the main financial and transportation center of Frankfurt. In addition to providing WPI students with the opportunity to perfect their German and to study in their major fields, THD provides support for IQPs through the faculty of its Zentrum fuer Interdisziplinare Technikforschung (Center for Interdisciplinary Study of Technology).

3-2 PROGRAMS

WPI has established cooperative arrangements with Anna Maria College, Assumption College, Atlantic Union College, Clark University, Emmanuel College, Regis College, St. Lawrence University, Wheaton College and Worcester State College which enable students enrolling at those colleges to establish a program which will provide both a degree from that college and one from WPI. Students in this program would spend three years at the cooperating college and the final two years at WPI.

WORCESTER CONSORTIUM COURSE CROSS-REGISTRATION

The Worcester Consortium for Higher Education consists of the following institutions: Anna Maria College, Assumption College, Atlantic Union College, Becker College, Clark University, College of the Holy Cross, Nichols College, Quinsigamond Community College, Massachusetts College of Pharmacy, Tufts School of Veterinary Medicine, University of Massachusetts Medical School, Worcester State College and WPI. Full-time WPI students who cross-register for courses at other Worcester Consortium colleges pay no extra fees. Students are limited to one course per semester. The no-charge plan does not include evening colleges or summer school. The Consortium provides buses which make frequent trips every day to all participating institutions.

Students interested in registering for Worcester Consortium courses should discuss their program with their advisors, and then obtain regulations and registration forms from the Director of Academic Advising or the Projects and Registrar's Office. Worcester Consortium college catalogs are available at the Gordon Library.

COOPERATIVE EDUCATION PROGRAM

THE CO-OP PROGRAM A Division of the Career Development Center

The WPI Cooperative Education Program provides an opportunity for students to alternate time in the classroom with extended periods of paid, full-time, career-related work experience in industry or private and government agencies. The program, which is optional at WPI, entails work assignments from six to eight months in duration which begin in either January or May.

Most students elect to participate in one co-op placement, though students may choose to work for more than one assignment. Participation in the Co-op program may delay the student's graduation date by 1/2 year (or longer if the student chooses to take more than one assignment). Preparation of a total college plan with the student's academic advisor is required to ensure a compatible scheduling of work periods and academic courses.

In order to qualify for the co-op program, students must meet the following requirements:

1. they must have completed two years of study but may not participate once they have started their senior year,
2. they must be in good academic standing (students cannot be on academic warning or probation),
3. they are only permitted to register for project credit during the co-op assignment with the approval of their academic and project advisors, co-op supervisor and co-op program coordinator, and
4. they must be full-time students.

Exceptions to any of these requirements are made by submitting a written petition to the Coordinator of Cooperative Education who consults with the WPI Registrar for a final decision.

ADVANTAGES TO STUDENTS AND EMPLOYERS

Co-op offers several advantages to students:

1. Participating in co-op helps students make career-related decisions.
2. Students can test classroom learning in the real world.
3. Co-op earnings enable students to pay a significant portion of their college expenses.
4. Students improve their after-graduation job prospects by gaining valuable work experience. In fact, more and more companies are using their co-op program to identify candidates for full-time permanent positions when the students graduate and/or seek candidates with co-op experience from other companies.

Employers also benefit in a number of ways:

1. Co-op students can handle assignments that may be difficult for untrained personnel, but that do not require the talents of full-time professionals.
2. The program gives employers the chance to judge the actual on-the-job performance of potential permanent employees.
3. Retention rates for permanent employees recruited through a co-op program are higher than for those hired through other routes.

THE PLACEMENT PROCESS

Students who are interested in participating in the co-op program must register with the Career Development Center (CDC) several months before the start date of the work assignment. Registration deadlines are announced at the mandatory Co-op Orientation meeting which is held at the beginning of A and C terms each year.

Once students complete the training in resume writing and interviewing skills that the CDC provides, the placement process begins. Employers seeking to fill a co-op position provide the CDC with a brief job description. Students decide which jobs they are interested in applying for and the CDC forwards their resume to the appropriate

companies. Some employers interview candidates on campus; others review resumes and then invite selected students for on-site interviews. The final hiring decision is left to the employer. The student is free to interview with more than one employer and to choose among the employment offers received. It often takes several months before the student is placed in a co-op assignment.

A co-op position is not guaranteed, but every effort is made to locate appropriate work assignments for qualified students. More than 300 employers have provided co-op opportunities to over 2000 students since the program began in 1976. The search for additional employers is an on-going activity.

OTHER CONSIDERATIONS

The employment experiences gained through the Cooperative Education Program do not substitute for, nor qualify as Major Qualifying Project (MQP) or Interactive Qualifying Project (IQP) requirements. These experiences, however, often generate ideas for qualifying projects with the cooperating companies.

For some students, the co-op orientation and registration period overlaps with an off campus activity, usually involvement with an IQP at one of our project centers. Students should not think that this prevents them from applying for co-op positions since our office has developed systems for dealing with their absence. Students who will be off campus during the orientation and registration period should contact the co-op program coordinator **before** their departure to complete the registration process in advance.

INFORMATION AND REGISTRATION

Students interested in exploring the possibility of participating in the program should contact:

Career Development Center
Coordinator, Cooperative Education Program
Project Center, Lower Level
(508) 831-5549

SUMMER STUDY (TERM E) MAY 29-JULY 18, 2003

During the summer, many courses central to planning major programs of study are offered at a time when all facilities are easily accessible. This is a great time to

- Make up a missing course
- Lighten the load for the next year
- Speed up your time to degree completion

This term also offers an exceptional opportunity to participate in certain types of project activity on a convenient basis since classrooms and laboratories will be less crowded and outside field work unlimited due to weather conditions. The use of the independent study has made it possible to present more individually-oriented course work during this term where class sizes are generally smaller. Many courses offered during Term E are included in the supplement to the catalog which is distributed to all students in March. A special summer

study website is available at www.wpi.edu/+Summer, in March. Students planning to participate in Term E should register at the regular spring registration period.

Term E also offers an excellent opportunity to complete a qualifying project or Sufficiency through a full-time effort during a single term. Students from other campuses are also invited to participate in the work of this term.

Admission to the summer session does not imply admission to regular academic year programs. Students desiring to continue their work at WPI following the summer session should seek admission following standard WPI admissions procedures issued through the Admissions Office.

For more information on the summer session, contact the Summer Session Office at (508) 831-6112.

ENGINEERING SOCIETIES

All engineers are professionals in accordance with the definition of engineering, one of which states that “engineering is the profession in which a knowledge of the mathematical and natural sciences gained by study, experience and practice is applied with judgment to develop ways to utilize, economically, the materials and forces of nature for the benefit of mankind.” Professional engineers also observe a code of ethics, exercise judgment and discretion while providing their services, and are involved in a confidential relationship with their clients. Professional engineers enjoy legal status, use professional titles, and associate together through professional societies.

An excellent way to begin learning about the status of the professional engineer is to join the student branch of a professional society relevant to your interests. At WPI, students are encouraged to join the student branches of such societies as the American Society for Metals (ASM), American Society of Mechanical Engineers (ASME), the Institute of Electrical and Electronic Engineers (IEEE), the American Society of Civil Engineers (ASCE), the American Institute of Chemical Engineers (AIChE), the American Institute of Aeronautics and Astronautics (AIAA), the Association of Computing Machinery (ACM), the American Nuclear Society (ANS), the Society of Automotive Engineers (SAE), the Society of Manufacturing Engineers (SME), the Society of Fire Protection Engineers (SFPE), the Society of Women Engineers (SWE), and the American Chemical Society, (ACS). For information on these organizations, see the appropriate department head.

Undergraduate students should begin the process of becoming professionally registered and licensed by following the steps detailed in the next section.

ENGINEERING REGISTRATION AND LICENSING

In order to become a “Professional Engineer” (P.E.) and enjoy the legal status which affords certain rights, privileges and responsibilities, engineers must qualify through the formal procedures of registration and licensing. Procedures vary from state to state, but in most cases, the applicant must pass a Fundamentals of Engineering Examination.

FUNDAMENTALS OF ENGINEERING EXAMINATION

To become legally registered as a professional engineer (P.E.), candidates must submit data regarding formal education and technical ability to the appropriate state Board of Registration for Professional Engineers. Two major examinations, The Fundamentals of Engineering Examination (also called Engineering-in-Training, E.I.T.) and the Professional Practice Examination (P.P.E.), must be successfully completed as a measure of technical abil-

ity. The Fundamentals Examination must be taken first; the Professional Practice Examination must then be taken after a designated period of substantial professional experience, usually a minimum of four years. File applications for E.I.T. by January 1. The E.I.T. Examination will be given in mid-April and late-October. File applications for Professional Practice Examinations (P.P.E.) six months in advance.

There are several possible qualification paths to registration as a P.E. The quickest and most common route is to obtain a degree from an ABET (Accreditation Board for Engineering and Technology—formerly ECPD) accredited curriculum, and to acquire the specified amount of suitable professional level experience in addition to passing the two examinations mentioned above. There are six ABET accredited curricula at WPI—civil engineering, chemical engineering, electrical engineering, manufacturing engineering, industrial engineering, and mechanical engineering. Persons with an unaccredited degree can still become registered in most, but not all, states by submitting evidence of a longer “apprenticeship” period (variable by states) before taking the two examinations. Students should strive, if at all possible, to pursue a program which is accredited by ABET and should work closely with their advisors and appropriate major departments to assure that the total program qualifies for accreditation, since this will greatly facilitate the achievement of registration in the future.

ALL SENIOR ENGINEERING MAJORS IN CE, CM, EE, ME AND MFE ARE URGED TO TAKE THE FUNDAMENTALS OF ENGINEERING EXAMINATION WHICH IS GIVEN ON CAMPUS EACH FALL AND SPRING. There will never be a better time!

Refresher courses for students, alumni and practicing engineers are available. Successful completion of this examination is normally the first step in eventually obtaining the right to use the initials “P.E.”

WPI’s Office of Continuing Education sponsors an eleven session EIT Refresher course from mid-January through mid-April on the WPI Campus. The course, which is taught by WPI faculty, includes reviews of the major topics covered on the exam. For further information, call 508-831-5517.

DESCRIPTION OF FUNDAMENTALS OF ENGINEERING EXAMINATION (F.E.E.)

Typical Date Given: Last Saturday in October (also in April).

Typical Application Deadline: First week in September (also in January).

Duration: Eight hours.

Type: Multiple choice, open book.

Sample Questions: A set of typical questions asked on the Fundamentals of Engineering Examination may be obtained by applicants from the reserve section of Gordon Library.

CAREER DEVELOPMENT AND GRADUATE SCHOOL

S E C T I O N

SIX

Career Development	240
Graduate Studies	240
WPI Graduate Program	241

The Career Development Center (CDC) at WPI is here to assist students in the development of life-long skills related to careers and the job search process. CDC serves not only undergraduate students but graduate students and alumni as well. Information and guidance is provided in the areas of full-time employment, graduate school, part-time employment, Cooperative Education and summer positions.

The Career Development Center (CDC) provides a variety of services to students including the following:

1. **ON-CAMPUS RECRUITMENT**—The CDC office coordinates a busy schedule of interviews by recruiters from over 200 private, government, civic, and professional companies and organization. To give you an idea, here are just a few organizations which have employed WPI graduates in recent years:

Andersen Consulting	Kiewit Construction
Clairol	Lockheed Martin
Compaq Computer	Microsoft
Data General Corporation	Quantum
Eastman Kodak	Polaroid Corporation
Exxon	Teradyne
General Dynamics/Electric Boat	Raytheon
General Electric Company	Saint Gobain (formerly Norton)
GTE	Turner Construction Company
General Motors	U.S. Govt./Naval Underwater Systems Center
IBM	Xerox

2. **JOB OPPORTUNITIES**—The CDC office posts full-time co-op, part-time, and summer opportunities. In fact, current students and alumni can be updated on professional full-time job openings through the office's WEB JOB LISTING SYSTEM. This service is available 24 hours a day, 7 days a week.
3. **CAREER LIBRARY**—CDC maintains a large library of literature and information about the various companies that recruit on campus so that students will be well prepared for their interviews and have a reasonably good idea whether they would be interested in a particular company. CDC also provides vocational resources for student researching and exploring various careers. For those students considering graduate school, the office provides information on graduate education at WPI and elsewhere. The office also houses standard examinations required by many graduate schools such as Graduate Record Exam (GRE), Graduate Management Admissions Tests (GMAT), Medical College Admission Test (MCAT) and Law School Admission Test (LSAT).
4. **CAREER WORKSHOPS**—Throughout the year a variety of workshops are offered to students. Topics have included: Resume/Cover Letters, Job Search Strategies, Summer Job Search, Alternatives to On-Campus Recruitment, Plant Interviews, Job Offer Decision Making, and Graduate School.

5. **INDIVIDUAL CAREER COUNSELING**—Students can arrange to meet a Career Counselor by appointment or on a drop-in basis. Help is provided in many areas including resumes, devising a job search plan, interviewing, graduate school, and evaluating and making career choices.
6. **COMPANY PRESENTATIONS**—Information sessions are provided by recruiters so that students have an opportunity to evaluate and learn more about the companies interviewing on campus.
7. **MAJOR SELECTION PROGRAM**—This program offers a variety of services to students trying to choose the major that's best for them.
8. **CAREER FAIRS**—Each year CDC organizes job fairs for students to obtain information on full-time, part-time, summer, and co-op opportunities.
9. **COMPUTERIZED RESUME DATABASE**—All students that register with the CDC office for on campus interviews or off campus referral will submit their resume via the web to the office. Employers access the resumes through the various Web Resume Books which the CDC maintains.

Even after students graduate from WPI, the CDC office provides assistance to alums seeking new employment or facing a change in career goals.

Location: The Career Development Center is located in the Lower Level of the Project Center. The phone number is (508) 831-5260.

GRADUATE STUDIES

Many students enroll in graduate school on a full- or part-time basis, realizing that a graduate degree can open the door to certain kinds of job opportunities (such as advanced research or development, college teaching, law or medicine). Graduate study is another step in the self-learning process begun at WPI, a process that will last a lifetime.

Most graduate schools require applicants to take a standard examination such as the Graduate Record Examination (GRE) or Graduate Management Admission (GMAT). Information on such examinations is available from the Graduate Admissions Office or CDC.

The Graduate Admissions Office and CDC can provide information on graduate education at WPI or elsewhere.

INTRODUCTION

For students who wish to continue their education after receiving the bachelor's degree in the same or a related field, the WPI graduate program offers the opportunity either to specialize or to broaden one's preparation. The M.S. degree generally means advanced formal education in a fundamental area and professional experience through thesis or project work in a current field. Several graduate departments offer the Master of Engineering, a non-thesis option to the M.S. degree. The M.B.A. degree provides preparation for careers in the management of technological enterprises. In addition to master's programs, graduate-level certificates are offered by select departments.

Graduate study represents a natural extension of education beyond the WPI undergraduate Plan. With proper planning, WPI students may shorten the time required to earn the master's degree as described in the "Combined Bachelor's/Master's Program" section, page 242.

The Ph.D. represents recognized original and independent professional work in the form of research for a dissertation and peer-recognized competence in the technical aspects of the profession.

In all cases, students have been introduced to the role of working with established professional people and have had their performance evaluated at the professional level.

ADMISSION

Admission decisions to the Graduate Program of any department is made by the faculty of that department. Students generally may enroll in a maximum of two to four graduate courses without formal admission to a degree program. Because numerous exceptions to this rule do exist, students are asked to check with their specific program head and the graduate catalog for exceptions to this rule.

Prospective students who desire an advanced degree should write to the Graduate Admissions Office specifying the department in which they intend to do their major work. In general, a complete application, transcripts of all college work, and three letters of recommendation are needed for admission to a graduate program. The Graduate Record Examination (GRE) is required in some programs and, for others, is highly recommended; for all Management programs, the GMAT is required. The required \$60 application fee is waived for WPI alumni and current undergraduate students.

REGISTRATION AND TUITION PAYMENT

Registration for graduate courses opens several months in advance of the start of each semester. Students are encouraged to register early in the cycle.

Tuition for courses taken by graduate students is \$796 per credit hour for the year 2002-2003. (Undergraduate courses listed as "one-third unit" are equivalent to three credit hours.)

Tuition and fees (including health insurance) must be paid before the start of classes.

FINANCIAL AID

GRADUATE ASSISTANTSHIPS

Assistantships are of two types—teaching and research. Generally, teaching assistants are assigned duties supporting faculty in the grading of papers and the supervision of laboratory sections. Research assistants usually are involved in sponsored-research projects that become a part of their theses or dissertations.

The basic stipend for all assistants is between \$11,700-\$18,000 for the 2002-2003 academic year. In some cases this may be supplemented by a summer stipend or by special funds for the academic year.

The normal assistantships also provide tuition for up to 10 credits for each of two semesters.

FELLOWSHIPS

Several fellowships are available for students in particular departments and through endowed funds.

The Backlin Fund, administered by the Associate Provost for Academic Affairs provides assistance for students nearing completion of their degree requirements who are recommended by a faculty member and their department chairman.

Competition for the prestigious Goddard Research Fellowship is open to U. S. citizens. Preference is given to doctoral candidates.

APPLICATION DEADLINES

Although applications for financial aid are considered at any time, the major distribution of aid is based upon complete applications submitted by February 1 for the fall semester.

SCHOLARSHIPS AND GRANTS FOR GRADUATE STUDY ABROAD

RHODES SCHOLARSHIPS

Rhodes Scholarships, covering tuition, fees and a stipend for two years of study in selected fields of science and engineering at Oxford University, are assigned through state and regional competitions. Students interested in applying for the Rhodes Scholarships should begin to assemble documentation during the junior year. Applicants should have achieved academic standing sufficiently advanced to assure completion of a bachelor's degree before their projected matriculation at Oxford.

For information, see Prof. Peter Hansen, 39 Dean St., Room 254.

FULBRIGHT GRANTS

A wide variety of grants for graduate study abroad, usually for research toward the doctorate, is available through the federally-funded Fulbright Grants Program. Contact the Graduate Admissions Office for more information.

DEGREES AND REQUIREMENTS

WPI offers master's degrees in applied math, applied statistics, biology and biotechnology, biomedical sciences, chemistry and biochemistry, computer and communications networks, computer science, management, mathematics for educators, and physics, biomedical/clinical, chemical, civil and environmental, electrical and computer, fire protection, manufacturing, materials science, and mechanical engineering.

The doctorate is offered in biotechnology, computer science, chemistry, physics, materials science and engineering, mathematical sciences, and in biomedical/clinical, chemical, civil and environmental, electrical and computer, manufacturing, mechanical engineering, and fire protection. There is also a research Ph.D. in biomedical science offered through a consortium.

Further information and specific requirements for these advanced degrees may be found in the *Graduate Catalog*. Several departments have special brochures describing their programs.

PART-TIME GRADUATE PROGRAM

The part-time graduate programs provides the opportunity to engage in part-time study leading to the master's degree. The evening program is operated by WPI to serve the educational needs of technical and management professionals in central New England.

Master of science degree capability for part-time students is offered in applied math, applied statistics, chemistry and biochemistry, computer and communications networks, computer science, operations and information technology, marketing and technological innovation, manufacturing management, and physics, biomedical/clinical, civil and environmental, electrical and computer, fire protection, manufacturing, materials science, and mechanical engineering. The master of engineering for part-time students is offered in biomedical/clinical, civil and environmental engineering. The master of business administration (M.B.A.) is also offered.

Although the number of courses in each discipline may be limited in any given year, the schedule of courses is such that students taking two courses per semester are able to complete the course requirements for the master of science or master of engineering degree in about three years or the M.B.A. in four years.

Students may enroll in individual evening graduate courses without being admitted to a graduate degree program. Those who wish to obtain a degree must apply for formal admission prior to completing two to four courses. Exceptions to the rule exist, therefore, interested students should verify the actual number of courses allowed prior to matriculation with the specific program department. Graduate-level certificate programs are also available in some departments (see Graduate Catalog for details).

A more detailed description of the program and specific course offerings is available in the Graduate Catalog. Questions relating to the program should be referred to the discipline department heads or to the Graduate Admissions Office.

COMBINED BACHELOR'S/ MASTER'S PROGRAM

The Combined Bachelor's/Master's Program is a unitary program leading a student to a bachelor of science degree and to a master of business administration, master of engineering, or master of science degree. The purpose of the Combined Bachelor's/ Master's Program is to give WPI undergraduates an opportunity to earn a bachelor's and a master's degree from WPI concurrently in less time than would be required if the student were to complete work on the bachelor's degree before beginning work on the master's degree. To gain the full benefit of this program, a student should apply for the Combined Program well before the bachelor's degree is completed. Application at the beginning of the junior year is recommended.

For the master of science and master of engineering degrees, the Combined Program typically allows a student to complete requirements for both degrees in about one more year of full-time study than would be required to earn the bachelor's degree. With careful planning, a student can obtain a similar reduction in the amount of time required to earn an M.B.A.

PROGRAM REQUIREMENTS

Only registered WPI undergraduates may enter the Combined Program. To enter, a student must apply to the WPI Graduate Program. Admission to the Combined Program is made by the faculty of the program that awards the graduate degree. A student in the Combined Program continues to be registered as an undergraduate until the bachelor's degree is awarded.

While in the Combined Program, a student may continue to take courses or projects toward the undergraduate degree; the student may also register for graduate courses, projects, directed research or thesis credits toward the master's degree.

To obtain a master's degree via the Combined Program, the student must satisfy all requirements for that master's degree, including any requirements of the graduate degree-awarding program for satisfactory completion of specified courses or a master's thesis. To obtain a bachelor's degree via the Combined Program, the student must satisfy all the requirements for that bachelor's degree, including distribution and project requirements.

A student in the Combined Program, may, within the program limit and with prior approval, use the same courses toward the bachelor's and master's degrees. The limitation is computed from the graduate credit hours for each course. Courses, whose credit hours total no more than 40% of the credit hours required for the master's degree, and which meet all other requirements for each degree, may be used to satisfy requirements for both degrees. Such courses are recorded on the transcript using the credit hours/units and grades appropriate at the graduate or undergraduate levels. For students in the Combined Program, approved undergraduate courses are assigned graduate credit with a conversion rate of 1/3 WPI undergraduate unit = 3 credit hours, while graduate

courses applied toward the undergraduate degree are awarded undergraduate credit with a conversion rate of 1 credit hour = 1/9 undergraduate unit.

Students in the Combined Program may use advanced undergraduate courses to satisfy graduate degree requirements. The department decides which courses may be used in this way. Faculty members teaching these advanced undergraduate courses may impose special requirements, appropriate to an undergraduate course being used for graduate credit, on Combined Program Students.

In many cases, including if the programs awarding the bachelor's and master's degrees are not the same, the program awarding the graduate degree may require that the student's Major Qualifying Project relate in some way to the graduate program's discipline. The graduate program may also make other requirements as it deems appropriate in any individual case. These requirements take the form of a written agreement (obtain Course Selection Form from the Graduate Admissions Office or at www.wpi.edu/+GAO) between the student and the graduate program, which must be completed and filed with the registrar before the student may be matriculated in the Combined Program.

The Combined Program is a full-time program of study. Once admitted to the Combined Program, a student must register every fall and spring semester until the graduate degree is completed. A student in the Combined Program who, during the fall or spring semester, has no registered activities is automatically terminated from the Combined Program, and may only be readmitted to the Combined Program by the Committee for Graduate Studies and Research via petition showing extenuating circumstances. Termination from the Combined Program does not affect a student's ability to continue toward the bachelor's degree.

Some graduate-degree-awarding programs impose additional restrictions on students in the Combined Program. Consult the degree requirements of individual programs for details.

Questions relating to the program should be referred to the discipline department heads or to the Graduate Admissions office.

OFF-CAMPUS GRADUATE STUDY

In response to the changing needs of technical professional people, WPI offers a growing number of graduate courses at the Southborough and Waltham campus. Off-campus graduate courses can be used in fulfilling degree requirements and residence requirements at WPI.

GRADUATE COURSE LISTINGS

Graduate courses of interest to undergraduate students are listed by title in the "Course Descriptions" section of this catalog. A complete list may be obtained from the Graduate Admissions Office. Most courses meet one or two times per week in a fourteen-week format. The credits applied in either case are as shown to the right of the course title. Undergraduate students taking graduate courses may use the conversion factor: 3 credit hours = 1/3 unit. Registration for research or projects is accomplished using an individual program number rather than a course designation.

For more information about WPI's Graduate Programs, please contact:

Graduate Admissions Office

Voice: 508-831-5301

Fax: 508-831-5717

gao@wpi.edu

www.wpi.edu/+GAO

The complete Graduate Catalog and application form are available on-line through our website.

ADMISSION, EXPENSES, FINANCIAL AID AND HOUSING

S E C T I O N

seven

Admission To WPI.....	245
Expenses	248
Financial Aid	249
Housing.....	254

INTRODUCTION

Selection for admission to the college is based upon such factors as candidates' secondary school record; recommendations by counselors and teachers; standardized test scores; out-of-class activities; and work experience. All candidates are invited to submit any supplementary material which they believe will aid the Admissions Committee in evaluating their application.

VISITING THE CAMPUS

Through research and reading, you can learn a lot about a college. But the best way to determine if WPI is a good match for you is by visiting the campus. Group Information Sessions and Open Houses are the very best ways to get to know WPI.

The Group Sessions, for which no appointment is needed, are held Monday-Friday at 10:00 a.m., and 2:00 p.m. in the Admissions Office and are followed by a tour of the campus. Group Sessions are also available on selected Saturdays. Please call the Admissions Office for specific dates and times. WPI also sponsors several Open Houses throughout the fall and spring. Campus tours, presentations by academic departments, and sessions on such topics as placement, financial aid and admissions are highlights. All students on our mailing list will receive an invitation to our Open Houses and must register in advance to attend.

Student-led tours of the campus are offered Monday through Friday every hour from 9:00 a.m.-4:00 p.m. (although tours run on a limited schedule during WPI's term breaks and in the summer). Lunch with a WPI student is also available from 12:00-1:00 p.m., Monday through Friday, while classes are in session. In addition, we will try to accommodate any requests to sit in on classes, meet privately with a faculty member or stay overnight with a current student. A personal interview is one of the best ways to learn more about WPI. It also gives us the opportunity to learn more about you. Interviews are available on campus and by appointment only. We schedule interviews between April 1 and December 15. If you would like to schedule a time to meet with one of our Admissions Office members, please contact the office directly. Whatever option you choose, you can arrange for a campus visit by calling the Admissions Office at (508) 831-5286, and our receptionist will be happy to assist you.

QUALIFICATIONS

In order to qualify for admission, candidates must have completed a full secondary school course of study including the following secondary school units:

ENGLISH	4	
MATHEMATICS	4	(including elements of trigonometry and analytic geometry)
LAB SCIENCES	2	(usually physics and chemistry)

Completion of the required mathematics and science courses in less than four years of study may qualify a student for early admission.

APPLYING TO WPI

Although the vast majority of entering freshmen matriculate in September, WPI will admit freshmen in January. Candidates for the September term should file their application by February 1. Freshman candidates for admission to the January term should file their applications by November 15.

In our efforts to make applying to WPI as easy as possible, we offer a variety of application options. You can use the traditional paper application form or you can apply on-line via WPI's WWW home page (<http://www.wpi.edu>). The \$60 application fee is waived for on-line applicants. We also accept the Common Application and applications submitted through College View, CollegeLink and ExPAN. For more information on these options, please call the Office of Admissions at (508) 831-5286.

STANDARDIZED TESTS

All candidates are required to take either the College Board tests or the American College Testing Service (ACT) test. If the College Board tests are selected, candidates should take both the Scholastic Aptitude Test I (SAT I) and three SAT II Subject Tests: Writing, mathematics, IC or IIC and a science of their choice. These tests should be taken by a date early enough to insure that the scores reach the Office of Admissions by mid-February of your senior year. Candidates should arrange to have their scores submitted directly to the college by either the College Board or ACT. The WPI code number is 3969 for the College Board tests and 1942 for the ACT test.

FINANCIAL AID

Students applying for financial aid should check the appropriate box on the application for admission. Financial aid candidates should submit the registration form for the College Scholarship Service Financial Aid PROFILE and the Free Application for Federal Student Aid (FAFSA), which are available in the guidance offices of secondary schools. For regular admission applicants, these forms should reach the WPI Financial Aid Office by March 1. Students applying early decision, should submit the completed Profile to the College Scholarship Service by November 15. All financial aid candidates are required to send directly to the college signed copies of their own and their parents' Federal Income Tax Returns and W-2 Forms. Financial Aid is available for U.S. citizens and/or permanent residents of the U.S. A limited amount of need-based financial aid is available for International Students and they should file the Foreign Student Financial Aid Application, which may be obtained in the WPI Admissions Office.

APPLICATION FEE

Candidates using the paper application must submit a \$60 non-refundable application fee. Those applying on-line need not supply this fee. WPI endorses the fee waiver policy of the College Entrance Examination Board.

NOTIFICATION

All candidates for admission will receive an acknowledgment of the receipt of their application. Should applicants fail to receive this acknowledgment within four weeks, they are encouraged to check with their high school guidance office or the Office of Admissions at WPI. Admissions decisions will be mailed to all applicants no later than April 1.

DECISION TO MATRICULATE

Accepted candidates must inform the college by May 1, the candidates' common reply date, of their decision to matriculate by returning a \$500 non-refundable tuition deposit along with the Acceptance of Admission Form.

EARLY DECISION

For those students whose first choice college is WPI, there is an early decision plan. The plan is as follows:

1. Candidates should check the Early Decision box on the application.
2. The completed application for admission must be submitted by November 15, with earlier submission encouraged.
3. Candidates recognize that applications to other colleges must be withdrawn if their application is acted favorably upon by WPI. Early Decision is a binding Admissions plan.
4. The Admissions Committee will review all early decision applications and notify all candidates of their decisions by December 15. Accepted students will be required to submit a \$500 non-refundable tuition deposit by January 15 within two weeks of notification of financial aid (if applicable).
5. If the Committee is unable to accept a student under the early decision plan, the applicant will be so informed, and his or her application will usually be considered at a later date along with all regular applications.

EARLY ACTION

Students may apply to WPI early and receive early notification of their admissions decision under the Early Action plan. The plan is as follows:

1. Candidates should check the early action box on the application.
2. The completed application for admission must be submitted by November 15, with earlier submission encouraged.
3. The Admissions Committee will review all early action applications and notify all candidates of their decisions by December 15. Early action is a non-binding admissions plan, so accepted students have until May 1 to submit a \$500 non-refundable tuition deposit.
4. Admitted early action candidates who are applying for financial aid will receive notification regarding eligibility for aid soon after their financial aid forms are submitted and complete.

ADVANCED PLACEMENT

WPI awards credit to students who take the Advanced Placement Examinations and score a "4" or "5." The Director of Academic Advising will notify such students in August of the earned credit.

For students who do take the examination in one or more of the WPI *humanities* areas and score a "4" or "5," the college will award advanced placement credit for one course per examination towards the humanities requirement. Soon after arriving on campus, students receiving such credit must speak with an appropriate Humanities and Arts department advisor about how this credit may be integrated into a thematic program of studies leading to fulfillment of the WPI humanities and arts requirement (see Sufficiency, page 54.)

Advanced placement in *computer science* can be earned.

Credit for CS 1005 is granted for a score of "4" or "5" on the *A* computer science exam; credit for an additional elective course is granted for a score of "4" or "5" on the *AB* exam.

Students who pass the advanced placement test in *biology, chemistry, or physics* with a "4" or "5" will be awarded 1/3 unit of advanced placement credit. Since no course is specifically required at WPI, the credit replaces no specific course but will be recorded on the transcript as credit without an assigned grade and may count as credit toward the applicable distribution requirement.

Students who pass the *AB mathematics* examination with a "4" or "5" will be awarded 2/3 unit of advanced placement credit for MA 1021 and MA 1022. Students with a "4" or "5" on the advanced placement *BC* exam will be awarded one unit advanced placement credit for MA 1021, MA 1022 and MA 1023.

In the four-course 1021-1024 *mathematics* sequence, students who arrive at WPI with a one-year high school calculus course, prepared to start with the second (or third) course in the WPI sequence and who successfully pass that course and the one that follows it in the sequence, will be considered to have established advanced placement credit for the first one (or two courses). To qualify for the credit, the advanced WPI courses must be passed the first time they are available in sequence to the student after matriculation. The courses credited retroactively will be listed by number without an assigned grade and will count toward the distribution requirement in mathematics.

NEW STUDENT ORIENTATION

During the week prior to classes, the Student Activities Office coordinates a comprehensive new student orientation program for all first-year and transfer students. New student orientation provides an introduction to the WPI experience, ranging from academic work and expectations and project-based education, to student life and campus activities. Led by upperclass student team leaders and faculty consultants, new students to WPI attend team meetings that are designed to familiarize them with the overall campus environment.

READMISSION

Students who were formerly at WPI but left before completing undergraduate study, and now wish to apply for readmission, should contact the Projects and Registrar's Office for information and forms. Completed readmission forms must be received by WPI no later than the following due dates in order to be acted upon for entrance in the indicated term:

July 15 for Term A November 15 for Term C

If possible, candidates should also plan on an interview with the Director of Academic Advising and with a departmental consultant in their intended major area of study prior to filing the readmission form.

TRANSFER STUDENTS

The WPI Plan provides some advantages that are particularly attractive for transfer students. Transfer applicants should furnish an autobiographical statement and Math/Science teacher recommendations in addition to the application for admission. The deadline for receipt of applications for entrance in September is April 15. The deadline for admission for January entrance is November 15. Applicants are encouraged to submit their applications as early as possible.

All transfer students are required to spend at least two years as full-time registered students. For more details on transfer admission, see WPI's web site under Admissions.

TRANSFER AGREEMENT

WPI has formal transfer agreements whereby students at the following colleges are guaranteed admissions provided they meet the terms of the program of instruction: Berkshire Community College, Bristol C. C., Dean Junior College, Franklin Institute, Greenfield C. C., North Shore C. C., Quinsigamond C. C., C. C. of Rhode Island, Springfield Technical C. C.

HUMANITIES AND ARTS REQUIREMENT FOR TRANSFER AND 3-2 STUDENTS

All transfer and 3-2 students should review their humanities and arts record and plan with the Humanities and Arts Department's coordinator for transfer students (J. Hanlan - SL23), who will determine for students the transfer credit applicable towards the Sufficiency.

All transfer and 3-2 students entering WPI with fewer than two units of humanities and arts credit must complete thematically related work in humanities and arts at WPI, including a Sufficiency evaluation (Independent Study/Project) to the extent that the overall humanities and arts credit totals two units. The humanities and arts requirement is considered fulfilled for transfer students who have completed the equivalent of two units of humanities and arts work prior to their matriculation at WPI or 3-2 students who have or will complete the equivalent as part of their degree program at the cooperating college. Please refer to the section "Transfer Students and the Sufficiency Requirement" for a description of how Sufficiency grading is determined for transfer students who believe they have completed requirements.

A Completion of Degree Requirement form must be submitted in order for the Sufficiency to be recorded. The student must be registered for at least 1/6 of a unit in the

same activity in the term in which the Completion of Degree Requirement form is submitted, or the student will be required to pay the usual recording fee. (This registration is in addition to any transfer credit awarded. As the Completion of Degree Requirement form is usually submitted during a term in which the student is full time, normally no extra charges are incurred.)

The following exception to this policy exists: Transfer and 3-2 students who receive a grade for the Sufficiency based on work completed at another school and who submit the Sufficiency Completion of Degree Requirement form as part of the transfer-credit posting process will have the Sufficiency Completion of Degree Requirement form and grade recorded without a fee. This process will normally take place prior to or during the first term of full-time enrollment at WPI.

INTERNATIONAL STUDENTS

The presence of international students serves as a means of strengthening the knowledge and understanding of foreign countries and cultures and is highly encouraged and supported at WPI. Programs and support services for international students and exchange programs are given high priority. As an institution of higher learning, WPI is dedicated to international education.

In addition to the standardized tests listed above, international applicants must provide proof of English language proficiency. English language proficiency may be demonstrated by the official results of:

TOEFL (Test of English as a Second Language)–
Minimum score: 550 (213 electronic form)

ELPT (English Language Proficiency Test)–Minimum
score: 965

MELAB (Michigan English Laboratory Assessment
Battery)–Minimum score: 81

International students whose score results are less than those above may still be conditionally admitted, with required attendance at WPI's English as a Second Language Program during the summer prior to enrollment.

THE ENGLISH AS A SECOND LANGUAGE (ESL) PROGRAM

The **ESL Summer Institute** is an intensive five-week non-credit course of study in English for specific purposes for conditionally-admitted international students and others whose first language is not English. This ESL program is designed to help prepare these international students for regular courses in engineering, science and technology before the regular academic year begins. A second intake is available for international students who desire only a head-start in preparation for such courses before the academic year begins.

For students who need additional support during the regular academic year, the **ESL Seminar**, a tutorial course designed to help the student further strengthen linguistic skills is offered.

During the regular academic year, *ESL for Spouses* is a non-credit course offered to interested partners accompanying WPI students and professors.

A TOEFL Preparation course is also offered during Terms C and D.

ESTIMATED EXPENSES

The expenses for a year at WPI will vary with each student. Expenses for the 2002-03 year are as follows:

Tuition	\$26,200
Social Fee	160
Total Tuition and Fees	\$26,360
Room (Typical Freshman Double)	4,890
Board (7-Day, 19-Meal Plan)	3,836
Books and Supplies (Estimated)	670
New Student Fee	195
	\$35,951

Health insurance is required for all students. If coverage is not through a parental plan, student health insurance is available at a projected cost of \$530 for the 2002-03 academic year. The health insurance plan is *mandatory* for international students.

Basic tuition entitles full-time students to full academic and student services including counseling, placement and recreational facilities. Other costs must be anticipated, such as laundry, clothing, travel expenses, entertainment and personal expenses. Therefore, with the exception of travel to and from home, we estimate that each student will spend an additional \$1,070 per year at WPI.

PAYMENT OF TUITION DEPOSIT

ENTERING STUDENTS

Payment of a nonrefundable \$500 deposit is required upon acceptance of admission to WPI. The \$500 will be credited as follows: \$250 to the student's tuition in the first term and \$250 toward the bill for housing. If housing is not needed, then the full \$500 is credited to the tuition bill for the first term.

Information about deferred tuition payment plans offered by commercial firms is available from the WPI Accounting Office.

ENROLLMENT AND TUITION DUE DATES

Enrollment for students pursuing a baccalaureate degree will occur three times per year:

1. Fall semester—at the beginning of Term A.
2. Spring semester—at the beginning of Term C.
3. Summer session—at the beginning of Term E.

There will be no enrollment at the start of Terms B and D, although a course change period will be available for students continuing from the previous term.

Special tuition features relative to Term E enrollment will be described in the Summer Session catalog.

Dates upon which semester tuition fees are due are listed in the WPI Chronology of Academic Schedule and Events on the inside front cover of this catalog.

OVERLOAD CHARGES

1. There will be a tuition surcharge on registration which contains academic overloads in excess of 2 1/6 unit per semester.
2. Neither physical education or military science will be included in the determination of overloads.
3. The overload charge will be based upon the total registration credit held by the student at the close of the initial change period each of the two terms of that semester. Students will be subject to the appropriate overload charge in effect at the time. (Please consult the Projects and Registrar's Office or the Accounting Office for current fees.)
4. Fall overload billing will take place during Term B and spring overload billing during Term D.
5. The current Term E charge system will not be affected.

FULL-TIME STUDENTS TUITION CHARGES UPON WITHDRAWAL OR SUSPENSION

Charges upon formal withdrawal from the college during each semester are:

	Charge
1. Withdrawal after enrollment but prior to first day of classes of the first term of a semester.	\$100.00
2. Withdrawal within one week following first day of classes of the above term.	20% of tuition
3. Withdrawal within two weeks following first day of classes of the above term.	40% of tuition
4. Withdrawal within three weeks following first day of classes of the above term.	60% of tuition
5. Withdrawal prior to Course Change Day of the second term of a semester.	80% of tuition
6. Withdrawal on or after Course Change Day of the second term of a semester.	100% of tuition

To qualify for refunds, students must submit a formal withdrawal application via the Projects and Registrar's Office. The date this application is received in the Office of Academic Advising will determine the charge.

There is no refund in the case of withdrawal from individual courses.

Students who have paid full tuition for eight semesters may be allowed to enroll as special (part-time) students on a per-course basis and be charged tuition accordingly. (Two summer terms enrolled as a full-time student may be counted as a semester.) Application forms for Special Student status are available at the Projects and Registrar's Office.

A late fee ranging from \$25 to \$50 is assessed for payment of bills and registration after the specified dates.

SPECIAL (SU, SX) STUDENTS TUITION CHARGES UPON WITHDRAWAL

During the regular academic year (Terms A, B, C and D), withdrawal refunds for special students in seven-week courses will be as follows:

	Charge
1. Withdrawal before the third scheduled class.	\$25.00
2. Withdrawal after the third class but during the first week of class.	25% of tuition
3. Withdrawal during the second week of class.	50% of tuition
4. Withdrawal during the third week of class.	75% of tuition
5. Withdrawal after the third week of class.	100% of tuition

Withdrawal of SU and SX students from 14-week courses will follow the current policies of the Projects and Registrar's Office.

ROOM CHARGES UPON WITHDRAWAL OR SUSPENSION

	Charge
1. Withdrawal after enrollment, but prior to the first day of classes. (Forfeiture of advance payment.)	\$100.00
2. Withdrawal after the first day of classes.	100% charge of room fee

BOARD CHARGES UPON WITHDRAWAL OR SUSPENSION

	Charge
1. Withdrawal after enrollment, but prior to the first day of classes.	No Charges
2. Withdrawal within four weeks following the first day of classes.	25% of board fee
3. Withdrawal within eight weeks following the first day of classes.	50% of board fee
4. Withdrawal within twelve weeks following the first day of classes.	75% of board fee
5. Withdrawal after twelve weeks following the first day of classes.	100% of board fee

FINANCIAL AID UPON WITHDRAWAL/ SUSPENSION

Federal regulations for a student receiving a Pell Grant, Supplemental Educational Opportunity Grant, Perkins Loan, or Stafford Loan require repayments to the fund from excess credit when a student withdraws or is suspended during a semester. Health insurance, health fee, and social fee are not prorated nor refunded. Stafford Loans, Parent PLUS Loans, Perkins Loans, Supplemental Educational Opportunity Grants and Pell Grants are reduced in that order by the percentage the total amount bears to the total financial aid package excluding employment.

WPI scholarships and institute loans are reduced up to the amount of remaining credit. If additional credit remains, it will be refunded to the student or outside sources.

FINANCIAL AID

WPI is committed to providing financial assistance to students whose family resources are insufficient to totally meet the cost of education. Central to WPI's program is the concept of financial need, based on the assumption that parents and students together accept the responsibility for educational expenses to the extent they are able. Over 70% of WPI undergraduates are receiving financial help from college resources. A combination of grants, loans and work study assistance from federal, state and WPI funding are allocated to students who demonstrate financial need. The proportion of grant, or "gift" assistance, versus loan and work, may be determined by the college on the following criteria: the magnitude of the financial need, the availability of funds and the student's merit.

APPLICATION PROCEDURES

Students are required to file the Free Application for Federal Student Aid (FAFSA) and the CSS (College Scholarship Service) PROFILE Application. List WPI's Code # under the section on each form where you designate which schools are to receive the form. In addition, send to the Financial Aid Office a signed copy of your parents'

Federal Income Tax Forms and W-2 Forms for the prior year plus all related schedules, and a signed copy of the student's Federal Income Tax Forms and W-2 Forms (or a statement signed by the student indicating he/she will not file a return.) for the prior year. In the case of separation or divorce, the noncustodial parent must complete a Noncustodial Parent's Statement and send it directly to the WPI Financial Aid Office. This form is available from CSS or may be obtained from the WPI Financial Aid Office or it can be downloaded from the office website (<http://www.wpi.edu/Admin/FA/Forms/?fy>)

EARLY DECISION APPLICATION FOR FINANCIAL AID

You must indicate on your admission application that you are applying for financial aid. For those students applying for early decision admission, the CSS PROFILE Application must be filed by November 15th (December 15th for Early Decision Round II applicants). The FAFSA and the CSS PROFILE Registration forms are available at the Guidance Office of the student's secondary school. All federal tax return forms, as outlined above, are required as soon after January 1 as possible, as well as completion of the FAFSA.

Early decision candidates will receive a financial aid package that meets their demonstrated financial need as determined by WPI, using both the CSS PROFILE Application and FAFSA by mid-late December (as long as your financial aid application is complete). No award decision is final until all material is received and reviewed.

EARLY ACTION APPLICATION FOR FINANCIAL AID

You must indicate on your admission application that you are applying for financial aid. For those students applying for early action admission, the CSS PROFILE Application should be submitted between November 15th – March 1st.

The FAFSA and the CSS PROFILE Registration forms are available at the Guidance Office of the student's secondary school. All federal tax return forms, as outlined above, are required as soon after January 1 as possible, as well as completion of the FAFSA. No award decision is final until all material is received and reviewed.

Successful candidates for early action admission will be notified of a financial aid decision on a rolling basis. You will then have from the date of your aid decision until the candidates' common reply date, May 1, to either accept or decline the aid offered.

REGULAR DECISION APPLICATION FOR FINANCIAL AID

You must indicate on your admission application that you are applying for financial aid. Successful candidates for admission will be notified of a financial aid decision in early April. You will then have from the date of your aid decision until the candidates' common reply date, May 1, to either accept or decline the aid offered.

To ensure a complete review, we must receive the FAFSA, CSS PROFILE and, for best results, all applicable federal tax returns and W-2(s) by March 1. Applications completed after this date will be reviewed subject to funds available. We suggest you obtain the FAFSA and the CSS PROFILE Registration materials from the Guidance Office of your secondary school by January, since it takes four to six weeks for the forms to be processed and sent to colleges.

UPPERCLASS APPLICATION FOR FINANCIAL AID

Financial aid applicants must apply for financial aid every year by completing the FAFSA, the CSS PROFILE Application, and the WPI upperclass application. These forms will be available at the beginning of Term C and are due by the beginning of Term D. The complete application packet covers grants, scholarships, loans and on-campus employment for the following academic year. Students and their parent(s) are expected to obtain and submit all requested forms in a timely manner for each year of planned enrollment.

The amount of financial aid upperclass students receive will depend on their family's demonstrated financial need which is determined from both the FAFSA and CSS PROFILE Application. In addition to the above, the number of classes a student successfully completes (up to a maximum of 12 per academic year) with a grade of "C" or higher in the previous academic year will be used to determine the amount of grant and/or scholarship assistance a student will receive in his/her financial aid package.

TRANSFER STUDENTS

Transfer students may apply for financial aid eligibility beginning with their first term of matriculation, and must indicate interest in financial aid on the admission application. Transfer aid applications will be reviewed based on the same documentation required for first year applicants and are packaged on a funds available basis.

FORMS OF AID

FEDERAL PELL GRANTS

Federal Pell Grants are awarded to high need students from low and lower middle-income families. These grants range from \$400 to \$4,000 per academic year. A Student Aid Report (SAR) is sent to all students who file a Free Application for Federal Student Aid (FAFSA). The WPI Financial Aid Office will verify the data on the form, make corrections if necessary, and then submit the SAR for payment from the Dept. of Education. In 2001-02, WPI administered over \$950,000 in Federal Pell Grant funds to eligible full and part time students.

FEDERAL SUPPLEMENTAL EDUCATIONAL OPPORTUNITY GRANTS (SEOG)

Federal SEOG funds are allocated to institutions by the Federal government. These funds, which are awarded to students as campus based grants, are awarded to high need students who are also eligible for the Federal Pell Grant. WPI students received over \$850,000 in Federal SEOG funds in the 2001-02 academic year.

FEDERAL STAFFORD GUARANTEED STUDENT LOAN

Student Federal Stafford Loans (GSL) are federally subsidized student loans; interest accrued is paid by the federal government while the student is enrolled at least half time. Repayment of both principal and interest begins at the end of the 6 month "grace period" following graduation or withdrawal from school. The repayment period is ten years and the interest rate is set at the bond equivalent rate of 91 day Treasury bills (as of the preceding June) plus 2.3%, capped at 8.25%. Approximately 3%-4% in origination and guarantee fees are deducted by the bank before the proceeds are disbursed to the school.

Students must file a FAFSA so that WPI can determine need-based eligibility for the Federal Stafford Loan. The Federal government sets annual borrowing limits according to the student's year in school or grade level. First year students may borrow up to \$2,625, second year students up to \$3,500 and third and fourth year students up to \$5,500. Students cannot borrow in excess of \$23,000 over the life of their undergraduate education.

Students not eligible for the subsidized Stafford Loan may borrow through the unsubsidized Federal Stafford Loan Program. In the unsubsidized Stafford Loan Program, the federal government does not pay the interest accrued while the student is enrolled. The student has the option to capitalize the interest and postpone repayment of principal and interest until after graduation or withdrawal from school.

The WPI Financial Aid Office recommends and approves the amount a student may borrow for the subsidized and unsubsidized Federal Stafford Loan. For all

new borrowers, the Financial Aid Office will obtain a Master promissory note and forward it to the student. The student must complete, sign and return the promissory note to the Financial Aid Office. The Master promissory note only needs to be signed once during the student's undergraduate time at WPI (if you continue on to graduate school at WPI, you do not need to sign a new MPN). If you are a previous borrower with an out-of-state lender and you have not completed a Master Promissory Note, you must obtain and complete a Master Promissory Note from the lender you borrowed from last year and forward it to WPI for processing.

All new WPI students (first year, transfer & graduate) must complete a Master Promissory Note at WPI.

FEDERAL PERKINS NATIONAL DIRECT STUDENT LOAN

Federal Perkins Loans are also federally subsidized loans awarded directly to students by colleges. Students are awarded based on funds available. Repayment of both principal and interest, currently 5% fixed, begins nine months after the recipient graduates or leaves college. Perkins Loan promissory notes are signed at the beginning of each semester. In 2001-02 WPI administered over \$1.2 million in Federal Perkins Loans.

FEDERAL COLLEGE WORK STUDY PROGRAM

Federal College Work Study funds are allocated annually to colleges who offer federally funded work opportunities to high need financial aid applicants. Federal Work Study is included in the financial aid award letter to eligible students. If you accept a Federal Work Study offer, you may work a maximum of 10 hours per week at the current wage of \$7.50 per hour. Federal Work Study earnings are paid by check on a bi-weekly basis directly to the student employee.

Work is available in a variety of academic and administrative settings on campus. The amount offered indicates maximum earnings allowed, but is not a guarantee. The best procedure is to take an available position at the start of the academic year and work as much as your schedule allows up to the maximum 10 hours per week. If you decline an offer of work, it will not affect the other components of your award package.

Students are prohibited from Federal Work Study employment if one of the following situations occur: if the student falls below the WPI established satisfactory progress levels for retention of aid; or the student enrolls on a less than full time basis; or the student registers as a "Special Student."

STATE SCHOLARSHIP PROGRAMS

WPI administered over \$280,000 from the MASSGrant Program during the 2001-02 academic year. The MASSGrant is awarded to Massachusetts residents whose combined family contribution falls within state-determined parameters. Students must file the FAFSA by the state-designated deadline and follow all state program procedures to apply.

Massachusetts has reciprocity agreements with seven other states: Connecticut, Maine, Maryland, New Hampshire, Pennsylvania, Rhode Island and Vermont. These states allow their residents attending institutions in Massachusetts to "carry" need-based state grants into Massa-

chusetts. Grants from all reciprocal states to WPI students last year totaled \$135,000. Awarding from other state scholarship programs depends on annual state funding levels.

The Massachusetts Gilbert Matching Grants Program is allocated annually to WPI. These funds are awarded to Massachusetts residents who fall within a certain financial need. WPI students received over \$750,000 in the Massachusetts Gilbert Matching Grant during 2001-02.

STATE FUNDED STUDENT LOAN PROGRAMS

The Commonwealth of Massachusetts provides the Massachusetts No Interest Loan (MA NIL) Program through annual allocations to participating colleges and universities. Students who file the FAFSA and meet state eligibility criteria are eligible for the Massachusetts No Interest Loan on a funds available basis. WPI administered over \$260,000 in the MA NIL program in 2001-02.

WPI COLLEGE SCHOLARSHIP

WPI awards College Scholarships and other restricted or endowed "gift" assistance, to students who have a demonstrated financial need based on review of the complete financial aid application, including the FAFSA, the CSS PROFILE Application, IRS tax returns, W-2 forms, and the upperclass WPI folder/application. WPI gift aid may be combined with federal and state grants to make up a student's total portion of "gift" assistance, before loans and work are packaged. Grants and scholarships funded directly by WPI exceeded \$23 million in 2001-02.

WPI INSTITUTE STUDENT LOAN PROGRAM

WPI offers a need-based loan similar to the Federally subsidized Stafford and Perkins loans. Students do not begin repayment of the principal and interest accrued until 9 months after graduation or separation from the college. WPI students borrowed \$1.7 million in Institute Loans during 2001-02. The Institute Loan terms and eligibility criteria are similar to the Federal Perkins Loan Program.

WPI DEPARTMENT-FUNDED WORK PROGRAM

Students who are not eligible for Federal Work Study funds may seek employment opportunities through departments or offices on campus who set aside funds for hiring undergraduate employees. These employment funds vary from year to year in terms of monies available or the number of students allowed per department/office. Students may also inquire about department-funded summer positions on campus.

RESERVE OFFICER TRAINING CORPS (ROTC) SCHOLARSHIPS

ARMY ROTC SCHOLARSHIP PROGRAM

The Army ROTC scholarship program offers financial assistance to outstanding students who meet the rigid standards of the **Scholar, Athlete, Leader**, attributes and have a strong desire and commitment to serve their country as commissioned Army officers. Scholarships are awarded based upon student merit, not financial need.

Potential college freshmen may apply for 4-yr scholarships early in the college search process on-line through the U.S. Army Cadet Command website, www.armyrotc.

com or by contacting the Army ROTC office at WPI. In many instances high-quality students who enter the program after their freshmen year may earn 3-yr scholarships based upon their academic, athletic and leadership potentiality. Sophomores may also enter the Army ROTC program and qualify for a 2-yr scholarship by graduating from the 5-week Leader's Training Course (LTC) at Fort Knox, Kentucky.

Transfer students with prior military training or students pursuing a Graduate Program of study may also qualify for a scholarship under the 2-yr program. Students from the Army Reserve or National Guard who enter the program as juniors may qualify for substantial financial benefits under a Simultaneous Membership Program.

Army ROTC scholarships may cover partial or full tuition, most fees, and include \$600 annually for books and a tax-free subsistence allowance that starts at \$250 monthly for freshmen and increases \$50 incrementally each year the cadet is in the program. Non-scholarship cadets receive the tax-free stipend of \$350 monthly at the junior year in college.

Students interested in learning more about the outstanding opportunities in the Army ROTC program should contact the Professor of Military Science located in the lower level of Harrington Auditorium by calling (508) 752-7209 or by visiting the Army ROTC website.

NAVAL ROTC SCHOLARSHIP PROGRAM

Programs leading to a commission in the United States Navy or Marine Corps are available for all qualified WPI students through cross-enrollment at the College of the Holy Cross.

WPI students may participate in the four-year or two-year national Naval ROTC Scholarship Program. Additionally, first and second year non-ROTC students may apply directly to the Professor of Naval Science for enrollment in the College Program (non-scholarship). After completion of at least one semester as a College Program midshipman, students who have achieved a GPA of 3.0 or higher, passed one semester of calculus with a grade of C or better, and performed well in the battalion may be recommended by the Professor of Naval Science for a Chief of Naval Education and Training Controlled Scholarship. All scholarships include full tuition, stipend and fees, military uniforms, and an minimum allowance of \$250 a month.

Along with their degree requirements, Naval ROTC students are required to successfully complete one naval science course per semester and participate in weekly unit drill periods. Additionally, scholarship students attend summer training after their freshman, sophomore and junior years.

After successful completion of the program, students are commissioned as ensigns in the Navy or second lieutenants in the Marine Corps. Ensigns enter into either aviation, submarine warfare, surface warfare, or special operations/warfare.

Students interested in Navy ROTC should either write to the Naval ROTC Unit, College of the Holy Cross, Worcester, Massachusetts 01602, or call (508)793-2433. Students may also find additional information on the internet at <http://holycross.edu/departments/nrotc/website/homepage/>

AIR FORCE ROTC SCHOLARSHIP PROGRAM

WPI students may participate in the four- or two-year Air Force ROTC programs conducted at WPI where the AFROTC offices are located. The AFROTC programs, which are voluntary and open to all students, lead to a commission as a Second Lieutenant in the U.S. Air Force.

The academic program consists of a one-hour, 1/9 unit general military course each term of the first and second years, and a two-hour 1/6 unit professional officer course each term of the third and fourth years. The courses cover Air Force organization and history during the first two years; management, leadership, American defense policy, and the military in society during the final two years. Each student is also provided with field training, which is completed during the summer between the second and third years. Students attending field training receive travel pay and are paid while in attendance at summer camp at the rate of one-half of the base pay of a Second Lieutenant with less than two years of service. Students who participate in the last two years of AFROTC only must attend field training for six weeks; students who have participated during the first two years of AFROTC attend for four weeks.

Students not already receiving an AFROTC scholarship may compete for either two or three year scholarships. Scholarships cover all or partial tuition costs, fees and textbooks. In addition, a monthly tax free subsistence allowance of at least \$250 is paid to all scholarship students and to all students in their last two years of AFROTC.

Enrollment in the AFROTC program require United States citizenship, good moral character and sound physical condition. Students interested in AFROTC should write to the Department of Aerospace Studies, AFROTC Detachment No. 340, WPI, Worcester, Massachusetts 01609-2280. Offices are located at 35-37 Institute Road.

FINANCIAL AID POLICIES

Financial Aid is awarded one year at a time. Aid applicants are required to reapply annually by the beginning of Term D. An annual review of each applicant's need is designed to assure that aid is renewed equitably as different circumstances cause needs to change. The Financial Aid Office assesses need through a review of the complete financial aid application, appropriate IRS forms, conferences with the student and family, and other information that the student may wish to submit or be asked to submit. Financial aid eligibility letters are mailed to upperclass students in early July for the following academic year.

STUDENT CONTRIBUTION

It is expected that the student's family will contribute its maximum financial effort and that the student will also make a maximum effort through savings from annual earnings and by accepting a proportion of financial aid in the form of loans and/or in-school employment, if eligible. Students at WPI are expected to contribute a minimum \$1,900 each academic year, from summer or other annual earnings. While this minimum student contribution is used, the Financial Aid Office must review previ-

ous calendar year student earnings and student savings/assets as the basis for determining the annual student contribution.

INFLATED NEED

Marriage, self-declared emancipation or independence from family, ownership and maintenance of valuable property (e.g., automobile), or other voluntary, self-imposed financial burdens will not be considered by WPI as a bona fide basis of financial need. Married or otherwise emancipated students will enjoy rights equal to but not exceeding those of other students, and they must apply for aid on the same basis as other students. Inaccurate documentation of financial need or omission of any financial resources may result in the complete loss of financial aid. Due to federal and state regulations and limited available resources, a student's total financial aid from combined sources cannot exceed the need derived from the college's cost of attendance minus the calculated family contribution. Therefore, all outside scholarships must be reported to the WPI Financial Aid Office for verification and possible adjustment of the total financial aid awarded.

Awards from Federal Pell Grants and State sources which were not estimated or were underestimated by the Financial Aid Office will be used to reduce any WPI administered grant if offered. Also, WPI will not make up the loss of an estimated State Grant if the student is considered ineligible due to a failure to apply appropriately or timely.

AID RETENTION / PROGRESS TOWARD A DEGREE

There are four key elements to the retention of eligibility for financial aid as it relates to academics:

1. The more courses you successfully complete (up to a maximum of 12 courses) during the Terms A-D academic year, the more your grant/scholarship eligibility is retained for the next academic year. Attempting, but not successfully completing courses and project work will reduce your aid.

Also, incompletes, as well as Advanced Placement, or other transfer credit cannot be counted in the determination of units completed. You will be responsible for resolution of incompletes with the faculty member assigning the grade.

2. Eligibility for consideration for all types of financial aid* is lost if you are placed on Academic Probation. Reviews of academic progress status are conducted by the Projects and Registrar's Office after Term B (Fall Semester) and Term D (Spring Semester).

*Includes all of the following:

- State Scholarship
- Federal Pell Grant
- Massachusetts No Interest Loan
- Federal Supplemental Opportunity Grant
- WPI Scholarships, Grants, & Loans
- Federal Perkins Loan
- WPI ROTC Room Credit
- Federal Subsidized/Unsubsidized Stafford Loan
- WPI ROTC Board Credit
- AI Parental & Auxiliary Loan Programs
- All on-campus employment

PETITIONS: A student failing to meet the eligibility requirements may, in cases which involve unusual and extenuating circumstances such as documented medical problems, file a petition with the Office of Financial Aid. The petition will be reviewed by the Financial Aid Appeal Committee, which is comprised of academic administrators (not members of the Office of Financial Aid). Determination will be made concerning eligibility on a case by case basis.

3. Regardless of academic progress status, eligibility for financial assistance (with the exception of Federal Stafford Loans), is available for the shorter of the two following periods: 16 terms (4 years) of enrollment or completion of your Bachelor Degree requirements at WPI.
4. If you receive grants/scholarships, loans of all forms and work study, you must be registered as full-time. You are charged tuition based upon full time status, and that serves as the basis for annual financial aid eligibility determinations.

You are responsible for knowing your status and working with an academic advisor to register for the necessary units to maintain eligibility for financial aid.

GRADUATE AND INTERNATIONAL STUDENTS

Graduate students are not eligible for undergraduate sources of need-based financial aid. The graduate Federal Stafford Loan is the only source of need-based aid administered by the Financial Aid Office to graduate students. Returning international students, who do not have official documentation of Permanent Residence in the United States, are ineligible for all sources of financial aid administered by the WPI Financial Aid Office. Limited scholarships are available for entering international students.

ALTERNATIVE FINANCIAL PROGRAMS

Alternate financing programs are available to many families who do not apply for aid or who need to supplement the aid offered. Several payment plans are available, which allow families to pay their annual charges over several months, rather than in two semester payments. Contact the WPI Accounting Office for further information about payment plan brochures and applications. The following three long-term financing programs assist families in spreading educational costs over 10 to 20 years. The three loans below allow families to borrow the difference between the cost of attendance determined by the college and total financial aid for the year. Contact the Financial Aid Office for additional information about the loans explained below, as well as other financing options.

FEDERAL PLUS LOANS

Federal PLUS Loans are available annually to parents of dependent undergraduates. Repayment begins when the funds are advanced, and parents have 10 years maximum to repay. The interest is calculated on a variable rate based on the average 52 week Treasury bill rate plus 3.1%, capped at 9%. Applications may be obtained from the WPI Financial Aid Office or a participating lender, and the application/promissory note must be completed and sent to the Financial Aid Office for authorization. The process requires approximately four to five weeks to complete before funds are disbursed.

THE MASSACHUSETTS EDUCATIONAL FINANCING AUTHORITY (MEFA)

WPI is a participant in MEFA, a not-for-profit, state authority serving students enrolled in the Commonwealth's accredited institutions. The Authority, in cooperation with WPI and other participating colleges and universities, offers a program of Family Education Loans, under which parents and students can borrow up to cost-less-aid and repay it in low monthly payments.

Parents have an option of a variable or fixed rate. The interest rate on the variable rate option is expected to be based on the Authority's total borrowing costs on monthly sales of Commercial Paper, plus approximately 2.75%. Commercial Paper is one of the lowest cost forms of debt financing currently available. Parents may be eligible to secure the loan with the Home Mortgage Option, using either interest rate option. The variable rate option carries a 10 year repayment limit, and the fixed rate has a 15 year limit. Borrowers must be citizens of the United States.

MEFA's MASS PLAN programs outlined above are described in a brochure/application which parents may obtain from the WPI Financial Aid Office or by contacting MEFA directly at 1-800-449-MEFA. Processing takes approximately six to eight weeks from initial submission of the application to approval and final disbursement. A credit check is performed to determine whether the borrowers' debt-to-income ratio lies within the approved limit.

CITIBANK'S CITIASSIST LOAN

The Citiassist Loan is offered to students with creditworthy cosigners. Eligible students may borrow a maximum loan of no more than cost of attendance less financial aid awarded. While students do not have to be U.S. citizens or permanent residents of the U.S., cosigners must be. The interest rate of the Citiassist Loan is equal to the current prime rate plus .5%. Borrowers have the option of deferring both principal and interest while enrolled in school. Interest will accrue under this option. The repayment period for a Citiassist Loan is 12 years. Applications may be obtained from the WPI Office of Financial Aid or students can apply on line at www.studentloan.com.

HOUSING

RESIDENCE HALLS

WPI provides its undergraduate students with a variety of housing options, both on and off campus. The WPI residence halls offer students a choice of single, double, and triple occupancy rooms as well as suites designed for four and six persons, and two- to seven- person apartments. In addition, WPI owns and staffs four houses located just a short walk from the campus. Off-campus housing alternatives include rooms in homes, apartments, fraternity/sorority living, and commuting from home.

Residence hall living at WPI offers opportunities that can be a valuable part of higher education. For this reason, on-campus housing is guaranteed to all first-year students who request it by June 1 as stated in their admission letter. First-year students admitted for Term A are guaranteed housing in the residence halls for Terms A, B, C, and D of that academic year.

Upperclass students may apply for those residence hall spaces not reserved for incoming first-year students. The Housing and Food Service Contract is a legally binding contract which extends from the beginning of Term A through Term D as long as the student is enrolled at WPI.

RESIDENCE HALL STAFF

Student Hall Directors (SHDs) and Resident Advisors (RAs) are the core of the residential life staff in the residence halls. RAs serve as a source of assistance in resolving students' academic, personal, and social concerns. They plan and implement social and educational programs in the halls, and enforce all WPI policies and regulations in an effort to develop an effective living-learning environment in the residence halls.

The administrative responsibility for the operation of the residence halls rests with the professional staff in Residential Services. They are available as resource persons to counsel and advise students, work with maintenance and dining hall staffs, and handle many administrative processes for students living on campus.

OCCUPANCY

Residence halls *normally* open at 9:00 a.m. four days before Term A begins and close at 12:00 noon on the day following the last day of classes for Term D. Housing and food service privileges are not transferable, nor may any person take up *de facto* residence without paying rent. The residence halls will be closed during the December recess period.

FURNISHINGS AND FACILITIES

Students are responsible for the neatness and cleanliness of their rooms. Residence halls are furnished with a twin-size bed, a desk and chair, closet space, and drawer space for each student. Students may arrange for private phone service through WPI if desired. Residents provide their own pillows, linens, blankets, and other personal furnishings. Coin-operated laundry facilities are available at four locations on the campus.

The following are not permitted in the residence halls:

- Sale, use or possession of illegal drugs
- Pets, except small fish
- Refrigerators larger than 4.0 cubic feet in size
- Gambling
- Use of alcoholic beverages in violation of Massachusetts State Laws
- Firearms, weapons, explosives, incendiary or toxic chemicals, starting pistols

- Cooking, except in kitchen areas provided
- Candles or other flame-emitting devices
- Lofts
- Smoking

Mail and express packages should be addressed to the student by name, and box number, WPI, 100 Institute Road, Worcester, MA 01609-2280.

ROOMMATES

One of the most memorable aspects of campus life can be the relationship you will build with your roommate(s). Roommates often find that a meaningful relationship is developed through the sharing of thoughts and feelings; in other words, communication. We encourage you to be as open as possible so that you and your roommate can begin early to create a relationship based on respect and understanding. This relationship can help make residence hall living one of the most enjoyable part of your college career.

ROOM CHARGES

Since room and board rates for 2003-2004 were not established at the time of this publication, they will be announced separately.

Room rental rates for 2002-2003 were as follows:

	Double Occupancy	Single Occupancy
	Triple Occupancy	
Morgan Hall	\$4,890	\$5,374
Daniels Hall	4,890	—
Institute Hall	4,890	5,374
Sanford-Riley	4,890	5,374
Stoddard Complex	4,890	5,374
25 Trowbridge House	4,890	—
28 Trowbridge House	4,890	—
26 Hackfeld House	4,890	5,374
16 Elbridge	4,890	5,374

Ellsworth/Fuller Apartments	Two-Person	Three-Person	Five-Person	Seven-Person
	\$5,160	\$4,852	\$4,578	\$4,138

Founders Hall

All Double	\$5,224
All Single	5,656
2 Person Singles (handicap suite)	5,680
2 Person Suite	5,284

Note: Each apartment is equipped with basic furnishings including stove and refrigerator. Students living in Ellsworth/Fuller pay their own electric bills; heat is electric.

Payment for housing and food service fees are made in two installments, one each at the beginning of Terms A and C. Refunds will be processed according to the established refund policy of the college. Students entering the residence halls other than at the beginning of Term A or C will be issued a prorated billing for the period. This bill must be paid in full prior to occupancy.

As part of the room charges for the first term of residency, the student is assessed a \$150 damage deposit. Students are expected to care for the physical facilities of the residence halls. Damage to the facilities beyond the

normal wear and tear shall be the financial responsibility of the residents. The security deposit, less any outstanding charges, will be returned to the student within a reasonable time after the student leaves the housing system.

First-year students can expect to receive a Housing and Food Service Contract in early May, after their \$500 tuition deposit is received by the Office of Admissions. On this contract, they will indicate their room preference for the residence halls.

All students wishing to live in the residence halls must submit a signed WPI Housing and Food Service Contract.

MEALS

All residence hall students (with the exception of Fuller/Ellsworth apartment residents) are required to participate in one of the four meal plans. The MEALS PLUS PLANS are a combination of traditional meal plans plus additional funds to be utilized at the students discretion.

Once a student has contracted for food service, the commitment remains in effect through the remainder of the year. This is a legally-binding agreement, and students are obligated to assume financial responsibility for the entire academic year.

Rates for the 2002-03 academic year were:

19-Meal PLUS	\$3,540
14-Meal PLUS	\$3,836
The 190	\$3,836
The Premier	\$3,836
The VIP Pass	\$4,300

OFF-CAMPUS LIVING

After the freshman year, on-campus housing may be at a premium; so if you decide to look for an off-campus apartment, make plans well in advance. Residential Services, located in Ellsworth 16, can be a valuable resource for you as you begin your search for off-campus housing. Presently, the Residential Services maintains a listing of available housing in the Worcester area, as well as maps of the greater Worcester area. In addition, sample leases, apartment condition forms, and brochures on tenants' rights are available for student and staff use. Information is available for you to research questions about small claims court, housing codes, leases, etc. The following are a few hints for you as you begin your search for off-campus housing.

Leases: Contract periods for off-campus housing vary in length, from twelve-month and nine-month to summer only and three-month leases. As you consider various places, find out what types of leases are available.

Looking: Check bulletin boards around campus for apartment ads. Also watch *Tech News* classifieds. In addition, the Residential Services Office maintains a listing of available off-campus housing.

Be Prepared: You'll want to plan realistically for expenses such as utilities, transportation, repairs, laundry, and food. Also, try to pick your roommates carefully and ahead of time.

TRUSTEES, ADMINISTRATION AND FACULTY

S E C T I O N

eight

Trustees	257
Administration	259
Faculty	269
Faculty Emeriti	279
Index	282
Policies & Practices	285
Accreditation	285
Currency of Information	286
Directions	286
Campus Map	IBC

TRUSTEES

The administration of the college is entrusted to a Corporation consisting of not less than 12 members, consisting of life, ex-officio, at-large and alumni members. Emeriti members are elected by the Corporation in an advisory capacity. (Dates in parentheses following each name indicate year of election to membership.)

OFFICERS OF THE CORPORATION

WARNER S. FLETCHER
Interim Chair

DONALD K. PETERSON '71
Vice Chairman

EDWARD ALTON PARRISH
President and CEO

STEPHEN J. HEBERT
Secretary and Treasurer

SYLVIA CUCINOTTA
Associate Treasurer

FRANK P. CONTI
Assistant Secretary

AT LARGE MEMBERS

PAUL W. BAYLISS '60 (1989)
Bayliss Consulting
Naples, ME

ROBERT H. BECKETT '57 (1986)
Retired Chairman and CEO
AmeriQuest/Robec
Horsham, PA

CURTIS R. CARLSON '67 (2002)
President and CEO
SRI International
Menlo Park, CA

THOMAS A. CORCORAN (1993)
President and CEO
Gemini Air Cargo
President, Corcoran Enterprises LLC
Potomac, MD

WARNER S. FLETCHER (1993)
Fletcher, Tilton & Whipple, P.C.
Worcester, MA

ROBERT A. FOISIE '56 (1993)
President
Matik North America
West Hartford, CT

JOHN J. GABARRO '61 (1987)
*Professor and Chair, The Advanced
Management Program*
Harvard Business School
Boston, MA

CLAIRE L. GAUDIANI
Senior Research Scholar
Yale Law School
New Haven, CT

PETER H. HORSTMANN '55 (1984)
Retired
New York Times Co.
Worcester, MA

M HOWARD JACOBSON (1977)
Westborough, MA

CHARLES C. JOHNSTON '57 (1991)
Chairman
Ventex Technology Inc.
Riviera Beach, FL

JOHN L. LaMATTINA (2001)
Vice President, Pfizer Inc.
*Executive Vice President, Pfizer Global Research &
Development*
President, Worldwide Research & Technology Alliances
New London, CT

GORDON B. LANKTON (1980)
Chairman
NYPRO, Inc.
Clinton, MA

PETER H. LEVINE (1990)
Health Care Consultant
BDC Advisors, LLC
Worcester, MA

F. WILLIAM MARSHALL, JR. (1986)
Retired Consultant
Chebeague Island, ME

PHILIP R. MORGAN (1994)
President and CEO
Morgan Construction Company
Worcester, MA

JOHN M. NELSON (1987)
Chairman
Commonwealth National Bank
Worcester, MA

JUDITH NITSCH '75 (1989)
President
Judith Nitsch Engineering, Inc.
Boston, MA

WINDLE B. PRIEM '59 (1991)
Vice Chairman and Director
Korn/Ferry International
Boston, MA

LEONARD E. REDON '73 (1992)
Vice President, Western Operations
Paychex, Inc.
Penfield, NY

ROBERT P. RESTREPO, JR. (2000)
President, CEO and Director
 Allmerica Property & Casualty
Vice President
 Allmerica Financial Corporation
 Worcester, MA

JOHN J. SHIELDS (SIM '69) (1990)
General Partner
 Boston Capital Ventures
 Boston, MA

H. KERNER SMITH, II (1993)
Chairman
 Internet Power
 Sudbury, MA

GLENN YEE '74 (1999)
CEO
 Pacific Can Co., Ltd.
 Wanchai, Hong Kong

EX-OFFICIO MEMBER

EDWARD ALTON PARRISH (1995)
President of the Institute

ALUMNI MEMBERS

To June 30, 2003

DANIEL I. COIFMAN '67 (1995)
ABLE International Corporation
 Santurce, PR

STEPHEN E. RUBIN '74 (1995)
Founder
 Intellution, Inc.
 Norwood, MA

To June 30, 2004

ALFRED A. MOLINARI, JR. '63 (1996)
President and CEO
 Data Translation, Inc.
 Marlboro, MA

FREDERICK D. RUCKER '81 (1996)
Managing Partner
 Capital Management Partners
 McLean, VA

To June 30, 2005

GEORGE T. ABDOW '53 (1993)
Retired Chairman
 Abdow Corporation
 Springfield, MA

DAVID K. HEEBNER '67 (1997)
Senior Vice President, Planning and Development
 General Dynamics
 Falls Church, VA

DONALD K. PETERSON '71 (1997)
Chairman and CEO
 Avaya Inc.
 Basking Ridge, NJ

To June 30, 2006

PAUL S. KENNEDY '67 (1998)
President
 Kennedy Die Casting, Inc.
 Worcester, MA

CARLETON F. KILMER '64 (1999)
Management Consultant
 Electronics and High Technology
 Wellesley, MA

To June 30, 2007

PHILIP B. RYAN '65 (1999)
Managing Director
 RYAN Associates
 Bedford, NH

MICHAEL P. ZARRILLI '71 (1999)
Managing Director and COO
 North American Credit Markets
 J. P. Morgan Securities, Inc.
 New York, NY

To June 30, 2008

KAREN L. BEAN '86 (2000)
Chief Operating Officer
 CADKEY Corporation
 Marlborough, MA

To June 30, 2009

DONALD P. ZERESKI (SIM '74) (2002)
President and CEO
 InfiniSwitch
 Westborough, MA

EMERITI TRUSTEES

PAUL A. ALLAIRE '60 (2002)
 Rowayton, CT

WALTER J. BANK '46 (1986)
 Bethesda, MD

JOHN LOTT BROWN '46 (1983)
 Oberlin, OH

ROBERT CUSHMAN (1984)
 Naples, FL

RICHARD A. DAVIS '53 (1987)
 Quechee, VT

WILLIAM A. DELPHOS '74 (1992)
 McLean, VA

ALBERT M. DEMONT '31 (1974)
 Schenectady, NY

WILLIAM P. DENSMORE '45 (1995)
 Worcester, MA

MICHAEL A. DIPIERRO '68 (2002)
Shrewsbury, MA

IRVING JAMES DONAHUE, JR. '44 (1993)
Shrewsbury, MA

RAYMOND J. FORKEY '40 (1989)
Tequesta, FL

JOHN C. S. FRAY (1999)
Worcester, MA

HOWARD G. FREEMAN '40 (1994)
Worcester, MA

ANSON C. FYLER '45 (1982)
Waynesville, NC

BARBARA B. GATISON '74 (2000)
Blue Bell, PA

CALEB D. HAMMOND '37 (1988)
Maplewood, NJ

WILLIAM E. HANSON '32 (1972)
Shelton, WA

FRANCIS S. HARVEY '37 (1976)
Worcester, MA

JAMES N. HEALD, II (1967)
Worcester, MA

JOHN E. HOSSACK '46 (1994)
New Canaan, CT

WILFRID J. HOUDE '59 (1998)
Los Gatos, CA

PAUL J. KEATING, II '64 (2000)
Leominster, MA

C. JOHN LINDEGREN, JR. '39 (1991)
Westboro, MA

ARTHUR J. LOVETERE '60 (1993)
Atlanta, MI

CLAUDE P. MANCEL '71 (1997)
Belgium

MYLES McDONOUGH (1999)
Worcester, MA

JOHN C. METZGER, JR. '46 (1989)
Vero Beach, FL

CHARLES R. MICHEL '37 (1972)
West Chester, PA

DAVID P. NORTON '62 (2000)
Concord, MA

JOHN F. O'BRIEN (1996)
Needham, MA

STANLEY C. OLSEN (1985)
Lecanto, FL

HILLIARD W. PAIGE '41 (1984)
Washington, DC

RAYMOND J. PERREAULT '38 (1993)
Vero Beach, FL

CAROL L. REINISCH (2001)
Falmouth, MA

DONALD E. ROSS '54 (1993)
Newbury, NH

GEORGE E. SALTUS '53 (1991)
Boulder, CO

GORDON H. SIGMAN, JR. '59 (1996)
Port St. Lucie, FL

DOROTHY M. SIMON (1988)
Pittsboro, NC

S. MERRILL SKEIST '40 (1990)
Plainview, NY

ROBERT C. STEMPEL '55 (1994)
Oxford, MI

DONALD TAYLOR '49 (2000)
North Hampton, NH

HOWARD C. WARREN '42 (1982)
Chicago, IL

LEONARD H. WHITE '41 (1992)
Worcester, MA

ADMINISTRATION

Numerals following name indicate year(s) of initial appointment.

OFFICE OF THE PRESIDENT

EDWARD ALTON PARRISH (1995)

President of the Institute

B.S., M.S., Sc.D., University of Virginia

JOAN M. MURPHY (1984)

Assistant to the President

OFFICE OF THE PROVOST AND VICE PRESIDENT FOR ACADEMIC AFFAIRS

JOHN F. CARNEY III (1996)

Provost and Vice President for Academic Affairs; Professor of Civil and Environmental Engineering

B.S., Merrimack College, 1963;

M.S., Northwestern University, 1964; Ph.D., 1966; P.E.

NIKKI ANDREWS (1996)

Registrar

B.A., Clark University, 1979.

SHEILA BAILEY (1978)

Production Manager, Continuing Education

B.S., University of Massachusetts, 1977.

McRAE C. BANKS (1995)

Director, Collaborative for Entrepreneurship & Innovation Professor of Management

B.A., Virginia Tech, 1972;

M.A., Northwestern University, 1973;

Ph.D., Virginia Tech, 1987.

- ELIZABETH BARR (1993)
Seminar Manager, Continuing Education
B.A., St. Michael's College, 1985.
- JAMES A. BARYS (2000)
Master Teacher of Mathematics, Massachusetts Academy of Mathematics and Science
A.B., Colby College, 1969;
M.A., Clark University, 1977.
- UDO A. BENZ (2002)
Research Engineer, Bioengineering Institute
B.S., University of Fridericiana of Karlsruhe, 1998;
M.S., Worcester Polytechnic Institute, 2001.
- GINA M. BETTI (2000)
Associate Director, Collaborative for Entrepreneurship & Innovation
B.S., Eastern Michigan University, 1980; M.B.A., 1983.
- YEVGENIY BOGDANOV (2002)
Research Assistant Professor, Bioengineering Institute
B.S., Worcester Polytechnic Institute, 1997; M.S., 1998.
- JACKLYN BONNEAU (1996)
Master Teacher of Science, Massachusetts Academy of Mathematics and Science
B.S., Fitchburg State College, 1971;
M.A., University of Connecticut, 1975.
- CAROL L. BRIGGS (1989)
Proposal Services Administrator
A.S., Becker College, 1968.
- FABIO CARERRA (1991)
*Global Program Manager,
Boston and Venice Project Center Director; Venice
Coordinator and Venice Co-Advisor; Adjunct Instructor,
Interdisciplinary and Global Studies Division*
B.S., Worcester Polytechnic Institute, 1984; M.S., 1996.
- ELIZABETH COSTELLO (1999)
Program Manager, Continuing Education
B.A., Boston College, 1979.
- PAUL W. DAVIS (1970)
*Dean, Interdisciplinary and Global Studies Division;
Professor of Mathematical Sciences*
B.S., Rensselaer Polytechnic Institute, 1966; M.S., 1967;
Ph.D., 1970.
- SHARON DEFFELY (1978)
Director, Corporate Training, Continuing Education
A.S. Graham Junior College, 1969.
- BRIAN DEGON (2001)
Program Manager, Corporate Education
B.S., Worcester Polytechnic Institute, 1995.
- KAREN DILLMAN (2000)
Assistant Director, Continuing Education
B.A., Rutgers University, 1978.
- JEFFREY C. DITULLIO (1997)
Technology Licensing Associate, Research Administration
B.S.M.E., University of Massachusetts-Lowell, 1987;
M.S., 1990.
- WILLIAM W. DURGIN (1971)
*Associate Provost for Academic Affairs; K. G. Merriam
Professor of Mechanical Engineering*
B.S., Brown University, 1964;
M.S., University of Rhode Island, 1966;
Ph.D., Brown University, 1970.
- RICHARD G. FALCO (1979)
Director of Jazz Studies; Humanities and Arts
B.A., University of Massachusetts, 1989;
M.A., Clark University, 1992.
- THELOISE W. FERRELL (1999)
*Master Teacher of Humanities, Massachusetts Academy of
Mathematics and Science*
B.S., Radford University, 1967;
M.A.T., Fitchburg State College, 1990.
- CAROL GAROFOLI (1982)
Director of Operations, Metal Processing Institute
A.S., Becker Junior College, 1972;
B.S., Worcester State College, 1982;
M.B.A., Assumption College, 1998.
- ANN GARVIN (1984)
Director of Academic Advising
B.A., West Liberty State College, 1971;
M.A., West Virginia University, 1976.
- TIMOTHY R. GERRITY (2002)
*Director, Bioengineering Institute;
Research Professor, Biomedical Engineering*
B.S., University of Illinois at Chicago, 1972; M.S., 1974;
Ph.D., 1978.
- JEANNE M. GOSSELIN (1999)
Director of Graduate Admissions
B.A., North Adams State College, 1983;
M.S. Ed., Hofstra University, 1992.
- CARL E. HENDRICKS (2002)
Research Engineer, Bioengineering Institute
B.S., University of Arizona, 1975;
M.S., Boston University, 1989;
M.E., Worcester Polytechnic Institute, 1992.
- DONNA M. JOHNSON (1975)
Program Administration, Metro West Campus
A.S., Quinsigamond Community College, 1970.
- KEVIN KOPEC (1998)
Assistant Director, IT Training, Continuing Education
B.A., Alma White College, 1994.
- CHARLES J. KORNIK (1989)
Administrator of Academic Programs
B.S., Fitchburg State College, 1966; M.Ed., 1975.
- PAULINE J. LAMARCHE (1992)
*Principal/Assistant Director, Massachusetts Academy of
Mathematics and Science*
B.S., Worcester State College, 1964; M.S., 1987.
- FRANCOIS D. LEMIRE (2000)
Director of Research Administration
B.S., University of Rhode Island, 1977.

- ARLENE LOWENSTEIN (1980)
Dean of Continuing and Professional Education
B.A., Boston University, 1971;
M.S., Boston College, 1976.
- ROBIN MAGILL (2000)
Marketing Manager, Continuing Education
B.S., Babson College, 1995.
- KATHERINE A. MAHONEY (2002)
Operations Manager, Bioengineering Institute
B.S., Assumption College, 1998.
- JAMES W. MATTHEWS (2002)
Research Scientist
B.S., Lehigh University, 1963;
M.S., Polytechnic Institute of Brooklyn, 1967; Ph.D., 1971.
- NATALIE MELLO (1993)
Director of Global Operations, Interdisciplinary and Global Studies Division
B.A., Connecticut College, 1984;
M.A., Clark University, 1995.
- JEAN-FRANCOIS MENARD (1995)
Master Teacher of Word Language, Massachusetts Academy of Mathematics and Science
B.A., Stonehill College, 1964;
M.A., Boston College, 1973;
D.E.A., Universite de Haute Bretagne, 1979.
- JOHN MINASIAN (1988)
Adjunct Assistant Professor, Management; Dean of Corporate Education
B.S., Worcester Polytechnic Institute, 1972; M.S., 1980;
Ph.D., 1998.
- LISA D. MONTGOMERY (2000)
Assistant Director, Graduate Management Programs
B.A., University of Victoria, 1991; M.B.A., 2000.
- DEAN M. O'DONNELL (1993)
Consulting Administrator—Drama/Theatre and Theatre and Theatre Technology, Humanities and Arts
B.S., Worcester Polytechnic Institute, 1986;
M.F.A., Brandeis College, 1990.
- PEGGY PAYTON (1999)
Business Manager, Continuing Education
M.B.A., Simmons Graduate School of Management, 1996.
- KATHLEEN PIERCE (2000)
Special Projects Coordinator, Projects & Registrar's Office
B.A., Assumption College, 1980;
M.L.M., Harvard University, 1994.
- SARAH M. T. PETRAKOS (2001)
Assistant Director, Graduate Admissions
B.A., Providence College, 1995
M.B.A., Boston College, 1999.
- CREIGHTON PEET (2000)
Program Coordinator/Adjunct Assistant Professor, Interdisciplinary and Global Studies Division
B.A., Harvard College, 1966;
P.Phil., Columbia University, 1978; Ph.D., 1978.
- LAUREN POUCHAK (1999)
Database Manager, Continuing Education
B.S., University Albany, 1997;
M.Ed., Lynchburg College, 1999.
- STACY RISEMAN (1997)
Director for Research Relations
B.S., Roger Williams University, 1989.
- RANDOLPH ROBINSON (1999)
System Administrator, Continuing Education
B.S.M.E., Union College, 1970.
- ROBERT A. SALVATELLI (1999)
Director of the Massachusetts Academy of Mathematics and Science
B.S., University of Bridgeport, 1964;
M.S., Fitchburg State College, 1969.
- LANCE E. SCHACHTERLE (1970)
Assistant Provost for Academic Affairs; Professor of English, Humanities and Arts
A.B., Haverford College, 1966;
A.M., University of Pennsylvania, 1968; Ph.D., 1970.
- DALE E. SNYDER (1999)
Director of the Academic Resources Center
B.S., Plymouth State College, 1976;
M.S., Old Dominion University, 1986.
- PAMELA K. ST. LOUIS (1996)
Operations Manager, Mechanical Engineering and Academic Affairs
A.S., El Paso College, 1972.
- KENNETH A. STAFFORD (1999)
Manager of Academic Initiatives, Adjunct Professor of Mechanical Engineering
B.S., Oregon State University, 1973;
M.S., Air Force Institute of Technology, 1980.
- MARY STEFANEY (1999)
Records/Financial Manager, Continuing Education
B.A., Boston University, 1997.
- GREGORY THEYEL (2001)
Program Manager, Adjunct Assistant Professor, Interdisciplinary and Global Studies Division
B.S., St. John's University, 1986;
M.S., Evergreen State College, 1989;
M.A., Clark University, 1994; Ph.D., 1997.
- KATHLEEN M. THOMPSON (2001)
Graduate Coordinator, Graduate Admissions
B.A., University of Connecticut, 2000.
- JOANN VAN DYKE (1973)
Student Disability Services Coordinator
R.N. Framingham Union Hospital School of Nursing, 1967; Certified College Health Nurse, American Nurses Credentialing Center, 1994.

RICHARD F. VAZ (1983)

Associate Dean, Interdisciplinary and Global Studies Division; Associate Professor, Electrical and Computer Engineering
B.S.E.E., Worcester Polytechnic Institute, 1979;
M.S.E.E., 1984; Ph.D., 1987.

SUSAN VERNON-GERSTENFELD (1987)

Adjunct Associate Professor; Director of Academic Programs and Planning, Interdisciplinary and Global Studies Division
B.A., Boston University, 1962, M.S.W., 1974;
Ph. D., Boston College, 1987.

DOUGLAS G. WEEKS (1980)

Administrator of Applied Music
B.S., University of New Hampshire, 1964;
M.S., Gorham State, 1968;
M.M., University of Massachusetts., 1970;
Ed.D., Boston University, 1987.

NORMAN D. WILKINSON (1995)

Director, Graduate Management Programs
B.A., University of Maine, 1983;
M.A., Syracuse University, 1986;
J.D., University of Connecticut School of Law, 1992.

PETER J. D. WILLIAMS (1997)

Director, Unified Office for Technology Transfer
B.S., University of Sussex, England, 1976;
M.B.A., Imperial College University, England, 1980.

QUING YANG ZHANG (2002)

Research Assistant Professor, Bioengineering Insititute
B.S., Shanghai University Industry College, 1981;
M.S., Shanghai University of Technology, 1988;
M.S., Worcester Polytechnic Institute, 1993; Ph.D., 1998.

OFFICE OF VICE PRESIDENT FOR STUDENT AFFAIRS

BERNARD H. BROWN (1966)

Vice President for Student Affairs
B.S., Springfield College, 1961, M.Ed., 1962;
Professional Certificate, University of Connecticut, 1970.

JANET BEGIN RICHARDSON (1980)

Associate Vice President/Dean of Student Life
B.A., Salem State College, 1975;
Ed.S., SUNY at Albany, 1977; M.S., 1977.

DAVID A. ABRAHAM (1986)

Head Athletic Trainer
B.S., Northeastern University, 1982.

MATTHEW C. BALLARD (1999)

Assistant Football Coach, Instructor of Physical Education, and Physical Center Supervisor
B.A., SUNY at Albany, 1990; M.A., 1993.

THOMAS J. BALISTRERI (1995)

Director, Student Development and Counseling Center
B.S., University of Wisconsin, Oskosh, 1973;
M.A., Pacific Lutheran University, 1975;
Ed.D., Mississippi State University, 1981.

CHRISTOPHER J. BARTLEY (2001)

Head Men's Varsity Basketball Coach
B.A., University of Massachusetts/Lowell, 1994.

STEPHANIE L. BLAISDELL (2000)

Director of Diversity and Women's Programs
B.A., University of Arizona, 1991;
M.A., Arizona State University, 1993; Ph.D., 2000.

MONICA LUCEY BLONDIN (1995)

Associate Director of Financial Aid
B.A., University of Massachusetts, 1990;
M.S., Northeastern University, 1994.

SHARON CAHILL (1990)

Nurse
St. Vincent Hospital, 1966.

DOROTHY CAMPANIELLO (1994)

Recruiting Coordinator, Career Development Center

SARAH CARVER (2002)

Assistant Athletic Trainer
B.S., Ithaca College, 1999.

PHILIP N. CLAY (1993)

Associate Dean of Students and Director of Residential Services
B.A., St. Lawrence University, 1982;
M.A., University Center at Binghamton, 1986.

JENNIFER A. CLUETT (1998)

Senior Assistant Director of Admissions, and Coordinator of Counselor Relations
A.B., Bowdoin College, 1996.

EDWARD J. CONNOR (2000)

Senior Assistant Director of Admissions/Coordinator of International Admissions
B.S., Worcester Polytechnic Institute, 1992;
M.S., Boston College, 1999.

TRACY CREE (1997)

Associate Director of Residential Services
B.S., Clarion University, 1990;
M.S., Elmira College, 1994.

MICHAEL J. CURLEY (1979)

Director of Financial Aid
B.S., University of Massachusetts, 1973;
M.S., Bridgewater State College, 1976.

JULIE DARLING (2001)

Assistant Director of Admissions
B.A., University of New Hampshire, 1997.

JOHANNA DICARLO (2002)

Head Coach; Women's Field Hockey & Women's Softball
B.S., Bentley, 1999; M.S., 2000.

MICHAEL J. DIRUZZA, JR. (2000)

Assistant Director of Financial Aid
A.S., Becker College, 1991;
B.S., New Hampshire College, 1992;
M.B.A., Anna Maria College, 1998.

- JEANNETTE DOYLE (2002)
*Assistant Director, Career Development Center/
Coordinator Career Services*
B.S., Framingham State College, 1989;
M.Ed., Springfield College, 1994.
- CHRIS DUNN (2001)
Assistant Women's Basketball Coach
B.S., Worcester Polytechnic Institute, 1996.
- CHERISE GALASSO (2000)
*Head Women's Varsity Basketball Coach,
Assistant Athletics Director*
B.A., University of Rochester, 1992;
M.S., Nazareth College of Rochester, 1994.
- PHILIP J. GREBINAR (1972)
*Associate Professor, Physical Education and Athletics,
and Head Wrestling Coach*
B.S., State University College at Cortland, 1971; M.S., 1972.
- DANA L. HARMON (2002)
Director of Physical Education, Recreation, and Athletics
B.A., Bellarmine College, 1987;
M.S., University of Massachusetts, 1994.
- YVONNE HARRISON (1992)
Director, Career Development Center
B.S., Lincoln University, 1973;
M.Ed., Temple University, 1984.
- ELAINE A. HELBERG (2000)
Assistant Director of Admissions
B.A., Providence College, 1997.
- ANNE MARIE JUCKINS (2000)
Assistant Director of Financial Aid
B.A., University of Massachusetts/Amherst, 1998.
- KENNETH J. KAUFMAN (1976)
*Assistant to the Athletic Director; Coordinator of Summer
Sports Camps*
B.S., University of Bridgeport, 1968;
M.Ed., Worcester State College, 1973.
- NEIL B. KAUFMAN (2002)
Area Coordinator, Residential Services
B.A., Beloit College, 1990
M.A., New York University, 1997.
- KEVIN KELLY (1998)
Associate Vice President for Enrollment Management
B.A., Western New England College.
- NATALIE K. KOUKIS (2002)
*Head Coach; Men's & Women's Swimming & Diving,
Director of Aquatics, Coordinator of Club Sports*
B.A., Ohio Wesleyan University, 1998;
M.S., Ithaca College, 2002.
- MELISSA M. LEAHY (1997)
Senior Assistant Director of Admissions
B.S., Worcester Polytechnic Institute, 1997.
- NAOMI B. LETENDRE (2002)
Area Coordinator, Residential Services
B.A., Regis College, 1999
M.A., University of Connecticut, 2000.
- BEVERLY J. LOOMIS (1981)
*Office Services Coordinator, Student Development and
Counseling Center*
B.A., University of Minnesota, Duluth, 1957.
- ED LORION (2002)
Manager, Bowling Center.
- SHAWN MCAVEY (1990)
Athletic Equipment Manager.
- BILLY D. MCGOWAN (1987)
ESL Program Coordinator
C.A.G.S., Clark University, 1996;
M.S., Troy State University, 1981.
- CAROLINE E. MCHUGH (2002)
Assistant Director of Admissions
B.S., Case Western Reserve University, 1992.
- JAMES H. McLAUGHLIN (2000)
Director of Campus Center
B.A., Bridgewater State College, 1975;
M.A., Fairfield University, 1977.
- CHARLES MORSE (2000)
Associate Director of Student Development and Counseling
B.A., University of Massachusetts/Amherst, 1981;
M.A., Assumption College, 1993.
- LARRY NOBLE (1999)
Head Coach—Men's Crew, and Director of Intramurals
B.A., Columbia University, 1984;
M.A., University of Virginia, 1993.
- LEOLYN OSBORN (1980)
Associate Director of Financial Aid
B.A., Southeastern Massachusetts University, 1976.
- TRACEY PAKSTIS-CLAIBORNE (1999)
Assistant Director of Student Activities
B.S., Babson, 1993;
M.Ed., University of Southern California, 1994.
- STEPHEN P. RACZYNSKI (1999)
Director of Sports Information
B.A., Assumption College, 1974.
- WENDELIN RANSOM (1999)
Operations Manager, Admissions
B.S., Worcester State College, 1992.
- ANNE RIORDAN (2000)
*Assistant Director, Career Development Center,
Experiential Education*
B.A., College of the Holy Cross, 1986;
M.B.A., Clark University, 1998.
- HENRY O. RITTER (2000)
*Assistant Director of Admissions/Coordinator of
Multicultural Recruitment*
A.A., Quinsigamond Community College, 1993;
B.S., Worcester State College, 1997.

CHRIS ROBERTSON (1999)
Assistant Football Coach and Head Baseball Coach
 B.A., University of Albany, 1994; M.S., 1998.

MICHAEL P. SMITH (1992)
Associate Director of Admissions
 A.B., Bowdoin College, 1989;
 M.S., Clark University, 1999.

GREG SNODDY (2002)
Director of Health Education, Recreation & Club Sports
 B.S., Ohio University, 1983;
 M.S., Bowling Green State University, 1985;
 Ph.D., West Virginia University, 1996.

JASON R. STEELE (1999)
*Head Women's Varsity Crew Coach, and
 Facilities Coordinator*
 B.A., Emory University, 1994.

PAUL SURETTE (2000)
*Assistant Athletic Trainer,
 Instructor of Physical Education*
 B.S., Endicott College, 1999.

TOM H. THOMSEN (1986)
Director of International Students and Scholars
 M.S.W., Copenhagen School of Social Work, 1981;
 C.A.G.S., Clark University, 1994.

KRISTIN R. TICHENOR (2000)
Director of Admissions
 B.A., Carleton College, 1985;
 M.A., Clark University, 1994.

EDMOND ZALOOM (1999)
Head Football Coach/Assistant Director of Athletics
 B.S., State University at Cortland, 1975;
 M.S., University of Albany, 1979.

**OFFICE OF THE VICE PRESIDENT FOR
 ADMINISTRATION, TREASURER AND SECRETARY
 OF THE CORPORATION; SECRETARY-TREASURER,
 WPI ALUMNI ASSOCIATION**

STEPHEN J. HEBERT (1969)
*Vice President for Administration; Treasurer and Secretary
 of the Corporation; Secretary-Treasurer, WPI Alumni
 Association*
 B.S., Worcester Polytechnic Institute, 1966.

JOHN E. MILLER (1982)
*Associate Vice President for Business Affairs;
 Director of Physical Plant*
 B.S.M.E., Clarkson University, 1966; M.S., 1971.

RODERICK J. BEATON (1992)
Assistant Director of Public Safety
 B.S., Boston College, 1976;
 M.A., Clark University, 1980.

BARRY E. CARMEL (1985)
Senior Staff Accountant
 A.S., Central New England College, 1972.

MICHAEL J. CARNEY (1990)
Assistant Vice President, Human Resources
 B.S./B.A., Nichols College, 1968;
 M.B.A., Suffolk University/Golden Gate, 1972.

FRANK P. CONTI (1981)
Controller and Assistant Secretary
 B.S.A., Bentley College, 1967; CPA, 1975.

DANIELLE L. COVE (1996)
Assistant Treasurer
 B.A., Clark University, 2000.

LAUREN A. CRAWFORD (1994)
Staff Accountant

SYLVIA CUCINOTTA (1981)
Associate Treasurer
 B.S., Clark University, 1971;
 M.B.A., Anna Maria College, 1979.

STEVE B. J. DESY (1993)
Campus Police Sergeant
 B.S., Eastern New Mexico University, 1989;
 M.A., Clark University, 2001.

MICHAEL W. ELLSWORTH (1999)
Campus Police Sergeant
 B.S., Worcester State College, 1979;
 M.A., Anna Maria College, 1991.

BARBARA J. FORTE (2002)
Assistant Director of Human Resources
 B.S., Rogers Williams University, 2002.

SADIE C. GOESCH (1990)
Administrative Services Manager

JANE GRANT (2001)
Events Manager
 B.A., Clark University, 1980.

JOHN J. HANLON, JR. (1990)
Director of Public Safety
 B.S., Clark University, 1975;
 M.S., American International College, 1978.

YVONNE D. HARRIS (1988)
Finance Projects Manager
 B.S., Central Connecticut State University, 1985
 M.B.A., Nichols College, 1997.

A. TRACY HASSETT (1998)
Director of Human Resources
 B.S., Roger Williams University, 2002.

NORMAN F. HUTCHINS (2001)
Mechanical Operations Supervisor

SUSAN E. JENNINGS (2001)
Payroll Manager
 B.S.B.A., Anna Maria College, 1981.

JAMES F. KENARY (1981)
Assistant Events Manager

RONALD F. KLOCEK (1988)
Manager of Grounds and Properties
 A.A., Central New England College, 1983.

ROBERT KOZLOWSKI (1986)
Manager of Contracts and Construction

JOSEPH M. KRASKOUSKAS (1995)
Director, Dining Services
(Chartwell's)

ELLYN McCORMICK (1996)
Manager, Bookstore
B.S. Towson University, 1998.

CELIA McLAREN (1987)
Supervisor, Mail Services

DAVID H. MESSIER (1982)
Environmental & Occupational Safety Manager
A.S., Quinsigamond Community College, 1993.

THOMAS MOREAU (1986)
Supervisor of Custodians
A.S., Becker Junior College, 1977.

MARLYN MYERS (1976)
Plant Services-Manager of Properties

TERRENCE J. PELLERIN (1981)
Associate Director of Physical Plant

ROBERT C. PEPIN (1985)
Supervisor of Custodians

MURIEL F. PERRA (1971)
Events Coordinator

CLARENCE PLANT (1985)
Property Administrator
CPPM, CF

H. JURGEN RING (1980)
Campus Police Sergeant

RICHARD J. ROGAN
Associate Controller/Director of Accounting Operations
B.B.A., UMass, 1981;
M.S., Bentley, 1981; CPA, 1984.

DENISE ROULEAU (1996)
Manager, Sponsored Research Accounting
B.S., Nichols College, 1990.

CHRISTOPHER L. SALTER (1998)
Manager of Technical Trades
B.S., University of Massachusetts, 1974.

ANN S. SCHLICKMANN (1982)
Director of Administrative Services
B.A., Regis College, 1963.

ELISIA R. STAFFORD (1993)
Manager, Student Loans

PAUL S. TARMASEWICZ (1979)
Supervisor of Maintenance and Operations;
Information Systems Supervisor

JUDITH L. TRAINOR (1987)
Director of Budget and Financial Systems
B.A., Smith College, 1971;
M.A., University of Connecticut, 1973;
M.B.A., Babson College, 1983; CPA, 1986.

JANET L. WHITTIER (1964)
Accounting Manager
Salter Secretarial School, 1964.

LUANNE ZINGARELLI (1998)
Treasury Administrator

OFFICE OF THE VICE PRESIDENT FOR INFORMATION TECHNOLOGY

THOMAS J. LYNCH III (1998)
Vice President for Information Technology and
Chief Information Officer
B.S., University of Cincinnati, 1972;
S.M., Massachusetts Institute of Technology, 1974;
E.E., Massachusetts Institute of Technology, 1975;
PH.D. Massachusetts Institute of Technology, 1981.

CHARLES R. ANDERSON (1999)
Network Engineer
B.S., Worcester Polytechnic Institute, 1999.

DEBRA L. BABINEAU (1995)
Academic Systems Trainer
B.A., University of Massachusetts, Amherst, 1992.

KEITH E. BABUSZCZAK (2001)
Graphics Coordinator
B.F.A., Sam Houston State University, 1996.

JON BARTELSON (1998)
Administrative Computer Systems Manager/
Technical Specialist
B.S., Worcester Polytechnic Institute, 2001.

JOANNE BELLER (1980)
Reference Librarian
B.S.Ed., Framingham State College, 1975;
M.L.S., Simmons College, 1980.

WALTER G. BERTRAND (1994)
Manager of Telecommunications

DEBORAH A. BOCKUS (1989)
Access Services Librarian
A.A., Mount Wachusett Community College, 1986;
B.S., Worcester State College, 1989.

JOSHUA T. BRANDT (2000)
Unix Systems Administrator

JUSTIN W. BROOKS (2001)
Systems Administrator
B.S., Rensselaer Polytechnic Institute, 1999.

CARMEN M. BROWN (1967)
Associate Director; Head of Public Services
B.A., James Millikin University, 1963;
M.S.L.S., University of Illinois, 1965.

- LORA T. BRUECK (1974)
Collection Management Librarian
B.A., University of Massachusetts, 1969;
M.L.S., Spalding College, 1970.
- ELIZABETH S. CASH (2002)
Web Developer
B.S., Worcester Polytechnic Institute, 2002.
- THOMAS L. COLLINS, III (2001)
PC/LAN Desktop Administrator
B.S., Worcester Polytechnic Institute, 2001.
- CHRISTOPHER COX (1998)
Reference/Instruction Librarian
B.A., Susquehanna University, 1991;
M.A., University of Connecticut, 1994;
M.L.S., SUNY at Albany, 1998.
- PAULA M. DELANEY (2001)
Administrative Applications Manager
B.S., Worcester Polytechnic Institute, 1976.
- MARIE DIRUZZA (1997)
Manager of Desktop Services
B.A., Our Lady of the Elms College, 1992.
- ROGER A. DONAHUE (1987)
Database Administrator
A.A., Worcester Industrial Technical Institute, 1974.
- BRUCE M. FIENE (2000)
Production Manager
B.F.A., Massachusetts College of Art, 1989.
- DAVID W. GALVIN (1973)
Administrative Database Technical & Project Support Specialist
- JOSEPH D. GARREPY (2000)
Information Systems Specialist/Analyst Programmer
- MARTHA GUNNARSON (1987)
Serials Librarian
A.B., Clark University, 1972;
M.L.S., Simmons College, 1976.
- MARY BETH HARRITY (1989)
Operations Manager
A.B., College of the Holy Cross, 1979;
M.Ed., University of Massachusetts, 1984.
- STEPHEN W. HEMMING (2002)
Manager, Campus Media Services
B.A., Ithaca College, 1981.
- THOMAS HERBERT (2000)
Information Systems Specialist/Analyst Programmer
B.A., Berklee College, 1972.
- LISA ISLEB (2000)
Instructional Designer & Manager, Educational Technology Services
B.S., Bridgewater State College, 1987;
M.S., Florida Institute of Technology, 1991.
- ALLAN E. JOHANNESSEN (1970)
Director of Internetworking and Telecommunications
B.S., Worcester Polytechnic Institute, 1968.
- DIANA J. JOHNSON (1961)
Reference and Interlibrary Loan Librarian
A.B., Radcliffe College, 1954;
M.S., Simmons College, 1957.
- JOSEPH A. KALINOWSKI (1997)
Senior Systems Administrator
B.S., Worcester Polytechnic Institute, 1999.
- DEBORAH N. KIGULI-BIRIGWA (2001)
Help Desk Support Specialist
B.S., Makerere University, 1982;
Certificate, Boston University, 1993;
CNA Certification, Clark University, 1997.
- JOSEPH M. KRZESZEWSKI (2000)
Network Engineer
B.S., Worcester Polytechnic Institute, 2000.
- VICKI LYNN (2000)
Project Manager
B.S., Bates College, 1972;
M.S., Central Connecticut State College, 1978;
M.B.A., University of Connecticut, 1984.
- AMY L. MARR (1996)
Manager of Web Development
B.S., Worcester Polytechnic Institute, 1996; M.S., 2000.
- JOSHUA McCURDY (2000)
Information Systems Specialist/Analyst Programmer
B.S., University of Rhode Island, 1999.
- PETER McSTRAVICK (2001)
Content Coordinator
B.A.A., Ryerson Polytechnic University, 1990;
B.Ed., University of Toronto, 1995;
M.Ed., University of Ottawa, 2001.
- JULIA MULLEN (2000)
Academic Computing Application Scientist
B.S., Worcester Polytechnic Institute, 1986; Sc.M., 1990;
Sc.M., Brown University, 1992; Ph.D., 1999.
- SIA M. NAJAFI (1995)
Manager of Academic Computing and Departmental Technology Support
B.S., Worcester Polytechnic Institute, 1984; M.S., 1990.
- RODNEY G. OBIEN (2000)
Archivist/Special Collections Librarian
B.A., Virginia Wesleyan College, 1992;
M.L.I.S., Catholic University of America, 1996.
- CHRISTOPHER M. O'CONNOR (2000)
PC/LAN Server Administrator
A.S., Community College of the Air Force, 1989;
B.A., Ohio State University, 1992;
MCSE Certification, Worcester Polytechnic Institute, 2000.
- KERRIE O'CONNOR (1997)
Office Operations Computer Support Services
B.A., College of the Holy Cross, 1992.

SEAN M. O'CONNOR (1997)

Network Manager

B.S., Worcester Polytechnic Institute, 1994;
M.S., Rensselaer Polytechnic Institute, 1998.

AMY E. PARTRIDGE (1984)

Programmer/Analyst

A.A., Colby-Sawyer College, 1978.

CHRISTOPHER J. PINARD (2000)

UNIX System Administrator

DONALD G. RICHARDSON (1976)

Systems/Reference Librarian

B.A., Colby College, 1974;
M.L.S., Simmons College, 1976.

JEFFREY D. SCAMACCA (2000)

Administrative Computer Specialist

B.A., Wesleyan University, 1990.

KEVIN R. SHANAHAN (1978)

Programmer/Analyst

A.A., Worcester Industrial Technical Institute, 1978.

ROBERT M. SHEEHAN (1995)

Programmer/Analyst

PAMELA SHELLEY (2000)

Assistant Director, Advanced Distance Learning Network (ADLN)

B.A., University of Massachusetts, 1971;
M.B.A., Suffolk University, 1981.

HELEN M. SHUSTER (1975)

Director, Library Services

M.A., Edinburgh University, 1958;
M.L.S., Syracuse University, 1974.

ANDREW M. STONE (2001)

New Technologies and Project Specialist

B.S., Worcester Polytechnic Institute, 2001.

FRANK E. SWEETSER (1998)

Network Engineer

B.S., Worcester Polytechnic Institute, 2001.

MARK J. TAYLOR (2001)

UNIX Systems Administrator

UNIX Certification, Worcester Polytechnic Institute, 1996;
Technology Certification, Worcester Polytechnic Institute, 1998.

BENJAMIN R. THOMPSON (1975)

Director of Computing Services

B.S., Worcester Polytechnic Institute, 1973

MICHAEL TONRY (2001)

Help Desk Support Coordinator

A.S., Mount Wachusett Community College, 1992.

TROY B. THOMPSON (1995)

Web Designer

B.S., Worcester Polytechnic Institute, 1995.

PENNIE S. TURGEON (1990)

*Director, Academic Technology Center and
Advanced Distance Learning Network*

B.S., Worcester State College, 1988;
M.B.A., Worcester Polytechnic Institute, 1991.

ANNE M. VALERIO (1996)

Office Operations Computer Support Specialist

B.A., University of Massachusetts, North Dartmouth, 1985.

SARAH WALKOWIAK (2000)

Online Delivery Coordinator

B.S., Worcester Polytechnic Institute, 2000.

OFFICE OF THE VICE PRESIDENT FOR DEVELOPMENT AND UNIVERSITY RELATIONS

JOHN L. HEYL (1996)

Vice President for Development and University Relations

B.A., Trinity College, 1966.

LAURIE W. BOWATER (1997)

Director, Advancement Research

B.S., Worcester State College, 1990.

PATTI-LYNNE M. CAMPOMIZZI (1997)

Director of Advancement Services

B.S., Worcester State College, 1977.

SHARON C. DAVIS (1989)

Senior Development Officer

B.A., State University of New York at Albany, 1966;
M.A., 1970.

ROBERT G. DIETRICH (1985)

Director of Development

B.S., West Virginia Wesleyan College, 1980.

PAMELA A. DiSCIPIO (1990)

Assistant Director of Alumni Relations

B.S., Eastern Nazarene College, 2002.

MICHAEL W. DORSEY (1985)

Director of Communications

B.A., University of Connecticut, 1976.

GEORGE FLETT (2002)

Associate Vice President of Marketing

B.S., University of Connecticut, 1968;
M.B.A., University of Florida, 1972.

ELIZABETH HOWLAND (1998)

Director of Alumni Relations

B.S., University of Vermont, 1984;
M.Ed., University of Connecticut, 1989.

PEGGY L. ISAACSON (1974)

Graphic Designer

Salter Secretarial School, 1958.

LANDY JOHNSON (2000)

Grant Writer for Corporate & Foundation Relations

B.A., University of Chicago, 1979;
M.P.A., Clark University, 1995.

JOAN KILLOUGH-MILLER (1993)

Alumni Editor

B.A., Hamilton College, 1979;

M.A., Syracuse University, 1986.

THERESA J. LEE (2002)

Director of Annual Giving

B.A., University of Maine, 1987;

M.A., Bowling Green State University, 1989.

LINDA C. LOOFT (1996)

Director of External and Government Affairs

B.S., Worcester State College, 1991.

LISA C. MAIZITE (1996)

Director of Capital and Endowed Gifts

B.A., University of Vermont, 1992.

ELEANOR M. MC CREA (1995)

Production Manager, Communications Group

B.S., Worcester State College, 1964;

M.A.T., Assumption College, 1969.

TARA MYERS (2002)

E-Marketing Director

B.A., Boston University, 1997.

ROBERT A. OBORNE (1974)

Senior Advancement Researcher

B.A., UMass Amherst;

M.B.A., Rivier College, 1984.

DANIEL PETROCELLI (1998)

Assistant Director of Planned Giving

B.A., SUNY at Buffalo, 1991;

M.A., Catholic University, 1994.

JENNIFER RIDDELL (2002)

Assistant Director of Alumni Relations

B.A., Simmons College, 1993;

M.S., Northeastern University, 1995.

DENISE R. RODINO (1979)

Executive Director of Corporate and Foundation Relations

B.A., Rutgers University, 1971.

PATRICIA M. SAMSON (2001)

Director of Media Relations

B.A., Connecticut College, 1979.

TERRY SCHMIDT ADAMS (1997)

Director of Corporate Relations &

Assistant Director of Foundation Relations

B.S., Worcester Polytechnic Institute, 1992;

M.B.A., New Hampshire College, 1997.

MICHAEL J. SHERMAN (1987)

Design Director

B.F.A., Johnson State College, 1983.

ELIZABETH B. SILADI (1986-1991) (1996)

Director of Planned Giving

B.A., Colby College, 1981.

JOHN D. WALSH (1996)

Associate Director of Annual Giving

B.A., Suffolk University, 1989.

ROLLY E. WESTER (1996)

Campaign Director

B.A., University of Texas, 1956.

JEAN M. WESTERLIND (1982)

Manager of Donor Relations

A.A., Quinsigamond Community College, 1981.

KEVIN WYNN (2002)

Assistant Director of Media and Community Relations

B.S., University of Massachusetts, 1992;

M.A., Emerson College, 1995.

BARBARA R. ZIFF (1976)

Executive Director, Advancement Operations and Research

B.F.A., Boston University, 1964.

ADMINISTRATORS EMERITI

WILLIAM R. GROGAN (1946-1990)

Dean of Undergraduate Studies Emeritus

and Professor Emeritus

ROBERT J. HALL (1956-1990)

Professor Emeritus

OWEN W. KENNEDY, JR. (1946-1987)

Dean of Academic Computing Emeritus and Professor Emeritus

DONALD N. ZWIEP (1957-1990)

Professor and Department Head Emeritus

ACADEMIC DEPARTMENT HEADS

LTC EDWARD N. IRELAND

Air Force Aerospace Studies

JILL RULFS

Biology and Biotechnology

CHRISTOPHER H. SOTAK

Biomedical Engineering

RAVINDRA DATTA

Chemical Engineering

JAMES P. DITTAMI

Chemistry and Biochemistry

FREDERICK L. HART

Civil and Environmental Engineering

MICHA HOFRI

Computer Science

JOHN A. ORR

Electrical and Computer Engineering

DAVID A. LUCHT (Director)

Fire Protection Engineering

PATRICK J. M. QUINN

Humanities and Arts

McRAE C. BANKS

Management

HOMER F. WALKER

Mathematical Sciences

GRETAR TRYGGVASON

Mechanical Engineering

LTC RICHARD B. O'CONNOR

Military Science

DANA L. HARMON

Physical Education

THOMAS H. KEIL

Physics

KHALID SAEED

Social Science and Policy Studies

FACULTY

(As of December 1, 2002)

Numerals following name indicate year(s) of initial appointment.

DAVID S. ADAMS (1984)

Professor, Biology and Biotechnology

B.S., Oklahoma State University, 1974;

M.S., University of Houston, 1976;

Ph.D., University of Texas, 1979.

WILLIAM A. B. ADDISON, JR. (1986)

Associate Professor of History; Humanities and Arts

B.A., University of South Carolina, 1965;

M.A., University of Virginia, 1967;

M.Phil., Columbia University, 1974; Ph.D., 1986.

EMMANUEL O. AGU (2002)

Assistant Professor, Computer Science

B.Eng., University of Benin, Nigeria, 1994;

M.S., University of Massachusetts/Amherst, 1996;

Ph.D., 2001.

LEONARD D. ALBANO (1992)

Associate Professor, Civil and Environmental Engineering

B.S., Tufts University, 1982;

M.S., Northwestern University, 1983;

Ph.D., Massachusetts Institute of Technology, 1992, P.E.

ANDREAS N. ALEXANDROU (1987)

Professor, Mechanical Engineering

B.S., American University of Beirut, 1982;

M.S., University of Michigan, 1983;

M.S. (C.E.), 1985; Ph.D., 1986.

DIRAN APELIAN (1990)

Professor, Mechanical Engineering;

Howmet Professor of Engineering;

Director, Metal Processing Institute

B.S., Drexel University, 1968;

Sc.D., Massachusetts Institute of Technology, 1972.

PADMANABHAN K. ARAVIND (1984)

Associate Professor, Physics

B.S., Delhi University (India), 1971; M.S., 1973;

Ph.D., Northwestern University, 1980.

JUTTA AREND (1994)

Visiting Assistant Professor of German;

Humanities and Arts

M.A., Case Western Reserve University (CWRU), 1969;

Ph.D., 1973.

JOSÉ M. ARGÜELLO (1996)

Associate Professor, Chemistry and Biochemistry

B.S., National University of Cordoba, 1979;

Ph.D., National University of Rio Cuarto, Argentina, 1986.

HOLLY K. AULT (1983)

Associate Professor, Mechanical Engineering;

Co-Director Design Studio

B.S., Worcester Polytechnic Institute, 1974;

M.S., 1983; Ph.D., 1988.

JOSEPH C. BAGSHAW (1984)

Professor, Biology and Biotechnology

B.A., Johns Hopkins University, 1965;

Ph.D., University of Tennessee - Oak Ridge Graduate

School, 1969.

WILLIAM A. BALLER (1986)

Adjunct Assistant Professor of History;

Humanities and Arts

B.A., Marquette University, 1971;

M.A., Providence College, 1975;

M.S., Columbia University, 1976;

M.A., State University of New York at Albany, 1982;

Ph.D., Clark University, 1994.

McRAE C. BANKS (1995)

Professor, Management; Head of Department

Director, Collaborative for Entrepreneurship and Innovation

B.A., Virginia Tech, 1972;

M.A., Northwestern University, 1973;

Ph.D., Virginia Tech, 1987.

JONATHAN R. BARNETT (1979)

Professor, Fire Protection Engineering;

Professor, Mechanical Engineering

B.S., Worcester Polytechnic Institute, 1974;

M.S., 1976; Ph.D., 1989.

ISA BAR-ON (1982)

Professor, Mechanical Engineering

B.S., Hebrew University of Jerusalem, 1974;

M.S., 1977; Ph.D., 1984.

LEE A. BECKER (1984)

Associate Professor, Computer Science,

and Associate Head of Department

B.A., University of Illinois, 1973; Ph.D., 1978.

JOHN A. BERGENDAHL (2000)

Assistant Professor, Civil and Environmental Engineering

Assistant Professor, Chemical Engineering

B.S., University of Connecticut, 1985; M.S., 1996;

Ph.D., 1998.

CAPT. PETER A. BERUBE (2003)

Assistant Professor, Air Force Aerospace Studies

B.S., Worcester Polytechnic Institute, 1994.

FREDERICK BIANCHI (1994)

Professor of Music; Humanities and Arts
B.A., Cleveland State University, 1980;
M.S., Ball State University, 1982; Ph.D., 1985.

RONALD R. BIEDERMAN (1968)

Professor, Mechanical Engineering
B.S., University of Connecticut, 1960;
M.S., 1962; Ph.D., 1968. P.E.

KRISTEN L. BILLIAR (2002)

Assistant Professor, Biomedical Engineering
B.S., Cornell University, 1991;
M.S., University of Pennsylvania, 1992; Ph.D., 1998.

JOHN J. BLANDINO (2001)

Assistant Professor, Mechanical Engineering
B.S., Rensselaer Polytechnic Institute, 1987;
M.S., Massachusetts Institute of Technology, 1989;
Ph.D., California Institute of Technology, 2001.

YEVGENIY BOGDANOV (2002)

Research Assistant Professor, Bioengineering Institute
B.S., Worcester Polytechnic Institute, 1997; M.S., 1998.

JOEL J. BRATTIN (1990)

Professor of English; Humanities and Arts
A.B., University of Michigan, 1978;
Ph.D., Stanford University, 1985.

CHRISTOPHER A. BROWN (1989)

Professor, Mechanical Engineering;
Director, Manufacturing Engineering Program
B.A., University of Vermont, 1975;
M.S., 1979; Ph.D., 1983.

DAVID C. BROWN (1980)

Professor, Computer Science; Professor,
Mechanical Engineering
B.S., North Staffordshire Polytechnic, 1970;
M.S., University of Kent at Canterbury, 1974;
M.S., Ohio State University, 1976; Ph.D., 1984.

DONALD R. BROWN (2000)

Assistant Professor, Electrical and Computer Engineering;
B.S., University of Connecticut, 1992; M.S., 1996;
Ph.D., Cornell University, 2000.

STEVEN C. BULLOCK (1989)

Professor of History; Humanities and Arts
B.A., Houghton College, 1978;
M.A., SUNY-Binghamton, 1980;
A.M., Brown University, 1982; Ph.D., 1986.

NANCY A. BURNHAM (2000)

Associate Professor, Physics
B.A., Colgate University, 1980;
M.S., University of Colorado, 1985; Ph.D., 1987.

TERRI ANNE CAMESANO (2000)

Assistant Professor, Chemical Engineering
B.S., University of Rochester, 1995;
M.S., University of Arizona, 1997;
Ph.D., Pennsylvania State University, 2000.

JOHN F. CARNEY III (1996)

Professor, Civil and Environmental Engineering; Provost
and Vice President for Academic Affairs
B.S., Merrimack College, 1963;
M.S., Northwestern University, 1964; Ph.D., 1966; P.E.

RONALD D. CHEETHAM (1973)

Professor, Biology and Biotechnology
B.A., University of Minnesota, 1965; M.S., 1967;
Ph.D., Purdue University, 1970.

PETER R. CHRISTOPHER (1963)

Professor, Mathematical Sciences
A.B., Clark University, 1959; M.A., 1963; Ph.D., 1982.

MICHAEL J. CIARALDI (1999)

Professor of Practice, Computer Science
B.A., Cornell University, 1973;
M.S., Rochester Institute of Technology, 1979;
M.S., University of Rochester, 1983.

EDWARD A. CLANCY (2000)

Assistant Professor, Electrical and Computer Engineering
Assistant Professor, Biomedical Engineering
B.S., Worcester Polytechnic Institute, 1983;
M.S., Massachusetts Institute of Technology, 1987;
Ph.D., 1991.

WILLIAM M. CLARK (1986)

Associate Professor, Chemical Engineering
B.S., Clemson University, 1979;
Ph.D., Rice University, 1984.

MARK L. CLAYPOOL (1998)

Assistant Professor, Computer Science
B.A., Colorado College, 1990;
M.S., University of Minnesota, 1993; Ph.D., 1996.

KEVIN A. CLEMENTS (1970)

Professor, Electrical and Computer Engineering
B.E.E., Manhattan College, 1963;
M.S., Polytechnic Institute of Brooklyn, 1966; Ph.D., 1970.

EBEN C. COBB (1995)

Visiting Assistant Professor, Mechanical Engineering
B.S., Norwich University, 1977;
M.S., University of Wisconsin, 1978;
M.S., Boston University, 1981;
Ph.D., University of Connecticut, 1985.

TREVOR CODE (1997)

Adjunct Professor of English; Humanities and Arts
B.A., University of Melbourne, 1965; M.A., 1975.

ROBERT E. CONNORS (1976)

Professor, Chemistry and Biochemistry
B.S., University of Massachusetts, 1967;
Ph.D., Northeastern University, 1972.

THEODORE C. CRUSBERG (1969)

Associate Professor, Biology and Biotechnology
B.A., University of Connecticut, 1963;
M.S., Yale University, 1964;
Ph.D., Clark University, 1968.

- LOUIS J. CURRAN, JR. (1966)
Associate Professor of Music; Humanities and Arts
B.Mus., Yale University, 1956;
M.Mus., University of Tulsa, 1963.
- DAVID CYGANOSKI (1976)
Professor, Electrical and Computer Engineering
B.S., Worcester Polytechnic Institute, 1975;
M.S., 1976; Ph.D., 1981.
- ROBERT A. D'ANDREA (1974)
Associate Professor, Civil and Environmental Engineering
B.S., University of Rhode Island, 1964; M.S., 1966;
Ph.D., Cornell University, 1980. P.E.
- ERWIN DANNEELS (2000)
Assistant Professor, Management
B.A., University of Ghent (Belgium), 1990; M.B.A., 1991;
M.S., University of California/Davis, 1994;
Ph.D., Pennsylvania State University, 1998.
- RAVINDRA DATTA (1998)
Professor Chemical Engineering, and Head of Department
B.T., Indian Institute of Technology (India), 1972;
Ph.D., University of California, 1981.
- PAUL W. DAVIS (1970)
Professor, Mathematical Sciences;
Dean, Interdisciplinary and Global Studies Division
B.S., Rensselaer Polytechnic Institute, 1966;
M.S., 1967; Ph.D., 1970.
- NICHOLAS A. DEMBSEY (1995)
Associate Professor, Fire Protection Engineering
B.S., University of Michigan, 1986
M.S., University of California at Berkeley, 1988; Ph.D., 1995.
- MICHAEL A. DEMETRIOU (1997)
Assistant Professor, Mechanical Engineering
B.S., University of Southern California, 1987; M.S., 1989;
M.S., 1990; Ph.D., 1993.
- CHRYSANTHE DEMETRY (1993)
Associate Professor, Mechanical Engineering
B.S., Worcester Polytechnic Institute, 1988;
Ph.D., Massachusetts Institute of Technology, 1993.
- DAVID DIBIASIO (1980)
Associate Professor, Chemical Engineering
B.S., Purdue University, 1972; M.S., 1977; Ph.D., 1980.
- MIKHAIL F. DIMENTBERG (1994)
Professor, Mechanical Engineering
M.S.C., Moscow Institute of Power Engineering, 1958;
Ph.D., 1963; Doctor of Technical Sciences, 1971.
- JAMES P. DITTAMI (1985)
Professor, Chemistry and Biochemistry,
and Head of Department
B.A., College of The Holy Cross, 1975;
M.S., Boston College, 1978;
Ph.D., Rensselaer Polytechnic Institute, 1983.
- ANTHONY G. DIXON (1980)
Professor, Chemical Engineering
B.S., Edinburgh University, 1975; Ph.D., 1978.
- DAVID B. DOLLENMAYER (1990)
Professor of German; Humanities and Arts
B.A., Princeton University, 1967; Ph.D., 1977.
- DANIEL J. DOUGHERTY (2002)
Professor, Computer Science
B.A., University of Maryland, 1974; Ph.D., 1982.
- JAMES K. DOYLE (1992)
Associate Professor, Social Science and Policy Studies
B.A., University of California/Berkeley, 1982;
M.A., University of Colorado/Boulder, 1990; Ph.D., 1991.
- BOGDAN D. DOYTCHINOV (1999)
Assistant Professor, Mathematical Sciences
M.S., Moscow State University, 1987;
M.S., Carnegie Mellon University, 1994; Ph.D., 1997.
- R. JAMES DUCKWORTH (1987)
Associate Professor, Electrical and Computer Engineering
B. Eng., Bradford University, 1981;
Ph.D., Nottingham University, 1984.
- WILLIAM W. DURGIN (1971)
Professor, Mechanical Engineering; Associate Provost for
Academic Affairs
Sc.B., Brown University, 1964;
M.S., University of Rhode Island, 1966;
Ph.D., Brown University, 1970. P.E.
- TAHAR EL-KORCHI (1987)
Professor, Civil and Environmental Engineering
B.S., University of New Hampshire, 1980,
M.S., 1982; Ph.D., 1986.
- MICHAEL B. ELMES (1990)
Professor, Management
B.S., Union College, 1975;
M.A., Colgate University, 1979;
Ph.D., Syracuse University, 1989.
- ALEXANDER E. EMANUEL (1974)
Professor, Electrical and Computer Engineering
B.S., Technion, Israel Institute of Technology (Haifa),
1963; M.S., 1965; D.Sc., 1969. P.E.
- MICHELLE EPHRAIM (1999)
Assistant Professor of English; Humanities and Arts
B.A., Tufts University, 1991;
M.A., University of Wisconsin, Madison, 1993;
Ph.D., 1998.
- CRAIG D. FAIRCHILD (2000)
Assistant Professor, Chemistry and Biochemistry
B.S., Yale University, 1984;
Ph.D., University of California/Berkeley, 1993.
- WILLIAM W. FARR (1989)
Associate Professor, Mathematical Sciences;
Associate Head of Department
B.S., University of California - Davis, 1975;
M.A., University of California - Los Angeles, 1981;
Ph.D., University of Minnesota, 1986.

- JOSEPH D. FEHRIBACH (1992)
Associate Professor, Mathematical Sciences
B.A., Centre College, 1980;
M.A., Duke University 1982; Ph.D., 1985.
- DAVID FINKEL (1988)
Professor, Computer Science
B.A., Temple University, 1966;
M.S., University of Chicago, 1967; Ph.D., 1971.
- KATHRYN FISLER (2000)
Assistant Professor, Computer Science
B.A., Williams College, 1991;
M.S., Indiana University, 1992; Ph.D., 1996.
- ROBERT W. FITZGERALD (1963)
Professor, Civil and Environmental Engineering;
Professor, Fire Protection Engineering
B.S., Worcester Polytechnic Institute, 1953; M.S., 1960;
Ph.D., University of Connecticut, 1969. P.E.
- MALCOLM S. FITZPATRICK (1977)
Associate Professor, Civil and Environmental Engineering
B.S., Yale University, 1959, B.E., 1960;
M.S., Stanford University, 1961;
M.S., Harvard University, 1965; M.C.P., 1968, Ph.D., 1975.
- MUSTAPHA S. FOFANA (1997)
Assistant Professor, Mechanical Engineering
B.S./M.S., Budapest Technical University, 1986;
M.A.S., University of Waterloo, 1989; Ph.D., 1993.
- JEFFREY L. FORGENG (1999)
Adjunct Associate Professor of History; Humanities and Arts;
The Paul S. Morgan Curator, The Higgins Armory Museum
B.A., Brown University, 1983;
M.A., Centre for Medieval Studies,
University of Toronto, 1985; Ph.D., 1991.
- NIKOLAOS A. GATSONIS (1994)
Associate Professor, Mechanical Engineering;
Director, Aerospace Engineering Program
B.S., Aristotelian University of Thessaloniki, 1983;
M.S., University Michigan, 1986;
M.S., Massachusetts Institute of Technology, 1987;
Ph.D., 1991.
- MICHAEL A. GENNERT (1987)
Associate Professor, Computer Science
S.M.E.E., S.B.C.S., S.B.E.E., Massachusetts Institute of
Technology, 1980; Sc.D., 1987.
- TIMOTHY R. GERRITY (2002)
Director, Bioengineering Institute; Research Professor,
Biomedical Engineering
B.S., University of Illinois, Chicago, 1972; M.S., 1974;
Ph.D., 1978.
- ARTHUR GERSTENFELD (1976)
Professor, Management
B.M.E., Rensselaer Polytechnic Institute, 1950;
M.S., Massachusetts Institute of Technology, 1966;
Ph.D., 1967.
- DANIEL G. GIBSON III (1983)
Assistant Professor, Biology and Biotechnology
B.A., Stanford University, 1966;
M.A., College of William and Mary, 1969;
Ph.D., Boston University, 1980.
- ROGER S. GOTTLIEB (1981)
Professor of Philosophy; Humanities and Arts
B.A., Brandeis University, 1968; Ph.D., 1975.
- DEBORAH E. GRAY (1991)
Part-time Instructor of History; Humanities and Arts
B.A., Elmira College, 1971;
M.A., Clark University, 1989.
- PHILIP J. GREBINAR (1972)
Associate Professor, Physical Education and Athletics;
Head Coach, Wrestling
B.S., State University College at Cortland, 1971;
M.S., 1972.
- WILLIAM R. GROGAN (1946)
Professor Emeritus, Electrical and Computer Engineering;
Dean of Undergraduate Studies Emeritus
B.S., Worcester Polytechnic Institute, 1945; M.S., 1949.
- RAYMOND R. HAGGLUND (1956)
Professor, Mechanical Engineering
B.S., Worcester Polytechnic Institute, 1956; M.S., 1959;
Ph.D., University of Illinois, 1962. P.E.
- HOSSEIN HAKIM (1984)
Associate Professor, Electrical and Computer Engineering
B.S.E.E., Arya Mehr University (Iran), 1975;
M.S.E.E., Purdue University, 1977; Ph.D., 1982.
- JAMES P. HANLAN (1975)
Associate Professor of History; Humanities and Arts
A.B., College of the Holy Cross, 1967;
M.A., Clark University, 1971; Ph.D., 1979.
- PETER H. HANSEN (1992)
Associate Professor of History; Humanities and Arts
B.A., Carleton College, 1984;
M.A., Harvard University, 1986; Ph.D., 1991.
- FREDERICK L. HART (1974)
Professor, Civil and Environmental Engineering, and
Head of Department
B.S.E., University of Connecticut, 1969;
M.S., 1971; Ph.D., 1974.
- GEORGE HEATON (1986)
Adjunct Associate Professor, Management; Adjunct
Associate Professor, Social Science and Policy Studies
B.S., University of Pennsylvania, 1969;
J.D., Boston university, 1974.
- NEIL T. HEFFERNAN (2002)
Assistant Professor, Computer Science
B.A., Amherst College, 1993;
M.S., Carnegie Mellon University, 1998; Ph.D., 2001.
- GEORGE T. HEINEMAN (1996)
Associate Professor, Computer Science
B.A., Dartmouth College;
M.S., Columbia University; Ph.D., 1996.

- ARTHUR C. HEINRICHER, JR. (1992)
Associate Professor, Mathematical Sciences
B.S., University of Missouri/St. Louis, 1980;
Ph.D., Carnegie Mellon University, 1986.
- HUONG NGO HIGGINS (1998)
Assistant Professor, Management
B.A., (French), University of Ho Chi Minh City, 1990;
B.A., (English), 1990;
M.A., Georgia State University, 1996; Ph.D., 1998.
- LTC SCOTT H. HILL (2000)
Professor, Aerospace Studies
B.S., Norwich University, 1982;
M.A., Troy State University, 1990;
M.S., University of Alaska, 1993.
- WILLIAM D. HOBAY (1963)
Associate Professor, Chemistry and Biochemistry
B.S., Tufts University, 1957;
Ph.D., California Institute of Technology, 1962.
- ALLEN H. HOFFMAN (1970)
Professor, Mechanical Engineering
B.S., Worcester Polytechnic Institute, 1963; M.S., 1967;
Ph.D., University of Colorado, 1970. P.E.
- MICHA HOFRI (1998)
Professor Computer Science, and Head of Department
B.S., Technion–IIT (Haifa), 1964; M.S., 1965; D.Sc., 1972.
- ZHIKUN HOU (1991)
Associate Professor, Mechanical Engineering
B.S., Fudan University, 1974;
M.S., Tongji University, 1981;
M.S., California Institute of Technology, 1986;
Ph.D., 1990.
- MAYER HUMI (1971)
Professor, Mathematical Sciences
B.S., Hebrew University of Jerusalem, 1963; M.S., 1964;
Ph.D., Weizmann Institute of Science, 1969.
- GERMANO S. IANNACCHIONE (1998)
Assistant Professor, Physics
B.S., University of Akron, 1987; M.S., 1990;
Ph.D., Kent State University, 1993.
- STEPHEN N. JASPERSON (1970)
Professor, Physics
B.S., University of Wisconsin, 1963;
M.A., Princeton University, 1965; Ph.D., 1968.
- PARAMASIVAM JAYACHANDRAN (1977)
Associate Professor, Civil and Environmental Engineering
B.E., University of Madras (India), 1966;
M.S., University of Wisconsin, 1971; Ph.D., 1975.
- HAMID JOHARI (1989)
*Professor, Mechanical Engineering, and
Associate Department Head*
B.S., California Institute of Technology, 1983;
M.S., University of Washington, 1984; Ph.D., 1989.
- SHARON A. JOHNSON (1988)
*Associate Professor, Management;
Director of Industrial Engineering Program*
B.S., University of Michigan, 1983;
M.S., Cornell University, 1986; Ph.D., 1989.
- CHICKERY J. KASOUF (1990)
Associate Professor, Management
B.A., Providence College, 1975;
M.B.A., Syracuse University, 1985; Ph.D., 1991.
- ROBERT N. KATZ (1990)
Research Professor, Mechanical Engineering
B.S., Massachusetts Institute of Technology, 1961;
M.S., University of Michigan, 1963;
Ph.D., Massachusetts Institute of Technology, 1969.
- NIKOLAOS KAZANTZIS (2001)
Assistant Professor, Chemical Engineering
B.S., University of Thessaloniki, Greece, 1990;
M.S., University of Michigan, 1992; M.S.E., 1993;
Ph.D., 1997.
- THOMAS H. KEIL (1967)
Professor, Physics, and Head of Department
B.S., California Institute of Technology, 1961;
Ph.D., University of Rochester, 1965.
- NICHOLAS K. KILDAHL (1976)
Professor, Chemistry and Biochemistry
B.S., Purdue University, 1968;
Ph.D., University of Illinois at Urbana, 1973.
- BRIAN KING (2002)
Assistant Professor, Electrical and Computer Engineering
B.S., Worcester Polytechnic Institute, 1993; M.S., 1995;
Ph.D., University of Arizona, 2000.
- ROBERT E. KINICKI (1978)
Associate Professor, Computer Science
B.S., Case Western Reserve University, 1968;
M.S., Indiana University, 1975;
Ph.D., Duke University, 1978.
- CAROLANN KOLECI (2001)
Assistant Professor, Physics
B.S., State University of New York/Albany, 1994;
M.S., Brown University, 1996; M.S., 1998; Ph.D., 2001.
- ROBERT C. LABONTÉ (1997)
Professor of Practice, Electrical and Computer Engineering
B.S., Worcester Polytechnic Institute, 1954; M.S., 1960.
- CHRISTOPHER J. LARSEN (1996)
Assistant Professor, Mathematical Sciences
B.S., Carnegie Mellon University, 1989;
J.D., University of Maryland School of Law, 1992;
M.S., Carnegie Mellon University; Ph.D., 1996.
- KAREN A. LEMONE (1981)
Associate Professor, Computer Science
B.A., Tufts University, 1964;
M.S., Boston College, 1972;
Ph.D., Northeastern University, 1979.

LOK C. LEW YAN VOON (1997)

Associate Professor, Physics
B.A., Robinson College, University of Cambridge, England, 1987; M.A., 1991;
M.S., University of British Columbia, 1989;
Ph.D., Worcester Polytechnic Institute, 1993.

KENT P. LJUNGQUIST (1977)

Professor of English; Humanities and Arts
B.A., Clark University, 1970;
M.A., University of Connecticut, 1972;
Ph.D., Duke University, 1975.

ELEANOR T. LOIACONO (2000)

Assistant Professor, Management
B.A., Boston University, 1992;
M.B.A., Boston College, 1996;
Ph.D., University of Georgia, 2000.

FRED J. LOOFT III (1980)

Professor, Electrical and Computer Engineering, and Associate Head of Department;
Professor, Biomedical Engineering;
B.S., University of Michigan, 1973;
M.S., 1974, 1976; Ph.D., 1979.

DAVID A. LUCHT (1978)

Director, Center for Firesafety Studies;
Professor, Fire Protection Engineering
B.S., Illinois Institute of Technology, 1965. P.E.

REINHOLD LUDWIG (1986)

Professor, Electrical and Computer Engineering;
Professor, Biomedical Engineering;
Diplom-Ingenieur, University of Wuppertal (West Germany), 1983;
Ph.D., Colorado State University, 1986.

ROGER YIN-MAN LUI (1983)

Professor, Mathematical Sciences
B.S., University of Minnesota, 1975; Ph.D., 1981.

KONSTANTIN A. LURIE (1989)

Professor, Mathematical Sciences
M.Sc., Leningrad Polytechnical Institute (USSR), 1959;
Ph.D., A.F. Ioffe Physical-Technical Institute, Academy of Sciences (USSR), 1964; D.Sc., 1972.

JAMES M. LYNEIS (2002)

Professor of Practice, Social Science and Policy Studies
S.B., Massachusetts Institute of Technology, 1971;
Ph.D., University of Michigan, 1974.

YI H. MA (1967)

Professor, Chemical Engineering
B.S., National Taiwan University, 1959;
M.S., University of Notre Dame, 1963;
Sc.D., Massachusetts Institute of Technology, 1967.

JOHN C. MACDONALD (2001)

Assistant Professor, Chemistry
B.A., Bowdoin College, 1987;
Ph.D., University of Minnesota, 1993.

SERGEY N. MAKAROV (2000)

Associate Professor, Electrical and Computer Engineering
M.S., St. Petersburg State university (Russia), 1982;
Ph.D., 1986.

MAKHLOUF M. MAKHLOUF (1989)

Associate Professor, Mechanical Engineering;
Director, Aluminum Casting Research Laboratory
B.S., American University (Cairo), 1978;
M.S., New Mexico State University, 1981;
Ph.D., Worcester Polytechnic Institute, 1989.

CAPT JAMIE A. MAKI (2000)

Assistant Professor, Aerospace Studies
B.S., Clarkson University, 1994.

RAJIB B. MALLICK (1998)

Assistant Professor, Civil & Environmental Engineering
B.S., Jadavpur University (India), 1989;
M.S., Auburn University, 1993; Ph.D., 1997.

JO ANN MANFRA (1972)

Professor of History; Humanities and Arts
B.S., State University of New York at Cortland, 1963;
M.S., 1967; Ph.D., University of Iowa, 1975;
J.D., Suffolk University Law School, 1977;
LL.M., Harvard Law School, 1979.

H. J. MANZARI (2001)

Assistant Professor, Spanish; Humanities & Arts
B.A., Hobart College, 1991;
M.A., Pennsylvania State University, 1993;
M.A., University of Virginia, 1995; Ph.D., 2001.

MAJ PHILIP S. MARTIN (2001)

Assistant Professor, Military Science
M.A., Illinois State University, 2001.

WILLIAM J. MARTIN (2000)

Associate Professor, Mathematical Sciences
B.A., State University of New York/Potsdam, 1986;
M.A., 1986;
Ph.D., University of Waterloo (Canada), 1992.

PAUL P. MATHISEN (1993)

Professor, Civil and Environmental Engineering
B.S., University of Massachusetts, 1984;
S.M., Massachusetts Institute of Technology, 1989;
Ph.D., 1993.

STEPHEN L. MATSON (2001)

Francis Manning Chaired Professor, Chemical Engineering
B.S., Cornell University, 1971; M.S., 1974;
Ph.D., University of Pennsylvania, 1979.

SCOTT McCOY (2002)

Assistant Professor, Mechanical Engineering
B.A., Flagler College, 1992;
M.S., Middle Tennessee State University, 1994;
Ph.D., University of Pittsburgh, 2002.

W. GRANT Mc GIMPSEY (1989)

Professor, Chemistry and Biochemistry
B.S., Brock University (Canada), 1978; M.S., 1981;
Ph.D., Queen's University (Canada), 1985.

- JOHN A. Mc NEILL (1994)
Associate Professor, Electrical and Computer Engineering
A.B., Dartmouth College, 1983;
M.S., University of Rochester, 1991;
Ph.D., Boston University, 1994.
- YITZHAK MENDELSON (1983)
Associate Professor, Biomedical Engineering
B.S., State University of New York at Buffalo, 1975;
M.S., 1976;
Ph.D., Case Western Reserve University, 1983.
- LAURA J. MENIDES (1976)
Professor of English; Humanities and Arts
B.A., City University of New York, 1959;
M.A., University of Chicago, 1964;
Ph.D., New York University, 1978.
- WILLIAM R. MICHALSON (1992)
Associate Professor, Electrical and Computer Engineering
B.S. E.E., Syracuse University, 1981;
M.S., Worcester Polytechnic Institute, 1985; Ph.D., 1989.
- JUDITH E. MILLER (1978)
Professor, Biology and Biotechnology
B.S., Cornell University, 1973;
Ph.D., Case Western Reserve University, 1978.
- JAMSHED J. MISTRY (1999)
Assistant Professor, Management
B. Com., Poona University (India), 1976;
B.S., Purdue University, 1983;
M.B.A., University of Utah, 1984;
D.B.A., Boston University, 1999.
- YONG-MO MOON (2002)
Assistant Professor, Mechanical Engineering
B.S., Yonsei University (Seoul, Korea), 1993; M.S., 1995;
Ph.D., University of Michigan, 2000.
- CARLOS J. MORALES (2002)
Assistant Professor, Mathematical Sciences
B.A., University of Houston, 1992; M.A., 1995;
Ph.D., Boston University, 2002.
- WESLEY T. MOTT (1987)
Professor of English; Humanities and Arts
A.B., Boston University, 1968; A.M., 1969; Ph.D., 1974.
- KANKANA MUKHERJEE (2002)
Assistant Professor, Mechanical Engineering
B.A., North Eastern Hill University (India), 1983;
MA, 1985; M.Phil., 1989;
M.A., University of Connecticut, 1992; Ph.D., 1997.
- BALGOBIN NANDRAM (1989)
Associate Professor, Mathematical Sciences
B.Sc., University of Guyana, 1977, Dip. Ed., 1979;
M.Sc., University of London, Imperial College, 1981;
Ph.D., University of Iowa, 1989.
- FRANCIS NOONAN (1978)
Associate Professor, Management;
Associate Professor, Fire Protection Engineering
B.S., Boston College, 1963;
M.S., Northeastern University, 1967;
Ph.D., University of Massachusetts, 1973.
- ROBERT L. NORTON (1981)
Professor, Mechanical Engineering
B.S., Northeastern University, 1967;
M.S., Tufts University, 1970. P.E.
- JOHN T. O'CONNOR (1970)
Professor, Social Science and Policy Studies;
Professor, Management
A.B., College of the Holy Cross, 1960;
M.B.A., The Wharton School, 1962;
Ph.D., University of Notre Dame, 1970;
M.P.H., Harvard University, 1975.
- LTC RICHARD B. O'CONNOR (2002)
Professor, Military Science, and Head of Department
B.S., Northeastern University, 1985;
M.S., Naval Postgraduate School, 1993.
- CAPT RICHARD J. OFCARCIK (2001)
Air Force ROTC Regional Director of Admissions,
Aerospace Studies
M.S., Embry Riddle Aeronautical University, 2000.
- DAVID J. OLINGER (1990)
Associate Professor, Mechanical Engineering
B.S., Lafayette College, 1983;
M.S., Rensselaer Polytechnic Institute, 1985;
M.S., Yale University, 1988; Ph.M., 1988; Ph.D., 1990.
- JOHN A. ORR (1977)
Professor, Electrical and Computer Engineering, and
Head of Department
B.S., University of Illinois, 1969;
M.S., Stanford University, 1970;
Ph.D., University of Illinois, 1977.
- JAMES C. O'SHAUGHNESSY (1986)
Professor, Civil and Environmental Engineering
B.S., University of New Hampshire, 1965;
M.S., Pennsylvania State University, 1970; Ph.D., 1973.
- KAVEH PAHLAVAN (1985)
Professor, Electrical and Computer Engineering; Professor,
Computer Science
M.S., University of Teheran, 1975;
Ph.D., Worcester Polytechnic Institute, 1979.
- DEMETRIOS P. PAPAGEORGIOU (2002)
Assistant Professor, Electrical and Computer Engineering
B.S., University of Michigan, 1995; M.S., 1997; Ph.D., 2001.
- EDWARD ALTON PARRISH (1995)
President of the Institute; Professor, Electrical and
Computer Engineering
B.S., University of Virginia, 1964; M.S., 1966; Ph.D., 1968.
- E. MALCOLM PARKINSON (1974)
Associate Professor of History; Humanities and Arts
B.S., Queen's University of Belfast, 1963;
Ph.D., Belfast, 1966;
M.A., Princeton University, 1970.
- JAMES W. PAVLIK (1974)
Professor, Chemistry and Biochemistry
A.B., Carthage College, 1959;
M.S., Virginia Polytechnic and State University, 1961;
Ph.D., George Washington University, 1970.

- OLEG V. PAVLOV (2002)
Assistant Professor, Social Science and Policy Studies
B.S., University of Southern California, 1994; Ph.D., 2000.
- PEDER C. PEDERSEN (1987)
Professor, Electrical and Computer Engineering;
Professor, Biomedical Engineering
B.S., Aalborg Engineering College, 1971;
M.E., University of Utah, 1974; Ph.D., 1976.
- CREIGHTON PEET (2000)
Program Coordinator/Adjunct Assistant Professor,
Interdisciplinary and Global Studies Division
B.A., Harvard College, 1966;
P.Phil., Columbia University, 1978; Ph.D., 1978.
- JOSEPH D. PETRUCCELLI (1978)
Professor, Mathematical Sciences
A.B., Boston College, 1971;
M.S., Purdue University, 1974; Ph.D., 1978.
- ROBERT A. PEURA (1968)
Professor, Biomedical Engineering; Professor,
Electrical and Computer Engineering
B.S., Worcester Polytechnic Institute, 1964;
M.S., Iowa State University, 1967; Ph.D., 1969.
- GEORGE D. J. PHILLIES (1985)
Professor, Physics
S.B., Massachusetts Institute of Technology, 1969,
M.S., 1971; D.Sc., 1973.
- STEPHEN W. PIERSON (1995)
Assistant Professor, Physics
B.A., Concordia College, 1988
Ph.D., University of Minnesota, 1993
- ROBERTO PIETROFORTE (1992)
Associate Professor, Civil and Environmental Engineering
Laurea University of Rome, 1974;
M.S., Massachusetts Institute of Technology, 1987;
M.S., 1987; Ph.D., 1992.
- GEORGE D. PINS (2000)
Assistant Professor, Biomedical Engineering
B.S., Rutgers College of Engineering, 1989;
Ph.D., Rutgers University, 1996.
- JEANINE D. PLUMMER (1999)
Assistant Professor, Civil & Environmental Engineering
B.S., Cornell University, 1993;
M.S., University of Massachusetts/Amherst, 1995;
Ph.D., 1999.
- SAMUEL M. POLITZ (1988)
Associate Professor, Biology and Biotechnology
B.S., Louisiana State University, 1973;
Ph.D., University of California at Los Angeles, 1978.
- RYSZARD J. PRYPUTNIEWICZ (1978)
Professor, Mechanical Engineering
B.S., University of Hartford, 1972;
M.S., University of Connecticut, 1974; Ph.D., 1976. P.E.
- RICHARD S. QUIMBY (1982)
Associate Professor, Physics
B.S., Clarkson College of Technology, 1975;
Ph.D., University of Wisconsin at Madison, 1979.
- PATRICK J. M. QUINN (2002)
Professor, Humanities and Arts, and Head of Department
B.A., University of Guelph (Canada), 1971;
M.A., University of Ottawa (Canada), 1972;
Ph.D., The University of Warwick (England), 1988.
- MICHAEL J. RADZICKI (1990)
Associate Professor, Social Science and Policy Studies
B.A., St. Norbert College, 1979;
M.A., University of Notre Dame, 1982; Ph.D., 1985.
- L. RAMDAS RAM-MOHAN (1978)
Professor, Physics; Professor, Electrical and
Computer Engineering
B.S., Delhi University (India), 1964;
M.S., Purdue University, 1967; Ph.D., 1971.
- MALCOLM H. RAY (1998)
Associate Professor and White Chair,
Civil & Environmental Engineering
B.S., University of Vermont, 1983;
M.S., Carnegie-Mellon University, 1984;
Ph.D., Vanderbilt University, 1992.
- JOSEPH J. RENCIS (1985)
Professor, Mechanical Engineering
B.S., Milwaukee School of Engineering, 1980;
M.S., Northwestern University, 1982;
Ph.D., Case Western Reserve University, 1985. P.E.
- FABIO H. RIBEIRO (1996)
Associate Professor, Chemical Engineering
B.S., Instituto Militar de Engenharia, Rio de Janeiro,
Brazil; M.S., 1984;
Ph.D., Stanford University, 1989.
- MARK W. RICHMAN (1985)
Associate Professor, Mechanical Engineering
B.S., State University of New York at Buffalo;
M.S., University of Michigan, 1979;
Ph.D., Cornell University, 1983.
- CAPT HAROLD J. RIDER (2000)
Assistant Professor, Military Science
B.S., Bryant College, 1984.
- KENT J. RISSMILLER (1988)
Associate Professor, Social Science and Policy Studies
A.B., Muhlenberg College, 1976;
J.D., Franklin Pierce Law Center, 1980;
M.A., Syracuse University, 1981; Ph.D., 1986.
- ANGEL A. RIVERA (1994)
Associate Professor of Spanish; Humanities and Arts
B.A., University of Puerto Rico, 1983; M.A., 1987;
Ph.D., Rutgers University, 1994.
- YIMING RONG (1998)
Associate Professor, Mechanical Engineering
B.S., Harbin University of Science and
Technology (China), 1981;
M.S., Tsinghua University (China), 1984;
M.S., University of Wisconsin-Madison, 1987;
Ph.D., University of Kentucky, 1989.

CAROLINA RUIZ (1998)

Assistant Professor, Computer Science
B.S., University of Los Andes, Columbia, 1988; B.S., 1989;
M.S., 1990;
Ph.D., University of Maryland, 1996.

JILL RULFS (1990)

Associate Professor, Biology and Biotechnology;
Pre-Health Professions Advisor, and Head of Department
B.S., University of Massachusetts, 1973;
Ph.D., Tufts University, 1982.

ELKE A. RUNDENSTEINER (1996)

Associate Professor, Computer Science
B.S., Johann Wolfgang Goethe University, Frankfurt,
West Germany; M.S., 1984;
M.S., Florida State University, Irvine, 1992.

ELIZABETH F. RYDER (1996)

Assistant Professor, Biology and Biotechnology
A.B., Princeton University, 1980;
M.S., Harvard School of Public Health, 1985;
Ph.D., Harvard Medical School, 1993.

KHALID SAEED (1997)

Professor, Social Science and Policy Studies, and
Head of Department
B.S., University of Engineering and Technology,
Parkistan, 1968;
M.E., Asian Institute of Technology, Thailand, 1975;
Ph.D., Massachusetts Institute of Technology, 1981.

GUILLERMO F. SALAZAR (1983)

Associate Professor, Civil and Environmental Engineering
B.S., University of La Salle (Mexico), 1971;
M.Eng., University of Toronto, 1977;
Ph.D., Massachusetts Institute of Technology, 1983.

M. DAVID SAMSON (1991)

Associate Professor of Art History/Architecture;
Humanities and Arts
B.A., University of Chicago, 1980;
Ph.D., Harvard University, 1988.

JOHN SANBONMATSU (2003)

Assistant Professor, Humanities and Arts
B.A., Hampshire College, 1984;
Ph.D., University of California at Santa Cruz, 2000.

MARCUS SARKIS (1998)

Assistant Professor, Mathematical Sciences
B.S., Instituto Tecnológico de Aeronáutica (Brazil), 1984;
M.S., Pontifícia Universidade Católica de Rio de Janeiro
(Brazil), 1989;
Ph.D., New York University, 1994.

BRIAN J. SAVILONIS (1981)

Professor, Mechanical Engineering;
Professor, Biomedical Engineering;
Head Coach, Cross-Country
B.S., Worcester Polytechnic Institute, 1972; M.S., 1973;
Ph.D., State University of New York, 1976.

ALFRED A. SCALA (1966)

Professor, Chemistry and Biochemistry
B.S., Brooklyn College, 1957; M.S., 1961;
Ph.D., Polytechnic Institute of Brooklyn, 1965.

LANCE E. SCHACHTERLE (1970)

Professor of English; Humanities and Arts;
Assistant Provost for Academic Affairs
A.B., Haverford College, 1966;
A.M., University of Pennsylvania, 1968; Ph.D., 1970.

STANLEY M. SELKOW (1980)

Professor, Computer Science
B.S., Carnegie Institute of Technology, 1965;
M.S., University of Pennsylvania, 1967; Ph.D., 1970.

BRIGITTE I. SERVATIUS (1987)

Associate Professor, Mathematical Sciences
Magister der Naturwissenschaften der Universität Graz,
Austria, 1978;
Ph.D., Syracuse University, 1987.

THOMAS A. SHANNON (1973)

Professor of Social Ethics; Humanities and Arts
A.B., Quincy College, 1964;
S.T.B., St. Joseph's Seminary, 1968;
S.T.M., Boston University School of Theology, 1970;
Ph.D., Boston University, 1973.

SATYA SHIVKUMAR (1990)

Associate Professor, Mechanical Engineering;
Associate Professor, Biomedical Engineering
B.S., Regional Engineering College, 1978;
M.S., Indian Institute of Technology, 1980;
M.S., Stevens Institute of Technology, 1987; Ph.D., 1987.

ROSS D. SHONAT (1998)

Assistant Professor, Biomedical Engineering
B.S., University of Illinois, 1983;
M.S.E., University of Pennsylvania, 1985; Ph.D., 1991.

RICHARD D. SISSON, JR. (1976)

Professor, Mechanical Engineering
B.S., Virginia Polytechnic Institute, 1969;
M.S., Purdue University, 1971; Ph.D., 1975.

RUTH L. SMITH (1983)

Associate Professor of Religion; Humanities and Arts
B.A., East Tennessee State University, 1969;
M.A., Ohio University, 1971;
M.T.S., Harvard University Divinity School, 1976;
Ph.D., Boston University, 1982.

MICHAEL M. SOKAL (1970)

Professor of History; Humanities and Arts
B.E., Cooper Union, 1966;
M.A., Case Western Reserve University, 1968; Ph.D., 1972.

CHRISTOPHER H. SOTAK (1988)

Professor, Biomedical Engineering, and Head of
Department; Professor, Chemistry & Biochemistry
B.A., University of Northern Colorado, 1975; M.A., 1980;
Ph.D., Syracuse University, 1983;
M.B.A., Worcester Polytechnic Institute, 1995.

DIANE M. STRONG (1995)

Associate Professor, Management
B.S., University of South Dakota, 1974;
M.S., New Jersey Institute of Technology, 1978;
M.S., Carnegie Mellon University, 1983;
Ph.D., Carnegie Mellon University, 1988.

JOHN M. SULLIVAN, JR. (1987)

Professor, Mechanical Engineering; Professor, Electrical & Computer Engineering; Professor, Biomedical Engineering
B.S., Zoology, University of Massachusetts, 1973;
B.S., Mec.E., 1977; M.S., Mec.E., 1978;
Ph.D., Thayer School of Engineering, Dartmouth College, 1986.

BERK SUNAR (2000)

Assistant Professor, Electrical and Computer Engineering
B.S., Middle East Technical University (Turkey), 1995;
Ph.D., Oregon State University, 1998.

DALIN TANG (1988)

Professor, Mathematical Sciences;
Professor, Biomedical Engineering
B.A., Nanjing Institute of Technology, 1981;
Ph.D., University of Wisconsin at Madison, 1988.

STEVEN S. TAYLOR (2002)

Assistant Professor, Management
B.S., Massachusetts Institute of Technology, 1982;
M.A., Emerson College, 1993;
Ph.D., Boston College, 2000.

VENKAT R. THALLADI (2002)

Assistant Professor, Chemistry and Biochemistry
B.S., Kakatiya University (India), 1990; M.S., 1992;
Ph.D., University of Hyderabad (India), 1998.

GREGORY THEYEL (2001)

Program Manager, Adjunct Assistant Professor, Interdisciplinary and Global Studies Division
B.S., St. John's University, 1986;
M.S., Evergreen State College, 1989;
M.A., Clark University, 1994; Ph.D., 1997.

ROBERT W. THOMPSON (1976)

Professor, Chemical Engineering
B.S., Clarkson Institute of Technology, 1971; M.S., 1973;
Ph.D., Iowa State University, 1975.

JOHN M. TRIMBUR (1987)

Professor of English; Humanities and Arts
B.A., Stanford University, 1968;
M.A., State University of New York at Buffalo, 1971;
Ph.D., 1982.

GRÉTAR TRYGGVASON (2000)

Professor, Mechanical Engineering, and Head of Department
B.S., University of Iceland, 1980;
M.S., Brown University, 1982; Ph.D., 1985.

JEFFREY A. TYLER (1999)

Assistant Professor, Biology and Biotechnology
B.S., Davidson College, 1984;
Ph.D., SUNY/Albany, 1991.

HELEN G. VASSALLO (1982)

Professor, Management;
Professor, Biology and Biotechnology
B.S., Tufts University, 1953; M.S., 1955;
Ph.D., Clark University, 1967;
M.B.A., Worcester Polytechnic Institute, 1982.

RICHARD F. VAZ (1983)

Associate Professor, Electrical and Computer Engineering;
Associate Dean, Interdisciplinary and Global Studies Division
B.S.E.E., Worcester Polytechnic Institute, 1979;
M.S.E.E., 1984; Ph.D., 1987.

DOMOKOS VERMES (1990)

Associate Professor, Mathematical Sciences
M.S. (Electrical), Technische Universitat, 1970;
M.S. (Mathematics), 1971; Ph.D., University of Szeged, 1975.

BOGDAN M. VERNESCU (1991)

Professor, Mathematical Sciences
B.S., University of Bucharest, 1982; M.S., 1982;
Ph.D., Institute of Mathematics - Bucharest, 1989.

SUSAN VERNON-GERSTENFELD (1987)

Adjunct Associate Professor, Interdisciplinary and Global Studies Division; Director of Academic Programs and Planning for IGSD
B.A., Boston University, 1962; M.S.W., 1974;
Ph.D., Boston College, 1987.

SUSAN VICK (1981)

Professor of Drama/Theatre; Humanities and Arts
A.B., Catawba College, 1967;
M.F.A., Southern Methodist University, 1969;
Ph.D., University of Illinois, 1979.

OLGA VOLKOFF (2000)

Assistant Professor, Management
B.S., University of British Columbia (Canada), 1971;
M.B.A., University of Western Ontario (Canada), 1973;
Ph.D., 2000;
M.A., Queen's College (Canada), 1994.

HOMER F. WALKER (1997)

Professor, Mathematical Sciences, and Head of Department
B.A., Rice University, 1966;
M.S., New York University, 1968; Ph.D., 1970.

MATTHEW O. WARD (1986)

Professor, Computer Science
B.S., Worcester Polytechnic Institute, 1977;
M.S., University of Connecticut, 1979, Ph.D., 1981.

PAMELA J. WEATHERS (1979)

Professor, Biology and Biotechnology
B.S., Marquette University, 1969;
Ph.D., Michigan State University, 1974.

ELISE A. WEAVER (2001)

Assistant Professor, Social Science and Policy Studies
B.S., University of Toronto, 1989; M.A., 1992;
M.A., Duke University, 1996; Ph.D., 1999.

SUZANNE L. WEEKES (1998)
Assistant Professor, Mathematical Sciences
 B.S., Indiana University, 1989;
 M.S., University of Michigan, 1990; Ph.D., 1995.

STEPHEN J. WEININGER (1965)
Professor, Chemistry and Biochemistry;
Professor, Interdisciplinary and Global Studies Division
 B.A., Brooklyn College, 1957;
 Ph.D., University of Pennsylvania, 1964.

WILLIAM C. WEIR (2000)
Adjunct Assistant Professor and Manager of the Robotics
Laboratory, Mechanical Engineering
 B.S., Union College, 1995;
 M.S., Worcester Polytechnic Institute, 1997; Ph.D., 2001.

NATHANIEL A. WHITMAL III (1999)
Assistant Professor, Electrical and Computer Engineering;
Professor, Biomedical Engineering
 B.S., Massachusetts Institute of Technology, 1986;
 M.S., Tufts University, 1990;
 M.S., Northwestern University, 1993; Ph.D., 1997.

JASON D. WILBUR (2002)
Assistant Professor, Mathematical Sciences
 B.S., Worcester Polytechnic Institute, 1997;
 M.S., Purdue University, 2000; Ph.D., 2001.

KATHRYN A. WILKENS (1998)
Assistant Professor, Management
 B.A., University of Massachusetts, 1991; M.B.A., 1993;
 Ph.D., 1998.

JOHN M. WILKES (1975)
Associate Professor, Social Science and Policy Studies
 B.A., Bates College, 1970;
 M.A., Cornell University, 1973; Ph.D., 1976.

CRAIG E. WILLS (1990)
Associate Professor, Computer Science
 B.S., University of Nebraska, 1982;
 M.S., Purdue University, 1984; Ph.D., 1988.

KRISTIN NELSON WOBBE (1995)
Associate Professor, Chemistry and Biochemistry
 B.A., St. Olaf College, 1983
 Ph.D., Harvard University, 1991

JOHN P. WOYCHEESE (2000)
Assistant Professor, Fire Protection Engineering
 B.S., University of California/Berkeley, 1994; M.S., 1996;
 Ph.D., 2000.

BARBARA E. WYSLOUZIL (1993)
Associate Professor, Chemical Engineering
 B.S., Queens University, 1980;
 M.S., University of Alberta, 1985;
 Ph.D., California Institute of Technology, 1992.

ROBERT G. ZALOSH (1990)
Professor, Fire Protection Engineering
 B.M.E., The Cooper Union, 1965;
 M.S., University of Rochester, 1966;
 Ph.D., Northeastern University, 1970.

Z. AMY ZENG (1999)
Assistant Professor, Management
 B.S., Beijing University of Aeronautics and
 Astronautics, 1990;
 M.S., University of Washington, 1992;
 Ph.D., The Pennsylvania State University, 1996.

JOHN F. ZEUGNER (1971)
Professor of History; Humanities and Arts
 A.B., Harvard College, 1959;
 M.A., Florida State University, 1968; Ph.D., 1971.

QUING YANG ZHANG (2002)
Research Assistant Professor, Bioengineering Institute
 B.S., Shanghai University Industry College, 1981;
 M.S., Shanghai University of Technology, 1988;
 M.S., Worcester Polytechnic Institute, 1993; Ph.D., 1998.

JOE ZHU (1998)
Assistant Professor, Management
 B.M., Huzhou Normal College (China), 1987;
 M.S., Southeast University (China), 1992; Ph.D., 1995;
 Ph.D., University of Massachusetts, 1998.

ALEX A. ZOZULYA (1998)
Associate Professor, Physics
 B.S., Moscow Engineering Physical Institute, 1978;
 Ph.D., Lebedev Physics Institute of the Academy of
 Sciences of the USSR, 1984.

FACULTY EMERITI

Numerals following name indicate years of service.

ALLEN BENJAMIN (1963-1980)
Professor Emeritus, Civil Engineering

LADISLAV H. BERKA (1965-2001)
Professor Emeritus, Chemistry and Biochemistry

VAN F. W. BLUEMEL (1966-1999)
Professor Emeritus, Physics

ROGER R. BORDEN (1959-1987)
Professor Emeritus, Mechanical Engineering

ROY R. BOURGAULT (1955-1985)
Professor Emeritus, Mechanical Engineering

JOHN M. BOYD (1966-1994)
Professor Emeritus, Mechanical Engineering

GORDON C. BRANCHE (1959-1997)
Professor Emeritus, Mathematical Sciences

WILBUR B. BRIDGMAN (1943-1978)
Professor Emeritus, Chemistry

ELLIOT R. BUELL (1957-1978)
Professor Emeritus, Mathematics

A. FATTAH CHALABI (1959-1991)
Professor Emeritus, Civil Engineering

EDWARD N. CLARKE (1965-1994)
Professor Emeritus

- VINCENT CONNOLLY (1956-1998)
Professor Emeritus, Mathematical Sciences
- EDMUND T. CRANCH (1978-1985)
Professor Emeritus and President Emeritus
- FRANK D. DEFALCO (1960-1999)
Professor Emeritus, Civil & Environmental Engineering
- JAMES S. DEMETRY (1971-2000)
Professor Emeritus, Electrical & Computer Engineering
- RICHARD D. DESROSIERS (1972-1991)
Professor Emeritus, Civil Engineering
- WILHELM H. EGGIMANN (1964-1999)
Professor Emeritus, Electrical & Computer Engineering
- LEE FONTANELLA (1993-2002)
*Professor and Department Head Emeritus,
Humanities and Arts*
- LEONARD GOODWIN (1974-1989)
Professor Emeritus, Social Science and Policy Studies
- HARTLEY T. GRANDIN, JR. (1957-1996)
Professor Emeritus, Mechanical Engineering
- LEON S. GRAUBARD (1969-2002)
Professor Emeritus, Management
- WILLIAM R. GROGAN (1946-1990)
*Professor Emeritus, Electrical Engineering;
Emeritus Dean of Undergraduate Studies*
- ROBERT J. HALL (1956-1990)
*Professor Emeritus, Mechanical Engineering and
Management; Former Director of Continuing Education*
- MARY M. HARDELL (1972-1996)
Professor Emeritus, Computer Science
- WILLIAM J. HARDELL (1960-1994)
Professor Emeritus, Mathematical Sciences
- EDMUND M. HAYES (1964-1997)
Professor Emeritus, Humanities and Arts
- CHARLES R. HEVENTHAL (1963-1990)
Professor Emeritus, Humanities
- HAROLD W. HILSINGER (1962-1998)
Professor Emeritus, Physics
- DONALD W. HOWE (1942-1981)
Professor Emeritus, Electrical Engineering
- OWEN W. KENNEDY, JR. (1946-1987)
*Professor Emeritus, Electrical Engineering;
Emeritus Dean of Academic Computing*
- KRISHNASWAMIENGAR KESHAVAN (1967-1998)
Professor Emeritus, Civil & Environmental Engineering
- WALTER A. KISTLER (1954-1994)
Professor Emeritus, Mechanical Engineering
- DIETER KLEIN (1979-1999)
Professor Emeritus, Management
- MICHAEL W. KLEIN (1979-1995)
Professor Emeritus, Physics
- CARL H. KOONTZ (1952-1986)
Professor Emeritus, Civil Engineering
- H. PETER LANYON (1967-1999)
Professor Emeritus, Electrical & Computer Engineering
- ROBERT LONG, II (1957-1995)
Professor Emeritus, Physics
- J. J. MALONE (1971-2000)
Professor Emeritus, Mathematical Sciences
- JOHN A. MAYER (1956-1990)
Professor Emeritus, Mechanical Engineering
- ARCHIE K. MC CURDY (1955-1994)
Professor Emeritus, Electrical and Computer Engineering
- DAVID P. MC KAY (1956-1993)
Professor Emeritus, Music
- BRUCE C. MC QUARRIE (1960-1990)
Professor Emeritus, Mathematical Sciences
- WILLIAM B. MILLER (1963-1989)
Professor Emeritus, Mathematical Sciences
- RICHARD F. MORTON (1949-1979)
Professor Emeritus, Physics
- WILLIAM R. MOSER (1981-2000)
Professor Emeritus, Chemical Engineering
- MERL M. NORCROSS (1952-1994)
Professor Emeritus, Physical Education and Athletics
- NICHOLAS L. ONORATO (1955-1994)
*Professor Emeritus, Social Science and Policy Studies/
Management; Director, School of Industrial Management*
- GILBERT H. OWYANG (1961-1990)
Professor Emeritus, Electrical Engineering
- THADDEUS H. RODDENBERY (1953-1991)
Professor Emeritus, Social Science and Policy Studies
- JOSEPH D. SAGE (1957-1994)
Professor Emeritus, Civil Engineering
- KENNETH E. SCOTT (1948-1991)
Professor Emeritus, Mechanical Engineering
- GEORGE E. STANNARD (1946-1986)
Professor Emeritus, Electrical Engineering
- CARLTON W. STAPLES (1948-1986)
Professor Emeritus, Mechanical Engineering
- ROBERT E. WAGNER (1949-1987)
Professor Emeritus, Chemical Engineering
- ADRIAAN WALTHER (1972-2001)
Professor Emeritus, Physics
- FRED N. WEBSTER (1948-1972)
Professor Emeritus, Mechanical Engineering

ALVIN H. WEISS (1966-1994)
Professor Emeritus, Chemical Engineering

JERALD A. WEISS (1962-1988)
Professor Emeritus, Physics

LESLIE C. WILBUR (1957-1987)
Professor Emeritus, Mechanical Engineering;
Professor and Chairman of Nuclear Reactor Facility Emeritus

JOHN F. WILD (1962-1992)
Professor Emeritus, Physics

LYLE E. WIMMERGREN (1969-1994)
Professor Emeritus, Management

DOUGLAS W. WOODS (1970-2000)
Professor Emeritus, Social Science and Policy Studies

DONALD N. ZWIEP (1957-1990)
Professor and Department Head Emeritus,
Mechanical Engineering

SPECIAL PROFESSORSHIPS

CHRISTOPHER A. BROWN (2001-2004)
Norton Professorship

STEPHEN L. MATSON
Francis Manning Chaired Professorship

MALCOLM H. RAY
Ralph H. White Family Distinguished Professorship

YIMING (KEVIN) RONG (2002-2005)
John Woodman Higgins Professorship in Engineering

BOARD OF TRUSTEES' AWARD FOR OUTSTANDING CREATIVE SCHOLARSHIP

1983 LEONARD GOODWIN and DAVID P. MC KAY
1984 ALVIN H. WEISS
1985 LEONARD B. SAND
1986 ALEXANDER E. EMANUEL
1987 MICHAEL W. KLEIN
1988 THOMAS A. SHANNON and MICHAEL M. SOKAL
1989 ALLEN H. HOFFMAN
1990 PAUL W. DAVIS and L. RAMDAS RAM-MOHAN
1991 RSYZARD J. PRYPUTNIEWICZ
1992 GEORGE D. J. PHILLIES
1993 WESLEY T. MOTT
1994 YI H. MA
1995 DONALD F. NELSON
1996 DAVID CYGANSKI
1996 ALBERT SACCO, JR.
1996 CHRISTOPHER H. SOTAK
1997 DAVID C. BROWN
1998 KENT P. LJUNGQUIST
1999 WILLIAM R. MOSER
2000 PAMELA J. WEATHERS
2001 BARBARA E. WYSLOUZIL
2002 W. GRANT McGIMPSEY

BOARD OF TRUSTEES' AWARD FOR OUTSTANDING SERVICE

1989 WILLIAM R. GROGAN

BOARD OF TRUSTEES' AWARD FOR OUTSTANDING TEACHING

1968 WILBUR B. BRIDGMAN
1969 WILLIAM R. GROGAN
1970 JOHN P. VAN ALSTYNE
1971 KENNETH E. SCOTT
1972 ROBERT E. WAGNER
1973 JAMES HENSEL
1974 RAYMOND R. HAGGLUND
1975 ROMEO L. MORUZZI
1976 JOHN M. BOYD
1977 FRANK D. DEFALCO
1978 THOMAS H. KEIL
1979 CARLTON W. STAPLES
1980 ALLEN H. HOFFMAN
1981 JAMES W. PAVLIK
1982 ALEXANDER E. EMANUEL
1983 HARTLEY T. GRANDIN, JR.
1984 DAVID CYGANSKI
1985 JOHN F. ZEUGNER
1986 DAN H. WOLAVER
1987 RICHARD D. SISSON, JR.
1988 PATRICK P. DUNN
1989 HAROLD W. HILSINGER
1990 DAVID S. ADAMS
1991 ROBERT LONG II
1992 ANDREAS N. ALEXANDROU
1993 RICHARD F. VAZ
1994 L. RAMDAS RAM-MOHAN
1995 JAMES S. DEMETRY
1996 VAN BLUEMEL
1996 NICHOLAS K. KILDAHL
1997 SUSAN VICK
1998 LEONARD D. ALBANO
1999 JOHN A. McNEILL
2000 STEPHEN J. WEININGER
2001 STEPHEN N. JASPERSON
2002 CHRYSANTHE DEMETRY

- Academic Advising 24
 Academic Policies and Procedures 221, 222
 Academic Probation 226
 Academic Progress 226
 Academic Resources Center 18
 Academic Suspension 226
 Academic Technology Center 16
 Academic Warning 226
 Accreditation 285
 Actuarial Mathematics 28, 140
 Administration 259
 Administrative Obligations 227
 Admission 245
 Admission, Expenses, Financial Aid and Housing 244
 Advanced Casting Research Center
 Advanced Casting Research Center (ACRC) 10, 11
 Advanced Chemistry Courses 182
 Advanced Placement 246
 Advising and Student Services 17
 Aerospace Laboratory 12
 Aerospace Projects Program 38
 Aerospace Studies 170
 Air Force Aerospace Studies 66
 Algebraic and Discrete Mathematics 137
 Alternative Financial Programs 253
 Analog/Mixed Signal Microelectronics Laboratory 12
 Application Fee 245
 Application for Degree 227
 Application Procedures 249
 Applying to WPI 245
 Areas for the Sufficiency in Humanities and Arts 55
 Art History/Architecture 192
 Athletic Programs 152
 Australia Project Program 52
 Available Projects 36
 Awards and Prizes 61
 Awards and Scholarships 53

 Bangkok Project Center 51
 Biochemistry 28, 84
 Biochemistry Courses 181
 Biology & Biotechnology with Concentration 28
 Biology and Biotechnology 28, 67, 171
 Biomaterials Laboratory 12
 Biomechanical Engineering Laboratories 12
 Biomechanics/Biofluids Laboratory 12
 Biomedical Engineering 29, 72, 175
 Bioprocess Laboratory 12
 Board Charges Upon Withdrawal or Suspension 249
 Boston Project Program 48

 Career Development and Graduate School 239
 Career Development Center 240
 Career Fairs 240
 Career Library 240
 Career Workshops 240
 Center for Communication Across the Curriculum 37
 Center for Heat Treating Excellence (CHTE) 10
 Center for Holographic Studies and Laser Technology 10
 Center for Sensory and Physiologic Signal Processing 12
 Center for Wireless Information Networking Studies 12
 Ceramic Processing Laboratory 12
 Change of Registration 228
 Charge 248
 Chemical Engineering 29, 79, 177
 Chemistry 29, 85
 Chemistry and Biochemistry 83, 179, 180
 Chronology of Academic Schedule and Events IFC
 Civil and Environmental Engineering 88, 182, 183
 Civil Engineering 29
 Civil Engineering Area Consultants 93
 Class Year 225
 Coding of Project Advisors 230
 Collaborative for Entrepreneurship & Innovation 234
 College Awards 61
 Combined Bachelor's/Master's Program 73, 92, 129, 158, 242
 Commitment to Pluralism 3

 Company Presentations 240
 Computational and Applied Analysis 137
 Computational Fields Laboratory 13
 Computational Gas and Plasma Dynamics Laboratory 13
 Computer Classroom 8
 Computer Music Laboratories 16
 Computer Resources 8
 Computer Science 30, 94, 184
 Computer Science Minor 100
 Computer Science Project Laboratories 10
 Computerized Resume Database 240
 Computers with Applications 30
 Concentrations 26
 Concentrations for Chemical Engineering Majors 82
 Concentrations for Humanities and Arts Majors 115
 Convergent Technologies Center (CTC) 13
 Cooperative Education Program 236
 Costa Rica Project Center 51
 Course Categories 170
 Course Changes 227
 Course Credit 170
 Course Descriptions 169, 170
 Course Numbering 170
 Credit Overlap 223
 Credit Units 22
 Cryptography and Information Security (CRIS) Labor 13
 Cumulative Point Average 223
 Currency of Information 286

 Data/Knowledge Base Research Laboratory 13
 Degree Audits 225
 Degree Requirements 22
 Degrees and Requirements 242
 Denmark Project Center 49
 Department and Program Descriptions 65
 Department of Management 127
 Departmental Descriptions 66
 Design Studio 9
 Designation of Class Year 225
 Designation of Major Area Of Study 225
 Developing a Sufficiency Program 55
 Directions 286
 Directory Information and Release of Information 227
 Discovery Classroom 10
 Distributed Processing Laboratory 13
 Double Majors 27, 225

 Early Action 246
 Early Decision 246
 Ecole Polytechnique; Montreal, Quebec, Canada 235
 Economic Growth, Stability and Development 44
 Economics 30, 160
 Economics and Technology 30, 160
 Education in a Technological Society 45
 Electrical and Computer Engineering 31, 100, 187
 Electrical Engineering 31
 Energy and Resources 40
 Engineering Experimentation Laboratory 10
 Engineering Physics 111
 Engineering Registration and Licensing 238
 Engineering Science Courses 111
 Engineering Science Interdisciplinary 189
 Engineering Societies 238
 English 192
 English as a Second Language (ESL) Program 247
 Enrollment 227, 248
 Entrepreneurship Minor 130
 Environmental Economics and Public Policy 112
 Environmental Engineering 94, 111
 Environmental Policy and Development 31, 161
 Environmental Programs 111
 Environmental Sciences 112
 Environmental Studies 112
 Estimated Expenses 248
 Ethical and Professional Conduct 285
 Examination 238
 Expenses 248

- Faculty 269
 Federal Technical Institute; Zurich, Switzerland 235
 Fellowships 241
 Financial Aid 241, 245, 249
 Financial Aid Policies 252
 Financial Aid Upon Withdrawal/ Suspension 249
 Fire Protection Engineering 113, 190, 192
 Fire Science Laboratory 13
 First-Year Advising 24
 Fluid Dynamics Laboratory 13
 Forms of Aid 250
 Four- or Five-Year Dual-Degree BS/MS Program 134
 Fulbright Grants 241
 Fundamentals of Engineering Examination 238
 Furnishings and Facilities 254
- Gender, Race, and Technology 53
 General Chemistry Sequence 180
 General Computer Science Department Facilities 8
 General Electric (GE) Company Project Center 38
 George C. Gordon Library 16
 Geosciences 191, 192
 German 195
 Getting Started in Humanities and Arts 57
 Gillette Company Project Center 38
 Global Technological University 6
 Goal of Worcester Polytechnic Institute 4
 Goals of The Sufficiency 54
 Goddard Space Flight Center MQP Program 48
 Grade System Selection 222
 Grades 222
 - Incomplete (I) 222
 - No Record (NR) 222
 - Satisfactory Progress (SP) 222
 - Other Grades 222
 - Grades for Completion of Degree Requirements 222
 - Grade Appeal and Grade Change Policy 223
- Graduate Admission 241
 Graduate Assistantships 241
 Graduate Biology and Biotechnology Courses 174
 Graduate Biomedical Engineering Courses 176
 Graduate Calendar 2003-2004 ii
 Graduate Chemical Engineering Courses 178
 Graduate Chemistry Courses 181
 Graduate Course Listings 243
 Graduate Fire Protection Engineering Courses 190
 Graduate Physics Courses 216
 Graduate Program 241
 Graduate Studies 240
 Graduation with Honors 223
 Great Hall of Alden 16
 Green Room 16
- Haas Technical Center for Computer-Controlled Machining 9, 10
 Health Care and Technology 41
 Heat Transfer Laboratory 14
 Historic and Artistic Preservation Technology 46
 History 195
 Hong Kong, China 51
 Housing 254
 Humanistic Studies of Technology 44
 Humanities 197, 198
 Humanities and Arts 32, 114, 192, 193
 Humanities and Arts Minors 117
 Hydrodynamics Laboratory 14
- Improvement in Status 226
 Independent Study Registration 228
 Individual Career Counseling 240
 Industrial Engineering 32, 118, 123
 Interactive Qualifying Project 22, 39
 Interdisciplinary 32, 201, 202
 Interdisciplinary Programs 118
 International Students 247
 International Studies 32, 119
 International Studies Minor 116
- Job Opportunities 240
- Keck Design Center 8
- Laboratories and Facilities 12
 Language Requirements 235
 Laser Laboratories 14
 Law and Technology 46
 Law and Technology Minor 121
 Library 16
 Licensing 238
 Limerick, Ireland 49
 Living Museums Program 53
 London Project Center 50
 London Sufficiency Program 50
- Madrid Sufficiency Program 50
 Major Areas of Study 24
 Major Qualifying Project 22, 39
 Major Selection Program 18, 240
 Management 33, 122, 127, 202
 Management Engineering 127
 Management Information Systems (MIS) 128
 Management Information Systems Minor 131
 Management Microcomputing Laboratory 9, 11
 Management Minor 131
 Manufacturing Design Studio 9
 Manufacturing Engineering 33, 132
 Manufacturing Engineering Research Center 9
 Manufacturing Laboratory 14
 MASH 18
 Master Builder Program 92
 Materials Engineering 135
 Math and Science Help 18
 Mathematical Science 33, 136, 205
 Mathematics Laboratories 14
 Mathematics Minor 143
 Matriculate 246
 Meals 255
 Mechanical Engineering 33, 144, 208
 Mechanical Engineering Department Concentrations 147
 Mechanical Engineering Project Laboratory 10
 Mechanical Testing Laboratories 14
 Metal Processing Institute (MPI) 11
 Military Science 150, 212
 Minimum Academic Credit 22
 Minimum Distribution Requirements For Students 28
 Minor in Computer Engineering 110
 Minor in Foreign Language (German or Spanish) 117
 Minor in Manufacturing Engineering 134
 Minor in Materials 135
 Minor in Music 117
 Minor in Writing and Rhetoric 118
 Minors 26
 MIS/OIE Oracle/Lean Lab 9
 Mission of Worcester Polytechnic Institute 3
 Monterrey Institute of Technology; Monterrey, Mexico 235
 Music 198
 Music and Theater Facilities 16
 Music Facilities 16
- New Student Orientation 246
 Nondiscriminatory Policy 285
 Notification 246
 Nuclear Magnetic Resonance (NMR) Imaging Facility 14
- Occupancy 254
 Off-Campus Graduate Study 243
 Off-Campus Insurance and Legal Agreements 37
 Off-Campus Living 255
 Off-Campus Sufficiency Option 60
 On-Campus IQP Programs 53
 Operations Research 138
 Optical and Electron Microscopy Laboratories 14
 Organizational Leadership Minor 131
 Overload Charges 248
 Overloads of Courses 228

- Part-Time Graduate Program 242
 Payment of Tuition Deposit 248
 Petitions 227
 Philosophy 199
 Physical Education 22, 152, 213
 Physics 34, 153, 214
 Physics and Engineering-Physics Programs 155
 Physics for Nonphysics Majors 157
 Physics Minor 157
 Placement Process 237
 Planning for Professional Development 23
 Planning Process 23
 Policies & Practices 285
 Powder Metallurgy Research Center (PMRC) 10, 11
 Power Electronics and Power Systems Laboratory 14
 Pre-Law Programs 158
 Pre-MBA Program (Dual Degree) 158
 Pre-Medical, Pre-Dental and Pre-Veterinary Program 158
 Preparing for The IQP 39
 President's IQP Awards 53
 Probability and Statistics 138
 Professional Development 23
 Professionally Accredited Programs 23
 Programs in Asia 51
 Programs in Australia 52
 Programs in Europe 49
 Programs in Latin America 51
 Programs in The United States 47
 Project Advisor 36, 228, 230
 Project and Educational Facilities 10
 Project and Independent Study Registration 228
 Project Centers 37
 Project Grading 222
 Project Performance 36
 Project Registration Topic Codes 229
 Projects 35
 Projects Program 37
 Provost's MQP Awards 53
 Puerto Rico Project Center 52
- Qualifications 245
 Qualifying Project Documentation 36
- Readmission 247
 Readmission after Suspension 227
 Registration 227
 Registration and Tuition Payment 241
 Registration Policy for Degree Requirements 229
 Rehabilitation Engineering Laboratory 12
 Release of Information 227
 Religion 200
 Research Centers and Institutes 10
 Research Laboratories and Facilities 12
 Reserve Officer Training Corps (ROTC) Scholarships 251
 Residence Halls/ Staff 254
 Residency Requirement 22
 Residential Programs 47
 Residential Project Programs 47
 Resources Available to Undergraduates 8
 Resources in Fuller Laboratories 8
 Resources in Higgins Laboratories 8
 Resources in The Washburn Laboratories 9
 Rhodes Scholarships 241
 Room Charges 255
 Room Charges Upon Withdrawal or Suspension 249
 Roommates 255
 Royal Institute of Technology; Stockholm, Sweden 235
- Safety Analysis and Liability 43
 Satellite Navigation Laboratory 15
 Satisfactory Academic Progress 226
 Scholarships and Grants for Graduate Study Abroad 241
 Science and Technology: Policy and Management 42
 Silicon Valley Project Center 48
 Social and Human Services 45
 Social Science And Policy Studies 159, 216
 Social Science Minors 168
 Social Science Requirement 61
 Social Studies of Science and Technology 43
 Societies, Registration and Licensing 238
 Society of Actuaries (SOA) Examinations 141
 Society, Technology and Policy 34, 161
 Software Engineering Research Lab 15
 Spanish 200
 Spaulding Recital Hall 16
 Special (Su, Sx) Students 249
 Special Awards 62
 Special Students 226, 229
 Standardized Tests 245
 Statistics Minor 143
 Student Absence Due to Religious Beliefs 285
 Student Development and Counseling Center 17
 Student Disability Services Office 18
 Student Exchanges 234
 Students Tuition Charges Upon Withdrawal or Suspension 248
 Sufficiency 22, 54
 Sufficiency For International Students 59
 Summer Bridge Program 226
 Summer Study (Term E) 237
 Surface Metrology Laboratory (Surf Met Lab) 15
 System Dynamics 34, 160
- 3-2 Programs 236
 Teacher Licensing 119
 Technical College; Munich, Germany 236
 Technical, Scientific, and Professional Communication 34, 119
 Technical University; Darmstadt, Germany 236
 Technology and Environment 40
 Term E Review Period 226
 Terms 22
 Transcript 225
 Transfer Agreement 247
 Transfer and 3-2 Students 247
 Transfer Credit 58, 223
 Transfer Students 225, 247
 Transfer Students and the Sufficiency Requirement 54
 Trustees 257
 Trustees Administration and Faculty 256
 Tufts School of Veterinary Medicine Project Center 38
 Tuition 248
 Tuition Deposit 248
 Two Towers Tradition 5
- Ultrasound Research Laboratories 15
 Undergraduate Calendar 2003-2004 ii
 Unique Opportunities 233
 Units 22
 University of Massachusetts Medical Center 38
 Upperclass Advising 24
 Urban and Environmental Planning 42
- Venice Project Center 50
 Vibrations/Control/Dynamics Laboratory 15
 Visiting the Campus 245
 Visualization and Image Science Laboratory 15
 VLSI Design Laboratory 15
- Wait Lists 227
 Washington Project Center 47
 Withdrawal from Courses 228
 Withdrawal from WPI 228
 Worcester Community Project Center 48
 Worcester Consortium Course Cross-Registration 236
 World Wide Web 19
 WPI Plan 5, 21
 Writing 201, 202
 Writing Courses and Advisors 19
 Writing Workshop 19
- X-Ray Diffraction Laboratory 15
 Zurich, Switzerland 51

Worcester Polytechnic Institute is accredited by the New England Association of Schools and Colleges, Inc., a non-governmental, nationally recognized organization whose affiliated institutions include elementary schools through collegiate institutions offering post-graduate instruction.

Accreditation of an institution by the New England Association indicates that it meets or exceeds criteria for the assessment of institutional quality periodically applied through a peer group review process. An accredited school or college is one which has available the necessary resources to achieve its stated purposes through appropriate educational programs, is substantially doing so, and gives reasonable evidence that it will continue to do so in the foreseeable future. Institutional integrity is also addressed through accreditation.

Accreditation by the New England Association is not partial but applies to the institution as a whole. As such, it is not a guarantee of the quality of every course or program offered, or the competence of individual graduates. Rather, it provides reasonable assurance about the quality of opportunities available to students who attend the institution.

In addition, the programs leading to majors in chemical engineering, civil engineering, electrical engineering, industrial engineering, manufacturing engineering and mechanical engineering are accredited by the Engineering Accreditation Commission of ABET. The Chemistry and Biochemistry Department and its program at WPI are approved by the American Chemical Society for a major in chemistry or biochemistry. Those chemistry majors who complete a program satisfying the guidelines established by the American Chemical Society are certified to that organization as having received an undergraduate professional education in chemistry or biochemistry. The Computer Science program has been accredited by the Computing Accreditation Commission of ABET.

POLICIES & PRACTICES

NOTICE OF NONDISCRIMINATORY POLICY AS TO STUDENTS

It is the policy of Worcester Polytechnic Institute that each qualified individual, regardless of race, color, sex, religion, sexual orientation, national origin, age as defined by law, or handicap, shall have equal opportunity in education, employment or services of Worcester Polytechnic Institute. It is the policy of WPI to follow U.S. federal government eligibility guidelines in the administration of its institutional financial aid program.

STUDENT RESPONSIBILITIES FOR ETHICAL AND PROFESSIONAL CONDUCT

WPI expects all its students to demonstrate the highest sense of honor in respecting academic and professional traditions such as acknowledging the borrowing or use of other people's ideas. Willful violations (like plagiarism) of such academic traditions or of legal restrictions (like those regarding copyright) will be considered violations of the "Campus Code" as described in the *Student Planner*.

WPI education is strongly committed to project-based learning, to providing students with access to state-of-the-art technology, and to working with professionals, on and off campus. Therefore, when students are exposed to proprietary and/or confidential information, they must accept responsibilities appropriate to their preparation for life-long careers in which codes of ethics govern professional conduct.

Facilities such as the off-campus projects, employment sites, and those listed in "Resources Available to Undergraduates" (pages 8-16) permit students to gain experi-

ence with techniques at the forefront of industrial and research development. With this access comes the added responsibility of safeguarding students of any agreements they sign regarding conditions or restrictions for access to certain equipment or information will also be considered a violation of the "Campus Code" as described in the *Student Planner*.

Record of any penalties assigned by the WPI Campus Judicial System which result from violation of standards of ethical conduct will become a permanent part of that student's disciplinary record.

STUDENT ABSENCE DUE TO RELIGIOUS BELIEFS

Section 2B, Chapter 151C of the General Laws of the Commonwealth of Massachusetts: "Any student in an educational or vocational training institution, other than a religious or denominational educational or vocational training institution, who is unable, because of his/her religious beliefs, to attend classes or to participate in any examination, study, or work requirement on a particular day shall be excused from any such examination or study or work requirement, and shall be provided with an opportunity to make up such examination, study, or work requirement which he/she may have missed because of such absence on any particular day; provided, however, that such makeup examination or work shall not create an unreasonable burden upon such school. No fees or any kind shall be charged by the institution for making available to the said student such opportunity. No adverse or prejudicial effects shall result to any students because of his/her availing himself/herself of the provisions of this section."

The information contained in this *Undergraduate Catalog* is not a complete statement of all the policies, practices, rules and regulations of Worcester Polytechnic Institute. Any statement made in this publication is for current informational purposes only and is subject to change by the governing body of WPI or its duly authorized representatives. Certain policies, rules and regulations are not published in this publication but are promulgated directly by the appropriate department. Members of the WPI community are expected to abide by the current policies,

practices, rules and regulations of the college, even though they may not be contained in this publication or may not be consistent with the information contained in this publication, whether due to a properly authorized change or to a printing error.

Changes, deletions, and additions authorized by the governing body of WPI, after the printing of this catalog, are posted on WPI's web page at www.wpi.edu/ as a supplement to the undergraduate catalog, and includes the effective date of the action.

DIRECTIONS

DRIVING TO WPI

FROM THE EAST:

Take Mass. Turnpike (I-90) to Exit 11A (I-495). Proceed north to I-290, then west into Worcester. Take Exit 18, turn right at end of ramp, then an immediate right before next traffic light. At next light, proceed straight through, bearing to the right on Salisbury St. At the WPI sign, turn left onto Boynton St., then right onto Institute Rd., then right onto West St. Visitor parking is on the left after footbridge.

FROM THE NORTH:

Take I-495 south to I-290. Follow directions as from east.

FROM THE SOUTH AND WEST:

Take Mass. Turnpike (I-90) to Exit 10 (Auburn). Proceed east on I-290 into Worcester. Take Exit 17, turn left at end of ramp, follow Rte. 9 west through Lincoln Sq., straight onto Highland St., then right at light onto West St. and through first intersection. Visitor parking is on the left after footbridge.

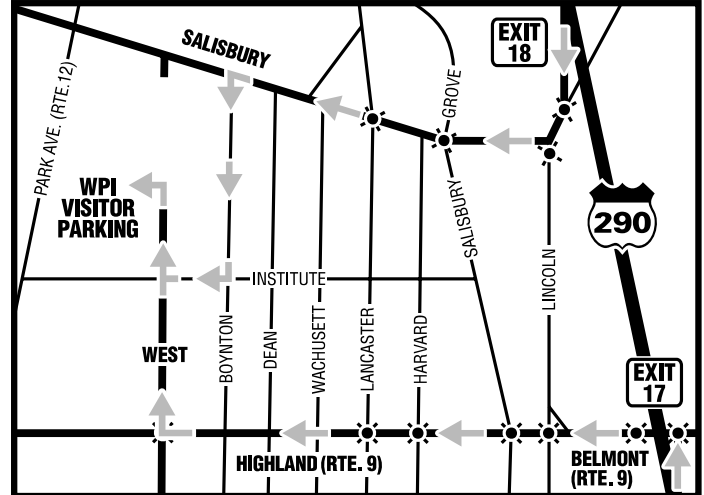
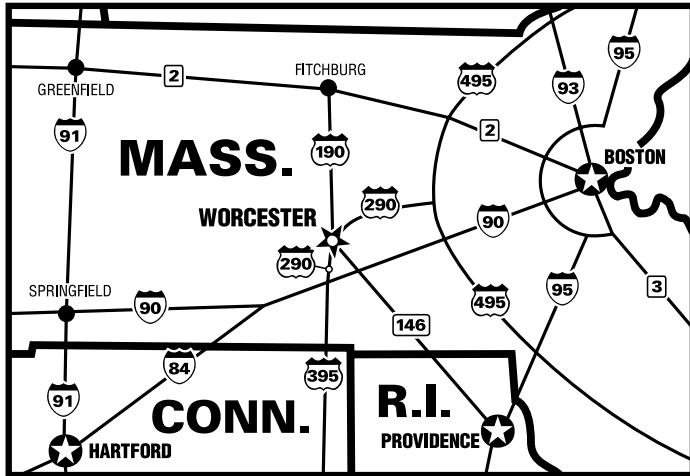

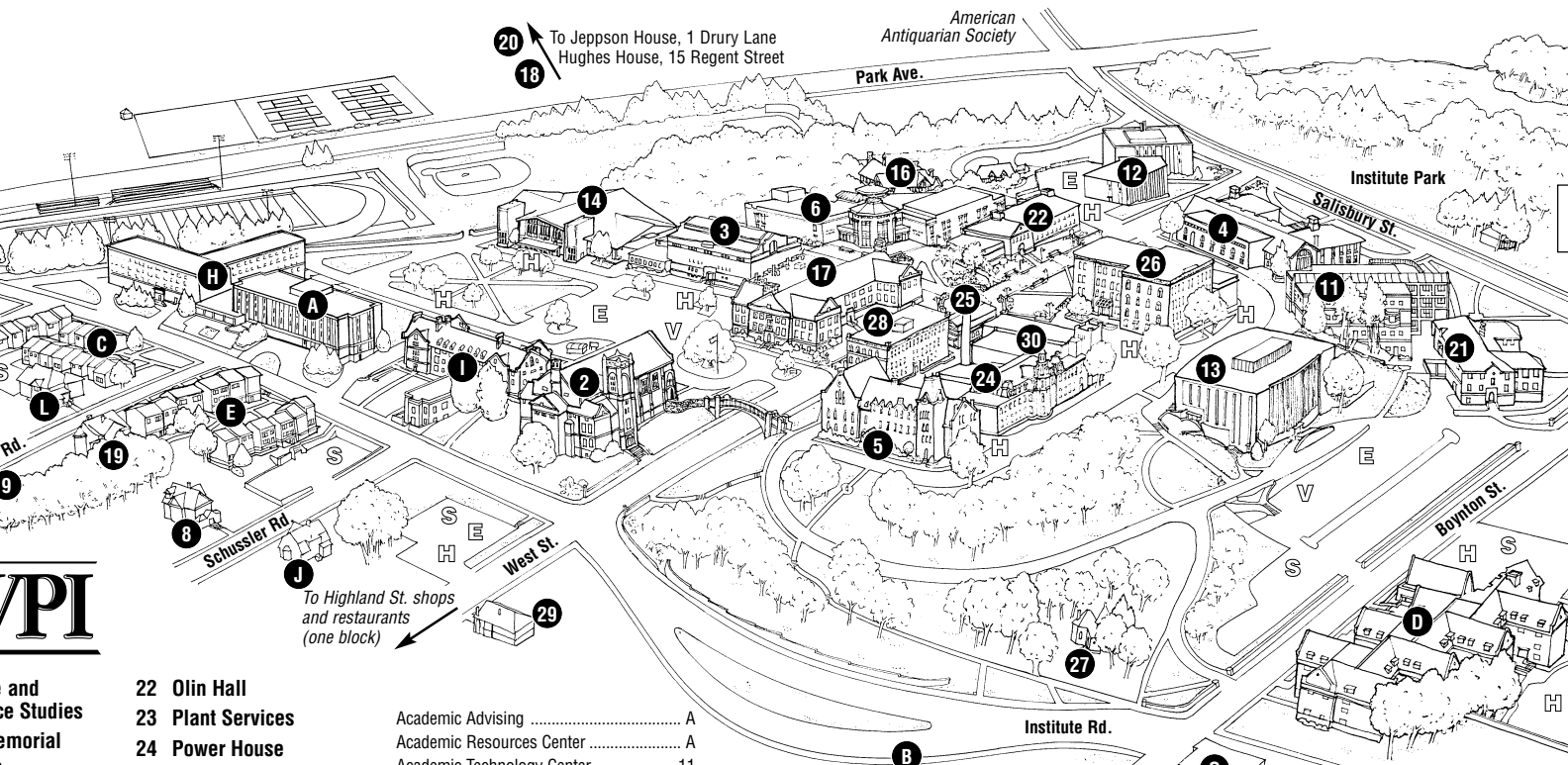

and
ce Studies
Memorial
ym
ent
ries
Hall
Center
Police
e Religious
ment Group
Street
Laboratories
Hall
Library
on Auditorium
enter
House
Laboratories
House
onal House
House
Hall

- 22 Olin Hall
- 23 Plant Services
- 24 Power House
- 25 Project Center
- 26 Salisbury Laboratories
- 27 Skull Tomb
- 28 Stratton Hall
- 29 Student Development and Counseling Center
- 30 Washburn Shops and Stoddard Laboratories
- A Daniels Hall
- B 16 Elbridge
- C Ellsworth Apartments
- D Founders Hall
- E Fuller Apartments
- F 26 Hackfeld
- G Institute Hall
- H Morgan Hall
- I Sanford Riley Hall
- J 22 Schussler
- K Stoddard Complex
- L 25 Trowbridge

Academic Advising	A
Academic Resources Center	A
Academic Technology Center	11
Accounting	5
Administrative Services	A
Admissions (Graduate)	10
Admissions (Undergraduate)	5
Air Force & Aerospace Studies	1
Alcohol/Drug Education Director	K
Alumni Office	16
Applied Music Division	2
Archives Room	13
Basketball Courts (indoor)	14
Biology & Biotechnology Dept.	26
Biomedical Engineering Dept.	26
Bookstore	6
Bowling Alleys	3
Business Affairs/Treasury	5
Campus Police	7
Career Development Center	25
Chemical Engineering Dept.	12
Chemistry & Biochemistry Dept.	12
Civil & Environmental Engineering Dept.	21
Computing and Communications Center	11
Collegiate Religious Center	8
Computer Science Dept.	11
Cooperative Education Program	25
Dining Hall (Founders)	D
Dining Hall (Morgan)	H
Dining Services	6
Disability Services	A
Discovery Classroom	17

Diversity & Women's Programs	6
Educational Development, Center for	10
Electrical & Computer Engineering Dept.	4
Emergency Medical Service	7
Entrepreneurship & Innovation, Collaborative for	30
ESL Program	19
Events Office	6
Financial Aid	5
Fire Protection Engineering	17
Firesafety Studies, Center for	17
Fitness Center	3
Food Court	6
Healthy Alternatives	3
Health Center	K
Higgins Club (dining room)	16
Higgins Lecture Hall	30
Human Resources	28
Humanities & Arts Dept.	26
Interdisciplinary & Global Studies	25
International Students & Scholars	19
Kinnicutt Lecture Hall	26
Lens & Lights	6
Mail Services	6
Major Selection Program	25
Management Dept.	30
Manufacturing Engineering	30

Masque Office	2
Materials Science & Engineering	30
Mathematical Sciences Dept.	28
Mechanical Engineering Dept.	17
Media Relations	5
Metal Processing Institute	30
Military Science	14
Minority Affairs	6
Newell Lecture Hall	4
Nuclear Reactor Facility	30
Odeum	6
Payroll	28
Peddler (yearbook)	6
Perreault Lecture Hall	11
Physical Education & Athletics	3
Physics Dept.	22
Pre-Health Center	26
President's Office	5
Printing Services	5
Projects & Registrar's Office	5
Property Administration	A
Provost's Office	5
Publications	5
Racquetball Courts	14

Radio Station WWPI	
Research Administration	
Residential Services	
Riley Commons	
School of Industrial Man	
Secretary of the Corpora	
Secretary of the Faculty	
Seminar Room	
Social Committee (SocC	
Social Science & Policy	
Sports Information	
Squash Courts	
Student Activities	
Student Affairs	
Student Development &	
Student Life	
Summer Session	
Swimming Pool	
Tech News (student new	
Telecommunications	
Theatre Facility	
University Marketing	
University Relations	
Web Development	
Wedge, The	
Wrestling Facility	
Writing Workshop	

Massachusetts Academy of Math & Science
Gateway Park, 89 Prescott St., Worcester