

CROSS-LAYER OPTIMIZATION AND DYNAMIC SPECTRUM ACCESS
FOR DISTRIBUTED WIRELESS NETWORKS

by

Si Chen

A Thesis
Submitted to the Faculty
of the
WORCESTER POLYTECHNIC INSTITUTE
in partial fulfillment of the requirements for the
Degree of Master of Science
in
Electrical and Computer Engineering
by

2009

APPROVED:

Professor Alexander M. Wyglinski, Research Advisor

Professor Kaveh Pahlavan

Professor Sudharman K. Jayaweera

Abstract

We proposed a novel spectrum allocation approach for distributed cognitive radio networks.

Cognitive radio systems are capable of sensing the prevailing environmental conditions and automatically adapting its operating parameters in order to enhance system and network performance. Using this technology, our proposed approach optimizes each individual wireless device and its single-hop communication links using the partial operating parameter and environmental information from adjacent devices within the wireless network.

Assuming stationary wireless nodes, all wireless communication links employ non-contiguous orthogonal frequency division multiplexing (NC-OFDM) in order to enable dynamic spectrum access (DSA). The proposed approach will attempt to simultaneously minimize the bit error rate, minimize out-of-band (OOB) interference, and maximize overall throughput using a multi-objective fitness function. Without loss in generality, genetic algorithms are employed to perform the actual optimization.

Two generic optimization approaches, subcarrier-wise approach and block-wise approach, were proposed to access spectrum. We also proposed and analyzed several approaches implemented via genetic algorithms (GA), such as quantizing variables, using adaptive variable ranges, and Multi-Objective Genetic Algorithms, for increasing the speed and improving the results of combined spectrum utilization/cross-layer optimization approaches proposed, together with several assisting processes and modifications devised to make the optimization to improve efficiency and execution time.

Acknowledgements

I would like to express my deepest gratitude to my advisor Dr. Alexander M. Wyglinski for the opportunity to work with him in Wireless Innovation Lab at Worcester Polytechnic Institute. His guidance and support has made my course of degree a wonderful experience.

I would also like to thank Dr. Kaveh Pahlavan and Dr. Sudharman K. Jayaweera for agreeing to be on my committee and for their suggestions and comments with regards to my thesis.

During my graduate studies at WPI, I have had the pleasure of meeting many friends, who have helped me directly or indirectly in completing my studies. I owe my thanks to them. In particular, I would like to thank WILab members, Michael Leferman, Srikanth Pagadarai, Kevin Bobrowski, Di Pu, Zhou Yuan, and Jingkai Su.

I would like to thank my parents for being with me from the very beginning of my education.

Contents

List of Figures	vi
List of Tables	viii
1 Introduction	1
1.1 Motivation	1
1.2 Brief Overview of the Current State-of-the-art	3
1.3 Thesis Contributions	6
1.4 Thesis Organization	6
2 Dynamic Spectrum Access in Wireless Cognitive Radio Network and Optimization	7
2.1 Cognitive Radio Systems	7
2.2 Distributed Wireless Networks	9
2.3 Dynamic Spectrum Access	9
2.4 Non-Contiguous Orthogonal Frequency Division Multiplexing (NC-OFDM)	11
2.5 Radio Resource Optimization Methods	14
2.5.1 Genetic Algorithms	14
2.5.2 Cross-Layer Optimization Technologies	16
2.5.3 Multi-Objective Optimization	18
2.6 Summary	20
3 Proposed Distributed Optimization Framework	21
3.1 Previous Work	21
3.2 Role of the Optimization Engine	22
3.3 Optimization Framework for Distributed Cognitive Radio Networks	22
3.3.1 Overall Multi-Objective Function	24
3.3.2 Bit Error Rate Fitness Function	26
3.3.3 Throughput Fitness Function	27
3.3.4 Transmission Power Fitness Function	27
3.3.5 Interference Fitness Function	28
3.3.6 Initial result	28
3.4 Dynamic Spectrum Access Iteration	29

3.5	Summary	30
4	Proposed Implementation of Optimization Approaches	31
4.1	Generic Framework	31
4.1.1	Proposed Serial Subcarrier-Wise Genetic Algorithm Optimization Approach (SCGA)	32
4.1.2	Proposed Block-Wise Genetic Algorithm Optimization Approach (BGSA)	33
4.1.3	Constraint Handling	35
4.2	Multi-Objective Optimization Algorithms	35
4.2.1	Weighted-Sum Method	36
4.2.2	Pareto Optimization	36
4.3	Implementation of Optimization Approaches	38
4.3.1	Quantization of Subcarrier Spacing for One-FFT Implementation	38
4.4	Approaches to Accelerate Optimization	40
4.4.1	Quantized Variables	40
4.4.2	Adaptive Variable Ranges	41
4.4.3	Manipulating Constraints and Objectives	43
4.5	Simulation Results	44
4.5.1	Simulation Parameters	44
4.5.2	Optimization Results	44
4.5.3	Effects of Quantization, Shifting and fine-tuning	48
4.5.4	NSGA-II	50
4.5.5	Weighted Sum	51
4.5.6	MOGA or Weighted Sum	52
4.6	Summary	53
5	Conclusions and Future Work	56
5.1	Future Work	58
	Bibliography	59

List of Figures

1.1	Cognitive Cycle	4
2.1	An visual illustration of a cognitive radio device	8
2.2	Schematic of an OFDM system employing a cyclic prefix.[1]	12
2.3	An illustration of a secondary user employing NC-OFDM in the presence of a primary user	14
2.4	An example of encoded parameters used in Genetic Algorithms	15
2.5	An example of how a new population is selected and generated from a pool of chromosomes	15
2.6	Framework of a generic cross-layer optimization architecture. The cross-layer optimization engine uses operating parameter information from the various network layers, as well as environmental parameters external to the wireless platform, in order to decide on an appropriate device configuration. This configuration is applied to the network layers of the platform.	18
3.1	Proposed distributed optimization architecture in [2]. Overhead channels are used to share a few necessary device parameters that cannot be sensed by other devices directly, such as receiving interference level.	23
3.2	Improvement of fitness score over generations. The four fitness functions are combined in a weighted sum	29
4.1	Illustration of SCGA process to allocate secondary subcarriers in the presence of primary users.	33
4.2	Binary recursion for BGSA approach.	34
4.3	A flowchart of a “noble” approach to data rate-oriented BGSA.	35
4.4	Non-dominated sorting is shown	37
4.5	Comparison of spectrum when subcarrier frequencies are not quantized and when they are quantized	39
4.6	Flowchart of quantization and fine-tuning.	41
4.7	Example of comparison of searches using non-adaptive variable ranges and adaptive variable ranges (Using NSGA, BGSA, 5 objectives and 0 constraints)	43
4.8	Simple case: Optimization results of SCGA trying to maximize throughput when BER constraint is 0.001 and interference constraint is -30 dB	45

4.9	Simple case: Optimization results of BGSA trying to maximize throughput when BER constraint is 0.001 and interference constraint is -30 dB	46
4.10	Scenario 2: Comparison of transmission power of subcarriers in the results of SCGA and BGSA	47
4.11	Scenario 2: Comparison of bit per symbol of subcarriers in the results of SCGA and BGSA	48
4.12	Sample result of spectrum allocation using SCGA, where 210kbps is achieved.	49
4.13	Sample result of spectrum allocation using BGSA, where 256kbps is achieved.	50
4.14	Throughput comparison of SCGA and BGSA in the senario of Figure 4.12 and Figure 4.13. BGSA performs better when secondary user demand is high	51
4.15	Demand satisfaction of SCGA and BGSA in the senario of Figure 4.12 and Figure 4.13.	51
4.16	A numeric sample result demonstrating the effects of quantization and fine-tuning processes on a NC-OFDM transmission. The required total bits per subcarrier is 80. Quantization regularizes the spacing of subcarriers, and fine-tuning reduces number of bits per subcarrier and shifts location for those subcarriers with high BER.	52
4.17	Example of comparison of searches using different objective-constraint combinations (Using NSGA, BGSA, non-adaptive variable ranges)	54
4.18	Example of comparison of searches using different objective-constraint combinations (Using SGA, BGSA, non-adaptive variable ranges)	55

List of Tables

2.1	Dependencies of several performance objectives on operating parameters . .	17
-----	--	----

Chapter 1

Introduction

1.1 Motivation

As the demand for high speed wireless transmission increases, in both industrial and personal communication systems, researchers have sought to increase the overall throughput of modern communication systems by alleviating the apparent spectrum scarcity issues currently being faced by these systems. Recent measurements showed that wireless spectrum resource in terms of frequency and time is underutilized in most part of the whole spectrum, and overutilized in a few sections, such as the cell phone band and the industrial, scientific and medical (ISM) radio band[3]. According to the *Federal Communications Commission* (FCC) , temporal and geographical utilization of the assigned spectrum varies from 15% to 85%[3]. Such a huge difference is the consequence of fixed spectrum regulation over almost the whole spectrum managed by the FCC or other federal regulators, under which every section of the spectrum is allocated for a particular use alone, and the user maintains exclusive rights across the specified range of frequencies within a geographical area. One of the reasons for fixed spectrum regulation is the incapability of conventional wireless transmitters to automatically change transmit parameters. However, this is no longer the case as the techniques of software defined radios (SDR) are becoming mature, with the help of cheaper, faster, and smaller DSP units.

Software defined radio enables wireless platforms to autonomously choose device oper-

ating parameters. These wireless devices have the potential to revolutionize how society performs wireless networking. Moreover, cognitive radios add an onboard intelligence to the software defined radio technologies so as to learn from the current wireless operating environment and to explore more possibilities of efficient spectrum utilization.

Cognitive radio technologies can be used to improve spectrum access and efficiency of spectrum use under several possible scenarios:

- A licensed user can employ cognitive radio technologies within its own network to increase efficiency.
- Cognitive radio technologies can facilitate automated frequency coordination among several primary licensees. Such coordination could be done voluntarily by the licensees under more general coordination rules imposed by FCC rules.
- Cognitive radio technologies can facilitate secondary markets in spectrum use, implemented by voluntary agreements between licensees and secondary users. For instance, a licensee and secondary users could sign an agreement allowing secondary spectrum uses given no interference on the licensee, which is made possible only by deployment of cognitive radio technologies. Ultimately cognitive radio devices could be developed to negotiate with a licensee and use spectrum only if agreement is reached between a device and the system.
- Cognitive radio technologies can coordinate secondary uses in either licensed or unlicensed spectrum bands. For instance, given the heterogeneity of primary uses, secondary users can form a sub-network in a cooperative way utilizing the idle wireless resources, or in a non-cooperative way for several secondary sub-networks to compete for available resources.

As a result, FCC is considering relaxing the fixed spectrum regulation by adopting the idea of “borrowing” spectrum, which means unlicensed users can use licensed bands when they are not used by licensed users, *i.e.*, as long as not to interfere with licensed users.

1.2 Brief Overview of the Current State-of-the-art

The advancement of software defined radio provides a platform with reconfigurability on which we build cognitive radios. Software defined radio is a convergence of digital radio and computer software as defined in [4]. One of the most popular definitions of cognitive radio is: “A cognitive radio is an SDR that is aware of its environment, internal state, and location, and autonomously adjusts its operations to achieve designated objectives.” [5].

Furthermore, a cognitive cycle was defined to summarize the necessary steps composing a cognitive radio [6, 7]. These steps in a cognitive cycle are the required tasks for adaptive operation:

- *Spectrum Sensing* is the part where a radio monitors the wireless environment and detects spectrum holes. Note that in this part the radio does not generate spectrum opportunity information.
- *Spectrum Analysis* is the part where the characteristics of the spectrum hole are estimated, including the channel-state estimation and the prediction of channel capacity.
- *Spectrum Decision and Management* is the part where a cognitive radio determines transmission parameters such as data rate, transmission mode, and bandwidth according to spectrum characteristics and user requirements.

In 2002, the FCC published a report [8] prepared by the Spectrum-Policy Task Force. Among the findings and recommendations of the report, there is one: “In many bands, spectrum access is a more significant problem the physical scarcity of spectrum, in large part due to legacy command-and-control regulation that limits the ability of potential spectrum users to obtain such access.” This leads to one of the most desirable functionalities of cognitive radio, *Dynamic Spectrum Access*.

Dynamic spectrum access (DSA) was first demonstrated in 2006 by the Defense Advanced Research Projects Agency (DARPA) and Shared Spectrum Company (SSC) of Vienna, VA, which enables users of virtually any modern radio device to utilize dynamic spectrum access techniques and thereby dramatically improve spectrum efficiency, communications reliability, and deployment time. The idea of spectrum pooling and cognitive

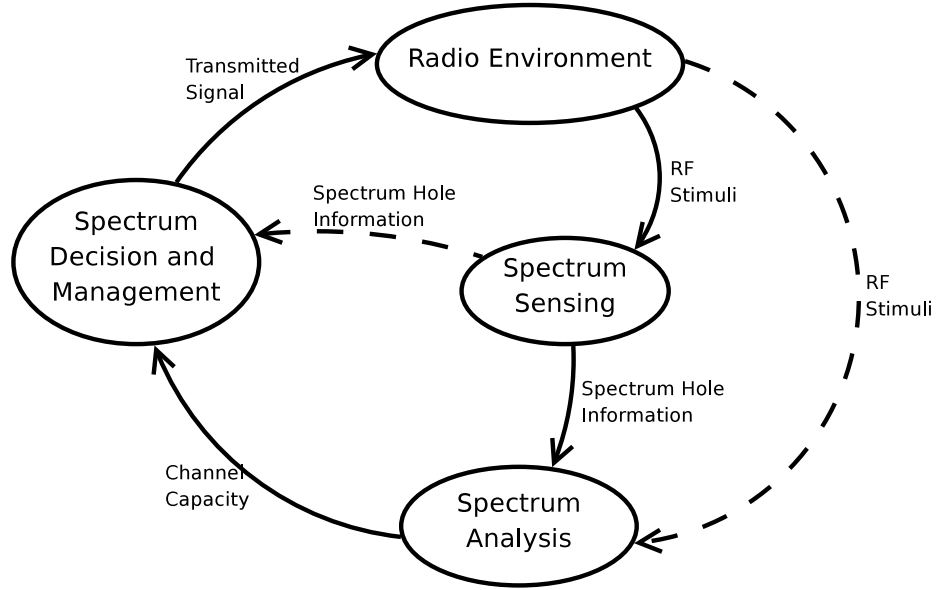

Figure 1.1: Cognitive Cycle

radio were first introduced in [9] by Mitola, which outlines the basic factors in determining the pooling strategy and in designing the radio etiquette. Further insight into the notion of spectrum pooling is provided by another paper by Weiss and Jondral[10].

Similar to [10], the dynamic spectrum access problem was first tackled in a centralized manner, where most, if not all, decisions and negotiations are made at some base stations that have full control over the network resources. For instances, in [11], dynamic spectrum access protocol (DSAP) enables a centralized entity to lease spectrum to users, and in [12], DIMSUMnet uses a centralized, regional network level brokering mechanism and lease a contiguous spectrum chunk reserved by regulating authorities according to secondary requests.

The Center for Wireless Telecommunications (CWT) in Virginia Tech has built and demonstrated the operation of a heterogeneous cognitive radio network which enabled dissimilar cooperative spectrum sensing, dynamic spectrum access, and interoperability among legacy radios and a Wi-Fi network [13]. They used a centralized broker system and WiFi control channel to notify all the nodes about channel assignments.

Zhao and Zheng looked into the distributed coordination in dynamic spectrum allocation

networks in [14] based on the assumption of fully cooperative secondary users and that each user can use one channel at a time in a channel-based wireless resource management. However, given the technology of NC-OFDM, a secondary user can be more flexible in utilizing wireless spectrum.

NC-OFDM-based transceiver systems have been proposed to be a viable solution for building a spectrum pooling system [10]. The advantages of using NC-OFDM in a spectrum pooling based cognitive radio include the flexibility in filling up the spectral gaps left behind by the licensed users in their idle periods, high data rate, and being robust to narrowband interference and frequency-selective fading. However, an important challenge in the physical layer design of an OFDM-based cognitive radio is the out-band power leakage caused by high sidelobe.

In wireless networks, especially distributed networks, conventional layered networks will encounter disturbances and performance degradation more frequently due to unstable noise, interference levels, and topology changes. Variations in noise and interference levels, together with the distance changes among nodes, will result in fluctuating *signal-to-interference-and-noise-ratio* (SINR) values at the receiver. The SINR values and the modulation schemes together can be used to determine the *bit error rate* (BER) at the receiver¹. Moreover, the requirements on the BER may vary when employing different error correction schemes and transmission applications. Therefore, it has been suggested in many articles [6, 4] that cross-layer design should better be employed in dynamic spectrum access. This is also enabled by the development of software defined radio.

Cross-layer design has been a hot research topic [15]. Vineet Srivastava *et al.* in [16] summarized several variations of cross-layer design and a few common problems such as cross-layer couplings and coexistence of cross-layer design proposals. Most researchers focus on cross-layer design considering a couple of OSI layers, using techniques such as creating new interfaces between non-adjacent layers and merging adjacent layers. A more complicated method adjusting all layers, namely vertical calibration, has not been widely looked into.

¹We would measure the actual BER and send it back to the transmitter via overhead channel.

1.3 Thesis Contributions

This thesis makes the following novel contributions to the wireless research community:

- A novel spectrum allocation approach for distributed cognitive radio networks. This proposed approach optimizes each individual wireless device and its single-hop communication links using the partial operating parameter and environmental information from adjacent devices within the wireless network.
- Two optimization approaches based on genetic algorithms (GAs), namely subcarrier-wise GA and block-wise GA. Designed quantization and fine-tuning processes to be applied to the raw results of these two optimization approaches.
- An analysis of several assisting approaches, such as quantizing variables and using adaptive variable ranges, for increasing the speed and improving the results of combined spectrum utilization/cross-layer optimization approaches
- Implementation of the optimization engine to solve the multi-objective problem using single-objective GA and Multi-Objective GA. Analyzed and compared the results of the two algorithms.

1.4 Thesis Organization

This thesis is organized as follows: Chapter 2 briefly introduces the background of this research, including general concept of cognitive radio, dynamic spectrum access, genetic algorithms, orthogonal frequency division multiplexing (OFDM), and cross-layer multi-objective optimization. In Chapter 3, the proposed distributed optimization framework for dynamic spectrum access is explained in detail. Chapter 4 describes the proposed optimization approaches based on genetic algorithms, starting with the generic framework to implementation details. Chapter 4 also includes simulation results showing the comparison of the proposed approaches and insights on how to improve performance. Finally, in Chapter 5, several conclusions are drawn and directions for future research are presented.

Chapter 2

Dynamic Spectrum Access in Wireless Cognitive Radio Network and Optimization

This chapter will give a tutorial on the following subjects. First, this chapter reviews the cognitive radio technologies, from the concept to implementation issues, and then its application in dynamic spectrum access to improve efficiency. Then the transmission technology of non-contiguous OFDM is discussed as a candidate for agile transmission in cognitive radio networks. Finally, cross-layer and multi-objective optimization using genetic algorithms are talked about as the optimization tool for a cognitive radio device as well as cognitive radio network.

2.1 Cognitive Radio Systems

Cognitive radios are highly agile wireless platforms capable of autonomously choosing device parameters based on prevailing operating conditions [6, 4]. Consequently, these wireless devices have the potential to revolutionize how society performs wireless networking. For instance, during emergency and natural disaster scenarios, centralized wireless networks may not be available due to disabled, damaged, or unpowered access points and base sta-

tions. Consequently, distributed cognitive radio networks can potentially establish wireless access in areas without an active wireless infrastructure.

The advancing of software defined radio provides a platform with reconfigurability on which we build cognitive radios. A cognitive radio device can be considered as something like in Figure 2.1. Software defined radio is a convergence of digital radio and computer software as defined in [4]. One of the most popular definitions of cognitive radio is: “A cognitive radio is an SDR that is aware of its environment, internal state, and location, and autonomously adjusts its operations to achieve designated objectives.” [5].

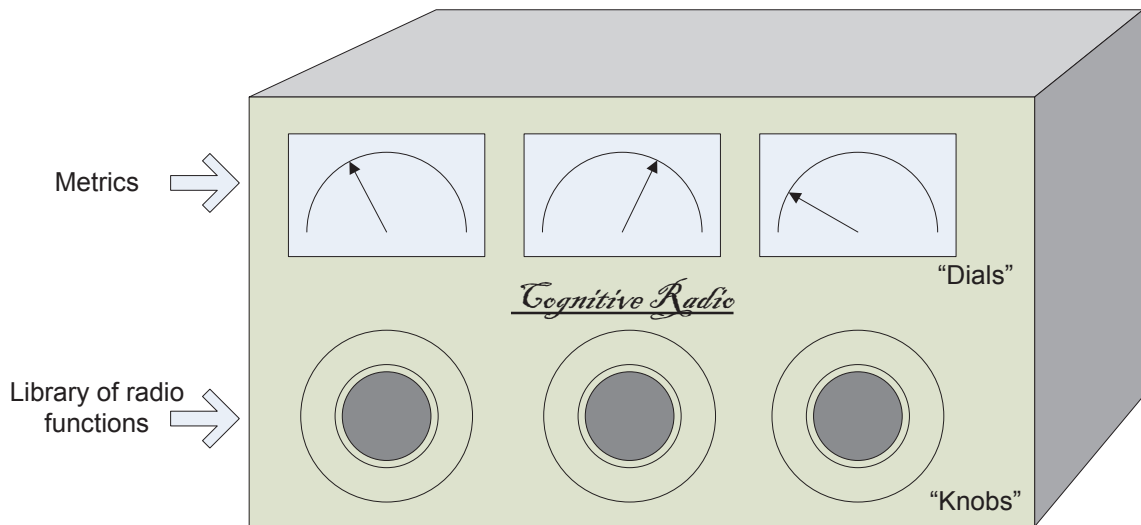

Figure 2.1: An visual illustration of a cognitive radio device

Two main characteristics of the cognitive radio can be defined as in [6, 17, 7]

- Cognitive capability: Cognitive capability refers to the ability of the radio technology to learn from its radio environment. This capability cannot be realized simply by monitoring the power in some frequency band of interest but more sophisticated techniques are required in order to capture the temporal and spatial variations in the radio environment while not interfering other users. Through this capability, the portions of the spectrum that are unused at a specific time or location can be identified. Consequently, the best spectrum and appropriate operating parameters can be

selected.

- **Reconfigurability:** The cognitive capability provides spectrum awareness whereas reconfigurability enables the radio to be dynamically programmed according to the radio environment. More specifically, the cognitive radio can be programmed to transmit and receive on a variety of frequencies and to use different transmission access technologies supported by its hardware design.

The reconfigurability enables the simultaneous optimization of multiple operating parameters across the different OSI layers of a device. This is known as *cross-layer optimization* [15], which facilitates the cognitive capability allowing the discovering and transmitting in unoccupied wireless spectrum while minimizing interference with other signals in the spectral vicinity, *i.e.*, *dynamic spectrum access* (DSA) [7].

2.2 Distributed Wireless Networks

Distributed network architectures also require the agility found in cognitive radio in order to self-organize and communicate in the absence of centralized coordination and control [18].

Cognitive radios can also be deployed in a centralized manner with the support of infrastructure. The infrastructure-based cognitive radio network also has a central entity such as a base station or an access point. In an infrastructure-based cognitive radio network, cognitive radio base stations collect observations from cognitive radio user terminals and make decisions after analyzing the observations on how to avoid interference with primary networks and on resource management.

Distributed Cognitive Radio Ad Hoc Network requires each cognitive radio to be responsible for not only observation, analyzing, and reconfiguring parameters, but also determining its actions based on local observation.

2.3 Dynamic Spectrum Access

Dynamic spectrum access (DSA) was first demonstrated in 2006 by the Defense Advanced Research Projects Agency (DARPA) and Shared Spectrum Company (SSC) of Vi-

enna, VA, which enables users of virtually any modern radio device to utilize dynamic spectrum access techniques and thereby dramatically improve spectrum efficiency, communications reliability, and deployment time. The idea of spectrum pooling and cognitive radio were first introduced in [9] by Mitola, which outlines the basic factors in determining the pooling strategy and in designing the radio etiquette. Further insight into the notion of spectrum pooling is provided by another paper by Weiss and Jondral in [10].

Dynamic spectrum access techniques allow the cognitive radio to operate in the best available channel. In order to achieve this, the users need to (1) determine (detect or predict) which portions of the spectrum is available and detect the presence of licensed users when a user operates in a licensed band (spectrum sensing), (2) select the best available channel (spectrum management), (3) coordinate access to this channel with other users (spectrum sharing), and (4) vacate the channel when a licensed user shows up and move to another portion of the spectrum (spectrum mobility).

According to [19], dynamic spectrum access can be categorized into three groups, which are *dynamic exclusive use model*, *open sharing model (spectrum common model)*, and *hierarchical access model*.

The *dynamic exclusive use model* maintains the basic structure of current spectrum regulation and introduce flexibility. This can be further divided into spectrum property rights, where licensees are allowed to sell or trade spectrum[20], and dynamic spectrum allocation, where the spectrum allocation is simply much faster than the current policy.

The *open sharing model* employs open sharing among peer users as the basis for managing a portion of spectrum. Such model is based on the successful wireless service regulation in the unlicensed industrial, scientific, and medical radio band. Game theory has been popularly used particularly in this model to analyze the competitive and cooperative behavior of individual or groups of wireless users in aspects such as power control[21, 22]. However, a number of critics have pointed out that implementing the open sharing model poses difficult challenges that have not been well addressed. A successful spectrum common will not be unregulated. Lehr *et al.* in [23] discussed some features that a suitable management protocol or etiquette will need to incorporate in open spectrum common model.

The *hierarchical access model* adopts a heterogeneous access structure composed of pri-

mary users and secondary users. The basic idea is to open licensed spectrum to secondary users while limiting the interference caused on primary users. There are two approaches for this model, which are the underlay approach, where the secondary users operate below the noise floor of primary users, and the overlay approach (opportunistic spectrum access), where secondary users only transmit in temporal and spatial spectrum holes. The hierarchical access approach is the easiest to implement in the current spectrum management policies. Examples are:

- The European Union funded DRiVE project[24] (Dynamic Radio for IP Services in Vehicular Environments) aims at enabling spectrum-efficient high-quality wireless IP communication in a heterogeneous multi-radio environment to deliver in-vehicle multimedia services. Key issues are spectrum efficiency and dynamic spectrum allocation within different radio networks, the IPv6 based network infrastructure with interworking of cellular and broadcast radio networks, as well as adaptive services for the vehicular environment with a high degree of mobility.
- KNOWS[25] is a hardware-software platform that includes a spectrum-aware Medium Access Control (MAC) protocol and algorithms to deal with spectrum fragmentation.

The Open Spectrum approach to spectrum access can achieve near-optimal utilization by allowing devices to sense and utilize available spectrum opportunistically. However, a naive distributed spectrum assignment can lead to significant interference between devices. Thus, the fairness in both centralized and distributed channel allocation would make large difference in the utilization of spectrum resources [26, 27].

2.4 Non-Contiguous Orthogonal Frequency Division Multiplexing (NC-OFDM)

Known in wireless applications as *orthogonal frequency division multiplexing* (OFDM) or in wireline applications as *discrete multitone* (DMT), these systems employ discrete Fourier transform (DFT) basis functions to create the synthesis and analysis filterbanks. The filters in the filterbanks are uniformly distributed throughout the frequency domain, with one

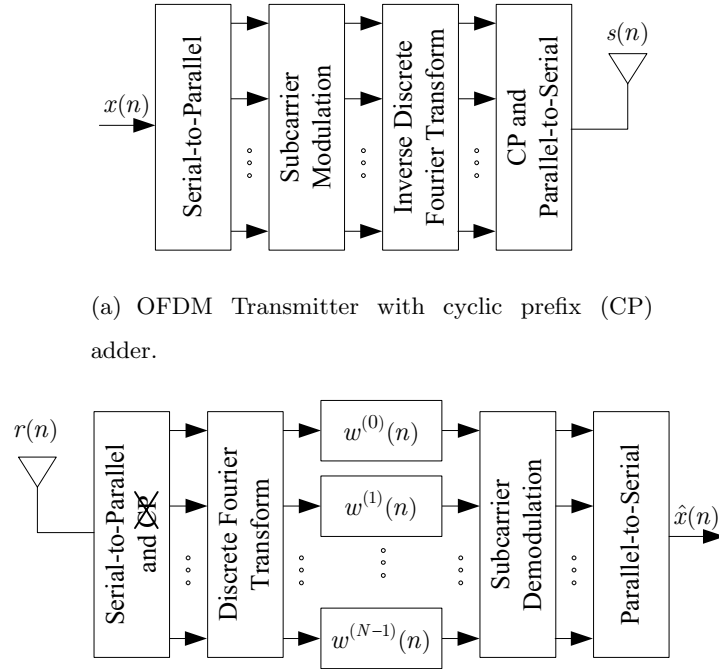

(a) OFDM Transmitter with cyclic prefix (CP) adder.

(b) OFDM Receiver with cyclic prefix remover.

Figure 2.2: Schematic of an OFDM system employing a cyclic prefix.[1]

filter centered at $\omega_0 = 0$ rad/s. Practical implementations of OFDM employ the FFT and IFFT, which results in a significant complexity reduction. As a result, OFDM/DMT has become a popular choice in many multicarrier applications, including digital audio broadcast (DAB), digital subscriber line (DSL), digital video broadcast (DVB), and wireless local area networks (WLAN) such as the IEEE 802.11a/g, the ETSI HiperLAN/2, and the MMAC HiSWAN. Without loss of generality, in OFDM, a speed data stream is modulated using M -ary phase shift keying. Then the modulated data stream is split into many slower data streams using a serial-to-parallel (S/P) converter.

A schematic of an OFDM transceiver is shown in Figure 2.2. A high-speed input stream $x(n)$ is first demultiplexed into N data streams, $x^{(k)}(n)$, $k = 0, \dots, N - 1$, using a serial-to-parallel converter, where $x^{(k)}(n)$ is the subcarrier data for subcarrier k . These streams are then individually modulated using M -QAM constellations, to yield $y^{(k)}(n)$, $k = 0, \dots, N - 1$, where $y^{(k)}(n)$ is the M -QAM-modulated subcarrier data for subcarrier k . The inverse DFT

(IDFT) is then applied to the subcarriers, defined as [28]

$$s^{(l)}(n) = \frac{1}{N} \sum_{k=0}^{N-1} y^{(k)}(n) e^{j2\pi kl/N} \quad (2.1)$$

where $l = 0, \dots, N - 1$, resulting in the subcarriers being modulated to one of N evenly spaced center frequencies in the range $[0, 2\pi)$.

Before the subcarriers are converted to form the composite signal, $s(n)$, it is necessary to add some redundancy in order to compensate for one of the main disadvantages of OFDM: low spectral selectivity. Since OFDM employs the DFT and its inverse, the filters applied to the subcarriers have a low stopband attenuation since the frequency response of the filters are of the form $\text{sinc}(x)$. Therefore, the performance of the OFDM system would significantly decrease if it were operating in a time-dispersive environment. To counteract the time-dispersiveness of the channel, a cyclic extension is employed either before the symbol (i.e., cyclic prefix) or after it (i.e., cyclic suffix) to capture this effect (the details of how the cyclic extension works will be discussed in the following subsection). Without loss of generality, the system will add a cyclic prefix to the OFDM symbol.

At the receiver, the cyclic prefix is removed from the received composite signal, $r(n)$, and converted from a serial stream into a collection of parallel streams using a serial-to-parallel converter. The DFT is applied [28]

$$\hat{y}^{(k)}(n) = \sum_{l=0}^{N-1} r^{(l)}(n) e^{-j2\pi kl/N} \quad (2.2)$$

for $k = 0, \dots, N - 1$, where $r^{(k)}(n)$, $k = 0, \dots, N - 1$, are the parallel input streams to the DFT. The subcarriers are then equalized with $w^{(k)}(n)$, $k = 0, \dots, N - 1$, to compensate for the distortion introduced by the channel. The equalized subcarriers are then demodulated before being multiplexed together using the parallel-to-serial converter, forming the output $\hat{x}(n)$.

NC-OFDM is a non-contiguous form of OFDM with some inactive subcarriers, namely carriers with zero power. Such transmission technique is designed to transmit data in non-contiguous spectrum, and has been shown to be a suitable candidate for agile transmission [29, 30]. Using NC-OFDM, secondary users can easily turn off subcarriers where

primary users occupy and use the left subcarriers to transmit data. Figure 2.3 gives an example of this flexibility.

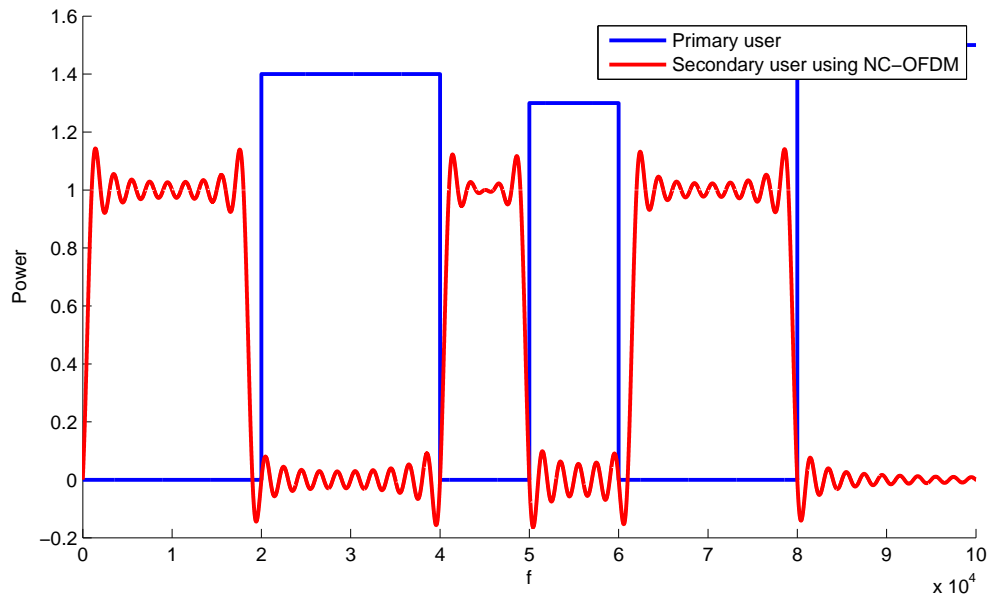

Figure 2.3: An illustration of a secondary user employing NC-OFDM in the presence of a primary user

2.5 Radio Resource Optimization Methods

2.5.1 Genetic Algorithms

Genetic algorithms are searching techniques that utilize a series of evolutionary techniques, such as *inheritance*, *mutation*, *selection*, and *crossover*, to find exact or approximate solutions to optimization or search problems [31, 32]. A genetic algorithm maintains multiple solutions. Each solution is represented by a sequence of variables. Each variable is then encoded as a part of the *chromosomes* as shown in Figure 2.4, either as several bits or as a floating number.

The computation usually starts with randomly generating a group of parameter tuples as the first generation. Then, in each generation, the fitness of every individual (solution)

parameter A (frequency)	parameter B (power)	parameter C (modulation)	parameter D (bandwidth)	...
----------------------------	------------------------	-----------------------------	----------------------------	-----

Figure 2.4: An example of encoded parameters used in Genetic Algorithms

Variables			fitness score	selected
var1	var2	...		
0.81472369	0.54688152		1.53	*
0.90579194	0.95750684		1.06	
0.12698682	0.96488854		0.56	
0.91337586	0.15761308		1.54	*
0.63235925	0.97059278		1.22	*
0.0975404	0.95716695		1.41	*
0.27849822	0.48537565		0.98	

Figure 2.5: An example of how a new population is selected and generated from a pool of chromosomes

in the population is evaluated, multiple individuals are selected from the current population based on their fitness, and recombined (crossover) and possibly randomly mutated to form a new population of solutions as in Figure 2.5. The new population is then used in the next iteration of the algorithm. Commonly, the algorithm terminates when either a maximum number of generations has been passed, or a satisfactory fitness level has been reached. If the algorithm has terminated due to a maximum number of generations, a satisfactory solution may or may not have been reached.

Genetic algorithm is a generic candidate for solving most multi-dimensional single-objective or multi-objective optimization or search problems, especially for complicated non-linear problems. Such as in [33], Hauris used genetic algorithms in cognitive radio for autonomous vehicle communications. Rondeau *et al.* also used genetic algorithm in solving problems in cognitive radio network[34]. Thus, genetic algorithms would be a attractive tool in this research.

However, generic algorithm of the general mode takes a long time to converge. In order to put genetic algorithms to practical use, we need careful modification. Modifications can be developed in all levels of genetic algorithms including the divide-and-conquer of

the original problem, modifying the solution space, and adding adaptivity to some steps of the evolution cycle, etc. More discussion about the acceleration of genetic algorithms is presented in Chapter 4.4.

2.5.2 Cross-Layer Optimization Technologies

In wireless networks, especially distributed networks, conventional layered networks will encounter disturbances and performance degradation more frequently due to unstable noise, interference levels, and topology changes. Variations in noise and interference levels, together with the distance changes among nodes, will result in fluctuating *signal-to-interference-and-noise-ratio* (SINR) values at the receiver. The SINR values and the modulation schemes together can be used to determine the *bit error rate* (BER) at the receiver¹. Moreover, the requirements on the BER may vary when employing different error correction schemes and transmission applications.

In a wireless network, besides the above dependencies among layers, there are dependencies between link layer and other layers as well. *Routing stability* and *link availability* depend on the BER and positions of nodes, and the hop number and congestion over a route determines the delay value for the transmission application. Table 2.1 gives an example of several dependencies in a wireless network.

Due to the numerous dependencies between the operating parameters and the performance objectives of the system, it is more efficient to configure across the traditional layers in order to better utilize the available resources.

Numerous researchers have looked into cross-layer optimization techniques. Lai-U Choi applied it to video streaming in [15]. A primal and dual approach was used by Mung Chiang to balance transport and physical layer in multi-hop network in [35] and by Bjrn Johansson in distributed network in [36]. Atilla Eryilmaz combined the queue-length-based resource allocation algorithm implemented at the MAC and network layers and a primal-dual congestion controller in transport layer in [37].

The general layout of a cross-layer optimization architecture is shown in Figure 2.6. Each node has a cross-layer optimization engine that takes as input a set of internal and external

¹We would measure the actual BER and send it back to the transmitter via overhead channel.

Table 2.1: Dependencies of several performance objectives on operating parameters

	Center frequency	Bit rate	TX power	Subcarrier bandwidth
Minimizing Bit error rate	✓	✓		✓
Maximizing Troughput		✓		
Minimizing Power Consumption			✓	
Minimizing Interference	✓		✓	✓

parameters obtained either by sensing environment or via overhead channels. The engine is responsible for deciding on a set of internal operating parameters across the different layers of the wireless device in order to avoid contention with other users and to satisfy user requirements with as little resource as possible.

For example, when a radio device using the framework in Figure 2.6 starts operating, it will gather external parameters through scanning the spectrum, and based on internal parameters such as modulation type and source data rate, the optimization engine will compute the possibilities and positions of spectrum holes. Then, it will report maximum data rate to application layer, choose modulation parameters in physical layer, and choose a congestion window size based on the degree of crowdedness in the spectrum and a retry limit based on the available energy on this radio device. After handshake with the receiver, the radio can get more external parameters from the receiver including bit-error-rate, noise level at the receiver, routing cost and delay to the receiver. Based on these external parameters, the optimization engine can further optimize the choices of internal parameters, such as adjusting source data rate, adjusting route selection metrics, and transmit power.

We are not focusing on incorporating many layers in this work, although this basic framework can be extended to include higher layers.

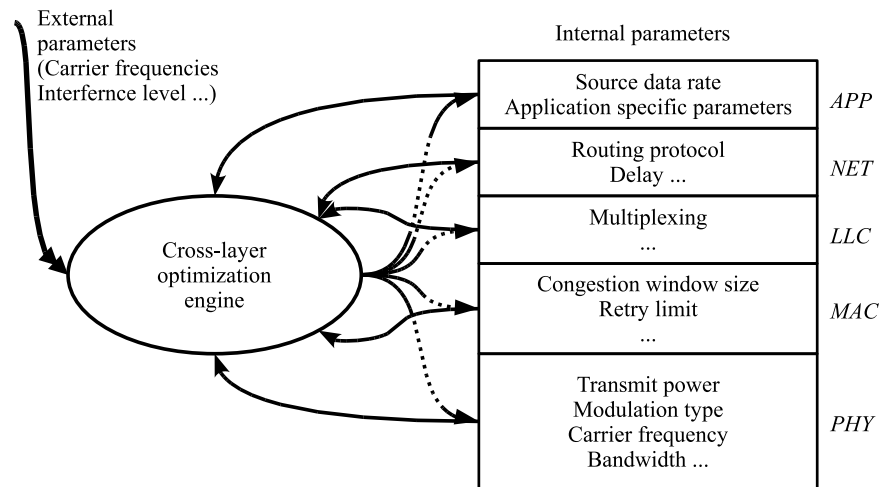

Figure 2.6: Framework of a generic cross-layer optimization architecture. The cross-layer optimization engine uses operating parameter information from the various network layers, as well as environmental parameters external to the wireless platform, in order to decide on an appropriate device configuration. This configuration is applied to the network layers of the platform.

2.5.3 Multi-Objective Optimization

There are numerous approaches for solving a multi-objective optimization [38]. Some conventional operational research methods of obtaining solutions or approaching the Pareto front are:

- Stochastic - very general, but inefficient (e.g. random walk, simulated annealing, Monte Carlo & tabu)
- Linear Programming - fast, but restricted to linearised situations only
- Gradient Based/Hill Climbing - nonlinear, applicable to smooth (differentiable) functions
- Simplex Based - nonlinear for discontinuous functions. The Simplex algorithm works by moving along adjacent bases until an optimal one is found. It works for two objectives only.

- Sequential Optimisation - ranks objectives by preference and optimises them in order (lexicographic)
- Weighting Objectives - creating a single scalar vector function to optimise, multiple runs needed
- Constraint - optimises preferred objective with others treated as constraints
- Global Criterion - minimises the distance to an ideal vector
- Homotopy techniques - Homotopy techniques aim to trace the complete Pareto curve in the bi-objective case ($n=2$). By tracing the full curve, they overcome the sampling deficiencies of the weighted-sum approach. The main drawback is that this approach does not generalize to the case of more than two objectives.
- Goal Programming - minimises deviation from target constraints. In the goal programming approach, we minimize one objective while constraining the remaining objectives to be less than given target values. This method is especially useful if the user can afford to solve just one optimization problem. However, it is not always easy to choose appropriate “goals” for the constraints. Goal programming cannot be used to generate the Pareto set effectively, particularly if the number of objectives is greater than two.
- Normal-Boundary Intersection (NBI) - The normal-boundary intersection method uses a geometrically intuitive parametrization to produce an even spread of points on the Pareto surface, giving an accurate picture of the whole surface. Even for poorly scaled problems (for which the relative scalings on the objectives are vastly different), the spread of Pareto points remains uniform. Given any point generated by NBI, it is usually possible to find a set of weights such that this point minimizes a weighted sum of objectives, as described above. Similarly, it is usually possible to define a goal programming problem for which the NBI point is a solution. NBI can also handle problems where the Pareto surface is discontinuous or non-smooth, unlike homotopy techniques. Unfortunately, a point generated by NBI may not be a Pareto

point if the boundary of the attained set in the objective space containing the Pareto points is nonconvex or ‘folded’ (which happens rarely in problems arising from actual applications). NBI requires the individual minimizers of the individual functions at the outset, which can also be viewed as a drawback.

- Multilevel programming is a one-shot optimization technique and is intended to find just one “optimal” point as opposed to the entire Pareto surface. The first step in multilevel programming involves ordering the objectives in terms of importance. Next, we find the set of points for which the minimum value of the first objective function is attained. We then find the points in this set that minimize the second most important objective. The method proceeds recursively until all objectives have been optimized on successively smaller sets.
- Game Theory - searches for Nash equilibria
- Multiattribute Utility Theory (MAUT) - maximises preferences or fitnesses

These mostly focus on the first stage of ranking the objectives, i.e. trying to reduce the design space to a more easily managed mathematical form (since most such problems are far too complex to enumerate and evaluate all the possible combinations in any reasonable time).

Since genetic algorithms are mainly used in this research, evolutionary multi-objective optimization is of more interests, which is discussed in detail in Chapter 4.2.2.

2.6 Summary

In this chapter, we reviewed several concepts related to this research, namely cognitive radio systems, distributed wireless networks, dynamic spectrum access, and NC-OFDM. And we talked about some popular techniques suitable for radio resource optimization, which are genetic algorithms, cross-layer optimization, and multi-objective optimization. We also discussed how they can be applied to distributed wireless networks.

Chapter 3

Proposed Distributed Optimization Framework

We proposed a novel distributed cross-layer optimization approach for cognitive radio wireless networks¹. Given the lack of a centralized intelligence to control the operating parameters of all the wireless devices in a distributed network, the proposed approach employs cross-layer optimization of individual wireless devices using partial operating parameter and environmental information from adjacent devices. Given all wireless links employing non-contiguous orthogonal frequency division multiplexing (NC-OFDM) and assuming stationary nodes, the proposed distributed optimization approach will attempt to minimize the bit error rate, minimize out-of-band (OOB) interference, maximize overall throughput, and minimize power consumption using a multi-objective fitness function derived in this work.

3.1 Previous Work

Distributed optimization in wireless networks has recently been an area of active research. In [26], a distributed approach for spectrum assignment was devised and it was shown that the performance of the heuristic-based algorithms is similar to the centralized

¹This was published in parts at Fifth Annual IEEE Communications Society Conference on Sensor, Mesh and Ad Hoc Communications and Networks – SECON 2008 [2] and Elsevier Computer Communications Journal in 2009 [39]

approach. A distributed optimization algorithm for multi-hop routing and scheduling is proposed in [40], where a conservative approach and an aggressive approach are incorporated to optimize network resource utilization. In [41], a distributed channel assignment mechanism in multi-radio multi-hop network is proposed where each node is equipped with multiple IEEE 802.11 wireless transceivers.

3.2 Role of the Optimization Engine

The engine is responsible for deciding on a set of internal operating parameters that are distributed across the different layers of the wireless device in order to achieve maximum performance and to coexist with other wireless devices. In our case, the engine will gather the transmit power, modulation type, and source data rate of the radio itself, and external parameters including noise level, center frequencies of other users if applicable, and scanned interference level over the spectrum. Afterwards, based on these information, the engine will compute how many NC-OFDM subcarriers are needed, their center frequencies, modulation types, and power level. Then the engine will configure the radio device accordingly.

Presently we are using genetic algorithms to implement our optimization engine. And the engine will conduct the computation based on 4 objective functions including minimizing bit-error-rate, achieving data rate requirement, minimizing power consumption, and minimizing interference with other users.

3.3 Optimization Framework for Distributed Cognitive Radio Networks

Since contention greatly impairs network performance, cooperation and optimization across several network nodes can be employed in order to minimize the occurrences of these events. In a distributed network, performance optimization and resource utilization is a more challenging task when compared to a centralized network due to the increased number of variables and the need for increased coordination between nodes. Approaches using a “super node” in order to take care of all optimization activities within the network

rely on the ability and stability of the super nodes. Consequently, the robustness of the network in terms of these optimization activities can be affected. Hence, we instead consider network optimization within a distributed optimization framework.

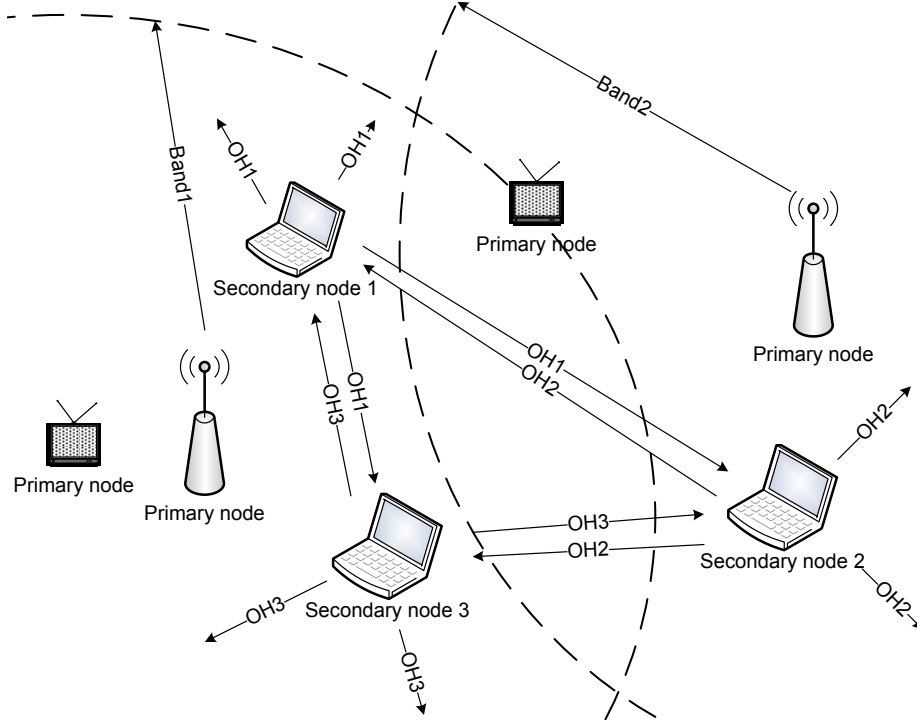

Figure 3.1: Proposed distributed optimization architecture in [2]. Overhead channels are used to share a few necessary device parameters that cannot be sensed by other devices directly, such as receiving interference level.

Figure 3.1 presents an example of the proposed distributed network architecture consisting of four wireless nodes, where adjacent nodes share overhead (OH) information about their current operating parameters and environmental conditions. We are not considering a large mesh network now, but just adjacent transmission pairs. In this context, each node represents a wireless user that possesses its own set of operating parameters (*e.g.*, modulation, power, bandwidth, center frequency), as well as its own optimization engine employing a genetic algorithm that resides on each node. The overhead channels among these four nodes are used to exchange information (*e.g.*, spectrum usage) needed by other nodes to calculate interference level among nodes in a DSA scenario.

In our work, we consider a wireless node employing *non-contiguous orthogonal frequency*

division multiplexing (NC-OFDM) [42] to transmit when it find a spectrum hole. NC-OFDM is widely considered to be a suitable candidate for spectrally-agile wireless transmission due to subcarrier scalability and robustness in frequency selective fading environments. Given the numerous operating parameters available for optimization, we have selected four variables for our framework: (i) normalized transmission power p , (ii) modulation index b , (iii) center frequency f , and (iv) bandwidth w . Given the *divide-and-conquer* nature of multicarrier transmission schemes, including NC-OFDM, each subcarrier may possess its own set of these four variables. Consequently, the optimization engine of each wireless node would simultaneously configure these operating parameters across all active subcarriers.

In order to simplify our work, we made following initial assumptions on the network we simulated. We assumed that the network parameters, such as noise level and interference profile, are time-invariant and that each node can communicate with many other nodes using NC-OFDM transmission. Note that we are not assuming unidirectional links but rather bidirectional communications.

Regardless of the choice of optimization approach employed in this work, a fitness score is required in order to assess the resulting system performance for a specific set of device operating parameters. In the following subsection, we present the mathematical development of the fitness function derived for this work.

3.3.1 Overall Multi-Objective Function

The objective of this research is to enhance the performance of a cognitive radio network using a multi-objective formulation per cognitive radio node, which includes minimizing the bit error rate, maximizing the throughput, minimizing the power usage, and minimizing the interference with other nodes. A weighted sum of the objectives is used to solve the multi-objective optimization problem. Note that one disadvantage of this method is the dependency of the weights on the performance objectives of specific applications. Most of the time, applications have requirements on measurements such as BER and throughput instead of weight values. The conversion from such measurements to weights requires extra efforts. Multi-Objective Genetic Algorithms (MOGA) resort to Pareto dominance to avoid the use of weights. However, MOGA usually needs more time to execute for the same

number of generation, making it less desirable in real-time applications.

Assuming M nodes each using N NC-ODFM subcarriers, the fitness function of a cognitive radio node is defined as [43, 44, 45]:

$$f(\bar{x}) = \sum_{i \in \{P_e, TP, P, Int\}} w_i \cdot f_i(\bar{x}) \quad (3.1)$$

where w_i are the weights and f_i are the separate fitness functions, “ P_e ” is the probability of bit error, “TP” stands for throughput, “P” for transmission power, and “Int” for interference, \bar{x} is a vector of all radio parameters, including internal parameters which a radio has complete control and external parameters which a radio can only observe, *i.e.*, if M is the number of nodes in a wireless network, then:

$$\bar{x} = \bigcup_{i=1, \dots, M} \left(\bigcup_{n=1, \dots, N} \left(\{p_{i,n}, b_{i,n}, f_{i,n}, w_{i,n}\} \right) \right). \quad (3.2)$$

Suppose each node is using NC-OFDM and has the same upper limit on number of subcarriers. Node j has L other nodes within transmission range, and it wants to communicate with node k . Subcarriers of this link are indexed by n . To simplify the equations, we only present the case when each node has only one outgoing link and one incoming link. Note that for the case with multiple outgoing and incoming links, the equations are similar as are in this simplified case except for some more summations. We just need to sum up all the links.

For some special cases where there are hard constraints on some of the four measurements (on BER, throughput, power level and interference) mentioned above, the fitness function can be modified to maximizing a few performance measurements while subject to the constraints. For instance, when there are strict requirements on P_e and the throughput, the fitness function can be modified to the following:

$$\begin{aligned} \text{maximize} \quad & f(\bar{x}) = \sum_{i=P, Int} w_i \cdot f_i(\bar{x}), \\ \text{subject to} \quad & f_i(\bar{x}) > \tau_i, i = P_e, TP. \end{aligned}$$

where τ_i is constraint value we want for a specific measurement.

3.3.2 Bit Error Rate Fitness Function

We define the first term $f_{P_e}(\bar{x})$ as:

$$f_{P_e}(\bar{x}) = \begin{cases} 1 & \text{if } \log(\overline{P_{ej}}) < \check{\tau}_{P_e} \\ \frac{\hat{\tau}_{P_e} - \log(\overline{P_{ej}})}{\hat{\tau}_{P_e} - \check{\tau}_{P_e}} & \text{if } \check{\tau}_{P_e} < \log(\overline{P_{ej}}) < \hat{\tau}_{P_e} \\ 0 & \text{if } \log(\overline{P_{ej}}) > \hat{\tau}_{P_e} \end{cases}$$

where $\overline{P_{ej}}$ is the average bit error rate (BER) of all the subcarriers of this link between node j and node k . Since P_e has a range from 0 to 0.5, this definition maps P_e to $[0,1]$. There are two thresholds used in this definition. When $\overline{P_{ej}}$ falls below $\check{\tau}_{P_e}$, this means that the receiver can recover the transmitted information completely, such that we can consider $\overline{P_{ej}}$ lower than this threshold as zero bit error rate. When $\overline{P_{ej}}$ is greater than $\hat{\tau}_{P_e}$, it means we cannot recover anything from the corrupted receiving signal. These two threshold can be set according to modulation and error correction techniques used in a particular transmission. Not likethe weight values in this weighted sum method, these two thresholds are simply the BER requirements of applications. Applications usually have straightforward BER requirements, thus it is clear how to set these thresholds. The same applies to other thresholds described in the following sections.

In general, P_e is calculated from symbol error rate (SER) by:

$$(1 - P_e)^b = 1 - \text{SER}.$$

The SER can be estimated either through direct detection or calculation using noise, modulation index, and $(\gamma_{(j,k)})_n$, where $(\gamma_{(j,k)})_n$ is the interference caused by all the existing radios on subcarrier n of radio j [46]. The value of $(\gamma_{(j,k)})_n$ can be sensed from environment by the node.

3.3.3 Throughput Fitness Function

This function measures the throughput of a transmission. f_{TP} can be defined as:

$$f_{\text{TP}}(\bar{x}) = \begin{cases} 0, & \sum_{n=0}^{N-1} b_n < \check{\tau}_{\text{TP}} \\ \frac{\sum_{n=0}^{N-1} b_n - \check{\tau}_{\text{TP}}}{\hat{\tau}_{\text{TP}} - \check{\tau}_{\text{TP}}}, & \check{\tau}_{\text{TP}} < \sum_{n=0}^{N-1} b_n < \hat{\tau}_{\text{TP}} \\ 1, & \sum_{n=0}^{N-1} b_n > \hat{\tau}_{\text{TP}} \end{cases}$$

where b_n is the modulation index of subcarrier n of the link between node j and k , and b_{max} is the maximum achievable modulation index. Given that P_e is considered in f_{P_e} , this separate fitness function only considers the data rate by measuring b , *i.e.*, the number of bit per symbol. Then, f_{P_e} and f_{TP} will balance with each other to satisfy the different application requirements. For example, in data transmission, if a relatively low P_e is granted, the fitness score will depend primarily on data rate. Conversely in a voice transmission, a higher P_e can be acceptable if constant data rate is satisfied.

Note that $\check{\tau}_{\text{TP}}$ and $\hat{\tau}_{\text{TP}}$ are two thresholds that define an interval of realistic throughput values. For instance, $\hat{\tau}_{\text{TP}}$ defines the target throughput that is aimed by this transmission. When the total throughput exceeds this threshold, more throughput will not bring any larger performance improvement. Furthermore, if throughput falls below $\check{\tau}_{\text{TP}}$, no utility can be obtained from this transmission. The $\hat{\tau}_{\text{TP}}$ can be set to be either greater than or lower than $N \times b_{\text{max}}$, which is the maximal achievable throughput of this transmission pair.

3.3.4 Transmission Power Fitness Function

This function is a necessary component in the optimization when considering portable devices, whose energy supply is limited. We can express f_P as:

$$f_P(\bar{x}) = 1 - \frac{\sum_{n=0}^{N-1} P_{j_n}}{N \times P_{\text{max}}}$$

where P_{j_n} is the part of transmitting power of subcarrier n of link (j,k) beyond the minimum power consumption, P_{max} is the maximum achievable transmitting power for one subcarrier of radio j . We are trying to minimize power consumption, therefore the larger

the transmission power, the lower the f_P . However, we do not consider the energy issue in this work.

3.3.5 Interference Fitness Function

The last term, $f_{\text{Int}}(\bar{x})$, addresses the interference caused by radio j on other radios in the network. In reality, this measurement cannot be sensed directly by radio j . This value can be obtained either by overhead channel between radio j and other radios or estimating through other environmental parameters such as central frequencies and transmission power of other radios. In our simulator, its calculation is expanded as:

$$f_{\text{Int}}(\bar{x}) = \begin{cases} 1, & \sum \text{Int} < \check{\tau}_{\text{Int}} \\ \frac{\hat{\tau}_{\text{Int}} - \sum \text{Int}}{\check{\tau}_{\text{Int}} - \hat{\tau}_{\text{Int}}}, & \check{\tau}_{\text{Int}} < \sum \text{Int} < \hat{\tau}_{\text{Int}} \\ 0, & \sum \text{Int} > \hat{\tau}_{\text{Int}} \end{cases}$$

where

$$\sum \text{Int} = \sum_{\substack{l=0 \\ l \neq k \\ l \neq j}}^{L-1} \frac{I_{(j,l)}}{P_l}$$

and $I_{(j,l)}$ is the interference caused by radio j on radio l and P_l is receiving signal power level of radio l . Note that $\check{\tau}_{\text{Int}}$ is the lower threshold on interference. Interference below this threshold will be considered as no interference, while interference greater than $\hat{\tau}_{\text{Int}}$ is considered as non-acceptable.

Not all the thresholds (τ) are actually used. If no thresholds are set by an application, they can be easily removed. The values of BER and interference all depend on the frequency locations of subcarriers. The choice of subcarrier frequency locations will be determined by the fitness functions when attempting to maximize the performance objectives.

3.3.6 Initial result

Figure 3.2 is an initial result using all these fitness functions in a genetic optimization framework to get the solution. We used a weighted sum to combine all the four fitness functions. The population size is set to 200. After 200 generations, the total fitness score

grows from 0.68 to 0.84. In this result, no threshold τ is used, thus it is impossible to achieve a total fitness score of 1.

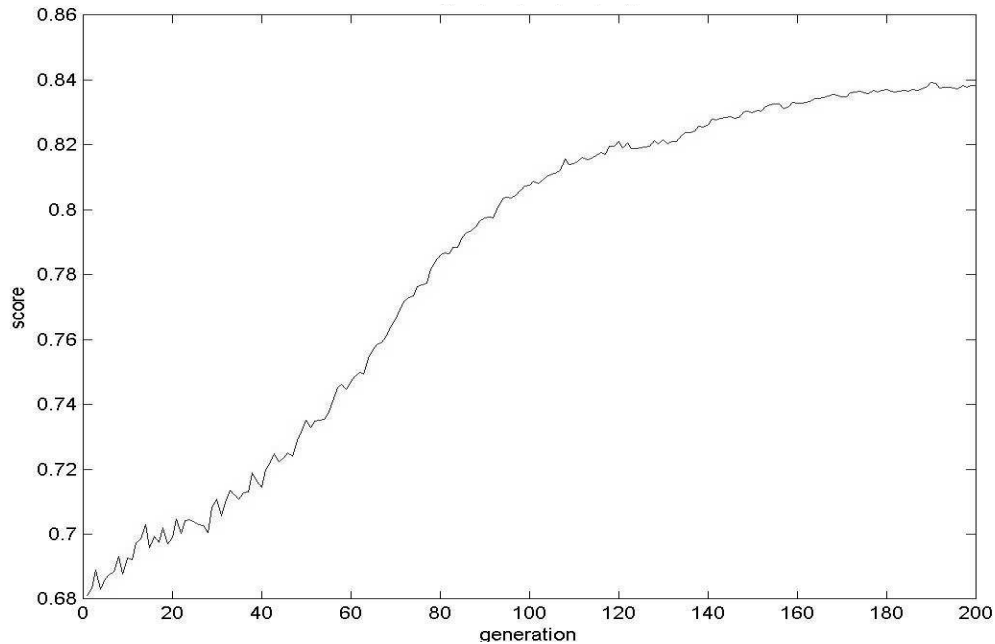

Figure 3.2: Improvement of fitness score over generations. The four fitness functions are combined in a weighted sum

3.4 Dynamic Spectrum Access Iteration

When another transmission appears, current transmissions will suffer more interference. Reallocating the whole bunch of subcarriers for each transmission requires too much time and causes delay. In this architecture, to deal with such situation, radios will keep track of the BER of each subcarrier. When an unacceptable BER is detected, radio will turn off that subcarrier and reallocate it to another available place on spectrum using either SCGA or BGSA. Those subcarriers that are in good conditions will remain unchanged. To obtain another available place on the spectrum, this radio can either use blank space recorded from last spectrum scanning if the data has not expired, or do another genetic algorithm based search on the spectrum if otherwise.

3.5 Summary

In this chapter, we concluded the cross-layer distributed optimization framework we proposed. We particularly described the optimization engine and the derivation of the four fitness functions, namely bitrate function, throughput function, transmission power function, and interference function. We also briefly talked about a simple approach to apply this framework dynamically into wireless resource sharing iterations. But advanced dynamic spectrum access mechanism is left for future work.

Chapter 4

Proposed Implementation of Optimization Approaches

In this chapter, we present our proposed implementation of two optimization approaches based on genetic algorithms (GAs), namely subcarrier-wise GA and block-wise GA. And we analyzed several approaches implemented via genetic algorithms (GA), such as quantizing variables, using adaptive variable ranges, and Multi-Objective Genetic Algorithms, for increasing the speed and improving the results of combined spectrum utilization/cross-layer optimization approaches proposed, together with several assisting processes and modifications devised to make the optimization to improve efficiency and execution time.

4.1 Generic Framework

In this section, we will talk about the generic framework of the optimization process¹. We designed two approaches to solve the optimization problem. And these two approaches are independent of the method to solve a more detailed multi-objective problem, which will be discussed later in this chapter. These two approaches are the interfaces between the more general optimization framework and the more detailed multi-objective optimization techniques.

¹This was published in parts at 4th International Conference on Cognitive Radio Oriented Wireless Networks and Communications – CrownCom 2009 – CrownCom 2009[47]

4.1.1 Proposed Serial Subcarrier-Wise Genetic Algorithm Optimization Approach (SCGA)

Initially, the most simple approach using genetic algorithm would be to code all variables into a chromosome. However, this result in a huge solution space where the converge of genetic algorithm is very slow. Therefore, we proposed this algorithm based on a *divide-and-conquer* paradigm, which exploits the multicarrier structure of NC-OFDM transmission. Consequently, the input variables consist of just one subcarrier.

One difference with respect to a conventional genetic algorithm is that we need a fitness function per subcarrier rather than across the entire transmission. Since there is some correlation between subcarriers, the SINR partly depends on the transmission power levels of other subcarriers within the same link, making it difficult to implement parallel genetic algorithms in this case. Therefore, we designed this optimization approach using a serial genetic algorithm optimization approach as shown in Figure 4.1. The allocation process of all subcarriers is executed in a cascading fashion, with the latter subcarriers having to take into account the optimization results of previous subcarriers so as to avoid interference with them. It is inevitable that the latter subcarriers are faced with fewer resources and more constraints than the previous ones. Ideally, allocation of latter subcarriers shall not cause an unacceptable performance degradation with the previous subcarriers since the GA engine will take into account of maintaining all the previous allocated subcarriers. However, given the limited running time, a GA engine may not always find a solution that meets all requirements.

In case we should continue the optimization processes afterwards to achieve better fitness scores, we would need to save a population file for each subcarrier in order to continue. In this method, a single GA optimization engine is still executed by the node, but the task for the engine is narrowed down to a single subcarrier at one time.

Data Rate Oriented Approach: Since wireless applications usually have requirements on data rates instead of number of subcarriers, it is important to design optimization approaches that is data rate oriented. As for the serial subcarrier-wise optimization approach, it is relatively simple to be data rate oriented. The idea is to load bits on subcarriers serially

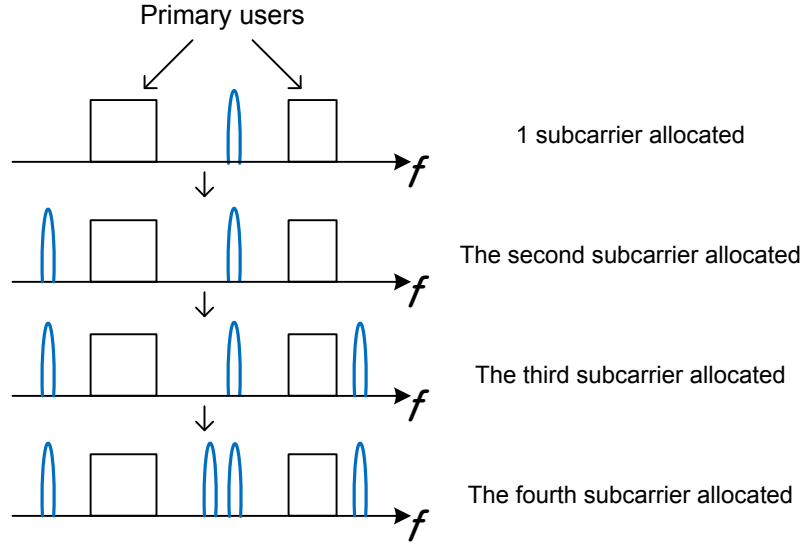

Figure 4.1: Illustration of SCGA process to allocate secondary subcarriers in the presence of primary users.

until the sum of bit rates per subcarrier meets the requirement.

4.1.2 Proposed Block-Wise Genetic Algorithm Optimization Approach (BGSA)

When the number of subcarriers is large, coupled with a significant amount of available wireless spectrum, employing the subcarrier-wise optimization serially would result in a very lengthy search for a final solution, and even longer for a final solution. Moreover, a conventional genetic algorithm optimization would result in the fragmentation of secondary user spectrum allocation. Consequently, we developed a block-wise genetic algorithm optimization approach.

The basic idea of BGSA is a binary recursion algorithm as shown in Figure 4.2. First, the algorithm searches for a continuous space of spectrum for the whole set of secondary user subcarriers. If the attempt succeeds, the search is finished. Otherwise, the algorithm divides the set of secondary user subcarriers into two halves and try to allocate a continuous space for each of them one after the other. If any of the two half-bandwidth allocation processes cannot identify an available band of spectrum, divide those unallocated subcarrier blocks

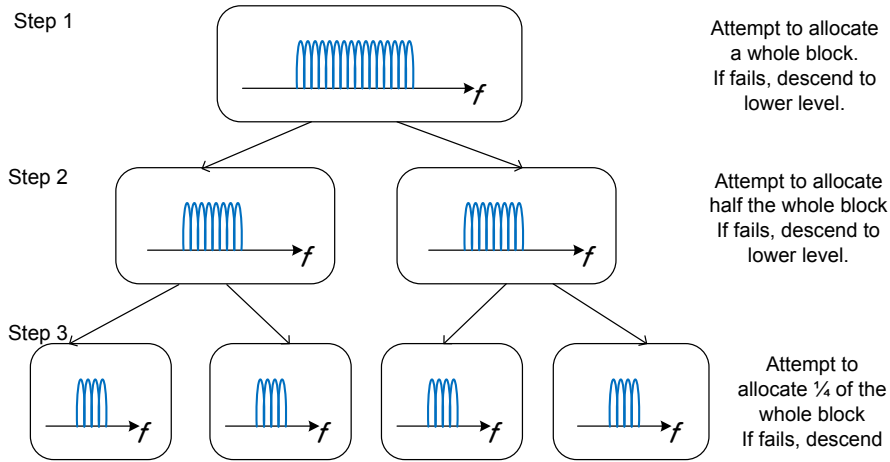

Figure 4.2: Binary recursion for BGSA approach.

into two halves and iterate. When an allocation attempt fails at some level, all the following attempts will start from the lower level to save time. In the end, if the available spectrum resource is not adequate, this approach will ultimately search for unoccupied spectrum that would accommodate a single subcarrier, and the algorithm will degenerate to SCGA. If any one allocation process for a single subcarrier fails, this algorithm ends since no more subcarriers can be accommodated in the target spectrum band.

Since the numbers of decision variables at each level are different, several genetic algorithm parameters need to be adjusted before each run. Moreover a global variable is used to record the block size of last successful allocation attempt. This would avoid vain attempts of allocating large blocks.

Data Rate Oriented Approach: Similar to that in serial subcarrier-wise GA approach, here we also designed a datarate oriented modification for block-wise GA approach. For the sake of spectrum efficiency, we want our radio to use as little spectrum as possible, which means we want to squeeze as many bits into as less subcarriers. Figure 4.3 shows how this approach works. We start from the largest value of bits per symbol per subcarrier and proceed until all bits are loaded and the requirements on bit error rate are satisfied.

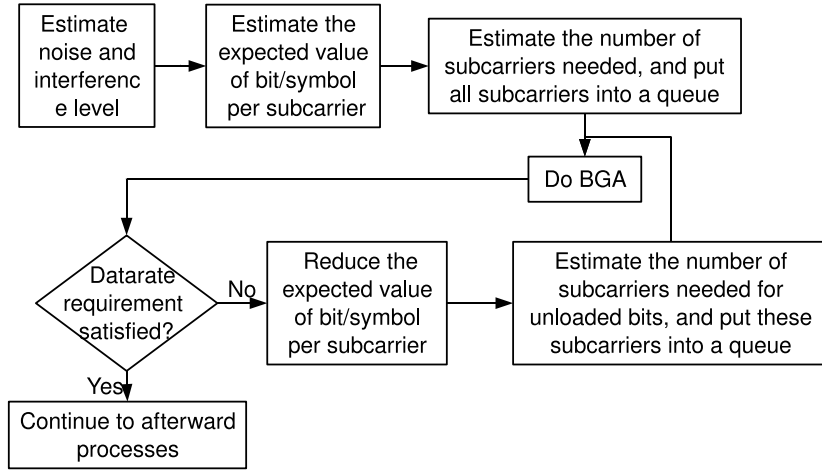

Figure 4.3: A flowchart of a “noble” approach to data rate-oriented BGSAs.

4.1.3 Constraint Handling

For some special cases where there are hard constraints on some of the four measurements (on BER, throughput, power level and interference) mentioned above, the objective function can be modified to maximizing a few performance measurements while subject to the constraints. For instance, when there are strict requirements on P_e and the throughput, the objective function can be modified to the following:

$$\begin{aligned}
 &\text{maximize} && f(\bar{x}) = \sum_{i=P, \text{Int}} w_i \cdot f_i(\bar{x}), \\
 &\text{subject to} && f_i(\bar{x}) > 0, i = P_e, \text{TP}.
 \end{aligned}$$

4.2 Multi-Objective Optimization Algorithms

There has been extensive research with respect to multi-objective optimization problems. In this section, we will talk about two methods we chose that are suitable for this particular problem, which is not linear, without strict preference on objectives, and without a continuous solution space.

4.2.1 Weighted-Sum Method

Weighted sum method is also called the method of aggregating functions. In this method, a weighted sum of the objectives is used to convert a multi-objective optimization problem to a single-objective optimization problem. One disadvantage of this method is that the weights of these objectives depend on specific application requirements and need to be adjusted carefully. Another controversial disadvantage of such method is that a linear weighted sum may not be capable of describing a non-convex solution space regardless of the weight combination used.

The weighted sum of objective functions of a cognitive radio node is defined as [43]:

$$f(\bar{x}) = \sum_{i=P_e,TP,P,Int} w_i \cdot f_i(\bar{x}) \quad (4.1)$$

where w_i are the weights and f_i are the separate objective functions, "TP" stands for throughput, "P" for transmission power, and "Int" for interference, \bar{x} is a vector of all radio parameters, including internal parameters which a radio has complete control and external parameters which a radio can only observe, *i.e.* if M is the number of nodes in a wireless network,

$$\bar{x} = \bigcup_{i=1,\dots,M} \left(\bigcup_{n=1,\dots,N} \{p_{i,n}, b_{i,n}, f_{i,n}, w_{i,n}\} \right)$$

4.2.2 Pareto Optimization

90% of the approaches to multi-objective optimization aimed to approximate the true Pareto front for the underlying problem. Although we are not aiming at generating the full Pareto front for this distributed spectrum utilization problem, Pareto based Multi-Objective Genetic Algorithm (MOGA) is still a good candidate for the solution technique of the problem. Therefore, we propose to use MOGA so solve this combined spectrum utilization/cross-layer optimization problem.

Among many variations of MOGA, we chose the non-dominated sorting genetic algorithm II (NSGA-II) as a representative [48]. This method includes fast non-dominated sorting approach, elitism, and diversity preservation.

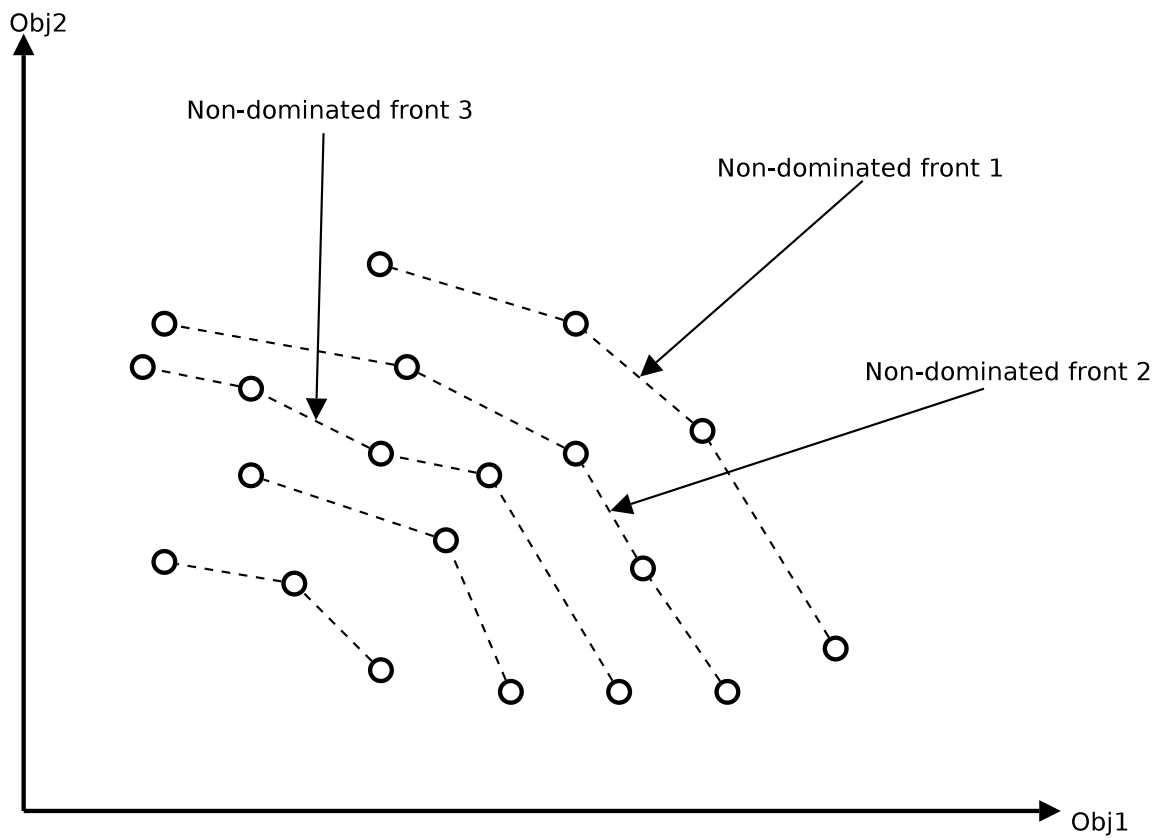

Figure 4.4: Non-dominated sorting is shown

Pareto dominance says a vector x strictly dominates a vector y if each parameter of x is no greater than the corresponding parameter of y and at least one parameter is strictly less. The optimal solutions to a multi-objective optimization problem are non-dominated solutions. In NSGA, before the selection is performed, the population is ranked on the basis of nondomination of all individuals as shown in Figure 4.4. Non-dominated individuals are identified to constitute the first non-dominated front and are assigned the same large dummy fitness value. Then in order to maintain diversity, *sharing* is performed through selection operation using degraded fitness values obtained by dividing the original fitness value of an individual by a quantity proportional to the number of individuals around it. After sharing, same procedures are applied on the rest of the population until the entire population is classified into several fronts. Then the population is reproduced according to dummy fitness values. Individuals with higher dummy fitness values get more copies. This results in convergence of the population towards non-dominated regions and sharing helps to distribute it over this region.

4.3 Implementation of Optimization Approaches

4.3.1 Quantization of Subcarrier Spacing for One-FFT Implementation

In order to facilitate NC-OFDM implementation using one fast Fourier transformation (FFT), the frequency locations of the subcarriers in one transmission have to be uniformly spaced. This uniform spacing also helps reduce the interference among subcarriers within one transmission because such that each subcarrier has a center frequency located at the zero crossing point of the sidelobes of other subcarriers. An example showing the difference is given in Figure 4.5.

Given the subcarrier center frequencies obtained from GA search, we first quantize them to a grid with a spacing equal to subcarrier bandwidth and an arbitrary offset. Then we shift the grid and the quantized frequency locations to find the offset with the lowest bit error rate. This process is likely to introduce more interference between transmissions on some area of the spectrum, since it will move subcarriers out of their optimal locations. Consequently, we add another modification called fine-tuning.

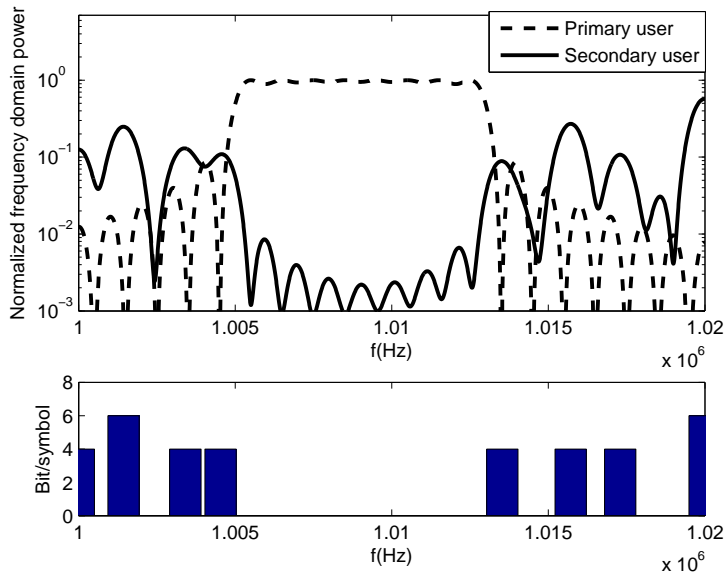

(a) Example of subcarriers with non-quantized centerfrequencies

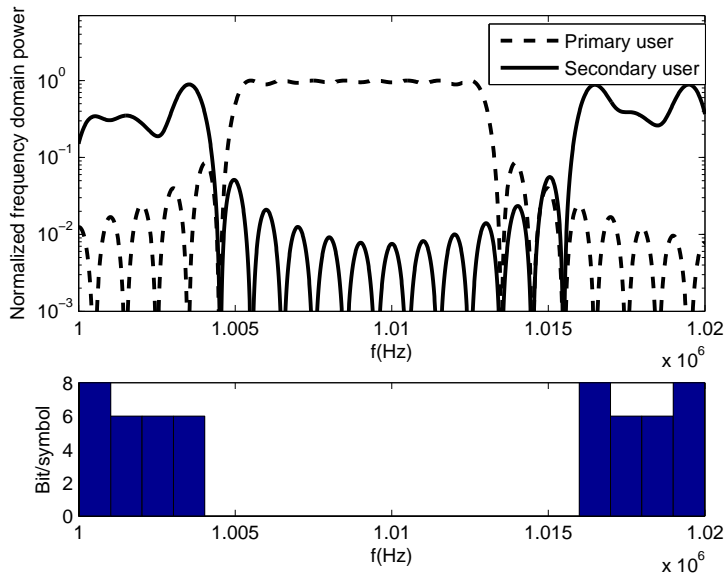

(b) Example of subcarrier with quantized center frequencies

Figure 4.5: Comparison of spectrum when subcarrier frequencies are not quantized and when they are quantized

In fine-tuning process, for each subcarrier whose BER is above threshold, we “wobble” it to its several adjacent quantized frequency locations to see whether there is a better frequency location with lower BER and interference. This requires some more environment sensing, and the reason for quantized frequencies is to make one-FFT implementation possible. If it fails to find a better location in the most adjacent region, we will try looking at some further regions. If that does not work either, we have to reduce its value of bit per symbol in an hope to reduce BER. After several such iteration, if the value of bit per symbol drops to zero, the radio has to give up allocating subcarriers in this region and look at somewhere else. In Figure 4.6 is the flowchart for the quantization, shifting and fine-tuning. The initial solution from GA optimization engine is quantized and modified to a frequency offset with less interference. Then the solution is processed by the fine-tuning process, which re-arrange the subcarriers to reduce interference even more. Some steps can be skipped if quick solutions are needed.

4.4 Approaches to Accelerate Optimization

Genetic algorithms have been criticized for being time-consuming and numerical intensive. Many modifications, most of which focusing on MOGA, have been proposed on how to manipulates the population and to conduct evolutionary operations to improve speed and optimality. However, through exploring various possibilities to improve the performance of these genetic algorithm based optimization approaches, we found that how to apply genetic algorithms is more critical than how genetic algorithm works. In this section, we propose several approaches to accelerate the optimization and to achieve a better result at the same time.

4.4.1 Quantized Variables

Genetic algorithms are capable of finding optimal on a solution space of integers as well as floating numbers. To find the optimal, it is tempting to make variables floating numbers. However, integer variables tremendously reduce the size of solution space and consequently increase the speed of search. The distributed spectrum utilization problem is a real time

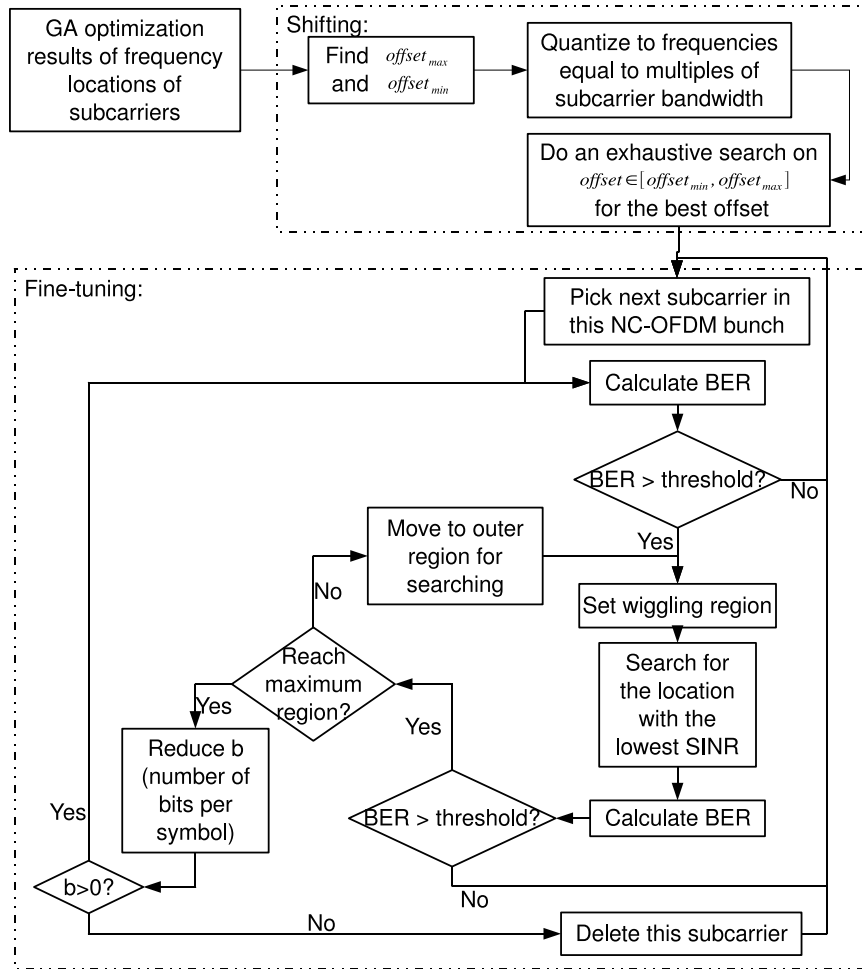

Figure 4.6: Flowchart of quantization and fine-tuning.

search in a possibly dynamic wireless environment. Consequently we have to sacrifice some degree of optimality for the sake of speed. Integer, in other words quantized, variables are especially desirable when the 100% optimal is unstable while a 95% suboptimal is acceptable for users.

4.4.2 Adaptive Variable Ranges

There has been research work on improving the performance of genetic algorithms by having adaptive population size and adaptive mutation rates. Here we look into adaptive

variable ranges.

Making variable ranges adaptive is another way to reduce solution space. It is desirable to have large variable ranges when little is known about the wireless environment, such as the noise level, primary user occupancy statistics, and channel fading profile. However, after we have obtained some knowledge about the wireless environment, we can reduce variable ranges to smaller ranges where the optimal are more likely to be found. For example, if we know from previous searches that the receiving SNR is too high for 256-QAM and low enough for modulations higher than 4-QAM, we can eliminate these two modulation candidates from our solution space. Figure 4.7 shows an example of difference between non-adaptive variable ranges and adaptive variable ranges. When using adaptive variable ranges, we can reduce the number of possible modulation schemes from four down to two, i.e. eliminating 256-QAM and 4-QAM, leaving 16-QAM and 64-QAM.

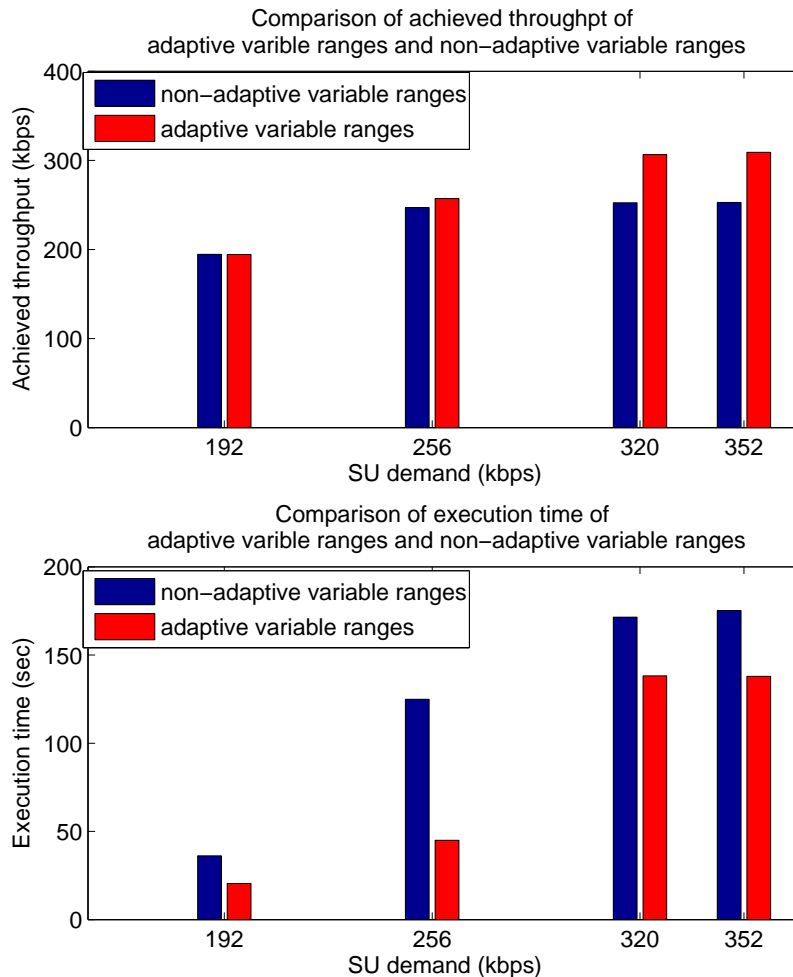

Figure 4.7: Example of comparison of searches using non-adaptive variable ranges and adaptive variable ranges (Using NSGA, BGSA, 5 objectives and 0 constraints)

4.4.3 Manipulating Constraints and Objectives

Genetic algorithms allow the use of constraints on selecting valid individuals. Each new individual is subject to some tests when generated. Valid individuals are allowed to enter the following evolutionary operations such as crossover and mutation. In the multi-objective optimization of real distributed spectrum utilization problems, objectives and constraints are sometimes interchangeable. For example, the goal of minimizing interference can be implemented as either an minimizing objective or a constraint that the interference

level cannot surpass a threshold, or both together. It would be interesting to know what combination of objectives and constraints leads to the best result.

4.5 Simulation Results

4.5.1 Simulation Parameters

Four nodes are positioned at corners of a square with a diagonal of 20 meters. Path gain is calculated as $1/d^2$, where d is the distance. Primary and secondary user transmissions are deployed among those four nodes. Each subcarrier is supposed to be 1 kHz wide. Transmission power is normalized to $[0.1,1]$. Allowed values of bit/symbol are 2, 4, 6, and 8.

4.5.2 Optimization Results

Simple case

The available bandwidth for these four nodes is 20 kHz, and each subcarrier is assumed to be 1 kHz wide.

The solution space for a conventional GA over 200 generations is intractable, all the parameters are employed at the same time. As a result, we only compare the proposed SCGA and BGSA here. Figs. 4.8 and 4.9 show the optimization results of SCGA and BGSA when trying to maximize throughput with constraints that maximum BER has to be less than 0.001 and maximum interference has to be less than -30 dB down from the primary user in Scenario 1.

The constraints on the BER and interference are set since these requirements are usually specified tightly in wireless transmission. The top figures in Figs. 4.8 and 4.9 show the resulting spectrum after the optimization, and the bottom figures show the numbers of bits per symbol allocated to those corresponding subcarriers. The sum of bits per symbol of each subcarrier in each figure indicates the total throughput performance of that approach.

Both approaches provide results satisfying the two constraints, but their throughput performances are different. This depends on whether they can find the most optimal lo-

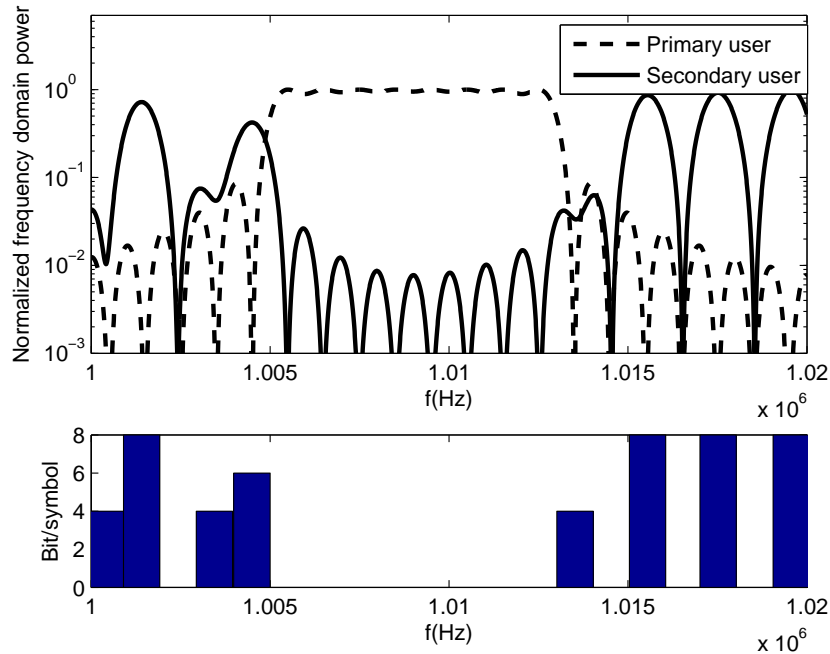

Figure 4.8: Simple case: Optimization results of SCGA trying to maximize throughput when BER constraint is 0.001 and interference constraint is -30 dB

cations on the spectrum to accommodate subcarriers. SCGA achieves a larger throughput than conventional GA, and BGSA achieves an even larger throughput.

Since these optimization approaches are implemented using genetic algorithms, there is uncertainty in the results. Sometimes the SCGA does well when foregoing subcarriers happen to pick good positions making situation easy for latter subcarriers. However, the BGSA always finds a results with all subcarriers having similar power levels.

In the above simulation, the optimization engine is supposed to allocate eight 1 kHz subcarriers given blank spectrum of totally 12 kHz. From Figure 4.8 and Figure 4.9, we can see that spectrum fragmentation is more severe in the result SCGA. The eight subcarriers are segregated into 8 parts. The segregation phenomenon is a minus in spectrum allocation because it increases the complexity for latter users to find available spectrum. A defragmentation process will be needed to improve the tidiness of spectrum. A similar concept to this is the memory fragmentation in multi-task problem in computer engineering. This result highlights the importance of the propose of BGSA algorithm, which greatly allevi-

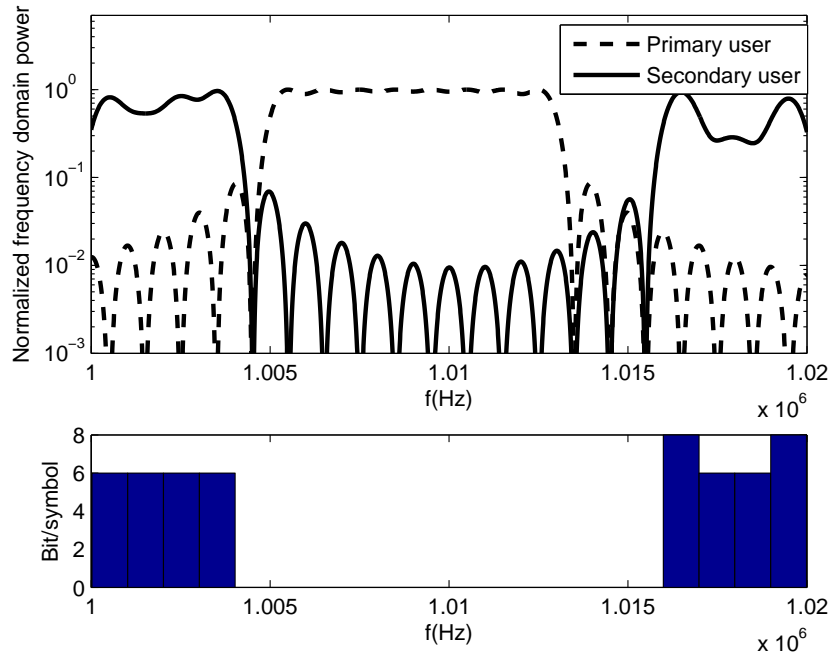

Figure 4.9: Simple case: Optimization results of BGSMA trying to maximize throughput when BER constraint is 0.001 and interference constraint is -30 dB

ates spectrum fragmentation. The spectrum fragmentation problem is more severe when the available spectrum is large.

Figs. 4.10 and 4.11 show the sequence of power level and bit per symbol of subcarriers in the results of SCGA and BGSMA in Scenario 2. It can be observed that the transmission power and bits per symbol per subcarriers in the result for the SCGA algorithm drop much faster. The drop in bits per symbol means the algorithm cannot find a good position to accommodate high data rate for the subcarrier. Since power efficiency is not considered in this simulation, the drop in power level means the algorithm cannot accommodate the subcarrier to meet the interference constraint without sacrificing signal power. As a result, they have to sacrifice the number of bit per symbol to satisfy their own BER constraints. Due to the lack of collaboration among subcarriers, the latter subcarriers are faced with more harsh situation. The fast drop in the result for the SCGA algorithm can be seen as the consequence caused by spectrum fragmentation.

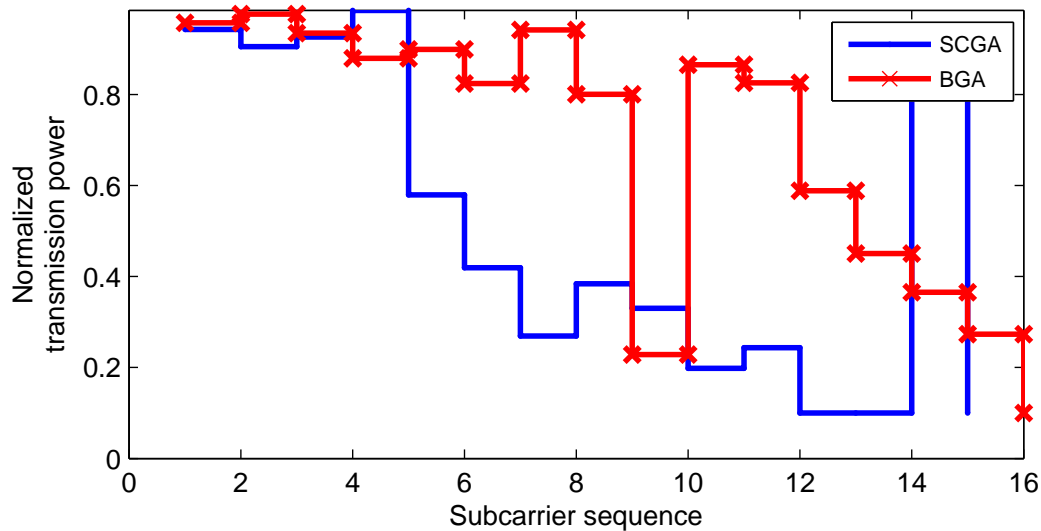

Figure 4.10: Scenario 2: Comparison of transmission power of subcarriers in the results of SCGA and BGSA

More complicated scenario

Available bandwidth for these nodes is 100 kHz, and each subcarrier is assumed to be 1 kHz wide. Since each node is using NC-OFDM, there exists the potential for high out-of-band side lobes [49].

In Figs. 4.12 and 4.13, we show two results of the spectrum allocation process using SCGA and BGSA, respectively. The dashed lines indicate primary user spectrum, and the solid lines indicates secondary user spectrum. The top figures show the resulting spectrum, while the bottom figures show the numbers of bit per symbol allocated to those corresponding subcarriers; the sum of bit per symbol of each subcarrier in each figure indicates the total throughput performance of that approach.

In the results for the BGSA, the secondary users are able to achieve a total throughput of 256 kbps given a segmented spectrum of 50 kHz in total, while SCGA only achieves 210 kbps. Moreover, spectrum fragmentation is more severe in the result of SCGA, which partly results in the lower throughput. Subcarriers are more separated and subcarriers of different secondary users are more mingled than in the result of BGSA. The segregation phenomenon is a minus in spectrum allocation because it increases the complexity for latter

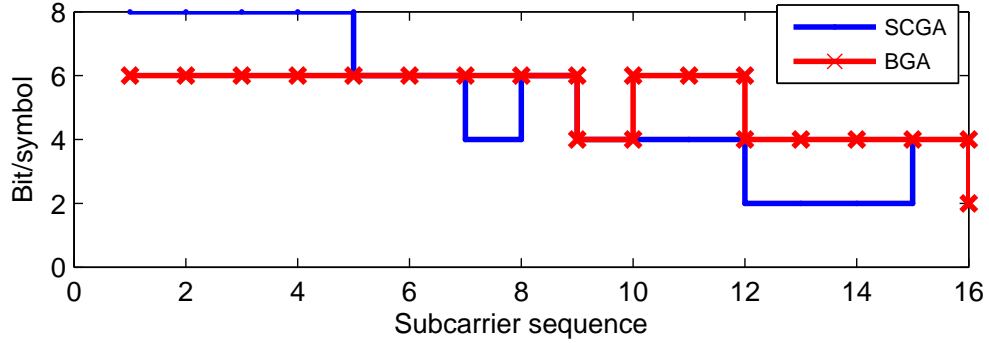

Figure 4.11: Scenario 2: Comparison of bit per symbol of subcarriers in the results of SCGA and BGSA

users to find available spectrum, and creates lots of thin slices of spectrum that are too small to allocate to a subcarrier or have too much interference in it.

Figs. 4.14 and 4.15 shows a comparison of throughput performance and demand satisfaction of SCGA and BGSA with different throughput demand from secondary users. The comparison is performed in the same wireless environment as shown in Figure 4.12 and Figure 4.13. Due to the guard bands of the primary users, the maximum throughput for secondary user is 284 kbps, as indicated by the blue dashed line. The highest throughput that can be achieved by BGSA is about 260 kbps. BGSA starts to outperform SCGA when the throughput demand gets higher and closer to the maximum achievable throughput. Referring to Figure 4.12 and Figure 4.13, such a difference is the result of spectrum fragmentation. In addition, BGSA also runs faster than SCGA when the throughput demand gets closer to the maximum achievable throughput.

4.5.3 Effects of Quantization, Shifting and fine-tuning

Because of the nature of NC-OFDM, a small shift in center frequency location can result in dramatic drop in SINR. And since different parts of spectrum may have different noise and interference profiles, to quantize subcarrier frequencies over the whole spectrum will definitely pull subcarriers out of optimal positions. This BER increase can be as large as 30dB.

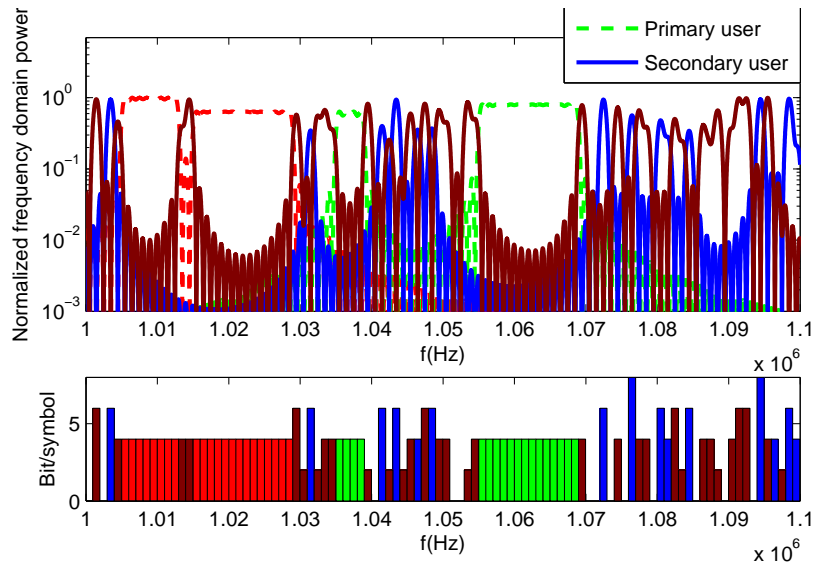

Figure 4.12: Sample result of spectrum allocation using SCGA, where 210kbps is achieved.

The afterward fine-tuning process regains the loss in quantization. It achieves lower BER by searching the spectrum again on a quantized grid. This search is much faster than the initial GA based search because the using of grid reduces the size of searching space.

Figure 4.16 is a sample of numeric solution before and after the processes of quantization, shifting and fine-tuning. In order to show the impact more clearly, here we are using SCSEA. After quantization, subcarriers are placed at a unified distance of 1k Hz, and shifted to a frequency offset of 437 Hz to avoid interference. The fine-tuning process moves several subcarriers aside to nearby locations with same offset to further reduce interference, such as moving a subcarrier at 1095437 Hz to 1096437 Hz.

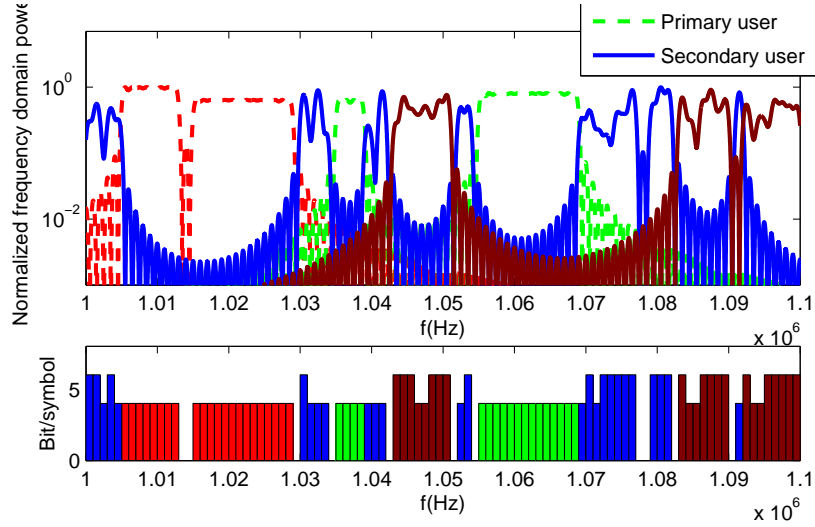

Figure 4.13: Sample result of spectrum allocation using BGSA, where 256kbps is achieved.

4.5.4 NSGA-II

In figure 4.17, we compared a few combination of objectives and constraints when using NSGA-II and BGSA to do the optimization.

The two constraints are on the maximum values on interference level and BER. In the cases with three objectives, we have maximizing throughput, minimizing average BER, and minimizing the width of spectrum usage. In the cases with five objectives, we have two more, which are minimizing the maximum BER and minimizing the maximum interference to other users. Performance are compared in terms of secondary user throughput achieved and time usage. We run simulations in 3 scenarios with secondary user throughput demands being 192 kbps, 256 kbps, and 320 kbps.

Results show that using constraints causes poor performance. The achieved throughput is less, and the time consumption is two times larger in average. A possible explanation for the large time consumption is that constraints are implemented using comparisons, and comparisons in programs are time-consuming. The reason for less throughput achievement may be that such method of setting constraints is not good for diversity preservation, and consequently results in poor performance.

Another observation is that the performance using three objectives is similar to that

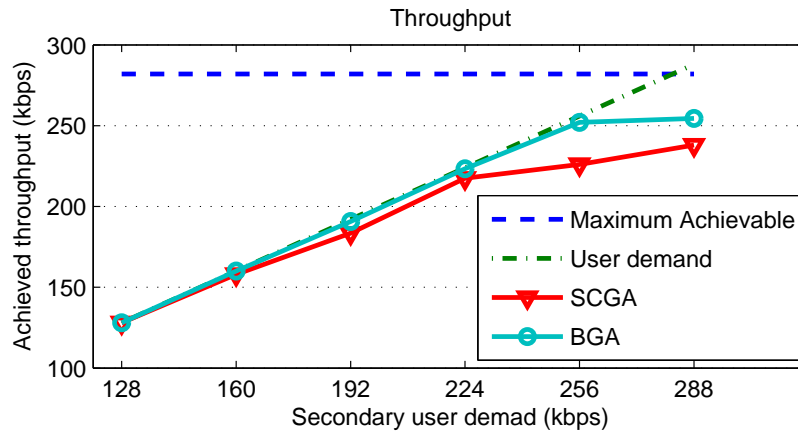

Figure 4.14: Throughput comparison of SCGA and BGA in the scenario of Figure 4.12 and Figure 4.13. BGA performs better when secondary user demand is high

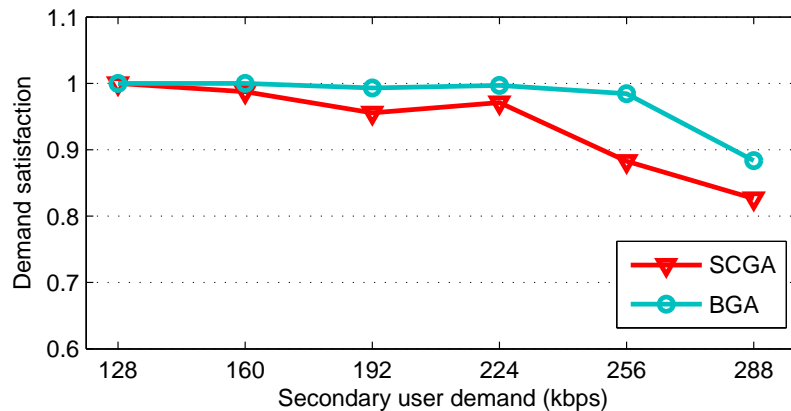

Figure 4.15: Demand satisfaction of SCGA and BGA in the scenario of Figure 4.12 and Figure 4.13.

using five objectives, with or without constraints. Therefore we can conclude that the two extra constraints of minimizing maximum BER and minimizing maximum interference are redundant in the presence of the constraint of minimizing average BER. However, this conclusion is based on the assumption that all users are using NC-OFDM.

4.5.5 Weighted Sum

Figure 4.18 shows a similar comparison in the case of using weighted sum method to solve this multi-objective optimization problem. The three objectives here are maximiz-

a spectrum hole to satisfy them. Thus, if a secondary user is looking for a quick small part of spectrum, weighted sum method without constraints is enough. MOGA without constraints can achieve a little more throughput than weighted sum method with constraints, and the time consumption of these two methods are also similar. Thus at least in this scenario, their performance are the same.

However, the need for setting weights manually is still a minus of weighte sum method. If the weights are unfortunately set to be misleading, the weighted sum method will have poor performance.

4.6 Summary

In this chapter, we summarized the implementation of our optimization approaches from the most general generic framework, to more specific multi-objective optimization algorithms, and then to more specific assisting techniques to accelerate the optimization. And we provide a bunch of results demonstrating the effects of these techniques and provide comparison and analysis.

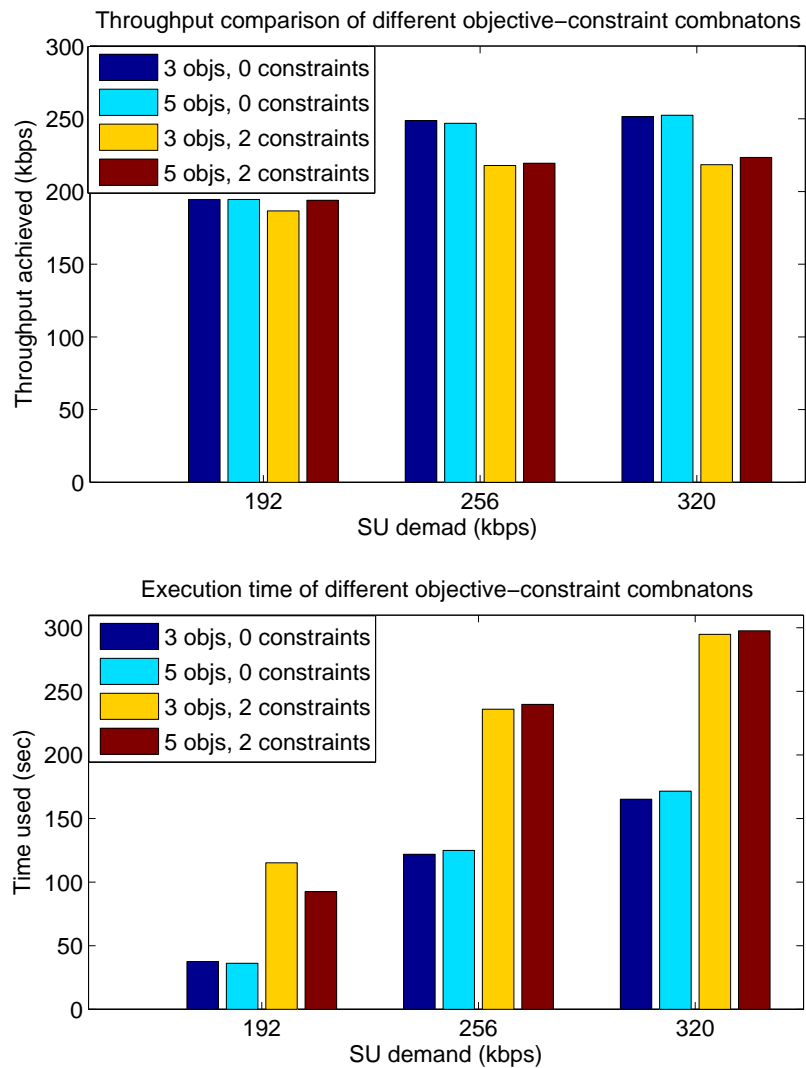
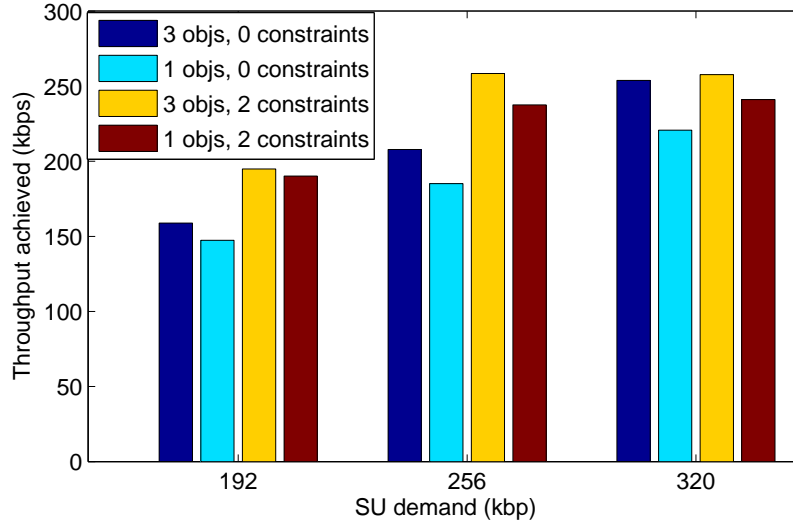

Figure 4.17: Example of comparison of searches using different objective-constraint combinations (Using NSGA, BGSA, non-adaptive variable ranges)

Throughput of different objective–constraint combination using Weight Sum Method



Execution time of different objective–constraint combination using Weight Sum Method

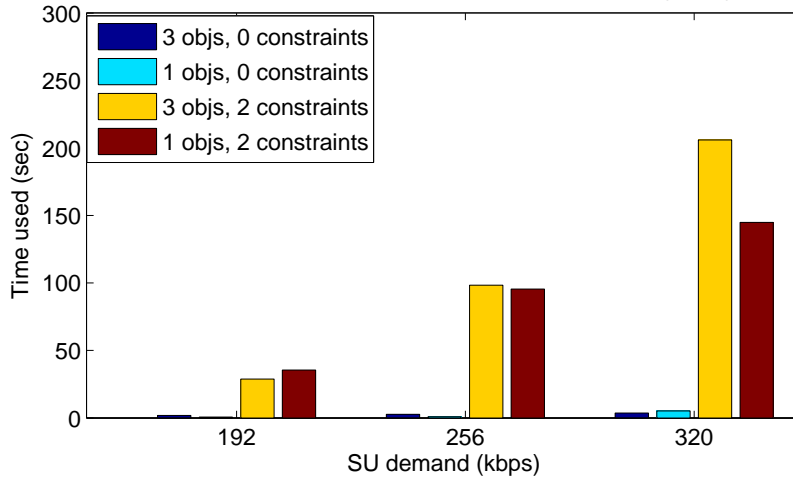

Figure 4.18: Example of comparison of searches using different objective-constraint combinations (Using SGA, BGSA, non-adaptive variable ranges)

Chapter 5

Conclusions and Future Work

In this thesis, we looked into dynamic spectrum access in cognitive radio networks, reviewed some popular classification of the problem, and some techniques to solve these problem and to optimize the solutions, including genetic algorithms, cross-layer optimization, and multi-objective optimization.

We also proposed several techniques to solve primarily the distributed optimization in spectrum access:

- A novel spectrum allocation approach for distributed cognitive radio networks. This proposed approach optimizes each individual wireless device and its single-hop communication links using the partial operating parameter and environmental information from adjacent devices within the wireless network. Through several tests, the fitness function we developed can be used in this framework to guide wireless users to optimize coexistence with others. This kind of distributed networks possess significant potential in numerous applications, both commercial and military. Global spectrum usage problems in these scenarios are solved through our distributed optimization.
- Two optimization approaches based on genetic algorithms (GAs), namely subcarrier-wise GA and block-wise GA. Designed quantization and fine-tuning processes to be applied to the raw results of these two optimization approaches. Serial subcarrier-wise genetic algorithms works better than conventional genetic algorithms in terms of throughput and execution time, but both of them cause severe spectrum fragmenta-

tion. Block-wise GA can avoid the fragmentation problem and has better throughput performance than SCGA.

- Proposed and analyzed several assisting approaches, such as quantizing variables and using adaptive variable ranges, for increasing the speed and improving the results of combined spectrum utilization/cross-layer optimization approaches. The quantization and fine-tuning serve to be a good afterward process of GA optimization in terms of practical one-FFT implementation of NC-OFDM and further reducing BER. And BGSA still have its advantage over SCGA with these afterward processes following.
- Proposed to implement the optimization engine to solve the multi-objective problem using single-objective GA and Multi-Objective GA. Analyzed and compared the results of the two algorithms. Through tests on several ideas on how to accelerate the multi-objective optimization in distributed spectrum search, it can be concluded that adaptive variable ranges largely improve the performance of optimization. In terms of choosing optimization technique, we see that genetic algorithms using weighted sum method without constraints is the fastest approach for the search, but does not yield the best results. We also found that constraints are good for weighted sum method, but bad for MOGA. MOGA without constraints appears to have similar performance with weighted sum method with constraints.

The following publications have been produced based on the above research work:

- Chen, S., Wyglinski, A. M. Distributed Optimization of Cognitive Radios Employed in Dynamic Spectrum Access Networks Proc. Fifth Annual IEEE Communications Society Conference on Sensor, Mesh and Ad Hoc Communications and Networks – SECON 2008, 2008
- Chen, S., Wyglinski, A. M. Cognitive Radio-Enabled Distributed Cross-Layer Optimization Via Genetic Algorithms 4th International Conference on Cognitive Radio Oriented Wireless Networks and Communications – CrownCom 2009, 2009
- Chen, S., Wyglinski, A. M. Efficient Spectrum Utilization via Cross-Layer Optimization in Distributed Cognitive Radio Networks Elsevier Computer Commun., 2008

5.1 Future Work

Possible future research of the material covered in this thesis can be found in the following aspects:

- When comparing the subcarrier-wise allocation approach and the block-wise allocation approach, we already saw the effects of spectrum fragmentation. The quantized influence of spectrum fragmentation in dynamic spectrum access is yet to be looked into. We will also search for possible solutions to spectrum fragmentation. Insights may come from the memory fragmentation in computer architecture.
- In this work, we designed some optimization approaches for a fully cooperative network, but we have not derived mathematical analysis for these approaches. An immediate extension would be to apply these approaches to non-cooperative networks. We will also use game theory to analyze the non-cooperative and cooperative behavior of radios in the dynamic spectrum access in cognitive radio networks.
- In our Wireless Innovation Lab (WILab), we have already collected amounts of measurement of real life spectrum usage. With this resource, we can test the dynamic spectrum access on software testbeds to show its practical effects. WILab is continuing building autonomous spectrum measurement facility to enable fast and flexible spectrum data collection.
- To test the above approaches in practise, it is necessary to implement these algorithms on SDR testbeds. There have been several attempts on making SDR testbeds. We will use the Universal Software Radio Peripheral (USRP) as the hardware testbeds to load our algorithms on. The Universal Software Radio Peripheral product family allows you to create a software radio using any computer with a USB2 or Gigabit ethernet port. Various plug-on daughterboards allow the USRP and USRP2 to be used on different radio frequency bands. Daughterboards are available from DC to 5.9 GHz at this time. The entire design of the USRP family is open source. [50]

Bibliography

- [1] Y. T. H. Alexander M. Wyglinski, Maziar Nekovee, *Cognitive Radio Communications and Networks Principles and Practice*, Y. T. H. Alexander M. Wyglinski, Maziar Nekovee, Ed. Elsevier, 2009.
- [2] S. Chen and A. M. Wyglinski, “Distributed optimization of cognitive radios employed in dynamic spectrum access networks,” in *Proc. Fifth Annual IEEE Communications Society Conference on Sensor, Mesh and Ad Hoc Communications and Networks – SECON 2008*, June 2008.
- [3] FCC, “Docket no 03-222 notice of proposed rule making and order,” FCC, Tech. Rep., 2003.
- [4] J. Mitola, “The software radio architecture,” *IEEE Communications Magazine*, 1995.
- [5] H. Arslan, *Cognitive Radio, Software Defined Radio, and Adaptive Wireless Systems*, H. Arslan, Ed. Springer, 2007.
- [6] S. Haykin, “Cognitive radio: brain-empowered wireless communications,” *IEEE Journal on Selected Areas in Communications*, 2005.
- [7] I. F. Akyildiz, W.-Y. Lee, M. C. Vuran, and S. Mohanty, “Next generation/dynamic spectrum access/cognitive radio wireless networks: A survey,” *Computer Networks*, 2006.
- [8] FCC, “Spectrum policy task force,” FCC, Tech. Rep., 2002.

- [9] I. Mitola, J., “Cognitive radio for flexible mobile multimedia communications,” in *Mobile Multimedia Communications, 1999. (MoMuC '99) 1999 IEEE International Workshop on*, 1999, pp. 3–10.
- [10] T. A. Weiss and F. K. Jondral, “Spectrum pooling: an innovative strategy for the enhancement of spectrum efficiency,” *IEEE Communications Magazine*, 2004.
- [11] V. Brik, E. Rozner, S. Banerjee, and P. Bahl, “Dsap: a protocol for coordinated spectrum access,” in *New Frontiers in Dynamic Spectrum Access Networks, 2005. DySPAN 2005. 2005 First IEEE International Symposium on*, Nov. 2005, pp. 611–614.
- [12] M. Buddhikot, P. Kolodzy, S. Miller, K. Ryan, and J. Evans, “Dimsumnet: new directions in wireless networking using coordinated dynamic spectrum,” in *World of Wireless Mobile and Multimedia Networks, 2005. WoWMoM 2005. Sixth IEEE International Symposium on a*, June 2005, pp. 78–85.
- [13] F. Ge, R. Rangnekar, A. Radhakrishnan, S. Nair, A. Fayed, Q. Chen, A. Young, Y. Wang, M. D. Silviu, T. Brisebois, G. Marballie, X. Cheng, N. He, B. Li, C. W. Bostian, and M. Hsiao, “A heterogeneous cognitive radio network enabling dissimilar cooperative spectrum sensing, dynamic spectrum access, interoperability,” in *IEEE, DySPAN*, October 2008, white paper for demonstration.
- [14] J. Zhao, H. Zheng, and G.-H. Yang, “Distributed coordination in dynamic spectrum allocation networks,” in *New Frontiers in Dynamic Spectrum Access Networks, 2005. DySPAN 2005. 2005 First IEEE International Symposium on*, Nov. 2005, pp. 259–268.
- [15] L. U. Choi, W. Kellerer, and E. Steinbach, “On cross-layer design for streaming video delivery in multiuser wireless environments,” *EURASIP Journal on Wireless Communications and Networking*, 2006.
- [16] V. Srivastava, “Cross-layer design: A survey and the road ahead,” *IEEE Communications Magazine*, 2005.
- [17] R. Thomas, L. DaSilva, and A. MacKenzie, “Cognitive networks,” in *New Frontiers in*

- Dynamic Spectrum Access Networks, 2005. DySPAN 2005. 2005 First IEEE International Symposium on*, Nov. 2005, pp. 352–360.
- [18] Q. Zhao, L. Tong, A. Swami, and Y. Chen, “Decentralized cognitive mac for opportunistic spectrum access in ad hoc networks: A pomdp framework,” *IEEE Journal On Selected Areas In Commun.*, 2007.
- [19] Q. Zhao and B. Sadler, “A survey of dynamic spectrum access,” *Signal Processing Magazine, IEEE*, vol. 24, no. 3, pp. 79–89, May 2007.
- [20] L. Cao and H. Zheng, “Distributed spectrum allocation via local bargaining,” *Second Annual IEEE Commun. Society Conference on Sensor and Ad Hoc Commun. and Networks*, pp. 475–486, Sept., 2005.
- [21] N. Clemens and C. Rose, “Intelligent power allocation strategies in an unlicensed spectrum,” in *New Frontiers in Dynamic Spectrum Access Networks, 2005. DySPAN 2005. 2005 First IEEE International Symposium on*, Nov. 2005, pp. 37–42.
- [22] D. Goodman and N. Mandayam, “Power control for wireless data,” *Personal Communications, IEEE*, vol. 7, no. 2, pp. 48–54, Apr 2000.
- [23] W. Lehr and J. Crowcroft, “Managing shared access to a spectrum commons,” in *New Frontiers in Dynamic Spectrum Access Networks, 2005. DySPAN 2005. 2005 First IEEE International Symposium on*, Nov. 2005, pp. 420–444.
- [24] L. Xu, R. Tonjes, T. Paila, W. Hansmann, M. Frank, and M. Albrecht, “Drive-ing to the internet: Dynamic radio for ip services in vehicular environments,” in *Local Computer Networks, 2000. LCN 2000. Proceedings. 25th Annual IEEE Conference on*, 2000, pp. 281–289.
- [25] Y. Yuan, P. Bahl, R. Chandra, P. A. Chou, J. I. Ferrell, T. Moscibroda, S. Narlanka, and Y. Wu, “Knows: Kognitiv networking over white spaces,” in *Proceedings of IEEE Symposium on New Frontier in Dynamic Spectrum Access Netowrk (DySPAN)*, 2007.
- [26] C. Peng, H. Zheng, and B. Y. Zhao, “Utilization and fairness in spectrum assignment for opportunistic spectrum access,” *Mob. Netw. Appl.*, vol. 11, no. 4, pp. 555–576, 2006.

- [27] Z. Han, Z. Ji, and K. Liu, "Low-complexity ofdma channel allocation with nash bargaining solution fairness," in *Global Telecommunications Conference, 2004. GLOBECOM '04. IEEE*, vol. 6, Nov.-3 Dec. 2004, pp. 3726–3731 Vol.6.
- [28] J. G. Proakis, *Digital Signal Processing: Principles, Algorithms, and Applications*, 3rd ed. Upper Saddle River, NJ, USA: Prentice Hall, 1996.
- [29] R. Rajbanshi, Q. Chen, A. M. Wyglinski, G. J. Minden, and J. B. Evans, "Quantitative comparison of agile modulation techniques for cognitive radio transceivers," in *Consumer Communications and Networking Conference, 2007. CCNC 2007. 4th IEEE*, Jan. 2007, pp. 1144–1148.
- [30] R. Rajbanshi, Q. Chen, A. M. Wyglinski, J. B. Evans, and G. J. Minden, "Comparative study of frequency agile data transmission schemes for cognitive radio transceivers," in *Proc. Int. Wksp on Technol. Policy for Accessing Spectrum*. New York, NY, USA: ACM, 2006, p. 15.
- [31] D. E. Goldberg, *Genetic Algorithms in Search, Optimization and Machine Learning*. New York, NY, USA: Addison-Wesley Longman Publishing Co., Inc., 1989.
- [32] "Illinois genetic algorithms laboratory." [Online]. Available: <http://www.illgal.uiuc.edu/web/>
- [33] J. F. Hauris, "Genetic algorithm optimization in a cognitive radio for autonomous vehicle communications," in *Proc. 2007 IEEE Int. Symposium on Computational Intelligence in Robotics and Automation*, 6 2007.
- [34] T. Rondeau, C. Rieser, B. Le, and C. Bostian, "Cognitive radios with genetic algorithms: Intelligent control of software defined radios," in *Proc. of SDR Forum Technical Conference*, 2004.
- [35] M. Chiang, "To layer or not to layer: balancing transport and physical layers in wireless multihop networks," in *INFOCOM 2004. Twenty-third Annual Joint Conference of the IEEE Computer and Communications Societies*, vol. 4, March 2004, pp. 2525–2536 vol.4.

- [36] B. Johansson and M. Johansson, “Primal and dual approaches to distributed cross-layer optimization,” in *in Proc. 16th IFAC World Congress*, 2005.
- [37] A. Eryilmaz and R. Srikant, “Joint congestion control, routing, and mac for stability and fairness in wireless networks,” *Selected Areas in Communications, IEEE Journal on*, vol. 24, no. 8, pp. 1514–1524, Aug. 2006.
- [38] R. Marler and J. Arora, “Survey of multi-objective optimization methods for engineering,” *Structural and Multidisciplinary Optimization*, vol. 26, pp. 369–395, 2004.
- [39] S. Chen and A. M. Wyglinski, “Efficient spectrum utilization via cross-layer optimization in distributed cognitive radio networks,” *Elsevier Computer Commun.*, 2008.
- [40] Y. Shi and Y. Hou, “A distributed optimization algorithm for multi-hop cognitive radio networks,” *In Proc. IEEE 27th Conf. on Computer Commun – INFOCOM 2008*, pp. 1292–1300, April 2008.
- [41] B.-J. Ko, V. Misra, J. Padhye, and D. Rubenstein, “Distributed channel assignment in multi-radio 802.11 mesh networks,” *In Proc. IEEE Wireless Commun. and Networking Conf.*, pp. 3978–3983, March 2007.
- [42] A. M. Wyglinski, “Effects of bit allocation on non-contiguous multicarrier-based cognitive radio transceivers,” in *Proceedings of the 64th IEEE Vehicular Technology Conference (VTC)*, 2006.
- [43] T. R. Newman, “Multiple objective fitness functions for cognitive radio adaptation,” Ph.D. dissertation, University of Kansas, Lawrence, KS, 2008.
- [44] T. R. Newman, B. A. Barker, A. M. Wyglinski, A. Agah, J. B. Evans, and G. J. Minden, “Cognitive engine implementation for wireless multicarrier transceivers,” *Wiley Wireless Commun. and Mobile Computing*, 2007.
- [45] T. R. Newman, R. Rajbanshi, A. M. Wyglinski, J. B. Evans, and G. J. Minden, “Population adaptation for genetic algorithm-based cognitive radios,” *ACM/Springer Mobile Ad Hoc Networks– Special Issue on Cognitive Radio Oriented Wireless Networks and Commun.*, 2008.

- [46] J. G. Proakis, *Digital Communications*, 3rd ed. McGraw-Hill, 1995.
- [47] S. Chen and A. M. Wyglinski, "Cognitive radio-enabled distributed cross-layer optimization via genetic algorithms," in *4th International Conference on Cognitive Radio Oriented Wireless Networks and Communications – CrownCom 2009*, 2009.
- [48] K. Deb, A. Pratap, S. Agarwal, and T. Meyarivan, "A fast and elitist multiobjective genetic algorithm: Nsga-ii," *Evolutionary Computation, IEEE Transactions on*, vol. 6, no. 2, pp. 182–197, Apr 2002.
- [49] S. Pagadarai, R. Rajbanshi, A. M. Wyglinski, and G. J. Minden, "Sidelobe suppression for ofdm-based cognitive radios using constellation expansion," in *IEEE Wireless Communications and Networking Conference*, 2008.
- [50] "Ettus research." [Online]. Available: <http://www.ettus.com/>