

UNDERGRADUATE CATALOG
2020-21



CONTENTS

The Mission of WPI	3
The Goal of WPI	3
A Statement of Values for Undergraduate Education at WPI	3
WPI Undergraduate Learning Outcomes	4
WPI's Commitment to Pluralism	4
The Two Towers Tradition:	5
The Second Century	5
The WPI Plan	5

SECTION 1 THE WPI PLAN 6

WPI Degree Requirements	7
Major Areas of Study	8
Professionally Accredited Programs	9
Academic Advising	10
Degree Options	11
Concentrations	11
Minors	11
Double Majors	12
Projects and Research	14
The Major Qualifying Project	17
MQP Learning Outcomes	17
MQP Project Centers	17
The Interactive Qualifying Project	18
Global Projects Program	19
Off-Campus Programs	19
Individually Sponsored Residential Projects (ISRPs)	21
Individually Sponsored On-Campus IQP Programs	21
Humanities and Arts Requirement	22
The Social Science Requirement	27

SECTION 2 DEPARTMENT AND PROGRAM DESCRIPTIONS 28

Department and Program Descriptions	29
Aerospace Engineering	29
Minor in Aerospace Engineering	32
Air Force Aerospace Studies	32
Architectural Engineering	33
Minor in Architectural Engineering (AREN)	34
Bioinformatics and Computational Biology	36
Minor in Bioinformatics and Computational Biology (BCB)	37
Biology and Biotechnology	37
Minor in Biology	38
Biomedical Engineering	39
Business, Robert A. Foisie School of	44
Business (BU)	44
Management Engineering (MGE)	47
Management Information Systems (MIS)	47
Industrial Engineering	48
Minor in Business	50
Minor in Entrepreneurship	50
Minor in Industrial Engineering	50
Minor in Management Information Systems	51
Minor in Social Entrepreneurship	51
Chemical Engineering	52
Chemistry and Biochemistry	54

Minor in Biochemistry	56
Minor in Chemistry	56
Civil and Environmental Engineering	57
Computer Science	60
Minor in Computer Science	63
Data Science	65
Minor in Data Science	66
Electrical and Computer Engineering	70
Minor in Electrical and Computer Engineering	73
Engineering Science Courses	73
Environmental Engineering	74
Fire Protection Engineering	76
Humanities and Arts	76
Professional Writing	79
Humanities and Arts Minors	80
American Studies	80
Chinese Studies	81
Drama/Theatre	82
English	82
Language (German or Spanish)	82
History	83
Media Arts	83
Music	83
Philosophy and Religion	84
Writing and Rhetoric	84
Interactive Media & Game Development	84
Interactive Media & Game Development (Bachelor of Arts)	85
Interactive Media & Game Development Technology (Bachelor of Science)	86
Minor in Interactive Media & Game Development	87
Interdisciplinary and Global Studies	87
Interdisciplinary Minors	88
Minor in Global Public Health	88
Minor in Nanoscience	89
Minor in Sustainability Engineering	89
International Development, Environment, and Sustainability (IDEaS) (Bachelor of Arts Degree)	90
Major in Environmental and Sustainability Studies	91
Minor in Environmental and Sustainability Studies	91
Minor in Science and Engineering for Development (DEV)	92
International and Global Studies	92
Minor in International and Global Studies	92
Liberal Arts and Engineering (Bachelor of Arts Degree)	95
Mathematical Sciences	97
Minor in Statistics	101
Minor in Mathematics	102
Mechanical Engineering	102
Minor in Mechanical Engineering	106
Minor in Manufacturing Engineering	106
Materials Engineering	107
Minor in Materials	107
Military Science	108
Physical Education, Recreation, and Athletics	109
Physics	110
Minor in Physics	113
Minor in Astrophysics	114

Pre-Professional Programs	114
Five-Year Dual Bachelor/M.S. in Management (MSMG)	114
Pre-Health Programs	115
Pre-Law Programs	115
Teacher Preparation Program	115
Robotics Engineering	116
Minor in Robotics Engineering	117
Social Science and Policy Studies	117
Economic Science Program	118
Psychological Science Program	119
Society, Technology, and Policy Program	120
Minor in Law and Technology	121
Minors in Social Science	121

SECTION 3 COURSE DESCRIPTIONS 123

Courses Qualifying for Engineering Distribution Areas	124
Course Descriptions	124
Aerospace Engineering	125
Air Force Aerospace Studies	126
Architectural Engineering	128
Basic Sciences	129
Bioinformatics and Computational Biology	129
Biology and Biotechnology	130
Biomedical Engineering	135
Business, Robert A. Foisie School of	138
Chemical Engineering	142
Chemistry and Biochemistry	144
Civil and Environmental Engineering	148
Computer Science	150
Data Science	154
Electrical and Computer Engineering	155
Engineering Science Interdisciplinary	158
Fire Protection Engineering	160
Humanities and Arts	161
Independent Study	179
Interactive Media & Game Development	179
Interdisciplinary	182
Mathematical Sciences	184
Mechanical Engineering	189
Military Science	192
Physical Education	194
Physics	195
Robotics Engineering	197
Social Science and Policy Studies	198

SECTION 4 UNIVERSITY POLICIES AND PROCEDURES 207

University Policies and Procedures	208
Grades	208
Grade Appeal and Grade Change Policy	209
Transfer Credit	211
Graduation with Honors	211
Commencement	212
Early Completion	212
Designation of Major Area of Study	212
Double Major	212

Designation of Class Year	212
Academic Honesty Policy	212
Guidelines for the Determination of Satisfactory Academic Progress, Academic Warning, Academic Probation and Academic Suspension	214
Administrative Obligations and Holds	215
Directory Information and Release of Information	215
Office of the Registrar	216
Part-Time Degree Students	219
Non-Degree Students	219

SECTION 5 RESOURCES AND SPECIAL PROGRAMS 221

Resources and Special Programs	222
The Gateway Park	222
Special Programs for First Year Students	222
Graduate Courses	222
Combined Bachelor/Master's Program	222
Information Technology Services	223
Music and Theatre Facilities	224
George C. Gordon Library	225
Student Services	226
Student Exchanges	227
Language Requirements	227
HECCMA Course Cross-Registration	228
Cooperative Education	228
Summer Session (Term E)	230
Awards and Prizes	231
Societies, Registration and Licensing	234

SECTION 6 CAREER DEVELOPMENT AND GRADUATE SCHOOL . . 235

Career Development and Graduate School Advising	236
Career Development Center	236
Graduate Study at WPI	237

SECTION 7 ADMISSION, EXPENSES, FINANCIAL AID AND HOUSING 241

Admission to WPI	242
Expenses	245
Financial Aid	247
Housing	251

SECTION 8 TRUSTEES ADMINISTRATION AND FACULTY 253

Trustees, Administration and Faculty	254
Trustees	254
Administration	256
Faculty	257
Index	280
Policies & Practices	284
Currency of Information	284
Accreditation	285
Directions	285
Campus Map	286

WPI educates talented men and women in engineering, science, management, and humanities in preparation for careers of professional practice, civic contribution, and leadership, facilitated by active lifelong learning. This educational process is true to the founders' directive to create, to discover, and to convey knowledge at the frontiers of academic inquiry for the

betterment of society. Knowledge is created and discovered in the scholarly activities of faculty and students ranging across educational methodology, professional practice, and basic research. Knowledge is conveyed through scholarly publication and instruction.

Adopted by the Board of Trustees, May 22, 1987

THE GOAL OF WPI

WPI was founded in 1865 to create and convey the latest science and engineering knowledge in ways that would be most useful to the society from which its students came. Since that time, the disciplines of human inquiry have expanded extraordinarily, as have WPI's constituencies. The WPI curriculum, accordingly, has been reshaped numerous times, but it has remained true to its original mission of fusing academic inquiry with social needs, of blending abstraction with immediacy, of linking new knowledge to applications.

The goals of the undergraduate program are to lead students to develop an excellent grasp of fundamental concepts in their principal areas of study; to lay a foundation for life-long renewal of knowledge; to gain a mature understanding of themselves; and, most importantly, to form a deep appreciation of the interrelationships among basic knowledge, technological advance, and human need. These principles are today manifest in the *WPI Plan*, a unique, project-oriented program which emphasizes intensive learning experiences and direct application

of knowledge. WPI remains committed to continued educational improvement and innovation.

The goals of WPI's programs of graduate instruction and research are to create and convey knowledge at the frontiers of academic inquiry. These endeavors are founded on the principle that vigorously pursued and rigorously assessed scholarship is the lifeblood of the institution. High quality graduate instruction conveys the arts of scholarship to new generations, and it assists working professionals in maintaining currency in a world where knowledge becomes obsolete with ever-increasing rapidity.

A WPI education encompasses continuous striving for excellence coupled with an examination of the contexts of learning so that knowledge is won not only for its own sake but also for the sake of the human community of which the people of WPI are part.

Endorsed by the WPI Faculty on March 5, 1987, and by the Board of Trustees on October 16, 1987.

A STATEMENT OF VALUES FOR UNDERGRADUATE EDUCATION AT WPI

1. WPI's programs shall emphasize fundamental concepts, knowledge, and skill, and ensure that students are able to apply them within the context of their major disciplines.
2. WPI's programs shall emphasize the development of students as effective thinkers and communicators, able to use evidence to present their ideas with logic, clarity, and persuasion.
3. Programmatic breadth in general, and balance between technical and humanistic components in particular, are the hallmarks of a WPI undergraduate education. In addition to educating students in their major discipline, WPI's programs shall provide students with a broad preparation for fulfilling lives as responsible professionals and informed citizens.
4. Grounded in project and course experiences, a WPI education shall provide a firm foundation for life-long learning in a variety of fields. WPI programs shall emphasize inquiry-based learning and open-ended problem solving. Students shall bear a considerable responsibility for learning outside of the classroom.
5. WPI's programs shall be sufficiently flexible so as to allow students significant choice in and responsibility for planning their courses of study. Faculty, via the central teaching tasks of project and academic advising, shall ensure that student learning experiences encourage critical reflection, decision making, and personal growth.
6. WPI's programs shall emphasize the scientific, technical, societal, and humanistic contexts in which knowledge is applied and constructed. Education activities shall challenge students to make connections between disciplines, to consider multiple viewpoints, and to appreciate the consequences of their actions. The curriculum shall prominently feature integrative and interdisciplinary activities.
7. WPI's learning environment and educational activities shall balance personal responsibility and individual accountability with cooperation, collaboration and mutual respect. Members of the community shall be encouraged to value academic integrity, and to become conscious of the value that such integrity confers to themselves and to the community.
8. WPI shall be committed to assessment and improvement of student learning.

Graduates of WPI will:

1. have a base of knowledge in mathematics, science, and humanistic studies.
2. have mastered fundamental concepts and methods in their principal areas of study.
3. understand and employ current technological tools.
4. be effective in oral, written and visual communication.
5. function effectively both individually and on teams.
6. be able to identify, analyze, and solve problems creatively through sustained critical investigation.
7. be able to make connections between disciplines and to integrate information from multiple sources.
8. demonstrate global and intercultural competency by developing the capacity to identify, explain, and critically analyze the forces (such as cultural, historical, political, economic) that shape the self and others as they engage with local and global communities.
9. be aware of personal, societal, and professional ethical standards.
10. have the skills, diligence, and commitment to excellence needed to engage in lifelong learning.

Approved by the WPI Faculty on May 3, 2019.

WPI'S COMMITMENT TO PLURALISM

Pluralism, as a social condition, means that several distinct ethnic, religious, and racial communities live side by side, have equitable access to resources, are willing to affirm each other's dignity, are ready to benefit from each other's experiences, and are quick to acknowledge each other's contributions to the common welfare. Recognizing the importance of pluralism to creativity, innovation, and excellence, WPI is dedicated to creating an atmosphere that encourages diversity in all aspects of campus life—from academics, to residence hall living, to social interactions among students, faculty, and staff. The Institute recognizes the special obligation of promoting a multicultural community based on mutual respect and tolerance. This commitment is part of WPI's institutional plan for encouraging pluralism and increasing diversity, a plan that proclaims the importance of having students understand and appreciate other cultures, and prepares them fully to pursue rewarding careers in an increasingly global economy.

Concepts endorsed by the WPI Faculty on April 21, 1994.

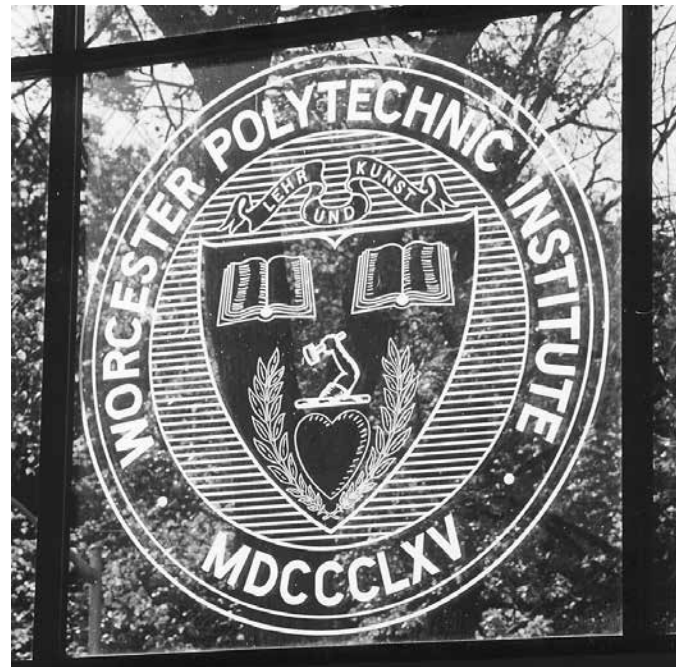

THE TWO TOWERS TRADITION: THE SECOND CENTURY

WPI, the nation's third oldest private technological university, was established in 1865 by the New England industrialists John Boynton, Ichabod Washburn, and their associates. Boynton and Washburn endowed the first two buildings on campus, as academic classrooms and practical shops. Boynton Hall and the Washburn Shops — renovated today into state-of-the-art facilities — still preserve their distinctive original towers. These “Two Towers” represent WPI's continued commitment to academic excellence through real-life project experience that synthesizes classroom learning.

The “Two Towers” tradition of academic achievement and practical application is reflected in WPI's motto, “Lehr und Kunst” or “Theory and Practice.”

WPI has awarded graduate degrees since 1898, adding new programs regularly in response to the developing needs of the professional world. WPI is among the top 50 science colleges in the nation in terms of the percentage of undergraduates who receive doctorates. Presently, WPI offers the master's degree in 31 disciplines and the doctorate in 15.

The current student body of over 4,000 men and women includes about 1,100 full- and part-time graduate students. Currently, students attend WPI from almost every state and over 70 foreign nations.



THE WPI PLAN

In 1970 WPI adopted a revolutionary new undergraduate program known as the *WPI Plan*. The Plan replaced the traditional rigidly-prescribed curriculum — typical of conventional engineering education — with a flexible, exciting, and academically challenging program aimed at helping students to learn *how to learn*.

The Plan continues the “Two Tower” tradition by synthesizing classroom experience in projects that solve real-world problems. The WPI project program prepares graduates for their future professional lives by helping them learn how to identify, investigate and report on open-ended problems. Alumni indicate that project experiences also prepare them uniquely well for managing team efforts, and for communicating both in oral and written forms according to professional standards.

All WPI students complete two major projects in addition to requirements in general education and in their major fields. The Major Qualifying Project (or MQP) challenges students to solve research and design problems typical of those encountered in their professional discipline. The Interactive Qualifying Project (or IQP) presents an issue at the intersection of science, technology, and culture, and emphasizes the need to learn about how technology affects societal values and structures. Students also achieve intellectual breadth through degree requirements in the social sciences and humanities and arts. In addition, students achieve some depth within the Humanities and Arts by completing an Inquiry Seminar or Practicum on a theme emerging from a self-selected series of courses. Taken together, these activities emphasize that professionals must learn not only to create technology, but also to assess and manage the social and human consequences of that technology.

THE WPI PLAN

SECTION 1

WPI Degree Requirements	7
Major Areas of Study	8
Professionally Accredited Programs	9
Academic Advising	10
Degree Options	11
Concentrations	11
Minors	11
Double Majors	12
Projects and Research.	14
The Major Qualifying Project	17
MQP Learning Outcomes.	17
MQP Project Centers	17
The Interactive Qualifying Project.	18
Global Projects Program	19
Off-Campus Programs.	19
Individually Sponsored Residential Projects (ISRPs)	21
Individually Sponsored On-Campus IQP Programs	21
Humanities and Arts Requirement	22
The Social Science Requirement	27

WPI DEGREE REQUIREMENTS (effective for students matriculating after August 1, 2011)

WPI's academic requirements are specifically designed to develop an overall educational experience which meets the goals of the college. Each requirement plays a supporting role as follows:

- To provide intellectual breadth and a better understanding of themselves and the diversity and creativity of human experience, every WPI student must complete a **Humanities and Arts Requirement**;
- To provide an understanding of the priorities of other sectors of society, develop the ability to communicate effectively with disparate groups, organize and derive solutions to complex problems, and gain an awareness of the interrelationships between technology and people, every WPI student must complete an **Interactive Qualifying Project (IQP)**;
- To provide a capstone experience in the professional discipline, to develop creativity, instill self-confidence and enhance the ability to communicate ideas and synthesize fundamental concepts, every student must complete a **Major Qualifying Project (MQP)**;
- To provide for learning through an academic program with fabric and course balance while encouraging individual student choices within that framework, every student must fulfill **Distribution Requirements**.

WPI TERMS AND CREDIT UNITS

The Bachelor degree from WPI normally is based upon a residency at WPI of 16 terms. WPI operates on a system with four seven-week *terms*, two in the autumn semester (Terms A and B) and two in the spring semester (Terms C and D). A summer session, Term E, is also available. The normal academic load for each term is defined as *one unit* of work, usually divided among three courses or projects. Thus, the usual credit unit for courses or independent study/projects is 1/3 unit. *Qualifying Projects*, defined on pages 14-16, require one full unit of activity which may be concentrated into a single term (especially if conducted off-campus) or spread throughout an academic year. The degree will be awarded upon completion of the following:

DEGREE REQUIREMENTS

1. **The Humanities and Arts Requirement** (See page 22)
Qualification by overall evaluation of two units of work in the humanities and arts.
To provide intellectual breadth and a better understanding of themselves and the diversity and creativity of human experience, every WPI student must complete a **Humanities and Arts Requirement**.
2. **The Mathematics and Science Requirement** (See distribution requirements for individual programs, starting on page 28)
The Mathematics and Science Requirement defines a minimum standard of scientific, technological, engineering, and mathematical literacy for graduates of WPI, regardless of major field. Most degree programs will provide a substantial

level of preparation in most of these areas, far beyond this standard. Students will satisfy this requirement by satisfying the program requirements of their individual major programs.

The goals of the Mathematics and Science Requirement at WPI are that students will be able, in their careers and daily lives, to: 1) explain and apply key concepts and principles of scientific disciplines and use an understanding of scientific methods to make critical judgments, 2) apply mathematical methods to understand the solution of real-world problems, 3) productively and appropriately use computers and other technology, 4) use methods from the quantitative, natural or engineering sciences to systematically identify, formulate, and solve problems.

The specific requirement is two units of work in science, engineering, mathematical science or computer science. Two-thirds units of work must be in Quantitative Science (courses with prefixes CS or MA count by default); two-thirds units of work must be in Natural or Engineering Science (courses with prefixes BB, BME, CHE, CE, CH, ECE, ES, GE, ME, PH or RBE count by default); the final two-thirds unit may be from any of the Quantitative, Natural or Engineering Sciences. Each major program may set more restrictive requirements as the program sees fit. Programs may also propose other work to fulfill any portion the two-unit Requirement; such alternatives must be approved by the Committee on Academic Policy and the Dean of Undergraduate Studies.

3. **The Interactive Qualifying Project** (See page 18)
Successful completion of a qualifying project relating science and/or technology to society (the Interactive Qualifying Project, or IQP) representing at least one unit of credit in project or independent study work. The format of the documentation is to be in accordance with current WPI policy on such documentation.
4. **The Major Qualifying Project** (See page 17)
Successful completion of a qualifying project in the major area of study (the Major Qualifying Project, or MQP) representing at least one unit of credit in project or independent study work. The format of the documentation is to be in accordance with current WPI policy on such documentation.
5. **Distribution Requirements** (See program description for specified departments – page 28)
Satisfaction of published academic activity distribution requirements in or relating to the major area of study. These requirements typically total no more than ten units (including the MQP and two units to fulfill the Mathematics and Science Requirement) and are specified by general topical subject area, not by specific courses. Completion of distribution requirements will be certified by the appropriate Program Review Committee (PRC), upon recommendation by the student's academic advisor. For students desiring designation of a major area for which a determination regarding distribution requirements has not previously been made and published, a faculty committee will be appointed by the department head or IGSD dean to review and approve the student's program of study.

6. **Social Sciences** (See page 27)
Completion of 2/3 unit of work in the social sciences, exclusive of qualifying project.
7. **Residency Requirement**
A minimum of eight units *must* be completed satisfactorily in residence at WPI. (It is anticipated the normal residence at WPI will be 16 terms.)
8. **Minimum Academic Credit**
The minimum academic credit required for the Bachelor degree is 15 units. Credit accumulated beyond the published distribution requirements shall be accomplished by the addition of “free elective” work.
9. **Physical Education** (See page 109)
Qualification in physical education shall be established by completing 1/3 unit of course work (four PE classes) or its equivalent. Such an equivalent, for example, may be participation in club or varsity sports.

MAJOR AREAS OF STUDY

Guidelines for the construction of the most common major programs are given alphabetically by area in the “Department and Program Descriptions” section beginning on page 28. The exact program of study for any student, however, is developed by the student with the aid of an advisor.

All of the majors below, with the exception of Environmental and Sustainability Studies, Interactive Media and Game Development, and Liberal Arts and Engineering, are awarded with the B.S. degree. Some programs are listed that are developed through the departments indicated in parentheses. In the past, WPI has graduated students in the following fields, but this list should not be interpreted as necessarily putting any restriction on a student’s “major:”

Actuarial Mathematics (MAC)

Aerospace Engineering (ME)(accredited by ABET)

Applied Physics (PHA)

Architectural Engineering (AREN)

Biochemistry (CBC)(certified by the American Chemical Society)

Bioinformatics and Computational Biology (BCB)

Biology/Biotechnology (BB)

Biomedical Engineering (BME)(accredited by ABET)

Specializations in:

Biomaterials and Tissue Engineering

Biomechanics

Biomedical Instrumentation, Biosignals,
and Image Processing

Business (BU) (accredited by AACSB)

Concentrations in:

Business Analytics

Financial Technology

Innovation for Social Change

General Business

Custom concentration

Chemical Engineering (CHE)(accredited by ABET)

Concentrations in:

Biochemical

Biomedical

Environmental

Materials

Chemistry (CBC)(certified by the American Chemical Society)

Concentration in:

Medicinal Chemistry

Civil Engineering (CEE)(accredited by ABET)

Subareas in:

Structural and Geotechnical Engineering

Environmental Engineering

Transportation Engineering

Urban and Environmental Planning

Construction Engineering and Project Management

Concentration in:

Environmental

Computer Science (CS)

Data Science (DS)

Economic Science (SSPS)

Concentrations in:

Sustainable Economic Development

Computational Economics

Electrical and Computer Engineering (ECE)(accredited by ABET)

Subdisciplines in:

Robotics

Power Systems Engineering

RF Circuits and Microwaves

Communications and Signal Analysis

Biomedical Engineering

Analog Microelectronics

Computer Engineering

Environmental Engineering (CEE; CHE) (accredited by ABET)

Environmental and Sustainability Studies (B.A. degree) (ID)

Humanities and Arts (HU)

Concentrations in:

American Studies

Environmental Studies

Humanities Studies of Science and Technology

History

Literature

Music

Philosophy, Religion

Drama/Theatre

Writing and Rhetoric

Art History

German Studies

Hispanic Studies

Science and Technology

Industrial Engineering (BU) (accredited by ABET)
 Interactive Media & Game Development (B.A. degree) (HU; CS)
 Interactive Media & Game Development Technology (HU; CS)
 Interdisciplinary (by arrangement)(IGSD)
 International and Global Studies (HU)
 Liberal Arts and Engineering (B.A. degree)(HU)
 Management Engineering (BU)(accredited by AACSB)

Concentrations in:

Biomedical Engineering
 Chemistry
 Civil Engineering
 Electrical and Computer Engineering
 Mechanical Engineering
 Manufacturing Engineering
 Operations Management
 Custom concentration

Management Information Systems (BU)(accredited by AACSB)

Mathematical Sciences (MA)

Subareas in:

Algebraic and Discrete Mathematics
 Computational and Applied Analysis
 Operations Research
 Probability and Statistics

Mechanical Engineering (ME)(accredited by ABET)

Concentrations in:

Biomechanical
 Engineering Mechanics
 Manufacturing
 Materials Science and Engineering
 Mechanical Design
 Robotics
 Thermal-Fluid Engineering

Physics (PH)

Professional Writing (HU)

Psychological Science (SSPS)

Robotics Engineering (CS; ECE; ME)(accredited by ABET)
 Society, Technology and Policy (SSPS)

Programs for students interested in medicine, law or pre-college education can be readily developed from many of the above majors.

Interdisciplinary (individually-designed) majors (ID) may also be developed under the B.S. or B.A. degree; see Interdisciplinary Programs, page 87.

WPI undergraduate diplomas designate “Bachelor of Science” or “Bachelor of Arts” as appropriate. The transcript will list the student’s major. If a Minor or Concentration was completed, this will also be included on the transcript.

The number of majors associated with a single WPI Bachelor’s degree is **limited to two**.

PROFESSIONALLY ACCREDITED PROGRAMS

WPI is accredited as an institution by the **New England Commission of Higher Education**. In addition, the aerospace engineering, architectural engineering, biomedical engineering, chemical engineering, civil engineering, electrical and computer engineering, environmental engineering, industrial engineering, mechanical engineering, and robotics engineering programs are accredited by the Engineering Accreditation Commission of

ABET, <http://www.abet.org>. The Chemistry and Biochemistry Department and its program are approved by the **American Chemical Society**. The bachelor’s and master’s degree programs offered by the Robert A. Foisie School of Business are accredited by **AACSB International — The Association to Advance Collegiate Schools of Business**.

WPI's advising program is based on a cooperative and understanding relationship between the students and advisors. Under the WPI Plan, *students have the final responsibility* for designing their own educational experience at WPI which includes *understanding all their degree requirements and making sure all those requirements have been satisfied for graduation*. The role of the faculty advisor is to help his/her advisees design a program of study which reflects the students' interests and professional goals. While advisors are willing to suggest specific programs of study, they will not insist that students follow a particular path. Advisors also help students choose among academic alternatives, help them interpret catalog requirements and review degree audits and grade reports with them. Students are expected to understand these documents and their implications for academic progress and act accordingly. Therefore it is critical that students take the initiative to consult regularly with their academic advisors.

The Office of Academic Advising at WPI has three main areas of focus: 1) general academic advising; 2) academic resources; and 3) pre-health programs.

GENERAL ACADEMIC ADVISING

Students can come to the Office of Academic Advising to get general advising help in areas such as course selection, academic status concerns, major and advisor selection, and individualized academic coaching. The Office of Academic Advising oversees programming for the First Year, including the Insight Program and the Insight Wellness course.

The academic coaching program includes counseling from an Academic Advisor in areas such as learning styles, effective study strategies, problem solving and critical thinking skills, and time management. Students work on setting their academic goals, discovering their strengths and weaknesses, and designing learning and study strategies that work best for them.

ACADEMIC RESOURCES CENTER

The Academic Resources Center (ARC) at WPI is located in Daniels Hall, and houses the academic tutoring program and MASH (Math and Science Help). Peer tutors and academic coaches are students who have demonstrated a mastery of material, and have been trained in peer tutoring and communication.

The MASH program is an academic support program for students enrolled in math and science classes. Offered to all students in a supported course, MASH provides assistance in regularly scheduled weekly study sessions beginning the first week of every term.

MASH review sessions are offered for a limited number of courses which students and faculty have identified as challenging. Many of the courses are typical first year classes, allowing extra support for students transitioning to college-level work. Each session is guided by a MASH leader, an undergraduate student who has taken the course before and has excelled. He/she understands the course material and what the instructor expects. MASH leaders attend lectures so they are prepared for questions that might arise in a MASH session.

Through the MASH and tutoring programs students become actively involved with the content material in a supportive environment. Studies show that students who attend MASH or tutoring regularly earn higher grades than students electing not to participate. Even more importantly, they learn how to master new concepts, learn how to put ideas into perspective, develop a better way to study, and effectively manage their time.

PRE-HEALTH ADVISING

The Pre-Health Advisor works with students who are interested in pursuing careers in the health professions. Students may meet with the Pre-Health Advisor to a) explore various careers in healthcare and receive assistance in selecting the most suitable path for themselves; b) receive advice regarding pre-requisite courses and other preparation for various health professions programs (e.g. medicine, dentistry, veterinary medicine, optometry, physician assistant studies, physical therapy, among others); c) receive assistance throughout the professional school application process, including the arrangement of a committee recommendation letter; d) take advantage of academic coaching or receive general help. The Office of Academic Advising collaborates with the Career Development Center and other offices on campus to offer special programming for pre-health students. Students may make an appointment for any of these services by contacting the Office of Academic Advising at 508-831-5381.

OFFICE OF DISABILITY SERVICES

Academic accommodations are available for students with documented disabilities. Please see page [226](#) for more information.

CONCENTRATIONS

DEFINITION

A Concentration is an option associated with a major which provides recognition for focused and coordinated academic work either within the major or within an area of study closely related to the major.

RULES

1. All Concentrations require completion of two units of integrated academic study plus an MQP with a topic and content appropriate to the given Concentration.
2. Concentrations deemed to belong exclusively or primarily within the stated major must be accommodated within the distribution requirements of that major.
3. Concentrations deemed to have a substantial interdisciplinary nature can exceed the normal 10-unit allotment of the major by as much as 1 unit, provided that the additional requirements do not include or permit academic work designated by the major prefix or coursework normally taken to satisfy the major's portion of the distribution requirements. Furthermore, Concentrations of an interdisciplinary nature are permitted to use up to 1 unit of the academic program beyond the distribution requirements of the major, including the IQP, Social Science requirement, and Free Electives, as deemed appropriate.
4. The requirements of the Concentration must be designed to offer choices for the student within the major area and, if relevant, outside the distribution requirements of the major; however, the Concentration requirements must not preclude meeting the normal distribution requirements for the major.
5. Rules and guidelines for each Concentration will be formulated by the faculty associated with the governing major, and must be reviewed by the Committee on Academic Operations (CAO) and subsequently approved by the Faculty. CAO is empowered to rule on whether a proposed Concentration is disciplinary or interdisciplinary.
6. An individual program of study leading to a major with a Concentration will be planned by a student in consultation with his/her academic advisor. The student's intention to pursue a Concentration will be declared by application to the appropriate Program Review Committee in accordance with that Committee's schedule of deadlines. Application deadlines should be designed to enable Committee review and communication of decisions to students at a sufficiently early point that flexibility of schedule still exists. Extenuating circumstances may be considered at the discretion of the Program Review Committee.
7. Concentrations and minors are additional degree designations. Any credit earned for an additional degree designation **must not overlap with credit earned for another additional degree designation by more than one unit. Also, no credit-bearing activity may be triple-counted** towards degree designations or degree requirements.

Listings of Concentrations may be found in the "Department and Program Descriptions" section beginning on page 28.

MINORS

DEFINITION

A minor is a thematically-related set of academic activities leading to a degree designation in addition to but separate from that granted by the major. A minor should be available to students of any major, with the exception of a minor which overlaps with a major area to such an extent that it is not sufficiently distinct from that major. The Committee on Academic Operations (CAO) is responsible for the review of proposed minor programs and decisions regarding allowed major/minor combinations.

RULES

1. A minor requires completion of two or more units of thematically related activity. Individual departments may impose additional restrictions such as a capstone or integrative experience. Students should consult individual minor Program descriptions in Section 2 of this catalog for these restrictions.
2. It is expected that minor requirements will be structured so that all acceptable major/minor combinations can be accommodated within a normal 16 term framework.
3. A minor may include any portion of the academic program, excluding the MQP. Academic activities used in satisfying the regular degree requirements may be double-counted toward meeting **all but one unit of the minor requirements**, subject to the following restrictions:
 - a. The one unit of double-counted work may include at most 1/3 unit of the IQP, 3/3 units of the Humanities and Arts Requirement, or a combination thereof.
 - b. At least one unit of the minor must be free elective choices. For the social science exception see page 121.
4. The Program Review Committee for a minor area will consist of faculty members designated by the sponsoring faculty members.
5. A minor area must be proposed by a sponsoring group of faculty and must be defined by the purpose of achieving an educational goal beyond those apparent or implicit in the regular degree requirements. Student-initiated minor programs must be developed with the approval of a sponsoring group of faculty advisors. Each minor program must be reviewed by CAO for its individual merit.
6. Minors are additional degree designations. Any credit earned for an additional degree designation **must not overlap with credit earned for another additional degree designation by more than one unit. Also, no credit-bearing activity may be triple-counted** towards degree designations or degree requirements.

Minors are described in the “Program Description” section of this catalog. Minors sponsored by a department are described following the department. Others are listed in the “Interdisciplinary Minors” section. As of the printing of this catalog, the following minors have been approved:

Astrophysics; Biology; Biochemistry; Bioinformatics and Computational Biology; Business; Chemistry; Chinese Studies; Computer Science; Data Science; Drama/Theatre; Economics; Electrical and Computer Engineering; English; Entrepreneurship; Environmental and Sustainable Studies; German; Global Public Health; History; Industrial Engineering; Interactive Media & Game Development; International and Global Studies; Law and Technology; Management Information Systems; Manufacturing Engineering; Materials; Mathematics; Mechanical Engineering; Media Arts; Music; Nanoscience; Philosophy and Religion; Physics; Political Science and Law; Psychology; Robotics Engineering; Social Entrepreneurship; Social Science; Spanish; Statistics; Sustainability Engineering; System Dynamics; Writing.

Interdisciplinary or Individually Designed (ID) minors are approved by the Committee on Academic Operations (CAO).

The form needed to declare a minor or to propose an interdisciplinary or individually designed minor can be found in the Registrar’s Office.

DOUBLE MAJORS

An option for some students who wish to broaden their WPI experience is the completion of two distinct majors through the double major option. The choice to pursue a double major should be made early in a student’s career. No student shall complete more than two undergraduate majors.

For double majors, the diploma may list both majors (in order of preference by the student), either major, or no major as indicated by the student.

A double major should signify capacity in two distinct disciplines. Some combinations of double majors are not sufficiently distinct to merit this designation. Departments and programs decide whether any combinations of double majors overlap to such an extent as to be disallowed. As of the publication date of this catalog, the following combinations are not allowed:

- Actuarial Mathematics and Mathematical Sciences
- Aerospace Engineering and Mechanical Engineering
- Biochemistry and Chemistry
- Business and Management Engineering
- Business and Management Information Systems
- Civil Engineering and Architectural Engineering
- Civil Engineering and Environmental Engineering
- Industrial Engineering and Management Engineering with Concentration in Operations Management

- Interactive Media and Game Development Technology and Interactive Media and Game Development
- Management Engineering and Management Information Systems
- Physics and Applied Physics

Students who wish to pursue any double major should consult with faculty advisors in both majors. Exceptions to disallowed double majors must be approved by the Committee on Academic Operations.

Degree requirements for double majors are as follows

1. Distribution Requirements.

The distribution requirements of each major must be met, but requirements common to both majors have to be met only once.

2. The Humanities and Arts Requirement.

No modifications are made to the Humanities and Arts Requirement for double majors. All students, including majors in Humanities and Arts or International and Global Studies must satisfactorily complete the Humanities and Arts Requirement culminating in an Inquiry Seminar or Practicum.

3. The Interactive Qualifying Project.

If one of the majors of a double major is in Social Science and Policy Studies, a single project bearing at least one unit credit may be used to satisfy both the MQP requirement for the SSPS major and the IQP requirement. In order to be used to satisfy both requirements, the combined social science MQP and IQP must meet the goals of both projects. It must be interactive in nature involving an aspect of technology, and must also be an application of social science knowledge and analytical techniques. In order to select a single project that satisfies both the goals of the MQP and the goals of the IQP, the decision to pursue a social science double major needs to be made fairly early in the student’s career.

4. The Major Qualifying Project.

The MQP requirements for Double Majors may be fulfilled in either one of two ways:

- Option 1: Two distinct projects, one in each major, each of at least one unit of credit.
- Option 2: One interdisciplinary project of at least 4/3 units of credit, and having significant work associated with each major. An interdisciplinary project must be:
 - jointly advised by at least two faculty members, one associated with each of the relevant degree programs; OR
 - advised by a single faculty member who is associated with both of the relevant degree programs.

Faculty associated with each degree program are listed in Section 2 of the WPI Undergraduate Catalog.

An interdisciplinary MQP involving social science may not be used as an IQP.

The interdisciplinary MQP option takes advantage of the value of interdisciplinary work at the intersection of the two majors. Students undertaking an interdisciplinary MQP must complete an *interdisciplinary MQP approval form* in advance of project registration, and this form must be signed by all advisor(s) on the project. This form must contain a summary of the proposed project work indicating the content relating to each major. The interdisciplinary MQP option is available only at the discretion of the faculty and only when all faculty advisor(s) agree on the project content. Students planning to use this option should identify and consult with their faculty advisor(s) well before the end of their junior year.

For a double major, completion of a 4/3 unit interdisciplinary MQP completes the 1 unit MQP requirement for each major. The assignment of credit is as follows: 2/3 unit is double counted toward each major, and the remaining 2/3 unit is allocated as 1/3 unit to one major and 1/3 unit to the other major.

Note: It is anticipated that in some cases a student pursuing a double major will join a project team whose other members are pursuing a single major. The double-majoring student will bring the interdisciplinary content to the project, and this additional

work will be represented by the additional credit that that student (perhaps only that student) earns, and with an enlarged report prepared by that student.

For students wishing to pursue double majors, the program audit for each intended major must be completed and certified by the review committee of each department involved. Academic activities appropriate to both majors may be counted in both majors. For the policy in the special situation of double majors involving the social sciences see the Social Science and Policy Studies department description in Section 2 and the Double Major Distribution Requirements in Section 4 of the Undergraduate Catalog.

Certain interdisciplinary MQP's and corresponding double-majors in the same department are not allowed.

Interdisciplinary MQP's with two faculty advisors: All faculty advisors have equal status in approving the final project, and a single grade is submitted for each term's work and a single project grade is submitted on the CDR form. Should an interdisciplinary MQP, once completed, be deemed acceptable as an MQP for one of the two majors, but not for the other, and/or if the faculty advisors cannot agree on a single grade after much effort to do so, the project may be considered as the MQP for a single major. This conversion can only occur with the consent of the student and the advisor(s) from the single major being selected.

At the heart of the WPI Plan is student research, open-ended inquiry, and original and creative design to solve problems and to make new discoveries. All students in all majors complete two qualifying projects:

1. the Major Qualifying Project (MQP),
2. the Interactive Qualifying Project (IQP).

The *Major Qualifying Project* requires the synthesis of all previous study as well as the development of new knowledge to solve problems in the student's major field. The MQP challenges the student to perform at an advanced level, as a professional would, and to communicate the results effectively.

The *Interactive Qualifying Project* challenges students to address a problem at the intersection of science and technology with human need.

These projects are substantial and are each equivalent to at least one-fourth of an academic year's worth of effort. Most IQPs are completed at an off-campus project center in collaboration with an external sponsor.

Projects must be accepted by a project advisor before project registration can be completed. Many project opportunities come from off-campus organizations, address real-world problems and thus provide experience invaluable for seeking jobs and for professional practice. Students are also encouraged to develop their own project ideas, to identify and work with interested faculty, and to form teams to pool resources and share points of view.

RESOURCES – GETTING STARTED

There are many opportunities for students to learn about project opportunities both in the major (for the MQP) and for the IQP. Advice and links to additional resources can be found on the Undergraduate Studies web page (<https://www.wpi.edu/academics/undergraduate>).

AVAILABLE PROJECTS

Students may obtain information about new or ongoing projects from a variety of sources. Principal sources include discussions with other students, especially those currently involved in a project, the Projects Program web site, department offices, or their web pages. Off-campus projects are discussed annually in the fall. In the spring, Project Opportunities in eProjects 2.0 (<https://eprojects.wpi.edu/>) can be used as a directory of specific IQP projects or as a source of ideas for developing your own projects. Some students will find a project listed which fits their needs and interests exactly. In other cases, the listing will serve to lead students to a faculty member with whom project involvement can be negotiated. The proposals in eProjects 2.0 are updated periodically to provide an accurate listing of available projects.

Students are encouraged to check the web site of the department of their major and Project Opportunities for MQPs in eProjects 2.0 (<https://eprojects.wpi.edu/>), as well as consulting with their academic advisors and with faculty in their courses. In addition, academic departments hold special events where faculty present project and other research opportunities to connect with students who are currently doing research.

PROJECT ADVISOR

Academic advisors can assist students in identifying a project. They are aware of the project interests of many other faculty members, and have a list of faculty interests which will enable a student to find a faculty member who can help to develop a project idea. Faculty associated with the Interdisciplinary and Global Studies Division (IGSD) are available to assist students in interdisciplinary and interactive projects.

PROJECT PERFORMANCE AND TIME-ON-TASK

A student is normally expected to expend 15-17 hours per week on the average for each 1/3 unit of credit for project work, and expected achievement is based upon that commitment.

A project group, whether it involves one student or more, should have a minimum of one scheduled conference per week with the advisor(s). Additional time should be scheduled when the effort exceeds 1/3 unit per student or when more students are involved.

Students should be prepared to submit interim project reports to the advisor each week. Students are also encouraged to complete a proposal at the beginning of the project activity to define the scope and timeline for completion of the effort. In addition, oral reports may be required as determined by the advisor. At the end of the project, a report must be prepared to the satisfaction of the project advisor. For projects sponsored by off-campus organizations, both a written and oral report for the sponsors is normally expected.

QUALIFYING PROJECT GRADING

The Faculty of WPI has endorsed the following grading guidelines for qualifying project activity:

1. Each term a student is registered for a qualifying project, the student receives a term grade reflecting assessment of his or her accomplishments for that term.
2. Upon completion of a project, each student will receive an overall project grade (also known as the "CDR grade," since it certifies completion of the degree requirement) reflecting his or her individual overall accomplishments for the project.
3. The term grades and the overall project grade reflect both the *products* of the project (e.g., results, reports, etc.) and also the *process* by which they were attained. The term grades and the overall project grade may be different.

The following are some characteristics that faculty should use in communicating expectations and evaluating the quality of each student's project work.

The degree to which the student:

- developed effective or creative goals or approaches,
- demonstrated initiative and originality,
- showed depth and critical thought in analysis,
- produced high quality results,
- took the lead in discussion, planning, and analysis,
- produced a clear, professional-level report with excellent drafts along the way,
- anticipated work that needed to be done and completed it in a timely manner, and
- worked to advance the success of the team.

For both terms and overall project, the available grades and interpretations are:

A: This grade denotes *excellent work* that attains all of the project goals and learning outcomes. The product and process of this work meet all of the expectations and exceed them in several areas.

B: This grade denotes *consistently good work* that attains the project goals and learning outcomes. The product and process of this work meet but generally do not exceed all of the expectations.

C: This grade denotes *acceptable work* that partially attains project goals and learning outcomes. The product and process of this work meet some but not all expectations.

SP: This grade denotes *satisfactory progress* and certifies sufficient accomplishments to earn credit for that term. Faculty who assign this grade should provide clear feedback to the student regarding his or her progress during the term. The use of the SP grade is discouraged except in circumstances where the faculty member is unable to judge the quality of the work, yet can attest that the granting of credit is appropriate. This is a temporary grade and must be replaced by a permanent grade consistent with the criteria outlined above by, if not before, the end of the project.

NR: This grade denotes work that did not attain the project goals or learning outcomes and is *insufficient for registered credit*. Both product and process were inconsistent with acceptable project work at WPI as outlined above.

NAC: This grade is reserved for *performance that is unacceptable*. It might mean that a student's performance (or lack of it) has seriously impeded group progress, or it has embarrassed the group, a project sponsor, or WPI. Note that this grade remains on the transcript.

4. Project goals should be established and clearly articulated early in the project. This may be done in the form of a formal project proposal. Learning outcomes for the qualifying projects have been established by the faculty and are published in the undergraduate catalog.
5. Project advisors should clearly convey in writing their expectations for learning and performance to project students at the start of the project, and provide students with substantive feedback on a regular basis during the project.

ELECTRONIC PROJECT SUBMISSION

WPI requires that all undergraduate students submit their Interactive Qualifying Project (IQP) and Major Qualifying Project (MQP) electronically (wpi.edu/+eprojects).

Students must be registered for a minimum of 1/6 unit of qualifying project credit in the term in which the final project report is submitted. An eProject must be submitted via the web site, wpi.edu/+eprojects, following the steps outlined there.

No matter which format is used to create the original report document (Microsoft Word, LaTeX or other), the final report must be converted to a PDF format in order to be submitted as

an eProject. The final PDF is required, and additional related files such as simulations, computer programs, multimedia, and data sets may be submitted as a component of the project. Guidance on eProject report formatting and file formats for the final report and any supplementary files is provided within the online submission process.

Every eProject must include a title page and must follow the formatting guidelines described at wpi.edu/+eprojects.

The final project report should be carefully proofread. Once the submitted project has been approved by the advisor and released to WPI's digital repository (Digital WPI) by the Registrar's Office, it is considered an academic record and cannot be edited.

The deadline for the submission of the initial report draft and the final document may be established at the discretion of the project advisor. Drafts and reports need *not* be accepted by the advisor after the established deadline.

A project that is completed by a team of students, except in extenuating circumstances, will submit ONE project report from the group. After the MQP or IQP team submits the final version of the project report, the advisor must review the work and approve or reject it online at wpi.edu/+eprojects.

A completed electronic Completion-of-Degree-Requirement (eCDR) form, must be printed for signature by each student and signed individually by the advisor as the final step in the submission process. The eCDR form must be submitted in person by the project advisor or a member of the academic department of the advisor to the Office of the Registrar by no later than the tenth day of the next academic term.

A student who has filed an application to receive their degree in May must submit a completed eCDR to the Office of the Registrar by the last Thursday in D-term.

GROUP QUALIFYING PROJECT EFFORTS

Students meeting a qualifying project degree requirement by participation in a group, or team effort, will submit, at the discretion of the project advisor, either a single, comprehensive written report from the group, or individual written reports from each member of the group. A single, comprehensive written report must, however, include some means by which each individual's contribution to the group effort may be clearly identified. This identification may take the form of an "author-ship page," simply a list of individual chapters and their respective authors, or of a prefacing statement in which each contributing group member is named as having carried out one or more specific tasks within the overall project effort.

In the case where one or more students leave an ongoing group project after having contributed at least one unit each of project effort, those students, again at the discretion of the project advisor, will submit either a single written report or individual written reports in satisfying the qualifying project documentation requirement. The same means of identifying individual contributions will be employed as described above.

DISSEMINATION OF PROJECT REPORTS

Completed project reports are made available to the public through Digital WPI, managed by WPI's Gordon Library (<https://www.wpi.edu/library/digital-wpi>).

MQPs and IQPs completed for off-campus agencies are usually distributed within the sponsoring agency by the agency project liaison. A project report may be redacted or restricted from public viewing for a defined period of time, if it contains confidential or proprietary information of a sponsoring agency.

Students are responsible for keeping personal copies of project reports for their own permanent professional records. In this way, reports can be reviewed for later use, and incorporated into a professional portfolio.

Thus, MQPs and IQPs are best viewed as research reports which establish good professional practices as well as being potential sources for further study and research.

PAY AND CREDIT (for students working on sponsored projects)

A student may receive pay for work associated with a registered project under the following conditions:

1. The work done for pay is clearly distinguished from the work defined for academic credit for the project. This distinction must be clearly articulated in a conflict of interest statement signed by all participating parties before the project begins.
2. Results obtained from paid or unpaid work performed while students are not registered for project credit at WPI may be used in projects only after consultation with the project advisor. When possible, such consultation should take place before work begins.

The qualifying project in the major field of study should demonstrate application of the skills, methods, and knowledge of the discipline to the solution of a problem that would be representative of the type to be encountered in one's career. The project's content area should be carefully selected to complement the student's total educational program. In defining the project area within which a specific topic is to be selected, the student and academic advisor should pay particular attention to the interrelationships that will exist between the bodies of knowledge represented by courses, independent studies, and Preliminary Qualifying Projects; and by the Interactive Qualifying Projects.

MQP activities encompass research, development, and application, involve analysis or synthesis, are experimental or theoretical, emphasize a particular subarea of the major, or combine aspects of several subareas. In many cases, especially in engineering, MQP's involve capstone design activity. Long before final selection of a project topic, serious thought should be given as to which of these types of activities are to be included. Beyond these considerations, the MQP can also be viewed as an opportunity to publish or to gain experience in the business or public sectors.

Off-campus MQP's are also very valuable for access to state-of-the-art resources and contacts for future professional work.

GETTING STARTED ON AN MQP

Project topics are originated by students, faculty, or practicing professionals participating in WPI's off-campus project programs. A faculty member in each academic department acts as Project Coordinator for all majors within the department. The Project Coordinator has assembled MQP topic descriptions being proposed and has identified the faculty who will serve as project advisors for each topic. All project opportunities—MQP, IQP, PQP, on-campus originated and off-campus originated are made available to the student body through a planned information-sharing program of activities during C and D terms of the academic year prior to the start of the project.

PROJECT PROPOSALS

Students are strongly encouraged to begin their MQP's with a project proposal. A detailed guide to preparing project proposals is available in department offices or on the Projects Program web page (<https://www.wpi.edu/academics/Projects/>).

MQP LEARNING OUTCOMES

By completing their MQP, WPI students will achieve the following learning outcomes at a level at least equivalent to that of an entry level professional or graduate student.

Students who complete a Major Qualifying Project will:

1. apply fundamental and disciplinary concepts and methods in ways appropriate to their principal areas of study.
2. demonstrate skill and knowledge of current information and technological tools and techniques specific to the professional field of study.
3. use effectively oral, written and visual communication.
4. identify, analyze, and solve problems creatively through sustained critical investigation.
5. integrate information from multiple sources.
6. demonstrate an awareness and application of appropriate personal, societal, and professional ethical standards.
7. practice the skills, diligence, and commitment to excellence needed to engage in lifelong learning.

Specific disciplinary programs may add additional MQP outcomes, such as design or mathematical skills or teamwork, as appropriate.

MQP PROJECT CENTERS

Each project center has a WPI faculty member as the director, well-defined procedures for completing project work, and selective admissions processes. The Centers tend to be highly structured and require superior performance.

At the present time, the WPI project center close to campus is:

- University of Massachusetts Medical School Project Center/
Tufts University Cummings School of Veterinary Medicine.

See also page 19 for residential Project Centers at a distance from WPI.

UNIVERSITY OF MASSACHUSETTS MEDICAL SCHOOL PROJECT CENTER/TUFTS UNIVERSITY CUMMINGS SCHOOL OF VETERINARY MEDICINE

Major qualifying projects are available at nearby University of Massachusetts Medical School (UMMS) and Tufts University Cummings School of Veterinary Medicine (TUCSVM) for students from many disciplines on campus. These institutions are nationally recognized for research and medicine and offer project opportunities over a wide range of research areas. Students performing projects at these centers work in cutting edge research programs and typically interact with graduate and post-doctoral researchers to solve real-world problems.

It is recommended that students spread their projects over the entire academic year. Students from any major interested in project opportunities should contact Dr. Destin Heilman in the department of Chemistry and Biochemistry.

At WPI, students are expected to develop an understanding of how science and technology are embedded in the fabric of society. The Interactive Qualifying Project (IQP) challenges students to address a problem that lies at the intersection of science or technology with society. During the IQP, students work in interdisciplinary teams, often with an external sponsoring organization, to develop solutions to real world problems. In doing so, students learn something about the role of science and technology, its impact on society, its place in meeting human needs and human efforts to regulate, control, promote and manage our changing technologies. The IQP is equivalent to three courses, typically undertaken in a student's junior year. It can be completed over three terms, or as a full course load for a student for one term, and it can be completed on-campus, or at one of our many residential project centers in the U.S. and abroad. For more on the IQP see the websites of the Interdisciplinary and Global Studies Division (IGSD) at <https://www.wpi.edu/academics/igsd/iqp.html>. For more on the IQP and study abroad, see the Global Projects Program website: <https://www.wpi.edu/academics/igsd/gpp.html>. Completed IQP reports are electronically archived and made available to the public through Digital WPI, managed by WPI's Gordon Library <https://www.wpi.edu/library/digital-wpi>.

IQP LEARNING OUTCOMES

The Faculty adopted the following statement defining learning outcomes for the IQP. Successful completion of an IQP is an important element in helping students achieve WPI's overall undergraduate learning outcomes.

Students who complete an Interactive Qualifying Project will:

1. Demonstrate an understanding of the project's technical, social and humanistic context.
2. Define clear, achievable goals and objectives for the project.
3. Critically identify, utilize, and properly cite information sources, and integrate information from multiple sources to identify appropriate approaches to addressing the project goals.
4. Select and implement a sound methodology for solving an interdisciplinary problem.
5. Analyze and synthesize results from social, ethical, humanistic, technical or other perspectives, as appropriate.
6. Maintain effective working relationships within the project team and with the project advisor(s), recognizing and resolving problems that may arise.
7. Demonstrate the ability to write clearly, critically and persuasively.
8. Demonstrate strong oral communication skills, using appropriate, effective visual aids.
9. Demonstrate an awareness of the ethical dimensions of their project work.

PREPARING FOR AND FINDING AN IQP

Students are encouraged to view the IQP as a learning opportunity – a chance to gain knowledge outside their major field – while working with others to solve open-ended, complex problems. The best approach is to consult with one's academic advisor and select courses to be taken in the first and second year at WPI that can provide a foundation for an IQP in the junior year. Often project preparation involves developing an understanding of the social sciences and humanities, as the concepts and analytical techniques of these disciplines are important in understanding the social context of science and technology. In addition, students enrolled in the Global Projects Program will be expected to complete a course devoted to project preparation in advance of their travel.

Project topics originate with external organizations, faculty and students. Students who complete IQPs at a residential project center through the Global Projects Program work on project topics identified by external sponsoring organizations. Students can explore these opportunities in eProjects 2.0 (eprojects.wpi.edu) and at the Global Opportunities Fair organized each September by the Interdisciplinary and Global Studies Division (IGSD, <https://www.wpi.edu/+igsd>). Students completing projects on campus are encouraged to seek faculty members that share their interests to advise projects. Faculty interested in advising specific IQPs will post their project topics in eProjects 2.0 (eprojects.wpi.edu). The IGSD also hosts an On-Campus Project Opportunities Fair each March where students can meet faculty advisors to discuss projects being offered on campus during the following year.

The IGSD offers administrative support for project activities. Students are welcome to seek further assistance from the staff on the second floor of the Project Center.

WHAT ARE IQPS ABOUT? SCIENCE, TECHNOLOGY AND SOCIETY

A detailed explanation of the IQP and its options can be found at <https://www.wpi.edu/academics/undergraduate/interactive-qualifying-project>. Proposed projects can be located in eprojects.wpi.edu. IQP (and MQP) projects are searchable in Digital WPI (<https://www.wpi.edu/library/digital-wpi>).

The Global Projects Program, overseen by the Interdisciplinary and Global Studies Division, offers WPI students the opportunity to complete a project at one of WPI's off-campus project sites. Some centers are residential, with students traveling to and living on site for an entire term, while others offer the opportunity to complete an off-campus project in Worcester, Boston, or other nearby communities. Project work conducted at these sites provides teams of students with extraordinary opportunities to learn by solving real-world problems provided by industry, non-profit, non-governmental or government agencies.

The application process for these programs begins in the fall with the Global Fair. At the Fair, IQP, MQP, HUA and exchange program directors will be available to talk with students. Students should apply in Term A of the year preceding the year in which they would like to participate. Further information is available at the Interdisciplinary and Global Studies Division in the Project Center or through the Program Guide: <https://www.wpi.edu/project-based-learning/global-project-program/program-guide>

Application processes are competitive and accepted students must complete a series of pre-departure orientations and submit required paperwork to be eligible to travel.

All students accepted to an off-campus IQP Center will be registered for the preparation courses (ID 2050 and PQP) in the term immediately preceding their planned term of travel. Students must be making satisfactory progress in their academic coursework in order to participate. Students are highly discouraged from overloading during the preparatory term and may only overload during the project term with the permission of their project advisors.

Prior to leaving campus for a project program site, each student is required to complete a project registration form as described on page 217.

OFF-CAMPUS PROGRAMS

All programs offer students the opportunity to complete a project in one term of full-time work. Advance preparation is required. Faculty advisors are in residence at IQP sites and some Humanities and Arts and MQP sites.

REGION	PROJECT CENTER	TYPE	E	A	B	C	D	SITE DIRECTOR(S)
Africa & Middle East	Cape Town, South Africa	IQP						Scott Jiusto & Gbeton Sommasse
Africa & Middle East	Kyebi, Ghana	IQP/MQP						Rob Krueger
Africa & Middle East	Rabat, Morocco	IQP						Mohamed Brahimi & Tahar El-Korchi
Africa & Middle East	Rabat, Morocco	HUA						Rebecca Moody
Africa & Middle East	Windhoek, Namibia	IQP						Creighton Peet
Africa & Middle East	Israel (Eilat)	IQP						Isa Bar-On
Africa & Middle East	Israel (Multiple Cities)	MQP						Isa Bar-On
Asia	Bangkok, Thailand	IQP						Esther Boucher & Rick Vaz
Asia	Beijing, China	IQP/MQP						Jianyu Liang
Asia	Hangzhou, China	IQP						Wen-Hua Du & Jennifer Rudolph
Asia	Hong Kong, China	IQP						Creighton Peet
Asia	Japan (Kyoto)	IQP						Jennifer deWinter
Asia	Japan (Multiple Cities)	HUA						Jennifer deWinter
Asia	Japan (Osaka/Kyoto)	MQP						Jennifer deWinter
Asia	Mandi, India	IQP						Ingrid Shockey
Asia	Yerevan, Armenia	IQP						Michael Aghajanian
Europe	Berlin, Germany	IQP						Dan Dimassa, Katherine Foo & Stephan Sturm
Europe	Bucharest, Romania	IQP						Bogdan Vernescu & Rodica Neamtu
Europe	Copenhagen, Denmark	IQP						Holly Ault & Peter Hansen
Europe	France (Multiple Cities)	Exchange						Norman Wilkinson
Europe	Konstanz, Germany	Exchange						Ulrike Brisson
Europe	London, England	IQP						Dominic Golding
Europe	London, England	HUA						Esther Boucher
Europe	Lyon, France	IQP						Peter Hansen & Fabienne Miller

20 GLOBAL PROJECTS PROGRAM

REGION	PROJECT CENTER	TYPE	E	A	B	C	D	SITE DIRECTOR(S)
Europe	Moscow, Russia	IQP						Svetlana Nikitina
Europe	Nancy, France	MQP						Steve Kmiotek
Europe	Reykjavik, Iceland	IQP						Aaron Sakulich
Europe	Stockholm, Sweden	MQP						Holy Ault
Europe	Thessaloniki, Greece	IQP						Bob Hersh
Europe	Tirana, Albania	IQP						Bob Hersh & Peter Christopher
Europe	Venice, Italy	IQP						Fabio Carrera
Europe	Worcester, England	IQP						Rob Krueger
Europe	Zurich, Switzerland	IQP/MQP						Nancy Burnham
North America	Bar Harbor, ME	IQP						Fred Bianchi
North America	Boston, MA	IQP						Paul Mathisen & Seth Tuler
North America	Gallo-Modesto, CA	MQP						David DiBiasio & Nikolaos Kazantzis
North America	Glacier National Park, MT	IQP						Fred Bianchi
North America	Hilo, Hawaii	IQP						Lauren Mathews
North America	MIT Lincoln Lab-Lexington, MA	MQP						George Heineman
North America	MITRE-Bedford, MA	MQP						Andrew Clark & Shamsnaz Virani Bhada
North America	Nantucket, MA	IQP						Dominic Golding
North America	San Juan, Puerto Rico	IQP						Lauren Mathews
North America	Santa Fe, NM	IQP						Fabio Carrera
North America	Silicon Valley, CA	MQP						Mark Claypool
North America	Stantec-Boston, MA	MQP						Suzanne LePage
North America	Wall Street/FinTech	MQP						Robert Sarnie
North America	Washington, DC	IQP						Kent Rissmiller
North America	Water Resource Outreach Center	IQP						Corey Dehner & Paul Mathisen
North America	Worcester, MA	IQP						Laura Roberts
South & Central America	Monteverde, Costa Rica	IQP						Melissa Belz
South & Central America	Panama City, Panama	IQP/MQP						Aaron Sakulich & Tahar El-Korchi
South & Central America	San Jose, Costa Rica	IQP						Melissa Belz
South & Central America	Asuncion, Paraguay	IQP						Rob Traver
South & Central America	Buenos Aires, Argentina	HUA						Aarti Smith Madan
South & Central America	Campinas, Brazil	MQP						Mike Timko
South & Central America	Cuenca, Ecuador	IQP						Laureen Elgert & Courtney Kurlanska
South Pacific	Melbourne, Australia	IQP						Lorraine Higgins & Steve McCauley
South Pacific	Wellington, New Zealand	IQP						Mike Elmes & Ingrid Shockey

INDIVIDUALLY SPONSORED RESIDENTIAL PROJECTS (ISRPs)

Through the Individually Sponsored Residential Projects (ISRP) process, faculty may design custom off-campus projects in addition to the established options available at WPI Project Centers. **ISRPs are subject to an approval process through the IGSD that includes routine planning and risk management protocols employed for the Global Projects Program.**

Consult the Global Portal at <https://www.wpi.edu/+globalportal> for ISRP Process Deadlines. Please contact IGSD at global@wpi.edu with any questions about the ISRP process.

INDIVIDUALLY SPONSORED ON-CAMPUS IQP PROGRAMS

CENTER FOR SUSTAINABLE FOOD SYSTEMS

Co-Directors Prof. Bob Hersh and Elisabeth (Lisa) Stoddard
In this set of on-campus IQPs students will work collaboratively with community groups, public health agencies, farmers, ecological designers, and organizations involved in regional food planning to: 1) improve access to healthy food in neighborhoods in Worcester, central Massachusetts, and regionally; 2) create closer links among food system activities (production, processing, distribution, consumption, waste disposal) 3) catalyze food business opportunities (e.g., urban farms, food processing, community kitchens, composting services) in these communities; and 4) collaborate with farmers on innovative designs for small scale food production (e.g., bioshelters, grain harvesters, vertical farms).

Recent projects include designing and building a commercial bike trailer out of recycled and 3D printed materials for an urban farmer in Boston and improving winter heating and lighting systems using solar to increase winter egg production on a farm in western MA. The Center also works with students on ongoing volunteer community projects, including growing seedlings in the university's green house for the two organic farms and dozens of school and community gardens run by the Regional Environmental Council. For more information, please contact Prof. Elisabeth (Lisa) Stoddard (eastoddard@wpi.edu).

ENERGY SUSTAINABILITY PROJECT CENTER

Director, Professor Paul Mathisen, Kaven Hall 209E

This center supports and helps to coordinate project work (both MQPs and IQPs) in all aspects of energy and across all areas of academic inquiry at WPI. A goal is to promote the use of innovative technologies and approaches to meet on-campus, regional, and global energy challenges. The principles of sustainability, with consideration to economics, the environment, and social justice, are emphasized in all of the Center's activities. The Center's objectives are to

support and to facilitate the organization of project teams and advisors to address problems involving sustainability and energy. Areas of interest range from traditional and renewable forms of energy to the use of systems approaches to address the relationships between energy and societal needs such as buildings, transportation, food and water. Center activities include the following: communication of WPI's activities in the energy area both internally and externally; establishment of a clearinghouse for project topics and the formation of project teams; organization of a forum for discussion of major energy-related topics, highlighting excellent energy-related projects; and identifying externally-sponsored projects. For more information contact Prof. Paul Mathisen (mathisen@wpi.edu).

STEM EDUCATION PROJECT CENTER

"Talent is equally distributed but opportunity is not." – Leila Janah

This often-quoted phrase is the heart of this Project Center and focuses on PreK-12 Science, Technology, Engineering, and Mathematics (STEM) Education. With the goal of improving PreK-12 STEM education opportunities for all children, our objectives include: 1) providing engaging and inclusive STEM activities to diverse audiences, 2) examining the educational opportunity gaps in different contexts, and 3) supporting informal and formal educators in STEM. Some projects may be to design, develop, and test hands-on, standards-aligned, PreK-12 STEM; to examine STEM education in a global context; and to develop sustainable relationships between WPI and local non-profits around STEM opportunities. In addition, the teaching practicum requirement in the Teacher Preparation Program is typically done as an IQP during A&B or C&D terms. These projects (MQPs and IQPs) are in partnership with the STEM Education Center at WPI and PreK-12 schools, afterschool programs, non-profits, and educators. Faculty are invited to bring projects under the STEM Education Project Center. For more information, please contact Kathy Chen (kcchen@wpi.edu) and go to <https://www.wpi.edu/+stem>.

SUSTAINING WPI PROJECT CENTER

Co-Directors, Suzanne LePage and Derren Rosbach

There is a great deal of interest in enhancing the sustainability of WPI – both as an institution and as a campus. The Sustaining WPI Project Center was developed to support and coordinate project work (primarily IQPs) developed around these interests. Project topics are proposed by the project teams based on their sustainability interests and in coordination with faculty advisors and the WPI Office of Sustainability. The intent is to address all aspects of sustainability as outlined in the WPI Sustainability Plan: campus facilities, the educational curriculum, research and scholarship, as well as civic engagement. The Center sponsors IQPs in D-term each year with student preparations beginning in C-term. For more information contact Suzanne LePage (slpage@wpi.edu).

OVERVIEW

The Humanities and Arts Requirement empowers students to meet the broad educational goals of WPI. The balance between technological and humanistic education and the emphasis on inquiry-based approaches to student learning have been and remain hallmarks of a WPI education. In concert with WPI's other degree requirements, the Humanities and Arts Requirement embodies the institute's definition of an educated person. The Humanities and Arts Requirement engages students with theory and practice – *Lehr und Kunst* – through the following educational goals.

GOALS OF THE HUMANITIES AND ARTS REQUIREMENT

- to introduce students to the breadth, diversity, and creativity of human experience as expressed in the humanities and arts;
- to develop students' ability to think critically and independently about the world;
- to enhance students' ability to communicate effectively with others in a spirit of openness and cooperation;
- to enrich students' understanding of themselves;
- to deepen students' ability to apply concepts and skills in a focused thematic area through sustained critical inquiry;
- to encourage students to reflect on their responsibilities to others in local, national and global communities;
- to kindle in students a life-long interest in the humanities and arts.

MEETING THE REQUIREMENT

Students fulfill the humanities and arts degree requirement by completing two units of work consisting of five student-selected courses followed by a 1/3 unit Inquiry Seminar or Practicum (HU 3900, HU 3910, or equivalent). In selecting the courses, students must complete depth and breadth components of the requirement, as described below. *All 5 HUA courses must be completed before beginning the Inquiry Seminar or Practicum.* At the end of the Inquiry Seminar or Practicum, every student will submit a completion-of-degree requirement form (CDR) to certify completion of the requirement.

DEPTH COMPONENT:

The WPI Plan calls for students to develop a meaningful grasp of a thematic area of the humanities and arts. *To ensure this depth, students complete at least three courses of thematically-related work prior to a culminating Inquiry Seminar or Practicum in the same thematic area.* Thematically-related work can be achieved in two ways:

1. Focusing on one of the following disciplines or disciplinary areas:
 - art/art history (AR)
 - music (MU)
 - drama/theatre (EN/TH)
 - literature and writing/rhetoric (EN, WR, RH)
 - history and international and global studies (HI, HU, INTL)
 - philosophy and religion (PY, RE)

Paths for language study are described below.

2. Defining the thematic area across disciplines or disciplinary areas in consultation with a Humanities and Arts faculty member.

To ensure that students develop a program of increasing complexity, at least one of the three thematically-related courses that precede the Inquiry Seminar or Practicum must be at the 2000-level or above. Students are strongly encouraged but not required to include a 3000-level course within their depth component. The structure of the requirement remains flexible so that students will become intentional learners as they select a sequence of thematically-related courses.

BREADTH COMPONENT:

To ensure intellectual breadth, before taking the final Inquiry Seminar or Practicum, students must take at least one course outside the grouping in which they complete their depth component. To identify breadth, courses are grouped in the following manner:

- art/art history, drama/theatre, and music (AR, EN/TH, MU);
- languages (SP, GN, ISE, AB, CN);
- literature and writing/rhetoric (EN, WR, RH);
- history and international and global studies (HI, HU, INTL);
- philosophy and religion (PY, RE).

WPI offers a flexible curriculum to entrust students with a significant amount of choice and responsibility for planning their own course of study. At the same time, WPI requires students to take at least one course outside the depth area in order to provide exposure to more than one disciplinary approach within the arts and humanities, which include the creativity of the fine and performing arts, modes of communication in languages and literature, and the cultural analysis of the past and present. Students are encouraged to experiment and to take courses in more than one group outside the depth area if they wish. By providing exposure to multiple areas, the breadth component encourages students to appreciate the fundamental unity of knowledge and the interconnections between and among diverse disciplinary fields.

The one exception to this breadth requirement is that students may take all six courses in a foreign language.

DEPTH AND BREADTH COMPONENTS IN FOREIGN LANGUAGES:

Development of proficiency in a language necessitates sustained engagement in the language beyond the elementary and intermediate level. Language instruction is broadly interdisciplinary and includes elements of the history, literature, and culture of a particular language area. A student in languages must still meet the depth component of the requirement by taking 6 courses in the language, one of which is approved as the final Inquiry Practicum or Seminar. Additional information about options for the Inquiry Practicum or Seminar in Chinese (CN), English for Non-Native speakers (ISE), German (GN) and Spanish (SP) can be found later in this section. A student who begins language study is not compelled to remain in that subject, but could choose to switch to another subject of study and complete the depth component in another thematic area.

INQUIRY SEMINAR OR PRACTICUM

The culmination of the depth component of the Humanities and Arts Requirement is an inquiry seminar or practicum. The educational goals for the seminar or practicum are the same regardless of the format.

OBJECTIVES OF THE INQUIRY SEMINAR OR PRACTICUM:

- *Critical inquiry*: to develop each student's ability to apply concepts and skills learned in the humanities and arts, the seminar/practicum offers opportunities to engage in sustained critical inquiry, analysis, or problem-solving in a focused thematic area.
- *Research and investigation*: to engage students in research, discovery, creativity, or investigation, the seminar/practicum provides opportunities for students actively and critically to seek and evaluate new information and insights using multiple sources. These opportunities need not necessarily be research papers.
- *Communication and writing*: to develop each student's ability to communicate effectively both orally and in writing, the seminar/practicum includes discussion of appropriate communications skills and provides opportunities to revise written work after receiving feedback from the instructor.
- *Intellectual independence*: to foster independence of thought, the seminar/practicum offers significant opportunities for individual, self-directed work.
- *Conversation and dialogue*: to promote individual reflection and the appreciation of diverse perspectives, the seminar/practicum consists of classroom activities other than traditional lecture to encourage discussion and collaborative learning in a spirit of openness, cooperation, and dialogue with peers. The thematic focus, structure, and assignments for each seminar or practicum are to be determined by each individual instructor to achieve these goals.

INQUIRY SEMINAR

The Inquiry Seminar, usually taken in the sophomore year, represents the culmination of the Humanities and Arts Requirement. The Seminar provides an opportunity for students to explore a particular topic or theme in the humanities in greater depth. The Seminar has two primary goals. The first is to foster independence of student thought, typically through some form of self-directed activity. The second is to encourage a cooperative, dialogic approach to inquiry, through open exchanges with peers in a small, intensive classroom setting (typically 12 students or fewer). Students learn how to frame questions in the context of a particular discipline or field of study, and to explore or investigate problems using methods appropriate to work in the humanities and arts.

As the student's capstone experience in the humanities and arts, the Inquiry Seminar is intended to help students take their knowledge of the humanities to a higher level. The purpose of the Inquiry Seminar, therefore, is not to provide a broad survey or general introduction to a given discipline, but to provide a structured forum in which students might approach a specific humanities-related problem or theme at a deeper, more

sustained level of intellectual engagement than would normally be possible within a traditional course setting. The pedagogical idea behind the Inquiry Seminar is that work in the humanities and arts is at once an intensely personal enterprise, in which the individual freely draws on her or his own particular interests, abilities, passions, and commitments, and at the same time a form of ethical community in which the practitioner is always in conversation with and accountable to others.

While the specific content and requirements of the Inquiry Seminar vary from instructor to instructor, all Inquiry Seminars incorporate self-directed learning as a significant part of the curriculum. It is the department's expectation, therefore, that by the time they enroll in the Seminar, students should have sufficient background in the humanities and arts to be able to work independently and to pose questions of their own. Students will be asked to research and write a term paper, to assemble a portfolio of writings or exercises, or otherwise to demonstrate their ability to pose a question of relevance to humanities inquiry, and to answer it. At the same time, the Seminars are designed to foster an atmosphere of intellectual collaboration and discovery. Students are required to participate fully in seminar discussion, to share the results of their own research or activities, and to engage the ideas and interests of their peers in a constructive and collegial way.

PRACTICUM IN HUMANITIES AND ARTS

Students in the performing arts have the option to complete their Humanities and Arts sequence with an Inquiry Practicum in music or drama/theatre. A practicum shares the same goals and objectives of an inquiry seminar but provides students with a production/performance experience which emphasizes the hands-on, practical application of skills and knowledge gained from previous Humanities and Arts courses. Samples of practicums in music include composing, arranging, or performing a solo recital. Drama/Theatre students may choose to act, direct, or design for a campus production. In addition to weekly meetings, students may be required to attend rehearsals and performances. The design of the final project is determined through conversations between instructors and students. Due to the unique nature of the practicum, permission of the instructor is required to enroll in a practicum.

LANGUAGES: PRACTICUM OR SEMINAR

Students in languages may complete the Humanities and Arts Requirement in one of the following three ways:

1. *Practicum in the sixth and final course in a language*. The practicum will include evaluative components or exams to demonstrate overall language skills in four areas: listening, speaking, reading, and writing. The practicum will require students to demonstrate breadth of cultural knowledge of the language area. (Examples of practicum courses: CN 2544, CN 3544, GN 3512, GN 3515; SP 3522; SP 3527)
2. *Advanced language seminar after five previous courses in the language*. The seminar will explore a thematic topic and provide opportunities for individual inquiry. (Seminar examples: GN 3513, GN 3514; SP 3523, SP 3524, SP 3525, SP 3526, SP 3528, SP 3529, SP 3530, SP 3531)

24 HUMANITIES AND ARTS REQUIREMENT

3. *Advanced language seminar after advanced-level language courses combined with courses from other areas of study.*
Students who demonstrate basic oral, written, and cultural knowledge of a language in a placement test at the advanced level may combine courses from other areas for their requirement. (Seminar examples are the same as option 2.) International students who are non-native speakers may take a combination of ISE and WR courses and fulfill the HUA requirement by taking a 3000-level or above ISE/WR project-based course.

Option 1 and 2 require students to take six courses in a language. For example, in option 1, a student without prior language training might begin with GN 1511 Elementary German I and conclude with a practicum in GN 3512 Advanced German II. In option 2, for example, a student might start with SP 2521 Intermediate Spanish I followed by five Spanish courses which culminate in one of the designated seminars. In option 3, students who demonstrate knowledge of the language at the advanced level may mix courses from other areas in their course sequence. For example, a student might take two courses from history, philosophy, music, etc. along with four advanced Spanish courses which would culminate in a designated seminar. Students in the English language track might begin with three ISE courses, take one WR course, one from history, and conclude with a 3000-level ISE/WR course. Students in all three options for languages would be required to submit the same materials to demonstrate completion of the requirement as students whose culminating experience was an inquiry seminar or practicum in another area of the Humanities and Arts.

HUA FACULTY ARRANGED BY DISCIPLINARY GROUP

Art/Art History (AR)

Roshanak Bigonah (AR)
Jennifer deWinter (AR)
Adryen Gonzalez (AR)
Edward Gutierrez(AR)
Marie Keller (AR)
Jo Ellen Reinhardt (AR)
Joshua Rosenstock (AR)
M. David Samson (AR)

Music (MU)

Scott Barton (MU)
Fred Bianchi (MU)
V.J. Manzo (MU)
Douglas Olsen (MU)
Joshua Rohde (MU)
Douglas Weeks (MU)
Brent Wetters (MU)

Drama/Theatre (TH)

Patrick Crowe (TH)
Despoina Giapoudzi (TH)
Kathryn Moncrief (TH)

Languages (AB, CN, GN, SP)

Joe Aguilar (SP)
Mohamed Brahim (AB)
Esther Boucher-Yip (ISE))
Ulrike Brisson (GN)
Althea Danielski (ISE)

Daniel DiMassa (GN)
Wen-Hua Du (CN)
Mohammed El Hamzaoui (AB, ISE)
Margarita Halpine (SP)
Aarti Madan (SP)
Ingrid Matos-Nin (SP)
Angel Rivera (SP)
Huili Zeng (CN)

Literature/Writing (EN, ISE, WR)

Joe Aguilar (EN, WR)
Esther Boucher-Yip (ISE, WR)
Kristin Boudreau (EN)
Joel Brattin (EN)
Jim Cocola (EN)
Althea Danielski (ISE, WR)
Jennifer deWinter (WR)
Mohammed El Hamzaoui (ISE, WR)
Michelle Ephraim (EN)
Brenton Faber (WR)
Joshua Harmon (EN, WR)
Lorraine Higgins (WR)
Shana Lessing (WR)
Kevin Lewis (WR)
Ryan Madan (WR)
Katherine McIntyre (EN, WR)
Svetlana Nikitina (EN, HU)
Lance Schachterle (EN)
Yunus Telli (WR)

History/International and Global Studies (HI, HU, INTL)

Bland Addison (HI, INTL)
Steven Bullock (HI)
Constance Clark (HI)
Joseph Cullon (HI)
Lindsay Davis (HI)
Holger Droessler (HI, INTL)
John Galante (HI, INTL)
James Hanlan (HI)
Peter Hansen (HI, INTL)
Shana Lessing (HI, INTL)
Jennifer Rudolph (HI, INTL)
William San Martin (HI, INTL)
David Spanagel (HI)

Philosophy/Religion (PY, RE)

Bethel Eddy (PY, RE)
Roger Gottlieb (PY, RE)
Jennifer McWeeny (PY)
Rebecca Moody (PY, RE)
Geoff Pfeifer (PY, RE)
John Sanbonmatsu (PY)

AP CREDIT POLICY

The Humanities and Arts Department will accept a maximum of 1/3 unit of AP credit towards the Humanities and Arts requirement. Students who score a 4 or 5 on the AP test in German or Spanish automatically receive 1/3 unit of credit in the language, provided they do not begin German or Spanish study at WPI with Elementary German I (GN 1511) or Elementary Spanish II (SP 1523). Students who score a 4 or 5 on the AP test in studio art may be eligible for HUA credit,

subject to a portfolio review by art faculty. Students who score a 4 or 5 on the AP test in other subject areas of the humanities and arts will receive credit in the relevant discipline. AP credit beyond one course (1/3 unit) in the Humanities and Arts may be counted toward other requirements such as free elective credit or particular majors and minors at WPI.

TRANSFER STUDENTS AND THE HUMANITIES AND ARTS REQUIREMENT

Students who transfer fewer than six Humanities and Arts courses from another institution must complete an inquiry seminar or practicum to complete the Humanities and Arts Requirement. Students who transfer six or more courses in Humanities and Arts will have the option of submitting a CDR form or engaging in additional work (or documentation of work) to earn an "A" on the CDR, in accordance with current transfer rules (see below).

All students may have the option of completing their Humanities and Arts Requirement while enrolled for 1 unit of coursework at an off-campus project center where one-third unit of the coursework shall include an inquiry seminar or practicum.

Transfer credit in the Humanities and Arts at WPI is granted on a course-for-course basis. All Transfer students entering WPI with *fewer than six courses or their equivalent of transfer credit in the Humanities and Arts* must complete work in the Humanities and Arts, including an Inquiry Seminar/Practicum to the extent that the overall Humanities and Arts credit totals two units.

No credit toward the Humanities and Arts Requirement is given for introductory-level foreign-language courses unless the entire program is in that foreign language. Usually only one transfer course in Freshman English can be applied toward the requirement. In all cases, the professor for the Inquiry Seminar/Practicum has the final decision on what courses are acceptable within the student's sequence leading up to the project. Up to one unit (i.e. three courses) of transferred work in the Humanities and Arts that is not credited toward the Humanities and Arts Requirement can be credited toward the fifteen-unit graduation requirement; such courses shall receive credit under the category of EL 1000.

If a Transfer student *has completed two units of acceptable college-level work in the Humanities and Arts prior to entering WPI*, a Completion of Degree Requirement form will be submitted by the Humanities and Arts Department Coordinator for Transfer Students at the request of the student. The grade for such a Humanities and Arts Requirement met by transfer credit is normally a grade of "CR". Students whose grades on transferred courses average A can engage in additional work or submit samples of their previous work and may be awarded an A for the Humanities and Arts Requirement. Alternately a transfer student may elect to undertake an Inquiry Seminar/Practicum in an effort to achieve an A grade. These evaluation options must be exercised prior to the Department's submission of the Completion of Degree Requirement form to the Registrar.

Decisions concerning credit toward the Humanities and Arts Requirement are made by the Humanities and Arts Coordinator for Transfer Students, Professor James Hanlan. He can be contacted in room 28 of Salisbury Laboratories, or at extension 5438, or email jphanlan@wpi.edu.

GUIDELINES FOR GRANTING TRANSFER CREDIT TO U.S. STUDENTS FOR FOREIGN LANGUAGE STUDY

A. Credit for study on the high school level:

1. Transfer credit of 1/3 unit is given for Advanced Placement with a score of 4 or 5.
2. Students with three or more years of foreign-language study in high school, but who have not taken the Advanced Placement examination in that language, may receive 1/3 unit credit for their high school language study upon satisfactory completion of two courses in the same language on the intermediate level or above. (Note: Courses in Chinese, German and Spanish in addition to those offered at WPI, as well as courses in other languages, are available at other colleges in the Consortium.)
3. In either case 1. or 2. above, in order to receive 1/3 unit credit, students must begin their WPI course sequence at the Elementary II level or above.

B. Credit for study at other colleges and universities:

1. Language study which is done at other universities and colleges prior to entering WPI, or done with the prior written permission of the student's Humanities and Arts Consultant (not the Department Head) as part of an agreed-upon Humanities and Arts sequence, transfers on a course-for-course basis.
2. Language study which is done at foreign universities, language institutes, cultural institutes, etc., prior to entering WPI, or done with the prior written permission of the student's Humanities and Arts Consultant (not the Department Head) as part of an agreed-upon Humanities and Arts sequence, is assessed by the Foreign Languages Consultant on the basis of matriculation papers and the level of work accomplished.

OTHER OPTIONS

INTERDISCIPLINARY STUDY AT THE AMERICAN ANTIQUARIAN SOCIETY

A unique opportunity for interdisciplinary work in the humanities and arts is offered by the American Studies Seminar sponsored each fall by the American Antiquarian Society. Organized in collaboration with Worcester's five undergraduate colleges and universities, this seminar focuses on topics that allow students to investigate the Society's rich holdings in early American history, literature, and culture. The Society's unparalleled collection of documents is a short walk from the campus. Information on application deadlines and academic credit toward the Humanities and Arts Requirement is available from the WPI Campus Representative to the American Antiquarian Society.

OFF-CAMPUS HUMANITIES AND ARTS OPTION

WPI offers the option to complete the Humanities and Arts Requirement during one term of study at several Project Centers. Normally, students complete the requirement through at least six courses or independent-study projects on campus. However, the "Off-Campus" option allows students to combine at least three courses on campus with one term studying the humanities and arts at a Project Center. Since this one-term

project is equivalent to three courses, students may use it to complete the requirement.

Off-campus projects are available in Germany for the study of foreign languages and in London and Morocco for other fields. These off-campus programs have a flexible format. Students devote themselves to one term studying the history, literature, language or culture at the project site with a WPI faculty advisor. The program might combine a thematic seminar in an area of the faculty advisor's expertise with visits to museums, the theatre, musical performances, or cultural excursions.

Although themes or areas of emphasis vary from year to year, all off-campus Humanities and Arts activities culminate in a written report in an area of interest to the student.

To be eligible for this one-unit activity, students must have already completed three courses in humanities and arts before they leave campus. Students may apply to the off-campus program before they have taken all three courses. However, students may not participate in the program unless they successfully complete one unit of work in humanities and arts before the term of the project. In addition, students going to any Project Center must complete all of the forms required by the Interdisciplinary and Global Studies Division.

Requirements:

- Students must have completed at least three courses in the Humanities and Arts at WPI, or have earned equivalent course credit approved by the Humanities and Arts Department, before the term of the off-campus activity. The Department may allow students to count transfer or advanced placement credits toward the three course minimum;
- Students must be accepted into the off-campus Humanities and Arts program by the Humanities and Arts Department, and complete all forms required by the Interdisciplinary and Global Studies Division, in order to register for these projects.
- Students might be required by the faculty advisor to complete a PQP or attend required meetings before the off-campus project;
- Students must submit a written report or paper at the end of the project. Students also may be required to submit written updates at various times in the course of the project. In all cases, the faculty advisor at the project site will determine the precise form of the written requirements.
- Students may be required to give an oral presentation at the end of the project;
- Under normal circumstances, students must complete the project within one term in order to receive the full unit of credit;
- Only members of the Humanities and Arts faculty at WPI may advise off-campus Humanities and Arts projects.

OFF-CAMPUS RECOMMENDATIONS

All off-campus programs benefit from advance planning. Discuss the possibility of an off-campus activity with your academic advisor at the beginning of the freshman year. Consult with the WPI faculty who will advise these off-campus projects as early as possible, since they may be able to suggest useful courses or other background resources for the projects. Also keep in mind that three courses are the minimum required, but many students find it advantageous to take additional courses before going away.

The interdisciplinary London and Morocco programs are open to students with a background in areas of the humanities and arts besides foreign languages, including art history and architecture, drama/theatre, history, literature, music, philosophy, religion, or writing/rhetoric. After taking at least three courses in any of these areas on campus, you could then go to London to complete your project. Some students also have gone to London with this program to study beyond the Humanities and Arts Requirement for international and global studies, history, literature, music, theatre, or other areas.

WPI offers programs in the German language at Darmstadt. This program requires completion of foreign language courses through the level of intermediate II or above (2000-level or above) before going abroad. For students who have taken foreign language courses in high school, language placement exams are available during New Student Orientation. Some students with basic foreign language preparation have completed their arts projects in Germany. We welcome a creative approach to off-campus study.

More advanced students may participate in these off-campus programs by doing work toward a minor or major. A student who had already completed their Humanities and Arts Requirement on campus, for example, might be able to work in the humanities and arts on an Independent Study Project that could count toward a minor. Or a student at one of these sites could work on a Major Qualifying Project in fields such as Humanities and Arts, International and Global Studies, or Professional Writing.

The Humanities and Arts Department advertises upcoming project locations and application deadlines at the Global Opportunities Fair each September. Future project opportunities might include other foreign locations or projects that provide the context for an intensive study of humanistic themes associated with particular locales within the United States. Contact the Department of Humanities and Arts for more information.

Social science deals with the behavior of individuals and groups as well as the functioning of the economic and political systems and institutions that shape and control our lives. As such, it offers a perspective that is essential for anyone desiring a well-rounded education.

Therefore, WPI, in common with other universities, requires some exposure to the social sciences for its graduates. In satisfying the two-course social science requirement, students are free to take courses in any of the traditional social sciences: economics, political science, sociology, and psychology. Courses with the following prefixes may be counted toward the social science requirement: ECON, ENV, GOV, PSY, SD, SOC, SS, STS. The social science courses offered at WPI are grouped into two broad categories. The first consists of core courses that introduce students to the social sciences and help them understand the scope and limits of social science approaches and how they might be related to the design of Interactive Qualifying

Projects. The second, more advanced, set of courses looks in depth at particular issues and problems, providing students with a more detailed understanding of social science disciplines and their use in social problem solving and interactive projects.

To obtain maximum benefit from their study of social science, students should choose courses that will provide knowledge and skills relevant to their Interactive Qualifying Project. These courses should be taken prior to or concurrent with undertaking the IQP and should be selected, if possible, after the student has identified the general topic area in which his or her interactive project work will be carried out.

More information on the alternatives available and the factors that should be considered in choosing courses to satisfy the social science requirement are available on the Social Science and Policy Studies department website at <https://www.wpi.edu/academics/study/programs/social-science-policy-studies/resources>.

DEPARTMENT AND PROGRAM DESCRIPTIONS

Department and Program Descriptions	29
Aerospace Engineering	29
Minor in Aerospace Engineering	32
Air Force Aerospace Studies	32
Architectural Engineering	33
Minor in Architectural Engineering (AREN)	34
Bioinformatics and Computational Biology	36
Minor in Bioinformatics and Computational Biology (BCB)	37
Biology and Biotechnology	37
Minor in Biology	38
Biomedical Engineering	39
Business, Robert A. Foisie School of	44
Business (BU)	44
Management Engineering (MGE)	47
Management Information Systems (MIS)	47
Industrial Engineering	48
Minor in Business	50
Minor in Entrepreneurship	50
Minor in Industrial Engineering	50
Minor in Management Information Systems	51
Minor in Social Entrepreneurship	51
Chemical Engineering	52
Chemistry and Biochemistry	54
Minor in Biochemistry	56
Minor in Chemistry	56
Civil and Environmental Engineering	57
Computer Science	60
Minor in Computer Science	63
Data Science	65
Minor in Data Science	66
Electrical and Computer Engineering	70
Minor in Electrical and Computer Engineering	73
Engineering Science Courses	73
Environmental Engineering	74
Fire Protection Engineering	76
Humanities and Arts	76
Professional Writing	79
Humanities and Arts Minors	80
American Studies	80

Chinese Studies	81
Drama/Theatre	82
English	82
Language (German or Spanish)	82
History	83
Media Arts	83
Music	83
Philosophy and Religion	84
Writing and Rhetoric	84
Interactive Media & Game Development	84
Interactive Media & Game Development (Bachelor of Arts)	85
Interactive Media & Game Development Technology (Bachelor of Science)	86
Minor in Interactive Media & Game Development	87
Interdisciplinary and Global Studies	87
Interdisciplinary Minors	88
Minor in Global Public Health	88
Minor in Nanoscience	89
Minor in Sustainability Engineering	89
International Development, Environment, and Sustainability (IDEaS) (Bachelor of Arts Degree)	90
Major in Environmental and Sustainability Studies	91
Minor in Environmental and Sustainability Studies	91
Minor in Science and Engineering for Development (DEV)	92
International and Global Studies	92
Minor in International and Global Studies	92
Liberal Arts and Engineering (Bachelor of Arts Degree)	95
Mathematical Sciences	97
Minor in Statistics	101
Minor in Mathematics	102
Mechanical Engineering	102
Minor in Mechanical Engineering	106
Minor in Manufacturing Engineering	106
Materials Engineering	107
Minor in Materials	107
Military Science	108
Physical Education, Recreation, and Athletics	109
Physics	110
Minor in Physics	113
Minor in Astrophysics	114
Pre-Professional Programs	114
Five-Year Dual Bachelor/M.S. in Management (MSMG)	114
Pre-Health Programs	115
Pre-Law Programs	115
Teacher Preparation Program	115
Robotics Engineering	116
Minor in Robotics Engineering	117
Social Science and Policy Studies	117
Economic Science Program	118
Psychological Science Program	119
Society, Technology, and Policy Program	120
Minor in Law and Technology	121
Minors in Social Science	121

SECTION 2

AEROSPACE ENGINEERING

N.A. GATSONIS, DIRECTOR

PROFESSORS: M. Demetriou, N. A. Gatsonis

ASSOCIATE PROFESSORS: J. Blandino, R. Cowlagi, D. Olinger, M. Richman

ASSISTANT PROFESSORS: J. Jayachandran, N. Karanjaakar

ASSISTANT TEACHING PROFESSOR: Z. Taillefer

MISSION STATEMENT

The Aerospace Engineering Program seeks to impart to our students strong technical competence in fundamental engineering principles along with specialized competence in aeronautical and astronautical engineering topics. The Program also seeks to foster a student's creative talents with the goal of developing a personal high standard of excellence and professionalism. Finally, the Aerospace Engineering Program seeks to provide to our students an appreciation of the role of the aerospace engineer in society.

PROGRAM EDUCATIONAL OBJECTIVES

The graduates of the Aerospace Engineering Program:

1. Will be successful professionals in aerospace and related engineering areas employed by industry or government.
2. Will be recipients of graduate degrees in aerospace and related engineering areas or in other professional areas.
3. Will become leaders in industry or government due to their mastery of technical concepts, broad preparation in the effective uses of technology, communication, and teamwork, and due to their appreciation of the importance of professional responsibilities and impact of technology on society.

STUDENT OUTCOMES

Graduating students should demonstrate that they attain the following:

1. an ability to identify, formulate, and solve complex engineering problems by applying principles of engineering, science, and mathematics.
2. an ability to apply engineering design to produce solutions that meet specified needs with consideration of public health, safety, and welfare, as well as global, cultural, social, environmental, and economic factor.
3. an ability to communicate effectively with a range of audiences.
4. an ability to recognize ethical and professional responsibilities in engineering situations and make informed judgments, which must consider the impact of engineering solutions in global, economic, environmental, and societal contexts.
5. an ability to function effectively on a team whose members together provide leadership, create a collaborative and inclusive environment, establish goals, plan tasks, and meet objectives.
6. an ability to develop and conduct appropriate experimentation, analyze and interpret data, and use engineering judgment to draw conclusions.
7. an ability to acquire and apply new knowledge as needed, using appropriate learning strategies.

8. knowledge covering one area emphasized – aeronautical engineering or astronautical engineering – and, in addition, knowledge of some topics from the area not emphasized.
9. major engineering design competence that incorporates appropriate engineering standards and multiple constraints, is based on the knowledge and skills acquired in earlier course work, and includes integration of aeronautical or astronautical topics

Program Distribution Requirements for the Aerospace Engineering Major

The normal period of residency at WPI is 16 terms. In addition to the WPI requirements applicable to all students (see WPI Degree Requirements) students wishing to receive a Bachelor degree in "Aerospace Engineering", must satisfy additional distribution requirements. These requirements apply to 10 units of study in the areas of mathematics, basic sciences, aerospace engineering science and design.

REQUIREMENTS	MINIMUM UNITS
1. Mathematics and Basic Sciences (Notes 1,2,3,4)	10/3
2. Engineering Topics (Notes 5,7)	16/3
3. Major Engineering Design Experience (including MQP) (Note 6)	4/3

NOTES:

1. Must include a minimum of 6/3 units of mathematics (prefix MA) with topics in: differential, integral, vector, multivariable calculus, differential equations, and linear algebra.
2. Must include a minimum of 2/3 units in physics (prefix PH) with topics in: mechanics, electricity and magnetism.
3. Must include 1/3 units in space environments (fulfilled by PH/AE 2550 Atmospheric and Space Environments as a Math and Basic Science course or other equivalent course with approval of the AE Program Undergraduate Committee)
4. Must include 1/3 unit in chemistry (prefix CH).
5. Must include 16/3 units of Engineering Topics, distributed as follows:
 - a. 14/3 units of Aeronautical Engineering
 - i. 2/3 units of Aerodynamics, with topics in: compressible fluid dynamics, subsonic and supersonic aerodynamics.
 - ii. 2/3 units of Aerospace Materials, with topics in: introductory materials science, and advanced materials.
 - iii. 3/3 units of Structures, with topics in: stress analysis, aerospace structures, and structural dynamics.
 - iv. 3/3 units of Propulsion, with topics in: thermodynamics, incompressible fluid dynamics, and air breathing propulsion.
 - v. 3/3 units of Flight Mechanics, and Stability and Control, with topics in: dynamics, control theory, and aircraft dynamics and control.
 - vi. 1/3 units of Experimentation.
 - b. 2/3 units in Astronautical Engineering
 - i. 1/3 units of Orbital Mechanics (fulfilled by AE 2713 Astronautics).
 - ii. 1/3 units of Telecommunications (fulfilled by AE 4733 Guidance, Navigation and Communication).
6. Must include 4/3 Units of Major Engineering Design Experience devising an aerospace system, component, or process to meet desired needs that incorporates appropriate engineering standards and multiple constraints, is based on the knowledge and skills acquired in earlier course work, and includes integration of aeronautical or astronautical topics (fulfilled by 1/3 Unit in AE 4770 Aircraft Design and 3/3 Units in MQP).

AEROSPACE ENGINEERING PROGRAM CHART

Course Recommendation

12/3 UNITS OF GENERAL EDUCATION ACTIVITIES			
HUA 6/3 Units	See WPI Requirements and Note 1	Interactive Qualifying Project 3/3 Units	See WPI Requirements
Social Science 2/3 Units	See WPI Requirements and Note 1	Physical Education 1/3 Unit	See WPI Requirements

3/3 UNITS OF FREE ELECTIVE
See WPI Requirements and Note 1

Note 1: First year Great Problems Seminar (GPS) courses can only be used to fulfill the HUA, SSPS, or the Free Elective requirement

10/3 UNITS OF MATHEMATICS AND BASIC SCIENCE (Note 2)			
Mathematics 6/3 Units	4/3 Units in Calculus (MA 1021, MA 1022, MA 1023, MA 1024) 1/3 Units in Differential Equations (MA 2051) 1/3 Units in Linear Algebra (MA 2071)	Physics 2/3 Units	1/3 Units in Mechanics (PH 1110 or PH 1111 or PH 2201) 1/3 Units Electricity & Magnetism (PH 1120 or PH 1121)
(Chemistry) 1/3 Unit	CH 1010 Chemistry I or CH 1020 Chemistry II	Space Environments 1/3 Unit	PH/AE 2550 Atmospheric and Space Environments

20/3 UNITS OF ENGINEERING TOPICS (Note 2)	
14/3 Units of AERONAUTICAL ENGINEERING	
Aerodynamics 2/3 Units	AE 3410 Compressible Fluid Dynamics AE 3711 Aerodynamics
Aerospace Materials 2/3 Units	ES 2001 Intro to Materials Science AE 4717 Fundamentals of Composite Materials
Structures 3/3 Units	AE 2712 Intro to Aerospace Structures AE 3712 Aerospace Structures AE 4712 Structural Dynamics
Propulsion 3/3 Units	ES 3001 Intro to Thermodynamics AE 3602 Incompressible Fluids AE 4711 Fundamentals of Air Breathing Propulsion
Flight Mechanics, and Stability and Control 3/3 Units	ES 2503 Intro to Dynamic Systems AE 3713 Intro to Aerospace Control Systems AE 4723 Aircraft Dynamics & Control
Experimentation 1/3 Unit	ME 3901 or ME 3902 Engineering Experimentation
2/3 Units of ASTRONAUTICAL ENGINEERING	
Orbital Mechanics 1/3 Unit	AE 2713 Astronautics
Telecommunications 1/3 Unit	AE 4733 Guidance, Navigation and Communications
4/3 UNITS OF MAJOR ENGINEERING DESIGN EXPERIENCE	
1/3 Unit	AE 4770 Aircraft Design
3/3 Units	Major Qualifying Project in Aerospace Engineering

or

20/3 UNITS OF ENGINEERING TOPICS (Note 2)	
14/3 Units of ASTRONAUTICAL ENGINEERING	
Orbital Mechanics 2/3 Unit	ES 2503 Intro to Dynamic Systems AE 2713 Astronautics
Attitude Determination and Control 2/3 Units	AE 3713 Intro to Aerospace Control Systems AE 4713 Spacecraft Dynamics & Control
Telecommunications 1/3 Unit	AE 4733 Guidance, Navigation and Communications
Space Structures 4/3 Units	ES 2001 Intro to Materials Science AE 2712 Intro to Aerospace Structures AE 3712 Aerospace Structures AE 4712 Structural Dynamics
Rocket Propulsion 4/3 Units	ES 3001 Intro to Thermodynamics AE 3602 Incompressible Fluids AE 3410 Compressible Fluid Dynamics AE 4719 Rocket Propulsion
Experimentation 1/3 Unit	ME 3901 or ME 3902 Engineering Experimentation
2/3 Units of AERONAUTICAL ENGINEERING	
Aerodynamics 1/3 Unit	AE 3711 Aerodynamics
Flight Mechanics, and Stability and Control 1/3 Unit	AE 4723 Aircraft Dynamics and Control
4/3 UNITS OF MAJOR ENGINEERING DESIGN EXPERIENCE	
1/3 Unit	AE 4771 Spacecraft and Mission Design
3/3 Units	Major Qualifying Project in Aerospace Engineering

Note 2: The courses in the above chart can be replaced by other equivalent courses, with the approval of the AE Program.

AEROSPACE ENGINEERING MAJOR COURSE FLOW CHART

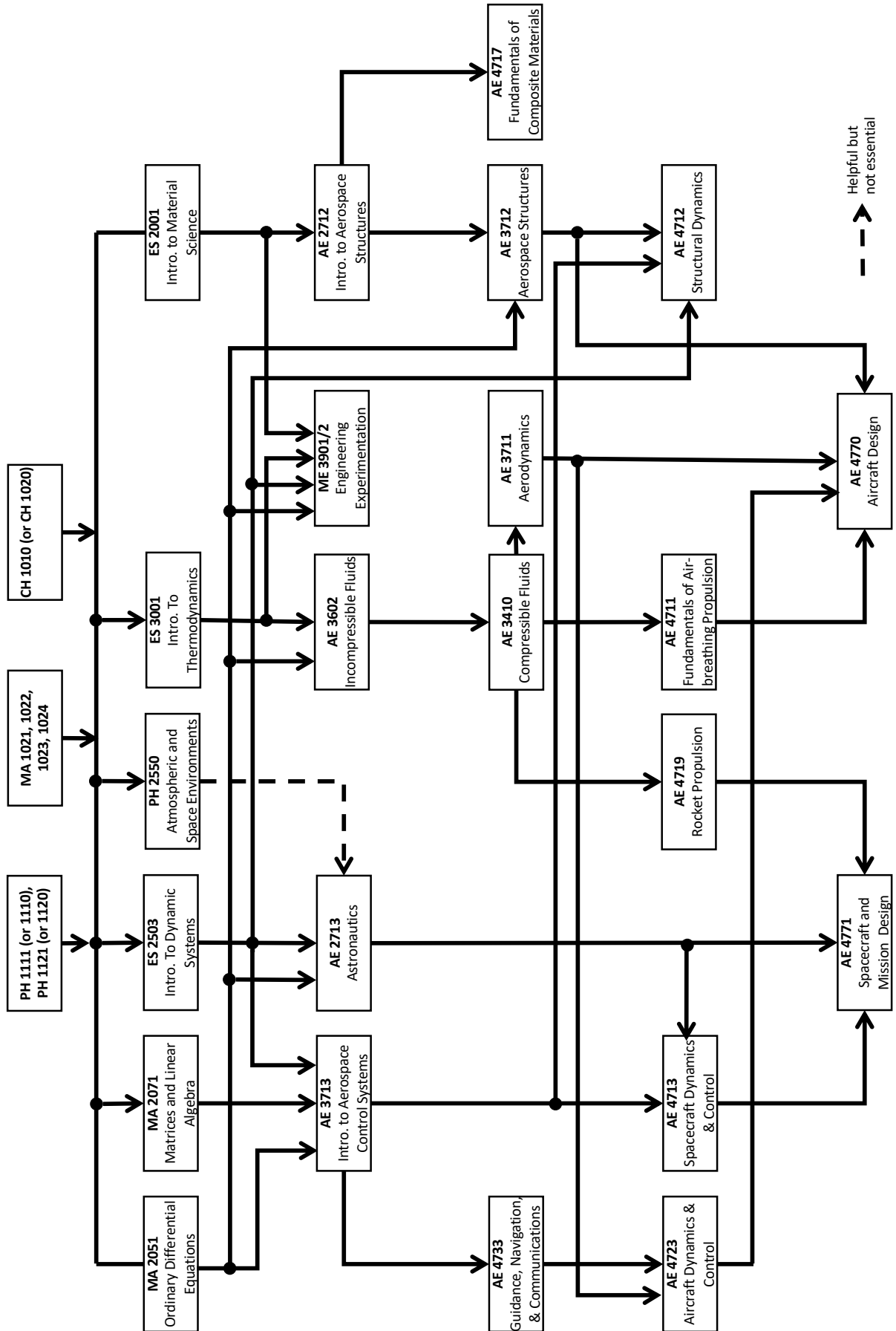

or

5. Must include 16/3 units of Engineering Topics, distributed as follows:
- 14/3 units of Astronautical Engineering
 - 2/3 units of Orbital Mechanics, with topics in: dynamics and space flight mechanics.
 - 2/3 units of Attitude Determination and Control, with topics in: control theory, and spacecraft dynamics and controls.
 - 1/3 units of Telecommunications, with topics in: guidance, navigation and communication.
 - 4/3 units of Space Structures, with topics in: introductory material science, stress analysis, aerospace structures, and structural dynamics.
 - 4/3 units of Rocket Propulsion, with topics in: thermodynamics, incompressible fluid dynamics, compressible fluid dynamics, and rocket propulsion.
 - 1/3 units of Experimentation.
 - 2/3 units in Aeronautical Engineering
 - 1/3 units of Aerodynamics (fulfilled by AE 3711 Aerodynamics).
 - 1/3 units of Flight Mechanics, and Stability and Control (fulfilled by AE 4723 Aircraft Dynamics and Control).
6. Must include 4/3 units of Major Engineering Design experience devising an aerospace system, component, or process to meet desired needs that incorporates appropriate engineering standards and multiple constraints, is based on the knowledge and skills acquired in earlier course work, and includes integration of aeronautical or astronautical topics (fulfilled by 1/3 Unit in 4771 Spacecraft and Mission Design and 3/3 Units in the MQP).
7. Great Problem Seminar (GPS) courses can only be used to fulfill the HUA, SSPS or the Free Elective requirement.

MAJOR QUALIFYING PROJECTS

The Aerospace Engineering Program provides opportunities, resources and organization for Major Qualifying Projects (MQPs). The MQPs involve the design of an aerospace system, component, or process to meet desired needs that incorporates appropriate engineering standards and multiple constraints, is based on the knowledge and skills acquired in earlier course work, and include the integration of aeronautical and/or astronautical engineering topics. MQPs are conducted in a dedicated lab or in one of the research laboratories of the Aerospace Engineering Program and serve as a vehicle for integration of undergraduate studies with current research activities. Some MQPs are also conducted in collaboration with industry or government research centers. All students present their MQP in a conference held at WPI on Project Presentation Day. Students are also encouraged and often supported to participate in student and professional conferences, as well as national design competitions. (<https://www.wpi.edu/academics/departments/aerospace-engineering>)

MINOR IN AEROSPACE ENGINEERING

For students who are not AE majors and are interested in broadening their exposure to, and understanding of, aerospace engineering, the Aerospace Engineering Program offers a Minor in Aerospace Engineering.

Successful candidates for the Minor in AE must meet the following requirements:

- Complete two units of work from courses with the prefix "AE" as outlined in the table below.
- Of the work in (1), at least 2/3 unit must be in 4000-level "AE" courses.

2 Units in AEROSPACE ENGINEERING

Aerodynamics and Propulsion	AE 2713	Astronautics
	AE 3410	Compressible Fluid Dynamics
	AE 3711	Aerodynamics
	AE 4711	Fundamentals of Air-Breathing Propulsion
	AE 4719	Rocket Propulsion
Aerospace Materials and Structures	AE 3712	Aerospace Structures
	AE 4712	Structural Dynamics
	AE 4717	Fundamentals of Composite Materials
Aerospace vehicle Dynamics, Stability and Control	AE 4723	Aircraft Dynamics and Control
	AE 4713	Spacecraft Dynamics and Control
	AE 4733	Guidance, Navigation and Communications
Major Aerospace Design Experience	AE 4770	Aircraft Design
	AE 4771	Spacecraft and Mission Design

Students seeking a Minor in AE should complete the Application for the Minor in AE and submit it to the AE Program Office as early in the program of study as possible. The Application for Minor in AE is available in the AE Program Office and the AE website. The AE Program Undergraduate Committee Chair will be responsible for review and approval of all Minor in AE requests. WPI policy requires that no more than one unit of course work be double counted toward other degree requirements.

THE COMBINED BACHELOR'S/MASTERS PROGRAM

Students are encouraged to consider the BS/MS program in Aerospace Engineering. Details are found in the WPI graduate catalog.

AIR FORCE AEROSPACE STUDIES

LT COL J. SKILES III, DEPARTMENT HEAD

PROFESSOR: Lt Col J. Skiles III

ASSISTANT PROFESSOR: Capt. N. Evans

MISSION

The mission of AFROTC is to develop leaders of character for tomorrow's Air Force, whose mission is to fly, fight, and win in air, space, and cyberspace. Successful graduates of the program receive a commission as a Second Lieutenant in the United States Air Force.

EDUCATIONAL OBJECTIVES:

Students who successfully complete the AFROTC program will develop:

- An understanding of the fundamental concepts and principles of Air and Space.
- A basic understanding of associated professional knowledge.
- A strong sense of personal integrity, honor, and individual responsibility.
- An appreciation of the requirements for national security.

AIR FORCE ROTC PROGRAMS

There are two traditional routes to an Air Force commission through Air Force ROTC. Entering students may enroll in the Air Force Four-Year Program. Students with at least three academic years remaining in college may apply for the Accelerated Program.

FOUR- OR FIVE-YEAR PROGRAM

The preferred program is the traditional Four-Year Program. To enroll, simply register for Air Force Aerospace Studies in the fall term of the freshman year in the same manner as other college courses. There is NO MILITARY OBLIGATION for the first two years of Air Force ROTC unless you have an Air Force ROTC scholarship.

The first two years are known as the General Military Course (GMC). Classes meet one hour per week and are required for freshmen and sophomores.

Individuals who successfully complete the GMC compete nationwide for entry into the Professional Officers Course (POC). POC classes meet three hours per week and are required for all juniors and seniors. Officer Candidates enrolled in the POC and on scholarship receive a nontaxable subsistence allowance of up to \$500 each month.

Qualified Officer candidates will attend the Air Force ROTC field-training program for four weeks, usually between their sophomore and junior years.

ACCELERATED PROGRAM

For students who do not enroll in Air Force ROTC during their first year in college, it is possible to condense the two years of GMC membership into a single year, as long as the student has three more years of college left.

OTHER ASPECTS OF THE AFROTC PROGRAM

Leadership Laboratory:

Air Force ROTC officer candidates participate in a Leadership Laboratory (LLAB) where the leadership skills and management theories acquired in the classroom are put into practice. The LLAB meets once each week for approximately two hours.

This formal military training is largely planned and directed by the officer candidates. The freshmen and sophomores are involved in such initial leadership experiences as problem solving, dynamic leadership, team building, Air Force customs and courtesies, drill movements, Air Force educational benefits, Air Force career opportunities, and preparation for field training. The juniors and seniors are involved in more advanced leadership experiences as they become responsible for the planning and organizing of wing activities, including conducting the Leadership Laboratory itself.

Field Training:

The summer program is designed to develop military leadership, discipline, and evaluate performance. At the same time, the Air Force can evaluate each student's potential as an officer. Field training includes: expeditionary operations, Air Force professional development, marksmanship training, physical fitness, and survival training.

Base Visits:

Air Force ROTC officer candidates may have the opportunity to visit Air Force bases for firsthand observation of the operating Air Force.

Additional Information:

In addition to formal activities, the cadet wing plans and organizes a full schedule of social events throughout the academic year. These include a Dining-In, Military Ball, a Field Day, and intramural sports activities. Professional Development Training Programs, such as Advanced Cyber Education, internships with the National Reconnaissance Office, combative training, and global cultural language and immersion training may also be available to selected volunteer officer candidates during the summer. Students may also participate in Arnold Air Society, Drill Team, and Civil Air Patrol, among other activities.

ARCHITECTURAL ENGINEERING

DIRECTOR: S. VAN DESSEL (AREN)

ASSOCIATED FACULTY: L. Albano (CEE), T. El-Korchi (CEE), M. Farzinmoghdam (AREN), S. Liu (AREN)

MISSION STATEMENT

Architectural Engineering is a discipline that focuses on the planning, design, construction and operation of buildings and, particularly, on their parts that support the functioning of the inner space and the undertaking of human activities, including environmental protection, comfort, well-being, sustainability and security. One of the major focuses of the architectural engineering program at WPI is the use of energy in buildings, and this is addressed through courses and projects that incorporate engineering science and design fundamentals that relate to those building parts, e.g., envelope, heating and air conditioning, plumbing and electrical systems, which impact the consumption of energy and natural resources. The program seeks to impart to students strong technical competence in fundamental engineering principles as they are applied to a sustainable built environment. The program, in addition, seeks to foster a student's creative undertaking and his/her development of high standards of professionalism. The project approach at WPI offers students a unique opportunity to explore the humanistic, technological, societal, economic, legal, and environmental issues surrounding architectural engineering problems. The architectural engineering degree prepares students for careers in the private and public sectors, architectural and engineering consulting, real estate and construction firms, and advanced graduate studies.

PROGRAM EDUCATIONAL OBJECTIVES

The objective of the undergraduate program in Architectural Engineering is to prepare graduates for successful careers in the Architectural Engineering profession. A few years after graduation WPI Architectural Engineering graduates are expected to have the ability to:

1. Attain registration as Professional Engineers,
2. Earn a graduate degree in Architectural Engineering or a related discipline,
3. Enhance their skills through continued education,
4. Serve their profession through engagement with professional societies,
5. Demonstrate commitment to sustainable design principles within their professional work

STUDENT OUTCOMES

The Student Outcomes for the Bachelor degree in Architectural Engineering are that all graduates will attain:

1. an ability to identify, formulate, and solve complex engineering problems by applying principles of engineering, science, and mathematics
2. an ability to apply engineering design to produce solutions that meet specified needs with consideration of public health, safety, and welfare, as well as global, cultural, social, environmental, and economic factors
3. an ability to communicate effectively with a range of audiences
4. an ability to recognize ethical and professional responsibilities in engineering situations and make informed judgments, which must consider the impact of engineering solutions in global, economic, environmental, and societal contexts
5. an ability to function effectively on a team whose members together provide leadership, create a collaborative and inclusive environment, establish goals, plan tasks, and meet objectives
6. an ability to develop and conduct appropriate experimentation, analyze and interpret data, and use engineering judgment to draw conclusions
7. an ability to acquire and apply new knowledge as needed, using appropriate learning strategies
8. the design level in one of the four architectural engineering areas, the application level in a second area, and the comprehension level in the remaining two areas.

Program Distribution Requirements for the Architectural Engineering Major

The program is designed according to the ABET criteria for Architectural Engineering accreditation. The four basic architectural engineering curriculum areas are building structures, building mechanical systems, building electrical systems and construction/construction management. The normal period of residency at WPI is 16 terms. In addition to WPI requirements applicable to all students (see WPI Degree requirements), students wishing to receive a Bachelor degree in "Architectural Engineering" must satisfy the following distribution requirements:

REQUIREMENTS	MINIMUM UNITS
1. Mathematics, Basic Science, and Supplemental Science (Note 1)	4
2. Architectural Engineering Science and Design (Notes 2, 3, 4)	7

NOTES:

1. Must include a minimum of 10/3 units of a combination of Mathematics and Basic Sciences. Mathematics must include differential and integral calculus, differential equations, statistics, and matrices and linear algebra. Science must include 2/3 unit in calculus-based physics (PH 1110 or PH 1111 and PH 1120 or PH 1121), 1/3 unit in chemistry, 1/3 unit in thermodynamics (can be fulfilled by PH 2101 or other approved equivalent course such as ES 3001), and 1/3 unit in fluid mechanics (can be fulfilled by ES 3004).
2. Must include 7 units of Architectural Engineering Science and Design in the different areas of architectural engineering, distributed as follows or with approved equivalents:

- a) 2/3 units of architectural engineering complements, including introduction to architectural engineering (AREN 2023) and topics related to the history and theory of architecture (AR 2114).
 - b) 2/3 units in construction/construction management including project evaluation (CE 3025) or Engineering Economics (OIE 2850), and either legal aspects of professional practice (CE 3022) or project management (CE 3020).
 - c) 5/3 units in building mechanical systems including Building Physics (AREN 3024), Principles of HVAC design for buildings (AREN 3003), Advanced HVAC system design (AREN 3006), and two integrated architectural design studios: Architectural Design IV - Building energy simulation (AREN 3020), and Architectural Design V - Building Envelope Design (AREN 3022).
 - d) 2/3 units in building electrical systems with topics in building electrical systems (AREN 2025) and Architectural Design II - Light and Lighting Systems (AREN 2004)
 - e) 5/3 units in building structural systems including Analytical Mechanics I and 2 (CE 2000 and CE 2001), Introduction to Analysis and Design (CE 2002), and two design level structural engineering courses (such as CE 3006, CE 3008, CE 3010, or CE 3044)
 - f) 2/3 Units in general architectural design including Architectural Design I (AREN 2002), and Architectural Design III (AREN 3002).
 - g) Must include the Capstone Design activity (1 Unit) through the MQP that achieves design proficiency in either the structural or mechanical area.
3. Must include 1/3 unit in Experimentation (fulfilled by AREN 3003, AREN 3020, ME 3901, CE 3026 or approved equivalent).
4. Great Problem Seminar (GPS) courses can only be used to fulfill the HUA, SSPS, or the Free Elective requirements.

For more information please consult the website for this major at <https://www.wpi.edu/academics/departments/architectural-engineering>.

MINOR IN ARCHITECTURAL ENGINEERING (AREN)

For students who are not AREN majors and are interested in broadening their exposure to and understanding of architectural engineering, the Architectural Engineering Program offers a Minor in Architectural Engineering.

Successful candidates for the Minor in AREN must complete two units of work from courses with the pre fix "AREN" as outlined in the table below.

2 Units in Architectural Engineering

Must include:

AREN 2002	Architectural Design I
AREN 2023	Introduction to Architectural Engineering Systems
AREN 3003	Principles of HVAC Design for Buildings

Elective courses (select three)

AREN 2025	Building Electrical Systems
AREN 2004	Architectural Design II – Light and lighting systems
AREN 3002	Architectural Design III
AREN 3006	Advanced HVAC System Design
AREN 3024	Building Physics
AREN 3020	Architectural Design IV – Building Energy Simulation
AREN 3022	Architectural Design V – Building Envelope Design

ARCHITECTURAL ENGINEERING PROGRAM CHART (NOTE 1, 2)

This chart summarizes course recommendations (Note 3)

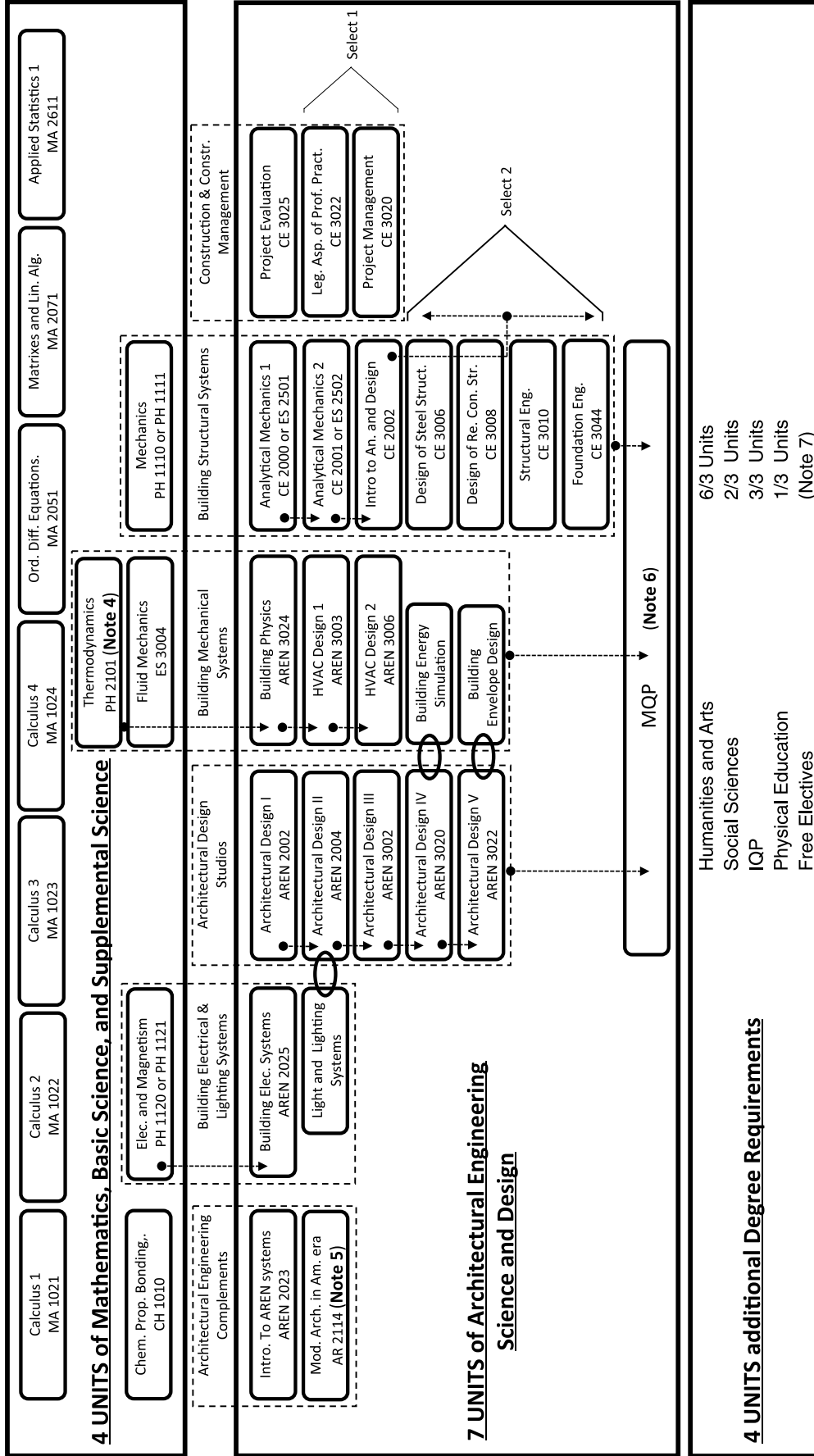

- Note 1:** The courses in this Architectural Engineering Program chart can be replaced by approved equivalents.
- Note 2:** Must include 1/3 unit in Experimentation (fulfilled by AREN 3003, AREN 3025, or approved equivalent).
- Note 3:** Arrows indicate recommended order of topics.
- Note 4:** Can be fulfilled by PH 2101 or other approved equivalent course such as ES 3001.
- Note 5:** This course can also help fulfill the Humanities and Arts requirement.
- Note 6:** Must include the Capstone Design activity that achieves design proficiency in either the structural or mechanical area.
- Note 7:** The minimum academic credit required for the Bachelor degree is 15 units. Credit accumulated beyond the published distribution requirements shall be accomplished by the addition of "free elective" work.

Students seeking a Minor in AREN should complete the Application for the Minor in AREN and submit it to the Director of AREN Program as early in the program of study as possible. The Application for Minor in AREN is available in the Civil and Environmental Engineering Office. The Director of the AREN Program will be responsible for the review and approval of all Minor in AREN requests. WPI policy requires that no more than one unit of course work be double counted toward other degree requirements.

BIOINFORMATICS AND COMPUTATIONAL BIOLOGY

DIRECTOR: D. KORKIN (CS)

ASSOCIATE DIRECTOR: E. RYDER (BB)

PROGRAM COMMITTEE: L. Harrison (CS), X. Kong (CS), A. Manning (BB), S. Olsen (MA), R. Paffenroth (MA), R. Rao (BB), C. Ruiz (CS), B. Servatius (MA), S. Shell (BB), L. Vidali (BB), Z. Wu (MA)

AFFILIATED FACULTY: E. Agu (CS), A. Arnold (MA), J. Duffy (BB), M. Y. Eltabakh (CS), K. Lee (BME), W.J. Martin (MA), A. Mattson (CBC), E.A. Rundensteiner (CS), E. Solovey (CS), J. Srinivasan (BB), D. Tang (MA), S. Walcott (MA), M. Wu (MA), A. Yousefi (CS), J. Zou (MA)

MISSION STATEMENT

With the advent of large amounts of biological data stemming from research efforts such as the Human Genome Project, there is a great need for professionals who can work at the interface of biology, computer science, and mathematics to address important problems involving complex biological systems. Graduates of this interdisciplinary program will be well versed in all three disciplines, typically specializing in one of them. Many opportunities for interdisciplinary research projects are available, both on the WPI campus, and through relationships with faculty at the University of Massachusetts Medical School. Graduates will be well-prepared for graduate study or for professional careers in industry.

PROGRAM OUTCOMES

Students graduating with a Bachelor of Science degree in Bioinformatics and Computational Biology:

- Have mastered foundational studies in biology, mathematics, and computer science
- Have mastered advanced principles and techniques in at least one of the three disciplines
- Can apply computational and mathematical knowledge to the solution of biological problems
- Can communicate effectively across disciplines both verbally and in writing
- Can locate, read, and interpret primary literature in bioinformatics and computational biology
- Can formulate hypotheses or models, design experiments to test these hypotheses, and interpret experimental data
- Can function effectively as members of an interdisciplinary team
- Adhere to accepted standards of ethical and professional behavior
- Will be life-long independent learners

Program Distribution Requirements for the Bioinformatics and Computational Biology Major

The distribution requirements for the BS degree in Bioinformatics consists of core courses in Biology, Chemistry, Mathematics, and Computer Science, several interdisciplinary courses, and a set of advanced courses primarily focused on one of three disciplines: Computer Science, Biology/Biochemistry, or Mathematics.

REQUIREMENTS	MINIMUM UNITS
1. Mathematics (Note 1)	5/3
2. Computer Science (Note 2)	4/3
3. Biology (Note 3)	5/3
4. Chemistry (Note 4)	4/3
5. Bioinformatics and Computational Biology (Note 5)	3/3
6. Social Implications (Note 6)	1/3
7. Advanced disciplinary courses (Note 7)	6/3
8. MQP	3/3

NOTES:

1. Mathematics must include 3/3 unit of differential and integral calculus and statistics. The additional 2/3 unit must be chosen from linear algebra, statistics, probability, calculus, and differential equations.
2. Computer Science must include 2/3 unit of introductory programming and 2/3 unit of discrete math and algorithms.
3. Biology must include cell biology, genetics, molecular biology, and 1/3 unit BB 2000-level laboratory.
4. Chemistry must include 2/3 unit of general chemistry and 2/3 unit of organic chemistry.
5. Chosen from BCB interdisciplinary courses.
6. Chosen from CS 3043 or PY 2713.
7. Chosen from advanced courses in MA, CS, BB, or CH listed below. At least one unit must be within one area (MA, CS, or BB/CH). At least one unit must be at the 4000 level (may be in different areas).

Advanced courses in MA:

MA 2431	Mathematical Modeling with Ordinary Differential Equations
MA 2621	Probability for Applications
MA 2631	Probability
MA 3627	Introduction to the Design and Analysis of Experiments
MA 3631	Mathematical Statistics
MA 4214	Survival Models
MA 4473	Partial Differential Equations
MA 4631	Probability and Mathematical Statistics I
MA 4632	Probability and Mathematical Statistics II

Advanced courses in CS:

CS 3733	Software Engineering
CS 3431	Database Systems I
CS 4120	Analysis of Algorithms
CS 4341	Introduction to Artificial Intelligence
CS 4432	Database Systems II
CS 4445	Data Mining and Knowledge Discovery in Databases

Advanced courses in BB/CH:

Any BB 3000/4000 level course or CH 4000 level Biochemistry course. Particularly relevant BB/CH courses:	
BB 3140	Evolution: Pattern and Process
BB/CH 4190	Regulation of Gene Expression
CH 4110	Protein Structure and Function
CH 4120	Lipids and Biomembrane Functions
CH 4130	Nucleic Acids and Bioinformation

MINOR IN BIOINFORMATICS AND COMPUTATIONAL BIOLOGY (BCB)

Students pursuing the Bioinformatics and Computational Biology minor need to acquire some familiarity with the three fields that form the basis of this interdisciplinary area: biology, mathematics, and computer science. They should also take at least one interdisciplinary course that uses quantitative methods to pose and answer biological problems. Students should be careful to choose their mathematics, computer science, and biology courses to prepare themselves for whichever capstone BCB course they plan to take.

REQUIREMENTS

- 5/3 units in BB, MA, CS, and BCB, chosen from the course lists below, with at least 1/3 unit in each of BB, CS, and MA, and no more than 2/3 unit from any of these three areas. No more than 1 course at the 1000 level may be included from any one department.
- 1/3 unit capstone: any BCB 4000 level class.

MA courses

- MA 2610 Statistics for the Life Sciences or
MA 2611 Applied Statistics I
- MA 2612 Applied Statistics II
- MA 2621 Probability for Applications
- MA 2051 Ordinary Differential Equations
- MA 2631 Probability
- Any course from the Advanced courses in MA list for the BCB major

CS courses

- CS 1004 Intro to Programming for Non-Majors
- CS 1101 Intro to Programming or CS 1102 Accelerated intro to Programming
- CS 2102 Object Oriented Design or
CS 2103 Accelerated Object Oriented Design
- CS 2223 Algorithms
- Any course from the Advanced courses in CS list for the BCB major

BB courses

- BB 1035 Biotechnology
- BB 1045 Biodiversity
- BB 1025 Human Biology
- BB 2920 Genetics
- BB 2950 Molecular Biology
- BB 2550 Cell Biology
- BB 2002 Microbiology
- BB 2040 Ecology
- Any course from the Advanced courses in BB/CH list for the BCB major

BCB Interdisciplinary courses

- BCB 3010 Simulation in Biology
- BCB 4001 Bioinformatics
- BCB 4002 Biovisualization
- BCB 4003 Biological and Biomedical Database Mining
- BCB 4004 Statistical Methods in Genetics and Bioinformatics

BIOLOGY AND BIOTECHNOLOGY

J. DUFFY, HEAD; J. RULFS, ASSOCIATE HEAD

PROFESSORS: D. S. Adams, J. King, K. Oates, R. Rao, P. J. Weathers

ASSOCIATE PROFESSORS: T. Dominko, J. Duffy, L. Mathews, J. Rulfs, E. Ryder, J. Srinivasan, L. Vidali

ASSOCIATE TEACHING PROFESSORS: M. Buckholt, L. Roberts, J. Whitefleet-Smith

ASSISTANT PROFESSORS: N. Farny, A. Manning, I. Nechipurenko, S. Shell

PROFESSOR OF PRACTICE: F. Brownell

ASSISTANT RESEARCH PROFESSOR: B. Nephew

AFFILIATE FACULTY: M. Bakermans

EMERITUS PROFESSORS: R. Cheetham, T. C. Crusberg

MISSION STATEMENT

The Department of Biology and Biotechnology will make scholarly scientific and technological advances that will address the changing needs of society. We will prepare well educated scientists able to approach problems with creativity and flexibility. A key element in this preparation is active participation in the process of scientific inquiry.

EDUCATIONAL PROGRAM

Our educational program is founded in five unifying concepts.

- All living things evolve through processes such as genetic drift and natural selection that act on heritable genetic variation.
- Biological systems obey the principles of chemistry and physics.
- Simple biological units can assemble into more complex systems with emergent properties.
- Biological systems function by the actions of complex regulatory systems.
- Scientific knowledge follows a process of observation and hypothesis testing.

An integrated and functional understanding of these concepts provides the foundation for biotechnology, *the technological application of biological systems, living organisms or derivatives thereof, to make or modify products or processes for specific use.* (United Nations Convention on Biological Diversity)

In the Biology & Biotechnology curriculum, these concepts are exemplified and integrated across three major divisions of biology:

- Cellular and molecular biology
- Biology of the organism
- Organisms in their environment

PROGRAM LEARNING OUTCOMES

The program's learning outcomes are designed to support life-long learning in the discipline. Toward that end, graduates of WPI with a Bachelor of Science degree in Biology & Biotechnology

- will know and understand the five unifying themes and can provide and explain examples of each from each of the three divisions of biology.

- can demonstrate mastery of a range of quantitative and procedural skills applicable to research and practice in biology & biotechnology.
- are able to generate hypotheses, design approaches to test them, and interpret data to reach valid conclusions.
- can find, read and critically evaluate the scientific literature.
- can describe the broader scientific or societal context of their work or that of others.
- demonstrate oral and written communication skills relevant to the discipline.
- can function effectively in a collaborative scientific environment.
- understand and can adhere to accepted standards of intellectual honesty in formulating, conducting and presenting their work.

Program Distribution Requirements for the Biology and Biotechnology Major

REQUIREMENTS	MINIMUM UNITS
1. Mathematical Sciences, Physics, Computer Science, Engineering (Note 1)	5/3
2. Chemistry	5/3
3. Biology & Biotechnology (Note 2)	10/3
4. Laboratory experience (Note 3)	4/3
5. Related courses (Note 4)	3/3
6. MQP	1

NOTES:

1. BB 3010 and BB 4801 may count toward this requirement.
2. Biology and Biotechnology coursework must include 2/3 units at the 1000 level, 4/3 units at the 2000 level, and 4/3 units at the 3000/4000 level, of which at least 1/3 unit must be a BB 4900 course. BB 1000, BB 1001, BB 1002 and BB/BCB 1003 may not count toward the major requirement. At least 2/3 unit of Biology and Biotechnology coursework must be taken from each of three major divisions of biology (below). The 2/3 unit for each division may include courses from any level (1000-4000).
3. • Chosen from among the BB 2000 and 3000 level labs and the Experimental Biochemistry labs, CH 4150.
• Must include at least 1/2 unit of work at the 2000 level.
4. Chosen from the Related Courses List which includes additional BB 3000/4000 level courses.

THE THREE MAJOR DIVISIONS OF BIOLOGY

1. Cellular and Molecular

BB 1035	Biotechnology
BB 2003	Fundamentals of Microbiology
BB 2550	Cell Biology
BB 2920	Genetics
BB 2950	Molecular Biology
BB 3003	Medical Microbiology
BB 3050	Cancer Biology
BB/CH 4190	Regulation of Gene Expression
BB 4260	Synthetic Biology

2. Biology of the organism

BB 1025	Human Biology
BB 3101	Anatomy and Physiology I
BB 3102	Anatomy and Physiology II
BB 3080	Neurobiology
BB 3120	Plant Physiology
BB 3620	Developmental Biology
BB 3920	Immunology

3. Organisms in their environment

BB 1045	Biodiversity
BB 2030	Plant Diversity
BB 2040	Principles of Ecology
BB 2050	Animal Behavior
BB 3140	Evolution: Pattern and Process

RELATED COURSES

BCB 4002	Biovisualization
BCB 4003	Biological and Biomedical Database Mining
BCB 4004	Statistical Methods in Genetics and Bioinformatics
CE 3059	Environmental Engineering
CH 2330	Organic Chemistry III
CH 3510	Chemical Thermodynamics
CH 4110	Protein Structure and Function
CH 4120	Lipids and Biomembrane Functions
CH 4130	Nucleic Acids and Bioinformation
CH 4140	Metabolism and Disease
CH 4160	Membrane Biophysics
CHE 3301	Introduction to Biological Engineering
Any BB 3000 or 4000 level course	

UNDERGRADUATE RESEARCH PROJECTS

The biology and biotechnology facilities offer an exceptional learning opportunity since research in an active laboratory group is the principal teaching tool. Tools for modern biochemistry, molecular biology, tissue culture, fermentation, ecology, microscopy and computer integration are all available to undergraduates.

In conjunction with the faculty, students who wish to expand their educational opportunities pursue many off-campus projects each year. Investigations may take place at institutions that have traditionally worked with WPI, such as the University of Massachusetts Medical School and Tufts Cummings School of Veterinary Medicine. The department also has established links with several companies that provide opportunities for project work and summer employment in applied biology and biotechnology.

Undergraduate research projects may be proposed by individual students or groups of students, or may be selected from on-going research activities of the faculty. The departmental faculty must be consulted for approval of a project before student work begins.

MINOR IN BIOLOGY

Rather than trying to cover the entire field of biology, the minor in biology has been designed to allow the student to survey a few areas of biology (e.g. ecology and genetics) or to select a specific area of focus (e.g. cell biology) for the minor. In either case, students will complete three courses at the 1000 and 2000 level to provide broad foundational knowledge, two laboratory modules, and two 3000/4000 level courses for advanced study, including a 4000 level course of the student's choosing. Students should choose their foundational courses carefully so that they provide recommended background for upper level courses they plan to take. As with all minors, 1 unit of this work may be double counted toward meeting another degree requirement, while a minimum of 1 unit of the work must be unique to the minor. The specific requirements for the minor are as follows:

REQUIREMENTS	UNITS
1000-level BB course (note 1)	1/3
2000-level BB courses	2/3
BB laboratory courses (note 2)	1/3
3000/4000-level BB course	1/3
4000-level BB course	1/3

NOTE

1. BB 1000, BB 1001, BB 1002, BB/BCB 1003 cannot be used to fulfill this requirement.
2. At least one of the BB laboratory courses must be at the 2000-level.

BIOMEDICAL ENGINEERING

K. L. BILLIAR, HEAD; G. PINS, ASSOCIATE HEAD

PROFESSORS: K. Billiar, G. R. Gaudette, Y. Mendelson, G. D. Pins

ASSOCIATE PROFESSORS: D. Albrecht, S. Ji, M. W. Rolle, K. Troy

ASSISTANT PROFESSORS: J. M. Coburn, A. Lammert, K. Lee, C. F. Whittington, H. Zhang

ASSOCIATE TEACHING PROFESSOR: S. Ambady

ASSISTANT TEACHING PROFESSORS: T.A. Butler, A. Z. Reidinger

PROFESSOR OF PRACTICE: R. L. Page

ASSOCIATED FACULTY: H. Ault (ME), C. Brown (ME), N. Burnham (PH), T. Camesano (CHE), E. Clancy (ECE), T. Dominko (BBT), G. Fischer (ME), M. Fofana (ME), J. King (BBT), S. Liu (ME), F. Looft (ECE), R. Ludwig (ECE), C. Ozaki (BME), A. Peterson (CHE), M. Popovic (PH), S. Roberts (CHE), B. Savilonis (ME), S. Shivkumar (ME), W. Soboyejo (ME), J. Sullivan (ME), D. Tang (MA), E. Tuzel (PH), P. Weathers (BBT), Q. Wen (PH), E. Young (CHE)

EMERITUS PROFESSOR: R. A. Peura

MISSION STATEMENT

The Biomedical Engineering Department prepares students for rewarding careers in the health care industry or professional programs in biomedical research or medicine.

EDUCATIONAL OBJECTIVES

The educational objectives of the Biomedical Engineering Program, which embrace the WPI educational philosophy, are that our alumni 1) have successful careers, 2) apply sound science and engineering principles to impact the field of biomedical sciences in a socially and ethically responsible manner and, 3) will meet the changing needs of the profession through lifelong learning.

STUDENT OUTCOMES

The Biomedical Engineering Program has established the following student outcomes in support of the educational objectives of our department. The general and specific program criteria meet the requirements for Biomedical Engineering accreditation by ABET (The Accreditation Board for Engineering and Technology). Accordingly, students graduating from the Biomedical Engineering Program will demonstrate:

1. An ability to identify, formulate, and solve complex engineering problems at the interface of engineering and biology by applying principles of engineering, science, and mathematics
2. An ability to apply engineering design to produce solutions that meet specified needs with consideration of public health, safety, and welfare, as well as global, cultural, social, environmental, and economic factors
3. An ability to communicate effectively with a range of audiences
4. An ability to recognize ethical and professional responsibilities in engineering situations and make informed judgments, which must consider the impact of engineering solutions in global, economic, environmental, and societal contexts
5. An ability to function effectively on a team whose members together provide leadership, create a collaborative and inclusive environment, establish goals, plan tasks, and meet objectives
6. An ability to develop and conduct appropriate experimentation, analyze and interpret data from living and non-living systems, and use engineering judgment to draw conclusions
7. An ability to acquire and apply new knowledge as needed, using appropriate learning strategies
8. An understanding of biology and physiology
9. An ability to address the problems associated with the interaction between living and non-living materials and systems.

Biomedical engineering is the application of engineering principles to the solution of problems in biology and medicine for the enhancement of health care. Students choose this field in order:

- to be of service to people;
- to work with living systems; and
- to apply advanced technology to solve complex problems of medicine.

Biomedical engineers may be called upon to design instruments and devices, to integrate knowledge from many sources in order to develop new procedures, or to pursue research in order to acquire knowledge needed to solve problems. The major culminates in a Major Qualifying Project, which requires that each student apply his or her engineering background to a suitable biomedical problem, generally in association with the University of Massachusetts Medical School, Tufts University School of Veterinary Medicine, one of the local hospitals, or a medical device company.

Each student's program will be developed individually with an advisor to follow the Biomedical Engineering program chart. WPI requirements applicable to all students must also be met. See page 7.

Biomedical engineering is characterized by the following types of activity in the field:

1. Uncovering new knowledge in areas of biological science and medical practice by applying engineering methods;
2. Applying engineering principles to identify unmet needs in the medical and biological fields and implement high impact innovative solutions;
3. Designing and developing patient-related instrumentation, biosensors, prostheses, biocompatible materials, and diagnostic and therapeutic devices; and bioengineered tissues and organs;
4. Analyzing, designing, and implementing improved health-care delivery systems and apparatus in order to improve patient care and reduce health-care costs in contexts ranging from individual doctors' offices to advanced clinical diagnostic and therapeutic centers.

The modeling of biological systems is an example of applying engineering analytical techniques to better understand the dynamic function of biological systems. The body has a complex feedback control system with multiple subsystems that interact with each other. The application of modeling, computer simulation, and control theory provides insights into the function of these bodily processes.

Recently, there has been increased emphasis on the application of the biomedical engineering principles embodied in the third and fourth areas listed above. Examples of the third area include:

- designing and developing tissues and organs;
- development of implantable biomaterials;
- design of an implantable power source;
- design of transducers to monitor the heart's performance;
- development of electronic circuitry to control the system;
- bench and field testing of devices in animals;
- application of new technology to rehabilitation engineering.

The fourth area involves closer contact with the patient and health-care delivery system. This area is commonly referred to as Clinical Engineering. The engineer in the clinical environment normally has responsibility for the medical instrumentation and equipment including:

- writing procurement specifications in consultation with medical and hospital staff;
- inspecting equipment for safe operation and conformance with specifications;
- training medical personnel in proper use of equipment;
- testing within hospital for electrical safety; and
- adaptation of instrumentation to specific applications.

Biomedical engineering projects are available in WPI's Goddard Hall and Higgins Laboratories, the Life Sciences and Bioengineering Center at Gateway Park as well as at the affiliated institutions previously listed.

Program Distribution Requirements for the Biomedical Engineering Major

The normal period of residency at WPI is 16 terms. In addition to the WPI requirements applicable to all students (see page 7), a biomedical engineer needs a solid background in mathematics, physical and life sciences. The distribution requirements are satisfied as follows:

BIOMEDICAL ENGINEERING	MINIMUM UNITS
1. Mathematics (See Note 1)	6/3
2. Basic Science (See Note 2)	6/3
3. Supplemental Science (See Note 3)	1/3
4. Computer Science (Note 4)	1/3
5. Biomedical Engineering and Engineering (See Note 5)	14/3
6. MQP (See Note 6)	3/3

NOTES:

1. Mathematics must include differential and integral calculus, differential equations and statistics.
2. 2/3 unit from each of the following areas: BB, CH and PH. At least 1/3 unit of BB coursework must be 2000+ level.
3. 1/3 additional unit from BB, CH, PH or FY courses that satisfy BB, CH, or PH.
4. 1/3 unit in basic computer programming (BME 1004, or equivalent).
5. 14/3 unit of engineering coursework as specified in the WPI Catalog "Courses Qualifying for Engineering Department Areas" with the following distribution:
 - A. 3/3 unit of 2000+ level in engineering.
 - B. 2/3 unit of 3000+ level in engineering.
 - C. 9/3 units in Biomedical Engineering which must include the following:
 - a. 1/3 unit biomechanics or biofluids at the 2000+ level
 - b. 1/3 unit biomaterials or tissue engineering at the 2000+ level
 - c. 1/3 unit biosensors or bioinstrumentation at the 2000+ level
 - d. 1/3 unit experimental measurement and data analysis at the 2000+ level
 - e. 2/3 unit of BME laboratories at the 3000+ level (four 1/6 unit labs)
 - f. 1/3 unit BME engineering with living systems laboratory (BME 3111 or equivalent)
 - g. 1/3 unit BME design (BME 3300 or equivalent)
 - h. 1/3 unit BME elective
 Notes:
 - i. 2/3 unit in BME must be at or above the 4000-level, of which 1/3 unit must be at the 4000-level.
 - ii. Only 1/3 unit may be ISU (syllabus and final report required)
 - iii. MQP credits cannot be used to satisfy the 14/3 engineering coursework)
6. Must include a minimum of 1/3 unit Capstone Design Experience.
 - A. Each Biomedical Engineering student must complete a Capstone Design experience requirement. The Capstone Design experience is partially or fully accomplished by completing the Major Qualifying Project which integrates the past course work and involves significant engineering design. At the time of registration for the MQP, the project advisor will determine whether the MQP will meet the full 1/3 unit Capstone Design requirement or not. If not, the advisor will identify an additional 1/6 unit of course work in the area of engineering design (BME 4300 or equivalent) to be taken in order to meet the ABET Capstone Design requirement.

These distribution requirements in *Biomedical Engineering* apply to all students matriculating at WPI AY2012 and after. Students who matriculated prior to AY2012 have the option of satisfying the degree requirements in the catalog current at the time of their matriculation.

BIOMEDICAL ENGINEERING PROGRAM CHART

13/3 UNITS

BASIC SCIENCE AND MATHEMATICS	
Mathematics (MA): 6/3 units, including differential equations and statistics	
Biology (BB): 2/3 units	Physics (PH): 2/3 units
Chemistry (CH): 2/3 units	Supplemental Science: 1/3 unit

1/3 UNIT

COMPUTER PROGRAMMING
1/3 unit Computer Programming/Logic

9/3 UNITS

BIOMEDICAL ENGINEERING	
For Breadth in BME 4/3 unit BME core <ul style="list-style-type: none"> • Biomechanics • Biomaterials • Bioinstrumentation • BME Measurement and Analysis 1/3 unit Design 1/3 unit BME elective	1/3 unit engineering with living systems laboratory[†] 2/3 units BME laboratories at ≥ 3000-level (4–1/6 unit labs) For Depth in BME Notes about 9/3 units: <ul style="list-style-type: none"> • 1000-level courses do not satisfy requirement • 1/3 unit at ≥ 4000-level • 1/3 unit at 4000-level

[†] BME 3111 or equivalent

5/3 UNITS

ENGINEERING
Engineering: 1 unit at ≥ 2000-level
Engineering: 2/3 units at ≥ 3000-level

2 UNITS

HUMANITIES
See undergraduate catalog

2/3 UNITS

SOCIAL SCIENCE
See undergraduate catalog

1 UNIT

IQP
See undergraduate catalog

1 UNIT

MQP
See undergraduate catalog Must include a minimum of 1/3 unit Capstone Design

2/3 UNITS

FREE ELECTIVES
See undergraduate catalog

1/3 UNIT

PHYSICAL EDUCATION
See undergraduate catalog

Course selections that meet the requirements for BME core knowledge

Biomechanics/ Biofluids	Biomaterials/Tissue Engineering	Bioinstrumentation/ Biosensors	Measurement and Data Analysis
BME 2511 BME 3610 ES 2501 ES 2502 ES 2503 ES 3004	BME 2811 ES 2001	BME 2210 ECE 2010	BME 2211 ME 3901

BIOMEDICAL ENGINEERING SPECIALIZATIONS

Because BME is such a broad and diverse discipline, it is convenient to subdivide it into a number of different specializations, or tracks. At the undergraduate level, these specializations help to bring focus to course and project planning. At the graduate-level, these specializations are aligned with the research interests of our faculty. Here at WPI, three specializations have been defined: 1) Biomechanics, 2) Biomedical Instrumentation, Biosignals and Image Processing, and 3) Biomaterials and Tissue Engineering. If students are interested in developing an undergraduate program of study in one of these specializations, they should consult the Program of Study in BME sections of the catalog, within their chosen areas of specialization. See the department web site for more details.

BIOMECHANICS

Biomechanics is a specialization within biomedical engineering that involves the application of engineering mechanics to the study of biological tissues and physiological systems. When most people first think of biomechanics, the way we move or the strength of bones generally comes to mind. However, many other aspects are included in this diverse field of study including:

- Dynamics – e.g., analysis of human movement including walking, running, and throwing.
- Statics – e.g., determination of the magnitude and nature of forces in joints, bones, muscles and implanted prostheses, and characterization of the mechanical properties of the tissues in our bodies.
- Stress Analysis – e.g. calculation of the stresses and deformations within biological tissues and prostheses, and characterization of the mechanical properties of tissues and biomaterials.
- Fluid mechanics and transport – e.g., analysis flow of blood through arteries and air through the lung and diffusion of oxygen in tissues.

Biomechanics research has improved our understanding of:

- Design and manufacturing of medical instruments, devices for disabled persons, artificial replacements, and implants.
- Human performance in the workplace and in athletic competition.
- Normal and pathological human and animal locomotion.
- The mechanical properties of hard and soft tissues.
- Neuromuscular control.
- The connection between blood flow and arteriosclerosis.
- Air flow and lung pathology.
- The effects of mechanical loads on cellular mechanics and physiology.
- Morphogenesis, growth, and healing.
- The mechanics of biomaterials.
- Engineering of living replacement tissue (tissue engineering).

BIOMEDICAL INSTRUMENTATION, BIOSIGNALS AND IMAGE PROCESSING

BIOINSTRUMENTATION

Modern health care relies heavily on a large array of sophisticated medical instrumentation and sensors to diagnose health problems, to monitor patient condition and administer therapeutic treatments, most often in a non-invasive or minimally-invasive manner. During the past decade, computers have become an essential part of modern bioinstrumentation, from the microprocessor in a single-purpose wearable instrument used to achieve a variety of small tasks to more sophisticated desk-top instruments needed to process the large amount of clinical information acquired from patients. The Biomedical Instrumentation track of our program is focused on training students to design, test, and use sensors and biomedical instrumentation to further enhance the quality of health care. Emphasis is placed both on understanding the physiological systems involved in the generation of the measured variable or affected by therapeutic equipment, as well as the engineering principles of biomedical sensors and biomedical devices.

Examples of common biomedical instrumentations used routinely in medicine include:

- Specialized instrumentation for genetic testing.
- Electrocardiography to measure the electrical activity of the heart.
- Electroencephalography to measure the electrical activities of the brain.
- Electromyography to measure the electrical activities of muscles.
- Mechanical respirators.
- Cardiac pacemakers.
- Defibrillators.
- An artificial heart.
- Heart-lung machines.
- Pulse oximeters.
- Drug infusion and insulin pumps.
- Electrosurgical equipment.
- Anesthesia equipment.
- Kidney dialysis machines.
- Artificial electronic prosthetics used by disabled people (e.g. hearing aids).
- Laser systems for minimally invasive surgery.

BIOSIGNALS

Biosignal processing involves the collection and analysis of data from patients or experiments to identify and extract distinct components of the data set that may lead to better understanding of the processes involved in physiological regulation. For example, identifying and quantifying differences in the dynamic characteristics of physiological function between normal and diseased conditions utilizing biosignal processing techniques

may lead to a better understanding of the role of regulatory imbalance in diseased conditions, and should have important clinical and diagnostic and prognostic application.

Examples of biosignal processing include:

- Detection of malignant heart rhythms from electrocardiograms.
- Early detection of sudden cardiac death.
- Monitoring of vital signs.
- Seizure detection using electroencephalogram recordings.
- Real-time control of artificial prosthetics.
- Real-time control of robotic movements.
- Early detection of hypertension and onset of diabetes.
- Wireless transmission of diagnostic devices.
- Modeling of pharmacokinetics and design of algorithms for robust drug delivery.
- Bioinformatics.
- Pattern recognition and decision support systems.
- Artificial intelligence.

IMAGE PROCESSING

Biomedical image processing involves the application of quantitative science and engineering to detect and visualize biological processes. An important area is the application of these tools to the study of diseases with an ultimate goal of aiding medical intervention. While x-ray imaging is an obvious and familiar example with tremendous diagnostic utility, it represents only a small aspect of this important field. Biomedical engineers are active participants in the development of new imaging modalities to acquire and process images from the body, most often in a non-invasive or minimally-invasive manner.

Examples of biomedical imaging and image processing include:

- X-ray imaging and computer-aided tomography (CAT).
- Visible light and optical imaging.
- Near-infrared imaging.
- Magnetic resonance imaging (MRI).
- Ultrasound imaging.
- Nuclear medicine imaging.
- Luminescence-based imaging.

BIOMATERIALS AND TISSUE ENGINEERING

BIOMATERIALS

Biomaterials is a specialization within biomedical engineering that integrates engineering fundamentals in materials science with principles of cell biology, chemistry and physiology to aid in the design and development of materials used in the production of medical devices. When most people first think of biomaterials, implants such as surgical sutures, artificial hips or pacemakers generally come to mind, but many other aspects are included in this diverse field of study:

- **Biomaterials Design** – Identify the physiological and engineering criteria that an implantable biomaterial must meet. Select the proper chemical composition to insure that the biomaterial imparts the desired mechanical properties and evokes the appropriate tissue response for the specified application.
- **Mechanics of Biomaterials** – Characterize the magnitude and nature of the mechanical properties of biomaterials. Predict and measure how the physical/structural properties of a biomaterial determine its mechanical properties.
- **Biomaterials-Tissue Interactions** – Examine the molecular, cellular and tissue responses to implanted medical devices. Design biomaterials with properties that induce the desired wound healing and tissue remodeling responses from the body.

Biomaterials research and development has improved our health care in many ways including:

- Design and manufacture of replacement parts for damaged or diseased tissues and organs (e.g., artificial hip joints, kidney dialysis machines)
- Improved wound healing (e.g., sutures, wound dressings)
- Enhanced performance of medical devices (e.g., contact lenses, pacemakers)
- Correct functional abnormalities (e.g., spinal rods)
- Correct cosmetic problems (e.g., reconstructive mammo-plasty, chin augmentation)
- Aid in clinical diagnostics (e.g., probes and catheters)
- Aid in clinical treatments (e.g., cardiac stents, drains and catheters)
- Design biodegradable scaffolds for tissue engineering (e.g., dermal analogs)

TISSUE ENGINEERING

Tissue engineering integrates the principles and methods of engineering with the fundamentals of life sciences towards the development of biological substitutes to restore, maintain or improve tissue/organ function. When most people first think of tissue engineering, artificial skin and cartilage generally comes to mind, but many other aspects are included in this diverse field of study:

- **Scaffold/Biomaterial Design** – Identify the physiological and engineering criteria that a biodegradable scaffold must meet. Select the proper biochemical composition to insure that the cells perform in a physiologic manner on the surface of the scaffold.
- **Functional/Biomechanical Tissue Engineering** – Characterize the roles of biomechanical and biochemical stimuli on the formation, growth, development and function of bioengineered cells, tissues and organs. Create accurate biomimetic engineered tissue models of human disease to aid in the discovery, invention and development of novel therapeutic strategies.
- **Bioreactor Design** – Design reactors that control the rates at which nutrients and growth factors are supplied to bioengineered tissues and organs during growth and development in a laboratory environment.

BUSINESS, ROBERT A. FOISIE SCHOOL OF

S. TAYLOR, DEAN AD INTERIM

D.M. STRONG, DEPARTMENT HEAD AD INTERIM

M.B. ELMES, PROGRAM DIRECTOR (MBA & MS IN MANAGEMENT PROGRAMS)

S. DJAMASBI, PROGRAM DIRECTOR (MS IN INNOVATION WITH USER EXPERIENCE)

A. HALL-PHILLIPS, PROGRAM DIRECTOR (UNDERGRADUATE PROGRAMS & MS IN MARKETING AND INNOVATION)

S. JOHNSON, PROGRAM DIRECTOR (INDUSTRIAL ENGINEERING AND MS IN OPERATIONS ANALYTICS & MANAGEMENT)

E. LOIACONO, PROGRAM DIRECTOR (MS IN INFORMATION TECHNOLOGY)

J. SARKIS, PROGRAM DIRECTOR (MS IN SUPPLY CHAIN MANAGEMENT)

J. ZHU, PROGRAM DIRECTOR (PHD PROGRAM)

PROFESSORS: S. Djamasbi, M.B. Elmes, H.N. Higgins, F. Hoy, S.A. Johnson, E. Loiacono, J. Sarkis, D.M. Strong, S. Taylor, J. Zhu

ASSOCIATE PROFESSORS: A. Hall-Phillips, R. Konrad, F. Miller, A. Trapp, B. Tulu

ASSISTANT PROFESSORS: K. Ching, N. Kordzadeh, E. Long Lingo, S. Saberi, P. Shah

PROFESSORS OF PRACTICE: R. Sarnie, S. Wulf

ASSOCIATE TEACHING PROFESSORS: J. Ryan, W. Towner, E.V. Wilson

MISSION

Inspiring leaders at the Nexus of

Science, Engineering, and Business with Project-based, purpose-driven learning and Innovative research to achieve impactful Results and to pursue Excellence that drives progress.

VISION

The leading business school focused on research and education at the intersections of STEM, business, and human behavior to solve global problems.

COURSE AREAS

The Robert A. Foisie School of Business covers all the functional areas of business. Courses with the following prefixes are found within the School:

ACC	Accounting
BUS	Business, including all foundation courses
ETR	Entrepreneurship
FIN	Finance
MIS	Management Information Systems
MKT	Marketing
OIE	Operations & Industrial Engineering
OBC	Organizational Behavior and Change

BUSINESS (BU)

EDUCATIONAL OBJECTIVES

Objectives of the Business Major are:

- To prepare students for management roles in technology-based organizations.
- Through a flexible curriculum, to provide a solid, broad base of business knowledge and the written communication, oral presentation, decision-making, and leadership skills necessary to succeed in a technology-based environment.
- To develop student abilities necessary for continued career growth including:
 - the ability to integrate theory and practice;
 - the ability to integrate technology and change into existing organizations;
 - the ability to think critically and analytically, to define and solve business problems, work in teams, and think globally; and
 - the ability to learn new skills in response to changing professional requirements.

Program Distribution Requirements for the Business Major

REQUIREMENTS (NOTE 1)	MINIMUM UNITS
1. Business Foundation (Note 2)	11/3
2. Mathematics (Note 3)	4/3
3. Basic Science	2/3
4. Business Major (Note 4)	6/3
5. Breadth Electives (Note 5)	3/3
6. Computer Science (Note 6)	1/3
7. BU MQP	3/3

NOTES:

- Courses may not be counted more than once in meeting these distribution requirements.
- The Business Foundation consists of BUS 1010: Leadership Practice; BUS 1020: Global Environment of Business Decisions; BUS 2020: The Legal Environment of Business Decisions; BUS 2060: Financial Statements for Decision Making; BUS 2070: Risk Analysis for Decision Making; BUS 2080: Data Analysis for Decision Making; BUS 3010: Creating Value through Innovation; BUS 3020: Achieving Effective Operations; BUS 4030: Achieving Strategic Effectiveness. Microeconomics and Macroeconomics are required and also fulfill the WPI Social Science requirement.
- Mathematics must include 2/3 units of calculus and 2/3 units of statistics.
- Students selecting the Business Major must complete six courses from one of the concentrations as specified in the summary table for concentrations on page 46. Students may also work with their academic advisor to create a custom BU Program. Such custom programs must be approved by the advisor and the Business School's Undergraduate Policy and Curriculum Committee.
- Breadth Electives must include at least 1/3 unit from among the 3000- and 4000-level courses in the School. The remaining 2/3 units specified in the requirement may be satisfied with courses from Mathematics, Basic Science, Computer Science, Social Science, or courses with any of the following prefixes: ACC, BUS, ETR, FIN, MIS, MKT, OBC, or OIE.
- A minimum of 1/3 unit of Computer Science focused on programming, CS 1004, CS 1101, or CS 1102 is recommended. (CS 2022 and CS 3043 are not accepted.)

**BUSINESS/MANAGEMENT ENGINEERING/MANAGEMENT INFORMATION SYSTEMS
OVERVIEW OF DEGREE REQUIREMENTS**

UNIVERSITY REQUIREMENTS
<p>HUMANITIES AND ARTS (6/3 Units): 6 courses including Inquiry Seminar/Practicum</p> <p>SOCIAL SCIENCE (2/3 Units): ECON 1110* & ECON 1120*</p> <p>PHYSICAL EDUCATION (1/3 Units)</p> <p>INTERACTIVE QUALIFYING PROJECT (3/3 Unit)-3rd Year</p>

MATHEMATICS AND SCIENCE REQUIREMENTS
<p>BASIC SCIENCE (2/3 Units) BB, CH, GE, PH</p> <p>MATHEMATICS (4/3 Units) Calculus - MA 1021; MA 1022; Statistics - MA 2611; MA 2612</p> <p>COMPUTER SCIENCE (1/3 Units): CS 1004 (recommended) or CS 1101 or CS 1102</p>

CORE BUSINESS CURRICULUM	
<p>BUSINESS FOUNDATIONS (5/3 Units)</p> <p>ECON 1110 Introductory Microeconomics* ECON 1120 Introductory Macroeconomics* BUS 1010 Leadership Practice BUS 1020 Global Environment of Decision Making BUS 2020 Legal Environment of Business Decisions</p>	<p>BUSINESS STRATEGY AND ANALYSIS (6/3 Units)</p> <p>BUS 2060 Financial Statements for Decision Making BUS 2070 Risk Analysis for Decision Making BUS 2080 Data Analysis for Decision Making BUS 3010 Creating Value Through Innovation BUS 3020 Achieving Effective Operations BUS 4030 Achieving Strategic Effectiveness</p>

DEGREE CONCENTRATION OPTIONS (6/3 Units) (Please see concentration courses listed on page 46.)		
B.S. in BUSINESS	B.S. in MANAGEMENT ENGINEERING	B.S. in MANAGEMENT INFORMATION SYSTEMS
<p>CONCENTRATIONS</p> <ul style="list-style-type: none"> • Business Analytics • Financial Technology (Fintech) • Innovation for Social Change • General Business 	<p>CONCENTRATIONS</p> <ul style="list-style-type: none"> • Biomedical Engineering • Chemistry • Civil Engineering • Electrical and Computer Engineering • Manufacturing Engineering • Mechanical Engineering • Operations Management • Custom 	<p>CONCENTRATIONS</p> <ul style="list-style-type: none"> • Management Information Systems
<p>MAJOR QUALIFYING PROJECT (3/3 Units) The MQP must have a focus and advisor in the concentration area from the Business School.</p>		
<p>BREADTH ELECTIVES (3/3 Units)</p>		
<p>Must include 1/3 unit from 3000- and 4000-level FBS courses; Remaining 2/3 units may be satisfied from MA, CS, SS, Basic Science, or with prefixes ACC, BUS, ETR, FIN, MIS, MKT, OBC, or OIE.</p>		
<p>FREE ELECTIVES (5/3 Units)</p>		

*ECON 1110 and ECON 1120 count toward Social Science requirements.

BUSINESS CONCENTRATION COURSES (6/3 Units)			
Business Analytics	Fintech	Innovation for Social Change	General Business
<ul style="list-style-type: none"> •Select one programming course: CS 2119, CS 2102, or CS 2103 •Select one: MIS 3720 or CS 3431 •Select one Math elective: MA 2071, MA 2621, MA 3231, MA 3627 •Select three business-domain, analytics electives, at least two at the 4000 level: MIS 4084, MIS 4720, MIS 4741, MKT 3650, OIE 3420, OIE 3460, OIE 3600, OIE 4420 	<ul style="list-style-type: none"> •Required: FIN 3300 •Select four: CS 2119 or CS 2102 or CS 2103, MIS 3720, MIS 3787, MIS 4720, MIS 4741 •One 2000-level or higher course from: CS (excluding CS 2022, CS 3043), ECON, FIN, MIS, OIE, and actuarial math courses (MA 2211, MA 2212, MA 2621) 	<ul style="list-style-type: none"> •Required: ETR 2900 •Select three: ETR 3633, ETR 3915, ETR 4930, OBC 4367 •Select two: EN 2251, ENV 2201, ENV 2310, ENV 2400, ENV 2600, GOV 2311, GOV 2312, GOV 2319, HI 2341, HI 2403, INTL 2100, PSY 1402, PY/RE 2731, PY/RE 2732, SD 1510, SOC 1202 	<p>Complete six courses from no more than three areas:</p> <ul style="list-style-type: none"> •Accounting & Finance: FIN 3300 •Economics: ECON 2110, ECON 2117, ECON 2120, ECON 2125, ECON 2130, ECON 2135, ECON 2145, ECON 2155, ECON/ETR 2910 •Entrepreneurship: ETR 2900, ETR/ECON 2910, ETR 3633, ETR 3915, ETR 4930 •Law: GOV 1310, GOV 2310, GOV 2311, GOV 2312, GOV 2313, GOV 2314 •Marketing: MKT 3640, MKT 3650 •Organizational Behavior: BUS 4300, OBC 3354, OBC 4367 •Psychology: PSY 1401, PSY 1402, PSY 1504, PSY 2406

MANAGEMENT ENGINEERING CONCENTRATION COURSES (6/3 Units)			
Biomedical Engineering	Chemistry	Civil Engineering	Electrical and Computer Engineering
<ul style="list-style-type: none"> •Select one course, but no more than two, from: ETR 2900, ETR 2910, ETR 3915, ETR 4930, MKT 3640, MKT 3650, OIE 3410, OIE 3420, OIE 3510, OIE 3600, OBC 3354, OBC 4367 •Select at least four courses, but no more than five, from: BME 1001, BME 2001, BME 2210, BME 2502, BME 3300, BB 3101, BB 3102 	<ul style="list-style-type: none"> •Select one course, but no more than two, from: ETR 2900, ETR 2910, ETR 3915, ETR 4930, MKT 3640, MKT 3650, OIE 3410, OIE 3420, OIE 3510, OIE 3600, OBC 3354, OBC 4367 •Select at least four courses, but no more than five, from: CH 1030, CH 1040, CH 2310, CH 2320, CH 2330, CH 2360, CH 2640, CH 3510 	<ul style="list-style-type: none"> •Select one course, but no more than two, from: ETR 2900, ETR 2910, ETR 3915, ETR 4930, MKT 3640, MKT 3650, OIE 3410, OIE 3420, OIE 3510, OIE 3600, OBC 3354, OBC 4367 •Select as least four courses, but no more than five, from: AREN 2023, CE 1030, CE2000, CE 2020, CE 3020, CE 3022, CE 3025, CE 3030, CE 3031, CE 3041, ES 3004 	<ul style="list-style-type: none"> •Select one course, but no more than two, from: ETR 2900, ETR 2910, ETR 3915, ETR 4930, MKT 3640, MKT 3650, OIE 3410, OIE 3420, OIE 3510, OIE 3600, OBC 3354, OBC 4367 •Select at least four courses, but no more than five, from: ECE 2010, ECE 2019, ECE 2029, ECE 2049, ECE 2112, ECE 2311, ECE 2312, ECE 2799

MANAGEMENT ENGINEERING CONCENTRATION COURSES (6/3 Units)		
Manufacturing Engineering	Mechanical Engineering	Operations Management
<ul style="list-style-type: none"> •Select one course, but no more than two, from: ETR 2900, ETR 2910, ETR 3915, ETR 4930, MKT 3640, MKT 3650, OIE 3410, OIE 3420, OIE 3510, OIE 3600, OBC 3354, OBC 4367 •Select at least four courses, but no more than five, from: ES 2001, ME 1800, ME 2820, ME 3320, ME 3820, ME 4718, ME 4810, ME 4813, ME 4814, ME 4815, ME 4821, ME 4875 	<ul style="list-style-type: none"> •Select one course, but no more than two, from: ETR 2900, ETR 2910, ETR 3915, ETR 4930, MKT 3640, MKT 3650, OIE 3410, OIE 3420, OIE 3510, OIE 3600, OBC 3354, OBC 4367 •Select at least four courses, but no more than five, from: ES 2001, ES 2501, ES 2502, ES 2503, ES 3001, ES 3003, ES 3004, ME 1800, ME 2300, ME 2820, ME 3820, ME 3901 or 3902, ME 4320, ME 4429, ME 4430 	<ul style="list-style-type: none"> •Complete the following four: OBC 3354, OIE 3410, OIE 3420, OIE 4460 •Select two from: CS 2119 or CS 2102/CS 2103, MIS 3720, MKT 3640, MKT 3650, OBC 4367, OIE 2081, OIE 3405, OIE 3460, OIE 3510, OIE 3600, OIE 4410, OIE 4420

MANAGEMENT INFORMATION SYSTEMS CONCENTRATION COURSES (6/3 Units)
Management Information Systems
<p>Complete the following three: MIS 3720, MIS 3787, MIS 4720</p> <p>Select one of the following: CS 2119, CS 2102 or CS 2103</p> <p>Select two from: CS 2102 or CS 2103, CS 2301 or CS 2303, CS 3041</p>

MANAGEMENT ENGINEERING (MGE)

EDUCATIONAL OBJECTIVES

Objectives of the Management Engineering Major are:

- To prepare students for management challenges in key areas that increasingly require proficiency in the technical aspects of business such as production and service operations.
- To provide the knowledge and skills necessary to succeed professionally, including literacy in a technical field, a broad understanding of management issues, written communication, oral presentation, decision-making, and leadership skills required to create new and improved products, processes and control systems.
- To develop student abilities necessary for continued career growth including:
 - the ability to integrate theory and practice and to apply knowledge of technical issues with the foundations of management;
 - the ability to integrate technology and change into existing organizations;
 - the ability to think critically and analytically, to define and solve business problems, work in teams, and think globally; and
 - the ability to learn new skills in response to changing professional requirements.

Program Distribution Requirements for the Management Engineering Major

REQUIREMENTS (NOTE 1)	MINIMUM UNITS
1. Business Foundation (Note 2)	11/3
2. Mathematics (Note 3)	4/3
3. Basic Science	2/3
4. Management Engineering Major (Note 4)	6/3
5. Breadth Electives (Note 5)	3/3
6. Computer Science (Note 6)	1/3
7. MGE MQP	3/3

NOTES:

1. Courses may not be counted more than once in meeting these distribution requirements.
2. The Business Foundation consists of BUS 1010: Leadership Practice; BUS 1020: Global Environment of Business Decisions; BUS 2020: The Legal Environment of Business Decisions; BUS 2060: Financial Statements for Decision Making; BUS 2070: Risk Analysis for Decision Making; BUS 2080: Data Analysis for Decision Making; BUS 3010: Creating Value through Innovation; BUS 3020: Achieving Effective Operations; BUS 4030: Achieving Strategic Effectiveness. Microeconomics and Macroeconomics are required and also fulfill the WPI Social Science requirement.
3. Mathematics must include 2/3 units of calculus and 2/3 units of statistics.
4. Students selecting the Management Engineering Major must complete six courses from one of the concentrations as specified in the summary table for concentrations on page 46. Students may also work with their faculty advisor to create a custom MGE Program. Such custom programs must be approved by the advisor and the Business School's Undergraduate Policy and Curriculum Committee.

5. Breadth Electives must include at least 1/3 unit from among the 3000- and 4000-level courses in the School. The remaining 2/3 units specified in the requirement may be satisfied with courses from Mathematics, Basic Science, Computer Science, Social Science, or courses with any of the following prefixes: ACC, BUS, ETR, FIN, MIS, MKT, OBC, or OIE.
6. A minimum of 1/3 unit of Computer Science focused on programming. CS 1004, CS 1101, or CS 1102 is recommended. (CS 2022 and CS 3043 are not accepted.)

MANAGEMENT INFORMATION SYSTEMS (MIS)

EDUCATIONAL OBJECTIVES

The objectives of the Management Information Systems major are:

- To prepare students for positions involving the design and deployment of business applications using a wide variety of advanced information technologies, especially in high technology business, consulting, and service firms, in either start-up or established environments, and to prepare students for rapid advancement to project management and other management positions.
- To provide the knowledge and skills consistent with the professionally accepted IS curriculum guidelines. Specifically, this includes providing knowledge and skills related to:
 - business application development tools;
 - database, web-based and machine learning applications;
 - integrating IT into existing organizations through managing and leading systems analysis and design projects;
 - communicating effectively via written and oral presentations.
- To develop student abilities necessary for continued career growth including:
 - the ability to integrate theory and practice and to apply knowledge of information technology issues with the foundations of management;
 - the ability to integrate technology and change into existing organizations;
 - the ability to think critically and analytically, to define and solve business problems, work in teams, and think globally; and
 - the ability to learn new skills in response to changing professional requirements.

Program Distribution Requirements for the Management Information Systems Major

REQUIREMENTS (NOTE 1)	MINIMUM UNITS
1. Business Foundation (Note 2)	11/3
2. Mathematics (Note 3)	4/3
3. Basic Science	2/3
4. Management Information Systems Major (Note 4)	6/3
5. Breadth Electives (Note 5)	3/3
6. Computer Science (Note 6)	1/3
7. MIS MQP	3/3

NOTES:

1. Courses may not be counted more than once in meeting these distribution requirements.

2. The Business Foundation consists of BUS 1010: Leadership Practice; BUS 1020: Global Environment of Business Decisions; BUS 2020: The Legal Environment of Business Decisions; BUS 2060: Financial Statements for Decision Making; BUS 2070: Risk Analysis for Decision Making; BUS 2080: Data Analysis for Decision Making; BUS 3010: Creating Value through Innovation; BUS 3020: Achieving Effective Operations; BUS 4030: Achieving Strategic Effectiveness. Microeconomics and Macroeconomics are required and also fulfill the WPI Social Science requirement.
3. Mathematics must include 2/3 units of calculus and 2/3 units of statistics.
4. Students selecting the Management Information Systems major must complete six courses as specified in the summary table on page 46.
5. Breadth Electives must include at least 1/3 unit from among the 3000- and 4000-level courses in the School. The remaining 2/3 units specified in the requirement may be satisfied with courses from Mathematics, Basic Science, Computer Science, Social Science, or courses with any of the following prefixes: ACC, BUS, ETR, FIN, MIS, MKT, OBC, or OIE.
6. A minimum of 1/3 unit of Computer Science focused on programming. CS 1004, CS 1101, or CS 1102 is recommended. (CS 2022 and CS 3043 are not accepted.)

INDUSTRIAL ENGINEERING

PROGRAM MISSION

The mission of the Industrial Engineering (IE) Program at WPI is to prepare undergraduate students for professional engineering practice, providing the foundation for careers of leadership in challenging global and technological environments. We strive to accomplish this through:

- An innovative, project-based curriculum
- An emphasis on industrial engineering skills with system applications
- A flexible curriculum responsive to student interests and changes in the competitive environment
- An environment that encourages faculty/student interaction
- A culture that encourages the active involvement of students in their learning

PROGRAM EDUCATIONAL OBJECTIVES

The educational objectives of the IE Program describe the expected accomplishments of graduates during the first few years after graduation. They include:

Industrial Engineering Knowledge and Design Skills.

Graduates should be able to support operational decision making and to design solutions that address the complex and changing industrial engineering problems faced by organizations, using current concepts and technologies.

Communication Skills. Graduates will be sought out as the preferred employees to represent their companies both for internal and external communications based upon the excellence they will have achieved through persistent updating of their knowledge of new communication tools and by taking advantage of opportunities for critical peer review.

Teamwork and Leadership Skills. Graduates should be able to serve as change agents in a global environment, based on strong interpersonal and teamwork skills, an understanding of professional and ethical responsibility, and a willingness to take initiatives.

STUDENT OUTCOMES

Specifically, graduating students should demonstrate that they attain the following:

1. an ability to identify, formulate, and solve complex engineering problems by applying principles of engineering, science, and mathematics
2. an ability to apply engineering design to produce solutions that meet specified needs with consideration of public health, safety, and welfare, as well as global, cultural, social, environmental, and economic factors
3. an ability to communicate effectively with a range of audiences
4. an ability to recognize ethical and professional responsibilities in engineering situations and make informed judgments, which must consider the impact of engineering solutions in global, economic, environmental, and societal contexts
5. an ability to function effectively on a team whose members together provide leadership, create a collaborative and inclusive environment, establish goals, plan tasks, and meet objectives
6. an ability to develop and conduct appropriate experimentation, analyze and interpret data, and use engineering judgment to draw conclusions
7. an ability to acquire and apply new knowledge as needed, using appropriate learning strategies.

Program Distribution Requirements for the Industrial Engineering Major (IE)

The normal period of residency at WPI is 16 terms. In addition to the WPI requirements applicable to all students (see page 7), students wishing to receive the ABET accredited degree designated “Industrial Engineering” must complete a minimum of 10 units of study in the areas of mathematics, basic science, and engineering topics as follows:

REQUIREMENTS	MINIMUM UNITS
Mathematics and Basic Science (Note 1)	12/3
Industrial Engineering Topics (Note 2)	15/3
Capstone Design Experience (IE MQP)	3/3

NOTES:

1. Mathematics and Basic Science:
 - a. Mathematics must include differential and integral calculus, ordinary differential equations, and 2/3 units in probability and statistics.
 - b. 3/3 units of Basic Science in chemistry and physics. No GPS credits may be used.
 - c. 2/3 units of Math/Science Electives
2. Industrial Engineering Topics must include courses in the following three topic areas:
 - a. The IE Core consists of 9/3 units: BUS 3020: Achieving Effective Operations; OIE 2081: Introduction to Prescriptive Analytics; OIE 2850: Engineering Economics; OIE 3405: Work Systems and Facilities Planning or OIE 4420: Practical Optimization; OIE 3410: Materials Management in Supply Chains; OIE 3420: Quality Planning, Design and Control; OIE 3460: Simulation Modeling and Analysis; OIE 3510: Stochastic Models; OIE 3600: Scripting for Process & Productivity Improvement or CS 2119: Application Building with Object-Oriented Concepts or CS 2102: Object-Oriented Design Concepts or CS 2103: Accelerated Object-Oriented Design Concepts.

**INDUSTRIAL ENGINEERING
OVERVIEW OF DEGREE REQUIREMENTS**

UNIVERSITY REQUIREMENTS
<p>HUMANITIES AND ARTS (6/3 Units): 6 courses including Inquiry Seminar/Practicum</p> <p>SOCIAL SCIENCE (2/3 Units): ECON, ENV, GOV, SOC, SS, STS, and ID 2050</p> <p>PHYSICAL EDUCATION (1/3 Units)</p> <p>INTERACTIVE QUALIFYING PROJECT (3/3 Unit)-3rd Year</p>

MATHEMATICS AND SCIENCE REQUIREMENTS
<p>MATHEMATICS (7/3 Units)</p> <p>Calculus - MA 1021; MA 1022; MA 1023, MA 1024, MA 2051 Statistics - MA 2611; MA 2612 or 2621</p> <p>PHYSICS/CHEMISTRY (3/3 Units) CH, PH, CH or PH</p> <p>MATH/SCIENCE ELECTIVES (2/3 Units) Recommended Math: MA 2071, probability & stats., numerical analysis Science BB, CH, GE, PH</p>

INDUSTRIAL ENGINEERING CORE CURRICULUM (9/3 Units)	
<p>BUS 3020 Achieving Effective Operations OIE 2081 Introduction to Prescriptive Analytics OIE 2850 Engineering Economics OIE 3405 Work Systems and Facilities Planning <u>or</u> OIE 4420 Practical Optimization: Methods & Applications</p>	<p>OIE 3410 Materials Management in Supply Chains OIE 3420 Quality Planning, Design and Control OIE 3460 Simulation Modeling and Analysis OIE 3510 Stochastic Models OIE 3600 Scripting for Process & Productivity Improvement <u>or</u> CS 2119 <u>or</u> CS 2102 <u>or</u> CS 2103</p>

INDUSTRIAL ENGINEERING ELECTIVES-Operations Research (3/3 Units)
<p>Choose three: OIE 3405*, OIE 3600*, OIE 4410, OIE 4420*, OIE 4460, MIS 3720, MIS 4084, MIS 4720, MIS 4741, MA 3231, MA 3233, MA 3627, MA 3631, MA 4235, MA 4237, MA 4631, MA 4632. *Only if not taken in IE Core.</p>

TECHNICAL ELECTIVES (3/3 Units)
<p>Any designated CE (except CE 3022), CHE, CS (except CS 1004, 1101, 1102, 3043), ECE, ES (except ES 1000, 3323), ME, OIE, RBE, as well as any IE Elective (see above). Suggested courses include: CS 2011, CS 4032/MA 3257, ECE 2010, ES 1310, ES 2001, ES 2800, ES 3001, ME 1800, ME 2820. One ES course required. GPS course credits do not qualify.</p>

MAJOR QUALIFYING PROJECT (3/3 Units)
<p>The MQP must have an IE faculty advisor from the Business School.</p>
FREE ELECTIVES (3/3 Units)

b. IE Electives (3/3 units): Any 3000- or 4000-level Operations Research courses in MA; MIS 3720, 4084, 4720, 4741; OIE 3405*, 3600*, 4410, 4420*, 4460.

*Only if not taken in IE Core.

c. Technical Electives (3/3 units): Any Engineering Science/Design course qualifies (except ES 1000 and ES 3323), as well as any CE (except CE 3022), CHE, CS (except CS 1004, 1101, 1102 & 3043), ECE, ME, OIE and RBE. **At least one course in ES is required for meeting this requirement.** Suggested courses include: CS 2011, CS 4032/MA 3257, ECE 2010, ES 1310, ES 2001, ES 2800, ES 3001, ME 1800, ME 2820. No GPS credits may be used.

MINOR IN BUSINESS

Everyone needs management skills. If engineers, scientists, and others hope to advance in their careers, they must learn how to lead projects and manage groups. The Business minor offers students (other than BU, MGE, or MIS majors, who may take the courses as part of their major or as Breadth or Free Electives, as appropriate) the opportunity to learn some of the theory and practice of managing in organizations with material on management concepts and practices commonly encountered in the business world. This program will help students make a transition to the business world and will provide basic skills for operating effectively in business organizations.

To complete the Business minor, a student must complete two units of work, typically through course work with the following distribution:

1. Select any **five** from the following:
ECON 1110 OR ECON 1120
BUS 1010 Leadership Practice
BUS 1020 Global Environment of Business Decisions
BUS 2020 The Legal Environment of Business Decisions
BUS 2060 Financial Statements for Decision Making
BUS 2070 Risk Analysis for Decision Making
BUS 2080 Data Analysis for Decision Making
BUS 3010 Creating Value through Innovation
BUS 3020 Achieving Effective Operations
2. Select **one** of the following two courses:
BUS 4030 Achieving Strategic Effectiveness
ETR 4930 Growing and Managing New Ventures

The minor in Business is available to all students at WPI, except for those majoring in Business, Management Engineering or Management Information Systems majors at WPI.

For general policy on minors, see page 11 of the catalog.

MINOR IN ENTREPRENEURSHIP

All around the world people are starting their own new business ventures. With its strong heritage of invention and entrepreneurship among students and faculty members, WPI is committed to encouraging its students to consider that career path. Our dream is that our students will earn a minor in Entrepreneurship, which will provide them with some basic business skills and an understanding of what it takes to start a business, then they will create a new and exciting technology as their MQP that they will then turn into a business upon graduation.

Related opportunities include competitions for the following: The Robert H. Grant Invention Awards, the Strage Innovation Awards, and the Kalenian Award. Through the Collaborative for Entrepreneurship and Innovation, WPI sponsors the student entrepreneurship club, Tech Entrepreneurs, and promotes and sponsors MassChallenge.

The minor requires the completion of two units of course-work as noted below.

1. Complete the following course:
BUS 2060 Financial Statements for Decision Making
2. Complete two (2) from the following list:
ETR 1100 Engineering Innovation and Entrepreneurship
ETR 2900 Social Entrepreneurship
ETR 3633 Entrepreneurial Selling
ETR 3915 Entrepreneurial Business Models
3. Complete two (2) of the following courses:
BUS 2070 Risk Analysis for Decision Making
BUS 3010 Creating Value through Innovation
MKT 3640 Management of Process and Product Innovation
GOV 2313 Intellectual Property Law
4. Required:
ETR 4930 Growing and Managing New Ventures

The minor in Entrepreneurship is available to all students at WPI, regardless of major.

For general policy on minors, see page 11 of the catalog.

MINOR IN INDUSTRIAL ENGINEERING

Industrial Engineering is concerned with efficiency and process improvement, which are vital to any organization's survival and growth in a global, competitive world. Hence, the fundamental skills and knowledge of Industrial Engineering can be utilized in many areas, and are valuable supplements to a student's core competency in his/her chosen major discipline. The IE minor provides an easy link between the curricula in engineering and business and expands students' ability to tackle business decisions and problems using engineering techniques.

The minor requires the completion of two units of course-work (six courses) as noted below.

1. IE Tools, select at least two (2):
OIE 2081 Introduction to Prescriptive Analytics
OIE 2850 Engineering Economics
OIE 3460 Simulation Modeling and Analysis
OIE 3510 Stochastic Models
OIE 3600 Scripting for Process & Productivity Improvement
OIE 4420 Practical Optimization: Methods and Applications
2. IE Knowledge, select at least two (2):
BUS 3020 Achieving Effective Operations
OIE 3405 Work Systems and Facilities Planning
OIE 3410 Materials Management in Supply Chain
OIE 3420 Quality Planning, Design, and Control
OIE 4410 Case Studies in Industrial Engineering
OIE 4460 Global Planning and Logistics

The minor in Industrial Engineering is available to all students at WPI, except for those majoring in Industrial Engineering.

For general policy on minors, see page 11 of the catalog.

MINOR IN MANAGEMENT INFORMATION SYSTEMS

Information technology has been the driving force behind the new way of doing business. It has enabled companies to make tremendous strides in productivity, it has opened new markets and new channels, and it has created new product and service opportunities. While one part of the information revolution has been advances in hardware, and another has been advances in software, a third major advance has been in the systems-side of information, or how information is organized and used to make effective decisions. That is Management Information Systems (MIS). The minor in MIS offers students the opportunity to broaden their disciplinary program with material and skills widely useful in the business world. This program will help students to broaden their exposure to information technology and its use in business and industry.

To complete the Management Information Systems minor, a student must complete two units of work with the following distribution:

1. A total of **three (3)** courses in Business Foundation and Programming Skills, with at least **one (1)** from each group:
 - A. Business Foundation:
 - BUS 1010 Leadership Practice
 - BUS 1020 Global Environment of Business Decisions
 - BUS 2020 The Legal Environment of Business Decisions
 - BUS 2060 Financial Statements for Decision Making
 - BUS 2070 Risk Analysis for Decision Making
 - BUS 2080 Data Analysis for Decision Making
 - BUS 3010 Creating Value through Innovation
 - BUS 3020 Achieving Effective Operations
 - BUS 4030 Achieving Strategic Effectiveness
 - B. Programming Skills:
 - CS 1004 Introduction to Programming for Non-Majors **or**
 - CS 1101 Introduction to Program Design **or**
 - CS 1102 Accelerated Introduction to Program Design
 - CS 2102 Object-Oriented Design Concepts **or**
 - CS 2103 Accelerated Object-Oriented Design Concepts
 - CS 2119 Application Building with Object-Oriented Concepts
 - CS 2301 Systems Programming for Non-Majors **or**
 - CS 2303 Systems Programming Concepts
2. **Two (2)** courses from the group of courses:
 - MIS 3720 Management of Data
 - MIS 3787 Business Applications of Machine Learning
 - MIS 4084 Business Intelligence
 - MIS 4741 User Experience and Design
 - MIS 4781 Information Systems and Technology Policy and Strategy

3. Required:
 - MIS 4720 Systems Analysis and Design

The minor Management Information Systems is available to all students at WPI, except for those majoring in Management Information Systems.

For general policy on minors, see page 11 of the catalog.

MINOR IN SOCIAL ENTREPRENEURSHIP

Social Entrepreneurship is defined as the formation of a new venture that combines social goals and for-profit activity to address social needs through novel solutions. Social entrepreneurs are leaders in that to be effective, they have to identify social problems, work closely with key stakeholders in identifying solutions to those problems, offer a vision for change, communicate clearly and persuasively to others, negotiate for resources from both public and private concerns, involve people in the solutions to problems, and be creative passionate, and persistent in how they work through various obstacles to progress. It is the purpose of the Social Entrepreneurship minor to provide students with the theoretical underpinnings of leadership, entrepreneurship, and social innovation. This minor will interest those students for whom the Great Problem Seminar and/or IQP have been an eye-opening experience and who aspire to change the world — or some part of it.

The minor requires the completion of two units of coursework as outlined below.

1. Required:
 - BUS 1010 Leadership Practice
2. Select two (2):
 - ETR 2900 Social Entrepreneurship
 - ETR 3633 Entrepreneurial Selling
 - ETR 3915 Entrepreneurial Business Models
 - ETR 4930 Growing and Managing New Ventures
3. Select two (2):
 - BUS 1020 Global Environment of Business Decisions
 - BUS 2020 Legal Environment of Business Decisions
 - ENV 1100 Introduction to Environmental Studies
 - ENV 2400 Environmental Problems and Human Behavior
 - ENV 2600 Environmental Problems in the Developing World
 - ENV 4400 Senior Seminar in Environmental Studies
 - OBC 3354 Organizational Behavior and Change
 - PSY 1402 Social Psychology
 - PSY 2406 Cross-Cultural Psychology
 - SOC 1202 Introduction to Sociology and Cultural Diversity
4. Required:
 - OBC 4367 Leadership, Ethics, and Social Responsibility (or a suitable ISU)

The minor in Social Entrepreneurship is available to all students at WPI, regardless of major.

For general policy on minors, see page 11 of the catalog.

CHEMICAL ENGINEERING

S. ROBERTS, HEAD

PROFESSORS: T. A. Camesano, R. Datta, A. G. Dixon,
N. K. Kazantzis, S. Roberts, J. Wilcox

ASSOCIATE PROFESSORS: W. M. Clark, N. A. Deskins,
D. DiBiasio, M. T. Timko, H. Zhou

ASSISTANT PROFESSORS: E. Stewart, A. Teixeira, E. Young

PROFESSOR OF PRACTICE: S. J. Kmietek

ASSOCIATE TEACHING PROFESSOR: W. Zurawsky

ASSISTANT TEACHING PROFESSOR: L. Abu-Lail

ASSISTANT RESEARCH PROFESSORS: G. Tompsett, S. Liguori

ADJUNCT INSTRUCTOR: B. Partopour, T. Starr

ASSOCIATED FACULTY: J. Bergendahl (CEE), J. Coburn (BME),

N. Dembsey (FPE), R. Grimm (CBC), D. Lados (ME),

J. Liang (ME), G. Pins (BME), P. Rao (ME), R. Rao (BBT),

A. Rangwalla (FPE), K. Rashid, L. Titova (PH), Y. Wang (ME)

EMERITUS FACULTY: Y. H. Ma, W. R. Moser, R. W. Thompson,
H. Weiss

MISSION STATEMENT

To prepare technically advanced, socially aware and interdisciplinary-minded chemical engineers. Our graduates will be ready to serve the global community as leaders, scholars and innovators.

VISION STATEMENT

WPI's chemical engineering department will be a national leader in innovating and implementing curricula, project work and research that infuses global, entrepreneurial and humanitarian perspectives.

PROGRAM EDUCATIONAL OBJECTIVES

The Chemical Engineering Department has established the following objectives of the undergraduate program in support of our mission and that of the Institute. Graduates are expected to be able to attain these objectives within 5 years following graduation:

1. Graduates will be able to use chemical engineering principles to solve problems of practical importance to society.
2. Graduates will be productive and informed citizens of society as well as of their professional community and will be positioned for a lifetime of success.
3. Graduates will be effective communicators.

STUDENT OUTCOMES

In support of the three Program Educational Objectives, the Chemical Engineering Department has adopted the eleven Student Outcomes established in ABET Criteria 3, (1)-(7), listed below:

Students shall demonstrate:

- 1) an ability to identify, formulate, and solve complex engineering problems by applying principles of engineering, science, and mathematics

- 2) an ability to apply engineering design to produce solutions that meet specified needs with consideration of public health, safety, and welfare, as well as global, cultural, social, environmental, and economic factors
- 3) an ability to communicate effectively with a range of audiences
- 4) an ability to recognize ethical and professional responsibilities in engineering situations and make informed judgments, which must consider the impact of engineering solutions in global, economic, environmental, and societal contexts
- 5) an ability to function effectively on a team whose members together provide leadership, create a collaborative and inclusive environment, establish goals, plan tasks, and meet objectives
- 6) an ability to develop and conduct appropriate experimentation, analyze and interpret data, and use engineering judgment to draw conclusions
- 7) an ability to acquire and apply new knowledge as needed, using appropriate learning strategies.

Program Distribution Requirements for the Chemical Engineering Major

The normal period of residency at WPI is 16 terms. In addition to the WPI requirements applicable to all students (see page 7), students wishing to receive the ABET-accredited degree designated "Chemical Engineering" must satisfy the distribution requirements shown below.

REQUIREMENTS	MINIMUM UNITS
1. Mathematics and Base Science (Notes 1 and 2)	4
2. Engineering Science and Design (Notes 3 and 4)	6
3. Advanced Chemistry and Natural Science (Note 5)	5/3

NOTES:

1. Must include differential and integral calculus and differential equations.
2. Must include 3 courses in chemistry, 2 courses in physics and 1 course in biology or biochemistry.
3. Must include 1 unit of MQR, 1/3 unit of capstone design experience (e.g. CHE 4404), and at least 1/3 unit of engineering study outside the major. Courses used to satisfy this requirement must be at the 2000-level or above, with the exception of CHE 1011. Students may not count both CHE 1011 and ES 2002 as engineering electives. CS and DS courses are included in the category of engineering study.
4. Must include at least 4 units from the following list of core chemical engineering courses: CHE 2011, CHE 2012, CHE 2013, CHE 2014, ES 3004, ES 3003, ES 3002, CHE 3201, CHE 3501, CHE 4401, CHE 4402, CHE 4403, CHE 4404, CHE 4405, CHE 4410. Students may not count both CHE 4404 and CHE 4410 as core courses.
5. Advanced chemistry and natural science courses are defined as any 2000-level and above BB, CH, PH, or GE course and CH 1040. Must include 3 advanced CH courses at 2000-level or above. Up to 2/3 unit of advanced chemistry and natural science may be double counted under requirements 1 and 3.

CONCENTRATIONS FOR CHEMICAL ENGINEERING MAJORS

Chemical engineering majors may choose to focus their studies by obtaining one of the following Concentrations: Biological, Energy, Environmental, or Materials. A Concentration is not mandatory and some students will benefit from exploring a variety of areas rather than choosing to focus on one. The Concentrations require 3 units of study (potentially all of which may be double-counted towards the Chemical Engineering degree) comprised of the following: an MQP (that satisfies the Chemical Engineering degree requirement and covers a topic in the Concentration field) and 2 units from the appropriate list below. We have designed each concentration around a fundamental course offered annually in the Department (shown in bold for each concentration below) that students are encouraged to take. Students should consult their academic advisor for advice and the Chemical Engineering Department Undergraduate Committee for approval of an appropriate course of study. Appropriate experimental courses, ISUs, and other appropriate courses or projects, not on the current lists, may be applied towards a Concentration with approval from the Chemical Engineering Undergraduate Committee.

CHEMICAL ENGINEERING WITH BIOLOGICAL CONCENTRATION

Science:

BB 1035	Biotechnology*
BB 1025	Human Biology*
BB 2003	Fundamentals of Microbiology
BB 2550	Cell Biology
BB 3102	Human Anatomy & Physiology: Transport and Maintenance
BB 560	Separation of Biological Molecules
CH 4110	Protein Structure and Function
CH 4120	Lipids and Biomembrane Functions
CH 4130	Nucleic Acids and Bioinformatics

Engineering Science and Design:

CHE 3201	Kinetics and Reactor Design
CHE 3301	Introduction to Biological Engineering
CHE 4402	Unit Operations Laboratory II
BME 1001	Introduction to Biomedical Engineering+
BME 2511	Introduction to Biomechanics and Biotransport
BME/ME 4504	Biomechanics
BME/ME 4606	Biofluids
BME/ME 4814	Biomaterials
CHE 521	Biochemical Engineering
BB 509	Scale-Up of Bioprocessing

*No more than one 1000-level course may be counted.

CHEMICAL ENGINEERING WITH ENERGY CONCENTRATION

Science:

CH 3510	Chemical Thermodynamics*
CH 3550	Chemical Dynamics
PH 2101	Principles of Thermodynamics*

Engineering Science and Design:

CHE 3201	Kinetics and Reactor Design
CHE 3301	Introduction to Biological Engineering
CHE 3702	Energy Challenges in the 21st Century
CHE 3722	Bioenergy
CHE 4402	Unit Operations of Chemical Engineering II
ES 3001	Introduction to Thermodynamics*
ES 3003	Heat Transfer
ES 3005	Radiation Heat Transfer Applications
ME 4710	Gas Turbines for Propulsion and Power Generation
CHE 506	Kinetics and Catalysis
CHE 507	Chemical Reactor Design
CHE 531	Fuel Cell Technology
CHE 561	Advanced Thermodynamics
FP 520	Fire Modeling
FP 521	Fire Dynamics

*Only one of the following courses may be counted: ES 3001, CH 3510, or PH 2101.

CHEMICAL ENGINEERING WITH ENVIRONMENTAL CONCENTRATION

Science:

GE 2341	Geology
BB 1002	Environmental Biology
BB 2040	Principles of Ecology

Engineering Science and Design:

CHE 3301	Introduction to Biological Engineering
CHE 3910	Chemical and Environmental Technology
CHE 3920	Air Quality Management
CHE 3201	Kinetics and Reactor Design
CHE/CE 4063	Transport and Transformations in the Environment

CHE 4402	Unit Operations Laboratory II
ES 3002	Mass Transfer
ES 2800	Environmental Impacts of Engineering Decisions
CE 3060	Water Treatment
CE 3061	Waste Water Treatment
CE 4060	Environmental Engineering Lab
CE 4061	Hydrology
CE 3059	Environmental Engineering*
CE 3070	Introduction to Urban and Environmental Planning*
CE 3074	Environmental Analysis*

*Only one of the following courses may be counted: CE 3059, CE 3070, or CE 3074.

CHEMICAL ENGINEERING WITH MATERIALS CONCENTRATION

Science:

CH 2320	Organic Chemistry II
CH 3410	Structure, Bonding, and Reactivity in Inorganic Chemistry
CH 4330	Organic Synthesis

Engineering Science and Design:

ES 2001	Introduction to Material Science
CHE 3201	Kinetics and Reactor Design
CHE 508	Catalysis and Surface Science of Materials
ME 2820	Materials Processing
ME 3801	Experimental Methods in Material Science and Engineering
ME 4813	Ceramics and Glasses for Engineering Applications
ME 4814	Biomaterials
ME 4821	Plastics
ME 4832	Corrosion and Corrosion Control
ME 4840	Physical Metallurgy
ME 4875/MFE 575	Introduction to Nanomaterials and Nanotechnology

CHEMISTRY AND BIOCHEMISTRY

A. GERICKE, HEAD; J. P. DITTAMI, ASSOCIATE HEAD

PROFESSORS: J. M. Argüello, B. Bursten, J. P. Dittami, A. Gericke, S. Scarlata

ASSOCIATE PROFESSORS: S. C. Burdette, R. Dempksi, M. H. Emmert, G. Kaminski, J. C. MacDonald, A. Mattson, K. N. Wobbe

ASSISTANT PROFESSORS: J. Grimm, C. Olsen

ASSOCIATE TEACHING PROFESSORS: D. Brodeur, D. Heilman, C. Lambert, U. Kumar

ASSISTANT TEACHING PROFESSOR: A. Cooper-Morgan

EMERITUS PROFESSORS: N. Kildahl, J. Pavlik, A. Seala, S. Weininger

MISSION STATEMENT

Through dynamic and innovative classroom instruction and exciting cutting edge research programs, the Department of Chemistry and Biochemistry strives to provide students with both a broad understanding of the fundamentals of the chemical sciences and an opportunity to create new chemical and biochemical knowledge through original research. We aspire to produce graduates who will enter their scientific careers with the confidence and competence to lead the advance of chemistry and biochemistry in the 21st century.

PROGRAM EDUCATIONAL OBJECTIVES

The Department of Chemistry and Biochemistry will graduate outstanding professionals possessing fundamental knowledge of the chemical sciences. Graduates will be able to apply this knowledge to the solution of problems in chemistry and biochemistry for the advancement of knowledge in these fields and the improvement of the standard of living of all humanity.

PROGRAM OUTCOMES

Students graduating with a major in Chemistry or Biochemistry will be able to demonstrate an ability to:

- perform accurate and precise quantitative measurements
- use and understand modern instruments, particularly NMR, IR, and UV-vis spectrometers, chromatographs, electrochemical instruments, and lab computers
- keep legible and complete experimental records

- analyze data statistically and assess reliability of results
- anticipate, recognize, and respond properly to hazards of chemical manipulations
- interpret experimental results and draw reasonable conclusions
- plan and execute experiments through use of the literature
- design experiments
- communicate effectively through oral and written reports
- critically assess their work for reasonableness and self-consistency
- adhere to high ethical standards
- learn independently

BIOCHEMISTRY

Program Distribution Requirements for the Biochemistry Major

In addition to the WPI requirements applicable to all students (see page 7), students wishing to graduate with a degree in biochemistry must meet the distribution requirements detailed below.

REQUIREMENTS	MINIMUM UNITS
1. Mathematics and Physics (Note 1).	2
2. Chemistry and Biochemistry (Note 2).	4 1/3
3. Biology (Note 3).	1 1/3
4. Chemistry and Biochemistry/ Biology Laboratory (Note 4).	1
5. Other Natural or Computer Science (Note 5).	1/3
6. MQP	1

NOTES:

1. The mathematics in MA 1021-MA 1024 or the equivalent is recommended. The physics in PH 1110-PH 1120 or equivalent is recommended.
2. These 4 1/3 units must include one unit of organic, 1 1/3 units of biochemistry, and 1/3 unit each of physical (3000 level or higher) and inorganic chemistry (3000 level or higher).
3. These 1 1/3 units must include 1/3 unit of cell biology, 1/3 unit of genetics, and 1/3 unit of advanced work (3000 level or higher).
4. This unit must include a minimum of 2/3 units of Chemistry and Biochemistry labs, of which 1/3 unit must be either CH 4150 or CH 4170. The remaining 1/3 unit may come from BB or CBC labs. However, counting both CH 4170 and BB 3512 is not allowed.
5. Any course in the natural sciences (not used to satisfy another requirement) or in computer science may be used to satisfy this requirement.

RECOMMENDATIONS FOR STUDENTS

A typical Biochemistry curriculum is given below.

Premedical students should take three terms of Physics, as well as one of the Organic Chemistry Laboratories (CH 2360 or CH 2660), by the end of their third year. BB 1035 is recommended as the initial course for students who need to strengthen their background in biology. Note that a total of one unit designated Elective in the table must be in Biology.

Students should take 1/3 unit of advanced Biology laboratory (BB 3512, 3518, 3519, 3520 are recommended) at their discretion as to the term; however, this should preferably be done before the MQP is commenced.

Recommended Biochemistry Program

Year	Term A	Term B	Term C	Term D
First	CH 1010 BB 2550 MA	CH 1020 HU MA	CH 1030 BB 2920 MA	CH 1040 HU MA
Second	CH 3510 CH 2640 HU	CH 2310 SS HU	CH 2320 HU PH	CH 2330 HU PH
Third	CH 4110 BB Lab SS	CH 4120 CH 4150 IQP	CH 4130 CH 3410 IQP	CH 4170 CH 4140 IQP
Fourth	Elective MQP Elective	Elective MQP Elective	CH 4160 MQP Elective	CH 4190 MQP Elective

CHEMISTRY**Program Distribution Requirements for the Chemistry Major**

In addition to the WPI requirements applicable to all students (see page 7), students wishing to graduate with a degree in chemistry must meet the distribution requirements detailed below.

REQUIREMENTS	MINIMUM UNITS
1. Mathematics and Physics (Note 1).	2 1/3
2. Chemistry (Notes 2, 3).	4
3. Additional Science/Engineering (Notes 3, 4).	3 2/3

NOTES:

- Must include differential and integral calculus and at least 2/3 units of physics.
- Must be above the level of general chemistry (2000 level or higher). These 4 units must include courses in experimental chemistry (either 4/3 unit or 3/3 unit), inorganic chemistry (1/3 unit), organic chemistry (3/3 unit), physical chemistry (3/3 unit), and biochemistry (either 1/3 unit or 2/3 unit, depending on the number of experimental chemistry courses taken). At least 2/3 units must be at or higher than the 4000 level.
- Students cannot receive credit for both CH 2360 and CH 2660.
- Distributed among the MQP, the natural and physical sciences, computer science, mathematics, and engineering (and including general chemistry, CH 1010-1040).

RECOMMENDATIONS FOR STUDENTS

Chemistry utilizes many of the concepts of physics and the tools of mathematics. Thus students should acquire a background in these subjects early in their programs. The material addressed in MA 1021 through MA 1024 is recommended for all chemistry majors. Students will also benefit from knowledge of differential equations, as discussed in MA 2051. Physics background should include mechanics, and electricity and magnetism. Either the PH 1110-1120 or the PH 1111-1121 sequence is recommended. Students seeking more depth in physics are advised to pursue PH 1130 and PH 1140.

Students seeking ACS certification (see below) should plan to study calculus through introductory multivariable calculus (MA 1021-1024), differential equations (MA 2051) and linear algebra (MA 2071), and should take a minimum of two courses in physics (for example, PH 1111 and PH 1121).

AMERICAN CHEMICAL SOCIETY APPROVAL AND CERTIFICATION

The Department of Chemistry and Biochemistry has an American Chemical Society (ACS) approved program. Thus graduates who complete programs satisfying the ACS recommendations have their degrees certified to the society by the department. Accordingly, students can earn an "ACS-Certified Degree in Chemistry" or an "ACS-Certified Degree in Chemistry with a Biochemistry Option."

ACS-Certified graduates are eligible for immediate membership in the ACS and thus are able to secure the benefits of membership, which include helpful services such as finding employment.

ACS-CERTIFIED DEGREE IN CHEMISTRY

The following sequence of courses, recommended to provide fundamental background in chemistry, will result in an ACS-certified degree in chemistry. Specialization in particular areas of interest is best accomplished via additional courses and projects, generally taken in the third and fourth years.

Recommended CBC Courses for an ACS-Certified Degree in Chemistry

Year	Term A	Term B	Term C	Term D
First	CH 1010	CH 1020	CH 1030	CH 1040
Second	CH 2640 (lab) CH 3510 (phys)	CH 2650 (lab) CH 2310 (org)	CH 2660 (lab) CH 2320 (org)	CH 2670 (lab) CH 2330 (org)
Third		CH 3550 (phys)	CH 3410 (inorg) CH 3530 (phys)	
Fourth	CH 4110 (bioc)			CH 4420 (inorg)

ACS-CERTIFIED DEGREE IN CHEMISTRY WITH A BIOCHEMISTRY OPTION

Students seeking the ACS-Certified Degree with Biochemistry Option must complete the following work in addition to those requirements noted above for an ACS-Certified Degree in Chemistry.

- 1/3 unit of biology which contains cell biology, microbiology or genetics.
- 2/3 unit of biochemistry that has organic chemistry as a prerequisite.
- 1/3 unit of a laboratory in biochemical methods.
- Research in biochemistry culminating in a comprehensive written report is highly recommended.

CONCENTRATION IN MEDICINAL CHEMISTRY

Medicinal Chemistry is the application of principles of biology and chemistry to the rational design and synthesis of new drugs for treatment of disease. A medicinal chemist applies knowledge of chemistry, biochemistry and physiology to generate solutions to health-related problems.

A concentration in medicinal chemistry is excellent preparation for students interested in entering health related professions, such as the pharmaceutical industry, upon graduation. Possible employment positions are numerous and expected to increase in the future.

COURSE REQUIREMENTS

In order to be eligible to receive the Medicinal Chemistry designation on their transcripts, chemistry majors need to satisfy the following course requirements:

Three biomedically oriented courses selected from the following list must be included in the distribution requirements:

- CH 4110 Protein Structure and Function
- CH 4120 Lipids and Biomembrane Functions
- CH 4130 Nucleic Acids and Bioinformation
- CH 4150 Enzymology and Protein Characterization Laboratory
- CH 4170 Experimental Genetic Engineering

Three courses oriented toward structure, synthesis, or mechanisms selected from the following list must be included in the distribution requirements. (All graduate courses in chemistry are open to undergraduates.)

- CH 4330 Organic Synthesis
- CH 516 Chemical Spectroscopy
- CH 536 Theory and Applications of NMR Spectroscopy
- CH 538 Medicinal Chemistry
- CH 554 Molecular Modeling

In addition to the above course requirements, chemistry majors must complete an MQP in the medicinal chemistry area, approved by the Program Coordinator. Examples of available projects are:

- Synthesis of huperzine analogs. New acetylcholinesterase inhibitors for treatment of Alzheimer's.
- Synthesis of opiate analogs.
- Computer simulations of small molecules and their interactions with proteins.

PROJECT ACTIVITY

A student undertaking a Major Qualifying Project in chemistry and biochemistry chooses a faculty advisor in the department with whom to work. This choice is normally made because the student is interested in the research program directed by the faculty member, and wants to become a part of this activity. The student is given a research problem to work on for a minimum of 20 hours a week for 3 terms. Although most MQP projects in chemistry and biochemistry are individual student efforts, team projects involving up to 3 students are occasionally available, depending on the faculty member concerned. The project culminates in a formal written MQP report and a poster session presentation to the department faculty and students. MQP projects in chemistry and biochemistry require a substantial effort from the student in both the laboratory and writing phases. Many projects result in professional publications and/or presentations at professional meetings. The department offers a variety of areas of specialization (see AREAS OF SPECIALIZATION IN CHEMISTRY AND BIOCHEMISTRY below) in which Major Qualifying Projects may be carried out.

Some students, particularly those in biochemistry, choose to do their MQPs at off-campus laboratories. Biochemistry projects have recently been completed at the University of Massachusetts Medical Center and Tufts University School of Veterinary Medicine.

AREAS OF SPECIALIZATION IN CHEMISTRY AND BIOCHEMISTRY

Computational Chemistry and Molecular Modeling
Gene Regulation
Homogeneous Catalysis
Ion Transport
Materials
Medicinal Chemistry
Membrane Proteins
Membrane Signaling Processes
Molecular Spectroscopy
Nanoscale Design
Natural Products Synthesis
Animal-Virus Biochemistry
Photochemistry
Photophysics
Sensors
Supramolecular Chemistry

MINOR IN BIOCHEMISTRY

A biochemistry minor allows students to develop real depth of understanding in biochemistry. The minor can include laboratory work, or be entirely classroom based. As biochemistry is a science that utilizes fundamentals from both chemistry and biology, courses from both areas are included. Some knowledge of organic chemistry is required to fully understand biochemistry.

Two units of study are required for the biochemistry minor as follows (note that in accordance with Institutional rules, one full unit, including the capstone, must be independent of distribution requirements for the major). Courses may count in only one area.

1. 1/3 unit of organic chemistry selected from
CH 2320
CH 2330
CH 2360
2. 1/3 unit of biology focused on cellular or subcellular biology. Acceptable courses include
BB 2550 BB 3620
BB 2920 BB 3920
BB 3080
3. At least 3/3 unit of biochemistry selected from
CH 4110 CH 4150
CH 4120 CH 4170
CH 4130
4. Capstone to be selected from
CH 4150 CH 4170
CH 4160 CH 4190

Majors in chemistry may not receive a biochemistry minor.

MINOR IN CHEMISTRY

The Minor in Chemistry is flexible and allows a student to design a minor with the balance between depth and breadth that is appropriate for the student's specific educational and professional objectives. Of the two units of required study, one unit must be at an advanced level (3000/4000), including a 4000 level capstone course. WPI policy for double counting courses to satisfy the requirements for a minor can be found in the Undergraduate Catalog.

REQUIREMENTS (Note 1)	UNITS
1000 level CH course	1/3
2000 level CH courses (Note 2)	2/3
3000/4000 level CH courses	2/3
4000 level CH courses (capstone)	1/3

NOTES

1. A higher level CH course can be used to satisfy the requirement for a lower level course e.g. 2000 for 1000, 3000 /4000 for 2000 etc.
2. Selected from CH2310, CH2320, and CH2330.

Two examples of sequences that satisfy the requirements for a CH minor:

CH Minor with Breadth	CH Minor with Depth in Physical Chemistry
CH 1020 Chemical Reactions	CH 1020 Chemical Reactions
CH 2310 Organic Chemistry I	CH 3510 Chemical Thermodynamics
CH 2320 Organic Chemistry II	CH 3530 Quantum Chemistry
CH 3510 Chemical Thermodynamics	CH 3550 Chemical Dynamics
CH 3410 Structure, Bonding, and Reactivity in Inorganic Chemistry	CH 3410 Structure, Bonding, and Reactivity in Inorganic Chemistry
CH 4110 Protein Structure and Function	CH 4520 Chemical Statistical Mechanics

Many other sequences are possible.

CIVIL AND ENVIRONMENTAL ENGINEERING

C. M. EGGLESTON, HEAD; M. TAO, ASSOCIATE HEAD

PROFESSORS: C. M. Eggleston, T. El-Korchi, R. Mallick, H. Walker
 ASSOCIATE PROFESSORS: L. D. Albano, J. Bergendahl, J. Dudle
 P. P. Mathisen, N. Rahbar, A. Sakulich, G. F. Salazar, M. Tao, Van Dessel
 ASSISTANT PROFESSORS: S. Liu,
 INSTRUCTOR: S. LePage
 ASSISTANT TEACHING PROFESSORS: L. Abu-Lail, M. Farzinmohadam, D. Rosbach
 EMERITUS PROFESSORS: F. DeFalco, R. Fitzgerald, J. C. O’Shaughnessy, R. Pietroforte
 ASSOCIATED FACULTY: T. Camesano (CHE), S. Kmietek (CHE)

MISSION STATEMENT

The Civil Engineering program at WPI prepares graduates for careers in civil engineering, emphasizing professional practice, civic contributions, and leadership, sustained by active life-long learning. The curriculum combines a project based learning environment with a broad background in the fundamental principles of civil engineering. Students have the flexibility to explore various civil engineering disciplines and career opportunities.

PROGRAM EDUCATIONAL OBJECTIVES

Graduates a few years out of the Civil and Environmental Engineering Undergraduate Program should:

1. be global citizens and stewards for the planet with an appreciation for the interrelationships between basic knowledge, technology, and society, while solving the challenges facing civil engineers in the 21st century.
2. be able to apply the fundamental principles of mathematics, science and engineering to analyze and solve problems and to produce creative sustainable design.
3. have the ability to engage in life-long learning, enhance their technical skills through graduate studies and continuing education, and through relevant experience.
4. exhibit leadership in the civil engineering profession, be engaged in professional societies, demonstrate understanding of ethical responsibility, and have a professional demeanor necessary for a successful civil engineering career.

STUDENT OUTCOMES

The Student Outcomes for the Bachelor degree in Civil Engineering are that all graduates will attain:

1. an ability to identify, formulate, and solve complex engineering problems by applying principles of engineering, science, and mathematics
2. an ability to apply engineering design to produce solutions that meet specified needs with consideration of public health, safety, and welfare, as well as global, cultural, social, environmental, and economic factors
3. an ability to communicate effectively with a range of audiences
4. an ability to recognize ethical and professional responsibilities in engineering situations and make informed judgments, which must consider the impact of engineering solutions in global, economic, environmental, and societal contexts
5. an ability to function effectively on a team whose members together provide leadership, create a collaborative and inclusive environment, establish goals, plan tasks, and meet objectives
6. an ability to develop and conduct appropriate experimentation, analyze and interpret data, and use engineering judgment to draw conclusions
7. an ability to acquire and apply new knowledge as needed, using appropriate learning strategies.

Program Distribution Requirements for the Civil Engineering Major

The normal period of undergraduate residency at WPI is 16 terms. In addition to the WPI requirements applicable to all students (see page 7), students wishing to receive the ABET accredited degree designated “Civil Engineering” must satisfy certain distribution units of study in the areas of mathematics, basic science, and engineering science and design as follows:

REQUIREMENTS	MINIMUM UNITS
1. Mathematics and Basic Science (Notes 1,2).	4
2. Engineering Science and Design (including the MQP) (Note 3,4,5,6).	6

NOTES:

1. Mathematics must include differential and integral calculus, differential equations, and probability and statistics.
2. Must include at least one course in physics, two courses in chemistry, and one course in an additional science area.
3. A minimum of 4 units of work must be within the Civil Engineering area. All CE courses including the MQP, ES 2503, ES 2800, and ES 3004 are acceptable within the Civil Engineering area.
4. The curriculum must include at least one engineering science course outside the major discipline area. Courses acceptable to satisfy the requirement of outside-of-discipline course are those taught in other engineering departments. The course must be 2000-level or above and cannot include ES 2501, ES 2502, ES 2503, ES 2800, and ES 3004.
5. All students are required to include an appropriate laboratory experience as part of their overall program. This experience can be met by the completion of two undergraduate CE lab courses, selected from among the following: CE 2020, CE 3024, CE 3026, CE 4054, and CE 4060. Alternately, an appropriate laboratory experience could also be accomplished by a student through careful planning of course, project and laboratory work and approval by petition through the Department Program Review Committee.
6. Must include 1/3 unit of Capstone Design Experience, and 4/3 units from the following list of Civil Engineering courses: CE 2020, CE 3010, CE 3020, CE 3041, CE 3050, CE 3059, and CE 3062.

PROGRAM DEVELOPMENT AND COURSE SELECTION

Students must meet distribution requirements for the Civil Engineering major; however, no unique courses are specifically required. Students should consult with their academic advisor to develop a program of study that meets WPI and ABET requirements. In addition, students should achieve breadth across the civil engineering discipline by taking courses in at least four subareas, depth within subareas of interest, and an understanding of the civil engineering profession. Lastly, a concentration in the environmental subarea is available. The program chart on page 59 can aid students in developing their plan of study.

SUBAREAS OF CIVIL ENGINEERING

Civil and environmental engineers plan, design, build and maintain the facilities that are paramount to modern society - facilities that provide for a high quality of life. These include buildings, transportation systems, waterways, and water and wastewater treatment systems, to name a few. Today, these facilities are designed using modern information systems and the principles of sustainability. Several subareas of civil and environmental engineering are available for study. Students are encouraged to take courses in multiple areas and develop an understanding for the interrelationships between these subareas that are involved in most civil engineering problems.

STRUCTURAL AND GEOTECHNICAL ENGINEERING

(L. Albano, T. El-Korchi, R. Mallick, N. Rahbar, A. Sakulich, M. Tao)

The practice of structural engineering involves the analysis and design of buildings, bridges, roads, and other components of our infrastructure. An understanding of mechanics and the engineering properties of construction materials serves as a foundation for study in this area. Geotechnical engineering focuses on the engineering behavior of earth materials. The design, analysis and construction of subsurface facilities includes a broad array of applications - including building foundations, pavement subgrades, tunnels, dams, landfills, and groundwater development.

ENVIRONMENTAL ENGINEERING

(J. Bergendahl, J. Dudle, C. M. Eggleston, S. LePage, P. Mathisen, H. Walker)

Environmental engineering involves protection of natural ecosystems as well as protection of public health. The practicing environmental engineer is concerned with planning, design, construction, operation and regulation of water quality control systems related to water supply and treatment, wastewater collection and treatment, and water resources protection. The environmental engineer is also concerned with hazardous waste remediation, pollutant migration and modeling, solid waste management, public health, radiological health, and air pollution control.

TRANSPORTATION ENGINEERING

(T. El-Korchi, S. LePage, R. Mallick, M. Tao)

Transportation engineers focus on the safe and efficient movement of people and goods. In particular, transportation engineers plan, design, construct, and operate highways and other facilities, such as transit systems, railways, and airports. The transportation infrastructure in the U.S. plays an important role in commerce, and the development of systems to carry large volumes of traffic safely and securely is important. Thus, the transportation engineer is concerned with roadway development, pavement engineering, drainage systems, traffic engineering, roadside safety, and travel demand modeling.

URBAN AND ENVIRONMENTAL PLANNING

(S. LePage, P. Mathisen)

The Urban and Environmental Planning area involves evaluating relationships between community development and both the natural and built environment. Planners seek to improve the quality of life in communities, with particular emphasis on environmentally conscious and sustainable solutions. Through the analysis and presentation of relevant data, planners inform and guide the public decision-making process while balancing economic, political, environmental, and social concerns. By exploring methods in community master planning, environmental impact analysis, growth management, and land use regulation, students can develop a comprehensive understanding of the framework within which civil engineers address urban and environmental planning problems.

CONSTRUCTION ENGINEERING AND PROJECT MANAGEMENT

(L. Albano, G. Salazar)

The construction engineering and project management subarea is directed to students whose interests lie in the design and construction engineering process but who are also concerned with engineering economics, social science, management, business, labor and legal relations, and the interaction of governmental and private interests as they relate to major construction projects. Engineers in this subarea plan, estimate, schedule and manage the construction of engineered facilities using modern tools - including information technologies and control systems.

ENVIRONMENTAL CONCENTRATION

Civil Engineering majors may choose to focus their studies by obtaining an Environmental concentration. An Environmental concentration in the CEE Department focuses on the planning, design, construction, operation and regulation of water quality control systems related to water supply and waste treatment. Additional areas of focus include hydrology, hydraulics, water resources, solid and hazardous waste management, waste minimization, public health and air pollution control.

Students electing to pursue the Environmental concentration follow a general curriculum in Civil Engineering, with emphasis on the environmental engineering subarea. Such preparation leads to an ABET accredited degree, and is an excellent start for entry-level professional placement or graduate study in environmental engineering.

The Environmental concentration is earned by completing six courses from the following list (or alternate courses through petition) plus an MQP in the environmental area. Typical MQPs include analysis and design of innovative water treatment, water quality monitoring and pollutant control,

water resources analysis and groundwater studies, innovative solid waste solutions, and air pollution control.

CE 3059	Environmental Engineering
CE 3060	Water Treatment
CE 3061	Wastewater Treatment
CE 3062	Hydraulics
CE 3070	Urban and Environmental Planning
CE 3074	Environmental Analysis
CE 4060	Environmental Engineering Laboratory
CE 4061	Hydrology
CE/CHE 4063	Transport and Transformations in the Environment
CE 4071	Land Use Development & Controls
CE 4600	Hazardous and Industrial Waste Management
CHE 3201	Kinetics and Reactor Design

PROJECTS

A great variety of projects are available to civil and environmental engineering students. Students may select project topics which are related to their subarea of emphasis, or may develop interdisciplinary projects that incorporate multiple subareas. Projects exemplify the type of work students will encounter in

CIVIL ENGINEERING PROGRAM CHART

This chart summarizes course and scheduling recommendations

First Year/ Sophomore	MATHEMATICS AND SCIENCE (4 units minimum required)							
	Differential and Integral Calculus	Differential Equations	Statistics	Probability	Chemistry	Physics	Additional Science	Math/Science Elective
	4/3 unit	1/3 unit	1/3 unit	1/3 unit	2/3 unit	1/3 unit	1/3 unit	1/3 unit
	MA 1021 (or 1020) MA 1022 MA 1023 MA 1024	MA 2051	MA 261	MA 2621	CH 1010 CH1020	PH 1110 (or 1111)	GE or BB	MA, CH, PH, GE, or BB
	HUMANITIES AND ARTS (2 units minimum required)							
	SOCIAL SCIENCE (2/3 units minimum required)							
Junior	IQP (1 unit minimum required)							
Anytime	PHYSICAL EDUCATION (2 units minimum required)							

First Year/ Sophomore	ENGINEERING SCIENCE AND DESIGN (6 units minimum required; 4 units minimum required in Civil Engineering)							
	Engineering Science	CE 1030, CE 2000, CE 2001, CE 2002, CE 2020, ES 2503, ES 2800, ES 3004						
Junior/ Senior	Computer Applications	CE 3030, CE 3031						
	Outside of CE	2001, ED3001, ECE 2010, or other 2000-level or above engineering course						
	Civil Engineering	Subareas	Structural	Geotechnical	Environmental and Hydraulics	Urban and Environmental Planning	Transportation	Construction Engineering and Project Management
		Courses	CE 3010 CE 3006 CE 3008 CE 4007 CE 4017	CE 3041 CE 3044	CE 3059 CE 3060 CE 3061 CE 3062 CE 4061 CE/CH 4063 CE 4600	CE 3070 CE 3074 CE 4071	CE 3050 CE 3051	CD 3020 CD 3022 CD 3025
		Labs	CE 3026		CE 4060		CE 4054	CE 3024
	MQP	Project in areas of interest, including capstone design						
Anytime	ELECTIVES (1 unit)							

their post-graduate pursuits. Project activities can include a combination of design, construction planning, sponsored research, laboratory investigations, field work, and internship activities with governmental agencies and private industry. Students should plan their Major Qualifying Project activity during the junior year, in consultation with a faculty advisor. The MQP should include analysis of a comprehensive civil engineering problem, consideration of alternative solutions, and optimization of a solution. A major objective of the MQP is the development of sound engineering judgment, incorporating engineering economics and social factors into problem solving.

Each civil engineering student must complete a capstone design experience which draws on past course work, involves significant engineering design, and relates to the practice of civil engineering. Normally, this is accomplished as part of the MQP. At the time of registration for the MQP, the project advisor indicates whether the project meets the capstone requirement. If not, the advisor will provide an additional 1/3 unit of capstone design (not MQP) work to meet the requirement. Alternatively, another MQP which meets the requirement could be selected.

FUNDAMENTALS OF ENGINEERING EXAM

The first step to becoming a licensed professional engineer is passing the Fundamentals of Engineering (FE) exam. Licensure is used to ensure public safety by requiring practicing consultants to demonstrate their qualifications based on education, experience, and examinations, including the FE exam. Engineers who attain licensure enjoy career benefits that allow them to offer consulting services and rise to positions of responsibility. All Civil Engineering majors are strongly encouraged to take the FE exam during their senior year. The exam is offered year-round.

COMBINED BACHELOR/MASTER'S PROGRAM

Continued studies beyond the bachelor's degree are valuable for career advancement and professional engineering licensure. Combined Bachelor/Master's degree programs offer the advantage of double-counting up to 12 credits, including up to six credits of advanced coursework (4000-level) at the undergraduate level, for both the Bachelor's and Master's degree requirements. Specific CEE requirements and more information can be obtained at the Civil and Environmental Engineering Department office. Programs leading to the Master of Science and Master of Engineering are available. Students should consult with their academic advisor to discuss program options, admission requirements, and course planning.

COMPUTER SCIENCE

C. E. WILLS, HEAD

C. RUIZ, ASSOCIATE HEAD

PROFESSORS: E. Agu, M. Claypool, D. J. Dougherty, M. A. Gennert, N. Heffernan, E. A. Rundensteiner, G. N. Sarkozy, C. E. Wills, J. Xiao

ASSOCIATE PROFESSORS: J. E. Beck, M. Y. Eltabakh, G. T. Heineman, D. Korkin, C. Ruiz, C. A. Shue

ASSISTANT PROFESSORS: B. Calli, L. De Carli, L. Fichera, T. Guo, L. T. Harrison, X. Kong, K. Lee, Y. Li, C. Pinciroli, D. Reichman, C. Roberts, G. Smith, E. Solovey, R. J. Walls, J. R. Whitehill, A. Yousefi

RESEARCH PROFESSORS: J. Guttman, C. L. Sidner

ASSOCIATE TEACHING PROFESSOR: R. Neamtu

ASSISTANT TEACHING PROFESSORS: M. Engling, T. Smith, J. Weinstock, W. Wong

INSTRUCTOR: J. M. Cuneo

PROFESSORS EMERITUS: D. C. Brown, D. Finkel, M. Hofri, R. E. Kinicki, K. A. Lemone, S. M. Selkow

ASSOCIATED FACULTY: S. Barton (HU), A. Lammert (BME), W. Martin (MA), W. Michalson (ECE), C. Ngan (DS), R. Paffenroth (MA), K. Pahlavan (ECE), C. Putnam (RBE), H. Zhang (BME)

MISSION STATEMENT

The mission of the Computer Science Department at WPI is to provide outstanding education to its undergraduate and graduate students in accordance with the principles of the WPI mission, to advance scholarship in key domains of the computing sciences, and to engage in activities that improve the welfare of society and enhance the reputation of WPI. The Department aims to maintain an environment that promotes innovative thinking, values mutual respect and diversity, encourages and supports scholarship, instills ethical behavior, and engenders life-long learning.

PROGRAM EDUCATIONAL OBJECTIVES

In support of its goals and mission, the WPI Computer Science undergraduate program's educational objectives are to graduate students who will

- achieve professional success due to their mastery of Computer Science theory and practice;
- become leaders in business, academia, and society due to a broad preparation in mathematics, science & engineering, communication, teamwork, and social issues;
- pursue lifelong learning and continuing professional development;
- use their understanding of the impact of technology on society for the benefit of humankind.

PROGRAM OUTCOMES

Based on the educational objectives, the specific educational outcomes for the WPI Computer Science undergraduate program are that by the time of graduation CS majors will have achieved

1. an understanding of programming language concepts;
2. knowledge of computer organization;
3. an ability to analyze computational systems;

4. knowledge of computer operating systems;
5. an understanding of the foundations of computer science;
6. an understanding of software engineering principles and the ability to apply them to software design;
7. an understanding of human-computer interaction;
8. completion of a large software project;
9. knowledge of advanced computer science topics;
10. an understanding of mathematics appropriate for computer science;
11. knowledge of probability and statistics;
12. an understanding of scientific principles;
13. an ability to design experiments and interpret experimental data;
14. an ability to undertake independent learning;
15. an ability to locate and use technical information from multiple sources;
16. an understanding of professional ethics;
17. an understanding of the links between technology and society;
18. an ability to participate effectively in a class or project team;
19. an ability to communicate effectively in speech;
20. an ability to communicate effectively in writing.

Program Distribution Requirements for the Computer Science Major

The normal period of residency at WPI is 16 terms. In addition to the WPI requirements applicable to all students (see page 7), the program distribution requirements for the Computer Science major include computer science, mathematics, and basic science and/or engineering science as follows:

COMPUTER SCIENCE	MINIMUM UNITS
1. Computer Science (including the MQP) (Notes 1, 2).	6
2. Mathematics (Notes 2, 3, 5).	7/3
3. Basic Science and/or Engineering Science (Notes 2, 4).	5/3

NOTES:

1. a. Only CS 1101, CS 1102 and computer science courses at the 2000-level or higher will count towards the computer science requirement. CS 2119 will not count towards the computer science requirement.
- b. Must include at least 1/3 unit from each of the following areas: Systems (CS 3013, CS 4513, CS 4515, CS 4516), Theory and Languages (CS 3133, CS 4120, CS 4123, CS 4533, CS 4536), Design (CS 3041, CS 3431, CS 3733, CS 4233), and Social Implications of Computing (CS3043, GOV/ID 2314, GOV/ID 2315, IMGD 2000, IMGD 2001, RBE 3100). (If GOV/ID 2314, GOV/ID 2315, IMGD 2000, IMGD 2001 or RBE 3100 is used to satisfy this requirement, it does not count as part of the 6 units of CS.)
- c. At least 5/3 units of the Computer Science requirement must consist of 4000-level or graduate CS courses, except for CS 5007.
- d. Any of the following graduate courses (when used as described in Note 1c) can be used to satisfy the undergraduate Theory and Languages area requirement: CS 5003, CS 5084, CS 503, CS 536, CS 544, or CS 584. Any of the following graduate courses (when used as stated in Note 1c) can be used to satisfy the undergraduate Systems area requirement: CS 502, CS 533, or CS 535.

Any of the following graduate courses (when used as stated in Note 1c) can be used to satisfy the undergraduate Design area requirement: CS 509, CS 542, CS 546, CS 561, or CS 562.

- e. Only one of CS 1101 and CS 1102 may count towards the computer science requirement. Only one of CS 2301 and CS 2303 may count towards the computer science requirement. Only one of CS 2102, CS 210X, and CS 2103 may count towards the computer science requirement.
2. A cross-listed course may be counted toward only one of areas 1, 2, 3, above.
3. Must include at least 1/3 unit from each of the following areas: Probability (MA 2621, MA 2631) and Statistics (MA 2611, MA 2612).
4. Courses satisfying the science requirement must come from the BB, BME, CE, CH, CHE, ECE, ES, GE, ME, PH, or RBE disciplines. At least three courses must come from BB, CH, GE, or PH, where at least two courses are from one of these disciplines.
5. At most four 1000-level Mathematics courses may be counted towards this requirement.

ADDITIONAL ADVICE

For additional advice about course selections, students should consult with their academic advisor or the Computer Science Department Web site (<http://www.cs.wpi.edu/Undergraduate/>).

INDEPENDENT STUDY

Independent study and project work provide the opportunity for students, working under the direction of faculty members, to study or conduct research in an area not covered in courses or in which the students require a greater depth of knowledge. The background required of a student for independent study work depends on the particular area of study or research.

PROJECT OPPORTUNITIES

Off-campus major qualifying projects are available at several project centers including the Budapest Project Center, the Lincoln Laboratory Project Center, the Japan Project Center, the Microsoft-Cambridge Project Center, and the Wall Street Project Center.

Projects are also available on campus, both to support the on-going research activities of the faculty and to expand and improve the applications of computers for service, education, and administration.

Additionally, the department supports IQPs in a number of areas.

ADVANCED PLACEMENT

Advanced placement in computer science can be earned for the "Computer Science AP A" exam. Credit for CS 1000 is granted for scoring a "4" or "5" on the CS AP A exam. No credit will be granted for "Computer Science AP Principles" exam.

The Computer Science department advises CS Majors who earn a "4" or a "5" on the CS AP A exam to enroll in CS 1102 (Accelerated Introduction to Program Design). Students who wish to pursue a CS Minor after earning a "4" or a "5" on the CS AP A exam may consider enrolling in CS 2119 (Application Building with Object-Oriented Concepts) or CS 2301 (Systems Programming for Non-Majors).

Students who took CS AP Principles exam and have substantial programming experience should consult with the CS course instructors as to which course to take.

COMPUTER SCIENCE COURSES FOR MAJORS FLOW CHART

Note: The chart does not specify dependencies with non-CS courses; consult the catalog. For dependencies on non-major CS courses and for CS minors, see the next chart.

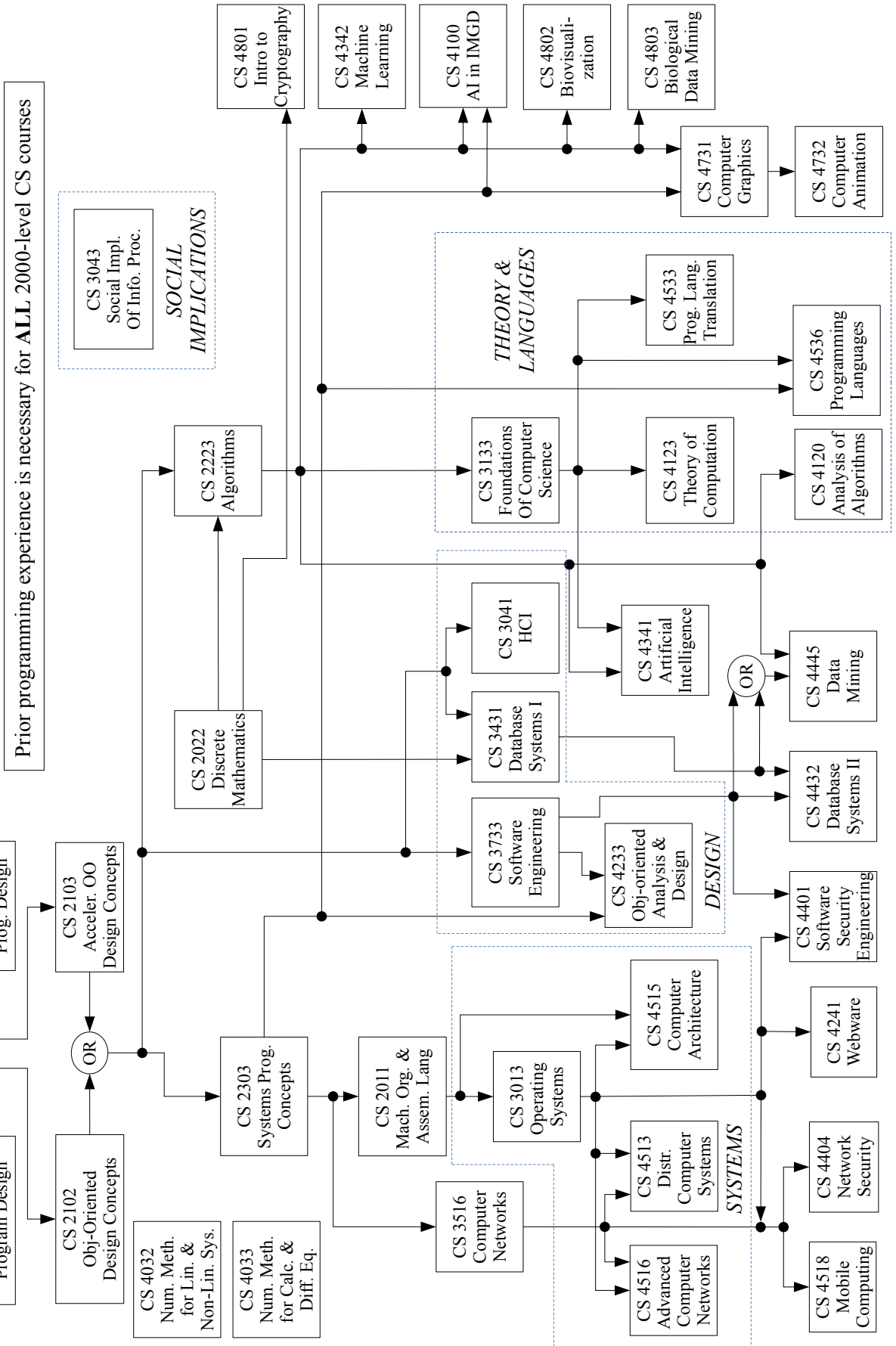

MINOR IN COMPUTER SCIENCE

The Minor in Computer Science will consist of 2 units from Computer Science, with no more than one course at the 1000-level. The 2 units must include at least 1/3 unit CS at the 3000-level or above; however, CS 3043, CS 4032, and CS 4033 cannot be used for a CS minor. Alternatively, 1/3 unit of another activity, for example an ISU that has been validated by the CS faculty instructor as a capstone, can substitute for this requirement.

The Computer Science Department has an advisor for CS Minors, who can be reached at minoradvisor@cs.wpi.edu. Students are required to consult with the CS Minor Advisor before declaring the CS Minor. Majors in Computer Science do not qualify for a Minor in Computer Science. Students should review the Operational Rules of the Minor at WPI to avoid problems with double counting CS courses.

For general policy on the Minor, see the description on page 11.

COMPUTER SCIENCE CONCENTRATIONS

Students pursuing the CS major may, at their option, choose to focus in the following topic of concentration:

- Cyber Security

Cyber Security Concentration

Students taking the Cyber Security Concentration must:

1. Satisfy 2/3 units in core Cyber Security classes from:
 - a. Software Security Engineering (CS 4401)
 - b. Tools and Techniques in Computer Network Security (CS 4404)
 - c. Introduction to Cryptography and Communication Security (CS 4801/ECE 4802)
 - d. Other Cyber Security-specific courses subject to program approval

COMPUTER SCIENCE PROGRAM CHART

COMPUTER SCIENCE Minimum 18/3 <div style="border: 1px solid black; padding: 5px; margin: 5px 0;"> <p style="text-align: center;">CORE COURSES</p> <p style="text-align: center;">CS 1101 or CS 1102, CS 2011, CS 2022, CS 2102, CS 2223, CS 2303, CS 3013, CS 3041, CS 3043, CS 3133, CS 3733</p> <p style="text-align: center;">Note: Not all of the Core Courses are required for the BS degree; see the program distribution requirements</p> </div> <div style="border: 1px solid black; padding: 5px; margin: 5px 0;"> <p style="text-align: center;">SYSTEMS—Minimum 1/3</p> <p style="text-align: center;">CS 3013, CS 4513, CS 4515, CS 4516</p> </div> <div style="border: 1px solid black; padding: 5px; margin: 5px 0;"> <p style="text-align: center;">THEORY AND LANGUAGE—Minimum 1/3</p> <p style="text-align: center;">CS 3133, CS 4120, CS 4123, CS 4533, CS 4536</p> </div> <div style="border: 1px solid black; padding: 5px; margin: 5px 0;"> <p style="text-align: center;">DESIGN—Minimum 1/3</p> <p style="text-align: center;">CS 3041, CS 3431, CS 3733, CS 4233</p> </div> <div style="border: 1px solid black; padding: 5px; margin: 5px 0;"> <p style="text-align: center;">SOCIAL IMPLICATIONS—Minimum 1/3</p> <p style="text-align: center;">CS 3043, GOV/ID 2314, GOV/ID 2315, IMGD 2000, IMGD 2001, RBE 3100 CS 3043 counts toward the 18/3 CS units required for major</p> </div> <div style="border: 1px solid black; padding: 5px; margin: 5px 0;"> <p style="text-align: center;">ADVANCED LEVEL COURSES—Minimum 5/3</p> </div> <div style="border: 1px solid black; padding: 5px; margin: 5px 0;"> <p style="text-align: center;">COMPUTER SCIENCE MQP—Minimum 3/3</p> </div>
SCIENCE Minimum 5/3 Any BB, BME, CE, CH, CHE, ECE, ES, GE, ME, PH, or RBE courses. At least three courses must come from BB, CH, GE, or PH, where at least two courses are from one of these disciplines.
MATHEMATICS Minimum 7/3 At most four 1000-level Mathematics courses. May include CS 2022, CS 4032, or CS 4033 if not used to satisfy the CS requirements. <div style="border: 1px solid black; padding: 5px; margin: 5px 0;"> <p style="text-align: center;">STATISTICS—Minimum 1/3</p> <p style="text-align: center;">MA 2611, MA 2612</p> </div> <div style="border: 1px solid black; padding: 5px; margin: 5px 0;"> <p style="text-align: center;">PROBABILITY—Minimum 1/3</p> <p style="text-align: center;">MA 2621, MA 2631</p> </div>

2. Satisfy 1/3 units in courses discussing societal impacts of security from one of:
 - a. Cyberlaw and Policy (GOV 2314)
 - b. Social Implication of Information Processing (CS 3043)
 - c. Other Cyber Security-related societal impacts courses subject to program approval
 3. Satisfy 3/3 units in additional courses from:
 - a. Operating Systems (CS 3013)
 - b. Computer Networks (CS 3516)
 - c. Advanced Computer Networks (CS 4516)
 - d. Distributed Computing Systems (CS 4513)
 - e. Mobile and Ubiquitous Computing (CS 4518)
 - f. Any of the core Cyber Security courses listed above that are not used to meet the core requirement
 - g. Other Cyber-Security-related courses subject to program approval
 4. Complete a Cyber Security-related Major Qualifying Project, subject to program approval
- Graduate courses may be counted towards the Cyber Security concentration at the discretion of the program.

COMPUTER SCIENCE COURSES FOR NON-MAJORS FLOW CHART

*Note: *The starred courses are designed for non-majors in need of computing preparation.*

They also provide needed background for specific CS-majors courses, as shown.

The courses CS 2102 & CS 2303 can be substituted for CS 2119 & CS 2301, respectively.

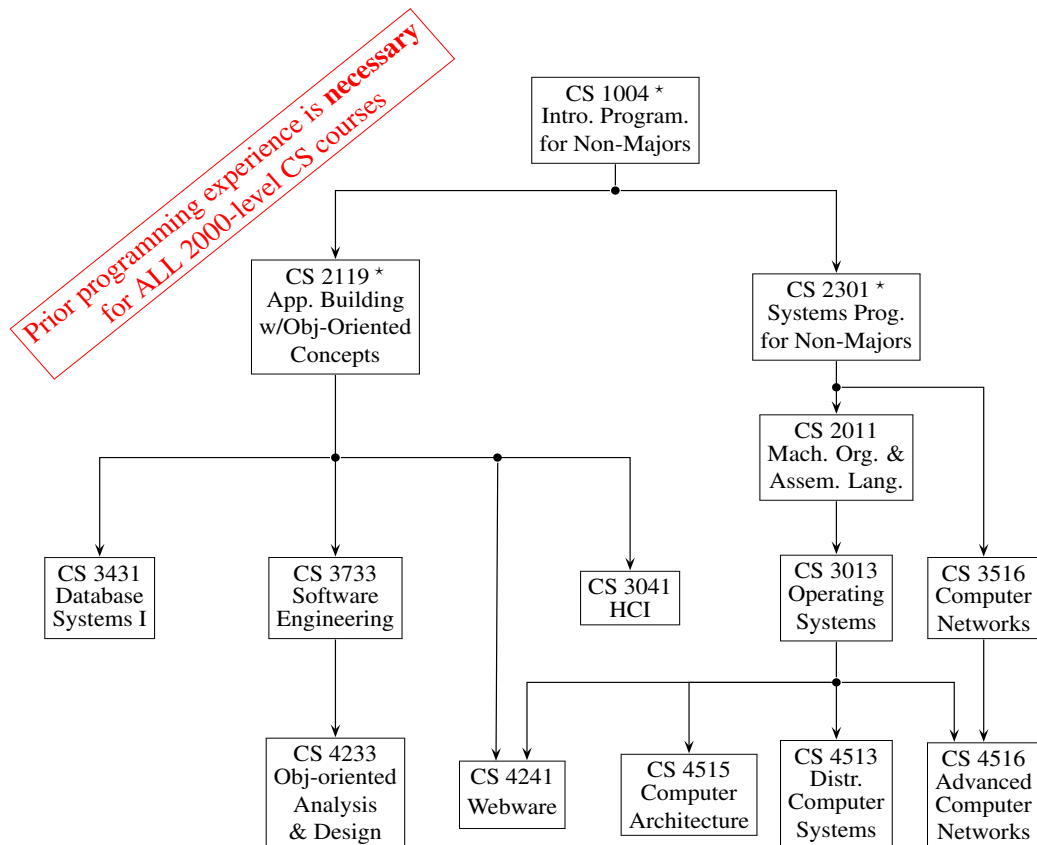

The Computer Science Courses for Non-Majors flowchart shows Computer Science courses that are particularly appropriate for students in need of computing preparation, but who are NOT majoring in Computer Science or one of its closely related fields. Consult the distribution requirements of each major to see the recommended CS courses for that major.

Please note: The three courses marked with an asterisk (i.e. CS 1004, CS 2119, and CS 2301) are less intense than the corresponding courses for Computer Science majors (CS 1101/1102, CS 2102/CS2103, and CS 2303, respectively). However, they do provide sufficient background for the CS courses shown on this chart.

This chart shows the most common sequence. However, non-majors are free to choose the courses for CS majors instead. That is, CS 1101 or CS 1102 can substitute for CS 1004; CS 2102, CS 210X, or CS 2103 can substitute for CS 2119; and CS 2303 can substitute for CS 2301.

DATA SCIENCE

E. A. RUNDENSTEINER, PROGRAM DIRECTOR

PROFESSORS: E. T. Loiacono, E. A. Rundensteiner,
D. M. Strong, S.A. Zekavat

ASSOCIATE PROFESSORS: M. Y. Eltabakh, R. Paffenroth,
C. Ruiz, A. Trapp, J. Zou

ASSISTANT PROFESSORS: L. T. Harrison, X. Kong,
N. Kordzadeh, K. Lee, Y. Li, O. Mangoubi

ASSOCIATE TEACHING PROFESSOR: F. Emdad

ASSISTANT TEACHING PROFESSOR: C.K. Ngan

MISSION STATEMENT

Data Science prepares WPI undergraduates with the skills to understand, apply and develop models, algorithms and statistical techniques to gather huge amounts of data, draw new insights from it, and formulate appropriate action plans. Through courses and hands-on project work, students in the Data Science program will master foundational and advanced topics, including state-of-the-art data analytic technologies like machine/deep learning, artificial intelligence, and big data. This prepares the student to tackle the most critical data challenges in interdisciplinary teams with diverse perspectives in this increasingly digital world from climate change, self-driving cars, digital healthcare, to social justice. In addition to being a discipline in and of itself, Data Science complements many of the existing undergraduate majors at WPI. Disciplines from the sciences to engineering increasingly grapple with large data sets using computational and statistical techniques and tools.

Students interested in Data Science, both majors and minors, should check with the Data Science program as early as possible in their academic career to develop a plan of study. Students will be assigned a Data Science advisor after completing a major/minor declaration form.

PROGRAM EDUCATIONAL OBJECTIVES

In support of its goals and mission, the WPI Data Science undergraduate program's educational objectives are to graduate students who will:

- Bring together a community of diverse disciplinary backgrounds and experiential perspectives to promote creative solutions to critical real-world problems and advance knowledge at the cutting edge
- Achieve professional success due to their mastery of Data Science theory and practice
- Conduct impactful research and project work in data sciences tackling the world's most challenging problems
- Engage in discovery through purpose-driven project-based learning
- Collaborate with partners both internally and externally in interdisciplinary projects
- Become leaders in business, academia, and society due to a broad preparation in data science, computational thinking, mathematics, science & engineering, communication, and social issues
- Pursue lifelong learning and continuing professional development
- Use their understanding of the impact of data science on society for the benefit of humankind

Theme:

"Gather Information, Form Insights, Impact the World!"

PROGRAM OUTCOMES

Students graduating with a Bachelor of Science degree in Data Science:

- Have mastered foundational studies in business, computer science, and mathematical sciences
- Have mastered advanced principles and techniques in at least one of the three disciplines
- Can apply computational and mathematical knowledge to the solution of big data problems
- Can communicate effectively across disciplines both verbally and in writing
- Can locate, read, and interpret primary literature in data science
- Can function effectively as members of an interdisciplinary team
- Have an understanding of accepted standards of ethical and professional behavior
- Have the ability to be a life-long independent learner

Program Distribution Requirements for the Data Science Major

The distribution requirements for the BS degree in Data Science consists a series of interdisciplinary courses in Data Science, fundamental courses in Computer Science, Mathematical Sciences, and Business, and a set of more advanced courses selected primarily from the three supporting disciplines: Computer Science, Mathematical Sciences, and/or Business.

REQUIREMENTS	MINIMUM UNITS
1. Data Science Core Courses (Note 1)	3/3
2. Business (Note 2)	2/3
3. Computer Science (Note 3)	3/3
4. Mathematical Sciences (Note 4)	5/3
5. Data Privacy and Ethics (Note 5)	1/3
6. Natural or Engineering Sciences (Note 6)	2/3
7. Disciplinary Elective Courses (Note 7)	11/3
8. MQP (Note 8)	3/3

NOTES:

1. Students must complete the series of three DS core courses (DS 1010, DS 2010, and DS 3010)
2. Business foundation courses must include 1/3 unit in entrepreneurship and innovation, and 1/3 unit in business analysis:
 - One of BUS 1010, ETR 1100, BUS 3010, ETR 3633
 - One of BUS 2080 or OIE 2081
3. Computer science foundation courses must include 2/3 units of introductory computer science (with no more than 1/3 unit at the 1000 level) and 1/3 unit of algorithms. CS elective courses at level of 3000 and above as defined in Note 7 may substitute for introductory computer science credits.
 - Two of CS 1004, 1101, 1102, CS 2102, CS 2103, CS 2119, or CS elective courses below.
 - One of CS 2223
4. Mathematics foundation courses must include 2/3 units calculus, 2/3 units applied statistics, and 1/3 unit linear algebra. Mathematics disciplinary elective courses as defined in Note 7 may substitute for introductory calculus credits.
 - Two of MA 1020, MA 1021, MA 1022, MA 1120, or disciplinary elective courses in MA as per Note 7. (Students cannot take both MA 1020 and

MA 1021 for credits. Students cannot take both MA 1022 and MA 1120 for credits.)

Both MA 2611, MA 2612

One of MA 2071, MA 2072

5. Data Privacy and Ethics. Choose 1/3 unit from among the following:

CS 3043

GOV 2313, GOV 2314, GOV 2315, GOV 2320

PY 2713, PY/RE 2731

RBE 3100

6. 2/3 units of work chosen in Natural or Engineering Science (courses with prefixes AE, AREN, BB, BME, CHE, CE, CH, ECE, ES, GE, ME, PH or RBE count).

7. Chosen from disciplinary elective courses in CS, MA, or BUS listed below.

At least one course must be selected from each of the following categories:

- Data access and management (CS 3431, MIS 3720, CS 4432, CS4433/DS4433)
- Data mining/machine learning (CS 4445, CS 4342)
- Business modeling and prediction (MIS 4084, OIE 4420)
- Disciplinary electives must include at least 4/3 units at the 4000 level or above.

8. Data Science MQP projects must have a MQP faculty advisor that has a formal collaborative appointment in the Data Science program.

Disciplinary Elective Courses in CS:

CS 2022	Discrete Mathematics
CS 2301	Systems Programming For Non-Majors
CS 2303	Systems Programming Concepts
CS 3133	Foundations of Computer Science
CS 3733	Software Engineering
+CS 3431	Database Systems I
CS 3041	Human-Computer Interaction
CS 4120	Analysis of Algorithms
+CS 4341	Introduction to Artificial Intelligence
+CS 4432	Database Systems II
+CS 4445	Data Mining and Knowledge Discovery in Databases
CS 4803/BCB 4003	Biological and Biomedical Database Mining
+CS 4342/DS 4342	Machine Learning
+CS 4804	Data Visualization
CS 4802/BCB 4002	Bio Visualization
+CS 4433/DS 4433	Big Data Management & Analytics
CS 4233	Object-Oriented Analysis and Design
CS 4241	Webware: Computational Technology for Network Information Systems

Students are encouraged to take elective courses with a (+) prefix.

Disciplinary Elective Courses in MA:

MA 1023	Calculus III
MA 1024	Calculus IV
MA 1033	Theoretical Calculus III
MA 1034	Theoretical Calculus IV

MA 2201	Discrete Mathematics
MA 2051	Ordinary Differential Equations
MA 2073	Matrices and Linear Algebra II
MA 2210	Mathematical Methods in Decision Making
MA 2431	Mathematical Modeling with Ordinary Differential Equations
+MA 2621	Probability for Applications
+MA 2631	Probability (Students cannot take both MA 2621 and MA 2631 for credits)
MA 3231	Linear Programming
MA 3233	Discrete Optimization
MA 3257	Numerical Methods for Linear and Nonlinear Systems
+MA 3627	Introduction to the Design and Analysis of Experiments
+MA 3631	Mathematical Statistics
MA 4213	Loss Models I - Risk Theory
MA 4214	Loss Models II - Survival Models
MA 4235	Mathematical Optimization
MA 4237	Probabilistic Methods of Operations Research
+MA 4603	Statistical Methods in Genetics and Bioinformatics
MA 4631	Probability and Mathematical Statistics I
MA 4632	Probability and Mathematical Statistics II
+MA 4635/DS4635	Data Analytics and Statistical Learning

Students are encouraged to take elective courses with a (+) prefix.

Disciplinary Elective Courses in BUS:

+MIS 3720	Business Data Management
MKT 3650	Consumer Behavior
OIE 3460	Simulation Modeling and Analysis
+MIS 4084	Business Intelligence
MIS 4720	Systems Analysis and Design
MIS 4741	User Experience and Design
+OIE 4420	Practical Optimization: Methods and Applications

Students are encouraged to take elective courses with a (+) prefix.

MINOR IN DATA SCIENCE

MISSION STATEMENT

The Minor in Data Science prepares WPI undergraduates in any major with the skills essential to understand and work with data by applying models, algorithms and statistical techniques to extract, model, analyze and predict data. The minor complements many of the existing undergraduate majors at WPI from sciences to engineering that increasingly must work with large digital data sets using computational and statistical techniques and tools by providing these students with the core competencies of Data Science.

Students interested in the minor should meet with the Data Science minor advisor as early as possible in their academic career to develop a plan of study. They will be assigned a Data Science minor advisor after completing a minor declaration form.

DATA SCIENCE MAJOR PROGRAM CHART

UNIVERSITY REQUIREMENTS	
Minimum Academic Credit	15 Units
Residency	8 Units
Humanities and Arts	6/3 Units
Interactive Qualifying Project	3/3 Unit
Social Science	2/3 Unit
Physical Education	1/3 Unit
Free Electives	3/3 Unit

MAJOR-SPECIFIC REQUIREMENTS (10 UNITS)	
DS Core Courses*	3/3 Unit
Disciplinary Foundation Courses	10/3 Units
Disciplinary Electives	11/3 Units
DS MQP	3/3 Unit
Data Privacy and Ethics	1/3 Unit
Sciences	2/3 Unit

(*) DS core courses include DS 1010, DS 2010, DS 3010.

DISCIPLINARY FOUNDATION COURSES (10/3 UNITS)

COMPUTER SCIENCE COURSES (3/3 Unit Required)	MATHEMATICS COURSES (5/3 Unit Required)	BUSINESS COURSES (2/3 Unit Required)
Two of CS 1004, CS 1101, CS 1102, CS 2102, CS 2103, CS 2119, or from CS electives below (**) AND One of CS 2223	Two of MA 1020, MA 1021, MA 1022, MA 1120, or from MA electives below AND Both MA 2611 and MA 2612 AND One of MA 2071 or MA 2072	One of BUS 1010, ETR1100, BUS 3010, ETR 3633 AND One of BUS 2080 or OIE 2081

(**) At most 1/3 CS unit at the 1000 level.

DISCIPLINARY ELECTIVE COURSES (11/3 UNITS)

COMPUTER SCIENCE COURSES	MATHEMATICS COURSES	BUSINESS COURSES
CS 2022 +CS 4341 CS 2301 CS 4120 CS 2303 +CS 4432 CS 3733 +CS 4445 CS 3041 +CS 4342/DS4342 CS 3133 +CS 4804 +CS 3431 +CS 4433/DS4433 CS 4233 CS 4802/BCB4002 CS 4241 CS 4803/BCB4003	MA 1023 MA 3257 MA 1024 +MA 3627 MA 1033 +MA 3631 MA 1034 MA 4213 MA 2051 MA 4214 MA 2073 MA 4235 MA 2201 MA 4237 MA 2210 +MA 4603 MA 2431 MA 4631 +MA 2621 MA 4632 +MA 2631 +MA4635/DS4635 MA 3231 MA 3233	+MIS 3720 MKT 3650 OIE 3460 +MIS 4084 MIS 4720 MIS 4741 +OIE 4420

Electives must include at least one course in each of the categories below:

- Databases (CS 3431, CS 4432, MIS 3720, CS 4433/DS 4433)
- Data mining/machine learning (CS 4445, CS 4342/DS4342)
- Business modeling and prediction (MIS 4084, OIE 4420)

Electives must include at least 4/3 at the 4000 level or above.

Students are encouraged to take electives marked with a "+".

The **Minor in Data Science** will consist of 2 units, all of which must be selected from the list of approved Data Science major courses. These 2 units must be selected to include the following:

- Three courses, one from each of the three areas (Business, Computer Science, Mathematical Sciences) at the 2000 level or above from the list of disciplinary courses approved for the Data Science major
- At least two courses out of the DS series DS 1010, DS 2010, and DS 3010.
- At least one course at the 3000 level or above selected from the list of disciplinary courses approved for the Data Science major.

The Minor in Data Science is open to all undergraduate majors at WPI. Students majoring in Business, Computer Science, or Mathematical Sciences should consult WPI rules on minors for double-counting courses.

LIST OF APPROVED COURSES FOR THE DATA SCIENCE MINOR

Any graduate course approved for the Data Science graduate program can also be counted towards the Data Science minor. These courses are not repeated here.

Data Science Core Courses:

- DS 1010 Data Science I: Introduction to Data Science
- DS 2010 Data Science II: Modeling and Data Analysis
- DS 3010 Data Science III: Computational Data Intelligence

Business Courses:

- BUS 2080 Data Analysis for Decision Making**
- BUS 3010 Creating Value Through Innovation
- ETR 3633 Entrepreneurial Selling
- MIS 3720 Business Data Management
- MIS 4084 Business Intelligence
- MIS 4720 Systems Analysis and Design
- MIS 4741 User Experience and Design
- MKT 3650 Consumer Behavior
- OIE 2081 Introduction to Prescriptive Analytics**
- OIE 3460 Simulation Modeling and Analysis
- OIE 4420 Practical Optimization: Methods and Applications

Computer Science Courses:

- CS 1004 Introduction to Programming for Non-Majors
- CS 1101 Introduction to Program Design *
- CS 1102 Accelerated Introduction to Program Design *
- CS 2102 Object-Oriented Design Concepts‡
- CS 2103 Accelerated Object-Oriented Design Concepts‡
- CS 2022 Discrete Mathematics
- CS 2119 Application Building with Object-Oriented Concepts
- CS 2223 Algorithms
- CS 2301 Systems Programming for Non-majors
- CS 2303 Systems Programming Concepts

- CS 3041 Human-Computer Interaction
- CS 3133 Foundation of Computer Science
- CS 3431 Database Systems I
- CS 3733 Software Engineering
- CS 4120 Analysis of Algorithms
- CS 4233 Object-Oriented Analysis and Design
- CS 4241 Webware
- CS 4341 Introduction to Artificial Intelligence
- DS/CS 4342 Machine Learning
- CS 4432 Database Systems II
- DS/CS 4433 Big Data Management and Analytics
- CS 4445 Data Mining and Knowledge Discovery in Databases
- CS 4802 Biovisualization
- CS 4803 Biological and Biomedical Database Mining
- CS 4804 Data Visualization

Mathematical Sciences Courses:

- MA 2051 Ordinary Differential Equations
- MA 2071 Linear Algebra
- MA 2072 Accelerated Matrices and Linear Algebra I
- MA 2073 Matrices and Linear Algebra II
- MA 2201 Discrete Mathematics
- MA 2210 Mathematical Methods in Decision Making
- MA 2431 Mathematical Modeling with Ordinary Differential Equations
- MA 2611 Applied Statistics I
- MA 2612 Applied Statistics II
- MA 2621 Probability for Applications†
- MA 2631 Probability Theory†
- MA 3231 Linear Programming
- MA 3233 Discrete Optimization
- MA 3257 Numerical Methods for Linear and Nonlinear Systems
- MA 3627 Introduction to the Design and Analysis of Experiments
- MA 3631 Mathematical Statistics
- MA 4213 Loss Models – Risk Theory
- MA 4214 Loss Models – Survival Models
- MA 4235 Mathematical Optimization
- MA 4237 Probabilistic Methods in Operations Research
- MA 4603 Statistical Methods in Genetics and Bioinformatics
- MA 4631 Probability and Mathematical Statistics I
- MA 4632 Probability and Mathematical Statistics II
- DS/MA 4635 Data Analytics and Statistical Learning

* Credit may not be earned for both CS 1101 and CS 1102

† Credit may not be earned for both MA 2621 and MA 2631

‡ Credit may not be earned for both CS 2102 and CS 2103

** Credit may be earned for both BUS 2080 and OIE 2081

ELECTRICAL AND COMPUTER ENGINEERING

D. R. BROWN, HEAD; R. LUDWIG, ASSOCIATE HEAD

PROFESSORS: D. R. Brown, E. A. Clancy, X. Huang, R. Ludwig, S. Makarov, J. A. McNeil, W.R. Michalson,

K. Pahlavan, P. Schaumont, B. Sunar, R.F. Vaz, A. Wyglinski
ASSISTANT PROFESSORS: S. Bhada, A. Clark, J. Fu, U. Guler, Z. Zhang

ASSISTANT TEACHING PROFESSORS: G. Bogdanov, Y. Doroz, M. Mughal, K. Mus, S. Ramabhotla

ADJUNCT PROFESSORS: G. Prince, G. Noetscher, J. Stander
INSTRUCTOR: S. J. Bitar

EMERITUS PROFESSORS: K. A. Clements, D. Cyganski, J. S. Demetry, A.E. Emanuel, F. J. Looft, J. A. Orr, P. C. Pedersen

ASSOCIATED FACULTY : E. Agu (CS), G. Fischer (ME), C Furlong (ME), M. Gennert (CS), Y. Mendelson (BME), L. Ramdas Ram-Mohan (PH), J. Sullivan (ME), K. Venkatasubramanian (CS)

MISSION STATEMENT

To be prepared for employment as a contributing engineer and/or for graduate-level education, students within the ECE Department receive instruction that is balanced between theory and practice. In fact, much of our curriculum integrates theory and practice within each course. It is common to study new devices and techniques, and then immediately work with these devices/techniques in a laboratory setting. In response to the breadth of ECE, all students work with their academic advisor to develop a broad-based program of study. As with most engineering curricula, ECE study includes a solid foundation of mathematics and science. Discipline-specific study in ECE usually begins early in a student's career — during the second half of the freshman year — with courses providing a broad overview of the entire field. During the sophomore and junior years, students learn the core analysis, design and laboratory skills necessary to a broad range of ECE sub-disciplines. When desired, specialization within ECE occurs during the junior and senior years. In addition, all students complete a major qualifying project (MQP). This project, typically completed in teams during the senior year, is an individualized design or research project that draws from much of the prior instruction. Utilizing the benefit of individualized instruction from one or more faculty members, students develop, implement and document the solution to a real engineering problem. Many of these projects are sponsored by industry, or are associated with ongoing faculty research. These projects form a unique bridge to the engineering profession.

PROGRAM EDUCATIONAL OBJECTIVES

The Electrical and Computer Engineering Department offers a balanced, integrated curriculum strong in both fundamentals and state-of-the-art knowledge. The curriculum embraces WPI's philosophy of education, with a program characterized by curricular flexibility, student project work such as the Interactive Qualifying Project, and active involvement of students in their learning.

The Electrical and Computer Engineering Program seeks to have alumni who:

- are successful professionals who demonstrate in their work a breadth of knowledge in the field of electrical and computer engineering,
- are engaged in graduate study or other forms of lifelong learning;
- are effective contributors in business and society, demonstrating the ability to communicate, work in teams, and understand the broad implications of their work;
- are engaged broadly in both their professional and personal lives, exhibiting effective leadership and informed citizenship.

STUDENT OUTCOMES

Based on the department's educational objectives, students will achieve the following specific educational outcomes within a challenging and supportive environment:

1. An ability to identify, formulate, and solve complex engineering problems by applying principles of engineering, science, and mathematics.
2. an ability to apply engineering design to produce solutions that meet specified needs with consideration of public health, safety, and welfare, as well as global, cultural, social, environmental, and economic factors.
3. an ability to communicate effectively with a range of audiences.
4. an ability to recognize ethical and professional responsibilities in engineering situations and make informed judgments, which must consider the impact of engineering solutions in global, economic, environmental, and societal contexts.
5. an ability to function effectively on a team whose members together provide leadership, create a collaborative and inclusive environment, establish goals, plan tasks, and meet objectives.
6. an ability to develop and conduct appropriate experimentation, analyze and interpret data, and use engineering judgement to draw conclusions
7. an ability to acquire and apply new knowledge as needed, using appropriate learning strategies.

Program Distribution Requirements for the Electrical and Computer Engineering Major

The normal period of residency at WPI is 16 terms. In addition to WPI requirements applicable to all students, students wishing to receive the major designated "Electrical and Computer Engineering" must satisfy certain distribution requirements. These requirements apply to 10 units of study in the areas of mathematics, basic science, and engineering science and design as follows:

REQUIREMENTS	MINIMUM UNITS
1. Mathematics and Basic Science (Notes 1a-1d)	4
2. Engineering Science and Design (ES/D) (including the MQP) (Notes 2a-2g)	6

NOTES:

1. Mathematics and Basic Science:
 - a. Must include at least 7/3 units of math (prefix MA). Mathematics must include differential and integral calculus, differential equations, and probability.
 - b. Must include at least 2/3 units of physics (prefix PH).
 - c. Must include at least 1/3 units of chemistry (prefix CH) or 1/3 units biology (prefix BB).
 - d. Must include an additional 2/3 units of math or basic science (prefixes MA, PH, CH, BB, or GE).
2. Engineering Science and Design (including the MQP):
 - a. Must include at least 5 units at the 2000-level or higher within the Electrical and Computer Engineering area (including the MQP). All courses with prefix ECE at the 2000-level or higher and ES 3011 are applicable to these 5 units.
 - b. The 5 units within the Electrical and Computer Engineering area must include at least 1 unit of courses from these approved Electrical Engineering courses: ECE 2112, ECE 2201, ECE 2305, ECE 2312, ECE 3012 (or ES 3011), ECE 3113, ECE 3204, ECE 3308, ECE 3311, ECE 3500, ECE 501, ECE 3503, ECE 4011, ECE4023, ECE 4305, ECE 4703, ECE 4902, and ECE 4904.
 - c. The 5 units within the Electrical and Computer Engineering area must include at least 2/3 unit of courses from these approved Computer Engineering courses: ECE 2029, ECE 2049, ECE 3829, ECE 3849 and ECE 4801.
 - d. The 5 units within the Electrical and Computer Engineering area must include 1/3 unit of Capstone Design Experience. (This requirement is typically fulfilled by the MQP)
 - e. Must include at least 1/3 unit of computer science (prefix CS), at the 2000-level or above (other than CS 2011, CS 2022, CS 3043 which cannot be applied to this requirement).
 - f. Must include an additional 2/3 unit of engineering science and design at the 2000-level or above, selected from courses having the prefix AE, AREN, BME, CE, CHE, CS (other than CS 2011, CS 2022, CS 3043), ECE, ES, FP, ME, or RBE.

SUBDISCIPLINES WITHIN ECE

Given a solid foundation, the MQP will allow you to demonstrate an in-depth understanding of one or more of the subdisciplines that compose the field of electrical and computer engineering. As a guide to the areas of study that can be investigated in an MQP, the ECE Course Flowchart identifies seven subdisciplines as possible areas for in-depth study leading to an MQP. Note that students should not feel constrained by these area designations — this is only one of many possible ways to organize the diverse field of electrical and computer engineering. Many if not most MQPs will incorporate subject matter from several different subdisciplines. The purpose of this list is to guide students interested in a particular area to coursework within a subdiscipline (Area Courses), relevant courses to choose from outside the subdiscipline (Related Courses), and faculty whose research and MQP advising interests fall within the subdiscipline (Area Consultants).

Robotics

Area Consultants: Fu, Michalson, Wyglinski

Area Courses

ECE 2029	Introduction to Digital Circuit Design
ECE 2049	Embedded Computing in Engineering Design
ECE 3849	Real-time Embedded Systems
ES 3011	Control Engineering I

Related Courses

CS 4341	Artificial Intelligence
ECE 2201	Microelectronics I
ECE 3503	Power Electronics

RBE 1001	Introduction to Robotics
RBE 2001	Unified Robotics I: Actuation
RBE 2002	Unified Robotics II: Sensing
RBE 3001	Unified Robotics III: Manipulation
RBE 3002	Unified Robotics IV: Navigation

Power Systems Engineering

Area Consultants: Mughal, Ramabhotla

Area Courses

ECE 3500	Introduction to Contemporary Electric Power Systems
ECE 3501	Electrical Energy Conversion
ECE 3503	Power Electronics

Related Courses

ES 3001	Introduction to Thermodynamics
ES 3011	Control Engineering I
ME 1800	Manufacturing Science Prototyping and Computer-Controlled Machining
OIE 2850	Engineering Economics

RF Circuits and Microwaves

Area Consultants: Ludwig, Makarov

Area Courses

ECE 2112	Electromagnetic Fields
ECE 3113	RF Circuit Design

Related Courses

MA 4451	Boundary Value Problems
PH 3301	Electromagnetic Theory
PH 3401	Quantum Mechanics I
PH 3504	Optics

Communications and Signal Analysis

Area Consultants: Brown, Clancy, Makarov, Pahlavan, Wyglinski

Area Courses

ECE 2305	Introduction to Communications and Networks
ECE 2312	Discrete-Time Signal and System Analysis
ECE 3308	Introduction to Wireless Networks
ECE 3311	Principles of Communication Systems
ECE 4305	Software-Defined Radio Systems and Analysis
ECE 4703	Real-Time Digital Signal Processing

Related Courses

ES 3011	Control Engineering I
MA 2071	Matrices and Linear Algebra I
MA 2621	Probability for Applications
MA 4291	Applicable Complex Variables

Biomedical Engineering

Area Consultants: Clancy

Area Courses

ECE/BME 4011	Biomedical Signal Analysis
ECE/BME 4023	Biomedical Instrumentation Design

Related Courses

BME 4201	Biomedical Imaging
ECE 2201	Microelectronic Circuits I
ECE 2312	Discrete-Time Signal and System Analysis
ECE 3204	Microelectronic Circuits II

Analog Microelectronics

Area Consultants: Bitar, Guler, Ludwig, McNeill

Area Courses

ECE 2201	Microelectronics I
ECE 3204	Microelectronics II
ECE 4902	Analog Integrated Circuit Design
ECE 4904	Semiconductor Devices

Related Course

ES 3011	Control Engineering I
---------	-----------------------

ELECTRICAL AND COMPUTER ENGINEERING COURSE FLOW CHART

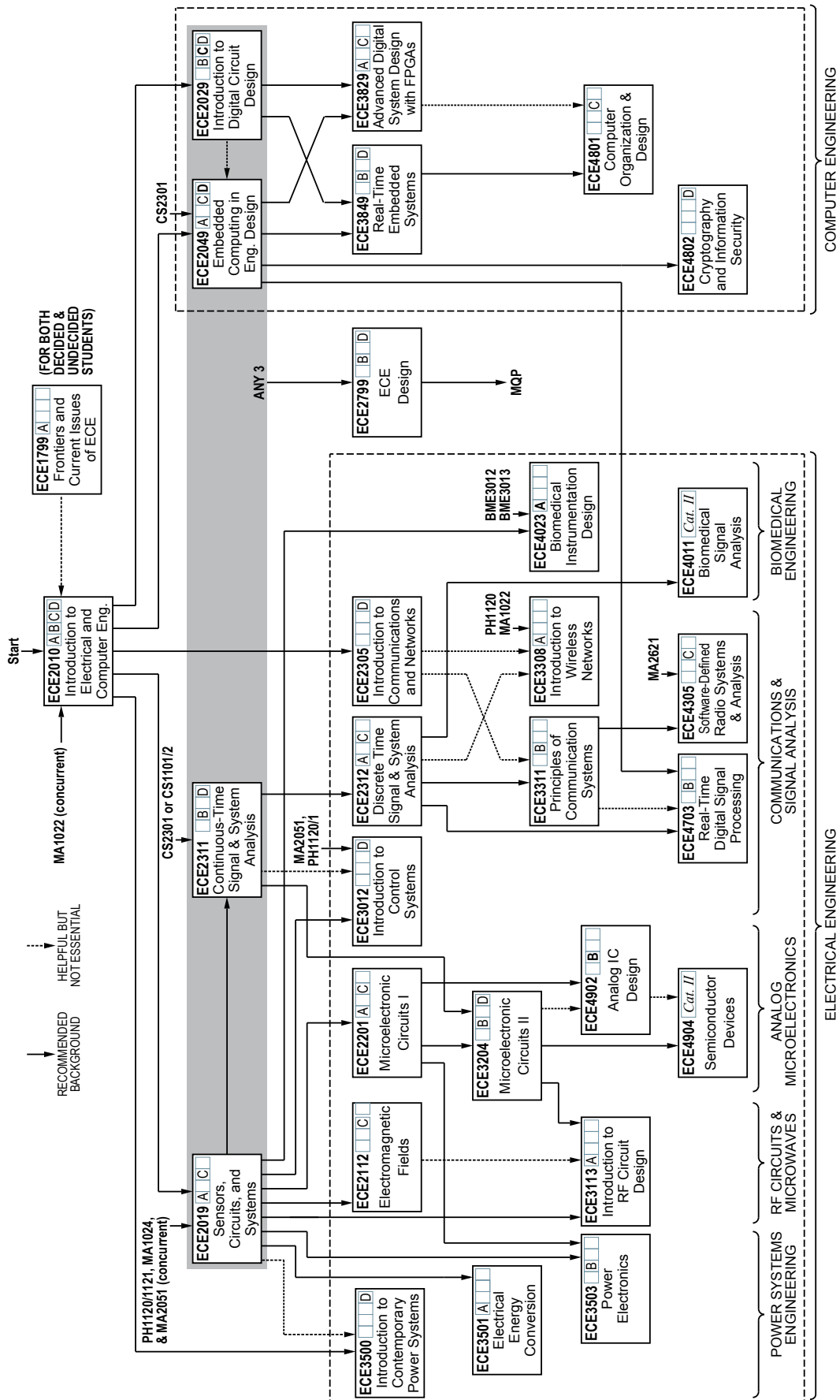

Computer Engineering

Area Consultants: Bogdanov, Clancy, Huang, Looft, Michalson, Sunar

Area Courses

ECE 2029	Introduction to Digital Circuit Design
ECE 2049	Embedded Computing in Engineering Design
ECE 3829	Advanced Digital System Design with FPGAs
ECE 3849	Real-time Embedded Systems
ECE 4801	Computer Organization and Design

Related Courses

ECE 2201	Microelectronics I
CS 2223	Algorithms
CS 3013	Operating Systems
CS 3733	Software Engineering
CS 4515	Computer Architecture
CS 4536	Programming Languages

OVERVIEW OF OTHER PROGRAM COMPONENTS**ENGINEERING SCIENCE AND DESIGN**

Because modern engineering practice is increasingly interdisciplinary, all students achieve some breadth of study outside of the ECE department by taking a minimum of one Computer Science and two Engineering Science and Design courses. These courses must be at the 2000-level or higher, and certain courses with limited technical content are not credited towards this requirement. (See the formal requirements listed previously in the distribution requirements.) Many students find it advantageous to take more than the minimum CS course requirement. CS 2301 is highly recommended for ECE students.

MATHEMATICS AND SCIENCE

To succeed in the study of electrical and computer engineering, the necessary foundation far exceeds what can be taught in a few introductory courses. In fact, if you even want to begin to understand what your ECE professors are talking about in lecture, you must begin with a firm basis in mathematics and the natural sciences. Moreover, whether applied to ECE or not, proficiency in mathematics and the sciences is a necessary quality for any educated engineer. Consequently, the ECE major requires a total of 4 units (12 courses) as the “Mathematics and Basic Science” distribution requirement.

The first part of this requirement is sufficient education in mathematics. At least 7 of the 12 required courses must be in this area, including coursework in differential calculus, integral calculus, differential equations, and probability. To see which specific courses fulfill these math requirements, please consult the mathematics course descriptions, and your academic advisor.

The other part of the requirement is coursework in the sciences. A solid understanding of physics is essential to any ECE student, being ultimately necessary for describing the behavior of electricity and magnetism as well as other physical phenomena. Knowledge of chemistry is useful as well, encompassing such topics as atomic and molecular behavior and the chemical properties of materials (such as silicon, which is quite useful in ECE). In recent years, knowledge of biology has also become important to electrical and computer engineers, particularly as biomedical-electrical technologies such as medical imaging continue to advance.

The ECE major requires at least 3 courses in the sciences, 2 of these courses must be in physics, and the remaining course may be in chemistry or biology depending on preference.

Finally, note that the total prescribed mathematics and science courses add up to 3 1/3 units (10 courses). To meet the distribution requirement, you then must take at least 2 more courses in any area of mathematics or science (that is, any other course with the prefix “MA”, “PH”, “CH”, “BB”, or “GE”).

MINOR IN ELECTRICAL AND COMPUTER ENGINEERING

For students who are not ECE majors and are interested in broadening their exposure to and understanding of electrical and computer engineering, the ECE department offers a Minor. This Minor provides an exciting opportunity to acquire a solid knowledge of electrical and computer engineering as needed in today’s diverse and technology driven society.

Successful candidates for the ECE Minor must meet the following requirements:

1. Complete two units of work from courses with the prefix “ECE” at the 2000-level or above.
2. Of the work in (1), at least 2/3 unit must be from ECE courses at the 3000-level or above which are thematically related.

The ECE minor form, available in the ECE office, lists examples of thematically related courses in different areas of concentration. Students seeking an ECE Minor should complete the ECE Minor form and submit it to the ECE office as early in the program of study as possible. The chair of the ECE curriculum committee will be responsible for review and approval of all ECE Minor requests.

WPI policy requires that no more than one unit of course work can be double counted toward other degree requirements.

ENGINEERING SCIENCE COURSES

In the formation of a program of study for any engineering or science student, it is important to emphasize a significant number of interdisciplinary courses which form the fundamental building blocks of so many scientific and engineering activities.

In addition to those courses in science and mathematics which are an important part of every engineer’s background at WPI, there are a number of courses containing subject matter common to a variety of disciplinary interests. These courses are known as the “engineering science group” and are often taught jointly by members of more than one department.

Every engineer, for example, needs to have some knowledge of graphics, the communications tool of engineering; of thermodynamics, the consideration of an important aspect of energy and its laws; of mechanics, solid and fluid, static and dynamic, the treatment of forces and their effects on producing motion. These and certain other courses of either basic knowledge or broad application are grouped in the engineering science series to provide special focus on them for all students interested in applied science or engineering. In developing programs to meet engineering science distribution requirements, students and advisors should give careful attention to these engineering science courses.

ENVIRONMENTAL ENGINEERING

DIRECTOR: J. BERGENDAHL (CEE)

ASSOCIATED FACULTY: J. Bergendahl (CEE), T. Camesano (CHE), D. DiBiasio (CHE), J. Duddle (CEE), C. M. Eggleston (CEE), S. Kmiotek (CHE), S. LePage (CEE), P. Mathisen (CEE), M. Tao (CEE), H. Walker (CEE)

MISSION STATEMENT

Environmental engineers are challenged not only with mastering technical and scientific principles, but also understanding the broader context within which environmental solutions are implemented. The environmental engineering program encourages coursework in the humanistic and social aspects of engineering decisions, public health management, and environmental preservation. The projects program at WPI offers environmental engineering students a unique opportunity to explore the complex humanistic, economic, legal, and political issues surrounding environmental engineering problems.

The Environmental Engineering degree program prepares students for careers in both the private and public sectors, consulting, industry, and advanced graduate study.

PROGRAM EDUCATIONAL OBJECTIVES

The Program Educational Objectives for the Bachelor degree in Environmental Engineering are that our alumni will:

1. Have successful careers in environmental engineering and related professions, where sound science and engineering principles are applied to solve environmental problems in a socially and ethically responsible manner.
2. Be leaders who are at the forefront of environmental change for the betterment of ecosystems and quality of life.
3. Meet the changing needs of the profession through lifelong learning, such as graduate education, engagement in the profession and organizations, and attainment of professional licensure.

STUDENT OUTCOMES

The Student Outcomes for the Bachelor degree in Environmental Engineering are that all graduates will attain:

1. an ability to identify, formulate, and solve complex engineering problems by applying principles of engineering, science, and mathematics
2. an ability to apply engineering design to produce solutions that meet specified needs with consideration of public health, safety, and welfare, as well as global, cultural, social, environmental, and economic factors
3. an ability to communicate effectively with a range of audiences
4. an ability to recognize ethical and professional responsibilities in engineering situations and make informed judgments, which must consider the impact of engineering solutions in global, economic, environmental, and societal contexts
5. an ability to function effectively on a team whose members together provide leadership, create a collaborative and inclusive environment, establish goals, plan tasks, and meet objectives

6. an ability to develop and conduct appropriate experimentation, analyze and interpret data, and use engineering judgment to draw conclusions
7. an ability to acquire and apply new knowledge as needed, using appropriate learning strategies.

Program Distribution Requirements for the Environmental Engineering Major

The normal period of residency at WPI is 16 terms. In addition to WPI requirements applicable to all students, students wishing to receive the ABET accredited degree designated "Environmental Engineering" must satisfy certain distribution requirements as follows:

REQUIREMENTS	MINIMUM UNITS
1. Mathematics and Basic Science (Note 1)	4
2. Advanced Science (Note 2)	1
3. Engineering Science and Design (Includes MQP) (Note 3)	6

NOTES:

1. Mathematics and Basic Science
 - a. Must include 6/3 units of mathematics, including differential and integral calculus, differential equations, and statistics.
 - b. Must include 6/3 units of basic science, including 1/3 unit of biology (BB), 3/3 units of chemistry (CH), 1/3 unit of earth science (GE 2341 recommended) and 1/3 unit of PH (calculus based).
2. Advanced Science: Must include 3/3 units of science in biology (BB) and chemistry (CH) with a minimum of 1/3 unit in BB and 1/3 unit in CH. Advanced BB courses must be at the 2000-level or higher. Advanced CH courses include CH 1040 and CH courses at the 2000-level or higher. Courses may not be double-counted toward the basic science requirement.
3. Engineering Science and Design
 - a. Must include 2/3 units in thermofluids, including 1/3 unit in fluid mechanics (ES 3004 recommended) and 1/3 unit in thermodynamics (ES 3001, CHE 2013, or CH 3510).
 - b. Must include 2/3 units in mechanics and materials (CE 2000 or ES 2501, CE 2001 or ES 2502, ES 2001, ES 2503).
 - c. Must include 3/3 units of Core Environmental Engineering (CHE 2011, CE 3059, CE 3062, CHE 3201).
 - d. Must include 6/3 units in Environmental Engineering Electives, arranged as follows: 3/3 units in water quality and resources, 2/3 units in air and land environmental systems, and 1/3 unit in environmental management.
 - e. Must include 1/3 unit of environmental health issues (CE 3059, CE 3060, CE 3061, or appropriate experience through IQP, independent study, or appropriate consortium courses).
 - f. Must include 2/3 units with laboratory experimentation. Must include either CE 4060 or CHE 4401. The remaining 1/3 unit may be CE 4060, CHE 4401, laboratory courses in CH (CH 2640 or CH 2650, which would satisfy Advanced Science course requirements), CE 3026, or CE 2020.
 - g. Must include 1/3 unit major design experience through the MQP, or other approved design experience in a course such as CHE 4403 or ME 4429.

For more information, please consult the web site for this major at <http://wpi.edu/academics/eve>

ENVIRONMENTAL ENGINEERING PROGRAM CHART

STUDENTS EARNING AN ABET ACCREDITED BACHELOR DEGREE IN ENVIRONMENTAL ENGINEERING
MUST COMPLETE A MINIMUM OF 15 UNITS OF STUDY, DISTRIBUTED AS FOLLOWS:

MATHEMATICS AND BASIC SCIENCE (4 Units Required)

Differential and integral calculus; differential equations	5/3 units
Statistics (MA 2611 recommended)	1/3 unit
Biology (BB)	1/3 unit
Chemistry (CH)	3/3 units
Earth science (GE 2341 recommended)	1/3 unit
Physics (PH)	1/3 unit

ADVANCED SCIENCE (1 Unit Required)

Must include 3/3 units of science in biology (BB) and chemistry (CH) with a minimum of 1/3 unit in BB and 1/3 unit in CH. Advanced BB courses must be at the 2000-level or higher.
Advanced CH courses include CH 1040 and CH courses at the 2000-level or higher.
Courses may not be double-counted toward the basic science requirement.

ENGINEERING SCIENCE AND DESIGN (6 Units Required;

5 1/3 units as arranged below plus 2/3 units free electives in ES&D at the 2000-level or above).

Please consult the program distribution requirements for detailed information on course requirements and selection.
Project must include 2/3 units with laboratory experimentation.

Engineering Science

Thermofluids	minimum 2/3 units
ES 3001 Introduction to Thermodynamics (or CHE 2013 or CH 3510)	
ES 3002 Mass Transfer	
ES 3004 Fluid Mechanics	

Mechanics and Materials	minimum 2/3 units
CE 2000 Analytical Mechanics I (or ES 2501)	
CE 2001 Analytical Mechanics II (or ES 2502)	
ES 2001 Introduction to Material Science	
ES 2503 Introduction to Dynamic Systems	

Core Environmental Engineering minimum 3/3 units

CHE 2011 Chemical Engineering Fundamentals	
CE 3059 Environmental Engineering	
CE 3062 Hydraulics in Civil Engineering	
CHE 3201 Kinetics and Reactor Design	

Environmental Engineering Electives

Water Quality and Resources	minimum 3/3 units
CE 3060 Water Treatment	
CE 3061 Wastewater Treatment	
CE 4060 Environmental Engineering Laboratory	
CE 4061 Hydrology	

Air and Land Environmental Systems	minimum 2/3 units
CE 3041 Soil Mechanics	
CE 3074 Environmental Analysis	
CE 4600 Hazardous and Industrial Waste Management	
CE/CHE 4063 Transport and Transformations in the Environment	
CHE 4401 Unit Operations of Chemical Engineering I	

Environmental Management	minimum 1/3 unit
CE 3020 Project Management	
CE 3070 Urban and Environmental Planning	
CE 4071 Land Use Development and Controls	

Major Qualifying Project 3/3 units

ADDITIONAL DEGREE REQUIREMENTS (4 units Required)

Humanities and Arts	6/3 units
Social Science‡	2/3 units
IQP	3/3 units
Physical Education	1/3 unit

‡ Many SS courses compliment topics in environmental engineering.
Courses in policy, regulations, law and environmental problems are recommended.

FIRE PROTECTION ENGINEERING

A. SIMEONI, HEAD

PROFESSORS: N. A. Dembsey, A. Rangwala, A. Simeoni

ASSOCIATE PROFESSOR: K. A. Notarianni

ASSISTANT PROFESSOR: J. Urban

PROFESSOR OF PRACTICE: M. Puchovsky

ADJUNCT FPE FACULTY: W. Krein, J. Tubbs, C. Wood,

EMERITUS PROFESSORS: R. W. Fitzgerald, D. A. Lucht,
R. E. Zalosh

ASSOCIATED FACULTY: L. Albano (CEE), J. Liang (ME)

MISSION STATEMENT

To deliver a high quality fire protection engineering education program for both full-time students and practicing professionals, supported by fire research in selected areas of strength.

PROGRAM EDUCATIONAL OBJECTIVES

- To deliver a comprehensive fire protection engineering degree/certificate program that is consistent with changes in technology and the environment.
- To maximize the use of educational technology to deliver for-credit courses to both part time and full time students, on and off campus worldwide.

COMBINED BS/MS DEGREE PROGRAM

A combined-degree program is available for those undergraduate students having a strong interest in fire protection. This program provides students with the opportunity to accelerate their graduate work by careful development of their undergraduate plan of study leading to a Bachelor degree in a field of engineering and a master's degree in fire protection engineering. The combined-degree approach saves time and money since up to 40 percent of course credits counted towards the Master's degree can also be counted toward the Bachelor degree. Holders of a Bachelor degree in traditional engineering or science disciplines and the Master's degree in fire protection engineering enjoy extremely good versatility in the job market.

FIRE PROTECTION ENGINEERING FIVE-YEAR PROGRAM

High school seniors can be admitted to the combined-degree program as freshmen, allowing them to complete both a bachelor's degree in a selected field of engineering followed by the master's degree in fire protection engineering, in a total of five years.

HUMANITIES AND ARTS

K. MONCRIEF, HEAD;

J. COCOLA, D. WEEKS, ASSOCIATE HEADS

PROFESSORS: F. Bianchi, K. Boudreau, J. J. Brattin,
S. C. Bullock, J. deWinter, B. Faber, R. S. Gottlieb, J. P. Hanlan,
P. H. Hansen, K. Moncrief, J. Rudolph, L. E. Schachterle

ASSOCIATE PROFESSORS: S. Barton, C. Clark, J. Cocola,
B. Eddy, M. Ephraim, A. S. Madan, V. Manzo, J. McWeeny,
A. A. Rivera, J. Rosenstock, M. D. Samson, J. Sanbonmatsu,
D. Spanagel

ASSISTANT PROFESSORS: D. DiMassa, H. Droessler,
E. Gutierrez, K. McIntyre, Y. Tellie

PROFESSOR OF PRACTICE: K. Lewis

TEACHING PROFESSORS: L. Higgins, D. Weeks

ASSOCIATE TEACHING PROFESSORS: E. Boucher-Yip,
U. Brisson, J. Cullon, J. Harmon, R. Madan, I. Matos-Nin,
S. Nikitina

ASSISTANT TEACHING PROFESSORS: J. Aguilar,
A. Danielski, L. Davis, W. Du, R. Falco, J. Galante, M. Halpine,
M. Keller, S. Lessing, R. Moody, G. Pfeifer, J. Rohde,
W. San Martín, H. Zheng

ADJUNCT TEACHING PROFESSORS: W. Addison, W. Baller

SENIOR INSTRUCTOR: R. Bigonah

INSTRUCTOR/LECTURERS: M. Brahimi, P. Crowe,
M. El Hamzaoui, D. Giapoudzi, A. Gonzalez

ADJUNCT FACULTY: J. Blumhofer, P. Buono, S. Burton,
J. Duquette, P. Everett, M. Hatch Moysey, D. Ibbett, P. Kirby,
D. Manzo, S. Minichiello, C. Nakajima, D. Olsen, T. O'Malley,
M. Pietrucha, J. Policelli, J. Reinhardt, S. Runstrom, P. Russell,
G. Scott, M. Sethi, A. Shafer, A. Vaudreuil, M. Warren,
B. Wetters, F. Yu

PROFESSORS EMERITUS: W. A. B. Addison, Jr.,
D. B. Dollenmayer, L. Fontanella, E. Hayes, C. Heventhal,
K. P. Ljungquist, J. Manfra, L. Menides, W. T. Mott,
E. M. Parkinson, T. Shannon, R. L. Smith, M. Sokal, S. Vick,
J. Zeugner

MISSION STATEMENT

We are committed to helping students develop both a knowledge of, and an ability to think critically about, the humanities and arts. We also seek to foster the skills and habits of inquiry necessary for such learning: analytical thought, clear communication, and creative expression. Such an education, we believe, provides a crucial foundation for responsible and effective participation in a complex world.

Program Distribution Requirements for the Humanities and Arts Major

REQUIREMENTS	MINIMUM UNITS
1. Humanities and Arts (including MQP) (Note 1)	6
2. Mathematics and Science (Note 2)	2
3. Electives (Note 3)	2

NOTES:

- Humanities and Arts majors may choose to complete 2 units of work and an MQP in one of the following areas of concentration: History, Literature, Music, Philosophy/Religion, Drama/Theatre, Writing and Rhetoric, Art or Art History, German Studies, Hispanic Studies, American Studies, Environmental Studies, or Humanities Studies of Science and Technology. The remaining 3 units of work may be from any area within the Humanities and Arts except that no less than 1 unit should be from an area of Humanities and Arts outside of the area of the student's main concentration.
- Must include 2/3 units in mathematics and 2/3 units in basic science. The remaining 2/3 unit may be from mathematics, basic science or computer science.
- May be from any area except Air Force Aerospace Studies, Military Science, or Physical Education. Courses used to satisfy other degree requirements (i.e. the IQP) may not be used to fulfill this requirement.

CONCENTRATIONS FOR HUMANITIES AND ARTS MAJORS

Humanities and Arts majors may focus their studies by choosing a Concentration within a specific area of the Humanities and Arts, or within an interdisciplinary area closely related to the Humanities and Arts. Concentrations within the Humanities and Arts Department comply with WPI's requirements for Concentrations. Students must complete an MQP and two units of integrated study in the area of their Concentration. Concentrations within the Humanities and Arts (History, Literature, Music, Philosophy, Religion, Drama/Theatre, Writing and Rhetoric, Art History, German Studies, Hispanic Studies) require two units of work in an area designated by specific disciplinary course prefixes, as described below. For example, a Concentration in History requires two units of HI courses at the 2000 level or higher and an MQP in history. Concentrations that are interdisciplinary in nature (American Studies, Environmental Studies, and Humanities Studies of Science and Technology) each require that courses be selected from specific lists of designated courses.

All of these Concentrations are excellent preparation for a variety of careers. Graduates of the Humanities and Arts major have gone to law, business, and medical schools, as well as to graduate programs in the discipline of their Humanities and Arts concentration. Some graduates have pursued careers as writers, teachers, engineers, or scientists. Other students have found work in the theatre as actors, technicians, or playwrights, or in music as composers or performers. The advantages our graduates find in their pursuit of further study and careers are the advantages of a rigorous study of the liberal arts: a good foundation in our cultural traditions and the cultural diversity of the world, and strong skills in research, analysis, writing, or performance.

In addition, since each Humanities and Arts major completes some technical work, either via the Distribution Requirements or a double major in a technical field, our graduates receive unique preparation as technological humanists. This educational

experience gives them a distinct advantage in many fields in which a solid knowledge of engineering or science is increasingly valuable, such as environmental studies, drama/theatre, or business. The Humanities and Arts major equips students with vital general professional skills and with broad cultural and technical perspectives. Our many courses devoted to international issues or to foreign languages and the active involvement of Humanities and Arts faculty in the university's global programs provides superb training for technological humanists interested in international issues. Whatever their specific area of concentration, majors in the Humanities and Arts gain an intellectual curiosity and openness to the diversity of human cultural achievements that will enrich their lives and enhance their careers.

REQUIREMENTS

At least 6 units of work in HUA (see "Note 1" under "Program Distributions Requirements for the Humanities and Arts Major") including the following special requirements for each concentration:

Humanities and Arts with History Concentration

2 units of HI (2000 level or higher) and MQP in History

Humanities and Arts with Literature Concentration

2 units of EN, TH, or RH (2000 level or higher) and MQP in Literature

Humanities and Arts with Music Concentration

2 units of MU (2000 level or higher) and MQP in Music

Humanities and Arts with Philosophy Concentration

2 units of PY (2000 level or higher) and MQP in Philosophy

Humanities and Arts with Religion Concentration

2 units of RE (2000 level or higher) and MQP in Religion

Humanities and Arts with Drama/Theatre Concentration

2 units of TH or EN (2000 level or higher) and MQP in Drama/Theatre

Humanities and Arts with Writing and Rhetoric Concentration

2 units of WR (2000 level or higher) and MQP in Writing and Rhetoric

Humanities and Arts with Art Concentration

2 units of AR or HU and MQP in Art

Humanities and Arts with German Studies Concentration

2 units of GN (2000 level or higher) and MQP in German Studies

Humanities and Arts with Hispanic Studies Concentration

2 units in SP (2000 level or higher) and MQP in Spanish

HUMANITIES AND ARTS WITH AMERICAN STUDIES CONCENTRATION

This interdisciplinary concentration examines American culture from the multiple perspectives of American history, literature, and politics. American Studies at WPI takes advantage of the unparalleled resources at the American Antiquarian Society. American Studies majors (and minors) may earn two-thirds-unit of credit at the 3000-level by being admitted to and completing the competitive AAS fall seminar, which annually accepts twelve Worcester Consortium students. Each spring, HUA faculty publicize the upcoming seminar and endorse WPI applicants. AAS seminars typically enroll two or three students from WPI.

1. 1/3 units: one of the following courses: HU 1411 Introduction to American Studies, EN 1231 Introduction to American Literature, EN 1257 Introduction to African American Literature and Culture, HI 1311 Introduction to American Urban History, HI 1312 Introduction to American Social History, or HI 1314 Introduction to Early American History.
2. 2/3 units from List 1 (“American History”)
3. 2/3 units from List 2 (“American Literature”)
4. 1/3 units from List 3 (“American Politics, Law, and Policy”). This may not include courses taken to fulfill the Social Science Requirement.
5. MQP in American Studies

List 1. American Antiquarian Society Fall Seminar:

This competitive seminar, open to a limited number of Worcester Consortium students, features a different visiting professor and a new thematic focus each fall. The seminar is equivalent to two courses in American Studies at the 3000-level; the comparable WPI discipline(s) will be determined by the topic of each seminar. To apply, consult a member of the American Studies faculty early in the preceding D-term.

List 2. American History:

HI 2310 Topics in Urban History
 HI 2311 American Colonial History
 HI 2313 American History, 1789-1877
 HI 2314 American History, 1877-1920
 HI 2315 The Shaping of Post-1920 America
 HI 2316 Twentieth Century American Foreign Relations
 HI 2318 Topics in Law, Justice and American Society
 HI 2335 Topics in the History of American Science and Technology
 HI 2400 Topics in Environmental History
 HI 2913 Capitalism and Its Discontents
 HI 2930 Topics in Latin American History
 HI 3312 Topics in American Social History
 HI 3314 The American Revolution
 HI 3316 Topics in Twentieth-Century U.S. History
 HI 3317 Topics in Environmental History
 HI 3334 Topics in the History of American Science and Technology
 HI 3344 Pacific Worlds

List 3. American Literature:

EN 2221 American Drama
 EN 2234 Modern American Novel
 EN 2237 American Literature and the Environment
 EN 2271 American Literary Histories
 EN 3238 American Authors
 EN 3231 Supernatural Literatures
 EN 3234 Modern American Poetry
 EN 3271 American Literary Topics
 SP/ID 3531 Contemporary US Latino Literature & Culture

List 4. American Art/Architecture:

AR 2114 Modern Architecture in the American Era, 1750-2001 and Beyond

List 5. American Music:

MU 2719 Jazz History
 MU 2722 History of American Popular Music

List 6. American Philosophy and Religion:

PY/RE 2716 Gender, Race, and Class
 *RE 2721 Religion and Culture
 *RE 3721 Topics in Religion

List 7. American Politics, Law, and Policy:

GOV 1301 U.S. Government
 GOV 1303 American Public Policy
 GOV 1310 Law, Courts, and Politics
 GOV 2302 Science-Technology Policy
 GOV 2310 Constitutional Law

* Check with an American Studies advisor to determine if this course has an American focus in a given term. To facilitate degree audits by the Office of the Registrar, HUA faculty will create a form by which to approve unlisted courses that have significant focus on the U.S. national experience.

HUMANITIES AND ARTS WITH ENVIRONMENTAL STUDIES CONCENTRATION

This interdisciplinary concentration combines course work from the humanities and arts, social sciences, and other areas to examine environmental issues.

1. 3/3 units from List 1 (“Designated Environmental Courses in Humanities”)
2. 2/3 units from List 2 (“Related Environmental Courses in Social Sciences”). These may not include courses taken to fulfill the Social Science Requirement.
3. 1/3 units from List 3 (“Environmental Courses in Other Areas”)
4. MQP in Environmental Studies

List 1. Designated Environmental Courses in Humanities:

AR 2114 Modern Architecture in the American Age
 EN 2237 American Literature and the Environment
 HI 1311 Introduction to American Urban History
 HI 1350 Introduction to Environmental History
 HI 2310 Topics in Urban History
 HI 2400 Topics in Environmental History
 HI 3317 Topics in Environmental History
 HI 3331 Topics in the History of European Science and Technology
 HI 3335 Topics in the History of Non-Western Science and Technology
 HI 3344 Pacific Worlds
 INTL 1100 Introduction to International and Global Studies
 PY 2712 Social and Political Philosophy
 PY 2713 Bioethics
 PY 2717 Philosophy and the Environment
 PY 2719 Philosophy of Science
 PY/RE 2731 Ethics

List 2. Related Environmental Courses in Social Sciences:

DEV 1200 International Development and Society
 DEV 2200 Case Studies in International Development Policy and Engineering
 ECON 2117 Environmental Economics
 ECON 2125 Development Economics
 ENV 1100 Introduction to Environmental Studies
 ENV 2201 Planning for Sustainable Communities
 ENV 2310 Environmental Governance and Innovation
 ENV 2400 Environmental Problems and Human Behavior
 ENV 2600 Environmental Problems in the Developing World
 ENV 2700 Social Media, Social Movements, and the Environment
 ENV 2900 The Green Economy and Models for Alternative Forms of Development
 ENV 3100 Adventures in Sustainable Urbanism
 ENV 4400 Senior Seminar in Environmental Studies
 GOV 2312 International Environmental Policy

List 3. Environmental Courses in Other Areas:

BB 2040 Principles of Ecology
 CE 3059 Environmental Engineering
 CE 3070 Urban and Environmental Planning
 CE 3074 Environmental Analysis
 CE 4060 Environmental Engineering Laboratory
 CE/CHE 4063 Transport & Transformation in the Environment
 CHE 3702 Energy Challenges in the 21st Century
 CHE 3910 Chemical and Environmental Technology
 CHE 3920 Air Quality Management
 ES 2800 Environmental Impacts of Engineering Decisions
 ME 3422 Environmental Issues and Analysis

HUMANITIES AND ARTS WITH HUMANITIES STUDIES OF SCIENCE AND TECHNOLOGY CONCENTRATION

This interdisciplinary concentration enables students to apply the methods of the humanities and social sciences to the study of science and technology.

1. 2/3 units from List 1 (“Designated HSST Courses”)
2. 2/3 units from List 1 or List 2 (“Closely Related Courses in Humanities”)
3. 2/3 units from List 3 (“Science-Technology-Studies Courses in Other Areas”). These may not include courses taken to fulfill the Social Science Requirement.
4. MQP in Humanities Studies of Science and Technology

List 1: Designated HSST Courses

EN 2252 Science and Scientists in Modern Literature
 HI 1330 Introduction to the History of Science and Technology
 HI 1350 Introduction to Environmental History
 HI 2335 Topics in the History of American Science and Technology
 HI 2350 Topics in the History of Science
 HI 2400 Topics in Environmental History
 HI 2913. Capitalism and Its Discontents
 HI 3317 Topics in Environmental History
 HI 3331 Topics in the History of European Science and Technology
 HI 3334 Topics in the History of American Science and Technology
 HI 3335 Topics in the History of Non-Western Science and Technology
 PY 2711 Epistemology
 PY 2713 Bioethics
 PY 2717 Philosophy and the Environment
 PY 2719 Philosophy of Science
 PY/RE 2732 Suffering, Healing & Values

List 2: Closely Related Courses in Humanities

AR 2114 Modern Architecture in the American Era, 1750-2001 and Beyond
 AR 2115 Topics in Architecture since 1960
 AR 3112 Modernism, Mass Culture, and the Avant-Garde
 HI 1311 Introduction to American Urban History
 HI 2310 Topics in Urban History
 HI 2315 The Shaping of Post-1920 America
 HI 2324 The British Empire
 HU 2251 Introduction to Film Studies
 HU 2340 Popular Culture and Social Change in Asia
 INTL 1100 Introduction to International and Global Studies
 INTL 2100 Approaches to Global Studies
 INTL 2910 Topics in Global Studies
 MU 2300 Foundations of Music Technology
 MU/PSY 2501 Music and Mind
 RE 2722 Modern Problems of Belief
 WR 1011 Writing About Science & Technology
 WR 3214 Writing About Disease & Public Health

List 3: Science-Technology-Studies Courses in Other Areas.

AR/ID 3150 Light, Vision and Understanding and the Scientific Community
 FY 1100 The Great Problems Seminar
 CS 3041 Human-Computer Interactions
 CS 3043 Social Implications of Information Processing
 DEV 1200 International Development and Society
 DEV 2200 Case Studies in International Development Policy and Engineering
 ENV 1100 Introduction to Environmental Studies
 ENV 2201 Planning for Sustainable Communities
 ENV 2310 Environmental Governance and Innovation
 ENV 2400 Environmental Problems and Human Behavior
 GOV 2302 Science-Technology Policy
 GOV 2311 Environmental Policy and Law
 GOV 2312 International Environmental Policy
 GOV 2314 Cyberlaw and Policy
 GOV 2315 Privacy: Laws, Policy, Technology and How They Fit Together
 GOV 2319 Global Environmental Politics
 IMGD 1000 Critical Studies of Interactive Media and Games
 STS 1200 Fundamentals of Global Health
 STS 4000 Senior Seminar in Global Public Health

DOUBLE MAJOR IN HUMANITIES AND ARTS

Students may pursue a double major in Humanities and Arts and any area of study at WPI. To pursue the double major, a student must satisfy the degree requirements of both disciplines including an MQP and Distribution Requirements. The double major in Humanities and Arts requires 6 units of studies in the Humanities and Arts, including the MQP and Inquiry Seminar or Practicum. Students interested in pursuing this option should contact Prof. B. Addison, Salisbury Labs, for additional information.

PROFESSIONAL WRITING

DIRECTOR: E. BOUCHER-YIP (HUA)

ASSOCIATE DIRECTOR: K. Lewis (HUA)

ASSOCIATED FACULTY: A. Danielski (HUA), J. deWinter (HUA), B. Faber (HUA & MG), L. Higgins (HUA), S. Lessing (HUA), R. Madan (HUA), A. Rivera (HUA), Y. Telliell (HUA)

The goal of the Professional Writing program is to prepare professionals to communicate scientific or technical content to a variety of specialized and non-specialized audiences in useful and accessible ways.

Professional Writing is an interdisciplinary major or double major that combines work in written, oral, visual, and data-based communication with a strong concentration in a scientific or technical field. Students receive individual attention from academic advisors as they design a plan of study that fulfills the program's distribution requirements and best suits their intellectual interests and career aspirations. Majors can select courses and projects in a variety of areas, such as:

- Science writing, medical writing, health communication
- Writing in the public interest, writing for non-profits
- Digital media, visual communication, information design
- Bilingual professional communication, translation

The Professional Writing major provides excellent preparation for students interested in careers in technical and scientific communication, writing and editing, web authoring,

information design, public relations, medical writing, translation, and intercultural communication. It prepares students for graduate work. Finally, it prepares professionals in scientific or technical fields to be lead communicators in their careers.

MQP opportunities are available on campus and with local companies, newspapers, public agencies, and private foundations. More information about project and career opportunities for Professional Writing majors can be found on the program website: <https://www.wpi.edu/academics/departments/professional-writing>.

Program Distribution Requirements for the Professional Writing Major

REQUIREMENTS	MINIMUM UNITS
1. Scientific and/or technical concentration (Note 1)	6
2. Writing and Rhetoric (WR) concentration (Note 2)	3
3. MQP (Note 3)	1

NOTES:

- The student's scientific and/or technical concentration must be a plan of study, approved by the student's program review committee, with a clear underlying rationale in mathematics, basic science, computer science, engineering, and/or business.
- The Writing and Rhetoric concentration consists of 3 units from the 2 following categories.
 - Writing and Rhetoric (2 units)** from any of the existing WR courses or equivalent ISUs. This must include WR 3112: Rhetorical Theory unless a substitution is authorized by the student's program review committee, which will be granted only under unusual circumstances. No more than one course at the 1000-level can be applied, and students must complete at least one 4000-level course in WR.
 - Electives (1 unit)**
The 1 unit of electives must be coherently defined and approved by the student's program review committee. Students may draw on:
 - Courses in Writing and Rhetoric not used to fulfill the above 2 units requirement;
 - Courses in science, technology, and culture studies (such as AR/ID 3150, CS 3041, CS 3043, EN 2252, HI 2334, HI 2402, HI 3331, HI 3333, HI 3334, IMGD 2000, IMGD 2001, GOV 2302, PSY 2406;
 - Philosophy and ethics courses (such as PY 2711, PY 2713, PY 2714, PY 2716, PY 2717, PY/RE 2718, PY/RE 2731);
 - Foreign language courses;
 - Business courses (such as BUS 2080, BUS 3010, BUS 4030, OBC 3354, OIE 3420, OBC 4367, MIS 3720, MIS 3787, MIS 4781).
- The MQP should build on the student's scientific and technical concentration while articulating a problem within professional writing.

HUMANITIES AND ARTS MINORS

Minors can be arranged in areas other than the above. See a professor in the appropriate discipline for further information about minors in other areas and interdisciplinary minors.

AMERICAN STUDIES

The Minor in American Studies is for students who choose to continue their studies in a blend of American history, literature, and other fields beyond the Humanities and Arts Requirement without majoring in American Studies, English, history, or other fields in humanities and arts.

The American Studies Minor consists of a total of two units of coursework in Humanities and Arts that focus on *the national experience of the United States*, distributed in the following way: at least two courses in American history (List 2) and at least two in American literature (List 3), except that HUA 1411 (Introduction to American Studies) may be substituted for either an EN or an HI course. The two units comprising the American Studies Minor must include a minimum of two 3000-level courses and a maximum of one 1000-level course.

American Studies Minors may earn two-thirds-unit of credit at the 3000-level by being admitted to and completing the competitive American Antiquarian Society fall seminar, which annually accepts twelve Worcester Consortium students. Each spring, HUA faculty publicize the upcoming seminar and endorse WPI applicants. AAS seminars typically enroll two or three students from WPI.

No more than one unit of work for the Humanities and Arts Requirement may be applied toward the American Studies Minor. Any student at WPI is eligible to pursue the Minor in American Studies except for students majoring in Humanities and Arts with a concentration in American Studies.

List 1. American Antiquarian Society Fall Seminar:

This competitive seminar, open to a limited number of Worcester Consortium students, features a different visiting professor and a new thematic focus each fall. The seminar is equivalent to two courses in American Studies at the 3000-level; the comparable WPI discipline(s) will be determined by the topic of each seminar. To apply, consult a member of the American Studies faculty early in the preceding D-term.

List 2. American History:

HI 2310 Topics in Urban History
 HI 2311 American Colonial History
 HI 2313 American History, 1789-1877
 HI 2314 American History, 1877-1920
 HI 2315 The Shaping of Post-1920 America
 HI 2316 Twentieth Century American Foreign Relations
 HI 2318 Topics in Law, Justice and American Society
 HI 2335 Topics in the History of American Science and Technology
 HI 2400 Topics in Environmental History
 HI 2401 U.S. Environmental History
 HI 2913 Capitalism and Its Discontents
 HI 2930 Topics in Latin American History
 HI 3312 Topics in American Social History
 HI 3314 The American Revolution
 HI 3317 Topics in Environmental History
 HI 3334 Topics in the History of American Science and Technology
 HI 3344 Pacific Worlds

List 3. American Literature:

EN 2221 American Drama
 EN 2234 Modern American Novel
 EN 2237 American Literature and the Environment
 EN 2271 American Literary Histories
 EN 3231 Supernatural Literatures
 EN 3234 Modern American Poetry
 EN 3238 American Authors
 EN 3271 American Literary Topics
 SP/ID 3531 Contemporary US Latino Literature & Culture

List 4. American Art/Architecture:

AR 2114 Modern Architecture in the American Era, 1750-2001 and Beyond

List 5. American Music:

MU 2719 Jazz History
 MU 2722 History of American Popular Music

List 6. American Philosophy and Religion:

PY/RE 2716 Gender, Race, and Class
 *RE 2721 Religion and Culture
 *RE 3721 Topics in Religion

List 7. American Politics, Law, and Policy:

GOV 1301 U.S. Government
 GOV 1303 American Public Policy
 GOV 1310 Law, Courts, and Politics
 GOV 2302 Science-Technology Policy
 GOV 2310 Constitutional Law
 GOV 2311 Environmental Policy and Law
 GOV 2313 Intellectual Property Law
 GOV 2314 Cyberlaw and Policy
 GOV 2315 Privacy
 GOV 2320 Constitutional Law: Civil Rights and Liberties

* Check with an American Studies advisor to determine if this course has an American focus in a given term. To facilitate degree audits by the Office of the Registrar, HUA faculty will create a form by which to approve unlisted courses that have significant focus on the U.S. national experience.

CHINESE STUDIES

The minor in Chinese Studies offers students the opportunity to extend their study of China and the Chinese Language beyond the Humanities and Arts Requirement. The Chinese Studies minor includes intermediate or above language proficiency and content courses on Chinese history, philosophy, environmental, and society and culture. The minor is primarily intended for non-native speakers of Mandarin Chinese. Native speakers of Mandarin are not eligible to take Chinese language courses at WPI. Native speakers who wish to pursue this minor through content courses need to receive permission from the minor advisor and will most likely have to take advantage of both WPI and Consortium offerings.

Students must demonstrate a level of Chinese proficiency of at least CN 2544 or its equivalent. A total of two units (six courses) are required for the minor degree requirement from the courses listed below. These consist of:

1. No more than 1 unit (3 courses) of intermediate to advanced Chinese language classes chosen from the following list:
 - CN 2542 (Cat. I)
 - CN 2543 (Cat. I)
 - CN 2544 (Cat. I)
 - CN 3541 (Cat. I)
 - CN 3542 (Cat. I)
 - CN 3543 (Cat. I)

or Consortium courses in Chinese approved by a WPI China faculty member.

2. At least 2/3 unit (2 courses) of advanced culture or society courses chosen from the following list. At least one of these must be at the 3000 level.
 - CN 3541 (2nd year Chinese, 4th term, formerly CN 250X) (Cat. I)
 - HI 2328 (History of Revolutions in the 20th Century) (Cat. II)
 - HI 2343 (East Asia: China at the Center) (Cat. II)
 - HU 2340 (Popular Culture and Social Change in Asia: China) (Cat. II)
 - HI 3335 (Topics in the History of Non-Western Science and Technology) (Cat. II)
 - HI 3343 (Topics in Asian History: Reengineering China) (Cat. I)
 - ID 2050 for Hong Kong or Hangzhou Project sites (Cat. I)
 - RE 2724 (Religions of the East) (Cat. II)
 - 1/3 unit of Hangzhou or Hong Kong Project Center IQP (Cat. I)
 - or Consortium courses approved by a WPI faculty member in Chinese.
3. 1/3 unit of capstone experience (1 course) consisting of an ISU or a 3000-level course in Chinese history, culture, literature, or philosophy identified before the beginning of the term as the capstone by the student and professor. The capstone experience must be the last course completed for the minor.

WPI policy requires that no more than one unit of course work can be double counted toward other degree requirements. Thus, students may count three courses taken to fulfill other degree requirements (such as the Humanities and Arts Requirement or two course requirement in the Social Sciences) toward the minor, provided that one unit of classes taken for the minor do not double-count for another degree requirement. In practical terms, this means that up to 3/3 units from HUA Requirement and 1/3 unit from a China IQP, with a combined total from the two of no more than 3/3 unit, can be applied to the Chinese Studies minor.

A student who uses an upper level Chinese language course as the capstone for an HUA Requirement fulfilled with language courses cannot use that capstone language course as the capstone for the Chinese Studies minor. For students conducting their IQP or MQP in China, the capstone can take the form of an ISU that reflects on their onsite experiences.

Students interested in pursuing the minor should speak with Professor Jennifer Rudolph or Professor Huili Zheng to find out more and to discuss finding a capstone course and any related background courses.

WPI current courses identified as contributing to a Chinese Studies Minor.

Chinese Language:

CN 1541 Elementary Chinese I (Cat. I)
 CN 1542 Elementary Chinese II (Cat. I)
 CN 1543 Elementary Chinese III (Cat. I)
 CN 2541 Intermediate Chinese I (Cat. I)
 CN 2542 Intermediate Chinese II (Cat. I)

- CN 2543 Intermediate Chinese III (Cat. I)
 CN 2544 Intermediate Chinese IV (Cat. I)
 CN 3541 Advanced Intermediate Chinese I (Cat. I)
 CN 3542 Advanced Intermediate Chinese II (Cat. I)
 CN 3543 Advanced Intermediate Chinese III (Cat. I)
 or Consortium Chinese courses in Chinese
 approved by a WPI China faculty member.

China Content courses:

- HI 2328 History of Revolutions in the 20th Century (Cat. II)
 HI 2341 Contemporary World Issues in Historical Perspective
 (Cat. II)
 HI 2343 East Asia: China at the Center (Cat. II)
 HI 3335 Topics in the History of Non-Western Science and
 Technology (Cat. II)
 HI 3343 Topics in Asian History: Reengineering China
 (Cat. I)
 HU 1412 Introduction to Asia (Cat. I)
 HU 2340 Popular Culture and Social Change in Asia: China
 (Cat. II)
 RE 2724 Religions of the East (Cat. II)

DRAMA/THEATRE

The minor in Drama/Theatre is for students who choose to continue their studies in Drama/Theatre beyond the Humanities and Arts Requirement without majoring in Drama/Theatre. Students who, for personal or career purposes, wish to earn official recognition of their achievements in Drama/Theatre, and who do not have academic time to fulfill the requirements for the major, should consider the Drama/Theatre minor.

Because practical experience in performance, including design and production, is an integral component of Drama/Theatre, the requirements for this minor contain a performance emphasis. The Drama/Theatre minor consists of 2 units of work distributed as follows:

1. Drama/Theatre Courses: 4/3 units chosen from among the following:
 EN 1221, EN 1222, EN 2221, EN 2222, EN 2224,
 EN 3222, EN 3223, EN 3224, or any ISU designated TH.
2. Drama/Theatre Performances: 1/3 unit (at least two 1/6 unit TH ISU, Independent Study).
3. Drama/Theatre Capstone Experience: 1/3 unit Performance Independent Study (EN or TH). The student, with faculty guidance, will perform, design, direct, produce or in some other way create a Drama/Theatre presentation that demonstrates the student's skill and knowledge.

No more than 1 unit of work for the Humanities and Arts Requirement may be applied to the Drama/Theatre minor. The final Inquiry Seminar or Practicum may not be counted toward the minor.

Any student at WPI is eligible to pursue the Minor in Drama/Theatre except for students majoring in Humanities and Arts with a concentration in Drama/Theatre.

ENGLISH

The minor in English is for students who choose to continue their studies in English beyond the Humanities and Arts Requirement without majoring in English. Students who, for personal or career purposes, wish to earn official recognition of their achievements in English, and who do not have academic time to fulfill the requirements for the major, should consider an English minor. Interested students should speak with one of the English faculty in the Department of Humanities and Arts.

The English minor consists of a total of two units of work in English, distributed in the following way:

1. 5/3 units of literature (usually EN) courses, which must include a minimum of one 3000-level course and a maximum of one 1000-level course.
2. 1/3 unit English Capstone Experience. This can be either a 1/3 unit Independent Study in English or a 3000-level course approved by the student and advisor.

No more than one unit of work for the Humanities and Arts Requirement may be applied toward the English minor. Any student at WPI is eligible to pursue the Minor in English except for students majoring in Humanities and Arts with a concentration in Literature.

LANGUAGE (GERMAN OR SPANISH)

The minor in Language can be completed in either German or Spanish. It allows students who are well prepared to continue their study of the language and its culture well beyond the advanced level. The minor consists of a total of two units of work, distributed in the following way:

1. 1 unit of intermediate and advanced language courses in Spanish or German chosen from the following:
 - SP 2522, SP 3521, SP 3522, or higher or
 - GN 2512, GN 3511, GN 3512, or higher.
 (This unit may be double-counted toward the Humanities and Arts Requirement. No more than one unit may be double-counted in this way.)
2. 2/3 unit of advanced literature and culture courses chosen from the following:
 - SP 3523, SP 3524, SP 3525, SP 3526, or Consortium courses approved by a faculty member in Spanish or
 - GN 3513, GN 3514, or Consortium courses approved by a faculty member in German.
 - Any 3000-level experimental course in GN or SP may also be used.
3. 1/3 unit capstone experience consisting of an ISU written in the foreign language.

(If, in the future, there are enough German and Spanish minors combined, the capstone independent study will be a team-taught seminar in comparative civilization/literature.) Interested students should see the following professors in the Humanities and Arts Department: Prof. Brisson (for German) or Prof. Rivera (for Spanish).

HISTORY

The minor in History offers students the opportunity to extend their study of History beyond the Humanities and Arts Requirement without majoring in History. Students who, for personal or career purposes, wish to earn official recognition of their achievements in History, and who do not have academic time to fulfill the requirements for the major, should consider the History minor. Students interested in declaring a minor should speak with one of the history faculty in the Department of Humanities and Arts. The History minor consists of a total of two units of work in history distributed as follows:

1. 5/3 units of history (HI) courses, which must include a minimum of 1 3000-level course and a maximum of one 1000-level course.
2. 1/3 unit History Capstone Experience. This can be either a 1/3 unit Independent Study in History or a 3000-level HI course identified by the student and instructor as the 3000-level capstone course for the student's program. Inquiry Seminars are not eligible to count as capstone courses for the minor. The capstone course must be taken last.
3. No more than one unit of work for the Humanities and Arts Requirement may be applied toward the History minor. Any student at WPI is eligible to pursue the Minor in History except for students majoring in Humanities and Arts with a concentration in History.

MEDIA ARTS

The Media Arts minor is for students who have a serious interest in multimedia and digital art. The Media Art minor includes a series of courses in visual and graphic arts, animation/film/video, audio arts, critical studies of art, and art history.

A total of six courses are required for the minor degree requirement. These consist of:

1. 1 Unit (3 courses) in visual art production (List 1):
2. 1/3 Unit (1 course) in either visual art (List 1), critical studies in art (List 2), or audio arts directly related to digital media production (List 3).
3. 1/3 Unit (1 course) in Art History (List 4).
4. 1/3 Unit 3000 or higher level visual art course as a final capstone experience (List 5).

WPI minor rules apply in that no more than three courses can be double-counted for any other degree requirement. Any student at WPI is eligible to pursue the minor in Media Arts except for students majoring in IMGD with a concentration in Art.

Students interested in pursuing the minor should speak with an HUA advisor about the rules of pursuing the minor, as well as finding a capstone course and any related background courses.

List 1. Visual Art production:

AR 1100	Essentials of Art
AR 1101	Digital Imaging & Computer Art
AR/IMGD 2101	3D Modeling I
AR/IMGD 2202	Figure Drawing
AR/IMGD 2222	2D Animation I

AR 2301	Graphic Design
AR/IMGD 2333	3D Animation I
AR 2401	Video Production
AR/IMGD 2700	Digital Painting
AR/IMGD 3101	3D Modeling II
AR/IMGD 3200	Interactive Electronic Arts
AR/IMGD 3222	2D Animation II
AR/IMGD 3333	3D Animation II
IMGD 3500	Artistic Game Development I
AR/IMGD 3700	Concept Art & Creative Illustration
IMGD 4500	Artistic Game Development II

List 2. Critical Studies in Art

IMGD 1000	Critical Studies of Interactive Media and Games
IMGD 2001	Philosophy & Ethics of Computer Games
GN 3516	German Film
HU 2251	Introduction to Film Studies
SP 3530	Spanish Film/Media: Cultural Issues
WR 2310	Visual Rhetoric

List 3. Audio Arts

IMGD 2030	Game Audio I
IMGD 3030	Game Audio II
MU 2300	Foundations of Music Technology
MU 2801	Making Music with Machines
MU 3614	Topics in Midi
MU 3615	Topics in Digital Sound
MU 3616	Topics in Interactive Programming
MU 3620	Electronic Music Composition

List 4. Art History

AR 1111	Introduction to Art History
AR 2111	Modern Art
AR 2114	Modern Architecture In the American Era
AR 3112	Modernism, Mass Culture, and the Avant-Garde
AR 3150	Light, Vision and Understanding
HU 2251	Introduction to Film Studies
IMGD 4200	History and Future of Immersive and Interactive Media

List 5. 3000 Level Capstone courses

AR/IMGD 3101	3D Modeling II
AR/IMGD 3200	Interactive Electronic Arts
AR/IMGD 3222	2D Animation II
AR/IMGD 3333	3D Animation II
IMGD 3500	Artistic Game Development I
AR/IMGD 3700	Concept Art & Creative Illustration
IMGD 4500	Artistic Game Development II

MUSIC

The Minor in Music is for students who choose to continue their studies in Music beyond the Humanities and Arts Requirement without pursuing a Concentration in Music. Students who, for personal or career purposes, wish to achieve official recognition of their achievements in Music, yet do not find the time to fulfill the requirements for the Concentration, should consider the Music Minor option. The Music Minor consists of two units of work distributed as follows:

1. 1 2/3 units of music courses.
2. 1/3 unit ISU as a final capstone experience. Students, with faculty guidance, will complete a project which could consist of a paper, composition, arrangement, performance, or other project designed in consultation with the faculty advisor.
3. Students may receive no more than 2/3 units from Music Ensembles (MU 2631, MU 2632, MU 2633, MU2634, MU 2635, MU 2636, MU 2637, MU 2638).

4. If a student completes the Humanities and Arts Requirement in music 1 unit of that work may be applied to the minor except the final Seminar or Practicum.
5. A student who is pursuing a Major in Humanities and Arts with Music as the Concentration cannot also receive a Minor in Music.

PHILOSOPHY AND RELIGION

A Philosophy and Religion Minor requires completion of 2 units of work in Philosophy and Religion distributed as follows:

1. 5/3 unit of PY and/or RE courses, which must include a minimum of one 3000-level course and a maximum of one 1000-level course.
2. 1/3 unit Philosophy and Religion Capstone Experience. This can be either a 1/3 unit Independent Study in Philosophy and Religion or a 2000 or 3000-level course approved by the student and advisor, to which significant extra reading and writing requirements are added. The capstone course must be taken last.

Notes: No more than one unit of work from the Humanities and Arts Requirement may be applied toward the Philosophy and Religion minor. The Inquiry Seminar Project cannot be applied to the Minor. Any student at WPI is eligible to pursue the minor in Philosophy and Religion except for students majoring in Humanities and Arts with a concentration in philosophy.

WRITING AND RHETORIC

The minor in Writing and Rhetoric offers students the opportunity to extend their study of writing and rhetoric beyond the Humanities and Arts Requirement without majoring in either the Writing and Rhetoric concentration in Humanities and Arts or the interdisciplinary Professional Writing program. Students interested in declaring a minor should obtain a minor declaration form so that they are assigned an advisor early in the process. Contact Esther Boucher-Yip (efboucher@wpi.edu) for more information.

The minor consists of two units of work, distributed in the following way:

1. 1/3 unit. Core course in Writing and Rhetoric: WR 3112 or equivalent.
2. 1-1/3 unit. Electives in writing and rhetoric (WR). If there is good reason, and with the approval of the Program Review Committee, electives may also include courses in art history, literature (in English or other languages), and philosophy and religion.
3. 1/3 unit. Capstone course WR 4111 unless an Independent Study (ISU) substitution is authorized by the student's program review committee, and will be granted only under unusual circumstances. Should students receive permission to complete the capstone with an ISU, then those students should submit and have approved a one-page proposal for their capstone to the Program Review Committee the term before they intend to complete it.

No more than 1 unit of course work may be double-counted toward the Humanities and Arts Requirement. Students interested in this area also may wish to consider the major in Professional Writing (see catalog rules for minors).

INTERACTIVE MEDIA & GAME DEVELOPMENT

DIRECTOR: J. DeWINTER (HUA)

ASSOCIATE DIRECTOR: B. MORIARTY (IMGD)

ASSOCIATED FACULTY: E. Agu (CS), S. Barton (HUA), F. Bianchi (HUA), R. Bigonah (HUA), F. Chery (IMGD), M. Claypool (CS), J. deWinter (HUA), J. Forgeng (HUA), E. Gutierrez (HUA), L. Harrison (CS), N. Heffernan (CS), M. Keller (HUA), V.J. Manzo (HUA), B. Moriarty (IMGD), D. O'Donnell (IMGD), E. Ottmar (SSPS), C. Roberts (CS), J. Rosenstock (HUA), J. Sanbonmatsu (HUA), L. Sheldon (IMGD), R. Sutter (IMGD), Y. Tellier (HUA), C. Wills (CS),

PROGRAM EDUCATIONAL OBJECTIVES

The educational objectives of the IMGD program are:

- To prepare students for technical and/or creative roles in the interactive media and game industries.
- To provide a solid base of IMGD-related technical and/or creative expertise, strong written and oral communication skills, and substantial experience in collaborating effectively in multidisciplinary teams.
- To cultivate an understanding of the social and ethical issues relevant to interactive media and games, together with a sense of personal responsibility and professionalism.
- To develop personal traits necessary for continuous career growth, including
 - The ability to integrate theory and practice.
 - The ability to think analytically and critically in order to define, analyze and solve technical and/or creative challenges.
 - The ability to learn new skills in response to evolving technology and a dynamic professional environment.

PROGRAM OUTCOMES

The specific outcomes for the IMGD program are that all graduates will:

1. Demonstrate practical skill and in-depth understanding of IMGD-related technologies, concepts, tools and aesthetics.
2. Have a base of knowledge in computer science, mathematics and the natural/engineering sciences.
3. Have a base of knowledge in IMGD-related design, audio, cultural narratives and visual arts.
4. Be aware of social and philosophical issues pertaining to interactive media and games.
5. Be able to creatively express and analyze artistic forms relative to IMGD.
6. Communicate effectively orally, in writing, and in visual media.
7. Successfully complete individual projects.
8. Successfully complete a group project with students from other IMGD disciplines.
9. Successfully complete team-based, full-term IMGD projects.
10. Successfully complete a team-based, multi-term IMGD project.

INTERACTIVE MEDIA & GAME DEVELOPMENT (BACHELOR OF ARTS)

Distribution Requirements for the IMGD Major

REQUIREMENTS	MINIMUM UNITS
IMGD Core	2/3
Choose 2/3 units from:	
<ul style="list-style-type: none"> • Critical Studies of Interactive Media & Games (IMGD 1000) • The Game Development Process (IMGD 1001) • Storytelling in Interactive Media and Games (IMGD 1002) 	
IMGD Design	1/3
Choose 1/3 unit from:	
<ul style="list-style-type: none"> • Design of Tabletop Strategy Games (IMGD 2500) • Digital Game Design I (IMGD 2900) • Digital Game Design II (IMGD 3900) • History & Future of Immersive & Interactive Media (IMGD 4200 or 5200, but not both) • Serious Games (IMGD 4600) • Advanced Storytelling: Quest Logic & Level Design (IMGD 4700) • Digital Game Design Studio (IMGD 4900) • Game Design Studio (IMGD 5000) • Design of Interactive Experiences (IMGD 5300) • User Experience & Design (MIS 4741) • User Experience Applications (MIS 583) 	
IMGD Audio	1/3
Choose 1/3 unit from one of:	
<ul style="list-style-type: none"> • Game Audio I (IMGD 2030) • Game Audio II (IMGD 3030) 	
IMGD Social & Philosophical Issues	1/3
Choose 1/3 unit from:	
<ul style="list-style-type: none"> • Social Issues in Interactive Media & Games (IMGD 2000) • Philosophy & Ethics of Computer Games (IMGD 2001) 	
Cultural Narratives	1/3
Choose 1/3 unit from any course with an EN, PY or RE prefix	
Visual Arts	1/3
Choose 1/3 unit from one of:	
<ul style="list-style-type: none"> • Essentials of Art (AR 1100) • Digital Imaging & Computer Art (AR 1101) • Graphic Design (AR 2301) 	
Natural & Engineering Sciences	2/3
Choose 1/3 unit from any course with an AE, BB, BME, CHE, CE, CH, ECE, ES, GE, ME, PH or RBE prefix.	
General Sciences	1/3
Choose 1/3 unit from any course with a CS, MA, AE, BB, BME, CHE, CE, CH, ECE, ES, GE, ME, PH or RBE prefix (except CS 2022 or CS 3043).	
Mathematics and Data Analysis	1/3
Choose 1/3 unit from:	
<ul style="list-style-type: none"> • Data Analysis for Game Development (IMGD 2905) • Any course with an MA prefix 	
Computer Science	2/3
Choose 2/3 units from any course with a CS prefix (except CS 2022 or CS 3043).	
General IMGD	8/3
Choose 8/3 units from any course with an IMGD prefix, which must include:	
<ul style="list-style-type: none"> • 1/3 unit of any 1000+ level IMGD course • 3/3 unit of any 2000+ level IMGD course • 2/3 units of any 3000+ level IMGD courses • 2/3 units of any 4000+ level IMGD courses 	

IMGD Focus Pair 2/3

Choose 2/3 units from one of the following IMGD course pairs:

- **Technical Art**
 - Technical Game Development I & II (IMGD 3000 + 4000)
- **Visual Art**
 - Artistic Game Development I & II (IMGD 3500 + 4500)
- **Design**
 - Digital Game Design II & Digital Game Design Studio (IMGD 3900 + 4900)
- **Writing**
 - Writing Narrative for IMGD & Advanced Storytelling: Quest Logic and Level Design (IMGD/WR 3400 + IMGD 4700)

IMGD Electives 4/3

Choose 4/3 units from any courses with an IMGD, AR, EN, WR, MU or CS prefix (except CS 2022 or CS 3043), at least 2/3 of which must be 3000+ level.

Major Qualifying Project 3/3

TOTAL DEGREE UNITS 30/3

NOTE: IMGD majors may not earn a double major in IMGD Technology.

IMGD BA: Concentrations

Students pursuing the IMGD major may, at their option, choose to focus in one of three topics of concentration:

- Visual Art
- Design
- Technical Art
- Writing

Concentrations are a formal degree designation (noted on a student's transcript), earned by completing a topic-specific selection of 6/3 units drawn from the IMGD Focus Pair and IMGD Electives (see above).

In accordance with WPI policy, a student's contribution to their Major Qualifying Project (MQP) must incorporate substantial content/effort in their area of concentration.

IMGD Visual Art Concentration

Students taking the IMGD Visual Arts Concentration must:

1. Satisfy the 2/3 units IMGD Focus Pair requirement by choosing Artistic Game Development I & II (IMGD 3500 + 4500).
2. Satisfy the 4/3 units IMGD Electives requirement by choosing:
 - 1/3 unit from any of:
 - Essentials of Art (AR 1100)
 - Digital Imaging & Computer Art (AR 1101)
 - Graphic Design (AR 2301)
 - 1/3 unit from any of:
 - Introduction to Art History (AR 1111)
 - Modern Art (AR 2111)
 - Modern Architecture in the American Era (AR 2114)
 - Modernism, Mass Culture & the Avant-Garde (AR 3112)
 - Light, Vision & Understanding (AR 3150)
 - 2/3 units from any of:
 - 3D Modeling II (IMGD/AR 3101)
 - Interactive Electronic Arts (IMGD/AR 3200)
 - 2D Animation II (IMGD/AR 3222)
 - 3D Animation II (IMGD/AR 3333)
 - Concept Art & Creative Illustration (IMGD/AR 3700)
3. Contribute substantially to the visual art aspects of their Major Qualifying Project.

IMGD Design Concentration

Students taking the Design Concentration must:

1. Satisfy the 2/3 units IMGD Focus Pair requirement by choosing Digital Game Design II and Digital Game Design Studio (IMGD 3900 + 4900).

2. Satisfy the 4/3 units IMGD Electives requirement by choosing:

- 2/3 units from any of:
 - Writing Characters for IMGD (IMGD/WR 2400)
 - Business Writing and Communications (WR 2210)
 - Creative Writing (EN 2219)
 - Visual Rhetoric (WR 2310)
 - Writing Narrative for IMGD (IMGD 3400)
 - Rhetorical Theory (WR 3112)
 - Technical Writing (WR 3210)
 - Advanced Creative Writing (EN 3219)
 - Digital Rhetoric (WR 3310)
 - Other IMGD-related writing courses subject to program approval

• 2/3 units from any of:

- History & Future of Immersive & Interactive Media (IMGD 4200 or 5200, but not both)
- Serious Games (IMGD 4600)
- Advanced Storytelling: Quest Logic & Level Design (IMGD 4700)
- User Experience & Design (MIS 4741) or User Experience Applications (MIS 583), but not both
- Game Design Studio (IMGD 5000)
- Design of Interactive Experiences (IMGD 5300)
- Other 3000+ level IMGD-related design courses subject to program approval

3. Contribute substantially to the design aspects of their Major Qualifying Project.

IMGD Technical Art Concentration

Students taking the IMGD Technical Art Concentration must:

1. Satisfy the 2/3 units IMGD Focus Pair requirement by choosing Artistic Game Development I & II (IMGD 3500 + 4500).

2. Satisfy the 4/3 units IMGD Electives requirement by choosing:

- 1/3 unit from any course with a CS prefix (except CS 2022 or CS 3043).
- 3/3 units from any of:
 - Technical Art and Character Rigging (IMGD 2048)
 - 3D Modeling II (IMGD/AR 3101)
 - Interactive Electronic Arts (IMGD/AR 3200)
 - 3D Animation II (IMGD/AR 3333)

3. Contribute substantially to the technical art aspects of their Major Qualifying Project.

IMGD Writing Concentration

Students taking the Writing Concentration must:

1. Satisfy the 2/3 units IMGD Focus Pair requirement by choosing Writing Narrative for IMGD & Advanced Storytelling: Quest Logic and Level Design (IMGD/WR 3400 + IMGD 4700)

2. Satisfy the 4/3 units IMGD Electives requirement by choosing:

- Writing Characters for IMGD (IMGD/WR 2400) (1/3 unit)
- 3/3 units (including at least 2/3 units at 3000+ level) from any of:
 - Elements of Style (WR 2010)
 - Business Writing and Communications (WR 2210)
 - Introduction to Journalism (WR 2213)
 - Creative Writing (EN 2219)
 - Visual Rhetoric (WR 2310)
 - Rhetorical Theory (WR 3112)
 - Technical Writing (WR 3210)
 - Advanced Creative Writing (EN 3219)
 - Digital Rhetoric (WR 3310)
 - Other IMGD-related writing courses subject to program approval

3. Contribute substantially to the writing aspects of their Major Qualifying Project.

INTERACTIVE MEDIA & GAME DEVELOPMENT TECHNOLOGY (BACHELOR OF SCIENCE)

Distribution Requirements for the IMGD Technology Major

REQUIREMENTS	MINIMUM UNITS
IMGD Core	2/3
Choose 2/3 units from:	
<ul style="list-style-type: none"> • Critical Studies of Interactive Media & Games (IMGD 1000) • The Game Development Process (IMGD 1001) • Storytelling in Interactive Media & Games (IMGD 1002) 	
IMGD Design	1/3
Choose 1/3 unit from:	
<ul style="list-style-type: none"> • Design of Tabletop Strategy Games (IMGD 2500) • Digital Game Design I (IMGD 2900) • Digital Game Design II (IMGD 3900) • History & Future of Immersive & Interactive Media (IMGD 4200 or 5200, but not both) • Serious Games (IMGD 4600) • Advanced Storytelling: Quest Logic & Level Design (IMGD 4700) • Digital Game Design Studio (IMGD 4900) • Game Design Studio (IMGD 5000) • Design of Interactive Experiences (IMGD 5300) • User Experience & Design (MIS 4741) • User Experience Applications (MIS 583) 	
IMGD Audio	1/3
Choose 1/3 unit from:	
<ul style="list-style-type: none"> • Game Audio I (IMGD 2030) • Game Audio II (IMGD 3030) 	
IMGD Social & Philosophical Issues	1/3
Choose 1/3 unit from:	
<ul style="list-style-type: none"> • Social Issues in Interactive Media & Games (IMGD 2000) • Philosophy & Ethics of Computer Games (IMGD 2001) 	
Cultural Narratives	1/3
Choose 1/3 unit from any course with an EN, PY or RE prefix.	
Visual Arts	1/3
Choose 1/3 unit from:	
<ul style="list-style-type: none"> • Essentials of Art (AR 1100) • Digital Imaging and Computer Art (AR 1101) • Graphic Design (AR 2301) 	
Natural & Engineering Sciences	2/3
Choose 2/3 units from any courses with an AE, BB, BME, CHE, CE, CH, ECE, ES, GE, ME, PH or RBE prefix.	
Mathematics and Data Analysis	2/3
Choose 2/3 units from:	
<ul style="list-style-type: none"> • Data Analysis for Game Development (IMGD 2905) • Any courses with an MA prefix 	
General IMGD	5/3
Choose 5/3 units from any courses with an IMGD prefix, which must include:	
<ul style="list-style-type: none"> • 1/3 unit of any 1000+ IMGD course • 1/3 unit from one of: <ul style="list-style-type: none"> • Novel Interfaces for Interactive Environments (IMGD 3100) • Artificial Intelligence for Interactive Media & Games (IMGD/CS 4100) • Technical Game Development I (IMGD 3000) • Technical Game Development II (IMGD 4000) • 1/3 unit of any 4000+ IMGD course 	
Computer Science	11/3
Choose 11/3 units from any courses with a CS prefix, which must include:	
<ul style="list-style-type: none"> • 5/3 units of any CS courses 	

- Any 3/3 units from:
 - Operating Systems (CS 3013)
 - Human-Computer Interaction (CS 3041)
 - Database Systems I (CS 3431)
 - Computer Networks (CS 3516)
 - Software Engineering (CS 3733)
- Any 3/3 units from:
 - Object-Oriented Analysis & Design (CS 4233)
 - Webware: Computational Technology for Network Information Systems (CS 4241)
 - Introduction to Artificial Intelligence (CS 4341)
 - Data Mining & Knowledge Discovery in Databases (CS 4445)
 - Mobile & Ubiquitous Computing (CS 4518)
 - Computer Graphics (CS 4731)
 - Computer Animation (CS 4732)

Computer Science Notes

1. Only CS 1101, CS 1102 and CS courses at the 2000-level or higher can be counted towards the Computer Science requirements.
2. Only one of CS 1101 and CS 1102 may count towards the Computer Science requirement.
3. Only one of CS 2301 and CS 2303 may count towards the Computer Science requirements.
4. CS 2119 and CS 3043 cannot be chosen to satisfy the Computer Science course requirements.
5. Any AP credits earned in Computer Science cannot be applied to the 30/3 unit distribution requirements of the IMGD BS degree. CS AP credit **can** be applied to the Unrestricted Electives units available outside the degree-specific distribution.

Major Qualifying Project	3/3
TOTAL DEGREE UNITS	30/3

NOTE: IMGD Technology majors may not earn a double major in IMGD.

MINOR IN INTERACTIVE MEDIA & GAME DEVELOPMENT

The Interactive Media & Game Development Minor is for students who, for personal or career purposes, wish to earn official recognition of their achievements in IMGD, but do not have academic time to fulfill the requirements for the major.

A total of six IMGD courses are required for the Minor degree requirement. This consists of:

Two core IMGD courses from this list:

- IMGD 1000. Critical Studies of Interactive Media and Games
- IMGD 1001. The Game Development Process
- IMGD 1002. Storytelling in Interactive Media and Games

Three additional IMGD courses. If necessary for the academic goals of a student’s minor program, and with prior approval of the IMGD Minor Coordinator, may include one course in art history, visual art, creative writing and rhetoric, theatre, or music.

One 3000 or higher level IMGD course as a final capstone.

General WPI rules that apply to the Minor are that at most three courses can be double-counted for any other degree requirement, and the capstone course cannot be a double-counted course.

Students interested in pursuing the Minor should speak with an IMGD advisor about the rules of pursuing the Minor, as well as finding a capstone course and any related background courses.

NOTE: IMGD Technical majors may not earn a minor in IMGD.

INTERDISCIPLINARY AND GLOBAL STUDIES

DEAN: K. J. RISSMILLER

PROFESSORS: S. Strauss, R. F. Vaz

ASSOCIATE PROFESSORS: S. Jiusto, S. Tuler

ASSISTANT PROFESSOR: S. Stanlick

TEACHING PROFESSORS: F. Carrera, D. Golding, C. Peet, R. Traver

ASSOCIATE TEACHING PROFESSORS: M. Belz, C. Dehner, L. Dodson, I. Shockey

ASSISTANT TEACHING PROFESSORS: J. M. Davis, J. Doiron, K. Foo, C. Kurlanska, S. McCauley

INSTRUCTORS/LECTURERS: T. Balistrieri, J. Chiarelli, R. Hersh, L. Roberts

In addition to overseeing the Interactive Qualifying Project (see page 18) and the Global Projects Program (see page 19), the Interdisciplinary and Global Studies Division (IGSD) provides the support structure for students who construct individually-designed (ID) majors which cannot readily be accommodated in traditional academic departments.

ID majors may be defined in any area of study where WPI’s academic strengths can support a program of study, and in which career goals exist. Many combinations of technical and non-technical study are possible. Do not be limited by the example given here; if you have questions about what programs at WPI are possible, please see Dean Kent Rissmiller in the FIS to discuss how WPI can assist you in reaching your goals.

PROCEDURE FOR ESTABLISHING AN INTERDISCIPLINARY (INDIVIDUALLY-DESIGNED) MAJOR PROGRAM

Students who wish to pursue an individually-designed major program should first discuss their ideas with their academic advisor. The student should then consult with the dean of the IGSD, who will determine, with the assistance of other members of the faculty, if the proposed program is feasible, and, if it is, arrange for its evaluation.

The following procedures will be followed for feasible programs:

1. The student must submit to the dean of the IGSD an educational program proposal, including a “definition of scope,” and a concise statement of the educational goals of the proposed program. Goals (such as graduate school or employment) should be specified very clearly. The proposal must be detailed in terms of anticipated course and project work. The proposal must be submitted no later than one calendar year before the student’s expected date of graduation, and normally before the student’s third year.
2. The Dean of the Interdisciplinary and Global Studies Division will name a three-member faculty committee, representing those disciplines most involved in the goals of the program, to evaluate the proposal. The committee may request clarification or additional information for its evaluation. The proposal, as finally accepted by the committee and the student, will serve as an informal contract to enable the student to pursue the stated educational goals most effectively.

3. Upon acceptance of the proposal, the student will notify the Office of Academic Advising and the Registrar's Office of the choice of ID (individually-designed) as the designation of major. The IGSD then becomes the student's academic department for purposes of record-keeping.
4. The three-person faculty committee will serve as the student's program advisory committee, and will devise and certify the distribution requirements (up to a limit of 10 units including the MQP) appropriate to the student's program.

INTERDISCIPLINARY MINORS

MINOR IN GLOBAL PUBLIC HEALTH

The minor in Global Public Health offers WPI students an opportunity to explore factors that impact the health of populations around the world. Students interested in the minor should meet with faculty associated with Global Public Health as early as possible in their academic career. They will be assigned a minor advisor after completing a minor declaration form.

The Global Public Health minor consists of two units of work distributed in the following way:

1. 2/3 unit Global Public Health Core courses from this list:
 - STS 1200 Fundamentals of Global Health
 - ID 2100 Disease Detectives: An Introduction to Epidemiology
 - Or an Independent Study (ISU) approved by the Global Public Health Steering Committee
2. 3/3 unit Global Public Health Electives. 2/3 unit of these electives must be at the 2000 level or higher. These may be selected from among global public health related courses in humanities, social sciences, life sciences, engineering or business (see below). These may include:
 - 1/3 unit Great Problems Seminar course (FY 1100) that has a Global Public Health focus and the approval of the Global Public Health Steering Committee
 - any course listed below among Global Public Health electives or courses approved by the Global Public Health Steering Committee.
3. 1/3 unit Senior Seminar in Global Public Health (STS 4000). This seminar may be taken concurrently, or any time after a Global Public Health Experience (for example, a Global Public Health -focused IQP or MQP (see below)). With the approval of the Global Public Health Steering Committee, the seminar may be completed as an independent study.
4. Global Public Health Experience. All Global Public Health minors require an 'experience' in global public health that is educational in nature and equivalent in length to at least one WPI term. Example experiences include global public health related IQPs and MQPs, or activities such as internships, service learning or significant volunteer work accompanied by a reflective writing assignment. The Program Steering

Committee Chair must approve this experience, prior to the student undertaking it, by signing the 'Global Public Health Experience Approval' at the bottom of the Application for the Global Public Health Minor.

WPI policy require that no more than one unit of course work can be double counted toward other degree requirements. Thus, students may count three courses for the minor to fulfill other degree requirements as long as one unit of the minor does not double count. In other words, students must take STS 4000 and two other courses for this minor that do not count for another degree requirement.

Global Public Health Minor Electives: Below is a list of examples of relevant courses, which students can choose from to fulfill their Global Public Health elective requirements. Students will take 1 Unit (at least 2 of the 3 courses must be at or above the 2000 level) from the list below or courses approved by the Global Public Health Steering Committee.

Social Science and Policy Study

- GOV 2312 International Environmental Policy
- GOV 2319 Global Environmental Politics
- GOV 2302 Science, Technology, and Policy
- GOV 1320 Topics in International Politics
- SOC 1202 Introduction to Sociology and Cultural Diversity
- ECON 2125 Development Economics
- PSY1400 Introduction to Psychological Sciences
- PSY 1402 Social Psychology
- PSY 2406 Cross Cultural Psychology: Human Behavior in a Global Perspective
- PSY 2407 Psychology of Gender
- PSY 2408 Health Psychology

Life Sciences

- BB 1025 Human Biology
- BB 2003 Microbiology
- BB 3003 Medical Microbiology
- BB 3920 Immunology

Humanities and Arts

- HI 2401 U.S. Environmental History
- HI 2403 Global Environmental History
- INTL 1100 Introduction to International and Global Studies
- PY 2712 Social And Political Philosophy
- PY 2713 Bioethics
- PY 2716 Philosophy of Difference
- PY 2717 Philosophy and the Environment
- PY 3731 Problems in Ethics and Social Philosophy
- PY 2732 Suffering, Healing and Values
- WR 1011 Writing about Science and Technology
- WR 2210 Business Writing and Communication
- WR 3214 Writing about Disease and Public Health

Business

- BUS 1010 Global Environment of Business Decisions
- BUS 1020 Leadership Practice

Other

- CE 3060 Water Treatment
- CE 3061 Wastewater Treatment
- CE 3070 Urban and Environmental Planning
- MA 2610 Applied Statistics for the Life Sciences

MINOR IN NANOSCIENCE

Important to nanoscience are the studies of the structure and function of molecules, and the quantum and atomic properties of matter. Nanoscientists investigate fundamental aspects of the behavior of molecules, materials, devices, and living matter at length scales smaller than the wavelength of visible light. Synthesizing knowledge across disciplines greatly enhances progress in understanding nanoscale systems. A Minor in Nanoscience will benefit students who wish to enhance their disciplinary major with an additional degree designation in the area of Nanoscience.

The Minor in Nanoscience requires the completion of at least two units of course work in the topical areas described below:^{a,b} Students planning the minor should contact Professor Burnham in the Physics Department.

1. **Structure of Molecules.** At least one course (1/3 unit) in organic, inorganic, or physical chemistry.
2. **Function of Molecules.** At least one course (1/3 unit) selected from the following list:

BB 1035	Introduction to Biotechnology
BB 2550	Cell Biology
BB 2920	Genetics
3. **Quantum Properties of Matter.** At least one course (1/3 unit) selected from the following list:

CH 3530	Quantum Chemistry
PH 1130	Modern Physics
PH 2501 or 2502	Photonics or Lasers
PH 3401 or 3402	Quantum Mechanics
4. **Atomic Properties of Matter.** At least one course (1/3 unit) selected from the following list:

ES 2001	Introduction to Material Science
ME 4875	Introduction to Nanomaterials and Nanotechnology
PH 3502	Solid State Physics
5. **Nanoscale Fabrication and Characterization.** (No minimum number of required courses.)

CHE/ME 2301	Nanobiotechnology Laboratory Experience
PH 2510	Atomic Force Microscopy
6. **Interdisciplinary Capstone Experience in Nanoscience.** (1/3 unit).

The capstone experience for the nanoscience minor can be satisfied either by i) an independent study arranged for this purpose as the sixth course in the sequence, or ii) a small project during an existing course, also as the sixth course in the sequence.^c If the second option is chosen, the student must arrange an interdisciplinary capstone experience with the instructor prior to the start of the course, and the instructor must agree to advise it. In either case, documentation of the capstone is required, prepared in consultation with the independent study advisor or instructor, which incorporates and ties together concepts learned in the nanoscience courses selected. After successful completion of the capstone, the instructor shall notify the student, Professor Burnham in the Physics Department, and the Registrar.

NOTES

- a. In keeping with Institute-wide policy for minors, up to three courses may be double-counted for degree requirements (at most 1/3 unit of IQP), no course may be triple-counted, and the capstone experience must be done at the end of the sequence. The Major Qualifying Project (MQP) may not be counted toward activity for Minors.
- b. Other courses, including graduate courses, may be used to satisfy the four topic areas with the approval of the Nanoscience Minor Committee.
- c. A list of faculty who are willing to advise Nanoscience Capstones or ISUs is given at the bottom of <https://www.wpi.edu/academics/study/nanoscience-minor>.

MINOR IN SUSTAINABILITY ENGINEERING

This academic minor is intended for students who are interested in gaining knowledge and experience in the principles and practices of engineering design for sustainability, and of the critical role of engineering decisions on the sustainability of the resulting designs. Every engineering discipline impacts the environmental and social sustainability of our planet, and knowledge of the principles of sustainability in engineering design will contribute substantially to professional practice.

While this minor is intended primarily for engineering students, it is open to all students. For non-engineering students the expected background courses may increase the total minor program to more than two units.

Review Committee: The Minor Program Review Committee consists of Profs. John Bergendahl, Robert Krueger, and Steven Van Dessel. The Office of Sustainability, directed by Prof. Paul Mathisen, will assist with oversight of the minor.

Requirements: Candidates for the Sustainability Engineering Minor must meet the following requirements:

1. Complete the Minor Declaration Form available from the Registrar's Office and the Completion Form available from the Office of Sustainability or Sustainability website.
 - I. Define a focus for the minor. Some examples are given below but these are not comprehensive. Note that the focus must be distinct from the content of your major and must be supported by the courses in the minor. It is important to select an cohesive set of courses that supports a minor in the focus area.
 - II. List the academic activities that will be included in the minor, following the general rules for minors at WPI as well as the rules below.
2. Complete two units of work for the minor, one unit of which may be double counted with other degree requirements. The two units must meet the following requirements:
 - I. Must include ES 2800, Environmental Impacts of Engineering Decisions.
 - II. May include at most 1/3 U of relevant 1000-level work from the following list (List A):
 - ENV 1100, Introduction to Environmental Studies
 - Relevant GPS FY 1100 credit.

- III. Must include 2/3 U of relevant sustainability coursework from the Humanities, Business, and/or SSPS areas. Course options in these areas are as follows (List B):
- ECON 2117, Environmental Economics
 - ENV 2201, Planning for Sustainable Communities
 - ENV 2400, Environmental Problems and Human Behavior
 - ENV 2600, Environmental Problems in the Developing World
 - ENV 2700, Social Media, Social Movements, and the Environment
 - ENV 4400, Senior Seminar in Environmental Studies
 - ETR 2900, Social Entrepreneurship
 - GOV 2311, Environmental Policy and Law
 - GOV 2312, International Environmental Policy
 - GOV 2319, Global Environmental Politics
 - HI 2401, U.S. Environmental History
 - HI 3317, Topics in Environmental History
 - PY 2717, Philosophy and the Environment
- IV. Must include at least 2/3 U of course work in engineering from the following list (List C):
- AREN 3003, Principles of HVAC Design for Buildings
 - AREN 3024, Building Physics
 - AREN 3025, Building Energy Simulation
 - CHE 3702, Energy Challenges of the 21st Century
 - CHE/CE 4063, Transport and Transformations in the Environment
 - CE 3059, Environmental Engineering
 - CE 3070, Urban and Environmental Planning
 - CE 3074, Environmental Analysis
 - ECE 3500, Introduction to Contemporary Electric Power Systems
 - ES 2001, Introduction to Materials Science
 - ES 3001, Introduction to Thermodynamics
 - ES 3003, Heat Transfer
 - ME 4422, Design and Optimization of Thermal Systems
 - ME 4429, Thermofluid Application and Design
 - ME 5105, Renewable Energy
3. To accommodate new sustainability-related courses and independent study and project activities, up to two thirds units may be substituted for the activities listed in items III and IV with the approval of the Sustainability Engineering Minor program review committee. This committee may be contacted through the Registrar or the Director of Sustainability.
4. See the WPI Undergraduate Catalog for additional rules for all minors, in particular that the MQP cannot be used in satisfying any Minor and that at most one unit may be double counted with another degree requirement.

Guidance for Students

Possible Focus Areas (not exhaustive):

The Sustainability Engineering Minor provides students with the opportunity to select a focus area that aligns with the student's area of interest. The following focus areas and sample programs are included to provide some possible options for selecting the activities that compose the two units of credit for the minor, although they are not meant to be restrictive in any way.

- Sustainable Engineering in the Developing World
- Climate Change Mitigation and Adaptation
- Engineering Design for Sustainability
- Sustainable Manufacturing
- Clean and Renewable Energy
- Sustainable Engineering Materials
- Resource Recovery and Reuse
- Green Buildings
- Sustainable Water Resources Management
- Planning for Sustainability
- Urban Sustainability

INTERNATIONAL DEVELOPMENT, ENVIRONMENT, AND SUSTAINABILITY (IDEaS) (BACHELOR OF ARTS DEGREE)

CO-DIRECTORS: L. ELGERT AND L. STODDARD

ASSOCIATED FACULTY: M. Bakermans (BB), C. Brown (SSPS), C. Clark (HUA), J. Doyle (SSPS), K. Foo (IGSD), R. Gottlieb (HUA), R. Krueger (SSPS), C. Kurlanska (IGSD), S. LePage (CEE), J. MacDonald (CBC), P. Mathiesen (CEE), G. Pfeifer (UGS), R. Rao (BB), D. Rosbach (CEE), I. Shockey (IGSD), S. Tuler (IGSD)

MISSION STATEMENT

Our planet faces urgent environmental, social, and technological crises. Because these problems involve peoples, natures, planetary systems, and technologies, we need new scientific and engineering approaches that are informed by the social sciences, humanities, the arts, and people's real lives. We must therefore challenge convention. IDEaS therefore offers a major and minor in Environmental Sustainability Studies. The major can be chosen as a stand-alone course of study or be connected with other degree programs, which could range from chemical engineering, to biology and chemistry, or civil engineering. IDEaS also offers a minor in Science and Engineering for International Development. Either degree option invites students to explore the technical area of their choice: to become competent engineers and scientists. These programs also teach those skills for the future workplace: interdisciplinary collaboration; complex problem solving of socio-technical issues; written and oral communication; and the dexterity and creativity to excel in changing contexts .

EDUCATIONAL OUTCOMES

Graduating Students will:

1. Be able to identify, analyze, and development solutions to environmental and socio-economic problems creatively.
2. Have mastered fundamental concepts and methods of inquiry in their areas of specialization, whether environmental or developmental thought, policy, or methodology.
3. Be able to make connections between disciplines and integrate information from multiple sources.
4. Be aware of how their decision-making processes affect and are affected by other individuals separated across time and space.
5. Be aware of personal, societal, and professional ethical standards.
6. Have interpersonal and communication skills and a professional attitude necessary for a successful career.
7. Understand and employ current technological tools.
8. Have the ability to engage in life-long learning.

MAJOR IN ENVIRONMENTAL AND SUSTAINABILITY STUDIES.

Distribution Requirements

REQUIREMENTS	MINIMUM UNITS
1. Environmental and Sustainability Studies Core (Note 1)	1
2. Mathematics & Basic Science (Note 2)	2 2/3
3. Environmental Science and Engineering (Note 3)	3
4. Basic Social Science and Humanities (Note 4)	1
5. Environmental Social Science or Humanities (Note 5)	2
6. MQP	1
Total	<u>10 2/3</u>

NOTES

1. Only courses with the prefix ENV count toward this requirement. Must include the senior seminar in environmental studies.
2. Must include 2/3 unit of calculus, 1/3 unit of statistics, 2/3 unit of chemistry, and 2/3 unit of biology. May include 1/3 unit of basic engineering with the permission of the Environmental Studies Program Review Committee.
3. All courses with prefixes BB, CE, CH, CHE, ES, GE, and PH may qualify under this requirement. BB courses must be at the 2000 level or higher. Must include 1/3 unit of ecology. Must include 1/3 unit of engineering at the 2000 level or higher. The 3 units of environmental science and engineering courses must be coherently defined and approved by the Environmental Studies Program Review Committee.
4. Must include 1/3 unit of economics, 1/3 unit of public policy or political science, and 1/3 unit of either history or philosophy.
5. Must include 1/3 unit environmental economics, 1/3 unit environmental policy, 1/3 unit environmental philosophy, and 1/3 unit environmental history.

MAJOR QUALIFYING PROJECT (1 UNIT)

The MQP is expected to provide an integrative capstone research experience in Environmental and Sustainability Studies. Several types of MQPs are possible: a research study in a particular science or social science discipline, a holistic examination of an environmental problem from an interdisciplinary perspective, or a philosophical or historical

analysis of an environmental issue. WPI faculty from academic disciplines including biology, chemistry, economics, geography, history, philosophy, psychology and public policy are associated with the Environmental Studies program and can advise Environmental Studies MQPs related to their area of expertise.

ENVIRONMENTAL IQP OPPORTUNITIES

WPI students can complete an IQP in a wide variety of areas at the intersection of society and technology, and there is no requirement that Environmental and Sustainability Studies students do an environmentally-related IQP. However, for interested students, numerous opportunities exist for environmental IQPs on campus and at off-campus centers. Many other environmentally themed projects are offered on campus as well. Typical project topics include issues of public health, renewable energy, land conservation, air quality and water quality, urban environments, and environmental justice. In some circumstances students may, with the approval of their IQP advisor, their academic advisor, and the Environmental Studies Program Review Committee, complete additional work on an environmental IQP that qualifies the project to count as an Environmental Studies MQP. However, students must still complete two separate, distinct projects, one IQP and one MQP, to meet the requirements for graduation.

MINOR IN ENVIRONMENTAL AND SUSTAINABILITY STUDIES

Students taking minors in environmental studies are expected to designate a member of the Environmental Studies associated faculty as their SS minor advisor, who will assist them in preparing a program that meets the requirements of the minor. Students can obtain assistance at the Environmental Studies Program office in designating an advisor.

REQUIREMENTS	UNITS
Environmental Studies Core (Note 1)	2/3
Environmental Social Science and Humanities (Note 2)	1
Environmental Studies Capstone (Note 3)	1/3

NOTES

1. Only courses with the prefix ENV count toward this requirement.
2. Students must either select courses for breadth, or they may choose a thematic set of courses for depth. At least two of these courses should be above the 2000 level. Additional ENV courses not counted toward the core requirement may be counted here. Students may substitute up to two courses in environmental science with the approval of the Environmental Studies Program Review Committee.
3. The capstone requirement will normally be met by taking ENV4400, Senior Seminar in Environmental Studies. With the approval of the Program Review Committee, the capstone requirement may also be fulfilled via independent study. Students are also strongly encouraged to do an environmental/sustainability related IQP.

APPROVED SOCIAL SCIENCE AND HUMANITIES COURSES

ECON 2117	Environmental Economics
GOV 2311	Environmental Policy and Law
GOV 2312	International Environmental Policy
PY 2717	Philosophy and the Environment
HI 2401	U. S. Environmental History
ECON 2125	Development Economics
EN 2237	American Literature and the Environment
HI 2351	History of Ecology
HI 3317	Topics in Environmental History
SD 1510	Introduction to System Dynamics Modeling

Two examples of sequences that satisfy the requirements for an ENV minor:

ENV MINOR WITH BREADTH

Environmental Studies Core	2/3
Environmental Studies Capstone	1/3
BB 2040 Ecology	1/3
HI 2401 US Environmental History	1/3
ECON 2117 Environmental Economics	1/3

ENV MINOR WITH DEPTH (SOCIAL SCIENCE)

Environmental Studies Core	2/3
Environmental Studies Capstone	1/3
GOV 2311 Env Law and Policy	1/3
GOV 2312 Intl. Env Law and Policy	1/3
ECON 2117 Environmental Economics	1/3

Many other sequences are possible.

MINOR IN SCIENCE AND ENGINEERING FOR DEVELOPMENT (DEV)

Successful candidates for the DEV Minor must meet the following requirements:

1. Complete two units of work that meet the requirements below.
2. Complete the following three courses:
 - DEV 1200: International Development and Society
 - DEV 2200: Case Studies in International Development Policy and Engineering
 - DEV 4400: Science, Engineering, and Design in International Development
3. Complete one unit of work in courses thematically related from environmental and sustainability studies, economics, system dynamics, psychology, or international dimensions of science technology policy, Foisie Business School, or an approved combination. Two of the three courses must be at the 2000-level or above. Some combinations could include:
 - ENV 2310, ENV 2600, GOV 2319 (Governance)
 - ENV 1100, ENV 2900, ENV 4400 (Environment and Society)
 - ECON 1110, ECON 2117, ECON 2125 (Development Economics)
 - GOV 2302, SD 1510, GOV 2319 (International Political Dynamics)
 - PSY 1400, ENV 2400, PSY 2406 (Psychological Science)
 - ETR 1100, ETR 2900, ETR 4930 (Social Entrepreneurship)
4. Complete approved courses and/or project work that reflect global experience.

Students seeking a DEV Minor should complete this form and submit it to the SSPS office as early in the program of study as possible. The chair of the DEV curriculum committee will be responsible for review and approval of all DEV Minor requests.

WPI policy requires that no more than one unit of course work can be double counted toward other degree requirements.

INTERNATIONAL AND GLOBAL STUDIES

DIRECTOR: P. H. HANSEN

ASSOCIATED FACULTY: W.A.B. Addison (HU), M. Belz (IGSD), E. Boucher-Yip (HU), M. Brahim (HU), U. Brisson (HU), C. Brown (SSPS), F. Carrera (IGSD), C. Dehner (IGSD), D. DiMassa (HU), H. Droessler (HU), W. Du (HU), L. Elgert (SSPS), M. Elmes (BUS), P. Everett (HU), K. Foo (IGSD), J. Galante (HU), D. Golding (IGSD), P. H. Hansen (HU), R. Hersh (IGSD), S. Jiusto (IGSD), R. Krueger (SSPS), C. Kurlanska (IGSD), S. McCauley (IGSD), A. S. Madan (HU), I. Matos-Nin (HU), R. Moody, (HU), S. Nikitina (HU), O. Pavlov (SSPS), C. Peet (IGSD), G. Pfeifer (HU), M. J. Radzicki (SSPS), K. J. Rissmiller (SSPS), A. Rivera (HU), J. Rudolph (HU), K. Saeed (SSPS), W. San Martin (HU), I. Shockey (IGSD), A. Smith (SSPS), G. Somasse (SSPS), J. Sphar (IGSD), S. Stanlick (IGSD), P. Stapleton (SSPS), E. Stoddard (SSPS), S. Strauss (IGSD), S. Taylor (BUS), Y. Telli (HU), A. Trapp (BUS), R. Traver (IGSD), S. Tuler (IGSD), R. Vaz (IGSD; ECE)

International and Global Studies prepares men and women for future leadership roles in business, industry, research, government and public affairs. International and Global Studies integrates WPI's international and global courses in the humanities, social sciences and business with its global projects and exchange programs. International and Global Studies courses on-campus prepare students to go abroad. After an experience overseas, students integrate their experiences and explore their career options in a capstone seminar. International and Global Studies at WPI offers a range of options including a minor, major, or double major.

MINOR IN INTERNATIONAL AND GLOBAL STUDIES

The minor in International and Global Studies offers students the opportunity to integrate coursework on campus with a global educational experience. Students interested in the minor should meet with faculty associated with International and Global Studies as early as possible. They will be assigned an advisor after completing a minor declaration form. The International and Global Studies minor consists of two units of work distributed in the following way:

1. 2/3 unit International and Global Core. Any courses with the INTL prefix or courses selected from international and global history or social science courses (see below).
2. 1 unit International and Global Electives. These may be selected from among international and global courses in the humanities, social sciences, or business. These may include:
 - any INTL courses;
 - any international and global history or social science courses (see below);
 - any foreign language courses (e.g. AB, CN, GN, SP);
 - 1/3 unit first-year course (e.g. FY 1100);

- International and global courses in business (e.g. BUS 1020), art history (e.g. AR 1111), literature (e.g. EN 3222), music history (e.g. MU 3001), philosophy (e.g. PY 2716), religion (e.g. RE 2724), and writing, and other courses approved by the Program Review Committee. Electives may not include the MQP.
3. 1/3 unit Senior Seminar in International and Global Studies (INTL 4100). This seminar may be taken at any time after an International and Global Experience. With the approval of the Program Review Committee, the seminar may be completed via independent study.
 4. International and Global Experience. All International and Global Studies minors are required to have a study abroad experience that should be educational in nature and equivalent in length to at least one WPI term. All WPI global projects and exchange programs completed at projects centers outside of the United States meet this requirement. If approved by the Program Review Committee, global projects completed in the United States or international educational programs and/or internships sponsored by other organizations also may satisfy this requirement.

WPI policy requires that no more than one unit of course work can be double counted toward other degree requirements. Thus, students may count three courses for the minor taken to fulfill other degree requirements (such as the Humanities and Arts Requirement or two course requirement in the Social Sciences) as long as one unit of the minor does not double-count. In other words, students must take INTL 4100 and two other courses for this minor that do not count for another degree requirement.

International and Global Humanities and Arts Courses

INTL 1100	Introduction to International and Global Studies
INTL 1300	Introduction to Latin America
INTL 2100	Approaches to Global Studies
INTL 2110	Global Justice
INTL 2310	Modern Latin America
INTL 2410	Modern Africa
INTL 2420	Middle East, North Africa and Mediterranean
INTL 2510	Contemporary Europe: Union and Disunion
INTL 2520	Russia Ready: Language and Cultural Context
INTL 2910	Topics in Global Studies
INTL 3050	Global Re-Entry Seminar
INTL 4100	Senior Seminar in International and Global Studies
HI 1313	US and the World
HI 1322	Introduction to European History
HI 1330	Introduction to the History of Science and Technology
HI 1350	Introduction to Environmental History
HI 2310	Topics in Urban History
HI 2314	American History, 1877-1920
HI 2315	The Shaping of Post-1920 America
HI 2316	Twentieth Century American Foreign Relations
HI 2318	Topics in Law, Justice and American Society
HI 2320	Modern European History
HI 2324	The British Empire
HI 2328	History of Revolutions in the Twentieth Century
HI 2335	Topics in the History of American Science and Technology
HI 2341	Contemporary World Issues in Historical Perspective

HI 2343	East Asia: China at the Center
HI 2350	Topics in the History of Science
HI 2400	Topics in Environmental History
HI 2403	Global Environmental History
HI 2913	Capitalism and its Discontents
HI 2921	Topics in Modern European History
HI 2930	Topics in Latin American History
HI 3316	Topics in Twentieth-Century U.S. History
HI 2217	Topics in Environmental History
HI 3312	Topics in American Social History
HI 3331	Topics in the History of European Science and Technology
HI 3334	Topics in the History of American Science and Technology
HI 3335	Topics in the History of Non-Western Science and Technology
HI 3341	Topics in Imperial and Postcolonial History
HI 3343	Topics in Asian History
HI 3344	Pacific Worlds
HU 1222	Introduction to Medical Humanities
HU 1412	Introduction to Asia
HU 1500	Introduction to Gender, Sexuality and Women's Studies
HU 2222	Topics in Medical Humanities
HU 2340	Popular Culture and Social Change in Asia
HU 2258	World Cinemas
HU 2501	STEM-inism
HU 2502	Global Feminisms
AR 1111	Introduction to Art History
AR 2111	Modern Art
EN 1251	Introduction to Literature
EN 1257	Introduction to African American Literature and Culture
EN 2257	Literature and the Environment
EN 2251	Moral Issues in the Modern Novel
EN 2252	Science and Scientists in Modern Literature
EN 2281	World Literatures
EN 3222	Forms in World Drama
EN 3226	Strange and Strangers
EN 3271	American Literary Topics
ISE 3800	Loaded Language: Discourse and Power in International English
IMGD 2000	Social Issues in Interactive Media and Games
IMGD 2001	Philosophy and Ethics of Computer Games
MU 3001	World Music
PY/RE 1731	Introduction to Philosophy and Religion
PY/RE 2716	Gender, Race, and Class
PY 2712	Social and Political Philosophy
PY 2713	Bioethics
PY 2717	Philosophy and the Environment
PY/RE 2731	Ethics
PY 3711	Topics in Philosophy
RE 2721	Religion and Culture
RE 2722	Modern Problems of Belief
RE 2725	Religious and Spiritual Traditions
RE 3721	Topics in Religion
WR 1011	Writing about Science & Technology
WR 3214	Writing about Disease & Public Health
WR 3300	Cross-Cultural Communication
	All Modern Language courses (AB, CN, GN, SP)

International and Global Social Science and Business Courses

DEV 1200	International Development and Society
DEV 2200	Case Studies in International Development Policy and Engineering
DEV 4400	Science, Engineering, and Design in International Development
ECON 1110	Introductory Microeconomics
ECON 1120	Introductory Macroeconomics
ECON 2117	Environmental Economics
ECON 2125	Development Economics
ECON 2126	Public Economics
ECON/ETR 2910	Economics and Entrepreneurship
ENV 1100	Introduction to Environmental Studies
ENV 2201	Planning for Sustainable Communities
ENV 2310	Environmental Governance and Innovation
ENV 2400	Environmental Problems and Human Behavior
ENV 2600	Environmental Problems in the Developing World
ENV 2600	Social Media, Social Movements, and the Environment
ENV 3900	The Green Economy and Models for Alternative Forms of Development
ENV 3100	Adventures in Sustainable Urbanism
GOV 1301	U.S. Government
GOV 1313	American Public Policy
GOV 1310	Law, Courts and Politics
GOV 1320	Topics in International Politics
GOV 2312	International Environmental Policy
GOV 2302	Science-Technology Policy
GOV 2311	Environmental Policy and Law
GOV 2312	International Environmental Policy
GOV 2313	Intellectual Property Law
GOV 2314	Cyberlaw and Policy
GOV 2315	Privacy: Laws, Policy, Technology, and How They Fit Together
GOV 2319	Global Environmental Politics
ID 2050	Social Science Research for the IQP
ID 2100	Disease Detectives: An Introduction to Epidemiology
PSY 1400	Introduction to Psychological Science
PSY 1402	Social Psychology
PSY 2406	Cross-Cultural Psychology: Human Behavior in Global Perspective
PSY 2407	Psychology of Gender
SD 1501	Introduction to Systems Dynamics Modeling
SD 2520	Modeling Economic and Social Systems
SS 1505	Games for Understanding Complexity
SOC 1202	Introduction to Sociology and Cultural Diversity
STS 1200	Fundamentals of Global Health
STS 4000	Senior Seminar in Global Public Health
BUS 1010	Leadership Practice
BUS 1020	Global Environment of Business Decisions
BUS 2020	The Legal Environment of Business Decisions
BUS 3010	Creating Value through Innovation
ETR 1100	Engineering Innovation and Entrepreneurship
ETR 2900	Social Entrepreneurship
ETR 3915	Entrepreneurial Business Models
OBC 3354	Organizational Behavior and Change
OBC 4367	Leadership, Ethics and Social Responsibility

Distribution Requirements for the International and Global Studies Major:

REQUIREMENTS	MINIMUM UNITS
International and Global Core (Note 1)	1
International and Global Fields (Note 2)	4
International and Global Experience (Note 3)	0
Science, Technology, Engineering, Mathematics (Note 4)	2
Electives (Note 5)	2
MQP	1
Total	10

NOTES:

- Only courses with the prefix INTL count toward this requirement. Must include the senior seminar in international and global studies.
- International and Global Fields: Majors complete at least one unit of work in each of the following areas. They must also complete at least one additional unit of work in one of these areas, which will be considered their primary field.
 - History and International and Global Studies. These include any course with the INTL prefix and/or any international and global history course (see list).
 - Language, Literature, and Culture. These include any course in foreign languages, civilization, and literature offered at WPI (e.g. AB, CN, GN, SP), or in the Consortium with the prior approval of the Program Review Committee; also courses approved by the Program Review Committee in Art History (e.g. AR 1111, AR 3112), English Literature (e.g. EN 2251, EN 3222), Music History (e.g. MU 3001), Philosophy (e.g. PY 2716), Religion (e.g. RE 2724), or Writing. Majors who designate Language, Literature, and Culture as their primary field should take most of their courses in a single discipline or in a coherent program approved by the Program Review Committee.
 - Social Sciences and Business. These include international and global social sciences courses (see list), international and global courses in business (e.g. BUS 1020), and 1/3 unit of a first-year course (e.g. FY 1100). Students may count courses taken for the two-course requirement in Social Sciences.
- International Studies majors are required to have a study-abroad experience. (In very unusual cases exceptions may be made to this requirement but only with prior approval of the Director and Program Review Committee). This abroad experience may take the form of a project, exchange, or internship approved by the Program Review Committee. The study-abroad experience should be educational in nature and equivalent in length to at least one WPI term.
- Must include a minimum of 2/3 units in mathematics or computer science and 2/3 units in natural science or engineering science. The remaining 2/3 units may be from any area of mathematics, computer science, natural science or engineering science. Double majors may count courses taken for their other major.
- Electives may be from any area except Air Force Aerospace Studies, Military Science or Physical Education. Double-majors may count courses taken for their other major.

DOUBLE MAJOR IN INTERNATIONAL AND GLOBAL STUDIES

Students may pursue a double major in International and Global Studies and any area of study at WPI except a major in Humanities and Arts. To pursue the double major, a student must satisfy all of the degree requirements for both disciplines, including an MQP and Distribution Requirements. The double major in International and Global Studies requires the same distribution of courses as the major and either a second MQP in International and Global Studies or an interdisciplinary MQP that satisfies the requirement of both programs as described on page 12. Double majors are also required to have an International and Global Experience.

INTERNATIONAL AND GLOBAL EXPERIENCES

An International and Global Experience may take the form of an international and global IQP, MQP, Humanities and Arts Inquiry Seminar, internship or exchange program. Students often plan their international and global experience in their Sophomore year. All students are advised to consult the list of projects offered at WPI's Global Project Centers. Each fall, the projects and exchange programs for the following year are widely advertised on campus. For information about student exchange programs, see page 227.

Award-winning projects at WPI are frequently on international topics. International and Global Studies offers the opportunity not only to complete some of the highest quality projects at WPI, but also to offer solutions to some of the most challenging problems in the world.

Students interested in International and Global Studies may ask any member of the Associated Faculty for more information, or they may consult our webpages <https://www.wpi.edu/academics/departments/international-global-studies>.

LIBERAL ARTS AND ENGINEERING

(BACHELOR OF ARTS DEGREE)

DIRECTOR: L. SCHACHTERLE (HU)

The Director will advise students and will convene faculty to serve as the Liberal Arts and Engineering Program Committee as needed.

MISSION STATEMENT

The goal of the Liberal Arts and Engineering Bachelor of Arts (BA) degree is to provide an opportunity for students who want a broad background in engineering and other disciplines, as preparation for further studies in engineering or in other fields such as medicine, law, public policy, international and global studies, business, or wherever a solid technical background would give them a unique edge. The program is also designed to allow students to transfer to an engineering BS program with minimum loss of time.

For more information, see the Admissions web site at <https://www.wpi.edu/academics/departments/liberal-arts-engineering>.

PROGRAM EDUCATIONAL OBJECTIVES

The Liberal Arts and Engineering degree recognizes that societal and technological issues are becoming more and more interdependent. Leaders of government, non-profit and for-profit organizations are typically educated in non-engineering disciplines yet increasingly would benefit from a more technological grounding. The Liberal Arts and Engineering major, with its emphasis on problem solving, will prepare students not only for further study in engineering but also for many other high-level careers, such as:

- Law
- Medicine and health care
- Energy policy
- Environmental policy
- Technology policy

- Finance
- Technology management
- International relations
- Public affairs and political service
- Performing arts, especially in music
- Consulting

PROGRAM OUTCOMES

Graduates of the BA in Liberal Arts and Engineering major will have:

- a) an ability to formulate and solve problems requiring knowledge of both technological and societal/humanistic needs and constraints
- b) an ability to apply, as needed, the relevant fundamentals of mathematics, science, engineering, social sciences, and the humanities to solve such problems
- c) an ability to use the techniques, skills, and modern tools necessary for professional practice
- d) an ability to function on multi-disciplinary teams
- e) an understanding of professional and ethical responsibility
- f) an ability to communicate effectively in oral, written and visual modes
- g) a recognition of the need for, and ability to engage in, life-long learning, in response to the ever-increasing pace of change affecting societal needs and opportunities
- h) the broad education necessary to understand the impact of professional solutions in a societal context, both locally and globally.

Minimum Distribution Requirements

REQUIREMENTS	MINIMUM UNITS
1. Mathematics and Basic Sciences (Notes 1, 2)	3
2. Engineering Science and Design (Notes 3, 4, 5)	3
3. Humanities and Arts, Social Science, and Business Topics (Notes 6, 7)	3
4. MQP (Note 8)	1

NOTES:

1. Mathematics must include differential and integral calculus and either probability or statistics.
2. All courses with prefixes BB, CH, PH, or GE count toward this requirement. Must include at least 1/3 Unit each of BB, CH, and PH.
3. Courses with prefixes AREN, BME, CE, CHE, CS, ECE, ES, ME, and RBE are eligible to count toward this requirement. These courses should be thematically related; students must gain approval of their program of study in this area from the Liberal Arts and Engineering Program Committee.
4. Must include either CS 1101 or CS 1102.
5. Must include at least one course in engineering design (such as ECE 2799 or ME 2300), plus at least two other courses with a significant laboratory component (a list of such courses will be maintained by the Liberal Arts and Engineering Program Committee).
6. Must include 2 Units of Humanities and Arts and Social Science. Courses with prefixes AR, HI, MU, PY, RH, WR, IMGD, ECON, GOV, PSY, STS, and SD may be eligible to count toward this requirement. Courses must be selected from areas that strongly complement the practice of engineering, such as the history of technology, ethics, writing and visual rhetoric, economics, society-technology studies, and environmental studies. A list of such courses will be maintained by the Liberal Arts and Engineering Program Committee.

Table 1: BA in Liberal Arts and Engineering*Three (3) examples; others possible*

15 Units	ECE Design	Energy and Environment	Engineering and Pre-Law
WPI General Education Institutional Requirements (5 Units)			
1 H&A	HU&A of student's choice	HI 1332	HI 2317
2 H&A	HU&A	HI 2324	EN/WR 2211
3 H&A	HU&A	HI 2331	EN/WR 3214
4 H&A	HU&A	HI 2334	EN/WR 3216
5 H&A	HU&A	HI 3331	RH 3112
6 H&A	HU 3900 or HU 3910	HU 3900 or HU 3910	HU 3900 or HU 3910
7 SS	SS	PSY 1402	SOC 1202
8 SS	SS	SS/ID 2050	GOV 1301
9 PE	PE	PE	PE
10 Free Elective	Free Elective	Free Elective	Free Elective
11 Free Elective	Free Elective	Free Elective	Free Elective
12 Free Elective	Free Elective	Free Elective	Free Elective
13 IQP	IQP	IQP	IQP
14 IQP	IQP	IQP	IQP
15 IQP	IQP	IQP	IQP
Mathematics and Science (3 Units)			
16 Math & Science	MA 1021	MA 1021	MA 1021
17 Math & Science	MA 1022	MA 1022	MA 1022
18 Math & Science	MA 1024	MA 1024	MA 1024
19 Math & Science	MA 2051	MA 2051	MA 2051
20 Math & Science	MA 2611	MA 2611	MA 2611
21 Math & Science	CH 1010	CH 1010	CH 1010
22 Math & Science	PH 1110	CH 1020	BB 1035
23 Math & Science	PH 1120	BB 1002	PH 1110
24 Math & Science	BB 1001	PH 1110	PH 1120
Engineering Studies Cornerstone (3 Units)			
Theme	ECE	Energy	Eng Science and Design
25 Engineering Sci/Des	ECE 2010	ES 3001	ES 1020
26 Engineering Sci/Des	ECE 2019	ES 3003	ES 1310
27 Engineering Sci/Des	ECE 2029	ES 3004	ES 2001
28 Engineering Sci/Des	ECE 2049	ES 2501	ES 2501
29 Engineering Sci/Des	ECE 2112	ECE 2010	ES 2502
30 Engineering Sci/Des	ECE 2201	ECE 2019	ES 2503
31 Engineering Sci/Des	ECE 2311	ECE 3501	ES 3003
32 Engineering Sci/Des	ECE 2799 (design)	ME 2300 (design)	ME 2300 (design)
33 Engineering Sci/Des	CS 1101	CS 1101	CS 1101
Liberal Arts Cornerstone (3 Units)			
Theme	Social, Humanistic, Business Factors of Design	Environment and Policy	Pre Law
34 Liberal Studies	PY 2714 Ethics in the Professions	PY 2717 Phil.&Environ.	GOV 1303 American Pub. Policy
35 Liberal Studies	HI 1332 History of Technology	GOV 2311 Ev. Policy & Law	GOV 1310 Law, Courts, Politics
36 Liberal Studies	HI 3331 Topics in Society/Technology Studies	ENV 2400 Environmental Problems and Human Behavior	GOV 2313 Intellectual Property Law
37 Liberal Studies	GOV 2313 Intellectual Property Law	GOV 2312 International EV Policy	GOV 2314 Cyberlaw and Policy
38 Liberal Studies	GOV 2302 Science and Technology Policy	HI 3333 American Technology Development	GOV 2304 Govt. Decision Making and Admin Law
39 Liberal Studies	GOV 2314 Cyberlaw and Policy	GOV 2302 Science and Technological Policy	
40 Liberal Studies	OIE 2850 Engineering Economics	ENV 1100 Introduction to Environmental Studies	BUS 2020 Legal Environment of Business Decisions
41 Liberal Studies	BUS 2020 Legal Environment of Business Decisions	ENV 2200 Environmental Studies in the Various Disciplines	OIE 2850 Engineering Economics
42 Liberal Studies	ETR 3915 Entrepreneurial Business Models	ENV 4400 Senior Seminar in Environmental Studies	FIN 3300 Finance, Risk Analytics & Technology
MQP – aimed at confluence of engineering and liberal arts cornerstones (1 Unit)			
43 MQP	MQP	MQP	MQP
44 MQP	MQP	MQP	MQP
45 MQP	MQP	MQP	MQP

7. May include up to 1 Unit of Business. All courses with prefixes ACC, BUS, ETR, FIN, MIS, MKT, OIE, and OBC are eligible to count toward this requirement.
8. The MQP provides a capstone experience that builds on both the technical (Engineering Science and Design) and nontechnical (Humanities and Arts, Social Science, and Business Topics) components of the student's particular program. At least one advisor to the MQP must be a member of the Liberal Arts and Engineering Associated Faculty.

PROGRAMS OF STUDY AND RELEVANT COURSES

The Liberal Arts and Engineering program will offer considerable curricular flexibility to accommodate a wide range of student interests, but at the same time will require students to be intentional about developing a coherent program of study consistent with the program's objectives. Academic advising will play an important role in helping students plan their programs.

For more information and advice about the program, contact Prof. Lance Schachterle at les@wpi.edu.

The Engineering Science and Design component of the major (Distribution Requirement 2) must be approved by the Liberal Arts and Engineering Program Committee to ensure that it provides students with a focus in some area of engineering. Guidance and examples will be provided so that students know in advance what types of programs will be approved. The intent is to accommodate creative programs while avoiding programs that lack a coherent theme.

The Social and Humanistic Factors component (see Distribution Requirement 3 and Note 6) should consist of courses that complement engineering and technology to support the educational objectives of the program. The Program Committee will maintain and make available to students and advisors lists of current courses that are acceptable for credit toward this requirement.

MATHEMATICAL SCIENCES

L. CAPOGNA, HEAD; M. BLAIS, ASSOCIATE HEAD

PROFESSORS: L. Capogna, A. Heinricher, M. Humi, C. Larsen, R. Lui, K. Lurie, W. Martin, U. Mosco, B. Nandram, M. Sarkis, B. Servatius, D. Tang, B. Vernescu, S. Weekes

ASSOCIATE PROFESSORS: J. Fehribach, S. Olson, R. Paffenroth, Q. Song, S. Sturm, B. Tilley, D. Volkov, F. Wang, S. Walcott, Z. Wu, J. Zou

ASSISTANT PROFESSORS: A. Arnold, O. Mangoubi, P. O'Cathain, G. Wang, M. Wu, Z. Zhang

PROFESSOR OF PRACTICE: J. Abraham

TEACHING PROFESSOR: J. Goulet

TEACHING ASSOCIATE PROFESSORS: M. Blais, M. Johnson, B. Posterro

TEACHING ASSISTANT PROFESSOR: B. Peiris

SENIOR INSTRUCTOR: T. Doytchinova

RESEARCH PROFESSOR: V. Druskin

RESEARCH ASSOCIATE PROFESSOR: V. Yakovlev

POST-DOCTORAL SCHOLARS: M. Andrei, G. Contador Revetria, C. Mayer, H. Nasralah, X. Ramos Olivé, C. Wei, D. Wright

EMERITUS PROFESSORS: P. Christopher, P. Davis, W. Farr, W. Hardell, J.J. Malone, B. McQuarrie, J. Petrucelli, D. Vermes, H. Walker

ASSOCIATED FACULTY: F. Emdad (CS), G. Sarkozy (CS), A. Trapp (BUS)

MISSION STATEMENT

Recognizing the vital role that mathematical sciences play in today's society, the Mathematical Sciences Department provides leading-edge programs in education, research, and professional training in applied and computational mathematics and statistics. These programs are enhanced and distinguished by project-oriented education and collaborative involvement with industry, national research centers, and the international academic community.

PROGRAM EDUCATIONAL OBJECTIVES

The department's major programs provide students with preparation for effective and successful professional careers in the mathematical sciences, whether in traditional academic pursuits or in the many new career areas available in today's technologically sophisticated, globally interdependent society. Through course work, students acquire a firm grounding in fundamental mathematics and selected areas of emphasis. Projects, which often involve interdisciplinary and industrial applications, offer further opportunities to gain mathematical depth and to develop skills in problem-solving, communication, teamwork, and self-directed learning, together with an understanding of the role of the mathematical sciences in the contemporary world.

PROGRAM OUTCOMES

We expect graduates to:

1. Have a solid knowledge of a broad range of mathematical principles and techniques and the ability to apply them.
2. Be able to read, write, and communicate mathematics inside and outside the discipline.
3. Have the ability to formulate mathematical statements and prove or disprove them.
4. Be able to formulate and investigate mathematical questions and conjectures.
5. Understand fundamental axiom systems and essential definitions and theorems.
6. Be able to formulate and analyze mathematical or statistical models.
7. Have the ability to apply appropriate computational technology to analyze and solve mathematical problems.
8. Be able to learn independently and as part of a team, and to demonstrate a depth of knowledge in at least one area of the mathematical sciences.

The Department of Mathematical Sciences at WPI offers:

- i) the Bachelor of Science degree in Mathematical Sciences;
- ii) the Bachelor of Science degree in Actuarial Mathematics;
- iii) a Minor in Mathematics;
- iv) a Minor in Statistics;
- v) a combined B.S./M.S. degree in Applied Mathematics, Applied Statistics, Industrial Mathematics, or Financial Mathematics.

Program Distribution Requirements for the Mathematical Sciences Major

The normal period of residency at WPI is 16 terms. In addition to the WPI requirements applicable to all students, completion of a minimum of 10 units of study is required as follows:

REQUIREMENTS	MINIMUM UNITS
1. Mathematics including MQP (See notes 1-5).	7
2. Basic Science (See note 6).	2/3
3. Computer Science (See note 7).	2/3
4. Additional courses or independent studies from other departments that are related to the student's mathematical program, to be selected from basic science, engineering, computer science or business (see Notes 6-8).	2/3
5. Additional courses or independent studies (except AS, MS, PE courses, and other degree requirements) from any area.	3/3

NOTES:

- Must include MA 3831 and MA 3832, or their equivalents, at least one of MA 3257, MA 3457, or equivalent, and at least one of MA 3823, MA 3825, or equivalent.
- Must include at least three of the following: MA 2073, MA 2271, MA 2273, MA 2431, MA 2631, or their equivalents.
- At least 7/3 units must consist of MA courses at the 3000 level or above (the courses in Note 1 count toward this requirement).
- May not include both MA 2631 and MA 2621.
- May not include both MA 2071 and MA 2072.
- Basic science courses must be chosen from the following disciplines: BB, CH, ES, GE, or PH.
- CS courses may not include both CS 3043 and CS 2022.
- Business courses may not include FIN 1250.

PROGRAM IN MATHEMATICAL SCIENCES

PROJECTS

Some of the most active career directions in the mathematical sciences are reflected in the MQP areas around which the department's offerings are organized: Algebraic and Discrete Mathematics, Computational and Applied Analysis, Operations Research, and Probability and Statistics. As early as practical, and certainly no later than the sophomore year, the mathematical sciences major should begin exploring these different areas. The transition courses, MA 2073, 2271, 2273, 2431, and 2631, are specifically designed to introduce the four MQP areas while preparing the student for advanced courses and the MQP. The student should talk to faculty in the student's area of interest to develop and select an MQP and MQP advisor.

While most students choose MQPs in one of the four areas mentioned above, it is possible to design an MQP that does not fit into any one area. In such cases, students will want to take special care to plan their programs carefully with their advisors so that sufficient background is obtained before beginning to do research. Independent studies are a good way for students to learn topics that are not taught in regularly-scheduled courses. Interested students should approach faculty with requests for independent studies.

Through the Center for Industrial Mathematics and Statistics (CIMS), students can use their mathematics and statistics training to work on real-world problems that come from

sponsors in industry and finance. More information about industrial MQPs and projects can be found at <http://www.wpi.edu/+CIMS>.

The following sections contain, for each MQP area:

- A brief description of the area including the kinds of challenges likely to be encountered by MQP students and mathematical scientists working there.
- Courses of interest.

ALGEBRAIC AND DISCRETE MATHEMATICS

Algebraic and discrete mathematics is recognized as an increasingly important and vital area of mathematics. Many of the fundamental ideas of discrete mathematics play an important role in formulating and solving problems in a variety of fields ranging from ecology to computer science. For instance, graph theory has been used to study competition of species in ecosystems, to schedule traffic lights at an intersection, and to synchronize parallel processors in a computer. Coding theory has been applied to problems from the private and public sectors where encoding and decoding information securely is the goal. In turn, the problems to which discrete mathematics is applied often yield new and interesting mathematical questions. The goal of a project in discrete mathematics would be to experience this interaction between theory and application. To begin, a typical project team would assess the current state of a problem and the theory that is relevant. Once this is done, the project team's objective would be to make a contribution to solving the problem by developing new mathematical results.

In working in discrete mathematics, one may be writing algorithms, using the computer as a modeling tool, and using the computer to test conjectures. It is important that a student interested in this area have some computer proficiency. Depending on the project, an understanding of algorithm analysis and computational complexity may be helpful.

Courses of Interest

MA 2271	Graph Theory
MA 2273	Combinatorics
MA 3231	Linear Programming
MA 3233	Discrete Optimization
MA 3823	Group Theory
MA 3825	Rings and Fields
MA 4891	Topics in Mathematics (when appropriate)
CS 2301	Systems Programming for Non-Majors
CS 4120	Analysis of Algorithms
CS 4123	Theory of Computation

COMPUTATIONAL AND APPLIED ANALYSIS

This area of mathematics concerns the modeling and analysis of continuous physical or biological processes that occur frequently in science and engineering. Students interested in this area should have a solid background in analysis which includes the ability to analyze ordinary and partial differential equations through both analytical and computational means.

In most circumstances, an applied mathematician does not work alone but is part of a team consisting of scientists and engineers. The mathematician's responsibility is to formulate a mathematical model from the problem, analyze the model, and then interpret the results in light of the experimental evidence. It is, therefore, important for students to have some experience in mathematical modeling and secure a background in one branch of science or engineering through a carefully planned sequence of courses outside of the department.

With the increase in computational power, many models previously too complicated to be solvable, can now be solved numerically. It is, therefore, recommended that students acquire enough computer proficiency to take advantage of this. Computational skills are important in applied mathematics. Students may learn these skills through various numerical analysis courses offered by the department. An MQP in this area will generally involve the modeling of a real-life problem, analyzing it, and solving it numerically.

Courses of Interest

- MA 2251 Vector and Tensor Calculus
- MA 2431 Mathematical Modeling with Ordinary Differential Equations
- MA 3231 Linear Programming
- MA 3257 Numerical Methods for Linear and Nonlinear Systems

- MA 3457 Numerical Methods for Calculus and Differential Equations
- MA 3471 Advanced Ordinary Differential Equations
- MA 3475 Calculus of Variations
- MA 4235 Mathematical Optimization
- MA 4291 Applicable Complex Variables
- MA 4411 Numerical Analysis of Differential Equations
- MA 4451 Boundary Value Problems
- MA 4473 Partial Differential Equations

OPERATIONS RESEARCH

Operations research is an area of mathematics which seeks to solve complex problems that arise in conducting and coordinating the operations of modern industry and government. Typically, operations research looks for the best or optimal solutions to a given problem. Problems within the scope of

MATHEMATICAL SCIENCES MAJOR PROGRAM CHART

UNIVERSITY REQUIREMENTS	
Minimum Academic Credit	15 Units
Residency	8 Units
Humanities and Arts	2 Units
Interactive Qualifying Project	1 Unit
Major Qualifying Project	1 Unit
Social Science	2/3 Unit
Physical Education	1/3 Unit

FOUNDATION COURSES

INTRODUCTORY COURSES	TRANSITION COURSES (1 Unit Required)	CORE COURSES (4/3 Unit Required)
MA 1021-1024 MA 1020-1120 MA 1033-1034 MA 1971 MA 2051 MA 2071 or MA 2072 MA 2201 MA 2210 MA 2251 MA 2610 MA 2611	MA 2073 MA 2271* MA 2273* MA 2431 MA 2631	Both MA 3831 and MA 3832 One of MA 3257 or MA 3457 One of MA 3823 or MA 3825*

OTHER MA COURSES TO ATTAIN TOTAL OF 6 UNITS:

ACTUARIAL MATH	ANALYSIS	ALGEBRA	DISCRETE MATH	COMPUTATIONAL MATH	OPERATIONS RESEARCH	STATISTICS/PROBABILITY
MA 2211 MA 2212 MA 3212 MA 4213 MA 4214 MA 4892	MA 2431 MA 3471* MA 3475* MA 4291 MA 4451 MA 4473*	MA 2073 MA 3823 MA 3825*	MA 2271* MA 2273* MA 3233*	MA 3257 MA 3457 MA 4411*	MA 3231 MA 3233* MA 4235* MA 4237*	MA 2612 MA 2621 MA 2631 MA 3627* MA 3631 MA 4214* MA 4631 MA 4632 MA 4635

OTHER REQUIREMENTS	
Computer Science Courses	2/3 Unit

* Category II courses, offered in alternating years.

operations research methods are as diverse as finding the lowest cost school bus routing that still satisfies racial guidelines, deciding whether to build a small plant or a large plant when demand is uncertain, or determining how best to allocate timesharing access in a computer network.

Typically, these problems are solved by creating and then analyzing a mathematical model to determine an optimal strategy for the organization to follow. Often the problem requires a statistical model, and nearly always the analysis - whether optimizing through a set of equations or simulating the behavior of a process - involves the use of a computer. Finally, operations researchers must be able to interpret and apply the results of their analyses in an appropriate manner.

In addition to a solid background in calculus, probability and statistics, and the various operations research areas, prospective

operations researchers should be familiar with computer programming and managerial techniques.

Courses of Interest

- BUS 2080 Data Analysis for Decision Making
- MA 2271 Graph Theory
- MA 2273 Combinatorics
- MA 3231 Linear Programming
- MA 3233 Discrete Optimization
- MA 3627 Introduction to the Design and Analysis of Experiments
- MA 3631 Mathematical Statistics
- MA 4222 Top Algorithms in Applied Mathematics
- MA 4235 Mathematical Optimization
- MA 4237 Probabilistic Methods in Operations Research
- MA 4631 Probability and Mathematical Statistics I
- MA 4632 Probability and Mathematical Statistics II
- OIE 3460 Simulation Modeling and Analysis
- OIE 3510 Stochastic Models

ACTUARIAL MATHEMATICS MAJOR PROGRAM CHART

UNIVERSITY REQUIREMENTS	
Minimum Academic Credit	15 Units
Residency	8 Units
Humanities and Arts	2 Units
Interactive Qualifying Project	1 Unit
Major Qualifying Project	1 Unit
Social Science	2/3 Unit
Physical Education	1/3 Unit

FOUNDATION COURSES

INTRODUCTORY COURSES	TRANSITION COURSES (2/3 Unit Required)	CORE COURSES (4/3 Unit Required)	ACTUARIAL COURSES (4/3 Unit Required)
MA 1021-1024 MA 1033-1034 MA 1971 MA 2051 MA 2071 or MA 2072 MA 2201 MA 2210 MA 2211 MA 2251 MA 2611	MA 2073 MA 2271* MA 2273* MA 2431 MA 2631	MA 3631 Both MA 3831 and MA 3832 One of MA 3257 or MA 3457	MA 2212 MA 3212 MA 3213 MA 4213 MA 4214 MA 4892

OTHER MA COURSES TO ATTAIN TOTAL OF 6 UNITS:

ACTUARIAL MATH	ANALYSIS	ALGEBRA	DISCRETE MATH	COMPUTATIONAL MATH	OPERATIONS RESEARCH	STATISTICS/PROBABILITY
MA 2211 MA 2212 MA 3212 MA 3213 MA 4213 MA 4214 MA 4892	MA 2431 MA 3471* MA 3475* MA 4291 MA 4451 MA 4473*	MA 2073 MA 3823* MA 3825*	MA 2271* MA 2273* MA 3233*	MA 3257 MA 3457 MA 4411*	MA 3231 MA 3233* MA 4235* MA 4237*	MA 2612 MA 2631 MA 3627* MA 3631 MA 4214 MA 4631 MA 4632 MA 4635

OTHER REQUIREMENTS

Basic Science (2/3 Unit Required)	Computer Science (2/3 Unit Required)	School of Business (4/3 Unit Required)
	Cross-listed classes (e.g. MA 2201/CS 2022) may only count towards one distribution requirement	

* Category II courses, offered in alternating years.

PROBABILITY AND STATISTICS

In many areas of endeavor, decisions must be made using information which is known only partially or has a degree of uncertainty attached to it. One of the major tasks of the statistician is to provide effective strategies for obtaining the relevant information and for making decisions based on it. Probabilists and statisticians are also deeply involved in stochastic modeling - the development and application of mathematical models of random phenomena. Applications to such areas as medicine, engineering, and finance abound.

Students interested in becoming probabilists or mathematical statisticians should consider additional study in graduate school. While graduate study is an option for students whose goals are to be applied statisticians, there are also career opportunities in business, industry, and government for holders of a Bachelor's degree. More information about careers in statistics can be found at the American Statistical Association's web site <http://www.amstat.org/careers>.

Students planning on graduate studies in this area would be well advised to consider, in addition to the courses of interest listed below, additional independent study or PQP work in probability and statistics, or some of the department's statistics graduate offerings.

Courses of Interest

MA 2611	Applied Statistics I
MA 2612	Applied Statistics II
MA 2631	Probability Theory
MA 3627	Introduction to the Design and Analysis of Experiments
MA 3631	Mathematical Statistics
MA 4237	Probabilistic Methods in Operations Research
MA 4631	Probability and Mathematical Statistics I
MA 4632	Probability and Mathematical Statistics II
MA 4635	Data Analytics and Statistical Learning

PROGRAM IN ACTUARIAL MATHEMATICS

Actuaries provide financial evaluations of risk that help professionals in the insurance and finance industries, and many in large corporations and government agencies make strategic management decisions. Fellowship in the Society of Actuaries or the Casualty Actuarial Society – achieved by passing a series of examinations – is the most widely accepted standard of professional qualification to practice as an actuary.

WPI's program enables students to take the first steps toward preparing for these exams and introduces these majors to the fundamentals of business and economics.

PROJECTS

Off-campus qualifying projects are regularly done in collaboration with insurance companies, and have in the past been sponsored by Aetna, Blue Cross Blue Shield, Hanover, John Hancock, Sun Life, Travelers and Unum. Visit <http://www.wpi.edu/+CIMS>. These projects give real-world experience of the actuarial field by having students involved in solving problems faced by professional actuaries. Instead of choosing a project already posed by a company/advisor team, students may instead seek out industry-sponsored projects on their own (often through internship connections) and propose them to a potential faculty advisor. Alternatively, students may choose to complete any other project in mathematics.

Program Distribution Requirements for the Actuarial Mathematics Major

The normal period of residency at WPI is 16 terms. In addition to the WPI requirements applicable to all students, completion of a minimum of 10 units of study is required as follows:

REQUIREMENTS	MINIMUM UNITS
1. Mathematics (including MQP) (See notes 1-5)	7
2. Basic Science (See note 6)	2/3
3. Computer Science	2/3
4. Business (See note 7)	4/3
5. Additional courses or independent studies (except AS, MS, PE courses, and other degree requirements) from any area	1/3
6. Actuarial Seminar (See note 8)	0/3

NOTES:

- Must include MA3212, MA3631, MA3831 and MA3832, or their equivalents, and at least one of MA3257, MA3457, or equivalent
- Must include two of the following: MA 2073, MA 2271, MA 2273, MA 2431, MA 2631, or their equivalents
- Must include three of the following: MA 2212, MA 3213, MA 4213, MA 4214, MA 4892, or their equivalents
- May include independent studies directed towards Society of Actuaries exams only if the material was not previously covered in a WPI course
- May not include both MA 2631 and MA 2621
- Basic science courses must be chosen from the following disciplines: BB, CH, ES, GE, or PH
- Business courses must be chosen from courses with any of the following prefixes: ACC, BUS, or FIN. BUS 2060, BUS 2070, and FIN 3300 are recommended.
- The actuarial seminar is a graduation requirement. Students must complete this seminar in at least four terms while at WPI. Please consult with the actuarial faculty for more details about this requirement.

Students interested in pursuing a degree in Actuarial Mathematics should contact Professor Abraham, the Coordinator of the Actuarial Mathematics Program, as soon as possible.

MINOR IN STATISTICS

Statistical methods are widely used in science, engineering, business, and industry. The Statistics Minor is appropriate for all WPI students with interests in experimental design, data analysis, or statistical modeling. The minor is designed to enable a student to properly design studies and analyze the resulting data, and to evaluate statistical methods used in their field of study. Students should discuss course selections for the minor in advance with a statistics faculty member, who serves as the Minor Advisor. The student must complete the Statistics Minor Program Planning and Approval Form, and have it signed by the Minor Advisor. Students are encouraged to do this as early as possible, but it must be done prior to starting the Capstone. The statistics minor consists of completion of at least 2 units of work, which must consist of:

- At least 5/3 units of coursework, which must be drawn from the following lists of Foundation and Upper-Level Courses, and which must include successful completion of at least 2/3 units from each list:

Courses for Statistics Minor (5/3 Unit Required)

Foundation Courses (2/3 Unit Required)

MA 2073	Matrices and Linear Algebra II
MA 2611	Applied Statistics I
MA 2612	Applied Statistics II
MA 2631	Probability Theory, or
MA 2621	Probability for Applications

Upper-Level Courses (2/3 Unit Required)

MA 3627	Introduction to the Design and Analysis of Experiments
MA 3631	Mathematical Statistics
MA 4213	Risk Theory
MA 4214	Survival Models
MA 4237	Probabilistic Methods in Operations Research
MA 4631	Probability and Mathematical Statistics I
MA 4632	Probability and Mathematical Statistics II
MA 4635	Data Analytics and Statistical Learning
Any statistics graduate course:	
MA 509 or any course numbered MA 540 through MA 559	

- The final 1/3 unit Capstone Experience: The capstone experience may be satisfied by certain 3000-level, 4000-level or graduate courses offered by the department or by a suitable independent study with one of the department's statistics faculty. The Capstone must be approved in advance by having the Capstone instructor sign the Statistics Minor Program Approval Form. After completion of the Capstone Experience, the Statistics Minor Program Planning and Approval Form is submitted to the Mathematical Sciences Program Review Chair for final approval.

For information about the Statistics Minor, see any of the statistics faculty: Professor Buddika Peiris, Balgobin Nandram, Zheyang Wu or Jian Zou.

MINOR IN MATHEMATICS

The Minor in Mathematics consists of the successful completion of at least 2 units of academic activities in mathematical sciences.

Students should discuss course selections for the minor in advance with a member of the mathematical sciences faculty who will serve as the Minor Advisor. The student must complete the Mathematics Minor Program Planning and Approval Form and have it signed by the Minor Advisor. Students are encouraged to do this as early as possible, but it must be done prior to starting the Capstone. The following requirements must be satisfied.

- At least 5/3 units must be coursework in the Mathematical Sciences Department at the 2000 level or above, of which at least 2/3 units must be upper-level courses, i.e. 3000-level, 4000-level, or graduate mathematics courses. Courses selected at the 2000 level, if any, must include at least one of the following courses:

MA 2073	Matrices and Linear Algebra II
MA 2251	Vector and Tensor Calculus
MA 2271	Graph Theory
MA 2273	Combinatorics
MA 2431	Mathematical Modeling with Ordinary Differential Equations
MA 2631	Probability Theory
- The final 1/3 unit Capstone Experience: The experience may be satisfied by certain 3000-level, 4000-level or graduate courses offered by the department or by a suitable independent study with a Mathematical Sciences faculty member. The Capstone must be approved in advance by having the Capstone instructor sign the Mathematics Minor Planning and Approval Form. After completion of the Capstone

Experience, the Mathematics Minor Program Planning and Approval Form is submitted to the Mathematical Sciences Program Review Chair for final approval.

Here are some examples of 5/3 units of coursework for five thematically-related minors. Other options are available.

Applied Analysis	Computational Analysis	Differential Equations	Discrete Mathematics	Operations Research
MA 2051	MA 2051	MA 2051	MA 2201	MA 2071
MA 2071	MA 2071	MA 2251	MA 2271	MA 2073
MA 2431	MA 2073	MA 3471	MA 2273	MA 3231
MA 3831	MA 3257	MA 4411	MA 3233	MA 3233
MA 3832	MA 3457	MA 4473	MA 533	MA 4235 or MA 4237

For more information about the Mathematics minor, see Professor Fehrbach, who is the coordinator for Mathematics minors.

MECHANICAL ENGINEERING**J. YAGOobi, HEAD**

PROFESSORS: D. Apelian, I. Braun, C. A. Brown, M. Demetriou, M. Dimentberg, G. Fischer, C. Furlong, N. A. Gatsonis, S. Gucer, Z. Hou, D. Lados, J. Liang, M. M. Makhlof, B. Mishra, B. Panchapakesan, B. J. Savilonis, S. Shivkumar, R. D. Sisson, Jr., W. Soboyejo, J. M. Sullivan, Jr., Y. Wang

ASSOCIATE PROFESSORS: H. K. Ault, J. Blandino, R. Cowlagi, C. Demetry, M. Fofana, D. J. Olinger, C. Onal, A. Powell, P. Rao, M. W. Richman, Y. Zhong

ASSISTANT PROFESSORS: D. Cote, J. Jayachandran, N. Karanjgaokar, Z. Li, Y. Liu, S. Narra, Y. Zheng

TEACHING PROFESSORS: M. Bhatia, E. Cobb, R. Daniello, F. Levey, D. Planchard, P. Radhakrishnan, A. Sabuncu, C. Scarpino, J. Stabile, Z. Taillefer, S. Wodin-Schwartz

ASSOCIATE D FA CULTY : N. Bertozzi (RBE), K. Billiar (BME), K. Chen (STEM), N. Dembsey (FPE), M. Emmert (CBC), G. Gaudette (BME), S. Ji (BME), S. Johnson (BUS), R. Konrad (BUS), R. Ludwig (ECE), K. Notarianni (FPE), N. Rahbar (CEE), A. Rangwala (FPE), D. Strong (BUS), B. Tilley (MA), W. Towner (BUS), K. Troy (BME)

EMERITUS PROFESSORS: R. Biederman, J. M. Boyd, A.H. Hoffman, J. A. Mayer, Jr., R. L. Norton, R. J. Pryputniewicz

MISSION STATEMENT

The Mechanical Engineering program at WPI aims to graduate students who have the broad expertise required to confront real world technological issues that arise in our society. Students in the program are educated to apply scientific principles and engineering methods to analyze and design systems, processes, and products that, when engineered properly, improve the quality of our lives. The Mechanical Engineering program is consistent with the WPI philosophy of education, in which each student develops the tools required for self-learning, and the sensibility to consider the impact of technology on society in the decisions they will make as engineering professionals.

PROGRAM EDUCATIONAL OBJECTIVES

The Mechanical Engineering Program seeks to have alumni who:

- are successful professionals because of their mastery of the fundamental engineering sciences, and mechanical engineering and their understanding of design processes.
- are leaders in business and society due to a broad preparation in technology, communication, teamwork, globalization, ethics, business acumen and entrepreneurship.
- will use their understanding of the impact of technology on the safety, health and welfare of the public for the betterment of humankind.

STUDENT OUTCOMES

Graduating students should demonstrate that they attained the following:

- an ability to identify, formulate, and solve complex engineering problems by applying principles of engineering, science, and mathematics
- an ability to apply engineering design to produce solutions that meet specified needs with consideration of public health, safety, and welfare, as well as global, cultural, social, environmental, and economic factors
- an ability to communicate effectively with a range of audiences
- an ability to recognize ethical and professional responsibilities in engineering situations and make informed judgments, which must consider the impact of engineering solutions in global, economic, environmental, and societal contexts
- an ability to function effectively on a team whose members together provide leadership, create a collaborative and inclusive environment, establish goals, plan tasks, and meet objectives
- an ability to develop and conduct appropriate experimentation, analyze and interpret data, and use engineering judgment to draw conclusions
- an ability to acquire and apply new knowledge as needed, using appropriate learning strategies.

Program Distribution Requirements for the Mechanical Engineering Major

The normal period of residency at WPI is 16 terms. In addition to WPI requirements applicable to all students (see page 7), students wishing to receive the ABET-accredited degree designated "Mechanical Engineering" must satisfy certain additional distribution requirements. These requirements apply to 10 units of study in the areas of mathematics, basic science, and engineering science and design as follows:

REQUIREMENTS	MINIMUM UNITS
1. Mathematics and Basic Science (Notes 1, 2).	3 2/3
2. Engineering Science and Design (includes MQP) (Notes 3, 4, 5, 6, 7).	6 1/3

NOTES:

1. Must include a minimum of 2 units of mathematics, including differential and integral calculus and differential equations, and linear algebra.
2. Must include a minimum of 1/3 unit in chemistry and 2/3 unit in physics, or 1/3 unit in physics and 2/3 unit in chemistry.
3. Must include 1/3 unit in programming
4. Must include 1/3 unit in each of the following: electrical engineering, materials science, and mechanical engineering experimentation.
5. May include 1000 level courses only if designated ES or ME.
6. Must include two stems of coherent course and/or project offerings as noted below in a and b.
 - a. A minimum of 4/3 unit of work in thermofluid systems that includes the topics of thermodynamics, fluid mechanics and heat transfer, plus 1/3 unit at or above the 4000 level that integrates thermofluid design.
 - b. A minimum of 4/3 unit of work in mechanical systems that includes the topics of statics, stress analysis, and dynamics, plus 1/3 unit at or above the 4000 level that integrates mechanical design.
7. Must include 1/3 unit of Capstone Design Experience.

Each Mechanical Engineering student must complete a Capstone Design experience requirement. This capstone design experience can be partially or fully accomplished by completing a Major Qualifying Project which integrates the past course work and involves significant engineering design. At the time of registration for the MQP, the project advisor will determine whether the MQP will meet the Capstone Design requirement or not. If not, the academic advisor will identify an additional 1/3 unit of course work in the area of thermofluid design (ME 4422, ME 4429) or mechanical design (ME 4320, ME 4322, or ME 4810) to be taken in order to meet the ABET Capstone Design requirement.

MECHANICAL ENGINEERING DEPARTMENT CONCENTRATIONS

BIOMECHANICAL (AULT)

Students blend biology and biotechnology coursework with continuum mechanics, biomechanics, biofluids, and biomedical materials to support their individual interest. MQPs are usually developed jointly with off-campus medical facilities, including the University of Massachusetts Medical Center.

Typically MQP topics include: soft tissue mechanics, flow in constricted blood vessels, joint kinematics, prosthetic devices, sports biomechanics, biomaterials, tissue engineering and rehabilitation.

Biomechanical

Two (2) Biology and Biotechnology (BB) Courses

Select 4

ME 3501	Elementary Continuum Mechanics
ME 3506	Rehabilitation Engineering
ME/BME 4504	Biomechanics
ME/BME 4606	Biofluids
ME/BME 4814	Biomaterials

Any BME course at the 3000-level or higher except BME 3300

* Plus Biomechanical-related MQP

ENGINEERING MECHANICS (HOU)

Students select courses to develop the ability to construct models to analyze, predict, and test the performance of solid structures, fluids, and composite materials under various situations.

Typical MQP topics include: mechanical vibrations, stress and strain analysis, computer methods in engineering mechanics, finite element analysis, and vibration isolation. Departmental testing facilities and computer and software support are available.

Engineering Mechanics

Select 6

AE 3410	Compressible Fluid Dynamics
ME 3501	Elementary Continuum Mechanics
ME 3506	Rehabilitation Engineering
AE 3602	Incompressible Fluids
AE 3712	Aerospace Structures
ME/BME 4504	Biomechanics
ME 4505	Advanced Dynamics
ME 4506	Mechanical Vibrations
ME 4512	Introduction to the Finite Element Method
AE 5202	Advanced Dynamics

**Plus Engineering Mechanics MQP*

MANUFACTURING (SISSON)

Courses are available to support student interest in manufacturing engineering, computer-aided design, computer-aided manufacturing, robotics, vision systems, and a variety of manufacturing processes. Typical MQPs include: robotics, composite materials, factory automation, materials processing, computercontrolled machining, surface metrology, fixturing, machine dynamics, grinding, precision engineering, prototype manufacturing, and additive manufacturing.

Manufacturing

Select 2

ME 1800	Manufacturing Science Prototyping & Computer Controlled Machining
ME 2820	Materials Processing
ME 4810	Automotive Materials and Process Design
ME 4821	Plastics

Select 2

ES 3011	Control Engineering I
ME 3820	Computer-Aided Manufacturing
ME/RBE 4815	Industrial Robotics

Select 2

BUS 3020	Achieving Effective Operations
OIE 2850	Engineering Economics
OIE 3410	Materials Management in Supply Chains
OIE 3420	Quality Planning, Design and Control

** Plus Manufacturing MQP*

MATERIALS SCIENCE AND ENGINEERING (SISSON)

Students interested in a strong materials science and engineering component can elect course and project activities in metals, ceramics, polymers, and composite materials with laboratory and project experience using facilities in Washburn Shops and Stoddard Laboratories. Typical MQP topics include: materials processing, materials characterization with X-ray diffraction, optical and electron microscopy, computer modeling of

properties and processing, mechanical testing and fatigue, biomaterials, recourse recovery and recycling, photovoltaics, electrochemical energy systems (batteries and fuel cells), corrosion, surface engineering and surface metrology. Another option in the materials program is a Minor in Materials Science and Engineering, which is described under Materials Engineering in this catalog.

Materials Science and Engineering

Select 6

ME 2820	Materials Processing
ME 4718	Advanced Materials with Aerospace Applications
ME 4810	Automotive Materials and Process Design
ME 4813	Ceramics and Glasses for Engineering
ME 4814	Biomaterials
ME 4821	Plastics
ME 4832	Corrosion and Corrosion Control
ME 4840	Physical Metallurgy
ME 4875	Introduction to Nanomaterials and Nanotechnology

MTE/ME 5847 Materials for Electrochemical Energy Systems

Any 500-level MTE course

** Plus Materials Science MQP*

MECHANICAL DESIGN (AULT)

Courses are available to support development of student interest in the design, analysis, and optimization of an assembly of components which produce a machine. Computer-based techniques are widely used in support of these activities.

Typical MQP topics are: optimum design of mechanical elements, stress analysis of machine components, evaluation and design of industrial machine components and systems, robotics, and computer-aided design and synthesis.

Mechanical Design

2 Required

ME 3310	Kinematics of Mechanisms
ME 3320	Design of Machine Elements

Select 4

ES 1310	Computer-Aided Design
ES 3323	Advanced Computer-Aided Design
ME 2300	Introduction to Engineering Design
ME 3311	Dynamics of Mechanisms and Machines
ME 3506	Rehabilitation Engineering
ME 4320	Advanced Engineering Design
ME/RBE 4322	Modeling and Analysis of Mechatronic Systems
ME 4810	Automotive Materials and Process Design
ME/RBE 4815	Industrial Robotics

** Plus Mechanical Design MQP*

ROBOTICS (FISCHER)

Students select courses to give them a solid foundation in the various aspects of robotics, including kinematics and actuators, sensors, and control and computing. In addition to relevant mechanical engineering courses, students can select courses from electrical engineering and computer science.

Typical MQP topics include designing of robots and robotic components, including mobile ground robots, aerial robots and underwater robots, automatic assembly and industrial robotics applications, and development of software and control algorithms for individual robots and robotic swarms.

MECHANICAL ENGINEERING PROGRAM CHART

STUDENTS EARNING A B.S. DEGREE IN MECHANICAL ENGINEERING MUST COMPLETE 15 UNITS OF STUDY, DISTRIBUTED AS FOLLOWS:

4 UNITS OF NON-TECHNICAL ACTIVITIES

2 UNITS HUMANITIES AND ARTS	<i>See WPI Requirements</i>
1 UNIT INTERACTIVE QUALIFYING (IQP) PROJECT	<i>See WPI Requirements</i>
2/3 UNIT SOCIAL SCIENCE	<i>See WPI Requirements</i>
1/3 UNIT PHYSICAL EDUCATION	<i>See WPI Requirements</i>

1 UNIT FREE ELECTIVE

1 UNIT FREE ELECTIVE	<i>See Catalog</i>
-----------------------------	--------------------

3 2/3 UNITS OF MATHEMATICS (MA) AND BASIC SCIENCE (BB, CH, GE 2341, PH)

MATHEMATICS	
MA 1021	MA 1023
MA 1022	MA 1024
MA 2051	MA 2071

2/3 Units
Student Selected Courses from the General Category of Mathematics and/or Basic Science

2 Units
Differential & Integral Calculus, Ordinary Differential Equations, and Linear Algebra

3/3 Units
One Chemistry and Two Physics, OR
One Physics and Two Chemistry

SCIENCE	
CH 1010	CH 1020
PH 1110	PH 1120

6 1/3 UNITS OF MECHANICAL ENGINEERING

4/3 units required	4/3 units required	4/3 units required	1 unit required	4/3 units required
MECHANICAL SYSTEMS	THERMAL SYSTEMS	OTHER COURSES	MAJOR QUALIFYING PROJECT (MQP)	ELECTIVES
ES 2501 ES 2502 ES 2503 One of: ME 4320 ME 4322 ME 4810	ES 3001 ² ES 3004 ES 3003 One of: ME 4422 ME 4429	ES 2001 ECE 2010 ³ ME 3901 Programming (ME 2312, ME 4512, BME 1004, CS 1101, or CS 1004)		Engineering (Note 1)

Note 1: Elective courses from engineering disciplines may be selected at the 2000 or higher level. They may also include ES and ME courses at the 1000 level.

Note 2: ES 3001 may be replaced by CH 3510 or PH Thermodynamics. If CH or PH is used to cover thermodynamics, this course counts as a science; another engineering elective is then required.

Note 3: ECE 2010 or any ECE course other than ECE 1799.

Robotics

3 Required

RBE 2001	Unified Robotics I
ES 3011	Control Engineering I or ME 3310 Kinematics of Mechanisms
ME/RBE 4322	Modeling and Analysis of Mechatronic Systems or ME/RBE 4815 Industrial Robotics

Select 3

CS 2102	Object-Oriented Design Concepts or CS 2103 Accelerated Object-Oriented Design Concepts
CS 2301	Systems Programming for Non-Majors or CS 2303 Systems Programming Concepts
CS 3733	Software Engineering
CS 4341	Introduction to Artificial Intelligence
ECE 2049	Embedded Computing in Engineering Design
ECE 2311	Continuous-Time Signal and System Analysis
ECE 2312	Discrete-Time Signal and System Analysis
ECE 4703	Real Time Digital Signal Processing
ES 3011	Control Engineering I (If not selected above)
ES 3323	Advanced Computer-aided Design
ME 3310	Kinematics of Mechanisms (If not selected above)
ME/RBE 4815	Industrial Robotics (If not selected above)
RBE 2002	Unified Robotics II: Sensing
RBE 3001	Unified Robotics III: Manipulation
RBE 3002	Unified Robotics IV: Navigation

Plus Robotics MQP*Others courses with approval from the ME Undergraduate Committee.***THERMAL-FLUID ENGINEERING (YAGOABI)**

Students study the theoretical and empirical bases of thermodynamics, heat transfer, mass transfer, and fluid flow, as well as the application of these fundamental engineering sciences to energy conversion, environmental control, and vehicular systems.

Typical MQPs include: biological fluid mechanics, laminar/turbulent separation, lifting bodies, heat pipes, electronic component cooling, power cycles, thermal-fluid component analysis and design, and energy storage.

Thermal-Fluid Engineering

3 Required

AE 3410	Compressible Fluid Dynamics
ME 3411	Intermediate Fluid Mechanics
ME 4422	Design and Optimization of Thermal Systems
ME 4424	Radiation Heat Transfer Application and Design
ME 4429	Thermodynamic Applications
AE 4711	Fundamentals of Air-Breathing Propulsion

Select 3

ES 3002	Mass Transfer
ME 3501	Continuum Mechanics
ME 4422	Design and Optimization of Thermal Systems
ME 4424	Radiation Heat Transfer Application and Design
ME 4429	Thermodynamic Applications
ME 4430	Integrated Thermochemical Design and Analysis
ME/BME 4606	Biofluids
AE 4711	Fundamentals of Air-Breathing Propulsion

Plus Thermal-Fluids related MQP*NOTES:**

1. A Concentration area requires a 1 unit of MQP in that area.
2. After consultation with their academic advisor, students may petition the M.E. Dept. Curriculum Committee for approval of a Concentration plan at any time, preferably prior to the middle of their Junior Year.

ENHANCED PROGRAMS**BACHELOR/MASTER'S PROGRAM IN MECHANICAL ENGINEERING**

Outstanding students are encouraged to combine a master's degree with their undergraduate WPI studies. Details are found in the WPI GRADUATE PROGRAM section of this catalog, and interested students should initiate discussions with their advisor early in their junior year.

COOPERATIVE EDUCATION PROGRAM

The WPI Cooperative Education Program provides an opportunity to integrate "real-world" experience into an educational program. Details are found in the COOPERATIVE EDUCATION PROGRAM section on page 228.

MINOR IN MECHANICAL ENGINEERING

For students who are not ME majors and are interested in broadening their exposure to and understanding of Mechanical Engineering, the ME department offers a Minor.

The Minor in Mechanical Engineering consists of 2 units of work from the lists below:

1. Select at least 4/3 unit from the following: ES 2001, ES 2501, ES 2502, ES 2503, ES 3001, ES 3003, ES 3004, ES 3323, ME 3901
2. Select no more than 1/3 unit from the following: ES 1020, ES 1310, ME 1800.
3. Must include at least 1/3 unit of the following : ME 3310, ME 3320, ME 4320, ME 4322, ME 4422, ME 4424, ME 4429, ME 4505, ME 4506, ME 4810.

Students seeking an ME Minor should complete an ME-Minor form, available online and at the ME office, and submit it to the ME office as early in the program of study as possible. The chair of the ME Undergraduate Curriculum Committee will be responsible for review and approval of all ME Minor requests.

WPI policy requires that no more than one unit of course work can be double counted toward other degree requirements.

MINOR IN MANUFACTURING ENGINEERING

A minor in Manufacturing Engineering gives students from a variety of majors the opportunity to strengthen their academic preparation and attractiveness to industry, while better preparing them to solve many of the problems that will challenge them in their careers. Most engineers are involved directly or indirectly with manufacturing or manufacturing principles. Manufacturing expertise is essential to all industrialized, developing and even post industrialized societies. The objective of the minor in manufacturing will be to give the students a solid understanding of the principles of production, processing, manufacturability, and quality that can be applied to a wide variety of products, including non-traditional products, such as software, service and information.

The minor requires the completion of 2 units of work as follows.

I. 1 unit of required course work selected from the following list:

ME 1800	Manufacturing Science Prototyping & Computer Controlled Machining
ME 2820	Materials Processing
ME 3820	Computer-Aided Manufacturing
ES 3011	Control Engineering I

II. 2/3 unit of electives, selected from the following list of courses:

_____	any of the courses above, in I., can count if the other three are completed.
BUS 3020	Achieving Effective Operations
CS 4032/MA 3257	Numerical Methods for Linear and Nonlinear Systems
CS 4341	Introduction to Artificial Intelligence
ES 3323	Advanced Computer Aided Design
ME 3310	Kinematics of Mechanisms
ME/RBE 4815	Industrial Robotics
ME 4821	Plastics
OIE 3420	Quality Planning, Design and Control
MFE 510	Control and Monitoring of Manufacturing Processes
MFE 511	Application of Industrial Robotics
MFE 520	Design and Analysis of Manufacturing Processes
MFE 530	Computer Integrated Manufacturing
MFE 540	Design for Manufacturability

III. 1/3 unit of capstone experience:

RBE/ME 4815	Industrial Robotics
MFE 598	Independent Study Project (this must be approved by the MFE minor program committee)
MFE 510	Control and Monitoring of Manufacturing Processes
MFE 511	Application of Industrial Robotics
MFE 520	Design and Analysis of Manufacturing processes
MFE 530	Computer Integrated Manufacturing
MFE 540	Design for Manufacturability

MATERIALS ENGINEERING

Courses and programs of study in materials engineering are included in the Mechanical Engineering Department (page 102). For advisory information, consult that section of the Undergraduate Catalog or members of the materials section of Mechanical Engineering.

MINOR IN MATERIALS

Material properties, material processing issues, or material costs are the limiting factor in the design or performance of almost all systems around us. Engineers, scientists, and managers in all technological sectors often must make material selection decisions based on a variety of considerations, including properties, performance, environmental impact, and cost. A Minor in Materials, feasible within a 15 unit program of study, will benefit students who wish to enhance their disciplinary major with an additional degree designation in the area of materials.

REQUIREMENTS FOR THE MATERIALS MINOR:

The minor requires the completion of 2 units of work as described below:

1. ES 2001 Introduction to Material Science (1/3 unit)

2. 1-1/3 units of electives, selected from the following list of courses^{b,c}:

CE 3026	Materials of Construction
CH 3410	Structure, Bonding, and Reactivity in Inorganic Chemistry
CH 2310	Organic Chemistry I
CH 2320	Organic Chemistry II
CH 2330	Organic Chemistry III
CH 4330	Organic Synthesis
ECE 4904	Semiconductor Devices
ME 2820	Materials Processing
ME/AE 4718	Advanced Materials with Aerospace Applications
ME 4810	Automotive Materials and Process Design
ME 4813	Ceramics and Glasses for Engineering Applications
ME/BME 4814	Biomaterials
ME 4821	Plastics
ME 4832	Corrosion and Corrosion Control
ME 4840	Physical Metallurgy
ME 4875	Introduction to Nanomaterials and Nanotechnology
MTE/ME 5847	Materials for Electrochemical Energy Systems
PH 2510	Atomic Force Microscopy
PH 3502	Solid State Physics

Students who are able to design their undergraduate program of study such that they have sufficient preparation may also use the following graduate courses toward a Materials Minor: all MTE graduate courses; CHE 510 Dynamics of Particulate Systems, CHE 531 Fuel Cell Technology.

3. Capstone Experience (1/3 unit)

The capstone experience requirement for the Minor in Materials must be satisfied by an upper level course or ISU activity that integrates and synthesizes material processing, structure, and property relationships as they affect performance.

- i) Courses that satisfy the capstone experience requirement currently include ME 4810, ME 4813, ME 4814, and ME 4821. Other courses must be approved in advance by the Program Committee for the Minor in Materials.
- ii) Students may satisfy the capstone experience requirement by completing a 1/3 unit ISU that receives prior approval from the Program Committee for the Minor in Materials. The ISU may, for example, take the form of a laboratory experience or may augment the MQP or IQP, considering in depth the materials issues associated with the project topic (see Note d). An ISU related to the MQP must be distinct from the core 1 unit of the MQP and in most cases would be advised by a faculty member other than the MQP advisor.

NOTES:

- a. In accordance with the Institute-wide policy on Minors, academic activities used in satisfying the regular degree requirements may be double-counted toward meeting all but one unit of the Minor requirements (see page 11).
- b. Physics ISU courses in Superconductors, Photonics, and Lasers may also be counted toward the Materials Minor. In addition, other new or experimental course offerings in the materials area may be approved by the Materials Minor Program Review Committee.

- c. Examples: An ECE major designing an integrated circuit for their MQP might conduct a separate analysis of the materials issues related to heat management in the device as the capstone experience for the Minor in Materials; a ME major specifying a gear in a design MQP might conduct a separate analysis of the material processing, structure, and property issues affecting fatigue life of the gear.
- d. In accordance with the Institute-wide policy on Minors, the Major Qualifying Project (MQP) cannot be counted toward activity for a Minor. Therefore, a ME, CHE, or any other major whose MQP is judged to be predominantly in the materials area by the Program Review Committee may not count an extra 1/3 unit augmentation of their MQP as their capstone experience in the Minor.
- e. The following faculty serve as the Program Review Committee for the Minor in Materials and will serve as Minor Advisors: Richard Sisson (ME), Chrys Demetry (ME), Tahar El-Korchi (CEE).

MILITARY SCIENCE

LTC A. D. HEPPE

PROFESSOR: LTC A. D. HEPPE

ASSISTANT PROFESSOR: MAJ M. Liarikos

INSTRUCTORS: MSG A. Sutton, SFC E. Mejia

MISSION STATEMENT:

The Military Science and Leadership Program (Army ROTC) is a premiere leadership program offered by WPI. Open to all students within the Worcester Consortium, the program teaches valuable leadership skills and managerial traits that prepare students for careers in both the private and public sectors. Students partake in hands-on experiences that integrate traditional coursework with innovative training. Students develop strong decision-making and organizational management skills, while cultivating team-building and interpersonal skills, as well as mastering time and stress management techniques.

MILITARY SCIENCE COURSE FLOW CHART

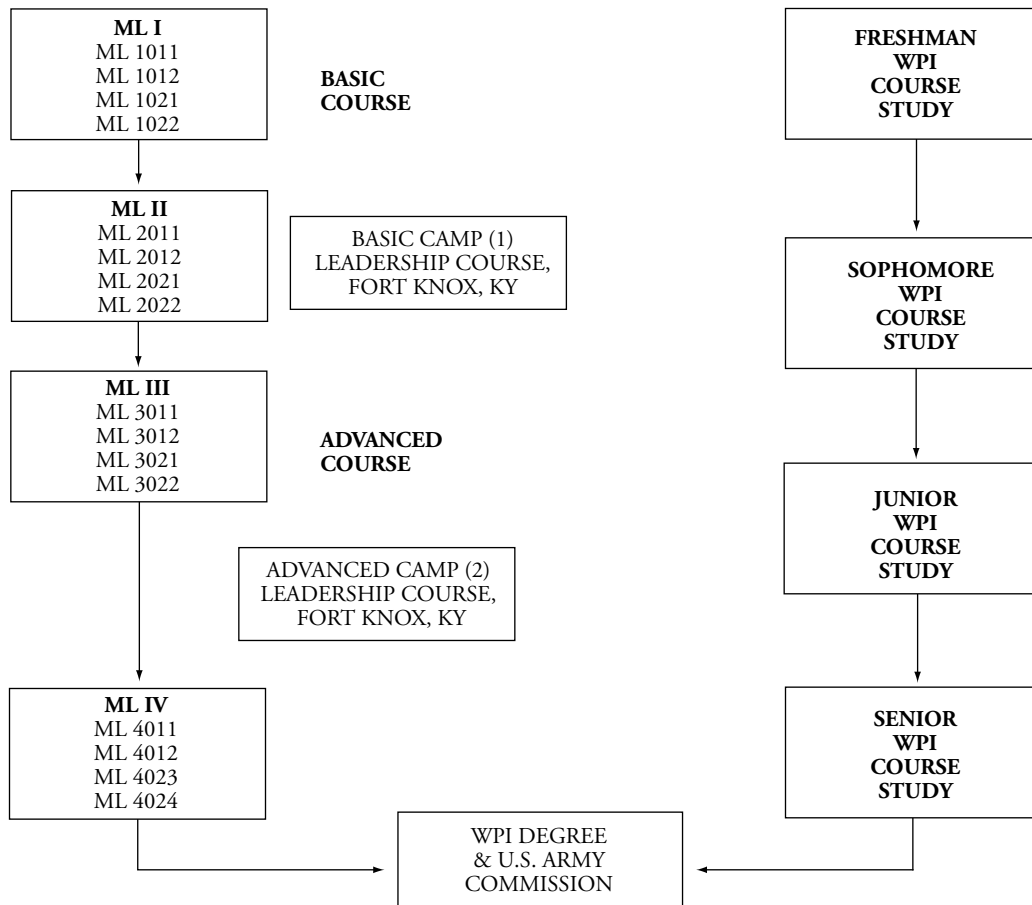

(1) Required for 2 year ROTC program students who did not complete the full Basic Course.

(2) Required attendance for all Juniors and Seniors.

OBJECTIVES AND OUTCOMES:

WPI's Army ROTC prepares multi-faceted future leaders. Students who participate in Army ROTC while pursuing their undergraduate and graduate studies are extremely marketable and highly sought after for their problem-solving and adaptable capabilities. As technology continues to transform organizations and corporations, ROTC students are at the forefront of these cutting-edge developments.

PROGRAM DESCRIPTIONS:

The Military Science and Leadership program is intended to be a four-year program which encourages personal growth and cultivates overall character development.

A. THE BASIC COURSE:

The Basic Course serves as the foundation of the Army ROTC program and is taken over the first two years. The focal points of the Basic Course are leadership, teambuilding and communication skills. Students participate in adventure training (such as orienteering, rappelling and paintball) to put classroom teachings and core concept-strategies to practice.

Students may participate in the first two years of the program commitment free. Students awarded full-tuition scholarships or who participate in the Advanced Course (described below) incur a service obligation and may serve in the Army either full-time or part-time.

B. ADVANCED COURSE:

The Advanced Course is a more intensive leadership program that is taken during the Junior and Senior years, or, during two years of graduate studies. The curriculum continues its focus on problem solving and team building exercises while incorporating military tactics and Ethics.

Students interested in earning a commission as an Army Officer are required to enroll in the Advanced Camp (AC) at Ft Knox, Kentucky. AC is a six-week leadership and tactical course that students are paid to attend during the summer; it is the culmination of the students' training over their tenure on campus. If students decide later in their academic career that they would like to pursue Army ROTC, there are alternate entry options that allow them to receive Basic Course credit and to prepare them for Advanced Camp (1).

Students attending on an Army ROTC Scholarship receive a yearly book-allowance of \$1,200 in addition to a monthly stipend. Both "scholarship" and "contracted, non-scholarship" students receive a monthly stipend of \$420.00. Students interested in pursuing scholarships or enrolling in the Advanced Course must meet specific eligibility requirements.

PHYSICAL EDUCATION, RECREATION, AND ATHLETICS

**D HARMON: DIRECTOR OF PHYSICAL EDUCATION,
RECREATION AND ATHLETICS**

L MOREAU: DIRECTOR OF PHYSICAL EDUCATION

A MCCARRON: DIRECTOR OF CLUB SPORTS

REQUIREMENTS

Qualification in physical education shall be established by completing 1/3 unit of course work. Students are strongly urged to complete this graduation requirement in their first two years of residency at WPI. Students may take classes multiple times for credit. We do not offer independent study options in Physical Education. In addition to PE 1000-series course offerings, students may satisfy their PE requirement by the following:

1. WPI approved varsity athletic team participation (PE 2000-series). Student must be registered with instructor permission in advance of participation. No retroactive credit will be awarded if failure to register.
2. Club Sports (PE 1200-series). Students must be members of a PE approved club prior to becoming eligible for physical education credit and by meeting established department policies for credit. Students must be registered in advance of participation; no retroactive credit will be awarded if failure to register in advance. Additional fees for some clubs may apply.
3. Approved courses not offered at WPI; advance approval by the Physical Education Department is necessary so students are encouraged to contact the department directly in advance to review. No retroactive credit will be awarded if failure to receive advance approval.
4. Participation in certain ROTC programs may entitle students to a receive PE credit. Students in ROTC programs should review in advance with their respective commanders.

**GENERAL PHYSICAL EDUCATION COURSES
(PE 1000 SERIES)**

This series is offered to provide a variety of courses in the more traditional sport-based area of physical education. These courses can serve the beginner to the more experienced in each activity area. PE 1000 series courses meet twice a week (generally between 8am-5pm) at predetermined times with attendance and participation major factors in a student's final grade.

**HEALTHY ALTERNATIVE PHYSICAL EDUCATION
COURSES (PE 1099)**

These PE courses are offered to provide a variety of wellness, dance and healthy alternatives to traditional PE sport-based classes. These classes are subject to change on a yearly basis in order to provide flexibility in the PE offerings based upon the latest trends in wellness and dance. The focus of these classes is more on individual fitness, wellness and education, with instruction provided to all students in the classes.

THE CLUB SPORTS PROGRAM (PE 1200-SERIES)

The club sports program involves activities in various sports and wellness that are organized and recognized by the Student Government Association as Class II organizations and open to any undergraduate student (more information regarding Club Sports can be found at wpi.edu/+techsync). Students who are properly registered in advance for the club activity in their interest area and who meet the established criteria for participation by the club as well as by PERA department policy, may be eligible for PE course credit. Practice and/or competition times will vary but are generally in the evenings and weekends. Participating students may incur additional fees for equipment, travel, and/or uniforms.

NOTE: Some club sports listed below may not be offered in every academic year.

PE 1201	Club Sport - Alpine Ski Team
PE 1202	Club Sport - Badminton
PE 1203	Club Sport - Ballroom Dancing
PE 1204	Club Sport - Dance Team
PE 1205	Club Sport - Fencing Team
PE 1206	Club Sport - Ice Hockey Team
PE 1207	Club Sport - Karate
PE 1208	Club Sport - Men's Rugby Team
PE 1209	Club Sport - Women's Rugby Team
PE 1210	Club Sport - Men's Ultimate Frisbee Team
PE 1211	Club Sport - Women's Ultimate Frisbee Team
PE 1212	Club Sport - Men's Lacrosse Team
PE 1213	Club Sport - Women's Lacrosse Team
PE 1214	Club Sport - Men's Volleyball Team
PE 1215	Club Sport - Outing: Bouldering
PE 1216	Club Sport - Pep Band
PE 1217	Club Sport - Sailing
PE 1218	Club Sport - Social Dance
PE 1219	Club Sport - Soma: Capoeira
PE 1220	Club Sport - Smas: Boffer Games

ATHLETIC PROGRAMS**THE INTERCOLLEGIATE PROGRAM**

The intercollegiate athletics program offers competition in 20 varsity sports.

WPI has excellent facilities and provides the best in protective equipment but, if an injury should occur, a team physician and full-time trainers are available, offering the latest treatment methods and facilities.

Practices are normally held daily, after 4 pm. Midweek contests involving travel are held to a minimum to avoid missing classes. Every effort is made to avoid conflicts with academic activities, and competitions are generally scheduled with schools with similar standards and objectives.

In recent years, teams and individuals have been sent to regional and national tournaments to allow them to compete at the highest possible level. All-America recognition has been attained recently in football, men's soccer, track and field, and wrestling.

THE VARSITY ATHLETICS PROGRAM (PE 2000-SERIES)

The WPI varsity athletics program is a highly involved and competitive program offered in 18 intercollegiate sports. Participants in these activities are selected by the head coach and must have prior approval to register. Practices are held daily in the evenings with contests mid-week and weekends for a period of 18/19 weeks. Every effort is made to avoid conflicts with academic activities and competitions are generally scheduled against schools with similar standards and objectives.

PE 2001	Varsity Football Team
PE 2002	Varsity Men's Soccer Team
PE 2003	Varsity Women's Soccer Team
PE 2004	Varsity Field Hockey Team
PE 2005	Varsity Women's Volleyball Team
PE 2006	Varsity Men's & Women' Cross Country Team
PE 2007	Varsity Wrestling Team
PE 2008	Varsity Men's Basketball Team
PE 2009	Varsity Women's Basketball Team
PE 2010	Varsity Men's & Women's Swim Team
PE 2011	Varsity Men's & Women's Indoor Track Team
PE 2012	Varsity Baseball Team
PE 2013	Varsity Softball Team
PE 2014	Varsity Men's & Women's Outdoor Track Team
PE 2015	Varsity Men's Crew Team
PE 2016	Varsity Women's Crew Team

PHYSICS**D. T. PETKIE, HEAD; D. L. MEDICH, ASSOCIATE HEAD**

PROFESSORS: P. K. Aravind, G. S. Iannacchione, D. T. Petkie, L. R. Ram-Mohan, A. A. Zozulya

ASSOCIATE PROFESSORS: N. A. Burnham, D. L. Medich, R. S. Quimby, E. Tüzel, Q. Wen

ASSISTANT PROFESSORS: L.V. Titora, K. Wu

ASSOCIATE TEACHING PROFESSOR: F. A. Dick

ASSISTANT TEACHING PROFESSORS: B. Currier, S. Kadam, R. Kafle, H. Kashuri, S. Rodriguez, I. Stroe

ASSISTANT RESEARCH PROFESSOR: M. B. Popovic

ASSOCIATED FACULTY: D. Lados (ME)

MISSION STATEMENT

The Physics Department provides education in physics to both undergraduate and graduate students and contributes to the growth of human knowledge through scholarly work.

PROGRAM EDUCATIONAL OBJECTIVES

The physics department educates students with a program characterized by curricular flexibility, student project work, and active involvement of students in their learning. Through a balanced, integrated curriculum stressing the widely applicable skills and knowledge of physics, we provide an education that is strong both in fundamentals and in applied knowledge, appropriate for immediate use in a variety of fields as well as graduate study and lifelong learning.

PROGRAM OUTCOMES

We expect that physics graduates:

1. Know, understand, and use a broad range of basic physical principles.
2. Have an understanding of appropriate mathematical methods, and an ability to apply them to physics.
3. Have demonstrated oral and written communications skills.
4. Can find, read, and critically evaluate selected original scientific literature.
5. Have an ability to learn independently.
6. Understand options for careers and further education, and have the necessary educational preparation to pursue those options.
7. Have acquired the broad education envisioned by the WPI Plan.
8. Are prepared for entry level careers in a variety of fields, and are aware of the technical, professional, and ethical components.
9. Are prepared for graduate study in physics and/or other fields.

The Department of Physics at WPI offers:

- i) the Bachelor of Science degree in Physics;
- ii) the Bachelor of Science degree in Applied Physics;
- iii) a Minor in Physics;
- iv) a Minor in Astrophysics

Program Distribution Requirements for the Physics Major

The normal period of residency at WPI is 16 terms. In addition to the WPI requirements applicable to all students (see page 7) of 4 units, completion of a minimum of 10 units of study is required for physics and applied physics in the areas of mathematics, physics, and related fields as follows:

PHYSICS (PH)

REQUIREMENTS	MINIMUM UNITS
1. Mathematics (Note 1).	3
2. Physics (including the MQP) (Notes 2, 3).	5
3. Other subjects to be selected from mathematics, science, engineering, computer science, and business (Note 3).	2

NOTES:

1. Mathematics must include at least 2/3 unit of mathematics at the level of MA 3000 or higher.
2. ES 3001 and CH 3510 count as physics courses.
3. Either item 2 or 3 must include at least 1/3 unit from each of the five principal areas of physics: mechanics, experimental physics, electromagnetism, quantum mechanics, and thermal/statistical physics. This core distribution requirement is satisfied by successfully completing at least one course from each of the following five areas: Mechanics (PH 2201 or 2202); Experimental Physics (PH 2651 or 2601); Electromagnetism (PH 2301 or PH 3301); Quantum Mechanics (PH 3401 or 3402); and Thermal/Statistical Physics (ES 3001, CH3510, PH 2101, or PH 3206). Other courses or ISUs may satisfy one or more of these areas but must be approved by the department Undergraduate Curriculum Committee. For substitutions, the student must submit a petition with a substitution proposal prior to the activity and the activity outcome must be approved by a physics faculty who has taught in the particular area.

PROGRAM IN APPLIED PHYSICS

The applied physics option is available to students who wish to obtain an interdisciplinary education based in physics. It is the goal of this program to either enable students to develop their own interdisciplinary course of study or to pursue current interdisciplinary areas such as: biophysics, nuclear science and engineering, medical physics, optics, engineering physics, or chemical physics.

Program Distribution Requirements for the Applied Physics Major

REQUIREMENTS	MINIMUM UNITS
Mathematics (Note 1)	3
Physics (Note 2, Note 3)	5
Applied Focus (Note 4)	2

NOTES:

1. Courses must include a course in Calculus, Differential Equations, Vector Calculus, Boundary Value Problems, and may include applied mathematical courses in physics, chemistry, biology, or computer science.
2. Students must take at least one course from each of the following physics core areas:
 - Mechanics (PH 2201, PH 2202, PH 4201, PH 511)
 - Electromagnetism (PH 2301, PH 3301, PH 533)
 - Quantum Mechanics (PH 3401, PH 3402, PH 514, PH 515)
 - Thermodynamics and Statistical Mechanics (CH 3510, PH 2101, PH 3206, PH 522)
 - Experimental Techniques or Laboratory (PH 2601, PH 2651)
3. To satisfy this requirement, a student must take and pass with a grade of C or better at least 1/3 unit from each of the core physics areas: Mechanics, Electromagnetism, Quantum Mechanics, Thermodynamics and Statistical Mechanics, and Experimental Techniques or Laboratory. An MQP (1 unit) is required. Physics 1110/1111, 1120/1121, 1130, and 1140 may be counted toward the 5 unit physics requirement. An MQP with substantial experimental activity, if approved in advance by the Physics Department Undergraduate Curriculum Committee, may substitute 1/3 units of an MQP in place of the Experimental Techniques / Laboratory course.
4. The Applied Focus requirement is satisfied by completing a minor in a department other than physics or by completing a coherent group of at least two units of courses in an applied field. The 2 unit program must be formulated prior to the student's final year of study by the student in consultation with his/her academic advisor and approved by the Physics Department Undergraduate Curriculum Committee.

GENERAL NOTE: Other courses or ISUs may satisfy one or more of these requirements upon prior approval by the Physics Undergraduate Curriculum Committee. For course substitutions, the student must submit a petition with a substitution proposal prior to the taking the course and the course instructor must provide a statement of support that the course will meet the qualifications of the substituted course.

PHYSICS AND APPLIED PHYSICS PROGRAMS ADVISING

Because the normal period of residency at WPI is 16 terms (four years), there is a potential for 16 units total while the minimum graduation requirement is 15 units. The difference is a WPI-wide 1 unit (3 courses) of free-electives. The general WPI requirements of 4-units must include the Humanities and Arts requirement (2 units), the Interactive Qualifying Project – IQP (1 unit), the Social Sciences (2/3 unit), and Physical Education (1/3 unit). For PH and PHA students a minimum of 10 units in the program is required leaving an

additional 1-unit of physics-electives. Thus, a great deal of flexibility exists to custom craft the curriculum.

For a student entering the study of physics, there is a natural progression of subjects which provide a foundation for advanced work within physics and applied physics programs. This constitutes a core sequence which embodies the following indispensable basic areas of study: classical mechanics, electromagnetism, a survey of modern physics, statistical and quantum physics, and laboratory experimental methods. Because the language of the exact sciences is mathematics, there is a parallel core sequence of mathematics courses normally taken either as preparation for or concurrently with the physics courses with which they are paired in the list presented below. In the following table \longrightarrow indicates that the mathematics course is strongly recommended; \longleftrightarrow indicates that concurrent study is acceptable.

MA 1021 Calculus I	\longleftrightarrow	PH 1110 Mechanics
MA 1022 Calculus II	\longleftrightarrow	PH 1120 Electricity and Magnetism
MA 1023 Calculus III	\longleftrightarrow	PH 1111 Mechanics
MA 1024 Calculus IV	\longleftrightarrow	PH 1121 Electricity and Magnetism
MA 1023 Calculus III	\longleftrightarrow	PH 1130 Modern Physics
MA 1024 Calculus IV	\longleftrightarrow	PH 1140 Oscillations and Waves
MA 2051 Differential Equations	\longleftrightarrow	PH 2202 Intermediate Mechanics II
MA 2071 Linear Algebra	\longrightarrow	PH 2651 Physics Laboratory
MA 2251 Vector/Tensor Calculus	\longrightarrow	PH 2301 Electromagnetic Fields I
MA 4451 Boundary Value Problems	\longleftrightarrow	PH 3301 Electromagnetic Theory
	\longrightarrow	PH 3206 Statistical Physics
		PH 3401 Quantum Mechanics I

Physics and applied physics students should also reserve part of their undergraduate experience for developing perspective in a range of other science and engineering disciplines. A few of the many possibilities are illustrated by the following examples.

- Chemistry (CH 1010, 1030); Material Science (ES 2001). Choosing appropriate materials is often crucial in the development of new experimental techniques that can further our knowledge of physical phenomena. Conversely, the studies of physicists have had profound effects on the development of new materials.
- Electronics, both analog (ECE 2201 and 3204, and digital (ECE 2022). Electronics pervades the modern laboratory. It is valuable to learn electronic principles and designs as they are applied in modern “on-line” experimental data collection and data reduction systems.
- Computer science (CS 1101 or CS 1102 and CS 2301). Physics students will need to make skillful use of computers in present and future experimental data processing, theoretical analyses, and the storing, retrieving and displaying of scientific information.
- Engineering courses related to science. Some basic knowledge in areas such as heat transfer, control systems, fluid mechanics, stress analysis and similar topics will prove to be of great benefit to the physicist called upon to apply professional knowledge to practical engineering problems.

Building on this core and topical subject coverage, physics students are in a position to turn in any number of directions within the range of physics studies, depending on individual interests and career objectives. Six illustrative examples are outlined below. In each case the outline includes a list of recommended and related courses followed by a sampling of project opportunities in the respective areas. Selection of specific courses and projects should be determined by students’ interests and the guidance of their academic advisors and the engineering-physics coordinator. For courses outside of the physics department, students are advised to discuss the prerequisites with the instructor.

1. Physics

Recommended Courses

PH 3402	Quantum Mechanics II
PH 511	Classical Mechanics
PH (ISU)	Selected Readings in Physics

Related Courses

ECE 2029	Introduction to Digital Circuit Design
ECE 2311	Continuous-Time Signal and System Analysis
ECE 2312	Discrete-Time Signal and System Analysis
ES 3011	Control Engineering I
MA 4291	Applicable Complex Variables
PH 2510	Atomic Force Microscopy
PH 3501	Relativity
PH 3502	Solid State Physics
PH 3503	Nuclear Physics
PH 3504	Optics
PH (ISU)	Modern Optics

2. Computational Physics

Recommended Courses

MA 3257	Numerical Methods for Linear and Non-Linear Systems
MA 4411	Numerical Solutions of Differential Equations
PH (ISU)	Numerical Techniques in Physics

Related Courses

ECE 2029	Introduction to Digital Circuit Design
ECE 2311	Continuous-Time Signal and System Analysis
ECE 2312	Discrete-Time Signal and System Analysis
ES 3011	Control Engineering I
CS 1101	Introduction to Program Design
CS 2011	Introduction to Computer Organization and Assembly Language
CS 2301	Systems Programming for Non-Majors
CS 4731	Computer Graphics
MA 3457/CS 4033	Numerical Methods for Calculus and Differential Equations
MA 4291	Applicable Complex Variables
PH 3402	Quantum Mechanics II
PH 3502	Solid State Physics

3. Optics

Recommended Courses

PH 2501	Photonics
PH 2502	Lasers
PH 3504	Optics

Related Courses

AR/ID 3150	Light, Vision, and Understanding
ECE 2311	Continuous-Time Signal and System Analysis
ECE 2312	Discrete-Time Signal and System Analysis
ES 3011	Control Engineering I
MA 4291	Applicable Complex Variables
PH 3402	Quantum Mechanics II
PH 3502	Solid State Physics

4. Electromagnetism**Recommended Courses**

PH (ISU)	Modern Optics
PH (ISU)	Selected Readings in Electromagnetism

Related Courses

ECE 2311	Continuous-Time Signal and System Analysis
ECE 2312	Discrete-Time Signal and System Analysis
ES 3011	Control Engineering I
MA 4291	Applicable Complex Variables
PH 3402	Quantum Mechanics II
PH 3502	Solid State Physics
PH 3503	Nuclear Physics
PH 3504	Optics
PH 514/5	(Graduate) Quantum Mechanics
PH 533	(Graduate) Electromagnetic Theory

5. Nuclear Science and Engineering**Recommended Courses**

NSE 510	Introduction to Nuclear Science and Engineering
NSE 520	Applied Nuclear Physics
PH (ISU)	Nuclear Physics Applications
PH 3503	Nuclear Physics

Related Courses

ECE 2029	Introduction to Digital Circuit Design
ECE 3801	Advanced Logic Design
ES 3011	Control Engineering I
ME 4832	Corrosion and Corrosion Control
PH 3402	Quantum Mechanics II
PH 3501	Relativity

6. Thermal Physics**Recommended Courses**

PH 2101	Principles of Thermodynamics
or ES 2001	Introduction to Thermodynamics
or CH 3510	Chemical Thermodynamics
ES 3004	Fluid Mechanics
PH 3206	Statistical Physics
PH (ISU)	Selected Readings in Thermal Physics

Related Courses

ES 3003	Heat Transfer
ES 3011	Control Engineering I
ME 3410	Compressible Flow
ME 4429	Thermodynamic Applications and Design
PH 3502	Solid State Physics
PH 3504	Optics

7. Biophysics**Recommended Courses**

ES 3001	Introduction to Thermodynamics
ME/BME 4504	Biomechanics
ME/BME 4606	Biofluids
PH 3206	Statistical Physics
PH (ISU)	Review of Biophysics

Related Courses

BB 2550	Cell Biology
BME 2210	Biomechanical Signals, Instruments, and Measurements
BME 2511	Introduction to Biomechanics and Biotransport
CH 4110	Protein Structure and Function
CH 4120	Lipids and Biomembrane Functions
CH 4160	Membrane Biophysics
ES 3004	Fluid Mechanics

MINOR IN PHYSICS

The Physics Minor offers non-Physics majors the opportunity to broaden their understanding of both the principles of physics and the application of those principles to modern day engineering problems. In these times of rapid technological change, knowledge of fundamental principles is a key to adaptability in a changing workforce.

Two units of coordinated physics activity are required for the Physics Minor, as follows (note that, in accordance with Institute policy, no more than 3/3 of these units may be double-counted toward other degree requirements):

1. Any or all of the following four introductory courses:
PH 1110 or PH 1111
PH 1120 or PH 1121
PH 1130
PH 1140
2. At least 2/3 unit of upper level physics courses (2000 level or higher), which may include ISU courses or independent studies approved by the program review committee. Examples of courses of this type which might be selected are (but are not limited to):
PH 2201 Intermediate Mechanics I
PH 2301 Electromagnetic Fields
PH 2651 Physics Laboratory
PH 3401 Quantum Mechanics I
PH 3504 Optics
PH 2501 Photonics
ISU Quantum Engineering

Students who have taken the four course introductory sequence should have an adequate physics background for these courses; see, however, the individual course descriptions for the expected mathematical background. Other physics courses may be selected for the physics minor, but the recommended background for such courses often includes one or more of the courses listed above.

3. Capstone Experience

The capstone experience for the physics minor can be satisfied either by an independent study project (ISU) arranged for this purpose, or by one of the upper level courses. IF the second option is chosen, the student must discuss this with the instructor prior to the start of the course. In either case, documentation of the capstone experience will consist of a paper, prepared in consultation with the instructor or independent study project advisor, which incorporates and ties together concepts learned in the physics courses selected.

For more information, or assistance in selecting a minor advisor or an independent study advisor, see the Head of the Physics Department in Olin Hall 119.

Majors in Physics or Applied Physics do not qualify for a Minor in Physics.

MINOR IN ASTROPHYSICS

For students of the sciences interested in the stars and seeking to acquire a minor expertise with a cosmic perspective, the Physics Department offers a Minor in Astrophysics. Candidates for the Minor complete two units of work, with one unit of Astrophysics courses, and one unit of recommended background courses consisting of: 1/3 unit of mechanics, 1/3 unit of electromagnetism and 1/3 unit of quantum mechanics.

Astrophysics Courses:

Astrophysics	PH 2520
Solar Systems	PH 2540
Space Environments	PH 2550/AE 2550

Recommended Background Courses (choose one from each category):

Mechanics	PH 1110/1111, PH 2201, PH 2202, PH 4201, or PH 511
Electromagnetism	PH 1120/1121, PH 2301, PH 3301, or PH 533
Quantum Mechanics	PH 1130, PH 3401, PH 3402, or PH 514

Candidates also complete an Astrophysics Minor Project either as part of one of the astrophysics courses or as a separate ISU. The project consists of: a) selecting an astrophysical topic of interest, b) posing a relevant question and performing in-depth analysis and investigation, and c) writing a paper, all in consultation with the instructor advising the project.

Students majoring in Physics or in Applied Physics may not do a Minor in Astrophysics.

Students complete the "Application for a Minor in Astrophysics" and present it to the Head of the Physics Department. The Application is available in the Physics Department Office. The Head of the Physics Department will be responsible for the review and approval of all requests for the Minor. WPI policy requires that no more than one unit of course work be double counted toward other degree requirements.

PRE-PROFESSIONAL PROGRAMS

FIVE-YEAR DUAL BACHELOR/M.S. IN MANAGEMENT (MSMG)

The combination of a technical undergraduate degree and a graduate degree in business has been cited by many experts as the ideal educational preparation for a career in private industry. For that reason, the Robert A. Foisie School of Business offers the opportunity for obtaining dual degrees - the Bachelor of Science (BS) and the Master of Science in Management (MSMG). Moreover, the MSMG provides a compelling pathway to the Master of Business Administration (MBA) while recognizing the value of work experience. Upon receiving your MSMG from WPI, and after a minimum of two years of work experience and within six years of completing your MSMG, you may apply to return to WPI, either full-time or part-time, to earn your MBA with just nine additional courses, including the hallmark project experience of WPI.

The dual BS/MS in Management program can potentially be completed within four years, however, the program is demanding, and curriculum planning with the student's advisor and the Foisie Business School should start by the beginning of the student's third year at WPI. Only registered WPI undergraduates may enter the dual-degree program. A separate and complete application to the MSMG program must be submitted. Students must be accepted into the MSMG program before they may register for graduate business courses. Admission to the dual BS/MSMG program is determined by the Foisie Business School.

A student in the dual BS/MSMG program continues to be registered as an undergraduate until the bachelor's degree is awarded. BS/MSMG students must satisfy all requirements for the bachelor's degree, including distribution and project requirements, as well as all MSMG requirements.

MSMG students must complete the following seven required courses:

- ACC 500 Accounting and Finance Fundamentals (1 credit) and ACC 502 Financial Intelligence and Strategic Decision Making (2 credits)
- BUS 500 Business Law, Ethics, and Social Responsibility
- FIN 503 Financial Decision Making for Value Creation
- MIS 500 Innovating with Information Systems
- MKT 500 Marketing Management
- OBC 505 Teaming and Organizing for Innovation
- OIE 501 Designing Operations for Competitive Advantage

Students then select three electives, at least one of which must be from the Business School.

A student in the dual BS/MSMG may, with prior approval, apply the equivalent of a maximum of 12 graduate credits from the same courses toward both the bachelor's and master's degrees.

Students enrolled in a BS/MS program may take the following graduate courses in lieu of the corresponding undergraduate course. However, once credit is received for the graduate course, students may not receive credit for the corresponding undergraduate course.

- MIS 584 Business Intelligence/ MIS 4084 Business Intelligence
- MIS 585 User Experience Design/MIS 4741 User Experience and Design
- MKT 561 Consumer Behavior/MKT 3650 Consumer Behavior
- OIE 501 Designing Operations for Competitive Advantage/BUS 3020 Achieving Effective Operations
- OIE 542 Risk Management and Decision Analysis/OIE 3510 Stochastic Models
- OIE 553 Global Purchasing and Logistics/OIE 4460 Global Planning and Logistics
- OIE 559 Optimization Methods Business Analysis/OIE 4420 Practical Optimization

PRE-HEALTH PROGRAMS

ADVISOR: E. JACOBY

Students at WPI who wish to pursue careers in the health professions (e.g. medicine, dentistry, veterinary medicine, etc.) should, in consultation with their academic advisors, plan their academic programs to include courses in biology, general and organic chemistry, biochemistry, and physics including laboratory experiences. Although required courses for certain majors will naturally overlap with professional school prerequisites more than others, entry into medical or other health professions schools may be accomplished through any major program of study. It is important for students to work closely with their faculty advisors as well as the pre-health advisor to formulate an academic plan of study that will include the courses required for admission to health professions schools while still allowing for completion of all degree requirements. Individual admissions requirements will vary by school and program. Students should consult admissions websites of individual health professions programs for specific information about prerequisites. Pre-med students are encouraged to consult the Medical School Admissions Requirement (MSAR) resource.

WPI's project-focused curriculum offers a tremendous advantage to pre-health students. Health professions programs value teamwork, as well as cross-cultural, research, and community service experience, all of which can be demonstrated through project work. Because students will graduate from WPI with a degree in an academic discipline, they will have other career opportunities should they decide not to pursue a career in a health profession or should they choose to work for some time after graduation before continuing on to a health professions school. Students and alumni applying to health professions schools should plan to meet with the pre-health advisor to discuss the application process and arrange a letter of recommendation from the pre-health committee (if required) to support their application. Such meetings should ideally begin during a student's first year as an undergraduate student (or as soon as a student decides to pursue this path) and continue through their time at WPI.

PRE-LAW PROGRAMS

ADVISOR: K. RISSMILLER

Law schools do not require that undergraduates complete any particular course of study. Thus, students who complete degrees in engineering and science may wish to consider careers in law. Undergraduates interested in attending law school are encouraged to choose from among the many courses offered which explore legal topics. For those with greater interest, WPI offers a Minor in Law and Technology described on page 121. Courses with substantial legal content are listed among those courses fulfilling the requirements of the minor.

Enrolling in these courses will introduce students to the fundamentals of legal process and legal analysis. Students will study statutes, regulations and case law. These courses will, therefore, offer the student valuable exposure to the kind of material commonly studied in law schools and they may help demonstrate a student's interest to law school admission committees. IQPs in Law and Technology, or other projects that involve library research and extensive writing may also be helpful.

A pre-law advising program in the Social Science Department maintains information on careers in law, law schools, and the law school admission test (LSAT), which is universally required. Students may examine this material independently or make an appointment. Students with an interest in law are also encouraged to join the Pre-Law Society. To do so, contact Professor Rissmiller.

TEACHER PREPARATION PROGRAM

ADVISOR: S. WEAVER

Licensed teachers in STEM fields are in continual high demand across the United States. By participating in and successfully completing this program, WPI students are able to obtain a degree in the major of their choice and receive a Massachusetts Initial Teaching License in middle or high school science, math, or technology/engineering often within 4 years. Teacher Prep students must complete the following requirements:

- PSY 2401 Psychology of Education
- PSY 2410 School Psychology
- ID 3100 Teaching Methods
- ID 3200 Sheltered English Immersion
- Successfully complete a teaching practicum in a local public middle or high school, often completed as an IQP
- Pass the state MTEL teaching test in (1) Communication and Literacy Skills and (2) relevant subject matter
- Participate in four senior year workshops

Specific content courses are required to meet State Subject Matter Knowledge requirements for each content area but these are generally covered by courses in the student's major. By joining this program, a student is able to pursue their content area of choice as well as make a difference in the lives of middle and high school students. Students wishing to discuss or pursue this opportunity should see Shari Weaver (STEM Education Center) and/or visit www.wpi.edu/+teach. Applications are available online and should be submitted no later than B term of sophomore year.

ROBOTICS ENGINEERING

DIRECTOR: J. XIAO

ASSOCIATE DIRECTOR: C. B. PUTNAM

PROFESSORS: G. Fischer (ME), M. A. Gennert (CS),
W. R. Michalson (ECE), J. Xiao (RBE)

ASSOCIATE PROFESSOR: C.D. Onal (ME)

ASSISTANT PROFESSORS: B. Calli (CS), L. Fichera (CS),
J. Fu (ECE), Z. Li (ME), C. Pincioli (CS), X. Zeng (ME),
H. Zhang (BME)

TEACHING PROFESSOR: K.A. Stafford (ME)

ASSISTANT RESEARCH PROFESSOR: M. B. Popovic (PH)

ASSISTANT TEACHING PROFESSORS: M. Agheli Hajjabadi (ME)
G. C. Lewin (CS)

SENIOR INSTRUCTORS: N. Bertozzi (RBE), C. B. Putnam (CS)

ADJUNCT FACULTY: R. Hammoud, M.S. Ibn Seddik,
C. Morato (RBE), J. Nafziger (RBE), W. L. Rasmussen (RBE),
K.A. Stafford (ME)

ASSOCIATED FACULTY: E. O. Agu (CS), H. K. Ault (ME),
S. Barton (HUA), T. Bergstrom (ME), C. Brown (ME),
G. R. Gaudette (BME), A. H. Hoffman (ME), X. Huang (ECE),
D. Korkin (CS), Y. Liu (ME), F. J. Looft (ECE),
P. Radhakrishnan (ME), C. L. Sidner (CS), J. Skorinko (SSPS),
E. Solovey (CS), A. Wyglinski (ECE)

RESEARCH STAFF: C. Nycz (RBE), R. Tsumura (BME), Y. Zheng (ME)
FACULTY EMERITUS: D. Cyganski (ECE), K.A. Stafford (ME)

MISSION STATEMENT

Robotics combines sensing, computation, and actuation in the real world, defined as intelligent connection from perception to action. Intelligent robotics is playing a key role in the fourth industrial revolution as it fuses technologies that connect physical, digital, biological, and social spheres. Robotics is becoming omnipresent in serving societal needs, with wide-range applications, including medicine and healthcare, transportation, manufacturing, material handling, exploration in space and deep sea, defense, domestic help, search and rescue, and emergency responses.

PROGRAM EDUCATIONAL OBJECTIVES

Graduates of the Robotics Engineering program are expected to:

1. Successfully
 - a. attain professional careers in robotics and related industries, academia, and government;
 - b. expand human knowledge through research and development; and/or
 - c. develop entrepreneurial engineering activities.
2. Engage in life-long and continuous learning, including advanced degrees.
3. Exert leadership over multi-disciplinary projects and teams.
4. Contribute as responsible professionals through community service, mentoring, instructing, and guiding their professions in ethical directions.
5. Communicate effectively to professional and business colleagues, and the public.

STUDENT OUTCOMES

1. an ability to identify, formulate, and solve complex engineering problems by applying principles of engineering, science, and mathematics
2. an ability to apply engineering design to produce solutions that meet specified needs with consideration of public health, safety, and welfare, as well as global, cultural, social, environmental, and economic factors
3. an ability to communicate effectively with a range of audiences
4. an ability to recognize ethical and professional responsibilities in engineering situations and make informed judgments, which must consider the impact of engineering solutions in global, economic, environmental, and societal contexts
5. an ability to function effectively on a team whose members together provide leadership, create a collaborative and inclusive environment, establish goals, plan tasks, and meet objectives
6. an ability to develop and conduct appropriate experimentation, analyze and interpret data, and use engineering judgment to draw conclusions
7. an ability to acquire and apply new knowledge as needed, using appropriate learning strategies
8. an ability to evaluate and integrate the mechanical, electrical, and computational components of a cyber-physical system.
9. an ability to recognize and take advantage of entrepreneurial opportunities.

Program Distribution Requirements for the Robotics Engineering Major

REQUIREMENTS	MINIMUM UNITS
1. Mathematics (Note 1)	7/3
2. Basic Science (Note 2)	4/3
3. Entrepreneurship	1/3
4. Social Implications (Note 3)	1/3
5. Engineering Science and Design, including the MQP (Notes 4–9)	6 *

NOTES:

1. Must include Differential and Integral Calculus, Differential Equations, Linear Algebra, and Probability.
2. Must include at least 2/3 units in Physics.
3. Must include at least 1/3 unit of Social Implications of Technology (CS 3043, GOV 2302, GOV/ID 2314 or RBE 3100). If GOV 2302 or GOV/ID 2314 are double-counted as meeting the Social Science Requirement and the Social Implications Requirement, then the Distribution Requirements total 10 units, otherwise the Distribution Requirements total 10 1/3 units.
4. Must include at least 5/3 units in Robotics Engineering, including RBE 2001, RBE 2002, RBE 3001, and RBE 3002, or equivalent. RBE 3100 may not be used to fulfill this requirement.
5. Must include at least 1 unit in Computer Science, including Object-Oriented Programming and Software Engineering.
6. Must include at least 2/3 units in Electrical and Computer Engineering, including Embedded Systems.
7. Must include at least 1/3 unit in Statics and 1/3 unit in Controls.
8. Must include at least 1 unit of Engineering Science and Design Electives, of which at least 2/3 unit must be at the 4000-level or higher.
9. The MQP must be a Capstone Design Experience in Robotics Engineering.

MAJOR QUALIFYING PROJECTS

Robotics Engineering MQPs are capstone design activities that span a wide range of topics from autonomous ground/air/underwater vehicles to swarm robotics to human-robot interaction, with applications in surgery, inspection, manufacturing, security, and entertainment, to name but a few. All RBE MQPs must go through the breadth of the design experience, including conceptualization, requirements, design, implementation, evaluation, and documentation. Projects also address societal issues, including professional responsibility, ethical and environmental considerations, sustainability, aesthetics, and safety. RBE MQPs may be sponsored by industry, including the Lincoln Lab and Silicon Valley project centers, develop from faculty research, or be initiated by students. Please see the Robotics Engineering website <http://robotics.wpi.edu/> for information on current projects.

ADDITIONAL ADVICE

For additional advice about course selections, including elective choices, students should consult with their academic advisor.

MINOR IN ROBOTICS ENGINEERING

The Minor in Robotics Engineering consists of 2 units of work distributed as follows:

1. 1/3 unit CS selected from CS 2102, CS 2103, CS 2223, CS 2301, CS 2303, CS 3733.
2. 1/3 unit ECE selected from ECE 2010, ECE 2019, ECE 2029, ECE 2049, ECE 2311.
3. 1/3 unit ME/ES selected from ES 2501, ES 2503, ES 3011, ME 3310.
4. 2/3 units from RBE 1001, RBE 2001, RBE 2002.
5. A 1/3 unit capstone experience through an RBE course at 3000-level or above.

No more than 1 unit of work may overlap the major.

Students considering a Robotics Engineering Minor should consult with the RBE Undergraduate Program Committee.

SOCIAL SCIENCE AND POLICY STUDIES

E. M. DOUGLAS, HEAD

FACULTY: I. Arroyo, E. M. Douglas, J. K. Doyle, L. Elgert, R. Krueger, E. Ottmar, O. Pavlov, M. J. Radzicki, K. J. Rissmiller, A. C. Rodriguez, K. Saeed, J. Skorinko, A. Smith, G. Somasse, P. Stapleton, E. Stoddard

FACULTY EMERITUS: J. O'Connor, D. Woods

ASSOCIATED FACULTY: S. Barton (HU), J. Beck (CS), N. Heffernan (CS), K. Oates (BB), D. Rosbach (CEE)

DEPARTMENT DESCRIPTION

Recognizing the increasingly important role that the social sciences play in our complex, technological world, the Department of Social Science and Policy Studies offers cutting edge educational and research programs in a variety of disciplines, including economics, environmental and sustainability studies, development studies, government/law, learning sciences, psychology, sociology, and system dynamics. Our programs, ranging from undergraduate general education in the social sciences to interdisciplinary Ph. D. degrees, are distinguished by their emphasis on behavioral science, commitment to project-based learning, and use of state of the art methods and technologies. We are committed to helping students at all levels to think critically about important societal problems and to identify effective solutions.

PROGRAMS

The SSPS Department supports general education in the social sciences through the university-wide Social Science Requirement. The Department offers B.S. degrees and minors in Economic Science, Psychological Science, Society, Technology & Policy, and System Dynamics. The Department also serves as the home for the Pre-Law program and Law & Technology Minor and is the lead department for the interdisciplinary BA and minor program in International Development, Environment, and Sustainability. Given the diversity of offerings in the department, each program has a unique set of goals and outcomes.

For additional advice about course selections, students should consult with their academic advisor. Detailed curriculum guidelines for each program as well as recommendations for completing the Social Science Requirement are available on the Social Science and Policy Studies Department Web site (www.wpi.edu/academics/ssps.html).

COURSE AREAS

The SSPS Department covers many of the traditional social science disciplines. Courses with the following prefixes are found in the Department:

DEV	Development
ECON	Economics
ENV	Environmental and Sustainability Studies
GOV	Political Science, Government, and Law
PSY	Psychology
SD	System Dynamics
SOC	Sociology
SS	General Social Science
STS	Society-Technology Studies

DOUBLE MAJOR IN SOCIAL SCIENCE AND POLICY STUDIES

Any of the major programs offered by the SSPS Department may be taken as part of a double major in which the student majors in an area of science, engineering or business as well as social science. To obtain a double major, the student must satisfy all of the degree requirements of both majors, including the MQP and Distribution requirements. However, the MQP in the social science discipline may double count as the IQP, provided that the combined project meets the goals of both. It must be interactive in nature involving an aspect of technology as well as an application of social science knowledge and analytical techniques. Thus double majors for whom one of the majors is in the social sciences requires only two projects, not three. The decision to pursue the social science double major should be made fairly early in the student's academic career, certainly early enough to ensure the selection of an appropriate IQP/MQP.

UNDERGRADUATE RESEARCH OPPORTUNITIES

SSPS faculty are actively engaged in research in a variety of applied social science areas, with particular strength in economics, environmental studies, learning sciences, psychology, social and public policy, and system dynamics.

ECONOMIC SCIENCE PROGRAM

A. Smith: Program Director

Economists study how both individuals and institutions make decisions about the utilization and distribution of resources. They also monitor economic data and analyze trends, examine the impact of economic policies and behaviors, and help formulate new policies and anticipate their effects. WPI's economic science major emphasizes the use of computational modeling and experimentation to achieve these goals.

PROGRAM OUTCOMES

In addition to fulfilling WPI's university-wide undergraduate learning outcomes, economic science majors will demonstrate:

1. Command of macro-economic and micro-economic theory.
2. Awareness of economic history and the evolution of thought in economics.
3. Skills in key economic modeling techniques, including econometrics and system dynamics.
4. Skills using data collected in a variety of ways, including surveys, experiments and through observation in the field.
5. Skill in mathematics as required to approach and solve economic problems.
6. Practical understanding of modern business disciplines including accounting and finance.
7. Knowledge of key economic institutions that make policy and influence economic practice.
8. Ability to understand current economic issues in light of economic theories.
9. Ability to approach and solve a practical problem like an economist.
10. Deep understanding of fundamental economic problems in a specific area of application.

Program Distribution Requirements for the Economic Science Major

The normal period of residency at WPI is 16 terms. In addition to the WPI requirements applicable to all students, completion of a minimum of 10 units of study is required in economics, social science, basic science, and mathematics as follows:

ECONOMIC SCIENCE REQUIREMENTS	MINIMUM UNITS
1. Economics (Note 1).	3
2. Economics and/or Business (Note 2)	2/3
3. Other Social Science	1
4. Modeling Techniques	2/3
5. Mathematics (Note 3)	2
6. Basic Science	1
7. Electives	2/3
8. MQP	1

NOTES:

1. Must include courses in both micro and macro economic theory at the intermediate level and in econometrics and international trade (available through the Consortium or independent study).
2. Must include financial accounting, BUS 2060. May include other relevant business courses as approved by the Departmental Program Review Committee.
3. Must include differential equations, integral calculus, and statistics.

CONCENTRATION AREAS AVAILABLE IN ECONOMIC SCIENCE

Economic Science majors may focus their studies by choosing a Concentration within one of the following two specific areas of Economics: Sustainable Economic Development and Computational Economics. These concentration areas reflect the growing importance of environmental issues and computational tools within the discipline of economics and are areas of strength in teaching and research in the social sciences at WPI. Concentrations within the Economics Science major comply with WPI's requirements for concentrations. Students must complete an MQP and two units of integrated study in the area of their Concentration.

Sustainable Economic Development. The term sustainable economic development means choosing policies that balance environmental preservation and economic development so as to meet the needs of the present generation without seriously compromising the needs of future generations. The sustainable development concentration examines the economic, psychological, social, political, legal, and technical issues surrounding the creation of policies aimed at establishing sustainable economic systems at the local, national, and international levels.

1. 1 unit from the following list of courses in economic development:
 - ECON 2125 Development Economics
 - ECON 2117 Environmental Economics
 - CE 3070 Urban Environmental Planning
 - CE 3074 Environmental Analysis
 - HI 3333 Topics in American Technological Development

2. 1 unit from the following list of environmental courses in other social science disciplines, humanities, and biology, or additional courses from list 1:

BB 1002	Environmental Biology
BB 4150	Environmental Change: Problems and Approaches
ENV 1100	Introduction to Environmental Studies
ENV2200	Environmental Studies in the Various Disciplines
ENV 2400	Environmental Problems and Human Behavior
GOV 2311	Legal Regulation of the Environment
GOV 2312	International Environmental Policy
PY 2717	Philosophy and the Environment

Computational Economics. Students in the computational economics concentration supplement their knowledge of traditional tools of economic analysis by studying modern computational techniques. Student projects may address problems of complex macroeconomic modeling, chaos, computational finance, design of automated Internet markets, and many more. This concentration draws on the expertise and talent of the faculty in various departments throughout the university.

1. 1 unit from the following list of courses in system dynamics:

SD 1510	Introduction to System Dynamics Modeling
SD 2530	Advanced Topics in System Dynamics Modeling
SD 3550	System Dynamics Seminar

2. 1 unit from the following list of courses offered in other departments:

CS 2022/MA2201	Discrete Mathematics
CS 4032/MA3257	Numerical Methods for Linear and Nonlinear Systems
CS 4033/MA3457	Numerical Methods for Calculus and Differential Equations
CS 4341	Introduction to Artificial Intelligence
ES 3011	Control Engineering I
OIE 3460	Simulation Modeling and Analysis
OIE 3510	Stochastic Models
MA 2210	Mathematical Methods in Decision Making
MA 2431	Mathematical Modeling with Ordinary Differential Equations
MA 3471	Advanced Ordinary Differential Equations
MA 4235	Mathematical Optimization
MA 4411	Numerical Analysis of Differential Equations

PSYCHOLOGICAL SCIENCE PROGRAM

J. Skorinko: Program Director

Psychology is the study of the entire range of human experience, thought, and behavior, from infancy until death, from the most abnormal behavior to the most mundane, from the behavior of neurons to the actions of societies and nations. Psychologists employ a wide variety of methods to understand behavior and to discover how best to improve performance, including controlled experiments on human subjects. WPI's major in psychological science emphasizes empirical research in the areas of social and cognitive psychology as well as practical applications to the classroom, the courtroom, and other settings.

PROGRAM OUTCOMES

In addition to fulfilling WPI's university-wide undergraduate learning outcomes, psychological science majors will demonstrate:

1. Familiarity with the major concepts, theoretical perspectives, empirical findings, and trends in psychology.
2. Understanding of and ability to apply basic research methods in psychology, including experimental design, data analysis, and interpretation.
3. Ability to apply psychological principles to personal, social, organizational, and societal issues, including developing insight into their own and others' behavioral and mental processes.
4. Understanding of the relationship and interactions between psychology and other social science domains.
5. Ability to understand the role of and apply knowledge of psychological phenomena in other domains, such as business, computer science, or biology.
6. Ability to recognize, understand, and respect the complexity of sociocultural and international diversity.
7. Understanding of the ethics of human subjects research and the ability to apply that understanding in designing research or practices that do not violate ethical guidelines.
8. Knowledge of basic science and how it contributes to understanding human behavior.

[Adapted from the American Psychological Association Report on Undergraduate Psychology Learning Goals and Outcomes.]

Program Distribution Requirements for the Psychological Science Major

The normal period of residency at WPI is 16 terms. In addition to the WPI requirements applicable to all students, completion of a minimum of 10 units of study is required in psychological science, social science, basic science, and mathematics as follows:

PSYCHOLOGICAL SCIENCE REQUIREMENTS	MINIMUM UNITS
1. Psychological Science (Note 1)	4
2. Psychological Science and/or Related Courses (Note 2)	4/3
3. Basic Science, Computer Science, and/or Engineering (Note 3)	5/3
4. Mathematics (Note 4)	1
5. Electives (Note 5)	1
6. MQP	1

NOTES:

1. Must include introductory psychology, social psychology, cognitive psychology, and experimental design.
2. Related courses may be additional psychology courses, other social science courses (DEV, ECON, ENV, GOV, SD, SOC, STS), ID 2050, or they may be chosen from a list of psychology-related courses from other departments listed in the undergraduate catalog section for the Psychological Science major.
3. Must include 1/3 unit of biology. Must include 1/3 unit of computer science (except CS 2022 and CS 3043).
4. Must include 2/3 units of calculus and 1/3 unit of statistics.
5. The 1 unit of electives must be approved by the Director of the Psychological Science Undergraduate Program.

List of psychology-related courses from other departments:

BB 2050	Animal Behavior
BB 2920	Genetics
BB 3080	Neurobiology
BB 3101	Human Anatomy & Physiology: Movement and Communication
BB 3102	Human Anatomy & Physiology: Transport and Maintenance
BB 3620	Developmental Biology
BME 2211	Biomedical Data Analysis
BME 3111	Physiology and Engineering
BME 3300	Biomedical Engineering Design
BUS 1010	Leadership Practice I
BUS 2080	Data Analysis for Decision Making
BUS 4030	Achieving Strategic Effectiveness
CS 3041	Human-Computer Interaction
CS 3043	Social Implications of Information Processing
CS 4341	Introduction to Artificial Intelligence
CS 4445	Data Mining and Knowledge Discovery in Databases
EN 1257	Introduction to African American Literature and Culture
EN 2225	The Literature of Sin
EN 2251	Moral Issues in the Modern Novel
HU 1412	Introduction to Asia
HU 2340	Popular Culture and Social Change in Asia
INTL 1100	Introduction to International and Global Studies
INTL 2410	Modern Africa
PY 2711	Philosophical Theories of Knowledge and Reality
PY 2716	Philosophies of Difference
PY 2718	Freedom and Existence
RE 2721	Religion and Culture
RE 2722	Modern Problems of Belief
ID 2050	Social Science Research for the IQP
IMGD 2000	Social Issues in Interactive Media and Games
MA 2612	Applied Statistics II
MA 2621	Probability for Applications or MA2631: Probability
MA 3631	Mathematical Statistics
DS 3001	Foundations of Data Science

CONCENTRATION IN PSYCHOBIOLOGY**CONCENTRATION GUIDELINES:**

1. Psychological Science Majors who are interested in the biological aspects of psychology can choose to complete a concentration in Psychobiology. To complete the concentration, students must complete 2 units of coursework from the approved list of courses related to psychobiology.
2. All students completing this concentration will need to complete an MQP that relates to psychobiology.
3. 2/3 units should come from the Psychological Science and may include (see Note 1):

PSY 1404:	Developmental Psychology
PSY 1412:	Mental Health
PSY 2408:	Health Psychology
PSY 2502:	Psychophysiology
4. 4/3 units should come from Biology & Biotechnology and may include (see Note 1):

BB 1025:	Human Biology
BB 1035:	Intro to Biotechnology
BB 2003:	Fundamentals of Microbiology
BB 2050:	Animal Behavior

BB 2550:	Cell Biology
BB 2903:	Anatomy & Physiology (1/6)
BB 2904:	Ecology, Environment, and Animal Behavior (1/6)
BB 2920:	Genetics
BB 2950:	Molecular Biology
BB 3080:	Neurobiology
BB 3101:	Human Anatomy & Physiology: Movement and Communication
BB 3102:	Human Anatomy & Physiology: Transport and Maintenance
BB 2511:	Nerve and Muscle Physiology
BB 3514:	Circulatory and Respiratory Physiology
BB 3620:	Developmental Biology

NOTES:

1. Only one course in this subset can be at the 1000-level

SOCIETY, TECHNOLOGY, AND POLICY PROGRAM

P. Stapleton: Program Director

Policy analysts apply an array of skills and techniques to evaluate the impacts of existing policies, both public and private, and to help formulate new policies to address societal needs. WPI's major in society, technology, and policy focuses on the relationships between science-technology, society, government, and business. The program allows students to develop a strong interdisciplinary background in these areas and to learn the analytical tools and methods needed to apply this knowledge to important questions in such areas as environmental policy and regulation, science-technology policy, and internet policy.

PROGRAM OUTCOMES

In addition to fulfilling WPI's university-wide undergraduate learning outcomes, society, technology, and policy majors will demonstrate:

1. Ability to conduct public policy analysis, technology assessment, or social impact analysis.
2. Understanding of and ability to apply research methods in the social sciences.
3. Ability to communicate effectively the results of a social analysis with policy implications in speech and writing.
4. Understanding of the relationships between technology, policy, and the public interest in a democratic society.
5. Ability to integrate understanding of science and technology into thinking on the social implications of science and technology.
6. Ability to understand the impacts of government regulation on the future development of a technology or industry.
7. Literacy in the technological aspects of policy issues in the student's area of concentration.
8. Ability to identify and appropriately consider ethical constraints during science and technology policy deliberations and decision-making.

Program Distribution Requirements for the Society, Technology, and Policy Major

The normal period of residency at WPI is 16 terms. In addition to the WPI requirements applicable to all students, completion of a minimum of 10 units of study is required in social science, basic science, and mathematics as follows:

SOCIETY, TECHNOLOGY AND POLICY REQUIREMENTS

	MINIMUM UNITS
1. Social Science (Notes 1, 2)	4
2. Minimum Basic Science background	2/3
3. Minimum Mathematics background (Note 3)	1
4. Technical concentration (Note 4)	5/3
5. Electives (Note 5)	5/3
6. MQP	1

NOTES:

- Students must obtain approval of their proposed program from the Departmental Program Review Committee. Course distribution will focus on a disciplinary specialty and either policy analysis or a society-technology specialization such as Social Impact Analysis or Technology Assessment.
- Relevant Humanities or Business courses approved by the Departmental Review Committee may be counted for a maximum of 2/3 of a unit in fulfilling the 4-unit requirement.
- One course in calculus-based statistics is required.
- A series of courses in one field of science, engineering, or business or a combination of courses approved by the departmental review committee which focus on issues to be developed in the MQP.
- These courses are to be approved by the Departmental Review Committee and are meant to broaden the technical concentration and tie it to social concerns.

MINOR IN LAW AND TECHNOLOGY

As science and technology evolve, there are growing needs for professionals who both understand science and technology and who work within the institutions of the American legal system. At all levels, from federal courts to state regulatory agencies and local planning commissions, policy makers decide issues in an environment of legal rules and principles. Yet to be effective, they must also understand how science and technology can aid their decisions, the methods and conclusions of scientific research, and the social impact of decisions. Without science, environmental regulators cannot decide on measures for hazardous waste disposal, public health officials cannot evaluate new drug therapies, utility regulators cannot authorize new sources of electric power, judges cannot construe the meaning of medical testimony, and attorneys cannot cross examine an expert witness in a product failure case. Decision makers, and those who attempt to influence them, find that they need to understand science and technology.

The Law and Technology Program is an interdisciplinary minor that can be used to supplement a major, introduce students in science and engineering disciplines to legal studies and prepare students to enter law school upon graduation. Students in the program begin their studies with a foundation in legal institutions and analysis and continue with advanced courses that integrate law and technology. A course in professional communication is also required.

To attain a Minor in Law and Technology, students must complete two units of study (6 courses) as follows:

- At least two of the following courses in legal fundamentals:

HI 2317	Law and Society in America, 1865-1910
GOV 1310	Law, Courts and Politics
GOV 2310	Constitutional Law: Foundations
GOV 2320	Constitutional Law: Civil Rights and Liberties
BUS 2020	The Legal Environment of Business Decisions
- At least two of the following courses which integrate law and technology:

CE 3022	Legal Aspects of Professional Practice
CE 4071	Land Use Development and Controls
CE 583	Contracts and Law for Civil Engineers
GOV 2302	Science-Technology Policy
GOV 2311	Environmental Policy and Law
GOV 2312	International Environmental Policy
GOV 2313	Intellectual Property Law
GOV/ID 2314	Cyberlaw and Policy

 Independent study or experimental courses with the approval of the program director.
 One-third unit of IQP may also be credited toward the minor with the approval of the program director.
- One of the following courses in professional communication:

WR 1010	Elements of Writing
WR 2210	Business Writing and Communication
WR 3112	Rhetorical Theory
WR 3214	Writing About Disease and Public Health

Students should review their program of study with the associated faculty and/or pre-law advisor. Students are also encouraged to seek IQP opportunities in Division 53, Law and Technology. Note: only one of the two units may be counted toward other college requirements.

For general policy on the Minor, see description on page 11.

MINORS IN SOCIAL SCIENCE

A Social Science Minor is available in any of the following disciplines:

Economics
 Sociology
 Political Science and Law
 Psychology
 System Dynamics
 Social Science

A minor in the Social Sciences consists of 2 units of academic activity satisfying the following conditions:

- Foundations
 Introductory level courses in any one or two social science disciplines taught at WPI: economics (ECON), sociology (SOC), political science (and law) (GOV), psychology (PSY), and system dynamics (SD). Introductory courses are identified by the first digit of the course number, which must be a 1. The second digit of the course number indicates the discipline (1—economics, 2—sociology, 3—political science and law, 4—psychology, and 5—system dynamics).

2. Applied Courses (At least 1 unit)

Three or more higher level courses in the same social science discipline as the foundation courses, which involve applications or extensions of the material covered in the introductory courses and list the introductory courses as recommended background. High level courses have either a 2, 3, or 4 as the first digit of the course number. The capstone experience will consist of a paper in the last applied course taken. The paper must draw upon and integrate material covered in the previous courses. An IQP may provide the capstone experience and substitute for the last applied course provided that the IQP was advised or co-advised by a member of the Social Science & Policy Studies department, and contains appropriate social science analysis.

3. If five or more of the six 1/3 units required for the minor are in a single social science discipline, the title of the minor will be "Minor" in that discipline.* Otherwise the title of the minor will be "Minor in Social Science." Examples of minor programs in economics, sociology, political science (and law), psychology, system dynamics and interdisciplinary social science are available at the SS & PS department office. The course selected for an interdisciplinary social science minor should follow an identifiable theme, such as the relationship between technology and society or social, political, economic or environmental policies.

Students taking minors in the social sciences are expected to designate a member of the SS & PS department as their SS minor advisor, who will assist them in preparing a program that meets the requirements of the minor. Students can obtain assistance at the SS & PS departmental office in designating an advisor.

Students completing any major in the Social Science and Policy Studies Department may not also complete a minor in social sciences.

* In designating sociology the minor, the course PSY 1402, Social Psychology, can be counted as one of the five courses required in Sociology. In designating the economics minor, at least 3 of the 5 required courses must be chosen from among the following four theory courses:

ECON 1110 Introductory Microeconomics;
ECON 1120 Introductory Macroeconomics;
ECON 2210 Intermediate Microeconomics; and
ECON 2120 Intermediate Macroeconomics.

COURSE DESCRIPTIONS

SECTION 3

Courses Qualifying for Engineering Distribution Areas	124
Aerospace Engineering	125
Air Force Aerospace Studies	126
Architectural Engineering	128
Basic Sciences	129
Bioinformatics and Computational Biology	129
Biology and Biotechnology	130
Biomedical Engineering	135
Business, Robert A. Foisie School of	138
Chemical Engineering	142
Chemistry and Biochemistry	144
Civil and Environmental Engineering	148
Computer Science	150
Data Science	154
Electrical and Computer Engineering	155
Engineering Science Interdisciplinary	158
Fire Protection Engineering	160
Humanities and Arts	161
Independent Study	179
Interactive Media & Game Development	179
Interdisciplinary	182
Mathematical Sciences	184
Mechanical Engineering	189
Military Science	192
Physical Education	194
Physics	195
Robotics Engineering	197
Social Science and Policy Studies	198

COURSES QUALIFYING FOR ENGINEERING DISTRIBUTION AREAS

Mathematics

All Courses designated "MA."

Advanced placement established by AP exam or through passing WPI advanced courses (see page 243) also qualify.

Basic Science

All courses designated "PH," "CH," "BB," and GE 2341.

Engineering Science/Design

The following courses may be applied to the "Engineering Science and Design" distribution requirement for each respective engineering major:

AE: All courses designated "AE"

BME: All courses designated "BME" (except BME 1001, BME 1004 and BME 3110) and CE, CHE, ECE, RBE, and ME courses at the 2000-level or above (except RBE 3100).

CE: All courses designated "CE". Also ES 2503 and ES 3004.

CHE: All courses designated "CHE." Also ES 3002, ES 3003, ES 3004, and other courses approved by the Chemical Engineering Department. See the department web site, and consult with your academic advisor for details.

ECE: All courses designated "ECE" and ES 3011 may be included in the six-unit ECE area distribution requirement.

IE: OIE courses including BUS 2080, BUS 3020, OIE 2850, OIE 3405, OIE 3410, OIE 3420, OIE 3460, OIE 3510, OIE 3600, OIE 4410, OIE 4420 and OIE 4460.

ME: All courses designated "ME".

RBE: All courses designated (except RBE 3100).

In addition, engineering majors selecting "Engineering Science/Design" courses from outside their major may choose appropriate activities from any of the following:

All courses designated ES, ECE, CHE, ME.

All OIE courses listed above (for ME majors only).

All courses designated as RBE except RBE 3100.

All courses designated as CE except CE 3022.

All courses designated as CS except CS 1101, CS 1102, and CS 3043. (Only RBE majors may select CS 1101 or CS 1102 to satisfy the Engineering Science and Design Distribution Requirement.)

(Electrical and Computer Engineering majors are restricted to these courses at the 2000-level or higher.)

All ABET engineering programs require six units of Engineering Science and Design.

All graduate-level courses may be counted in the appropriate categories.

COURSE DESCRIPTIONS

COURSE CATEGORIES

for purposes of planning programs of study, courses at WPI are divided into three categories.

Category I (Cat. I)

These courses cover core material of interest to large numbers of students. Category I courses are offered at least once a year.

Category II (Cat. II)

Category II courses are offered at least every other year

Category III (Cat. III)

Category III courses are offered at the discretion of the department/program.

BACKGROUND

Recommended

The course will build on material in the recommended course. Instructors can assume that the student is knowledgeable of the material from the recommended course or from other experiences.

Suggested

The material from this course would be helpful to the student, but it is not assumed background.

WRITING-INTENSIVE (WI) COURSE SECTIONS

Some sections of WPI courses may be labeled as "WI" in the course schedules. These sections will:

- Assign writing to teach course content and disciplinary forms of communication and reasoning;
- Provide explicit instruction in and feedback on students' written work; and
- Specify and require standards for ethical writing practices.

CATALOG AND SCHEDULE

The catalog and course schedule can be found online at <https://www.wpi.edu/academics/calendar-catalogs> and www.wpi.edu/+schedules.

COURSE NUMBERING

Each course at WPI is designated by a prefix identifying the subject area followed by a four digit number. The first digit is coded as follows:

- 1 — Courses for which first-year students will receive priority in registration. Upper class students may register on a space-available basis.
- 2 — Basic level courses.
- 3 — Advanced level undergraduate courses for which no graduate credit is given. (This restriction may be waived at the discretion of the degree department.)
- 4 — Advanced level undergraduate courses for which graduate credit may also be given.
- 5 — Graduate courses.

The last three digits may be used by the departments to indicate subject areas. Many graduate courses are also available to undergraduates.

COURSE CREDIT

Unless otherwise indicated, WPI courses usually carry credit of 1/3 unit. This level of activity suggests at least 15-17 hours of work per week, including work outside the classroom, as well as scheduled class and laboratory time. The usual workload per term is 1 unit.

AEROSPACE ENGINEERING

AE/PH 2550. ATMOSPHERIC AND SPACE ENVIRONMENTS.

Cat. I

This course introduces the ambient atmospheric and space environments encountered by aerospace vehicles. Topics include: the sun and solar activity; the solar wind; planetary magnetospheres; planetary atmospheres; radiation environments; galactic cosmic rays; meteoroids; and space debris.

Recommended background: mechanics (PH 1110/1111 or equivalent), electromagnetism (PH 1120/1121 or equivalent), and ordinary differential equations (MA 2051 or equivalent).

AE 2712. INTRODUCTION TO AEROSPACE STRUCTURES.

Cat. I

This course provides a concise overview of statics and then focuses on basic stress analysis applied to simple aerospace structures. Topics in stress analysis include: concepts of stress and strain; basic constitutive relations; one-dimensional response to axial loading; thermal stresses; statically determinate and indeterminate problems; shear forces, bending moments, bending stresses and deflections in beams with symmetric cross sections; two-dimensional stress transformation and Mohr's circle; and an introduction to energy methods in structural analysis.

Recommended background: differential, integral, multivariable calculus (MA 1021, MA 1022, MA 1024 or equivalent), mechanics (PH 1110, PH 1111, or equivalent).

AE 2713. ASTRONAUTICS.

Cat. I

An introductory course that covers the fundamentals of space flight. Topics studied include: two-body orbital dynamics, classification of orbits, and time of flight analysis; geocentric orbits and impulsive maneuvers: orbit shaping, escape trajectories, Hohmann and non-Hohmann transfers; orbital elements in 3D; interplanetary Hohmann and generalized transfers, intercepts, flybys.

Recommended background: multivariable calculus (MA 1024 or equivalent), differential equations (MA 2051 or equivalent), dynamics (ES 2503, PH 2201 or equivalent).

AE 3410. COMPRESSIBLE FLUID DYNAMICS.

Cat. I

In this course, students are introduced to various compressibility phenomena such as compression (shock) and expansion waves. Conservation laws and thermodynamic principles are applied to the description of flows in which compressibility effects are significant. One-dimensional models are applied to analysis of flow in variable area ducts, normal and oblique shock waves, expansion waves, and flows with friction and heat addition. Numerous applications from engineering are investigated including supersonic inlets, rocket nozzles, supersonic wind tunnels, gas delivery systems, and afterburning jet engines.

Recommended background: thermodynamics (ES 3001, CH 3510 or equivalent), incompressible fluid dynamics (AE 3602 or equivalent).

AE 3602. INCOMPRESSIBLE FLUIDS.

Cat. I

This course covers the fundamentals of inviscid and viscous incompressible fluid dynamics. Topics presented will be considered from the following: fluid kinematics and deformation; integral conservation laws of mass, momentum and energy for finite systems and control volumes; differential conservation laws of mass, momentum and energy; the Navier-Stokes equations; the streamfunction and the velocity potential. Applications will be considered from the following topics: hydrostatics; incompressible, inviscid, irrotational (potential) flows; incompressible boundary layer flows; viscous incompressible steady internal and external flows; and dimensional analysis.

Recommended background: differential equations (MA2051 or equivalent), dynamics (ES 2503, PH 2101 or equivalent), thermodynamics (ES 3001, PH 2101, CH 3510 or equivalent).

AE 3711. AERODYNAMICS.

Cat. I

This course introduces students to the aerodynamics of airfoils, wings, and aircraft in the subsonic and supersonic regimes. Topics covered include: prediction of aerodynamic forces (lift, drag) and moments, dynamic similarity, experimental techniques in aerodynamics, Kutta-Joukowski theorem, circulation, thin airfoil theory, panel methods, finite wing theory, subsonic

compressible flow over airfoils, linearized supersonic flow, and viscous flow over airfoils.

Recommended background: incompressible and compressible fluid dynamics (AE 3602, AE 3410 or equivalent).

AE 3712. AEROSPACE STRUCTURES.

Cat. I

This course focuses on intermediate-level topics in stress analysis relevant to aerospace structures. Topics include: buckling under centric and eccentric loadings with and without lateral loads applied; torsion of solid circular and noncircular cross sections; torsion of thin-walled multi-celled members; flexural shear flow in and shear center of thin walled multi-celled members; bending stresses in beams with unsymmetric cross sections; stresses under combined loadings; and three-dimensional states of stress. The laboratory component of this course provides testing and measurement experience related to buckling of columns under a variety of loadings and support conditions; and to the determination of the shear center and bending response of beams with unsymmetric cross sections.

Recommended background: differential equations (MA 2051 or equivalent), introductory aerospace structures (AE 2712 or equivalent).

AE 3713. INTRODUCTION TO AEROSPACE CONTROL SYSTEMS.

Cat. I

This course introduces feedback control systems analysis and design for applications to aircraft and spacecraft. Topics include: linear dynamical systems modeling of aircraft and spacecraft motion, including linearization; identification and transient response analysis of typical modes of motion; time- and frequency domain analysis; Bode plots; criteria for stability; design of stability augmentation and, attitude and orbital control systems using linear state feedback or PID control; numerical simulation of controlled and uncontrolled aircraft and spacecraft motion.

Recommended background: ordinary differential equations (MA 2051 or equivalent), introductory dynamics (ES 2503, PH 2201 or equivalent), and linear algebra (MA 2071 or equivalent).

Students may not receive credit for both AE/ME 3703 and AE 3713.

AE 4711. FUNDAMENTALS OF AIR-BREATHING PROPULSION.

Cat. I

This course introduces the principles of operation of air-breathing engines, including gas-turbines (turbojets, turbofans, and turboprops), ramjets, and scramjets. Topics covered include: engine thrust and efficiency analysis; working principles and performance analysis of diffusers, compressors, combustors, and nozzles; parametric cycle analysis; effect of irreversibilities on performance. The topics covered are also relevant to the operation of gas-turbines used for power generation.

Recommended background: thermodynamics (ES 3001, CH 3510, PH 2101 or equivalent), compressible fluid dynamics (AE 3410 or equivalent).

Students may not receive credit for both AE 4710 and AE 4711.

AE 4712. STRUCTURAL DYNAMICS.

Cat. I

This course introduces the analysis of vibrations of flexible bodies encountered as elements of aircraft and space structures. Topics include: modeling of aerospace structures with lumped parameters using Newton's Law and Lagrange's equations, free- and forced- vibration response of single degree of freedom systems and multi-degree of freedom systems, design of simplified vibration absorption systems, dynamic testing, modal analysis for determining structural response of lumped and continuous systems.

Recommended background: dynamics (ES 2503, PH 2201, PH2202 or equivalent), control (AE 3713 or equivalent), aerospace structures (AE 3712 or equivalent).

AE 4713. SPACECRAFT DYNAMICS AND CONTROL.

Cat. I

The course covers broad topics in spacecraft attitude dynamics, stability and control. The course includes a review of particle and two-body dynamics and introduction to rigid body dynamics. Orbital and attitude maneuvers are presented. Attitude control devices and momentum exchange techniques such as spinners, dual spinners, gravity gradient, and geomagnetic torques are presented. Attitude sensors/actuators are presented and the attitude control problem is introduced. Open-loop stability analysis for a variety of equilibrium conditions is discussed. Control using momentum exchange and mass expulsion (thrusters) devices is discussed. The analyses and designs will be implemented using scientific computing software such as MATLAB®.

Recommended background: astronautics (AE 2713 or equivalent), dynamics (ES 2503, PH 2201 or equivalent), control (AE 3713 or equivalent).

AE 4717. FUNDAMENTALS OF COMPOSITE MATERIALS.*Cat. I*

This course provides an overview of the processing techniques and mechanical behavior of composite materials relevant to aerospace applications. Topics in this course may include: classification of composites; elasticity of composite materials; the effect of reinforcements on strength and toughness; bonding mechanisms of interfaces in composite; fabrication methods for polymer-matrix composite materials; viscoelasticity and creep of composites; advanced composites materials (bio-composites, nano-composites).

Recommended background: introductory material science (ES 2001), and introductory stress analysis (AE 2712 or equivalent).

AE 4719. ROCKET PROPULSION.*Cat. I*

This course provides a study of rocket propulsion systems for launch vehicles and spacecraft. Dynamics, performance, and optimization of rocket-propelled vehicles are presented. Performance and component analysis of chemical propulsion systems are covered including flight dynamics, vehicle staging, nozzle design, and thermochemistry of bipropellant and monopropellant thrusters. Different classes of electric thrusters are introduced along with the concept of optimal specific impulse.

Recommended background: compressible fluid dynamics (AE 3410 or equivalent), thermodynamics (ES 3001, PH 2101, CH 3510 or equivalent).

AE 4723. AIRCRAFT DYNAMICS AND CONTROL.*Cat. I*

This course covers models of fixed-wing aircraft dynamics, and the design of aircraft control systems. Topics include: aircraft performance, longitudinal and lateral flight dynamics, simulation methodologies, natural modes of motion, static and dynamic stability, and aircraft control systems (such as autopilot design, flight path control, and automatic landing).

Recommended background: controls (AE 3713 or equivalent), attitude and position kinematics (AE 4733 or equivalent).

AE 4733. GUIDANCE, NAVIGATION AND COMMUNICATION.*Cat. I*

This course covers methods and current enabling technologies in the analysis, synthesis, and practice of aerospace guidance, navigation, and communications systems. Topics covered include: attitude- and position kinematics, inertial navigation systems, global satellite navigation systems, communication architectures for satellite navigation, tropospheric and ionospheric effects on radio-wave propagation, least squares estimation, the Kalman filter, and pursuit guidance.

Recommended background: linear algebra (MA 2071 or equivalent), dynamics (ES 2503, PH 2201 or equivalent), and controls (AE 3713 or equivalent).

AE 4770. AIRCRAFT DESIGN.*Cat. I*

This course introduces students to design of aircraft systems. Students complete a conceptual design of an aircraft in a term-long project. Students are exposed to the aircraft design process, and must establish design specifications, develop and analyze alternative designs, and optimize their designs to meet mission requirements. Students work together in teams to apply material learned in the areas of aerodynamics, structures and materials, propulsion, stability and control, and flight mechanics and maneuvers to the preliminary design of an aircraft. The project requirements are selected to reflect real-life aircraft mission requirements, and teams are required to design systems which incorporate appropriate engineering standards and multiple realistic constraints. The teams present their design in a final report and oral presentation.

Recommended background: aerodynamics (AE 3711 or equivalent), aerospace structures (AE 3712 or equivalent), air breathing propulsion (AE 4711 or equivalent), aircraft dynamics and control (AE 4723 or equivalent).

AE 4771. SPACECRAFT AND MISSION DESIGN.*Cat. I*

This course introduces students to design of spacecraft and missions. Students are introduced to the process of designing a spacecraft and major subsystems to meet a specific set of objectives or needs. In addition, students will learn about different spacecraft subsystems and what factors drive their design. Particular emphasis is given to propulsion, power, attitude control, structural, and thermal control subsystems. Students work together in teams to apply material learned in

the areas of orbital mechanics, attitude determination and control, space structures, and propulsion to the preliminary design of a spacecraft and mission. The project requirements are selected to reflect real-life missions, and teams are required to design systems which incorporate appropriate engineering standards and multiple realistic constraints. The teams present their design in a final report and oral presentation.

Recommended background: astronautics (AE 2713 or equivalent), rocket propulsion (AE 4719 or equivalent), spacecraft dynamics and control (AE 4713 or equivalent).

AIR FORCE AEROSPACE STUDIES

AS 1001. THE FOUNDATIONS OF THE UNITED STATES AIR FORCE I.*Cat. I (1/9 unit)*

The AS 1000 sequence of courses are designed to introduce students to the United States Air Force and Air Force Reserve Officer Training Corps. Featured topics include mission and organization of the Air Force, officership and professionalism, Air Force officer opportunities, military customs and courtesies, and an introduction to communication skills.

The first course focuses on the foundation of officership and customs and courtesies.

The course includes one hour of class work and two hours of mandatory leadership laboratory per week. The AS 1001 Leadership Laboratory includes a study of Air Force customs and courtesies, drill and ceremonies, and military commands.

AS 1002. THE FOUNDATIONS OF THE UNITED STATES AIR FORCE II.*Cat. I (1/9 unit)*

The AS 1000 sequence of courses are designed to introduce students to the United States Air Force and Air Force Reserve Officer Training Corps.

A continuation of AS 1001, the second course in this series emphasizes those communication skills needed in today's Air Force. It describes the communication systems as well as discusses common barriers and enhancements to effective communications. The course includes numerous speaking and written exercises using current Air Force topics.

The course includes one hour of class work and two hours of mandatory leadership laboratory per week. The AS 1002 Leadership Laboratory includes a study of Air Force customs and courtesies, drill and ceremonies, and military commands.

AS 1003. THE FOUNDATIONS OF THE UNITED STATES AIR FORCE III.*Cat. I (1/9 unit)*

The AS 1000 sequence of courses are designed to introduce students to the United States Air Force and Air Force Reserve Officer Training Corps.

A continuation of AS 1002, the course outlines the origin of the Air Force and the organizational structure of the Air Force with a focus on the missions of select military organizations. The basic history of the United States military is studied in order to appreciate how military history impacts the Air Force today. Written and oral communication skills are practiced.

The course includes one hour of class work and two hours of mandatory leadership laboratory per week. The AS 1003 Leadership Laboratory includes a study of Air Force customs and courtesies, drill and ceremonies, and military commands.

AS 1004. THE FOUNDATIONS OF THE UNITED STATES AIR FORCE IV.*Cat. I (1/9 unit)*

The AS 1000 sequence of courses are designed to introduce students to the United States Air Force and Air Force Reserve Officer Training Corps.

The final course in the AS 1000 sequence, it introduces students to the Air Force installation and her sister services. Written and oral communication skills are practiced.

The course includes one hour of class work and two hours of mandatory leadership laboratory per week. The AS 1004 Leadership Laboratory includes a study of Air Force customs and courtesies, drill and ceremonies, and military commands.

AS 2001. THE EVOLUTION OF USAF AIR AND SPACE POWER I.*Cat. I (1/9 unit)*

The AS 2000 sequence of courses are designed to examine general aspects of air and space power through a historical perspective. Utilizing this perspective, the course covers a time period from the first balloons and dirigibles to the space-age global positioning systems of the Persian Gulf War. Historical examples are provided to extrapolate the development of Air Force capabilities (competencies), and missions (functions) to demonstrate the evolution of what has become today's USAF air and space power. As a whole, the AS 2000 sequence of courses provides the student with a knowledge level understanding for the general element and employment of air and space power.

The first course covers the factors leading to the early development of air power through the use of air power during World War II. The development of oral and written communication skills is continued from the AS 1000 classes.

The course includes one hour of class work and two hours of mandatory leadership laboratory per week. The AS 2001 Leadership Laboratory continues a study of Air Force customs and courtesies, drill and ceremonies, military commands, and preparation for Field Training.

AS 2002. THE EVOLUTION OF USAF AIR AND SPACE POWER II.*Cat. I (1/9 unit)*

The AS 2000 sequence of courses are designed to examine general aspects of air and space power through a historical perspective. The second course in the series continues with the development of air power from World War II through the development of the Intercontinental Ballistic Missile.

The course includes one hour of class work and two hours of mandatory leadership laboratory per week. The AS 2002 Leadership Laboratory continues a study of Air Force customs and courtesies, drill and ceremonies, military commands, and preparation for field training.

AS 2003. THE EVOLUTION OF USAF AIR AND SPACE POWER III.*Cat. I (1/9 unit)*

The AS 2000 sequence of courses are designed to examine general aspects of air and space power through a historical perspective. The third course in the series begins with a study of air power in the Vietnam war through the Gulf war. Oral and written communications skills will be practiced.

The course includes one hour of class work and two hours of mandatory leadership laboratory per week. The AS 2003 Leadership Laboratory continues a study of Air Force customs and courtesies, drill and ceremonies, military commands, and preparation for field training.

AS 2004. THE EVOLUTION OF USAF AIR AND SPACE POWER IV.*Cat. I (1/9 unit)*

The AS 2000 sequence of courses are designed to examine general aspects of air and space power through a historical perspective. The course examines several fundamental truths associated with war in the third dimension: e.g. Principles of War and Tenets of Air and Space Power. As a whole, this course provides the students with a knowledge level understanding for the general element and employment of air and space power from an institutional, doctrinal and historical perspective. In addition, the students will continue to discuss the importance of the Air Force Core Values with the use of operational examples and historical Air Force leaders and will continue to develop their communication skills. The final course in the series explores the future of the Air Force through 2025.

The course includes one hour of class work and two hours of mandatory leadership laboratory per week. The AS 2004 Leadership Laboratory continues a study of Air Force customs and courtesies, drill and ceremonies, military commands, and preparation for field training.

AS 3001. AIR FORCE LEADERSHIP STUDIES I.*Cat. I (1/6 unit)*

The AS 3000 sequence of courses is a study of leadership, management fundamentals, professional knowledge, Air Force personnel and evaluation systems, leadership ethics, and communication skills required of an Air Force junior officer. Throughout the courses, case studies are used to examine Air Force leadership and management situations as a means of demonstrating and exercising practical application of concepts being studied.

The first course explores different styles of leadership, followership, and management functions.

The course includes three hours of class work and three hours of mandatory leadership laboratory per week. The AS 3001 Leadership Laboratory complements the classroom work by providing advanced leadership experiences in officer-type activities and giving students the opportunity to apply leadership and management principles.

AS 3002. AIR FORCE LEADERSHIP STUDIES II.*Cat. I (1/6 unit)*

The AS 3000 sequence of courses is a study of leadership, management fundamentals, professional knowledge, Air Force personnel and evaluation systems, leadership ethics, and communication skills required of an Air Force junior officer. The second course studies various aspects of leadership, conflict management, counseling, and supervision.

The course includes three hours of class work and three hours of mandatory leadership laboratory per week. The AS 3002 Leadership Laboratory complements the classroom work by providing advanced leadership experiences in officer-type activities and giving students the opportunity to apply leadership and management principles.

AS 3003. AIR FORCE LEADERSHIP STUDIES III.*Cat. I (1/6 unit)*

The AS 3000 sequence of courses is a study of leadership, management fundamentals, professional knowledge, Air Force personnel and evaluation systems, leadership ethics, and communication skills required of an Air Force junior officer. The third course emphasizes teambuilding, process improvement, and military ethics.

The course includes three hours of class work and three hours of mandatory leadership laboratory per week. The AS 3003 Leadership Laboratory complements the classroom work by providing advanced leadership experiences in officer-type activities and giving students the opportunity to apply leadership and management principles.

AS 3004. AIR FORCE LEADERSHIP STUDIES IV.*Cat. I (1/6 unit)*

The AS 3000 sequence of courses is a study of leadership, management fundamentals, professional knowledge, Air Force personnel and evaluation systems, leadership ethics, and communication skills required of an Air Force junior officer. The final course explores officer professional development, and personnel and evaluation systems including practical exercises.

The course includes three hours of class work and three hours of mandatory leadership laboratory per week. The AS 3004 Leadership Laboratory complements the classroom work by providing advanced leadership experiences in officer-type activities and giving students the opportunity to apply leadership and management principles.

AS 4101. NATIONAL SECURITY AFFAIRS I.*Cat. I (1/6 unit)*

The AS 4000 sequence of courses examines the national security process, regional studies, advanced leadership ethics, and Air Force doctrine. Special topics of interest focus on the military as a profession, officership, military justice, civilian control of the military, preparation for active duty and current issues affecting military professionalism. Throughout the AS 4000 sequence of courses, briefing and writing exercises will be accomplished with emphasis on refining communication skills.

The first course examines in depth the national security process, principles of war and the Air Force major commands.

The course includes three hours of class work and three hours of mandatory leadership laboratory each week. The AS 4101 Leadership Laboratory complements the classroom work by providing advanced leadership experiences in officer-like activities and giving the students the opportunity to apply leadership and management principles.

AS 4102. NATIONAL SECURITY AFFAIRS II.*Cat. I (1/6 unit)*

The AS 4000 sequence of courses examines the national security process, regional studies, advanced leadership ethics, and Air Force doctrine. The second course provides a detailed examination of Air Force doctrine including a study of the joint doctrine and the roles of the other military services.

The course includes three hours of class work and three hours of mandatory leadership laboratory each week. The AS 4102 Leadership Laboratory complements the classroom work by providing advanced leadership experiences in officer-like activities and giving the students the opportunity to apply leadership and management principles.

AS 4103. NATIONAL SECURITY AFFAIRS III.*Cat. I (1/6 unit)*

The AS 4000 sequence of courses examines the national security process, regional studies, advanced leadership ethics, and Air Force doctrine. The third course provides an extensive study of alliances and regional security issues, including international peacekeeping and terrorism. Continued attention is given to developing the research and communications skills necessary to be successful as junior officers.

The course includes three hours of class work and three hours of mandatory leadership laboratory each week. The AS 4103 Leadership Laboratory complements the classroom work by providing advanced leadership experiences in officer-like activities and giving the students the opportunity to apply leadership and management principles.

AS 4104. PREPARATION FOR ACTIVE DUTY.*Cat. I (1/6 unit)*

The AS 4000 sequence of courses examines the national security process, regional studies, advanced leadership ethics, and Air Force doctrine. The final course in the series examines officership, the military justice system, social responsibilities, current issues affecting the military profession, and various factors that will facilitate a smooth transition from civilian to military life.

The course includes three hours of class work and three hours of mandatory leadership laboratory each week. The AS 4104 Leadership Laboratory complements the classroom work by providing advanced leadership experiences in officer-like activities and giving the students the opportunity to apply leadership and management principles.

ARCHITECTURAL ENGINEERING

AREN 2002. ARCHITECTURAL DESIGN I.*(Cat. I)*

This course offers an introduction to the architectural design process by exploring the relations between materials, structures, spaces, and architectural composition. Studio: The studio design component explores the syntax of architecture, siting, context, and human scale. Students will engage these topics through architectural design studies for a project of limited scope and programmatic complexity. Hand drawing and sketching, modeling and visualization software, orthographic drawings, and physical models are used to explore, develop, and communicate architectural design concepts. Lectures / lab: The lecture/lab component of the course focuses on two-dimensional drawing techniques (including hand drawings and sketching), drawing conventions, and architectural representation techniques. Students are introduced to the fundamental uses of modeling software in engineering and architectural design practice. Advanced topics may include three dimensional modeling rendering, animation, and parametric design.

This course uses studio, lecture, and lab based teaching methods

Recommended background: None

AREN 2004. ARCHITECTURAL DESIGN II – LIGHT AND LIGHTING SYSTEMS.*Cat. I*

This course aims to develop an understanding of the role of light and lighting in the perception of architecture and human well-being. Studio: The studio component of the course will explore the interactions between light, materials, spaces, and people. Students will engage these topics through architectural design studies for a project with well-specified lighting and architectural needs. Modeling, visualization and simulation software, orthographic drawings, and physical models are used to explore and analyze architectural design concepts. Lectures: The lecture components of the course focuses on the design of illumination systems in buildings. A general introduction to the visual environment is provided, including subjective and objective scales of measurement, visual perception, photometry, brightness, luminance, illumination, natural and artificial lighting. Other topics include photometric units, light sources, daylight luminaries, lighting quality, light loss factors, average luminance calculations (lumen method), point-by-point calculations, performance impacts, and ethics. Field measurements and computer simulations are used to explore some major aspects of architectural illumination systems. Design problems are solved by considering economic evaluation, energy saving criteria and applicable standards and building codes. Students will be introduced to the use of computer tools for the design, analysis, and visualization of natural and artificial lighting in buildings.

This course uses studio and lecture based teaching methods

Recommended background: Introductory architectural design (AREN 2002 or equivalent).

Students may not receive credit for both AREN 2004 and AREN 3005

AREN 2023. INTRODUCTION TO ARCHITECTURAL ENGINEERING SYSTEMS.*Cat. I*

The objective of this course is to introduce the functional parts and systems that make up a building as well as their interactions in delivering required sustainable performance. It encompasses foundations, structures, building enclosures, heating and air conditioning, electrical, plumbing and fire safety systems as well as concepts of building performance and aspects of pertinent building codes and standards. This course, in addition, incorporates basic principles of building science and green construction.

AREN 2025. BUILDING ELECTRICAL SYSTEMS.*Cat. I*

The principles of electrical system design in buildings are introduced in this course. Starting with an overview of electrical fundamentals and related laws, it covers circuit design, power distribution and service equipment, communication systems and special electrical systems that meet the requirements of the national electric code as well as building occupants. Other topics include single-phase and three-phase circuits, electrical and lighting loads, panel-board design, switching, system sizing, grounding, fault calculations, and over-current protection. The design criteria and calculation procedures for developing simple layouts of building electrical systems are illustrated. Work includes study of applicable NFPA 70 (NEC) and related building codes.

Recommended background: electricity and magnetism (PH 1120/1121 or equivalent)

AREN 3002. ARCHITECTURAL DESIGN III.*Cat. I*

This course aims to further a student's knowledge of the architectural design process through study of ideas, principles and methods of design and construction. Studio: Architectural concepts are developed with the completion of a project of expanded scope and complexity. The course emphasizes the development of form, space, spatial relationships, materials, context, program, and architectural presentation techniques. Hand drawing and sketching, modeling and visualization software, orthographic drawings, detail drawings, and physical models are used to explore, develop, and communicate architectural design concepts. Lectures: The lecture/lab component of the course focuses on three-dimensional modeling and architectural representation techniques. Students are introduced to advanced modeling software in engineering and architectural design practice. Topics include three dimensional modeling, rendering, animation, and parametric design.

This course uses studio, lecture, and lab based teaching methods

Recommended background: Intermediate architectural design (AREN 2002 and AREN 2004 or equivalent)

AREN 3003. PRINCIPLES OF HVAC DESIGN FOR BUILDINGS.*Cat. I*

The course introduces principles and applications of mechanical systems that are required for environmental comfort, health, and safety of building occupants with a focus on energy efficiency and conservation. Topics include psychometrics, thermal comfort, building heating and cooling loads, fluid flow basics, HVAC components and systems, building envelop heat transfer, and energy requirements. In the course, students develop the ability to design and conduct computational modelling experiments and to analyze and interpret output data for selection between system alternatives in order to optimize energy use.

Recommended background: Thermodynamics.

Some sections of this course may be offered as Writing Intensive (WI)

AREN 3006. ADVANCED HVAC SYSTEM DESIGN.*Cat. I*

Analysis of heating and cooling load requirements, considering building construction type, geometry, infiltration, occupancy effects, and daily load variations. Heating design addresses water heating systems, electrical heating, central heating, heating of low and high-rise buildings, selection of heaters, boilers, pumps, piping design. Cooling design addresses refrigerants, refrigeration cycle, evaporator, compressor, condenser, thermostatic expansion valves, refrigeration system control equipment, motor and motor control equipment, refrigeration accessories, calculation of refrigeration piping and absorption systems. Computer applications for heating and cooling load analysis will be introduced to develop energy saving solutions. Analytical techniques and building codes are discussed through case studies and design projects.

Recommended background: AREN 3003, ES 3004.

AREN 3020. ARCHITECTURAL DESIGN IV – BUILDING ENERGY SIMULATION.*Cat. I*

This course aims to develop an understanding of sustainability in architecture and introduces the fundamentals and applications of energy simulation tools. Studio: The studio component of the course will explore the relationships between people, buildings, and the environment. Students will explore the impact of building site and context, orientation, building massing and envelop configuration, occupancy and other factors. Students will engage these topics through architectural design studies and simulations for a project of increased scope and programmatic complexity. Modeling and visualization software, simulation tools, orthographic drawings, and physical models are used to explore and develop architectural design concepts. Lectures: The lecture components of the course focuses on the principles of building energy simulation, with a focus on the practical applications of building energy simulation tools to building design. Topics being covered include various model input parameters such as building geometry, orientation, climate, comfort, zoning, material properties, operation schedules, and HVAC systems. Building energy simulation software is illustrated and applied to the analysis of case studies and/or design projects. Simulation output results are critically analyzed and compared to the results obtained from other building energy calculation methods.

This course uses studio and lecture based teaching methods

Recommended background: Building Physics and HVAC system design (AREN 3024 and AREN 3003) and Architectural Design (AREN 2002, AREN 2004, and AREN 3002 or equivalent).

Students may not receive credit for both AREN 3020 and AREN 3025

AREN 3022. ARCHITECTURAL DESIGN V – BUILDING ENVELOPE DESIGN.*Cat. I*

This course aims to develop an understanding of the architectural design development process with special focus on the design and detailing of building envelopes. Studio: Through an iterative process, students will advance the architectural and technical development of an architectural project of increased complexity. Modeling and simulation software, orthographic drawings, detail drawings, and physical models are used to advance the development of architectural design concepts. Lectures: The lecture component of the course covers the basic principles of building envelope design, focusing primarily on functional performance requirements and practical constructability aspects. Various building envelope systems are reviewed, including façade and roofing systems made of masonry, stone, concrete, timber, glass, and various metals. More elaborate building envelope strategies will also be reviewed; such as double skin facades and passive solar design approaches. Students will be introduced to computer tools and other methods for the analysis of heat and moisture transfer within building envelopes and components thereof.

This course uses studio and lecture based teaching methods

Recommended background: Building Physics and HVAC system design (AREN 3024 and AREN 3003) and Architectural Design (AREN 2002, AREN 2004, and AREN 3002 or equivalent).

Students may not receive credit for both AREN 3022 and AREN 3026

AREN 3024. BUILDING PHYSICS.*Cat. I*

The course introduces the principles of building physics, as they are applied to various building design situations and performance requirements. Covered topics include heat transfer, moisture control, condensation, cold bridging, external and internal gains, and air flows, as they pertain to building envelopes (external walls, windows and doors, and roofs) and the requirements of environmental comfort of space occupants. Design exercises take into account pertinent building and energy codes as well as comfort standards. The course gives students the tools to integrate engineering science fundamentals and physics principles in developing building design solutions. Thermal measurements in building components are performed.

Recommended background: thermodynamics and heat transfer (ES 3001, ES 3003 or equivalent).

BASIC SCIENCES**GEOSCIENCES (GE)****GE 2341. GEOLOGY.***Cat. I*

Students of this course will examine the fundamental principles of physical geology including the materials, structures, and surface features of the earth and the processes which produced them. Emphasis will be placed on the interrelationship of people and environment and applications to various fields of technology. The course includes field trips and a significant laboratory component.

BIOINFORMATICS AND COMPUTATIONAL BIOLOGY**BCB/BB 1003. EXPLORING BIOINFORMATICS AND COMPUTATIONAL BIOLOGY.***Cat. I*

Life scientists are generating huge amounts of data on many different scales, from DNA and protein sequence, to information on biological systems such as protein interaction networks, brain circuitry, and ecosystems. Analyzing these kinds of data requires quantitative knowledge and approaches using computer science and mathematics. In this project-based course, students will use case studies to learn about both important biological problems and the computational tools and algorithms used to study them. Students will study a sampling of topics in the field; recent topics included complex disease genetics, HIV evolution, antibiotic resistance, and animal migration behavior. In addition, students will hear from several guest speakers about their interdisciplinary research. Computational tools explored will include both freely-available tools to analyze sequences and build phylogenetic trees (e.g. BLAST, MUSCLE, MEGA) as well as guided programming using languages such as Python, R, and Netlogo.

Students may not receive credit for both BCB / BB 100X and BCB / BB 1003.

BBT majors may count this course as fulfilling part of their quantitative science and engineering requirement, but not as part of their BB 1000 level course requirement.

Recommended background: High school biology. Programming experience is not required.

BCB/BB 3010. SIMULATION IN BIOLOGY.*Cat. II*

Computer simulations are becoming increasingly important in understanding and predicting the behavior of a wide variety of biological systems, ranging from metastasis of cancer cells, to spread of disease in an epidemic, to management of natural resources such as fisheries and forests. In this course, students will learn to use a graphical programming language to simulate biological systems. Most of the classroom time will be spent working individually or in groups, first learning the language, and then programming simulation projects. We will also discuss several papers on biological simulations from the primary scientific literature. In constructing and comparing their simulations, students will demonstrate for themselves how relatively simple behavioral rules followed by individual molecules, cells, or organisms can result in complex system behaviors.

Recommended background: Students taking this course must have a solid background in a biological area they would like to simulate, at about the depth provided by a BB 3000 level class. No programming experience is assumed.

This course will be offered in 2020-21, and in alternating years thereafter.

BCB 4001/BB4801. BIOINFORMATICS.*Cat. II*

In an age when the amount of new biological data generated each year is exploding, it has become essential to use bioinformatics tools to explore biological questions. This class will provide an understanding of how we organize, catalog, analyze, and compare biological data across whole genomes, covering a broad selection of important databases and techniques. Students will acquire a working knowledge of bioinformatics applications through hands-on use of software to ask and answer biological questions in such areas as genetic sequence and protein structure comparisons, phylogenetic tree analysis, and

gene expression and biological pathway analysis. In addition, the course will provide students with an introduction to some of the theory underlying the software (for example, how alignments are made and scored).

Recommended background: a working knowledge of concepts in genetics and molecular biology (BB2920 and BB2950 or equivalent), and statistics (MA 2610 or MA2611 or equivalent)

This course will be offered in 2020-21, and in alternating years thereafter.

BCB 4002/CS 4802. BIOVISUALIZATION.

Cat. II

This course will use interactive visualization to model and analyze biological information, structures, and processes. Topics will include the fundamental principles, concepts, and techniques of visualization (both scientific and information visualization) and how visualization can be used to study bioinformatics data at the genomic, cellular, molecular, organism, and population levels. Students will be expected to write small to moderate programs to experiment with different visual mappings and data types.

Recommended background: CS 2102 or CS 2103, CS 2223, and one or more biology courses.

This course will be offered in 2020-21, and in alternating years thereafter.

BCB 4003/CS 4803. BIOLOGICAL AND BIOMEDICAL DATABASE MINING.

Cat. II

This course will investigate computational techniques for discovering patterns in and across complex biological and biomedical sources including genomic and proteomic databases, clinical databases, digital libraries of scientific articles, and ontologies. Techniques covered will be drawn from several areas including sequence mining, statistical natural language processing and text mining, and data mining.

Recommended Background: CS 2102 or CS 2103, CS 2223, MA 2610 or MA 2611, and one or more biology courses.

This course will be offered in 2019-20, and in alternating years thereafter.

BCB 4004/MA 4603. STATISTICAL METHODS IN GENETICS AND BIOINFORMATICS.

Cat. II

This course provides students with knowledge and understanding of the applications of statistics in modern genetics and bioinformatics. The course generally covers population genetics, genetic epidemiology, and statistical models in bioinformatics. Specific topics include meiosis modeling, stochastic models for recombination, linkage and association studies (parametric vs. nonparametric models, family-based vs. population-based models) for mapping genes of qualitative and quantitative traits, gene expression data analysis, DNA and protein sequence analysis, and molecular evolution. Statistical approaches include log-likelihood ratio tests, score tests, generalized linear models, EM algorithm, Markov chain Monte Carlo, hidden Markov model, and classification and regression trees.

Recommended background: MA 2612, MA 2631 (or MA 2621), and one or more biology courses.

This course will be offered in 2019-20, and in alternating years thereafter.

BIOLOGY AND BIOTECHNOLOGY

BB 1001. INTRODUCTION TO BIOLOGY.

Cat. I

This course is designed for students seeking a broad overview of biologic concepts, especially at the cell and organism level. It is conducted in an active style including the use of case studies, class discussion/participation, and classroom polling systems. The major goal of this course is to help students become more informed citizens, skeptical when presented with data in the media, and knowledgeable enough to question and make informed decisions about scientific advances and science policy. It will primarily focus on current topics which may include stem cells, ethical uses of DNA, development of personalized medicine, genetic engineering, antibiotic resistance. This course is intended for non-life-science majors. This will not fulfill a major distribution requirement for BBT majors.

Recommended background: high school biology

BB 1002. ENVIRONMENTAL BIOLOGY.

Cat. I

This course is designed for students seeking a broad overview of ecological systems and the effect of humans on the ecosystems. It provides an introduction to natural ecosystems, population growth, and the interaction between human populations and our environment. It is conducted in an active style including the use of case studies, class discussion/participation, and classroom polling systems. The major goal of this course is to help students become more informed environmental citizens, skeptical when presented with data in the media, and knowledgeable enough to question and make informed decisions about the environment. It will primarily focus on current topics but areas of discussion likely to be covered include ecosystems, populations, biodiversity, pollution, environmental economics and climate change.

This course is intended for non-life-science majors. This will not fulfill a major distribution requirement for BBT majors.

Recommended background: high school biology

BB/BCB 1003. EXPLORING BIOINFORMATICS AND COMPUTATIONAL BIOLOGY.

Cat. I

Life scientists are generating huge amounts of data on many different scales, from DNA and protein sequence, to information on biological systems such as protein interaction networks, brain circuitry, and ecosystems. Analyzing these kinds of data requires quantitative knowledge and approaches using computer science and mathematics. In this project-based course, students will use case studies to learn about both important biological problems and the computational tools and algorithms used to study them. Students will study a sampling of topics in the field; recent topics included complex disease genetics, HIV evolution, antibiotic resistance, and animal migration behavior. In addition, students will hear from several guest speakers about their interdisciplinary research. Computational tools explored will include both freely-available tools to analyze sequences and build phylogenetic trees (e.g. BLAST, MUSCLE, MEGA) as well as guided programming using languages such as Python, R, and Netlogo.

Students may not receive credit for both BCB / BB 100X and BCB / BB 1003.

BBT majors may count this course as fulfilling part of their quantitative science and engineering requirement, but not as part of their BB 1000 level course requirement.

Recommended background: High school biology. Programming experience is not required.

BB 1025. HUMAN BIOLOGY.

Cat. I

This course presents students with an introduction to general concepts of human biology with particular focus on human structure and function. Concepts such as homeostasis, structure/function, and regulatory systems will be introduced. Discussion of current topics related to human health, such as personalized medicine and recent advances in cancer research and auto immune disease will be integrated throughout the course. This course is intended for BBT and other life science majors.

Recommended background: a solid working knowledge of biological principles such as would be learned in a rigorous high school biology course.

BB 1035. BIOTECHNOLOGY.

Cat. I

Through lectures, discussion and project work, students will gain an understanding of the function of biological systems at the molecular and cellular level. This course will explore topics such as genes-to-proteins, cell cycle regulation, genomics, and cell signaling as foundational concepts in genetic and cellular engineering, synthetic biology, stem cell generation, regenerative and personalized medicine and the production of therapeutic biologics. Projects will be designed to facilitate students' understanding of the links between biological systems and biotechnology applications, including their impact on society. This course is intended for BBT and other life science majors.

Recommended background: a solid working knowledge of biological principles such as would be learned in a rigorous high school biology course.

BB 1045. BIODIVERSITY.*Cat. I*

Through lectures, readings, and discussions this course will examine the breadth, patterns, mechanisms, and conservation of biodiversity. Case studies and peer-to-peer learning will be used to examine threats to regional and global biodiversity and assess management and engineering strategies for solutions to the biodiversity crisis. Students will investigate and interpret past and contemporary research to quantify, document, and track trends in biodiversity. This course will use problem sets and assignments to explore the natural, social, and economic tradeoffs associated with threats to and conservation of biodiversity. Students will develop an area of expertise and synthesize their comprehension of topics through project work (e.g., management plan, report, presentation, citizen science). Finally, this course will provide a synthesis of the interdisciplinary nature of biodiversity conservation and how principles of conservation biology, landscape ecology, metapopulation biology, and biogeography can be applied to strategies aimed towards sustaining Earth's biota. This course is intended for BBT and other life science majors.

Recommended Background: a solid working knowledge of biological principles such as would be learned in a rigorous high school biology course.

BB 2003. FUNDAMENTALS OF MICROBIOLOGY.*Cat. I*

This course will introduce the basic principles of microbiology through lectures, discussion, readings, and projects. The course will explore both the fundamental biology of microbes and the ways in which microbes influence society and the world. Topics will include the morphology, physiology, and genetics of unicellular organisms with a primary focus on bacteria. Special attention will be given to organisms known to have important roles in health, research, industry, and the environment. This course is designed for all biology majors and other students who seek a good general education in modern biology.

Recommended background: A basic understanding of cell biology and elementary biochemical processes (BB 1035, BB 2550 or equivalent).

BB 2030. PLANT DIVERSITY.*Cat. I*

This course focuses on general biological concepts as they relate to the vast array of plant species and their taxonomic links. Current uses of major plant phyla in both society and the biotechnology industry will be explored. Some emphasis will be given to economically important species chosen from agronomic and non-agronomic situations.

Recommended background: a working knowledge of concepts in biodiversity (BB 1045 or equivalent)

Students may not receive credit for both BB 2030 and BB 1040.

BB 2040. PRINCIPLES OF ECOLOGY.*Cat. I*

This course is intended to help students understand ecological concepts at different levels of integration, from individuals to ecosystems, and the linkages among them. Students will also practice the application of qualitative and quantitative models to ecological systems and processes, as well as hypothesis generation, experimental design, and analysis and interpretation of data. In a format that includes team-based case studies, discussion and presentations, and ecological simulations, students will explore topics in both basic and applied ecology, which may include population ecology, host-parasite ecology and epidemiology, climate change, and sustainable agriculture, among others.

Recommended background: a working knowledge of concepts in biodiversity (BB 1045 or equivalent) and integral and differential calculus

BB 2050. ANIMAL BEHAVIOR.*Cat. I*

This course will provide an introduction to the scientific study of animal behavior. A combination of lecture, reading, and video will be used to illustrate how proximate and ultimate forces interact to shape animal behavior in complex and fascinating ways. Behavioral phenomena in all members of the animal kingdom will be discussed and analyzed from ecological, evolutionary, cognitive, and neurobiological perspectives to highlight how the use of an integrative approach has greatly accelerated our ability to solve complex behavioral problems. Primary scientific literature will be used to outline experimental tools and techniques used to investigate behavior in different contexts, including communication, foraging, navigation, mate choice, predation, and social behavior.

BB 2550. CELL BIOLOGY.*Cat. I*

The goal of this course is to help students to develop a working understanding of the unifying concepts that define cell structure and function including replication, metabolism, regulation, communication and death. Applications in therapeutics, molecular medicine, and genetic engineering will be introduced. Classic and current research examples will provide practice in hypothesis generation and testing as well as making clear the importance of a working knowledge of cell biology to support advances in biotechnology and medicine. The course serves as the foundation of all fields of modern biology, and is recommended for all BBT and other life science majors.

Recommended background: a working knowledge of concepts in biotechnology (BB 1035 or equivalent)

BB 2920. GENETICS.*Cat. I*

Through interactive lectures, group problem solving, and analysis of primary scientific literature, this course will help students understand the gene concept and its application in modern biological analysis. This course will cover patterns of inheritance, the relationship between genotype and phenotype, and the transmission, coding, and expression of genetic information contained in DNA, in several model systems. Students will gain an understanding of the modern tools of genetic analysis, including gene cloning, creation of transgenic organisms, high-throughput sequencing and RNA interference. Applications of genetic analysis to current advancements in agriculture through crop improvements, and in human health, including gene therapy and personalized medicine, will be explored.

Recommended background: a working knowledge of concepts in biotechnology (BB 1035 or equivalent)

BB 2950. MOLECULAR BIOLOGY.*Cat. I*

Through a combination of lectures and in class discussion, students will learn and understand the essential concept of molecular biology, including the mechanisms by which information stored in nucleic acids is maintained and processed in living systems. An evolutionary framework will help illustrate how genomes are structured and how they change. Basic regulatory mechanisms of gene expression will be addressed, with emphasis in eukaryotic gene regulatory proteins. The concepts learned in this course will provide the foundation to continue exploring this rapidly expanding field.

Recommended background: a working knowledge of concepts in biotechnology (BB 1035 or equivalent)

BB 3003. MEDICAL MICROBIOLOGY: PLAGUES OF THE MODERN WORLD, A CASE STUDY APPROACH.*Cat. I*

Using a case study approach, this course will focus on molecular mechanisms of pathogenesis of a wide range of infectious diseases and host-pathogen interactions including a survey of human immunobiology. Students will gain an understanding of microbes that are of medical relevance including bacteria, viruses, fungi, and protozoans, enabling them to make informed decisions about appropriate medical interventions. Students will be able to evaluate how their day-to-day choices impact public health as well as alter microbial communities. This interactive course is designed for all biology and biochemistry majors as well as other students with the recommended background who have an interest in the pathogenesis of disease.

Recommended background: a working knowledge of concepts in biotechnology, molecular biology and microbiology (BB 1035, BB 2950, and BB 2003 or equivalent)

Students may not receive credit for both BB 2002 Microbiology: Plagues of the Modern World and BB 3003.

BB/BCB 3010. SIMULATION IN BIOLOGY.*Cat. II*

Computer simulations are becoming increasingly important in understanding and predicting the behavior of a wide variety of biological systems, ranging from metastasis of cancer cells, to spread of disease in an epidemic, to management of natural resources such as fisheries and forests. In this course, students will learn to use a graphical programming language to simulate biological systems. Most of the classroom time will be spent working individually or in groups, first learning the language, and then programming simulation projects. We will also discuss several papers on biological simulations from the primary scientific literature. In

constructing and comparing their simulations, students will demonstrate for themselves how relatively simple behavioral rules followed by individual molecules, cells, or organisms can result in complex system behaviors.

Recommended background: Students taking this course must have a solid background in a biological area they would like to simulate, at about the depth provided by a BB 3000 level class. No programming experience is assumed.

This course will be offered in 2020-21, and in alternating years thereafter.

BB 3050. CANCER BIOLOGY.

Cat. I

In this course, students will learn and apply advanced cellular and molecular biology concepts to understand causes and consequences of cancer cell transformation. Through an integration of primary literature and lecture material students will explore how research into basic mechanisms of cancer biology is used to identify therapeutic targets, and inform drug design. This course will cover discussion of the hallmarks of cancer including the deregulation of cell growth, cell death, and metabolism; corruption of genome stability, evasion of immune response, and metastatic potential.

Recommended background: A thorough understanding of genetics (BB 2920 or equivalent), molecular biology (BB 2950 or equivalent), and cell biology (BB 2550 or equivalent).

BB 3080. NEUROBIOLOGY.

Cat. I

The nervous system underlies every aspect of our behavior, including sensation, movement, emotion, and cognition. In this course, students will develop an understanding of neurobiology at several levels, from the physiology of individual neurons, through the functioning of neural circuits, and finally to the behavior of neural systems such as vision, motion, and memory. The class will be based on lectures accompanied by in-class activities, and will include weekly discussion of a paper from the scientific literature. The class will focus each year on a guiding theme, such as a particular neurotransmitter system, and will emphasize research on human neurological problems, such as schizophrenia, addiction, Alzheimer's disease, and autism.

Recommended background: a working knowledge of concepts in cell biology (BB 2550 or equivalent), and either genetics or molecular biology (BB2920 or BB2950 or equivalent)

Suggested background: a working knowledge of concepts related to the anatomy and physiology of movement and communication (BB 3101 or equivalent).

Students may not receive credit for both BB 4080 and BB 3080.

BB 3101. HUMAN ANATOMY & PHYSIOLOGY: MOVEMENT AND COMMUNICATION.

Cat. I

The form and function of the systems that are responsible for the support, movement, internal communication, and interaction of the human body with its environment will be presented and discussed: Integumentary, Skeletal, Muscular, Nervous (including the senses), and Endocrine.

Recommended background: BB 1025 and BB 2550.

Suggested background: Concurrent Laboratory Module: BB 3511. Students who have received credit for BB 2130 may not take BB 3101 for credit.

BB 3102. HUMAN ANATOMY & PHYSIOLOGY: TRANSPORT AND MAINTENANCE.

Cat. I

The form and function of the systems of the human body that provide for the intake, distribution, and processing of nutrients, water, and oxygen, and the systems that safeguard health by elimination of wastes, regulation of metabolism, and surveillance against disease will be presented and discussed. Digestive, Respiratory, Circulatory, Lymphatic, Endocrine, Urinary, and Reproductive.

Recommended Background: BB 1025 and BB 2550; CH 1010 and CH 1020.

Suggested background: Concurrent Laboratory Module: BB 3514. Students who have received credit for BB 3110 may not take BB 3102 for credit.

BB 3120. PLANT PHYSIOLOGY.

Cat. II

This course explores the remarkable physiology of plants and emphasizes their importance in past and future life on earth. Conserved and unique aspects of plant cellular physiology will provide the foundation to understand the challenges of life on land and multicellularity. Topics such as water relations, mineral nutrition, intra- and inter-cellular transport, photosynthesis, and light responses will be discussed. Examples from the recent literature will be used to illustrate some of the key existing problems in plant physiology.

Recommended background: a working knowledge of concepts in biodiversity and cell biology (BB 1045 and BB 2550 or equivalent) and in chemical reactions (CH 1020 or equivalent)

This course will be offered in 2019-20, and in alternating years thereafter.

Some sections of this course may be offered as Writing Intensive (WI).

BB 3140. EVOLUTION: PATTERN AND PROCESS.

Cat. II

In this course, students will explore the foundations of micro- and macro-evolutionary theory and will learn to apply these fundamental evolutionary principles through critical analysis of the primary scientific literature. In a course format that emphasizes team-based case studies, discussion of recent and classic papers, and computer simulation of evolutionary processes, students will explore the evolutionary foundations of a wide range of biological disciplines, and will gain experience in critical evaluation of approaches, arguments, and points of view in the field. Topics may include the history of life on Earth; biogeography and the origins of biodiversity; host-pathogen coevolution; and genomic and molecular evolution, among others.

Recommended background: a working knowledge of the principles of ecology and genetics (BB2040 and BB2920 or equivalent) and integral and differential calculus

This course will be offered in 2019-20, and in alternating years thereafter.

BB 3620. DEVELOPMENTAL BIOLOGY.

Cat. II

Through lecture, reading, and discussion, this course will help students understand how developmental biologists study the development of a fertilized egg into a multi-cellular animal. Beginning with the description of developmental events, the major problems of developmental biology such as determination of cell fate, differentiation, and pattern formation will be explored. Emphasis will be placed on techniques such as analysis of mutations, molecular genetics, gene transfer, and the use of model organisms. Societal implications of the ability to control the outcome of development will be discussed.

Recommended background: a working knowledge of concepts in microbiology, cell biology and genetics (BB 2002, BB 2550, and BB 2920 or equivalent)

This course will be offered in 2019-20, and in alternating years thereafter.

BB 3920. IMMUNOLOGY.

Cat. I

Through lecture, reading, and discussion, this course will help students understand the origin of immune cells in bone marrow development, the distinction between innate and adaptive immunity, and the function of the immune system in health and disease. The mechanisms responsible for the exquisite specificity of the adaptive immune system will be described. Throughout the course, the probable paths of evolution of the immune system will be stressed. As examples of major genetic diseases of immunity, case studies will be discussed on a weekly basis.

Recommended background: a working knowledge of the concepts in cell biology, genetics and biochemistry (BB 2550, BB 2920, CH 4110 and 4120 or equivalent)

BB/CH 4190. REGULATION OF GENE EXPRESSION.

Cat. I

Through lectures, problem sets, reading and discussion, and presentations this course will help elucidate for students the processes that allow regulated gene expression, mechanisms used in each type of regulation, and methods and techniques used for investigation of regulatory mechanisms. Readings from the current original research literature will explore the growing use of model systems and "omics" level approaches to enhance our ever expanding understanding of the gene regulatory mechanisms. The development of cell-based therapeutics and genetic engineering as they relate to gene regulation will be introduced.

Recommended background: a working knowledge of concepts in biochemistry and molecular genetics (CH 4110, 4120, 4130 and BB 4010 or equivalent)

BB 4260. SYNTHETIC BIOLOGY.

Cat. II

Do we yet have the technology to engineer life? Can we control gene expression to create organisms that function in useful ways? Do we understand the tenets of genetic regulation as well as we think we do? These important questions and more are investigated by the emerging field of Synthetic Biology. In this course, students will explore this exciting new realm of biology through in-depth analysis and discussion of primary literature. Topics to be covered include the

design and construction of synthetic gene circuits, synthesis of new genes and genomes, logic gate regulation of gene expression, and the latest applications of synthetic biology to advances in medicine, information processing, and the environment.

Recommended Background: Students should have a strong foundational knowledge of cell biology, molecular biology, and genetics, as would be obtained from BB2550, BB2920, and BB2950.

This course will be offered in 2020-21, and in alternating years thereafter.

BB 4801/BCB 4001. BIOINFORMATICS.

Cat. II

In an age when the amount of new biological data generated each year is exploding, it has become essential to use bioinformatics tools to explore biological questions. This class will provide an understanding of how we organize, catalog, analyze, and compare biological data across whole genomes, covering a broad selection of important databases and techniques. Students will acquire a working knowledge of bioinformatics applications through hands-on use of software to ask and answer biological questions in such areas as genetic sequence and protein structure comparisons, phylogenetic tree analysis, and gene expression and biological pathway analysis. In addition, the course will provide students with an introduction to some of the theory underlying the software (for example, how alignments are made and scored).

Recommended background: a working knowledge of concepts in genetics and molecular biology (BB2920 and BB2950 or equivalent), and statistics (MA 2610 or MA2611 or equivalent)

This course will be offered in 2019-20, and in alternating years thereafter.

BB 4900. CAPSTONE EXPERIENCE IN BIOLOGY AND BIOTECHNOLOGY.

Cat. I

These classes will serve as integrative experiences for students majoring in Biology & Biotechnology. The course will help students integrate concepts from other courses in the curriculum, practice skills of critical analysis, and evaluate and communicate scientific information effectively. The specific theme of each offering will center around a current topic of biological interest, and may include such areas as genomics, cancer, environmental problems, and synthetic biology. Prior to enrolling in the seminar, a student should have completed all of the BB course distribution requirements for BBT majors at the 1000 and 2000 level, or should seek advice from the course instructor.

Topics will be announced prior to registration in the year preceding the course offering.

IS4 BB. SPECIAL TOPICS.

Cat. I

Experimental courses, special conferences and seminars are offered by advance arrangement only.

BIOLOGY AND BIOTECHNOLOGY LAB COURSES

The lab activities in these courses will provide foundational skills needed for the study of living organisms and systems at the molecular, organismal and environmental level. In these labs students will begin building the skills to carry into more advanced labs, their MQPs and professional careers. In particular students will gain experience with scientific procedures and techniques, technical equipment, teamwork, laboratory safety, hypothesis generation and testing, scientific data analysis (including statistics), oral and written scientific communication and skills common to all areas of biology.

BB 2902. ENZYMES, PROTEINS, AND PURIFICATION.

Cat. I (1/6 unit)

This course gives basic practical experimental experience in enzymology, how enzymes work and how to purify them for later use. These techniques are the foundation the design and production of many therapeutic products. Examples of the types of techniques and experiences included in this course are:

- The action and optima of enzyme catalysis
- Induction of enzyme production
- Quantification and detection techniques for proteins
- Extraction and purification of protein from biological material using column chromatography
- Identification of compounds using Thin Layer Chromatography

Recommended background: a working knowledge of concepts in biotechnology (BB 1035 or equivalent).

BB 2903. ANATOMY AND PHYSIOLOGY.

Cat. I (1/6 unit)

This course is an active exploration of a number of topics in anatomy and physiology through the use of simulations, measurement and hands on discovery. It will be particularly relevant to any student considering a health related career, doing work where body structure is relevant or has interest in how body systems connect. A significant portion of this discovery will be accomplished by a hands-on dissection. Examples of the specific types of techniques and experiences included in this course are:

- Comparative and general anatomy of several organisms
- Physiology and function of body systems, processes and organs.
- Enzyme Linked Immunosorbent Assay (ELISA)
- Microscopy

Recommended background: a working knowledge of concepts in human biology (BB 1025 or equivalent).

BB 2904. ECOLOGY, ENVIRONMENT, AND ANIMAL BEHAVIOR.

Cat. I (1/6 unit)

This course examines topics in ecology and animal behavior through hands on experimentation and simulation. Activities in this course include interactions and observation of live animals as well as some outdoor activities and environmental sampling. This course will be relevant to students who have an interest in biology at more than the individual organism level as well as those with majors involving environmental and ecological concerns. Examples of the specific types of techniques and experience included in this course are:

- Observing, recording, understanding, and analyzing animal behaviors
- Handling of organisms
- Environmental and ecological assessment and sampling
- Observations of population dynamics

Recommended background: a working knowledge of concepts in biodiversity (BB 1045 or equivalent).

BB 2915. SEARCHING FOR SOLUTIONS IN SOIL: MICROBIAL AND MOLECULAR INVESTIGATIONS.

Cat. I (1/3 unit)

Students in this course will be part of a national student crowd sourcing initiative, developed in response to a decreasing supply of effective antibiotics and increased microbial resistance, to identify novel antibiotics produced by soil bacteria. Operating in an authentic research paradigm, students will gain skill in the process of scientific inquiry, including hypothesis generation and testing, and in common procedures of microbial culture and characterization. They will learn about and have the opportunity to use the techniques of recombinant DNA including the use of plasmids, restriction enzymes, and PCR. At the conclusion of the course students will report their findings in a poster style format and will be able to see the results of other groups around the country.

Recommended background: A familiarity with current topics in biotechnology or microbiology such as those introduced in BB 1035 and BB 2003, or equivalent.

Students may not receive credit for this course and either BB 2901 and BB 2905.

BB 2917. HUNTING FOR PHAGE.

Cat. I (1/3 unit)

Students in this course will become part of a national crowd sourcing initiative to isolate and identify novel bacteriophage. Students will design experiments to initially isolate phage (bacterial viruses) from environmental samples they have collected, then characterize and determine their DNA sequence. The DNA sequences will be used in the follow-on bioinformatics course BB 3526 Phage Hunters: The Analysis. Students in this course will make significant contributions to the field of genomics while gaining skill in the process of scientific inquiry, including hypothesis generation and testing, and practice in common microbiologic techniques.

Recommended background: A working knowledge of biotechnology or microbiology (BB 1035 or BB 2003, or equivalent).

Students enrolled in this course may wish to consider enrollment in BB 3526 (Phage Hunters: The Analysis).

Students that have already received course credit for BB 291X or BB 2916 may not also receive credit for BB 2917.

BB 3511. NERVE AND MUSCLE PHYSIOLOGY.*Cat. I (1/6 unit)*

Exercises in this course focus on computer and wet laboratory studies of nerve and muscle structure and function. Students will gain experience in hypothesis generation and testing, and will have extensive experience using an interactive biomedical/physiological data acquisition and analysis system.

Recommended background: a working knowledge of laboratory skills and concepts in anatomy and physiology (BB 2903 and BB 3101 or equivalent).

BB 3512. MOLECULAR GENETICS LAB.*Cat. I (1/6 unit)*

The topic of gene therapy will be used to give students experience with several fundamental skills in biotechnological research and practice: on-line information search and retrieval, computer cloning, and biological sequence analysis and manipulation. Course is entirely computer based.

Recommended background: a working knowledge of laboratory skills and concepts in molecular biology, microbiology and genetics (BB 2901, BB 2950, BB 2002, and BB 2920 or equivalent).

BB 3513. CELL CULTURE TECHNIQUES FOR ANIMAL CELLS.*Cat. I (1/6 unit)*

Basic laboratory skills in mammalian cell culture to include cell counting, freezing and thawing cell lines, culture of suspension and attached cells.

Recommended background: BB 2901, BB 2550 and knowledge of aseptic techniques.

Concurrent or prior registration in BB 4008 is recommended.

BB 3514. CIRCULATORY AND RESPIRATORY PHYSIOLOGY.*Cat. I (1/6 unit)*

Exercises in this course focus on wet laboratory and computer studies of circulatory and respiratory system structure, function and physiology. Students will gain experience in hypothesis generation and testing, and will be introduced to an interactive biomedical/physiological data acquisition and analysis system.

Recommended background: a working knowledge of laboratory skills and concepts in anatomy and physiology (BB 2903 and BB 3102 or equivalent).

BB 3517. FERMENTATION.*Cat. I (1/6 unit)*

The experiments in this course focus on basic fermentation theory and practice, common to any bio-product production facility. Students will gain significant experience in hypothesis generation and testing as they work toward the goal of optimizing their proposed culture media.

Recommended background: a working knowledge of laboratory techniques in molecular biology, and microbiology (BB 2901 or equivalent), and concepts in cell biology (BB 2550 or equivalent).

BB 3519. PROTEIN PURIFICATION.*Cat. I (1/6 unit)*

This is a laboratory course focusing on the theory and practice of protein purification from a primary source. Chromatographic techniques will include two more of the most commonly used in the biotech industry.

Recommended background: a working knowledge of laboratory skills in enzyme and protein purification, and concepts in biochemistry (BB 2902 and CH 4110 or equivalent).

BB 3521. MICROSCOPY.*Cat. II (1/6 unit)*

Through a research-based laboratory and short lectures, students will learn the basic principles of image formation, resolution, and digital imaging. Students will develop confidence in the use of the light microscope and be able to apply different modes of microscopy to solve biological problems. This course emphasizes a quantitative approach to microscopy and digital imaging applied toward simple phenotypic analysis. Student will develop scientific writing skills and learn how to prepare professional quality images.

Recommended background: a working knowledge of laboratory techniques in molecular biology, and microbiology (BB 2901 or equivalent), and concepts in cell biology (BB 2550 or equivalent)

Some sections of this course may be offered as Writing Intensive (WI).

BB 3525. PLANT PHYSIOLOGY.*Cat. I (1/6 unit)*

Basic studies in the biochemical and physical systems plants use to sustain life; includes an introduction to plant cell culture techniques.

Recommended background: BB 1045 and BB 2903.

Concurrent or prior registration in BB 3120 is recommended.

Students who have received credit for BB 325X may not receive credit for BB 3525.

Some sections of this course may be offered as Writing Intensive (WI).

BB 3526. PHAGE HUNTERS: THE ANALYSIS.*Cat. I (1/6 unit)*

In this computer lab students will work with phage genomic sequences obtained from novel bacteriophages isolated in BB 2910, Phage Hunters: The Quest. The raw genome files will be finished and oriented; students will then search the sequence to identify and map existing genes and other genomic components (sequence annotation). Additional course goals are to do an initial comparative genomic analysis and post-annotation experimentation. The ultimate goal is to produce novel bacteriophage genome sequences that are ready to be submitted to GenBank, the US repository of DNA sequence information at the National Institute of Health.

Recommended background: a working knowledge of genome structure and function (BB 2920, BB 2950, or equivalent).

Students planning to take this course may wish to consider enrollment in BB 2916 (Phage Hunters: The Quest)

Students may not receive credit for both BB 350X and BB 3526

BB 3527. MOLECULAR BIOLOGY AND GENETIC ENGINEERING: APPROACHES AND APPLICATIONS.*Cat. I (1/3 unit)*

In this laboratory based course, students will learn to use current techniques in molecular and genetic engineering to address authentic research questions. Students will design and execute experiments to assess hypotheses, and evaluate data relative to those hypotheses. Specific approaches may include the generation of novel plasmids, genes, and cells, designed to specifically address contemporary problems in biology and biomedical science. In each offering, the problem addressed will be selected from and the results contribute to current faculty research initiatives.

Recommended background: Working knowledge of the principles of molecular biology (BB 2950 or BB 2920 or equivalent) and cell biology (BB 2550 or equivalent), as well as relevant biology laboratory experience (BB 2905, BB 2915, or BB 2916).

Students may not receive credit for both BB 356X and BB 3527.

BB/CH 4170. EXPERIMENTAL GENETIC ENGINEERING.*Cat. I (1/3 unit)*

This laboratory course focuses on modern DNA technologies and general applications of gene manipulation. Topics include gene amplification and recombination, promoter and plasmid engineering, gene expression and analysis, model systems, CRISPR, genomics and transgenics. Experiments in this course are integrated into an overall genetic engineering project throughout the term that will involve techniques such as electrophoresis, quantitative spectrofluorimetry, and real-time quantitative PCR. Methods of data analysis, common statistical approaches and technical writing will be emphasized throughout the course.

Recommended background: Knowledge of organic chemistry fundamentals as well as biochemical concepts including DNA replication and recombination, RNA synthesis and protein synthesis. Familiarity with cellular architecture is also recommended. See CH 2310, BB 2550 and CH 4110 or equivalent.

Graduate Biology and Biotechnology Courses of Interest to Undergraduates

The following courses are open to advanced undergraduates with special written permission of the course instructor and department head.

BB 501. SEMINAR.

BB 509. SCALE-UP OF BIOPROCESSING.

Strategies for optimization of bioprocesses for scale-up applications. In addition to the theory of scaling up unit operations in bioprocessing, students will scale-up a bench scale bioprocess (5 liters) including fermentation and downstream processing to 55 liters. Specific topics include the effects of scaling-up on: mass transfer and bioreactor design, harvesting techniques including tangential flow filtration and centrifugation, and chromatography (open column and HPLC).

Recommended courses include BB 3055 Microbial Physiology and BB 4070/560 Separations of Biological Molecules, as a working knowledge of the bench scale processes will be assumed. Otherwise, instructor permission is required.

BB 542. ECOLOGICAL SIMULATION MODELING.

This course will cover computer simulation modeling of populations, bioenergetics, behavior of individuals, and ecosystem dynamics. Modeling techniques covered will range from simple linear models of populations and interactions between ecosystem components to individual-based models of populations in complex environments. Students successfully completing the course should be capable of understanding models used in today's study of populations and ecosystems and of developing original models. Knowledge of a programming language is assumed.

BB 560. SEPARATION OF BIOLOGICAL MOLECULES.

This course provides a detailed hands-on survey of state-of-the-art methods employed by the biotechnology industry for the purification of products, proteins in particular, from fermentation processes. Focus is on methods which offer the best potential for scale-up. Included are the theory of the design as well as the operation of these methods both at the laboratory scale as well as scaled up. It is intended for biology, biotechnology, chemical engineering, and biochemistry students. A knowledge of basic biochemistry is assumed.

BB 565. VIROLOGY.

This advanced-level course uses a seminar format based on research articles to discuss current topics related to the molecular/cell biology of viral structure, function, and evolution. Particular emphasis is placed on pathological mechanisms of various human disorders, especially emerging diseases, and the use of viruses in research.

BB 570. SPECIAL TOPICS.

Specialty subjects are offered using the research expertise of the department faculty. Content and format varies to suit the interest and needs of the faculty and students. This course may be repeated for different topics covered.

BB 575. ADVANCED GENETICS & CELL BIOLOGY.

Topics in this course focus on the basic building blocks of life; molecules, genes and cells. The course will address areas of the organization, structure, function and analysis, of the genome and of cells. Required Background: Students in the course should be familiar with the fundamentals of recombinant DNA and molecular biological techniques as well as cell biology.

BB 576. ADVANCED INTEGRATIVE BIOSCIENCE.

This course concentrates on the organization of cells into biological systems and into individual organisms. Discussion will center on the development and function of specific model systems such as the nervous and immune systems. Required background: Students in the course should be familiar with the fundamentals of developmental biology, genetics and cell biology.

BB 577. ADVANCED ECOLOGICAL & EVOLUTIONARY BIOSCIENCE.

This course will explore the organization of individuals into communities, and the evolution of individual traits and behaviors. Problems discussed will range from those of population harvesting and the effect humans have on the environment to the evolution of disadvantageous traits. Required background: Students should be familiar with fundamentals of population interactions, evolution and animal behavior.

BB 578. ADVANCED APPLIED BIOTECHNOLOGY.

This course examines the use of biotechnological advances towards solving real world problems. Students will discuss problem-solving strategies from the current literature in the areas of medicine, agriculture, environmental protection/restoration and industrial biotechnology. Required background: Students should be familiar with biochemistry, microbiology, and plant and animal physiology.

BIOMEDICAL ENGINEERING

The second digit for Biomedical Engineering course numbers is coded as follows:

- 0 — Bioinstrumentation, Biosignals, Introduction
- 1 — Physiology
- 2 — Bioelectric, Bioimaging
- 3 — Design
- 4 — Communication
- 5 — Biomechanics, Biological Systems
- 6 — Biofluids
- 7 — Cellular and molecular
- 8 — Biomaterials

NOTE: Courses listed in previous catalogs with "BE" as the prefix and the same course number as below are considered to be the SAME COURSE.

BME 1001. INTRODUCTION TO BIOMEDICAL ENGINEERING.

Cat. I

This course uses lectures, demonstrations, projects and scientific literature readings on the major branches of biomedical engineering. A series of guest lectures, including device demonstrations introduce students to the many branches of biomedical engineering. Course work for BME 1001 is based on small, creative projects focusing on primary literature, department research, global health, and biomedical engineering as a whole.

BME 1004. INTRODUCTION TO PROGRAMMING IN MATLAB.

Cat. I

This course will introduce basic and essential programming skills in modern engineering program language, Matlab, to all BME students. The course will include basic programming syntax, control structures, data structures (vectors, matrices, structures, cell arrays), 2D images, 3D image volumes, string manipulations, File I/O, figure plotting/visualization, image display, and basic graphical user interface (GUI) design.

Recommended background: none.

NOTE: The course does not count for engineering credits, but will fulfill the computer programming requirement for BME students.

BME 2001. INTRODUCTION TO BIOMATERIALS.

Cat. I

This beginning course provides important background for all science and engineering disciplines regarding the capabilities and limitations of materials relevant to the development of medical devices. Students are introduced to the fundamental theme of materials science – structure-property-processing relationships in biomaterials, specifically metals, ceramics, and plastics. Aspects of material structure range from the atomic to microstructural and macroscopic scales. In turn, these structural features determine the properties of materials. In particular, this course investigates connections between structure and mechanical properties, and how working and thermal treatments may transform structure and thus alter material properties. This knowledge is then applied to material selection decisions for the design of medical devices and engineered tissues.

Recommended background: prior knowledge of college-level chemistry and physics.

Students who have previously received credit for ES 2001 or BME 2811 may not receive credit for BME 2001.

BME 2210. BIOMEDICAL SIGNALS, INSTRUMENTS AND MEASUREMENTS.

Cat. I

This course is an introduction to the instrumentation methods used to measure, store and analyze the signals produced by biomedical phenomena. The goal of this course is to familiarize students with the basic design and implementation of techniques for measuring a broad scope of signal types for molecular, cellular and physiological research. Sensors used for acquiring electrical, magnetic, optical/spectral and chemical signals will be covered. Topics include the underlying physics and chemistry of biomedical signals, biosensor types and usage, amplification and signal conditioning, data acquisition methods, and sources of artifact and noise.

Recommended background: PH 1120/21, CH 1010 or equivalent.

BME 2211. BIOMEDICAL DATA ANALYSIS.*Cat. I*

To learn the fundamentals of basic signal processing methods as well as linear time series analyses framework for modeling and mining biological data. Tools of data analysis include statistics for determining significance of a result, Laplace and Z transforms, convolution, correlation, sampling theorem, Fourier transform, transfer function, coherence function and various filtering techniques. The goal of this course is to offer the students an opportunity to learn and model and simulate static and dynamic physiological systems using linear systems theory. First principles of chemistry and physics are used to quantitatively model physiological systems. Most of the models are based on linear systems theory. Simulations and estimation are performed using Matlab and already-developed software.

Recommended background: BME 2210, CS 1004 or equivalent.

BME 2502. INTRODUCTION TO BIOMECHANICS: STRESS ANALYSIS*Cat. I*

This is an introductory course that addresses the analysis of basic mechanical and structural elements relevant to biomechanics. Topics include general concepts of stresses, strains, and material properties of biomaterials and biological materials including viscoelasticity. Also covered are stress concentrations, two-dimensional stress transformations, principal stresses, and Mohr's circle. Applications are to uniaxially loaded bars, circular shafts under torsion, bending and shearing and deflection of beams. Both statically determinate and indeterminate problems are analyzed.

Recommended background: Differential (MA 1021) and integral (MA 1022) calculus, vector algebra (MA 1023), physics mechanics (PH 1110 or PH 1111), and statics (ES 2501). Students who have previously received credit for BME 2511 or ES 2502 may not receive credit for BME 2502.

BME 2610. INTRODUCTION TO BIOPROCESS ENGINEERING.*Cat. I*

This course is an introduction to fundamental material and energy balances related to the field of Biomedical Engineering. The fundamentals of bioprocess engineering calculations and data analysis, and bioengineering processes and process variables will be covered. Students will learn to identify a system, define boundary conditions, and characterize the system processes to generate appropriate material and energy balances using the principles of conservation of mass and energy. Fundamentals and applications in the human body and biomaterials are examined. Specific examples may include an organ, multiple organs or the entire body, bioprocess instrumentation, individual or groups of cells, cell culture bioreactors, tissue engineered scaffolds, and drug delivery systems.

Recommended background: Basic knowledge of differential and integral calculus (e.g. MA 1021 and MA 1022 or equivalent), human biology (e.g., BB 1025 or equivalent), and chemistry (e.g. CH 1010 and CH1020 or equivalent).

BME 3111. PHYSIOLOGY AND ENGINEERING.*Cat. I*

This course provides students with an understanding of mammalian physiology and the engineering aspects of different physiological systems. The course will have both a lecture and laboratory portion. The laboratory portion will provide the students with the ability to analyze and interpret data from living systems, which is a required ABET program criteria for student majoring in Biomedical Engineering. The course will focus on a number of organ systems that may include cardiovascular, respiratory, and renal. Engineering principles that include biomechanical, bioelectrical, and biofluids will be applied to physiological systems.

Recommended background: A knowledge of Cell Biology (such as BB 2550), biomechanics and biotransport (such as BME 2511), and signal analysis (such as BME 2210) or equivalent.

BME 3300. BIOMEDICAL ENGINEERING DESIGN.*Cat. I*

Students are guided through the open-ended, real-world, design process starting with the project definition, specification development, management, team interactions and communication, failure and safety criteria, progress reporting, marketing concepts, documentation and technical presentation of the final project outcome. The course will include a significant writing component, will make use of computers, and hands-on design explorations.

Students who have previously received credit for BME 2300 may not receive credit for BME 3300.

BME 3610. TRANSPORT ANALYSIS IN BIOENGINEERING.*Cat. I*

This course provides an overview of the modeling and analysis of fluid and mass transport processes related to the field of Biomedical Engineering and Bioprocess Engineering. Fundamentals and applications of hydrostatics, conservation of mass and momentum in modeling and analysis of biological fluid transport processes in the human body and bioprocess equipment are presented and discussed. It includes modeling and analysis of blood and biological fluid flow through blood vessels, capillary beds and bioprocess equipment. Modeling and analysis of diffusive and convective mass transport in biological conduits and membranes, selective permeability and nutrient/waste exchange in parenchymal tissues with transport barriers unique to biological systems such as intact and fenestrated endothelium. Basic concepts of pharmacokinetics such as plasma clearance, volume of distribution of drugs and other biological solutes in body tissues are also covered. Surface adsorption and membrane permeability concepts are covered in the context of biological solute exchange in capillaries and bioprocess operations. Students may not receive credit for both BME 3610 and BME 361X.

Recommended background: Basic knowledge of differential and integral calculus (e.g., MA 2051 or equivalent), fundamental knowledge of biological system function or cell function (e.g., BB 1035 or BB 2550 or equivalent), fundamentals of data analysis and process modeling such as some of the topics covered in BME 2211 or BME 2610 or ChE 2011, or equivalent.

BME/ECE 4011. BIOMEDICAL SIGNAL ANALYSIS.*Cat. II*

Introduction to biomedical signal processing and analysis. Fundamental techniques to analyze and process signals that originate from biological sources: ECGs, EMGs, EEGs, blood pressure signals, etc. Course integrates physiologic knowledge with the information useful for physiologic investigation and medical diagnosis and processing. Biomedical signal characterization, time domain analysis techniques (transfer functions, convolution, auto- and cross-correlation), frequency domain (Fourier analysis), continuous and discrete signals, deterministic and stochastic signal analysis methods. Analog and digital filtering.

Recommended background: ECE 2311, ECE 2312, or equivalent.

This course will be offered in 2020-21, and in alternating years thereafter.

BME/ECE 4023. BIOMEDICAL INSTRUMENTATION DESIGN.*Cat. I*

This course builds on the fundamental knowledge of instrumentation and sensors. Lectures cover the principles of designing, building and testing analog instruments to measure and process biomedical signals. The course is intended for students interested in the design and development of electronic bioinstrumentation. Emphasis is placed on developing the student's ability to design a simple medical device to perform real-time physiological measurements.

Recommended background: BME 3012, BME 3013, ECE 2010 or ECE 2019.

BME 4201. BIOMEDICAL IMAGING.*Cat. II*

This course provides an understanding of fundamental principles of various biomedical imaging modalities as well as computational image analysis. Topics include: light microscopy, computed tomography, magnetic resonance imaging, computational image analysis, and review of computer vision theory and the relevant principles of physics. Course work uses examples from light microscopy, computed tomography, X-ray radiography, and magnetic resonance imaging. Familiarity with a high-level programming language is recommended.

This course will be offered in 2020-21, and in alternating years thereafter.

BME 4300. MQP CAPSTONE DESIGN.*Cat. I (1/6 unit)*

This course guides students through the engineering design process during the first term of their MQP to aid them in fulfilling their capstone design requirement. The course focuses on developing a revised client statement based on the objectives, constraints, and functions of the design. Methods for concept generation, concept selection and development strategy will be covered. In addition, project planning tools, business plans, ethics, and design for manufacturability and sustainability will be covered.

Recommended background: Principles of engineering design such as BME 3300 or equivalent. Course should be taken concurrently with the MQP. Students who have taken BME 430X may not get credit for BME 4300. BME 4300 cannot be used to fulfill graduate degree requirements.

BME/ME 4504. BIOMECHANICS.*Cat. I*

This course emphasizes the applications of mechanics to describe the material properties of living tissues. It is concerned with the description and measurements of these properties as related to their physiological functions. Emphasis on the interrelationship between biomechanics and physiology in medicine, surgery, body injury and prostheses.

Topics covered include: Review of basic mechanics, stress, strain, constitutive equations and the field equations, viscoelastic behavior, and models of material behavior. The measurement and characterization of properties of tendons, skin, muscles and bone. Biomechanics as related to body injury and the design of prosthetic devices.

Recommended background: Mechanics (ES 2501, ES 2502, ES 2503, ME 3501), Mathematics (MA 2051).

This course will be offered in 2019-20, and in alternating years thereafter.

BME/ME 4606. BIOFLUIDS.*Cat. II*

This course emphasizes the applications of fluid mechanics to biological problems. The course concentrates primarily on the human circulatory and respiratory systems. Topics covered include: blood flow in the heart, arteries, veins and microcirculation and air flow in the lungs and airways. Mass transfer across the walls of these systems is also presented.

Recommended background: ME 3501 and fluid mechanics equivalent to ES 3004.

This course will be offered in 2020-21, and in alternating years thereafter.

BME 4701. CELL AND MOLECULAR BIOENGINEERING.*Cat. I*

This course examines the principles of molecular and cell biology applied to the design of engineered molecules, cells and tissues. Topics will include the basic structural, chemical and physical properties of biomolecules (proteins, lipids, DNA and RNA), application of biomolecules to monitor and alter cellular processes in vitro and in vivo, and design considerations for engineering cell and molecular therapeutics. Case studies will be used to examine specific applications of molecular and cellular bioengineering technologies to treat disease and promote tissue repair and regeneration.

Recommended background: Cell biology (BB 2550). Additional coursework in molecular biology (BB 2950) and/or genetics (BB 2920) would be beneficial.

Students who earned credit for BME 37XX may not receive credit for BME 4701.

BME/ME 4814. BIOMATERIALS.*Cat. I*

A course discusses various aspects pertaining to the selection, processing, testing (in vitro and in vivo) and performance of biomedical materials. The biocompatibility and surgical applicability of metallic, polymeric and ceramic implants and prosthetic devices are discussed. The physico-chemical interactions between the implant material and the physiological environment will be described. The use of biomaterials in maxillofacial, orthopedic, dental, ophthalmic and neuromuscular applications is presented.

Recommended background: BB 3130 or equivalent introduction to Human Anatomy, ES 2001 or equivalent introduction to Materials Science and Engineering.

BME 4828. BIOMATERIALS-TISSUE INTERACTIONS.*Cat. I*

This course examines the principles of materials science and cell biology underlying the design of medical devices, artificial organs and scaffolds for tissue engineering. Molecular and cellular interactions with biomaterials are analyzed in terms of cellular processes such as matrix synthesis, degradation and contraction. Principles of wound healing and tissue remodeling are used to study biological responses to implanted materials and devices. Case studies will be analyzed to compare tissue responses to intact, bioresorbable and bioerodible biomaterials. Additionally, this course will examine criteria for restoring physiological function of tissue and organs and investigate strategies to design implants and prostheses based on control of biomaterial-tissue interactions.

Recommended background: BB 2550 or equivalent, ES 2001 or equivalent, PH 1110 or PH 1111.

BME 4831. DRUG DELIVERY.*Cat. I*

The course examines fundamental composition, structure, property and performance relationships in classical and novel drug delivery systems as part of disease treatment strategies (i.e. cancer, organ damage). Physiological barriers to drug delivery and methods to overcome these barriers are analyzed. The course will familiarize students with biomaterial-based drug delivery systems that have recently been developed. Topics include routes of drug administration, diffusion, Fick's law, pharmacokinetics/pharmacodynamics, drug modifications, materials for drug delivery (implantable, transdermal, injectable), antibody therapeutics, cells as drugs and drug delivery vehicles, and novel drug formulations and delivery systems.

Recommended background: Fundamental knowledge of biomaterials (e.g. BME 2811 or equivalent), multivariable calculus (e.g. MA 1024 or equivalent) and biological system function or cell function (e.g. BB 1035 or BB 2550 or equivalent)

BIOMEDICAL ENGINEERING LAB COURSES**BME 3012. BIOMEDICAL SENSORS LABORATORY.***Cat. I (1/6 unit)*

This laboratory-based course is designed to develop hands-on experimental skills relevant to the selection and application of various sensors used to acquire biomedical signals.

Recommended background: BME 2210, ECE 2010, ECE 2019 or equivalent. Students who have previously taken BME 3011 may not receive credit for this course.

BME 3013. BIOMEDICAL INSTRUMENTATION LABORATORY.*Cat. I (1/6 unit)*

This laboratory-based course is designed to develop hands-on experimental skills relevant to the design and application of analog instrumentation commonly used to acquire biomedical signals.

Recommended background: BME 2210, ECE 2010, ECE 2019 or equivalent. Students who have previously taken BME 3011 may not receive credit for this course.

BME 3014. SIGNAL PROCESSING LABORATORY.*Cat. I (1/6 unit)*

This course is an introduction to the computational methods used to extract and analyze the signals produced by biomedical phenomena. The goal of this course is to familiarize the student with implementing the most common algorithmic approaches for data analysis used in biomedical engineering. Coursework will cover programming for topics such as peak detection, spectral analysis and the fast Fourier transform FFT method, auto-regression analysis, polynomial trend removal, and signal filtering methods.

Recommended background: BME 2211, CS 1004 or equivalent.

BME 3503. SKELETAL BIOMECHANICS LABORATORY.*Cat. I (1/6 unit)*

This laboratory course will help students increase their knowledge of the mechanics of the musculoskeletal system. Students will gain understanding of the course materials and technical skills through the combined hands-on application of state-of-the-art biomechanical testing equipment and computer simulation modules towards solving authentic problems involving balance, strength, and movement.

Recommended background: Statics (ES 2501) and dynamics (ES 2503).

Students who have previously taken BME3504 may not receive credit for this course.

BME 3505. SOLID BIOMECHANICS LABORATORY: TECHNIQUES.*Cat. I (1/6 unit)*

This laboratory-driven solid biomechanics course provides hands-on experience in characterizing the mechanical properties of biological tissues such as bone, tendons, ligaments, skin, and blood vessels and their synthetic analogs. Students gain an in-depth understanding of the course material by performing uniaxial tension and compression, bending, and torsion tests on hard and soft tissues using industry-standard testing equipment and completing mechanical and statistical analysis of the data.

Recommended background: A solid knowledge of mechanics of materials (ES2502) and material science (ES 2001). Students who have previously taken BME3504 may not receive credit for this course.

Some sections of this course may be offered as Writing Intensive (WI).

BME 3506. SOLID BIOMECHANICS LABORATORY: APPLICATIONS.*Cat. I (1/6 unit)*

This laboratory-driven solid biomechanics course provides hands-on experience in characterizing the mechanical properties of biological tissues such as bone, tendons, ligaments, skin, and blood vessels and their synthetic analogs, in the context of an authentic challenge. Students gain an in-depth understanding of the course material from personal observations, measurements, and analysis of biological tissues and synthetic replacement/fixation materials using industry-standard testing equipment. A challenge-based laboratory project will be assigned which will require the students to determine and execute effective test methods at their own pace in a team setting and communicate their findings effectively.

Recommended background: Ability to independently perform tensile and bending tests using a uniaxial mechanical testing machine and to perform mechanical and statistical analysis of test data (BME3505). Students who have previously taken BME3504 may not receive credit for this course.

Some sections of this course may be offered as Writing Intensive (WI).

BME 3605. BIOTRANSPORT LABORATORY.*Cat. I (1/6 unit)*

This laboratory-driven transport course provides hands-on experience in measuring heat, flow, and transport in biologically-relevant systems. Students gain an in-depth understanding of the course material from personal observations and measurements on model cardiovascular systems and connective tissues. Challenge-based laboratory projects will be assigned which will require the students to determine and execute effective test methods at their own pace in a team setting and communicate their findings effectively. Systems modeled may include blood vessels, stenotic vessels, and aneurysms. Connective tissues tested may include blood vessels and skin.

Recommended background: Basic Chemistry (CH 1010, CH 1020), Basic Physics (PH 1010), Material Science (ES 2001 or BME 2811), stress analysis (ES 2502 or BME 2502) and a knowledge of cell biology (BB 2550), or equivalent.

BME 3811. BIOMATERIALS LAB.*Cat. I (1/6 unit)*

This laboratory-driven course provides hands-on experience in the design, fabrication and characterization of biomaterials for medical applications. Students will use synthetic and natural polymer materials to fabricate a scaffold for applications such as tissue engineering, wound healing or controlled drug delivery. A challenge-based laboratory project will be assigned which will require the students to design a biomaterial scaffold that meets specific design criteria, and quantitatively assess the properties of this scaffold to evaluate how well the criteria were met. Design criteria may include mechanical strength, biocompatibility, porosity, degradation rate, or release kinetics. Students will complete the project at their own pace in a team setting and communicate their findings effectively.

Recommended background: Basic chemistry (CH 1010 and CH 1020) and a knowledge of material science (ES 2001) or equivalent.

BME 3813. CELLULAR ENGINEERING LAB.*Cat. I (1/6 unit)*

This laboratory-driven course provides hands-on experience in the application of bioengineering to control cellular processes. Students will be challenged to design an intervention to manipulate a specific cellular process (adhesion, proliferation, migration, differentiation) and use modern cellular and molecular biology tools to assess and refine their approach. Laboratory exercises will provide an overview of cell culture technique, microscopy and molecular probes, quantification of cell proliferation and migration, and assessment of cellular differentiation in the context of the assigned projects. Students will complete the project at their own pace in a team setting and communicate their findings effectively.

Recommended background: Basic chemistry (CH 1010 and CH 1020) and a solid knowledge of cell biology (BB 2550) or equivalent.

BUSINESS, ROBERT A. FOISIE SCHOOL OF

ACCOUNTING (ACC)**ACC 2101. MANAGEMENT ACCOUNTING.***Cat. II*

This course is intended to familiarize the student with the wide variety of ways in which accounting data are used by management as a tool for the attainment of predetermined organizational objectives. The emphasis of the course is on the application of accounting data, rather than on its preparation, and particular attention is given to the use of financial data both in controlling day-to-day activities and planning future operations. Principal topics include: master budgets, cost analysis and classification systems, cost-volume-profit analysis, standard cost accounting and an introduction to capital budgeting.

Recommended background: BUS 2060.

This course will be offered in 2021-22, and in alternating years thereafter.

BUSINESS (BUS)**BUS 1010. LEADERSHIP PRACTICE.***Cat. I*

Leadership is a critical role in any global, technological organization. This course explores how the concepts of creativity, entrepreneurial and critical thinking, emotional and self-awareness, passion, diversity, communication, and ethics inform and affect leadership practice. The course considers a variety of contemporary leadership challenges including how leaders work effectively across cultural, technological, and disciplinary boundaries, how leaders foster new ideas and bring them to fruition, how they communicate effectively and persuasively to diverse stakeholders, and how they make decisions that are both ethical and effective. The course is designed to 1) increase students' awareness of their own leadership styles, 2) examine the responsibilities of leadership, and 3) determine best practices in leadership.

BUS 1020. GLOBAL ENVIRONMENT OF BUSINESS DECISIONS.*Cat. I*

The global nature of business is indisputable. This course introduces the students to the complexity of the global environment and adopts a multi-dimensional view (cultural, economic, social, legal, political, and technological) of world economy. It promotes understanding the global environment as integrative forces affecting the success or failure of today's businesses and fosters a global perspective. Topics may include an overview of the world economy, comparative advantage and international trade, cultural distance, FDI/globalization theory, outsourcing and global supply chain coordination, political and country risk, the global monetary system and currency risk, legal and ethical issues, and risk management.

BUS 2020. THE LEGAL ENVIRONMENT OF BUSINESS DECISIONS.*Cat. I*

This course addresses the impact of law on business. The course covers fundamental areas of business law, such as torts, contracts, intellectual property, and legal forms of business organizations, and their effects on business decisions. Particular attention is paid to technology-based enterprises where global business issues intersect with law.

BUS 2060. FINANCIAL STATEMENTS FOR DECISION MAKING.*Cat. I*

This course provides students with an understanding of the primary financial statements used for internal and external business decision-making in start-up firms and large corporations. It emphasizes underlying accounting concepts captured in financial statements, while highlighting the interdependence among these statements. The course will cover analytical techniques, such as ratio analyses and sensitivity analyses to assess the impact of changes in strategy and outcomes on efficiency and effectiveness measures. It also describes the various users of internal and external financial statements, and the potential conflicts between these various stakeholders.

BUS 2070. RISK ANALYSIS FOR DECISION MAKING.*Cat. I*

Financial and operational risks are omnipresent in small entrepreneurial enterprises and in the corporate world. All firms, large and small, must be able to manage risk to create value. This course introduces students to enterprise risk and prepares them to act in the presence of risk. The course will sensitize students to two significant types of risk (namely, financial and operational risk), provide students with tools for assessing risk and minimizing risk exposure, and prepare students to take risk into account when making decisions as leaders, managers, and individuals.

BUS 2080. DATA ANALYSIS FOR DECISION MAKING.*Cat. I*

This course builds upon students' understanding of statistics and introduces them to the concepts and methods for analyzing data to support business decision-making. Students will explore data sets using data mining and analytics techniques to create business intelligence, to be used for understanding and improving customers' experiences, supply chain operations, product management, etc. During the course, students will develop an understanding of the uses of business data analytics and associated models for business decision-making, forecasting, and obtaining and maintaining a competitive advantage. Students will learn a comprehensive set of advanced spreadsheet skills, including how to design, build, test, and use spreadsheets for analyzing business decisions.

Recommended background: Basic statistics, equivalent to that in MA 2611 and MA 2612.

BUS 3010. CREATING VALUE THROUGH INNOVATION.*Cat. I*

This course focuses on the ways value can be created and captured through innovation. Focusing on the assessment of customers, organizational capabilities, and competition, students will consider a variety of different types of innovations and their associated ethical and financial value propositions. Students will learn analytic tools to successfully assess and commercialize technology, product, and service innovations in a variety of contexts.

BUS 3020. ACHIEVING EFFECTIVE OPERATIONS.*Cat. I*

Operations are embedded in a constantly changing network of relationships with various stakeholders including customers and suppliers. Within the organization, scarce resources (including financial, human, and technological) need to be ethically allocated and aligned with strategic goals. This course focuses on process analysis, design, and implementation within the constraints of stakeholder networks and available resources.

BUS 4030. ACHIEVING STRATEGIC EFFECTIVENESS.*Cat. I*

Every successful business has a strategy for how it provides value and earns profit within its particular industry. Focusing on the contexts of technology, innovation and entrepreneurship, this course develops analytic approaches for assessing the various aspects of strategy such as the competitive environment, the network of stakeholders, ethical implications, investor motivation, operational execution, and financial projections that are necessary to create a complete business plan.

BUS 4300. SENIOR SEMINAR.*Cat. I*

This course is designed for the senior student who wishes to acquire or strengthen important skills needed for organizational success. Among the subjects covered is power in organizations, what it is, and how to acquire and appropriately use it. Additionally, this course emphasizes presentation skills, organizational etiquette, cross-cultural communication, and the knowledge of current events. The student will be expected to be familiar with and use all forms of media information for both individual and group projects. The course may be counted as a 4000-level elective for BU, MGE, or MIS, or as a Free Elective for any student at WPI.

Recommended Background: Senior standing.

ENTREPRENEURSHIP (ETR)**ETR 1100. ENGINEERING INNOVATION AND ENTREPRENEURSHIP.***Cat. I*

In the modern competitive and global world confronting today's engineers, innovation and entrepreneurship (I&E) are increasingly important perspectives for every engineering career. Individuals proficient in I&E are likely to possess unique competitive advantage over those who do not. This course develops the foundation for developing such proficiency by examining the functional roles of the business/commercial aspects of engineering disciplines as well as establishing a basis for innovative thinking. Specific cases where I&E has led to new products innovation and new enterprise development will supplement course materials.

ETR 2900. SOCIAL ENTREPRENEURSHIP.*Cat. I*

This course will introduce students to the concept of social entrepreneurship and the ways in which social entrepreneurs are addressing complex social problems with their entrepreneurial ventures. Students will be exposed to the challenges and rewards of running a social enterprise. They will learn valuable business and entrepreneurial tools that can be applied to the design of sustainable social business models. Topics include social opportunity recognition and evaluation, business models in the social sector, social impact assessment, the double-bottom line, scalability of solutions, organizational forms and structures, and social venture financing.

Suggested background: Familiarity with concepts of creativity, innovation, entrepreneurial and critical thinking, ethics, cross-cultural relations, and social problems (BUS 1010, BUS 1020, BUS 2060 or equivalent).

ETR/ECON 2910. ECONOMICS AND ENTREPRENEURSHIP.*Cat. I*

This course is designed to provide an introduction to economics, an introduction to entrepreneurship, and an understanding of the linkages between economics and entrepreneurship. Students will apply these concepts to the assessment of opportunities that might arise from participation in WPI projects. Students will engage in exploring how economics and entrepreneurship can inform opportunity assessment within an ambiguous and uncertain context. These decisions are always made with incomplete information and there is typically no single correct answer but rather multiple possible answers -- each with pluses and minuses.

Recommended background: None

ETR 3633. ENTREPRENEURIAL SELLING.*Cat. I*

Selling is a major part of business life, but it is especially important for those who are launching a new venture. They need to sell their business plan to potential investors. Later they need to sell their product or service to a customer. Ultimately they need to create an organization that is focused on meeting customer and other stakeholder needs through effective selling disciplines. This course will examine the elements of the sales cycle in terms of preparation, market research, prospecting, objection handling, closing, techniques for motivating the sales professional and formulation of strategy for the successful selling transaction. As part of the course students will be required to prepare individual sales presentations, one to secure investment for a new venture and one to sell a product or service to a customer. Guest speakers may be used on topics such as sales coaching, inside sales management, and to deliver sales effectiveness training.

ETR 3915. ENTREPRENEURIAL BUSINESS MODELS.*Cat. I*

This course is designed to foster an understanding of entrepreneurship in the context of innovation and the global economy. It also provides the theoretical and practical knowledge for the preparation of business models. The course includes opportunity identification, team formation, capital and other resource acquisition, exit strategies and other aspects of new venture creation.

Recommended Background: BUS 2020, BUS 2060, BUS 3010, BUS 3020 and OIE 2850.

ETR 4930. GROWING AND MANAGING NEW VENTURES.*Cat. I*

One of the most troublesome aspects of entrepreneurship is running the business once it is started. This course focuses on techniques to grow the new venture and how to manage both the growth and operations. Considerable emphasis will be placed on expanding existing markets, finding new markets, anticipating the next generation of products, and managing cash flow.

Recommended background for this course consists of five of the following: ACC 2101, BUS 1010, BUS 1020, BUS 2020, BUS 2060, BUS 3010, BUS 3020, BUS 4030, ETR 3915, OIE 2850.

FINANCE (FIN)**FIN 1250. PERSONAL FINANCE.***Cat. I*

This course is designed to help the student make well-informed judgments when faced with personal financial decisions. Such decisions are growing in number and complexity, and both individuals and families need a considerable degree of financial expertise in order to utilize optimally their limited incomes. Principal topics include: insurance (medical, life, automobile and disability), consumer credit, estate planning, taxation, personal investments (real estate, securities, etc.), social security legislation and personal financial planning.

FIN 3300. FINANCE, RISK ANALYTICS & TECHNOLOGY.*Cat. I*

This course provides an in-depth overview of finance, methods in risk analytics, and the importance of financial technology in today's global and interconnected marketplace. In this course, students learn the most up-to-date methods and tools that are used globally within the financial services industry. Topics covered include portfolio formation based on personal and risk preferences, the formation and backtesting of trading strategies, fundamental and technical analysis, the mutual fund and hedge fund industries, and cryptocurrencies. These topics are explored using big data and risk analytics methods such as time series modeling, prediction models, volatility risk forecasting, and the identification and distinction between market-wide and industry-specific risks. Throughout the course, students will learn how to use Bloomberg to analyze data across market sectors to make financial decisions. This course is especially suited to those seeking careers where data analytics and information technologies play critical roles in finance or the management of risks. Topics covered in this course appear regularly in examinations required for professional certifications, such as the Chartered Financial Analyst (CFA) certification. The risk analytics portion of this course also covers topics that appear regularly in the financial mathematics examination by the Society of Actuaries (SOA).

Recommended Background: Introductory business and finance topics such as those found in BUS 2060.

MANAGEMENT INFORMATION SYSTEMS (MIS)**MIS 3720. BUSINESS DATA MANAGEMENT.***Cat. I*

This course introduces students to the theory and practice of database management and the application of database software to implement business information systems that support managerial and operational decision making. Special topics covered include relational data models, query languages, normalization, locking, concurrency control and recovery. The course covers data administration and the design of data tables for computerized databases. Students will use a commercial database package to design and implement a small business database application.

Recommended background: CS 2119 or equivalent knowledge.

MIS 3787. BUSINESS APPLICATIONS OF MACHINE LEARNING.*Cat. I*

This course offers a business focused data analytics introduction. Using cutting-edge tools and approaches to the analysis of data through supervised machine learning, the course teaches how to utilize "big data" for effective decision-making. The course creates data analytics skills through hands-on exposure to data and analytic techniques embedded in Automated Machine Learning tools. Application areas covered include Marketing (pricing and

marketing of luxury shoes), Supply Chain (predicting parts backorders), Finance (predicting safe loans), Talent Management (predicting and explaining attrition), Service Delivery (predicting hospital readmissions), as well as student-centric topics (college grades and starting salaries). This course provides foundations required to successfully apply the machine learning approaches to many of the most common business problems.

MIS 4084. BUSINESS INTELLIGENCE.*Cat. I*

This course provides an introduction to the technologies and techniques for organizing, analyzing, visualizing, and presenting data about business operations in a way that creates business value, and prepares students to be knowledgeable producers and consumers of business intelligence. During the course, students will study a variety of business decisions that can be improved by analyzing large volumes of data about customers, sales, operations, and business performance. Students will employ commercially available business intelligence software to organize, summarize, visualize, and analyze data sets and make recommendations to decision makers based on the results. The course explores the technical challenges of conducting analytics on various forms of data including social media data and the managerial challenges of creating value from business intelligence expertise deployed in organizations. The course includes business cases, in-class discussion, hands-on analyses of business data, and methods for presenting results to decision makers. It is designed for any student interested in analyzing data to support business decision-making, including students whose primary focus is Management Information Systems, Marketing, Operations and Industrial Engineering, Business, Management Engineering, Data Science, or Computer Science.

Recommended background: Previous knowledge in data management, such as that provided by MIS 3720 Business Data Management or CS 3431 Database Systems I.

MIS 4720. SYSTEMS ANALYSIS AND DESIGN.*Cat. I*

This course integrates students' background in MIS in a one-term project focusing on development of creative solutions to open-ended business and manufacturing problems. The project will utilize systems analysis and design tools such as systems development life cycle, feasibility study, cost-benefit analysis, structured analysis and design. Students will acquire the skills necessary to analyze, develop, implement, and document real-life information systems. Students must be able to organize themselves and the project to complete their work within a seven week term. It is recommended that MIS majors take this course in preparation for their MQP.

Recommended background: MIS 3720.

MIS 4741. USER EXPERIENCE AND DESIGN.*Cat. I*

This course focuses on the newest developments in the field of user experience (UX) (e.g., the use of physiological measures such as eye tracking in UX design) and provides an introduction to various methods used in cutting-edge research laboratories to study user experience. Both theoretical concepts and practical skills with appropriate development tools will be addressed within the scope of the class through hands-on projects and assignments. Students will develop a plan to innovate with user experience and will implement a simple prototype of their plan.

Recommended background: BUS 3010, CS 2102 (or CS 2103) or ability to program in a higher level programming language.

MIS 4781. INFORMATION SYSTEMS AND TECHNOLOGY POLICY AND STRATEGY.*Cat. II*

A successful MIS manager must keep up with the fast-paced changes in technology, apply technology when appropriate, and understand the implications technology has on employees and an organization as a whole. S/he must understand both the internal (e.g., political and organizational culture) and external (e.g., laws, global concerns, and cultural issues) environments. The core MIS capabilities of business and information technology (IT) vision, design of IT architecture, and IT service delivery also need to be understood by effective MIS managers.

Recommended background: BUS 3010, MIS 3720 and MIS 4720

This course will be offered in 2021-22, and in alternating years thereafter.

MARKETING (MKT)

MKT 3640. MANAGEMENT OF PROCESS AND PRODUCT INNOVATION.

Cat. I

This course is based on the hypothesis that high performance firms depend on a sustainable pattern of new and innovative processes and products. Successful companies are examined in regard to their strategies for innovation and technology transfer. Technology alliances among industry, universities, and government are considered in order to increase the leverage of the individual firm. Benchmarking and commercialization from research to actualization is discussed through cases and examples.

Recommended background: BUS 2070 or OIE 2850.

MKT 3650. CONSUMER BEHAVIOR.

Cat. I

Knowing how to manage and interact with customers is a key component for business success. Today, customer needs are continuously evolving as well as how products and services are purchased and consumed. Understanding consumer behavior concepts allows firms to investigate consumption habits and make better informed managerial decisions. The goal of this course is to provide an introduction to various theories and dimensions of consumer behavior, such as the consumer decision-making process, the influence of attitude towards the product, brand, and/or firm, and the impact of culture and subculture. Students will be exposed to how these concepts are linked and applied to marketing, to our roles as consumers, and to everyday decisions.

OPERATIONS AND INDUSTRIAL ENGINEERING (OIE)

OIE 2081. INTRODUCTION TO PRESCRIPTIVE ANALYTICS

Cat. I

This course provides an introduction to prescriptive analytics, which involves the application of mathematical and computational sciences, such as linear optimization and simulation, to recommend optimal courses of action for decision making. The course will feature decision problems arising from a variety of contexts such as capacity management, finance, healthcare, humanitarian relief, inventory management, production planning, staffing, and supply chain. The emphasis of the course is the application of such techniques to recommend a best strategy or course of action for the particular context.

Recommended background: Basic statistics, equivalent to that in MA 2611 and MA 2612.

OIE 2850. ENGINEERING ECONOMICS.

Cat. I

To aid all engineering students in understanding economics and business constraints on engineering decision making. Topics include evaluation of alternative; the six time-value-of-money factors; present worth, annual cash flow and rate-of-return analysis; incremental analysis; depreciation and income taxes; replacement analysis; inflation; handling probabilistic events; public economy; break-even and minimum cost points; and foreign exchange.

OIE 3405. WORK SYSTEMS AND FACILITIES PLANNING.

Cat. I

This course covers the fundamentals of developing efficient layouts for production and service facilities. Methods analysis, work measurement, material handling and material flow analysis are also covered. Mathematical models and computer tools are used to assist decision-making.

Recommended background: BUS 3020 and OIE 2081.

OIE 3410. MATERIALS MANAGEMENT IN SUPPLY CHAINS.

Cat. I

This course is an introduction to the planning and controlling the material flow into, through, and out of an organization. It explains fundamental relationships among the activities that occur in the supply chain from suppliers to customers. In particular, the course addresses types of manufacturing systems, demand management and forecasting, master production scheduling, materials requirements planning, capacity management, inventory management, distribution resource planning, JIT and lean principles, and other current topics that are pertinent to managing the material flow of supply chains.

Recommended background: MA 1020, MA 1021, MA 2611 and BUS 3020.

OIE 3420. QUALITY PLANNING, DESIGN AND CONTROL.

Cat. I

This course provides students with the analytical and management tools necessary to solve manufacturing and service quality problems. Topics include customer needs and quality, quality and cost relationships, process capability analysis, statistical process control, control charts for variables and attributes, design of experiments, and other Six Sigma problem solving methodology.

Recommended background: BUS 3020 and MA 2612 or consent of the instructor.

OIE 3460. SIMULATION MODELING AND ANALYSIS.

Cat. I

This course covers the application of simulation to a variety of managerial problems with examples from operations management, industrial engineering and manufacturing engineering. It introduces the student to the concepts of computer simulation, with an emphasis on the design of a simulation experiment and statistical interpretation of its results. It will discuss simulation of queuing models, inventory and industrial dynamics, and gaming situations. The role and use of computers for the execution of simulations will also be highlighted. A commercial simulation language such as Arena will be used to solve problems from the manufacturing and service industries.

Recommended background: CS 1004 and MA 2612.

OIE 3510. STOCHASTIC MODELS.

Cat. I

This is an introductory course in probabilistic models and decision-making under risk, with applications to engineering and management decision making. The course first covers quantitative methods for assessing and evaluating risks and how they are used in decision making. Decision making under risk is examined across a wide set of management and engineering problems. The course then introduces a set of probabilistic models commonly used in decision making and operations improvement; specifically, emphasis is placed on Markov chains, Poisson processes, and queuing theory, and their applications in manufacturing and service systems are illustrated.

Recommended background: Knowledge of calculus and introductory probability and statistics.

OIE 3600. SCRIPTING FOR PROCESS AND PRODUCTIVITY IMPROVEMENT.

Cat. I

This course will train students to think critically about the effective and efficient use of computational tools to enhance everyday organizational performance. Students will learn how to create value through productivity tools that will likely include advanced spreadsheet functionality, regular expressions, macros, and scripting. The course will make use of software including Microsoft Excel with Visual Basic for Applications, Python, and advanced text editors, applied to a variety of domains, to improve students' ability to automate processes and productivity.

Students can receive credits for both OIE 3600 and either CS 2119 or CS 2102 or CS 2103. For IE majors, if one of the CS courses previously listed is used as a required programming course, then OIE 3600 can be used as an IE elective.

Recommended background: some previous exposure to analytical problem solving as found in OIE 2081 or MA 2210.

OIE 4410. CASE STUDIES IN INDUSTRIAL ENGINEERING.

Cat. I

A number of in-depth case studies in operations and industrial engineering are analyzed. The cases will cover both manufacturing and service systems ranging from production system design to operations planning and control.

Recommended background: BUS 3020, OIE 2081, OIE 3410, and OIE 3510.

OIE 4420. PRACTICAL OPTIMIZATION: METHODS AND APPLICATIONS.

Cat. I

This course covers the use of practical computational methods to solve constrained optimization problems from industry. Optimization theory and algorithms related to linear and integer programming will be discussed, with primary emphasis placed upon computationally solving applications in the industrial, operational, manufacturing, and service sectors. Both proprietary and open-source optimization software will be used, including spreadsheet solvers

(e.g., Excel Solver, OpenSolver), industrial-strength optimization packages (e.g., CPLEX, GUROBI), and other interfaces (e.g., MATLAB, AMPL). Students will be expected to model problems and interpret their results; where applicable, sensitivity analysis, duality and additional techniques will be utilized to gain managerial insight from developed models and solutions. Cases from industries such as health care, supply chain management, financial services and analytics will be used for illustrations, discussions, and exercises.

Recommended background: Familiarity with some basic linear programming OIE 2081, MA 2210, MA 3231, or equivalent.

OIE 4460. GLOBAL PLANNING AND LOGISTICS.

Cat. I

This case-based course will examine methods and strategies for managing and controlling material movement, with particular emphasis on international operations, from the purchase of production materials to the control of work in process to the distribution of the finished product. Strategies that will be discussed include the design of international distribution networks, the use of third-party logistics providers, and the creation of links between logistic systems and marketing to create competitive advantage. The course will also explore tactical issues that must be managed to pursue a logistics strategy successfully, including choices regarding means of transportation, packaging, and inventory policies. Underlying themes of the course will be the use of information technologies (such as electronic data interchange and bar coding) and mathematical models to support logistics decision-making.

Recommended background: BUS 3020 and one of the following: BUS 2070 or OIE 2850 or consent of the professor.

ORGANIZATIONAL BEHAVIOR AND CHANGE (OBC)

OBC 3354. ORGANIZATIONAL BEHAVIOR AND CHANGE.

Cat. I

This course focuses on the basic knowledge and processes required of managers to understand behavior in organizations and to apply this knowledge to organizational change. Topics include communication and trust, power and leadership, group and intergroup processes, conflict and conflict management, and work and organizational design. Students apply their knowledge of organizational behavior to the analysis, implementation, and leadership of organizational change. Lectures, video presentations, case studies, group discussions and mini-projects are employed to introduce and illustrate the basic elements of organizational behavior and change.

Recommended background: None.

OBC 4367. LEADERSHIP, ETHICS, AND SOCIAL RESPONSIBILITY.

Cat. I

This upper-level course invites students to consider the importance of ethics, corporate governance, and corporate social responsibility for leading global enterprises effectively. Students will be asked to reflect on their own leadership styles and to engage the complex, ethical dimensions of leadership in modern organizations. The course will engage students using lecture, video presentations, case studies, guest speakers, fieldwork, and mini-projects.

Recommended background: None.

CHEMICAL ENGINEERING

NOTE: Courses listed in previous catalogs with "CM" as the prefix and the same course number as below are considered to be the SAME COURSE.

CHE 1011. INTRODUCTION TO CHEMICAL ENGINEERING.

Cat. I

This course provides an introduction to the broad and vital discipline of chemical engineering including conventional and developing chemical technologies. An introduction is provided to the first principles of chemical engineering, as well as environmental, health, safety and ethical issues in chemical engineering practice. An overview is provided of the chemical engineering profession, career choices, the course of study, and a survey of the chemical industry, e.g., polymer, pharmaceutical, food processing, microelectronic, electrochemical, biotechnology, process control, energy, and petroleum refining. Course activities include guest speakers and plant trips.

Recommended for first-year students with a basic knowledge of chemistry.

CHE 2011. CHEMICAL ENGINEERING FUNDAMENTALS.

Cat. I

This first course in chemical engineering is designed to give students the ability to use techniques and solve problems of interest to chemical engineers. Students will learn fundamental material by completing analysis, design, and/or laboratory projects. Topics covered include: material balances and stoichiometry, pressure, volume, and temperature behavior of pure fluids, 1st law of thermodynamics, vapor-liquid equilibria with ideal thermodynamics, and staged separation processes.

Recommended background: Elementary college chemistry and calculus.

Students may not receive credit towards CHE distribution requirements for both CHE 2011 and CM 2001.

CHE 2012. ELEMENTARY CHEMICAL PROCESSES.

Cat. I

This course aims to build a strong foundation in analysis of chemical processes via a project-based approach. Topics covered include analysis and design of stagewise separation processes such as distillation, 1st and 2nd law (of thermodynamics) analysis of power and refrigeration cycles, and application of material and energy balances in industrial chemical processes, including those with recycle and non-ideal systems.

Recommended background: Elementary college chemistry and calculus and some familiarity with the topics listed in CHE 2011.

Students may not receive credit towards CHE distribution requirements for both CHE 2012 and ES 3000.

CHE 2013. APPLIED CHEMICAL ENGINEERING THERMODYNAMICS.

Cat. I

This course uses a project-based approach to build confidence and competence in the use of chemical engineering thermodynamics for the analysis and design of chemical processes. Topics covered include extractive separation systems, solution thermodynamics and nonreacting multicomponent mixtures, phase equilibria and property changes on mixing.

Recommended background: Elementary college chemistry and calculus and some familiarity with the topics listed in CHE 2011 and CHE 2012.

Students may not receive credit towards CHE distribution requirements for both CHE 2013 and CM 2102.

CHE 2014. ADVANCED CHEMICAL PROCESSES.

Cat. I

This course builds on prior work in material and energy balances, chemical engineering thermodynamics, and stagewise separation processes to facilitate student mastery and design of more complex processes. Topics covered include chemical reaction equilibria, material and energy balances for non-steady state systems, combined material and energy balances, humidification, and batch distillation.

Recommended background: Elementary college chemistry and calculus and some familiarity with the topics listed in CHE 2011, CHE 2012, and CHE 2013.

Students may not receive credit towards CHE distribution requirements for both CHE 2014 and CM 2002.

Some sections of this course may be offered as Writing Intensive (WI).

CHE/ME 2301, NANOBIO TECHNOLOGY LABORATORY EXPERIENCE.

Cat. II

The current developments and experimental skills in nanoscale bioscience and biotechnology will be introduced. Experimental skills such as nanomaterials synthesis, electron microscopy and introductory biotechnology techniques are presented. This course will provide students training in laboratory technique and data handling.

Recommended background: CH 1010 or equivalent.

This course will be offered in 2020-21, and in alternating years thereafter.

CHE 3201. KINETICS AND REACTOR DESIGN.

Cat. I

Techniques for experimentally determining rate laws for simple and complex chemical reactions, the mechanisms and theories of chemical reactions, the function of catalysts, and the design of isothermal, adiabatic, batch and flow reactors. The course is intended to provide chemists and chemical engineers with the conceptual base needed to study reactions and perform in the design and analysis of reactors.

Recommended background: differential equations, thermodynamics and some organic chemistry.

CHE 3301. INTRODUCTION TO BIOLOGICAL ENGINEERING.*Cat. II*

This course is an introduction to the chemical engineering principles involved in modern applications of biological engineering. Topics may include: an introduction to biology, biochemistry, physiology, and genomics; biological process engineering including fermentation, mammalian cell culture, biocatalysis, and downstream bioseparations; drug discovery, development, and delivery; environmental biotechnology; and chemical engineering aspects of biomedical devices.

Recommended background: material and energy balances, thermodynamics, organic chemistry, and differential equations.

This course will be offered in 2019-20, and in alternating years thereafter.

CHE 3501. APPLIED MATHEMATICS IN CHEMICAL ENGINEERING.*Cat. I*

The consolidation of the methods of mathematics into a form that can be used for setting up and solving chemical engineering problems. Mathematical formulation of problems corresponding to specific physical situations such as momentum, energy and mass transfer, and chemical reactions. Analytical and numerical techniques for handling the resulting ordinary and partial differential equations and finite difference equations.

Recommended background: ordinary differential equations, partial derivatives and vectors, momentum heat and mass transfer.

CHE 3702. ENERGY CHALLENGES IN THE 21ST CENTURY.*Cat. II*

The goal of this course is to prepare students for future work in energy-related fields by providing an overview of the challenges related to energy production. Students will study several major energy systems. The details of such energy systems will be examined using engineering principles, particularly focusing on relevant chemical processes. For example, the details and processes of a typical power plant or a refinery will be examined. Students will also become familiar with environmental and economic issues related to energy production. Topics to be covered may include: fossil fuels, the hydrogen economy, biofuels, nuclear energy, fuel cells, batteries, and the electricity grid.

Recommended background: knowledge of chemistry (CH 1010, 1020, 1030), differential and integral calculus, and chemical processes (CHE 2011).

Students may not receive credit for both CHE 3702 and CHE 320X.

This course will be offered in 2019-20, and in alternating years thereafter.

CHE 3722. BIOENERGY.*Cat. II*

The primary goal of this course is to provide students the necessary understanding and tools to evaluate biochemical and thermochemical biofuel production technologies. The secondary goals include developing understanding of 1) fuel properties, 2) biomass resources, 3) basic enzyme kinetics, 4) biochemical reactor design, 5) the corn ethanol process, 6) challenges to cellulosic ethanol, 7) biomass gasification reactions and thermochemistry, 8) gasification reactor design, and 9) techno economic concepts of biofuel processes.

Recommended background: Knowledge of chemistry (CH 1010, 1020, and 1030 or equivalent), differential and integral calculus and differential equations (MA 1021-1024 and 2051 or equivalent), and chemical processing (CHE 2011 or equivalent).

Students may not receive credit for both CHE 372X and CHE 3722.

This course will be offered in 2020-21, and in alternating years thereafter.

CHE/CE 4063. TRANSPORT & TRANSFORMATIONS IN THE ENVIRONMENT.*Cat. II*

In this course, students will learn to make quantitative relationships between human activities and the effects on water, soil, and air in the environment. Students will learn the scientific and engineering principles that are needed to understand how contaminants enter and move in the environment, how compounds react in the environment, how to predict their concentrations in the environment, and how to develop solutions to environmental problems.

Topics to be covered may include water quality engineering (including microbial interactions), air quality engineering, and hazardous waste management.

Recommended Background: familiarity with transport phenomena, such as in ES 3004 (Fluid Mechanics) and ES 3002 (Mass Transfer), and familiarity with reaction kinetics and reactor design, such as through CHE 3201 (Kinetics and Reactor Design). Background such as CE 3059 (Environmental Engineering), CE 3060 (Water Treatment), or CE3061 (Wastewater Treatment) is suggested.

This course will be offered in 2020-21, and in alternating years thereafter.

CHE 4401. UNIT OPERATIONS OF CHEMICAL ENGINEERING I.*Cat. I*

Laboratory-application of fundamental theories to practical chemical engineering operations. Emphasis is on building the student's understanding and ability to approach the problems of design and operations of large scale chemical processing equipment.

The course is a combination of lectures and laboratory projects in the area of unit operations. Laboratory projects include experiments in fluid-flow phenomena through various media such as: friction in conduits, filtration, pressure drop in packed towers, fluidization of solids, and spray drying.

Students are expected to carry out the planning and execution of experimental work as well as the analysis and reporting of experimental results in both written and oral format.

Recommended background: knowledge of chemistry, mathematics and engineering principles.

CHE 4402. UNIT OPERATIONS OF CHEMICAL ENGINEERING II.*Cat. I*

Overall format and procedure are essentially the same as in Unit Operations of Chemical Engineering I.

Laboratory projects include experiments in heat and mass transfer such as: heat transfer in two heaters and a cooler, climbing film evaporation, multiple effect evaporation, absorption, extraction, distillation and rotary drying of solids.

Recommended background: familiarity with techniques and procedures emphasized in CHE 4401.

CHE 4403. CHEMICAL ENGINEERING DESIGN.*Cat. I*

Design of equipment, systems and plants; discussion of factors important in chemical plant design such as: economics, cost estimation, profitability, process selection, materials of construction, process control, plant location and safety. Introduction to optimization and computer-aided design. Principles are illustrated with short industrial-type problems.

Recommended background: thermodynamics; heat, mass and momentum transfer; inorganic and organic chemistry; chemical kinetics and reactor design.

CHE 4404. CHEMICAL PLANT DESIGN PROJECT.*Cat. I*

Application of Chemical Engineering design principles to the design of a major chemical plant. Students work in groups to produce a preliminary practical process flowsheet, equipment and plant design, and economic analysis.

Recommended background: familiarity with techniques and procedures emphasized in CHE 4403.

CHE 4405. CHEMICAL PROCESS DYNAMICS AND CONTROL LABORATORY.*Cat. I*

This course is intended to provide laboratory application of fundamental principles of chemical process dynamics and feedback control. This includes open-loop dynamics of typical chemical engineering processes such as distillation, fluid flow, chemical reactors and heated stirred tanks. Closed-loop experiments will involve control loop design, controller tuning, multivariable, and computer control.

Students will be required to design and execute their own experiments based on supplied objectives. Analysis and presentation of the results will be done through oral and written reports.

Recommended background: knowledge of fluid flow and heat transfer, mathematics and chemical engineering principles.

CHE 4410. CHEMICAL PROCESS SAFETY DESIGN.*Cat. II*

Application of chemical engineering design principles to the design of the process safety and environmental controls of a major chemical plant. Students work in groups to produce a preliminary practical flowsheet, equipment design and controls, and economic analysis, all associated with chemical process safety components within a plant. The course will also include an introduction to modeling of off-site impacts.

Recommended background: familiarity with techniques and procedures of chemical engineering design (CHE 4403), working knowledge of thermodynamics, heat, mass and momentum transfer, inorganic and organic chemistry, chemical kinetics and reactor design.

This course meets the requirements for a core course and a Capstone Design course in chemical engineering. Students may not receive core credit for both CHE 4404 and CHE 4410.

Graduate Chemical Engineering Courses of Interest to Undergraduates

CHE 504. MATHEMATICS ANALYSIS IN CHEMICAL ENGINEERING.

Methods of mathematical analysis selected from such topics as vector analysis, matrices, complex variables, Eigenvalue problems, Fourier analysis, Fourier transforms, Laplace transformation, solution of ordinary and partial differential equations, integral equations, calculus of variations, perturbation and asymptotic methods and numerical analysis. Emphasis on application to the solution of chemical engineering problems.

CHE 506. KINETICS AND CATALYSIS.

Theories of reaction kinetics and heterogeneous catalysis are developed for both simple and complex reactions. The kinetics and mechanisms of both catalyzed and uncatalyzed reactions are explored, as well as the effects of bulk and pore diffusion. Techniques for experimentation, reaction data treatment, and catalyst preparation and characterization are related to developing a sound approach to studying a chemical reaction.

CHE 507. CHEMICAL REACTOR DESIGN.

A review of the design of ideal reactors. Main course topics include: deviations from ideal reactor behavior; transport effects in reacting systems; steady state multiplicity and stability analysis; optimization of reactors; analysis of heterogeneous reactors.

CHE 508. CATALYSIS AND SURFACE SCIENCE OF MATERIALS.

The major factors which distinguished catalytic processes for chemicals and fuels from one another are the structure and composition of the materials used as catalysts.

This course examines the detailed structures and reactivities of solid catalysts like zeolites, solid state inorganics, supported metals and metal-support interactions, carbon catalysts, anchored catalysts and others. Several important spectroscopic techniques used in surface science such as X-ray photoelectron spectroscopy (ESCA), electron microprobe, AUGER, scanning electron microscopy, EXAFS, Mossbauer, Fourier-transform infrared, enhanced laser Raman spectroscopy and photoacoustics spectroscopy will be described for characterization of the catalytic surfaces.

The relationship between the structures and reactivities of important catalysts used in hydrocarbon oxidation and functionalization and syngas reactions will be examined to rationalize how they accomplish specific catalytic transformations.

CHE 510. DYNAMICS OF PARTICULATE SYSTEMS.

Systems of discrete particles which grow in size or some other characteristic variable (e.g., age, molecular weight, etc.) are analyzed. Both reaction engineering and population balance analyses are introduced for batch and continuous systems. Steady state and transient system dynamics are explored.

Depending on class interest, specific topics may include: crystallization, latex synthesis, polymer molecular weight distribution, fermentation/ecological systems and gas-solid systems.

CHE 521. BIOCHEMICAL ENGINEERING.

The course emphasizes the basic concepts of biological systems which are relevant to study by chemical engineers. Topics covered include ligand binding and membrane transport processes; growth kinetics of microorganisms; kinetics of interacting multiple populations; biological reactor design and analysis; soluble and immobilized enzyme kinetics; optimization and control of fermentation; and biological product recovery and separation.

CHE 531. FUEL CELL TECHNOLOGY.

The course provides an overview of the various types of fuel cells followed by a detailed discussion of the proton-exchange membrane (PEM) fuel cell fundamentals: thermodynamics relations including cell equilibrium, standard potentials, and Nernst equation; transport and adsorption in proton-exchange membranes and supported liquid electrolytes; transport in gas-diffusion electrodes; kinetics and catalysis of electrocatalytic reactions including kinetics of elementary reactions, the Butler-Volmer equation, reaction routes and mechanisms; kinetics of overall anode and cathode reactions for hydrogen and direct methanol fuel cells; and overall design and performance characteristics of PEM fuel cells.

CHE/CH 554. MOLECULAR MODELING.

This course trains students in the area of molecular modeling using a variety of quantum mechanical and force field methods. The approach will be toward practical applications, for researchers who want to answer specific questions about molecular geometry, transition states, reaction paths and photoexcited states. No experience in programming is necessary; however, a background at the introductory level in quantum mechanics is highly desirable. Methods to be explored include density functional theory, ab initio methods, semiempirical molecular orbital theory, and visualization software for the graphical display of molecules.

CHE 561. ADVANCED THERMODYNAMICS.

An examination of the fundamental concepts of classical thermodynamics and presentation of existence theorems for the thermodynamic properties with study of relations among them. The inequality of Clausius as a criterion for equilibrium in both chemical and physical systems. Examination of thermodynamic equilibrium for a variety of restraining conditions. Applications to fluid mechanics, process systems and chemical systems. Computation of complex equilibria.

CHE 571. INTERMEDIATE TRANSPORT PHENOMENA.

Mass, momentum and energy transport; analytic and approximate solutions of the equations of change. Special flow problems such as creeping, potential and laminar boundary-layer flows. Heat and mass transfer in multi-component systems. Estimation of heat and mass transfer rates. Transport with chemical reaction.

CHE 573. SEPARATION PROCESSES.

Thermodynamics of equilibrium separation processes such as distillation, absorption, adsorption and extraction. Multi-staged separations. Principles and processes of some of the less common separations.

CHE 574. FLUID MECHANICS.

Advanced treatment of fluid kinematics and dynamics. Stress and strain rate analysis using vectors and tensors as tools. Incompressible and compressible, one-dimensional flows in channels, ducts and nozzles. Nonviscous and viscous flow fields. Boundary layers and turbulence. Flow through porous media such as fixed and fluidized beds. Two-phase flows with drops, bubbles and/or boiling. Introduction to non-Newtonian flows.

CHE 580. SPECIAL TOPICS.

This course will focus on various topics of current interest related to faculty research experience.

CHEMISTRY AND BIOCHEMISTRY

GENERAL CHEMISTRY SEQUENCE

The general chemistry sequence, CH 1010—1040, is a unified sequence of courses in which areas of major importance in chemistry are discussed in depth from both the empirical and theoretical viewpoints. Each of the four courses develops a theme, or core idea, of chemistry. The sequence is designed for biology, science and engineering majors.

The format of each course includes four 1-hour classroom meetings and one 3-hour laboratory meeting per week. For reasons of safety, contact lenses may not be worn in the chemical laboratories. Prescription glasses meeting the ANSI standard Z87.1 will be accepted as affording adequate eye protection in the laboratory. Otherwise, goggles meeting these standards must be worn at all times.

CH 1010. CHEMICAL PROPERTIES, BONDING, AND FORCES.

Cat. I

The CH 1010 course is an introduction to chemistry using the fundamental structures of atoms as a starting point. Emphasis is placed on discussing how all properties of matter as well as bonding mechanisms arise from atomic structure. Lewis structures and molecular orbitals are used to understand bonding, and the intermolecular forces present in chemicals systems are used as a prelude to reactivity patterns covered in future courses.

CH 1020. CHEMICAL REACTIONS.*Cat. I*

Bonding theories introduced earlier in the sequence are applied to chemical reactions, including reduction/oxidation reactions, to demonstrate patterns in reactivity. Solution thermodynamics, concentration scales, and colligative properties are discussed in the context of balanced chemical reactions both in aqueous solution and in the gas phase.

Recommended background: Properties of matter, basic bonding theory, Lewis structures and molecular orbitals, intermolecular forces. See CH 1010.

CH 1030. KINETICS, EQUILIBRIUM AND THERMODYNAMICS.*Cat. I*

This course will examine the dynamic nature of solutions at the molecular level, and will develop an understanding of the mathematical aspects of molecular dynamics and equilibrium. Reaction kinetics will be outlined in detail leading into exploration of various fundamentals and examples of equilibrium processes in the gas phase as well as in solution, including acid-base chemistry and precipitation. Principles of thermodynamics will be introduced (entropy, free energy), and relationships with equilibrium will be explored. Case studies in current topics will be emphasized throughout the course.

Recommended background: Properties of matter, basic bonding theory, Lewis structures and molecular orbitals, intermolecular forces. Redox reactions, solution thermodynamics, colligative properties, balancing of chemical reactions. See CH 1010 and CH 1020.

CH 1040. SPECTROSCOPY IN ORGANIC AND POLYMER CHEMISTRY.*Cat. I*

We will examine the nature of molecular motions and their interaction with electromagnetic radiation, which provides us with all of our structural information about molecules. In addition, students will be introduced to the fundamentals of mass spectrometry and electrochemistry. The concepts of these techniques will be discussed in the context of structural organic chemistry and polymer characterization

Recommended background: Properties of matter, basic bonding theory, Lewis structures and molecular orbitals, intermolecular forces. Redox reactions, solution thermodynamics, colligative properties, balancing of chemical reactions. Reaction kinetics, equilibrium processes, acid-base chemistry and principles of thermodynamics (entropy, free energy). See CH 1010, CH 1020 and CH 1030.

ORGANIC CHEMISTRY COURSES

CH 2310. ORGANIC CHEMISTRY I.*Cat. I*

A systematic survey of the major reaction types and functional groups in organic chemistry. The course will provide a representative collection of characteristic reactions and transformations of a variety of types of organic molecules. Most of the examples will be drawn from aliphatic chemistry. Some theoretical models will be introduced with a view toward establishing a general overview of the material.

The course is intended for chemists, chemical engineers, pre-medical students and all those interested in the biosciences. A familiarity with the material presented in the general chemistry courses is assumed.

CH 2320. ORGANIC CHEMISTRY II.*Cat. I*

Modern theories of aromaticity, including a general assessment of delocalized bonding. The chemistry of some significant functional groups not surveyed in Organic Chemistry I, and the meaning of acidity and basicity in organic chemistry, will be more fully explored. The course will provide an introduction to the systematic synthesis of polyfunctional organic compounds.

Recommended background: CH 2310. The course is intended for chemists, chemical engineers and bio-science majors.

CH 2330. ORGANIC CHEMISTRY III.*Cat. I*

This course fully explores three most important analytical methods in organic chemistry: infrared spectroscopy, mass spectrometry, and nuclear magnetic resonance spectroscopy. It will continue the coverage of aromatic chemistry. New topics to be introduced include structures, properties, and reactivities of aldehydes and ketones, carboxylic acids and their derivatives, amines, and the interaction among polyfunctional compounds. It reinforces the retrosynthetic

analysis and multistep synthesis of organic compounds and revisits reaction mechanisms and stereochemistry of all the new functional groups studied.

Recommended background: CH 2310 and CH 2320. The course is intended for biochemists, chemists, chemical engineers and bioscience majors.

CH 2360. ORGANIC LABORATORY.*Cat. I*

Laboratory experience in standard methods for the preparation and purification of organic compounds. The course will provide sufficient training in laboratory technique so that no previous laboratory experience beyond that of general chemistry is required. This course may be taken concurrently or following lecture courses in organic chemistry. Recommended for pre-medical students and students majoring in disciplines outside of chemistry and biochemistry that desire laboratory experience in basic methods of organic synthesis.

Recommended background: Fundamentals of chemistry, basic chemistry laboratory techniques (e.g., basic synthesis, spectral analysis and chemical separation skills).

CH 3310. ADVANCED ORGANIC CHEMISTRY.*Cat. II*

This course will review and further develop concepts introduced in CH 2310, CH 2320, and CH 2330. These concepts will include oxidation states of organic compounds, acidity and basicity, and stereochemistry and conformational analysis. Chemical reactivity will be emphasized and will include functional group interconversion and ionic and free radical carbon-carbon bond formation.

Recommended background: CH 2310, CH 2320, and CH 2330. This course is intended for students planning to take advanced courses in organic and/or medicinal chemistry and for chemists, biochemists, chemical engineers, and bio-science majors who desire a stronger background in organic chemistry.

This course will be offered in 2020-21, and in alternating years thereafter.

EXPERIMENTAL CHEMISTRY SEQUENCE

The following four courses provide a full-year laboratory program. The purpose of this sequence is to train students in the most essential laboratory techniques, procedures and instrumentation of experimental chemistry. It aims to develop the skills needed for effective work on future chemical laboratory projects such as the Major Qualifying Project. The work of the year develops sequentially.

CH 2640. EXPERIMENTAL CHEMISTRY I: INSTRUMENTAL ANALYSIS.*Cat. I*

This laboratory course focuses on the application of modern instrumental methods of analysis to chemical, biochemical and environmental problems. Practical experience is gained in quantitative electrochemistry, ultraviolet-visible spectrophotometry, fluorometry and bioluminescence, high performance liquid chromatography, and capillary electrophoresis. Principles of experimental design and execution are developed as student teams select a chemical, biochemical or environmental problem, formulate an approach, conduct the analysis, and present findings to the class. Methods of data analysis and common statistical approaches are emphasized throughout the course.

Recommended background: CH 1010, CH 1020, CH 1030, CH 1040.

CH 2650. MODERN PHYSICAL CHEMISTRY METHODS.*Cat. I*

This laboratory course emphasizes principles, techniques, and instrumentation employed in modern physical chemistry with a view towards applications throughout the molecular sciences. Investigations include chemical thermodynamics and phase equilibria; gas-phase, solution-phase, and interfacial reaction kinetics and dynamics; and molecular modeling of small molecules. Emphasis includes data collection, interpretation, error analysis, and write-up.

Recommended background: Fundamentals in chemistry (see CH 1010 – CH 1040), knowledge in thermodynamics (see CH 3510).

CH 2660. ORGANIC SYNTHESIS AND ANALYSIS LABORATORY.*Cat. I*

The emphasis in CH 2660 is on fundamental techniques essential for the synthesis, purification, and characterization of organic compounds. These techniques include setting up, running and monitoring reactions, isolation and purification by solvent extraction, crystallization, distillation, and chromatographic techniques, followed by determination of physical properties and characterization by infrared (IR) and nuclear magnetic resonance (NMR) spectroscopy. Micro-synthetic methods and multi-step synthesis are introduced. This course differs from CH 2360 by providing in-depth experience with spectroscopic characterization of molecular structure and hands-on training operating core instruments in addition to methods of organic synthesis. This course is required for students majoring in chemistry, and is recommended for students majoring in biochemistry and disciplines outside of chemistry that desire a strong background in methods of organic synthesis and characterization.

Recommended background: Fundamentals of chemistry (see CH 1010, CH 1020, CH 1030) and chemical characterization techniques (see CH 1040), basic chemistry laboratory techniques (e.g., basic chemical synthesis, spectral analysis and chemical separation skills).

CH 2670. INVESTIGATION OF COORDINATION COMPLEXES THROUGH INQUIRY.*Cat. I*

The synthesis, isolation, and characterization of inorganic compounds are emphasized. Syntheses of main group compounds, classical transition metal complexes, and organotransition metal compounds are included. In addition to reinforcing and building on standard techniques of synthesis and characterization, several new techniques are introduced: synthesis under inert atmosphere, measurement of magnetic susceptibility by NMR, and cyclic voltammetry. Some exposure to ^{13}C NMR is also provided. The final experiment of the course requires the student to design a synthesis for a compound selected from a list provided, based on strategies learned in the course.

Recommended background: Principles of inorganic chemistry, chemical bonding and reactions, thermodynamic stability of inorganic species, solubility and precipitation of inorganic compounds. Advanced chemistry laboratory skills (see CH 2660)

INORGANIC AND PHYSICAL CHEMISTRY COURSES**CH 3410. STRUCTURE, BONDING, AND REACTIVITY IN INORGANIC CHEMISTRY.***Cat. I*

This course provides the fundamental understanding of atomic, molecular and solid state structures and properties. Orbital structures of atoms, symmetry of molecules and point groups are used to understand chemical bonding and reactions. Various acid-base concepts are explored to analyze the acidity of cations and basicity of anions, solubility and precipitations of inorganic compounds, and metal-ligand binding affinities. Redox properties are discussed using Pourbaix diagrams. Thermodynamic stabilities of inorganic species are discussed using acid-base and redox concepts and thermochemical analyses are used to analyze chemical reactivity at atomic, molecular, and solid state level.

Recommended background: Firm understanding of general chemistry topics (CH 1010 – CH 1030)

CH 3510. CHEMICAL THERMODYNAMICS.*Cat. I*

The content of this course will be the development of the principles of classical thermodynamics. The laws of thermodynamics will be developed by using a series of increasingly complex model systems and a universal equation of state is formulated which incorporates the relationships illustrated by these model systems. Using this equation it will be possible to appreciate that thermodynamic laws are applicable to all systems of matter, regardless of their complexity. Finally, the principles developed are applied to problems of a chemical nature, focusing on predicting the spontaneity of chemical reactions.

The material in this course will be of greatest interest to those students enrolled in the basic sciences including biology, chemistry, and physics, and in applied fields such as chemical engineering, materials science and biotechnology.

Recommended background: Students should be familiar with the material covered in the general chemistry sequence CH 1010-1040, and calculus including multi variables.

CH 3530. QUANTUM CHEMISTRY.*Cat. I*

An introduction to quantum mechanics with applications to atomic and molecular species. The course will be developed systematically beginning with the postulates of quantum mechanics. The Schroedinger equation will be applied to systems such as the particle in a box, the rigid rotor, the harmonic oscillator and the hydrogen atom. Emphasis will be given to a quantum mechanical description of multielectron atoms, molecular bonding and spectroscopy.

Recommended background: a solid foundation in elementary physics and calculus.

This course is normally for students in their third year.

CH 3550. CHEMICAL DYNAMICS.*Cat. I*

This course deals in a general way with the interactions between energy and molecules, and considers how energetic and structural considerations affect the outcome of molecular interactions. The manipulation of kinetic data and results is stressed. Selected topics from both organic and inorganic chemistry are analyzed in terms of reaction thermodynamics, rates and mechanisms.

Students are expected to be familiar with thermodynamics, equilibria, reaction rates and the Periodic Table of the elements.

The following three courses, CH 4110, CH 4120, and CH 4130, are a three-term sequence intended to provide a strong emphasis in biochemistry. As background for this sequence, CH 1010, CH 1020, CH 1030, CH 1040, CH 2310, CH 2320, and CH 2330, or their equivalents, are recommended.

BIOCHEMISTRY COURSES**CH 4110. PROTEIN STRUCTURE AND FUNCTION.***Cat. I*

The fundamental concepts of protein architecture and dynamics are presented with an emphasis on the functional outcomes of chemistry coordinated in three dimensional space. Catalytic mechanics and enzyme function are outlined in detail. Current methods in the determination of enzyme structure and function will be discussed, and students will use common tools in macromolecular analysis and structural modeling. Case studies in enzyme dysfunction, disease, and current research will be used throughout the course.

Recommended background: Familiarity with organic chemistry topics including functional groups, nucleophilic addition and substitution reactions, stereochemistry, and carbonyl chemistry. General knowledge of cellular architecture is also recommended. See CH 2310, CH 2320, CH 2330, and BB 2550 or equivalent.

CH 4120. LIPIDS AND BIOMEMBRANE FUNCTIONS.*Cat. I*

Oriented around biological membranes, this course begins with a description of lipids and proteins forming biomembranes. Permeability and the mechanism of transmembrane mass transport are presented. Transport of electrons and redox equivalents is explained within the context of aerobic production of ATP and plant photosynthesis. Finally the transport of information across biomembranes in signal transduction and neurotransmission are discussed.

Recommended background: Knowledge of organic chemistry fundamentals as well as concepts including protein structure and folding, catalytic mechanics, enzyme kinetics, and ATP synthesis and hydrolysis mechanisms. See CH 2310, BB 2550, and CH 4110 or equivalent.

CH 4130. NUCLEIC ACIDS AND BIOINFORMATION.*Cat. I*

This course presents the structure and function of DNA. Precursors and biomolecules that give rise to DNA, the mechanism of DNA replication, RNA synthesis, and protein synthesis are described in detail. In addition to mechanistic studies, regulation of these processes is covered as well as those of genetic mutation, DNA repair, and epigenetics.

Recommended background: Knowledge of organic chemistry fundamentals as well as concepts including protein structure and folding, catalytic mechanics, enzyme kinetics, and ATP synthesis and hydrolysis mechanisms. See CH 2310, CH 2320, CH 2330, BB 2550, and CH 4110 or equivalent.

CH 4140. METABOLISM AND DISEASE.*Cat. I*

This course presents a thorough analysis of the most relevant metabolic processes in cells. The catabolism of sugars and lipids will be presented in the context of energy generation and storage. Nucleotide and amino acid metabolism will be discussed as building blocks for large biomolecules. Throughout the course the links between metabolism, hereditary pathologies, as well as risk of metabolic imbalances such as diabetes and obesity will be presented.

Recommended background: Familiarity with organic chemistry topics including functional groups, nucleophilic addition and substitution reactions, stereochemistry, and carbonyl chemistry. General knowledge of cellular architecture is also recommended. See CH 2310, CH 2320, CH 2330, and BB 2550 or equivalent.

Specific concepts that we will discuss are: Glucose and glycogen metabolism; Gluconeogenesis; Citric Acid Cycle; Lipid, amino acid and nucleotide metabolisms; Mammalian Fuel Metabolism: Integration and Regulation.

CH 4150. ENZYMOLOGY AND PROTEIN CHARACTERIZATION LABORATORY.*Cat. I*

The experiments in this laboratory course have been designed to acquaint the students with the basic skills necessary to perform biochemical studies. The course will cover, for instance, protein purification, subcellular fractionation, enzyme kinetics (K_m , V_{max} , specific activity, effector-protein interaction, etc.), exclusion and ion exchange chromatography, and electrophoresis.

Recommended background: Knowledge of organic chemistry fundamentals as well as concepts including protein structure and folding, catalytic mechanics, enzyme kinetics, and ATP synthesis and hydrolysis mechanisms. See CH 2310, BB 2550, and CH 4110 or equivalent.

CH 4160. MEMBRANE BIOPHYSICS.*Cat. II*

This course will focus on different areas of biophysics with special emphasis on membrane phenomena. The biomedical-biological importance of biophysical phenomena will be stressed. The course will begin with the introduction of the molecular forces relevant in biological media and subsequently develop the following topics: Membrane Structure and Function; Channels, Carriers and Pumps; Nerve Excitation and related topics; and Molecular Biophysics of Motility.

Recommended background: prior knowledge of Biochemistry (CH 4110, CH 4120), Mechanics (PH 1110) and Electricity (PH 1120).

This course will be offered in 2019-20, and in alternating years thereafter.

CH/BB 4170. EXPERIMENTAL GENETIC ENGINEERING.*Cat. I*

This laboratory course focuses on modern DNA technologies and general applications of gene manipulation. Topics include gene amplification and recombination, promoter and plasmid engineering, gene expression and analysis, model systems, CRISPR, genomics and transgenics. Experiments in this course are integrated into an overall genetic engineering project throughout the term that will involve techniques such as electrophoresis, quantitative spectrofluorimetry, and real-time quantitative PCR. Methods of data analysis, common statistical approaches and technical writing will be emphasized throughout the course.

Recommended background: Knowledge of organic chemistry fundamentals as well as biochemical concepts including DNA replication and recombination, RNA synthesis and protein synthesis. Familiarity with cellular architecture is also recommended. See CH 2310, BB 2550, BB 4010 and CH 4110 or equivalent.

CH/BB 4190. REGULATION OF GENE EXPRESSION.*Cat. I*

Through lectures, problem sets, reading and discussion, and presentations this course will help elucidate for students the processes that allow regulated gene expression, mechanisms used in each type of regulation, and methods and techniques used for investigation of regulatory mechanisms. Readings from the current original research literature will explore the growing use of model systems and "omics" level approaches to enhance our ever expanding understanding of the gene regulatory mechanisms. The development of cell-based therapeutics and genetic engineering as they relate to gene regulation will be introduced.

Recommended background: a working knowledge of concepts in biochemistry and molecular genetics (CH 4110, 4120, 4130 and BB 4010 or equivalent)

ADVANCED CHEMISTRY COURSES**CH 4330. ORGANIC SYNTHESIS.***Cat. II*

Modern synthetic methods as applied to the construction of societally relevant target molecules will be the focus of this course. Discussions may emphasize the logic and strategy in synthetic approaches toward active pharmaceutical ingredients, agrochemicals, fine chemicals, materials, and other targets of interest. The analysis of current examples from the primary literature will draw attention to the most state-of-the-art synthetic tactics.

Recommended for graduate students and undergraduates who have a basic understanding of the principles governing organic reactions, such as those covered in CH2310, CH2320, and CH2330.

This course will be offered in 2020-21 and alternate years thereafter.

CH 4420. APPLICATION OF MOLECULAR ORBITAL THEORY TO METAL COMPLEXES.*Cat. I*

Complexes of the transition metals are discussed. Covered are the electronic structures of transition metal atoms and ions, and the topological and electronic structures of their complexes. Symmetry concepts are developed early in the course and used throughout to simplify treatments of electronic structure. The molecular orbital approach to bonding is emphasized. The pivotal area of organotransition metal chemistry is introduced, with focus on complexes of carbon monoxide, metal-metal interactions in clusters, and catalysis by metal complexes. Recommended background: CH 1010 - CH 1040, CH 2640 - CH 2670, CH 3410, CH 3530, and CH 3550.

Recommended background: Fundamental understanding of atomic, molecular and solid state structures and properties. Thermodynamic stabilities of inorganic species. Acidity, solubility and precipitation of inorganic compounds (see CH 3410).

CH 4520. CHEMICAL STATISTICAL MECHANICS.*Cat. II*

This course deals with how the electronic, translational, rotational and vibrational energy levels of individual molecules, or of macromolecular systems, are statistically related to the energy, entropy, and free energy of macroscopic systems, taking into account the quantum mechanical properties of the component particles. Ensembles, partition functions, and Boltzmann, Fermi-Dirac, and Bose-Einstein statistics are used. A wealth of physical chemical phenomena, including material related to solids, liquids, gases, spectroscopy and chemical reactions are made understandable by the concepts learned in this course.

Recommended background: CH 3510 and CH 3530, or equivalent, and mathematics through differential and integral calculus.

This course will be offered in 2019-20, and in alternating years thereafter.

Graduate Chemistry Courses of Interest to Undergraduates**CH 516. CHEMICAL SPECTROSCOPY.**

Advanced topics in identification of organic species and determination of molecular structure by spectroscopic methods.

Methods covered include ^1H - and ^{13}C -NMR, mass spectrometry and infrared and UV-visible spectroscopy. This course is concerned only with interpretation of spectra and does not cover techniques obtaining them; there is no laboratory.

CH 536. THEORY AND APPLICATIONS OF NMR SPECTROSCOPY.

This course emphasizes the fundamental aspects of 1D and 2D nuclear magnetic resonance spectroscopy (NMR). The theory of pulsed Fourier transform NMR is presented through the use of vector diagrams. A conceptual nonmathematical approach is employed in discussion of NMR theory. The course is geared toward an audience which seeks an understanding of NMR theory and an appreciation of the practical applications of NMR in chemical analysis. Students are exposed to hands-on NMR operation. Detailed instructions are provided and each student is expected to carry out his or her own NMR experiments on a Bruker AVANCE 400 MHz NMR spectrometer.

CH 538. MEDICINAL CHEMISTRY.

This course will focus on the medicinal chemistry aspects of drug discovery from an industrial pharmaceutical Research and Development perspective. Topics will include Chemotherapeutic Agents (such as antibacterial, antiviral and antitumor agents) and Pharmacodynamic Agents (such as antihypertensive, antiallergic, antiulcer and CNS agents).

Recommended background: CH 2310, CH 2320, and CH 2330.

CH/CHE 554. MOLECULAR MODELING.

This course trains students in the area of molecular modeling using a variety of quantum mechanical and force field methods. The approach will be toward practical applications, for researchers who want to answer specific questions about molecular geometry, transition states, reaction paths and photoexcited states. No experience in programming is necessary; however, a background at the introductory level in quantum mechanics is highly desirable. Methods to be explored include density functional theory, ab initio methods, semiempirical molecular orbital theory, and visualization software for the graphical display of molecules.

CH 555. ADVANCED TOPICS.

A course of advanced study in selected areas whose content and format to suit the interest and needs of faculty and students.

CIVIL AND ENVIRONMENTAL ENGINEERING

CE 1030. CIVIL ENGINEERING AND COMPUTER FUNDAMENTALS.

Cat. I

This course introduces students to basic fundamentals of civil engineering, group dynamics, oral presentation skills, engineering report writing techniques, and uses of the computer. Basics of structural engineering, geotechnical engineering, environmental engineering, surveying, materials, and construction engineering and management are presented in this course through a collaborative group teaching approach. Background is provided to gain competence in operating systems, editors, and spreadsheets. Student groups complete weekly computer laboratory projects and develop oral presentations and written reports.

No previous computer use skills are required or assumed. This course is recommended for freshman or sophomore students.

CE 2000. ANALYTICAL MECHANICS I.

Cat. I

This fundamental civil engineering course provides an introduction to the analysis of structures in static equilibrium. The focus of this course is a classical analysis of concurrent and non-concurrent equilibrium. A variety of engineering problems including trusses, machines, beams, rigid frames, and hydraulic structures involving concentrated and distributed loading systems are analyzed for external reactions and internal forces.

CE 2001. ANALYTICAL MECHANICS II.

Cat. I

This course provides an introduction to the relationship between analysis, design, and the behavior of materials under load. Theory and applications are developed that utilize simple and combined stress-strain behavior of members subjected to axial, torsional, and flexural loadings, with applications to beams, trusses, rigid frames, shafts, and tension and compression structures.

Recommended background: CE 2000.

CE 2002. INTRODUCTION TO ANALYSIS AND DESIGN.

Cat. I

This course develops an understanding of classical and modern structural analysis. Topics include loading systems, and the analysis of statically determinate and statically indeterminate beams, frames, trusses, structural floor systems for buildings, bridges, and other structural assemblies.

Recommended background: CE 2000 and CE 2001.

Suggested background: CE 1030.

CE 2020. SURVEYING.

Cat. I

This course develops fundamental skills in the theoretical and practical aspects of plane surveying through the use and care of modern instruments and the associated computations. Topics include the classification of errors incurred in observed field data and necessary correction applications, the use and care of surveying equipment, traversing, differential leveling, stadia and mapping, and electronic data transfer. Computer applications are used where appropriate.

CE 3006. DESIGN OF STEEL STRUCTURES.

Cat. I

This course covers the theory and practice of structural steel design. The structural design process for beams, columns, trusses, frames, and connections is based on Load and Resistance Factor Design (LRFD) specifications of the American Institute of Steel Construction.

Recommended background: CE 2002 and CE 3010.

Suggested background: CE 1030.

CE 3008. DESIGN OF REINFORCED CONCRETE STRUCTURES.

Cat. I

This course covers the theory and practice of reinforced concrete design. The structural design process for beams, columns, slabs, frames, flat slabs, footings, and retaining walls uses the ultimate strength design codes of the American Concrete Institute.

Recommended background: CE 2002 and CE 3010.

Suggested background: CE 1030.

CE 3010. STRUCTURAL ENGINEERING.

Cat. I

This course provides an understanding of the practice of structural engineering. It builds upon the fundamental skills developed in CE 2000, CE 2001, and CE 2002 to present the principles of structures and their elements. The course provides a perspective for dealing with the issues of strength, stiffness, and stability. Although wood is the principle material used to develop the study of the interrelationship between analysis and design of structural systems, structural steel and reinforced concrete systems are also discussed. It also introduces students to the use of building codes for design criteria. The role of the structural engineer in the design process and cost factors are also discussed.

Recommended background: CE 2000, CE 2001, and CE 2002.

Suggested background: CE 1030.

CE 3020. PROJECT MANAGEMENT.

Cat. I

This course presents the fundamental concepts and process of project management applied to public and private works. The principle focus of the course is the management of civil engineering projects including planning, scheduling, organization and control, as well as management concepts of leadership, motivation, trust, project team development, division of work, and conflict resolution. Ancillary engineering and construction practices involving financial practices, construction documents, contract negotiation and administration, quality and safety control, insurance and bonding are covered.

Recommended background: CE 1030.

CE 3022. LEGAL ASPECTS OF PROFESSIONAL PRACTICE.

Cat. I

The course focuses on the legal underpinnings that regulate the design and execution of construction projects and the relations between their participants. The subject is presented according to the various phases of a construction project, from inception to handover. The overall objective is to develop an awareness of the legal aspects that regulate the exercise of the architectural and civil engineering profession and of the environmental constraints of construction. Topics such as permitting process, design/engineering services and ethical issues are included.

Some sections of this course may be offered as Writing Intensive (WI)

CE 3024. CONTROL SURVEYING.

Cat. II

This course presents the principles and field procedures required in the design of vertical and horizontal control networks for large building and construction projects.

Recommended background: CE 2020.

This course will be offered in 2020-21, and in alternating years thereafter.

CE 3025. PROJECT EVALUATION.

Cat. I

In this course students are provided with a systematic framework for evaluating the economic sustainability and financial aspects of a building investment through its life cycle: project definition, design, construction and operation. The course develops according to several interrelated topics: budgeting (square foot cost and parametric estimating) and economic feasibility analysis, financing mechanisms, cash flow analysis, (time-value -of -money factors, present worth and rate of return), life-cycle assessment (environmental impact analysis), taxes, depreciation and regulations as well as consideration of risks and uncertainties.

Recommended background: AREN 2023.

This course will be offered in 2020-21, and in alternating years thereafter.

CE 3026. MATERIALS OF CONSTRUCTION.*Cat. I*

This course provides an understanding of the use and acquisition of engineering properties of construction materials. Topics include relationships between the structure of materials, their engineering properties, and the selection of suitable materials for applications involving strength, durability, and serviceability. Experimental laboratory procedures including design of experiments, data collection, analysis, and representation, and report writing are an integral part of the work.

Recommended background: CE 1030 and CE 2001.

Some sections of this course may be offered as Writing Intensive (WI).

CE 3030. FUNDAMENTALS OF CIVIL ENGINEERING AUTOCAD.*Cat. I*

This course introduces Civil Engineering students to fundamental uses of the AutoCAD software package. Basic two dimensional drawing techniques are covered. Advanced topics that may be covered include three dimensional drawing, rendering and animation. Students are required to become familiar with AutoCAD.

Knowledge of the subject matter in at least two civil engineering design courses is expected background for this course.

CE 3031. BUILDING INFORMATION MODELING: SOFTWARE TOOLS AND PRINCIPLES.*Cat. I*

This course introduces students to fundamental software applications for design and construction planning throughout the different phases of the development of civil engineering projects in a collaborative fashion as established by the principles of Building Information Modeling. The course covers the principles of basic 3D software environments, object creation and manipulation, assemblies of objects, surface and terrain modeling, building modeling, geographic and building information databases. Emphasis is given to the adaptability of this software to changes in design and to the production of graphic design documentation. Application software such as AutoCAD Civil 3D, Autodesk Revit and Navisworks are used in this course. Recommended background: CE 1030 or AREN 3001 or equivalent.

CE 3041. SOIL MECHANICS.*Cat. I*

This is an introductory course dealing with the science and technology of earth materials with an emphasis on fundamental concepts of particulate mechanics. The topics which are discussed include fluid flow through porous media, deformation and shear characteristics of soil, consolidation, lateral earth pressure, and slope stability.

Recommended background: CE 2000 and CE 2001.

Suggested background: GE 2341.

CE 3044. FOUNDATION ENGINEERING.*Cat. I*

Foundation engineering is a study of the applications of the principles of soil mechanics and structural theory to the analysis, design and construction of foundations for engineering works with the emphasis on the soil engineering aspects of soil structure interaction. Subsurface exploration techniques, design of rigid and flexible retaining structures, and design of, shallow and deep foundations are considered. Although the course deals mainly with aspects of the design of buildings and bridges, certain parts of the course (design of temporary trench bracing, for example) are very relevant to construction engineering.

Recommended background: CE 3041.

Suggested background: CE 3008.

CE 3050. TRANSPORTATION: TRAFFIC ENGINEERING.*Cat. I*

This course provides an introduction to the field of transportation engineering with particular emphasis on traffic engineering. Topics covered include a description of the transportation industry and transportation modes; characteristics of drivers, pedestrians, vehicles and the roadway; traffic engineering studies, highway safety, principles of traffic flow, intersection design and control, capacity analysis, and level of service analysis.

Suggested background: CE 2020.

CE 3051. TRANSPORTATION: PAVEMENT ENGINEERING.*Cat. I*

This course provides an introduction to concepts required for design construction and management of pavements. Topics include Highway Drainage, Soil

Engineering for Highway Design, Bituminous Materials, Design of Flexible and Rigid Pavements and Pavement Management. Knowledge of the subject matter in CE 3050 is helpful but not required.

CE 3059. ENVIRONMENTAL ENGINEERING*Cat. I*

This course provides an introduction to engineering aspects of environmental quality control. Students will learn fundamental science and engineering principles needed for environmental engineering, including concepts in chemistry, biology, physics, mass conservation, kinetics and reactor design. These principles are then applied to environmental engineering problems, including modeling of pollutants in natural systems and design of unit processes in engineered systems. Topics covered include environmental regulations, surface and ground water quality, drinking water treatment, wastewater treatment, air pollution, and hazardous waste management.

Recommended background: college-level chemistry.

CE 3060. WATER TREATMENT.*Cat. I*

This course provides in-depth coverage of processes used in water treatment. Topics include: review of water chemistry and drinking water standards, impurities in natural waters, aeration, water softening coagulation, flocculation, sedimentation, filtration, disinfection, taste and odor control, corrosion control, and iron and manganese removal.

Recommended background: CE 3059 and ES 3004.

CE 3061. WASTE WATER TREATMENT.*Cat. I*

This course provides in-depth coverage of processes used in wastewater treatment. Topics include: review of water quality standards, wastewater characteristics, application of biochemical oxygen demand, sources and effects of pollution, physical, chemical, and biological wastewater treatment processes, and waste sludge management.

Recommended background: CE 3059 and ES 3004.

CE 3062. HYDRAULICS.*Cat. I*

This course provides a background for applying the principles of fluid mechanics to analyze and design hydraulic and fluid flow systems for projects related to water resources and civil and environmental engineering. Topics include hydraulics in pipes and closed systems, open channels and rivers, water supply systems and water distribution networks, pump systems and turbines, wastewater collection and treatment systems, and coastal and other natural environmental systems. Course content includes water quality and energy considerations, as well as the development and application of hydraulic models.

Recommended background: ES 3004.

CE 3070. URBAN AND ENVIRONMENTAL PLANNING.*Cat. I*

This course introduces to the student the social, economic, political, and environmental factors that affect the complex relationship between the built and natural environment. By using the principles of sustainable development and the procedures of planning, the optimal development pattern may be examined, and the infrastructure (roads, water supply systems, waste-water treatment systems, shopping malls, etc.) necessary to support present and future growth patterns may be determined. The information necessary in planning, which involves conscious procedures of analysis, formulation of alternative solutions, rational assessment and deliberate choice in accordance with evaluation criteria, is obtained through extensive reading. As such, the course introduces a variety of topics of concern to engineers and environmental scientists. The course is intended not only for civil engineering majors, but also for students preparing for an IQP in areas of urban or environmental concerns.

Some sections of this course may be offered as Writing Intensive (WI).

CE 3074. ENVIRONMENTAL ANALYSIS.*Cat. I*

This course provides a background in the principles and techniques of assessing areas of natural environment and applying environmental assessments to evaluate the inherent suitability of these areas for sustainable urban and resource-based uses. Topic areas include basic concepts in sustainability, landscape characterization and analysis, and environmental impact assessment and planning. The concepts and techniques developed in this course are useful for land use planning, site design, natural resources management, and the determination of the impact of engineering projects on the environment.

Suggested background: CE 3059 or CE 3070.

CE 4007. MATRIX ANALYSIS OF STRUCTURES.*Cat. II*

This course presents the principles of matrix analysis of structural elements and systems; fundamentals of matrix algebra, solution of simultaneous equations, matrix inversion; analysis of plane trusses, method of joints; displacement method, principle of virtual work, analysis of continuous beams, analysis of plane frames, plane trusses, analysis of building frames and bridges; computer aided structural analysis and principles of software development.

Recommended background: CE 2002.

This course will be offered in 2019-20, and in alternating years thereafter.

CE 4017. PRESTRESSED CONCRETE DESIGN.*Cat. II*

This course covers analysis and design aspects of prestressed concrete structural elements and systems: principles of prestressing, materials for prestressing, high strength steel, flexural analysis and design methods; allowable stress and strength design methods; design of beams, load balancing, partial prestressing and cracking moment; design for shear, partial loss of prestress; deflections of prestressed concrete and precast construction; connections.

Recommended background: CE 2002 and CE 3026.

Suggested background: CE 3008.

This course will be offered in 2019-20, and in alternating years thereafter.

CE 4054. TRANSPORTATION: INFRASTRUCTURE MATERIALS LABORATORY.*Cat. II*

This laboratory-based course introduces standard laboratory soil and asphalt materials testing procedures, and effect of physical properties on performance of soils and asphalt pavements. The tests which are performed include: grain size analysis, Atterberg limits, specific gravity, permeability, compaction, compression and consolidation, and triaxial shear for soils, and penetration, consensus and source properties of aggregate, compaction, resilient modulus, indirect tensile strength and nondestructive testing of soils and hot mix asphalt. Instruction is provided through lecture, laboratory work and field trip.

Recommended background: CE 3041 and CE 3052.

This course will be offered in 2019-20, and in alternating years thereafter.

CE 4060. ENVIRONMENTAL ENGINEERING LABORATORY.*Cat. I*

This course familiarizes students with the laboratory studies used to obtain the design parameters for water and wastewater treatment systems. The topics include laboratory experiments dealing with physical, chemical, and biological treatment systems.

Recommended background: CE 3060 and CE 3061.

CE 4061. HYDROLOGY.*Cat. II*

This course introduces the concepts and principles governing the distribution and transport of water in the environment, and also provides a background for quantifying hydrologic processes as required for the development of water resources projects. Topics include the hydrologic cycle, precipitation, evaporation and transpiration, infiltration, runoff analysis, streamflow, hydrologic routing, statistics and probability in hydrology, and the quantification of hydrologic processes for water quality protection. The course introduces field techniques and the use of hydrologic models for solving problems in water resources and hydrology.

Recommended background: ES 3004.

This course will be offered in 2020-21, and in alternating years thereafter.

CE/CHE 4063. TRANSPORT & TRANSFORMATIONS IN THE ENVIRONMENT.*Cat. II*

In this course, students will learn to make quantitative relationships between human activities and the effects on water, soil, and air in the environment. Students will learn the scientific and engineering principles that are needed to understand how contaminants enter and move in the environment, how compounds react in the environment, how to predict their concentrations in the environment, and how to develop solutions to environmental problems.

Topics to be covered may include water quality engineering (including microbial interactions), air quality engineering, and hazardous waste management.

Recommended Background: familiarity with transport phenomena, such as in ES 3004 (Fluid Mechanics) and ES 3002 (Mass Transfer), and familiarity with reaction kinetics and reactor design, such as through CHE 3201 (Kinetics and Reactor Design). Background such as CE 3059 (Environmental Engineering),

CE 3060 (Water Treatment), or CE3061 (Wastewater Treatment) is suggested.

This course will be offered in 2020-21, and in alternating years thereafter.

CE 4071. LAND USE DEVELOPMENT AND CONTROLS.*Cat. I*

The purpose of this course is to provide an understanding of the regulatory framework under which land is developed and the built environment is designed. The quality of our environment depends upon the development which is permitted to take place and the controls which direct that development. Through this course, the student will learn the principles, methods, and techniques which a planner or engineer may use to plan and design the highest and best uses and development of land. In particular, the use and limits of zoning, special permits, subdivision control, and other tools with which a developer or planner should be familiar will be examined in detail.

Some sections of this course may be offered as Writing Intensive (WI).

CE 4600. HAZARDOUS AND INDUSTRIAL WASTE MANAGEMENT.*Cat. II*

This course will cover concepts and techniques for handling hazardous and industrial wastes. Regulations governing hazardous waste, water & soil remediation concepts, and the fundamentals of waste treatment processes will be discussed. Instruction will be provided through lectures, fieldtrips, practitioner seminars, and class problem solving sessions.

Recommended background: ES 3004 and CE 3059.

This course will be offered in 2019-20, and in alternating years thereafter.

COMPUTER SCIENCE

CS 1004. INTRODUCTION TO PROGRAMMING FOR NON-MAJORS.*Cat. I*

This course introduces students to the fundamental principles of programming in imperative and scripting languages. Topics include control structures, iterators, functional decomposition, and basic data structures (such as records). Students will be expected to implement, test, and debug programs. Through the use of compelling applications and lab exercises, students will learn how to interface with external data systems and control devices.

Recommended background: none. All Computer Science students and other students wishing to prepare for 3000-level courses in Computer Science should take CS 1101/1102 instead of CS 1004. This course provides sufficient background for CS 2301 Systems Programming for Non-Majors.

CS 1101. INTRODUCTION TO PROGRAM DESIGN.*Cat. I*

This course introduces principles of computation and programming with an emphasis on program design. Topics include the design, implementation, and testing of programs that use a variety of data structures (such as structures, lists, and trees), functions, conditionals, recursion, and higher-order functions. Students will be expected to design simple data models, and implement and debug programs in a functional programming language.

Recommended background: none. Either CS 1101 or CS 1102 provides sufficient background for further courses in the CS department. Undergraduate credit may not be earned for both this course and CS 1102.

CS 1102. ACCELERATED INTRODUCTION TO PROGRAM DESIGN.*Cat. I*

In the first half of the term, this course covers the same functional programming material as CS 1101 at roughly twice the pace. The second half of the term is a preview of selected advanced Computer Science topics, such as the design and implementation of application-specific languages, macros, programming with the HTTP protocol, and continuation-passing style. Students will be expected to complete an open-ended individual programming project.

Recommended background: Substantial prior programming experience (including functions, recursion, and lists, as would be covered in high-school Advanced Placement Computer Science A courses, but not necessarily AP CS Principles courses). Either CS 1101 or CS 1102 provides sufficient background for further courses in the CS department. Undergraduate credit may not be earned for both this course and CS 1101.

CS 2011. INTRODUCTION TO MACHINE ORGANIZATION AND ASSEMBLY LANGUAGE.*Cat. I*

This course introduces students to the structure and behavior of modern digital computers and the way they execute programs. Machine organization topics include the Von Neumann model of execution, functional organization of computer hardware, the memory hierarchy, caching performance, and pipelining. Assembly language topics include representations of numbers in computers, basic instruction sets, addressing modes, stacks and procedures, low-level I/O, and the functions of compilers, assemblers, linkers, and loaders. The course also presents how code and data structures of higher-level languages are mapped into the assembly language and machine representations of a modern processor. Programming projects will be carried out in the C language and the assembly language of a modern processor.

Recommended background: CS 2301 or CS 2303, or a significant knowledge of C/C++.

CS 2022/MA 2201. DISCRETE MATHEMATICS.*Cat. I*

This course serves as an introduction to some of the more important concepts, techniques, and structures of discrete mathematics providing a bridge between computer science and mathematics. Topics include sets, functions and relations, propositional and predicate calculus, mathematical induction, properties of integers, counting techniques, and graph theory. Students will be expected to develop simple proofs for problems drawn primarily from computer science and applied mathematics.

Recommended background: None.

CS 2102. OBJECT-ORIENTED DESIGN CONCEPTS.*Cat. I*

This course introduces students to an object-oriented model of programming. Building from the design methodology covered in CS 1101/CS 1102, this course shows how programs can be decomposed into classes and objects. By emphasizing design, this course shows how to implement small defect-free programs and evaluate design decisions to select an optimal design under specific assumptions. Topics include inheritance, exceptions, interface, design by contract, basic design patterns, and reuse. Students will be expected to design, implement, and debug object-oriented programs composed of multiple classes and over a variety of data structures.

Recommended background: CS 1101 or CS 1102.

CS 2103. ACCELERATED OBJECT-ORIENTED DESIGN CONCEPTS.*Cat. I*

This course covers the data structures and general program-design material from CS2102, but assumes that students have significant prior experience in object-oriented programming. The course covers object-oriented design principles and data structures more deeply and at a faster pace than in CS 2102. Students will be expected to design, implement, test, debug, and critique programs both for correctness and adherence to good object-oriented design principles. The course is designed to strengthen both the design skills and algorithmic thinking of students who already have a foundation in object-oriented programming. Recommended background: CS 1101 or CS 1102 and significant prior experience writing object-oriented programs from scratch. Advanced Placement Computer Science A courses should provide sufficient background; students from AP CS Principles courses or gentler introductions to Java Programming are advised to take CS2102 instead. Students may receive credit for only one of the following three courses: CS 2102, CS 210X, CS 2103.

CS 2119. APPLICATION BUILDING WITH OBJECT-ORIENTED CONCEPTS.*Cat. I*

This course introduces students to an object-oriented model of programming, with an emphasis on the programming approaches useful in creating software applications. Students will be expected to design, implement, and debug object-oriented programs. Topics include inheritance, user interfaces, and database access. This course is for non-CS majors with prior programming experience and an interest in building software applications.

Recommended background: Some programming experience such as found in CS 1101, CS 1102, or CS 1004.

CS 2223. ALGORITHMS.*Cat. I*

Building on a fundamental knowledge of data structures, data abstraction techniques, and mathematical tools, a number of examples of algorithm design and analysis — worst case and average case — will be developed.

Topics include greedy algorithms, divide-and-conquer, dynamic programming, heuristics, and probabilistic algorithms. Problems will be drawn from areas such as sorting, graph theory, and string processing. The influence of the computational model on algorithm design will be discussed.

Students will be expected to perform analysis on a variety of algorithms.

Recommended background: CS 2102 or CS 2103, and CS 2022.

CS 2301. SYSTEMS PROGRAMMING FOR NON-MAJORS.*Cat. I*

This course introduces the C programming language and system programming concepts to non-CS majors who need to program computers in their own fields. The course assumes that students have had previous programming experience. It quickly introduces the major concepts of the C language and covers manual memory management, pointers and basic data structures, the machine stack, and input/output mechanisms. Students will be expected to design, implement, and debug programs in C.

Recommended background: CS 1101, CS 1102, or CS 1004 or previous experience programming a computer.

All Computer Science students and other students wishing to prepare for upper-level courses in Computer Science should take CS 2303 instead of CS 2301. Students who have credit for CS 2303 may not receive subsequent credit for CS 2301.

CS 2303. SYSTEMS PROGRAMMING CONCEPTS.*Cat. I*

This course introduces students to a model of programming where the programming language exposes details of how the hardware stores and executes software. Building from the design concepts covered in CS 2102, this course covers manual memory management, pointers, the machine stack, and input/output mechanisms. The course will involve large-scale programming exercises and will be designed to help students confront issues of safe programming with system-level constructs. The course will cover several tools that assist programmers in these tasks. Students will be expected to design, implement, and debug programs in C++ and C. The course presents the material from CS 2301 at a fast pace and also includes C++ and other advanced topics.

Recommended background: CS 2102, CS 2103, or CS 2119 and/or substantial object-oriented programming experience.

CS 3013. OPERATING SYSTEMS.*Cat. I*

This course provides the student with an understanding of the basic components of a general-purpose operating system. Topics include processes, process management, synchronization, input/output devices and their programming, interrupts, memory management, resource allocation, and an introduction to file systems. Students will be expected to design and implement a large piece of system software in the C programming language.

Undergraduate credit may not be earned both for this course and for CS 502.

Recommended background: CS 2303 or CS 2301, and CS 2011.

CS 3041. HUMAN-COMPUTER INTERACTION.*Cat. I*

This course develops in the student an understanding of the nature and importance of problems concerning the efficiency and effectiveness of human interaction with computer-based systems.

Topics include the design and evaluation of interactive computer systems, basic psychological considerations of interaction, interactive language design, interactive hardware design, and special input/output techniques.

Students will be expected to complete several projects. A project might be a software evaluation, interface development, or an experiment.

Recommended background: CS 2102, CS 2103, or CS 2119.

CS 3043. SOCIAL IMPLICATIONS OF INFORMATION PROCESSING.*Cat. I*

This course makes the student aware of the social, moral, ethical, and philosophical impact of computers and computer-based systems on society, both now and in the future.

Topics include major computer-based applications and their impact, human-machine relationships, and the major problems of controlling the use of computers.

Students will be expected to contribute to classroom discussions and to complete a number of significant writing assignments.

This course is recommended for juniors and seniors.

Recommended background: a general knowledge of computers and computer systems.

CS 3133. FOUNDATIONS OF COMPUTER SCIENCE.*Cat. I*

This course introduces the theoretical foundations of computer science. These form the basis for a more complete understanding of the proficiency in computer science.

Topics include computational models, formal languages, and an introduction to compatibility and complexity theory, including NP-completeness.

Students will be expected to complete a variety of exercises and proofs.

Undergraduate credit may not be earned for both this course and for CS 5003. Recommended Background: Discrete Mathematics (CS 2022 or equivalent), and Algorithms (CS 2223 or equivalent).

Students who have credit for CS 4121 may not receive credit for CS 3133.

CS 3431. DATABASE SYSTEMS I.*Cat. I*

This course introduces the student to the design, use, and application of database management systems.

Topics include the relational data model, relational query languages, design theory, and conceptual data design and modeling for relational database design. Techniques that provide for data independence and minimal redundancy will be discussed.

Students will be expected to design and implement database system applications.

Undergraduate credit may not be earned both for this course and for CS 4431 or CS 542.

Recommended background: CS 2022 and either CS 2102, CS 2103, or CS 2119.

CS 3516. COMPUTER NETWORKS.*Cat. I*

This course provides a broad view of computer networks. The course exposes students to all seven layers of OSI Reference Model while providing an introduction into newer topics such as wireless networking and Internet traffic concerns. The objective is to focus on an understanding of fundamental concepts of modern computer network architecture from a design and performance perspective. Topics covered include physical layer considerations, network protocols, wide area networks, local area networks, wireless networks, switches and routing, congestion, Internet traffic, and network security. Students will be expected to do extensive systems/network programming and will be expected to make use of simulation and measurement tools to gain an appreciation of current network design and performance issues. This course is also highly recommended for RBE and IMGD majors.

Recommended background: CS 2301 or CS 2303, or a significant knowledge of C/C++.

CS 3733. SOFTWARE ENGINEERING.*Cat. I*

This course introduces the fundamental principles of software engineering. Modern software development techniques and life cycles are emphasized.

Topics include requirements analysis and specification, analysis and design, architecture, implementation, testing and quality, configuration management, and project management.

Students will be expected to complete a project that employs techniques from the topics studied.

This course should be taken before any course requiring a large programming project.

Undergraduate credit may not be earned both for this course and for CS 509.

Recommended background: CS 2102, CS 2103, or CS 2119.

CS 4032/MA 3257. NUMERICAL METHODS FOR LINEAR AND NONLINEAR SYSTEMS.*Cat. I*

This course provides an introduction to modern computational methods for linear and nonlinear equations and systems and their applications.

Topics covered include solution of nonlinear scalar equations, direct and iterative algorithms for the solution of systems of linear equations, solution of nonlinear systems, and the eigenvalue problem for matrices. Error analysis will be emphasized throughout.

Recommended background: MA 2071. An ability to write computer programs in a scientific language is assumed.

CS 4033/MA 3457. NUMERICAL METHODS FOR CALCULUS AND DIFFERENTIAL EQUATIONS.*Cat. I*

This course provides an introduction to modern computational methods for differential and integral calculus and differential equations.

Topics covered include interpolation and polynomial approximation,

approximation theory, numerical differentiation and integration, and numerical solutions of ordinary differential equations. Error analysis will be emphasized throughout.

Recommended background: MA 2051. An ability to write computer programs in a scientific language is assumed. Undergraduate credit may not be earned for both this course and for MA 3255/CS 4031.

CS/IMGD 4100. ARTIFICIAL INTELLIGENCE FOR INTERACTIVE MEDIA AND GAMES.*Cat. II*

Algorithms and programming techniques from artificial intelligence (AI) are key contributors to the experience of modern computer games and interactive media, either by directly controlling a non-player character (NPC) or through more subtle manipulation of the environment. This course will focus on the practical AI programming techniques currently used in computer games for NPC navigation and decision-making, along with the design issues that arise when AI is applied in computer games, such as believability and real-time performance. The course will also briefly discuss future directions in applying AI to games and media. Students will be expected to complete significant software development projects using the studied techniques.

Recommended background: object-oriented design concepts (CS 2102 or CS 2103), algorithms (CS 2223), and knowledge of technical game development (IMGD 3000)

This course will be offered in 2019-20, and in alternating years thereafter.

CS 4120. ANALYSIS OF ALGORITHMS.*Cat. II*

This course develops the skill of analyzing the behavior of algorithms.

Topics include the analysis — with respect to average and worst case behavior — and correctness of algorithms for internal sorting, pattern matching on strings, graph algorithms, and methods such as recursion elimination, dynamic programming, and program profiling.

Students will be expected to write and analyze programs.

Undergraduate credit may not be earned both for this course and for CS 5084.

Recommended background: Algorithms (CS 2223 or equivalent), and some knowledge of probability.

This course will be offered in 2020-21, and in alternating years thereafter.

CS 4123. THEORY OF COMPUTATION.*Cat. II*

Building on the theoretical foundations from CS 3133, this course addresses the fundamental question of what it means to be “computable,” including different characterization of computable sets and functions.

Topics include the halting program, the Church-Turing thesis, primitive recursive functions, recursive sets, recursively enumerable sets, NP-completeness, and reducibilities.

Students will be expected to complete a variety of exercises and proofs.

Recommended Background: CS 3133.

This course will be offered in 2019-20, and in alternating years thereafter.

CS 4233. OBJECT-ORIENTED ANALYSIS AND DESIGN.*Cat. II*

This Software Engineering course will focus on the process of Object-Oriented Analysis and Design. Students will be expected to complete a large number of exercises in Domain Modeling, Use Case Analysis, and Object-Oriented Design. In addition, the course will investigate Design Patterns, which are elements of reusable object-oriented software designs. This course will survey a set of design patterns and consider how these patterns are described and used to solve design problems.

Recommended Background: CS 2303 and CS 3733.

This course will be offered in 2020-21, and in alternating years thereafter.

CS 4241. WEBWARE: COMPUTATIONAL TECHNOLOGY FOR NETWORK INFORMATION SYSTEMS.*Cat. I*

This course explores the computational aspects of network information systems as embodied by the World Wide Web (WWW). Topics include languages for document design, programming languages for executable content, scripting languages, design of WWW based human/computer interfaces, client/server network architecture models, high level network protocols (e.g., http), WWW network resource discovery and network security issues.

Students in this course will be expected to complete a substantial software project (e.g., Java based user interface, HTML/CGI based information system, WWW search mechanisms).

Recommended background: CS 2102, CS 2103, or CS 2119; and CS 3013.

CS 4341. INTRODUCTION TO ARTIFICIAL INTELLIGENCE.*Cat. I*

This course studies the problem of making computers act in ways which we call “intelligent”.

Topics include major theories, tools and applications of artificial intelligence; aspects of knowledge representation; searching and planning; and natural language understanding.

Students will be expected to complete projects which express problems that require search in state spaces and to propose appropriate methods for solving the problems.

Undergraduate credit may not be earned both for this course and for CS 534.

Recommended background: CS 2102 or CS 2103; CS 2223; and CS 3133.

CS 4342. MACHINE LEARNING.*Cat. I*

In this course, students will explore both theoretical and practical aspects of machine learning, including algorithms for regression, classification, dimensionality reduction, clustering, and density estimation. Specific topics may include neural networks and deep learning, Bayesian networks and probabilistic graphical models, principal component analysis, k-means clustering, decision trees and random forests, support vector machines, and kernel methods.

Recommended background: Multivariate Calculus (MA 1024 or MA 1034), Linear Algebra (such as MA 2071), Probability (MA 2621 or MA 2631), and Algorithms (CS 2223).

Students may not earn credit for both CS 453X and CS 4342.

Undergraduate credit may not be earned both for this course and for CS 539.

CS 4401. SOFTWARE SECURITY ENGINEERING.*Cat. I*

This course provides an introduction to the pitfalls and practices of building secure software applications. Topics will include threat modeling, secure software development, defensive programming, web security, and the interaction between security and usability. The course focuses on the application level with minor attention to operating-system level security; network-level security is not covered. Assignments involve designing and implementing secure software, evaluating designs and systems for security-related flaws, and presentations on security issues or tools. All students will be required to sign a pledge of responsible conduct at the start of the course.

Recommended Background: CS3013 and CS3733. The course assumes nontrivial experience with C and Unix, familiarity with operating systems, filesystems, and databases, and experience with technologies for building web applications (from CS4241 or personal experience).

CS 4404. TOOLS AND TECHNIQUES IN COMPUTER NETWORK SECURITY.*Cat. II*

This course introduces students to modern network security concepts, tools, and techniques. The course covers security threats, attacks, and mitigations at the operating-system and network levels (as opposed to the software level). Topics include authentication, authorization, confidentiality, integrity, anonymity, privacy, intrusion detection and response, and cryptographic applications. Students will become familiar with modern security protocols and tools. Assignments will involve using security-testing software to uncover vulnerabilities, network packet analyzers, and existing security applications to create secure network implementations. The course requires enough programming and systems background to understand attacks and use systems tools but does not involve significant programming projects. Assignments and projects will use a Linux base for implementation.

Recommended Background: Knowledge of operating systems (CS 3013 or equivalent) and computer networks (CS 3516 or equivalent). Familiarity with Linux or Unix is essential.

CS 4432. DATABASE SYSTEMS II.*Cat. II*

This course concentrates on the study of the internals of database management systems. Topics include principles and theories of physical storage management, advanced query languages, query processing and optimization, index structures for relational databases, transaction processing, concurrency control, distributed databases, and database recovery, security, client server and transaction processing systems. Students may be expected to design and implement software components that make up modern database systems.

Undergraduate credit may not be earned both for this course and CS 542.

Recommended background: CS 3431 and CS 3733.

This course will be offered in 2019-20, and in alternating years thereafter.

CS/DS 4433. BIG DATA MANAGEMENT AND ANALYTICS.*Cat. I*

This course introduces the emerging techniques and infrastructures for big data management and analytics including parallel and distributed database systems, map-reduce, Spark, and NO-SQL infrastructures, data stream processing systems, scalable analytics and mining, and cloud-based computing. Query processing and optimization, access methods, and storage layouts developed on these infrastructures will be covered. Students are expected to engage in hands-on projects using one or more of these technologies.

Recommended background: Knowledge in database systems at the level of CS4432, and programming experience are assumed.

CS 4445. DATA MINING AND KNOWLEDGE DISCOVERY IN DATABASES.*Cat. II*

This course provides an introduction to Knowledge Discovery in Databases (KDD) and Data Mining. KDD deals with data integration techniques and with the discovery, interpretation, and visualization of patterns in large collections of data. Topics covered in this course include data warehousing and mediation techniques; data mining methods such as rule-based learning, decision trees, association rules, and sequence mining; and data visualization. The work discussed originates in the fields of artificial intelligence, machine learning, statistical data analysis, data visualization, databases, and information retrieval. Several scientific and industrial applications of KDD will be studied.

Recommended background: MA 2611, CS 2223, and CS 3431 or CS 3733.

This course will be offered in 2019-20, and in alternating years thereafter.

CS 4513. DISTRIBUTED COMPUTING SYSTEMS.*Cat. II*

This course extends the study of the design and implementation of operating systems begun in CS 3013 to distributed and advanced computer systems.

Topics include principles and theories of resource allocation, file systems, protection schemes, and performance evaluation as they relate to distributed and advanced computer systems.

Students may be expected to design and implement programs that emphasize the concepts of file systems and distributed computing systems using current tools and languages.

Undergraduate credit may not be earned both for this course and for CS 502.

Recommended background: CS 3013, CS 3516, and system programming experience.

This course will be offered in 2019-20, and in alternating years thereafter.

CS 4515. COMPUTER ARCHITECTURE.*Cat. II*

This course explores the architectural design of modern computer systems in terms of instruction sets and the organization of processors, controllers, memories, devices, and communication links. Topics include an overview of computer architectures and system components, theoretical foundations, instruction-level and thread-level pipelining, multifunction pipelines, multi-core systems, caching and memory hierarchies, and multi-core and parallel computer organization. Students may be expected to design and implement programs that simulate significant components of modern computer architectures.

Recommended background: CS 2011 or ECE 2049, and CS 3013.

This course will be offered in 2020-21, and in alternating years thereafter.

CS 4516. ADVANCED COMPUTER NETWORKS.*Cat. II*

This course provides an in-depth look into computer networks. While repeating some of the areas from CS 3516, the goal is to go deeper into computer networks topics. This in-depth treatment in topics such as routing, congestion control, wireless layer protocols, and physical signaling considerations will require the use of basic queuing theory and probability to provide a more formal treatment of computer networks performance. Other topics covered include LAN and WLAN technologies, mobile wireless networks, sensor networks, optical networks, network security, intrusion detection, and network management. Students will be expected to do more sophisticated network programming than seen in CS 3516 and will conduct laboratory activities involving measuring the performance of modern networking applications running on both wired networks and infrastructure wireless networks.

Undergraduate credit may not be earned both for this course and for CS 513.

Recommended background: CS 3013, CS 3516, and knowledge of probability. The course assumes a familiarity with operating systems including Unix or Linux and significant experience with C/C++.

This course will be offered in 2019-20, and in alternating years thereafter.

CS 4518. MOBILE AND UBIQUITOUS COMPUTING.*Cat. II*

The goal of this course is to acquaint students with fundamental concepts and state-of-the-art computer science literature in mobile and ubiquitous computing. Topics to be covered include mobile systems issues, human activity and emotion sensing, location sensing, mobile human-computer interaction, mobile social networking, mobile health, power saving techniques, energy and mobile performance measurement studies, and mobile security.

The course will introduce the programming of mobile devices such as smartphones running the Android operating system.

Recommended background: Proficiency in programming in Java, including classes, inheritance, exceptions, interfaces, and polymorphism (CS 2102 or equivalent).

Students may not earn credit for both CS 403X and CS 4518.

CS 4533. TECHNIQUES OF PROGRAMMING LANGUAGE TRANSLATION.*Cat. II*

This course studies the compiling process for high-level languages.

Topics include lexical analysis, syntax analysis, semantic analysis, symbol tables, intermediate languages, optimization, code generation, and run-time systems.

Students will be expected to use compiler tools to implement the front end — and to write a program to implement the back end — of a compiler for a recursive programming language.

Undergraduate credit may not be earned for both this course and for CS 544.

Recommended Background: CS 2102 or CS 2103, and CS 3133.

This course will be offered in 2020-21, and in alternating years thereafter.

CS 4536. PROGRAMMING LANGUAGES.*Cat. II*

This course covers the design and implementation of programming languages. Topics include data structures for representing programming languages, implementing control structures (such as functions, recursion, and exceptions), garbage collection, and type systems. Students will be expected to implement several small languages using a functional programming language.

Recommended background: CS 2303, CS 3133, and experience programming in a functional language (as provided by CS 1101 or CS 1102).

Undergraduate credit may not be earned for both this course and CS 536.

This course will be offered in 2019-20, and in alternating years thereafter.

CS 4731. COMPUTER GRAPHICS.*Cat. I*

This course studies the use of the computer to model and graphically render two- and three-dimensional structures.

Topics include graphics devices and languages, 2- and 3-D object representations, and various aspects of rendering realistic images.

Students will be expected to implement programs which span all stages of the 3-D graphics pipeline, including clipping, projection, arbitrary viewing, hidden surface removal, and shading.

Undergraduate credit may not be earned both for this course and for CS 543.

Recommended background: CS 2223, CS 2303, and MA 2071.

CS 4732. COMPUTER ANIMATION.*Cat. II*

This course provides an in-depth examination of the algorithms, data structures, and techniques used in modeling and rendering dynamic scenes. Topics include animation hardware and software; parametric blending techniques; modeling physical and articulated objects; forward and inverse kinematics; key-frame, procedural, and behavioral animation; and free-form deformation. Students will be expected to develop programs to implement low-level animation algorithms as well as use commercial animation tools to design and produce small to moderate sized animations.

Recommended background: CS 4731.

This course will be offered in 2020-21, and in alternating years thereafter.

CS 4801/ECE 4802. INTRODUCTION TO CRYPTOGRAPHY AND COMMUNICATION SECURITY.*Cat. I*

This course provides an introduction to modern cryptography and communication security. It focuses on how cryptographic algorithms and protocols work and *how* to use them. The course covers the concepts of block ciphers and message authentication codes, public key encryption, digital signatures, and key establishment, as well as common examples and uses of such schemes, including

the AES, RSA-OAEP, and the Digital Signature Algorithm. Basic cryptanalytic techniques and examples of practical security solutions are explored to understand how to design and evaluate modern security solutions. The course is suited for students interested in cryptography or other security related fields such as trusted computing, network and OS security, or general IT security.

Recommended background: Experience in expressing algorithms in a modern programming language (e.g., ECE 2049 or CS 2301).

Suggested background: Discrete mathematics (CS 2022/MA 2201 or equivalent)

CS 4802/BCB 4002. BIOVISUALIZATION.*Cat. II*

This course will use interactive visualization to model and analyze biological information, structures, and processes. Topics will include the fundamental principles, concepts, and techniques of visualization (both scientific and information visualization) and how visualization can be used to study bioinformatics data at the genomic, cellular, molecular, organism, and population levels. Students will be expected to write small to moderate programs to experiment with different visual mappings and data types.

Recommended background: CS 2102 or CS 2103; CS 2223; and one or more biology courses.

This course will be offered in 2020-21, and in alternating years thereafter.

CS 4803/BCB 4003. BIOLOGICAL AND BIOMEDICAL DATABASE MINING.*Cat. II*

This course will investigate computational techniques for discovering patterns in and across complex biological and biomedical sources including genomic and proteomic databases, clinical databases, digital libraries of scientific articles, and ontologies. Techniques covered will be drawn from several areas including sequence mining, statistical natural language processing and text mining, and data mining.

Recommended Background: CS 2102 or CS 2103; CS 2223; MA 2610 or MA 2611; and one or more biology courses.

This course will be offered in 2019-20, and in alternating years thereafter.

DATA SCIENCE

DS 1010. DATA SCIENCE I: INTRODUCTION TO DATA SCIENCE.*Cat. I*

This course provides an introduction to the core concepts in Data Science. It covers a broad range of methodologies for working with and making informed decisions based on real-world data. Core topics introduced in this course include basic statistics, data exploration, data cleaning, data visualization, business intelligence, and data analysis. Students will utilize various techniques and tools to explore, understand and visualize real-world data sets from various domains and learn how to communicate data results to decision makers.

Recommended background: None

DS 2010. DATA SCIENCE II: MODELING AND DATA ANALYSIS.*Cat. I*

This course focuses on model- and data-driven approaches in Data Science. It covers methods from applied statistics (regression), optimization, and machine learning to analyze and make predictions and inferences from real-world data sets. Topics introduced in this course include basic statistics (regression), analytics (explanatory and predictive), basics of machine learning (classification and clustering), eigen values and singular matrices, data exploration, data cleaning, data visualization, and business intelligence. Students will utilize various techniques and tools to explore and understand real-world data sets from various domains.

Recommended background: Data science basics equivalent to DS 1010, applied statistics and regression equivalent to MA2611 and MA 2612, and the ability to write computer programs in a scientific language equivalent to a CS programming course at the CS 1000 or CS 2000 level are assumed.

DS 3010. DATA SCIENCE III: COMPUTATIONAL DATA INTELLIGENCE.*Cat. I*

This course introduces core methods in Data Science. It covers a broad range of methodologies for working with large and/or high-dimensional data sets to making informed decisions based on real-world data. Core topics introduced in this course include data collection through use cycle, data management of large-scale data, cloud computing, machine learning and deep learning. Students will acquire experience with big data problems through hands-on projects using real-world data sets.

Recommended background: Data science basics equivalent to DS 1010, and data analysis principles and modeling equivalent to DS 2010, knowledge of basic statistics equivalent to (MA 2611 and MA 2612), and the ability to program equivalent to (CS 1004 or CS 1101 or CS 1102) and (CS 2102, CS 2103 or CS 2119), as well as understanding of databases equivalent to (CS 3431 or MIS 3720) are assumed.

DS/CS 4433. BIG DATA MANAGEMENT AND ANALYTICS.*Cat. I*

This course introduces the emerging techniques and infrastructures for big data management and analytics including parallel and distributed database systems, map-reduce, Spark, and NO-SQL infrastructures, data stream processing systems, scalable analytics and mining, and cloud-based computing. Query processing and optimization, access methods, and storage layouts developed on these infrastructures will be covered. Students are expected to engage in hands-on projects using one or more of these technologies.

Recommended background: Knowledge in database systems at the level of CS4432, and programming experience are assumed.

ELECTRICAL AND COMPUTER ENGINEERING

The second digit in electrical engineering course numbers is coded as follows:

- 0 — Circuits
- 1 — Fields
- 2 — Electronic Circuits and Systems
- 3 — Signals and Communication Systems
- 4 — Available for Future Use
- 5 — Machines, Power Systems
- 6 — Professional and Miscellaneous
- 7 — Projects, Laboratory, Independent Study
- 8 — Computers
- 9 — Electronic Devices

NOTE: Courses listed in previous catalogs with “EE” as the prefix and the same course number as below are considered to be the SAME COURSE.

ECE 1799. FRONTIERS AND CURRENT ISSUES OF ELECTRICAL AND COMPUTER ENGINEERING.*Cat. I (1/6 unit semester course, spread out evenly over A and B terms)*

This is a seminar-based course intended for First Year students seeking to understand the breadth of activities, career choices and technology that are considered to comprise Electrical and Computer Engineering. Students considering ECE as a major, both those who are “decided” as well as those who are “undecided” should enroll in ECE 1799. The class meets once a week during the fall semester (A & B terms).

Note: There are no “recommended” or “suggested” courses for this description.

ECE 2010. INTRODUCTION TO ELECTRICAL AND COMPUTER ENGINEERING.*Cat. I*

The objective of this course is to introduce students to the broad field of electrical and computer engineering within the context of real world applications. This course is designed for first-year students who are considering ECE as a possible major or for non-ECE students fulfilling an out-of-major degree requirement.

The course will introduce basic electrical circuit theory as well as analog and digital signal processing methods currently used to solve a variety of engineering design problems in areas such as entertainment and networking media, robotics, renewable energy and biomedical applications. Laboratory experiments based on these applications are used to reinforce basic concepts and develop laboratory skills, as well as to provide system-level understanding. Circuit and system simulation analysis tools are also introduced and emphasized.

Topics: Basic concepts of AC/DC and Digital electrical circuits, power, linear

circuit simulation and analysis, op-amp circuits, transducers, feedback, circuit equivalents and system models, first order transients, the description of sinusoidal signals and system response, analog/digital conversion, basic digital logic gates and combinatorial circuits.

Recommended Background: high school physics, and MA 1022 (concurrent).

ECE 2019. SENSORS, CIRCUITS, AND SYSTEMS.*Cat. I*

This course investigates commonly used sensors such as resistive temperature sensors, capacitive touch sensors, and inductive motion sensors and actuators. Numerous applications are presented to motivate coverage of fundamental operating principles of circuit elements such as resistors, capacitors, and inductors; model the signals produced by these sensors; and analyze the circuits and systems used to amplify and process these signals. After a review of Kirchhoff’s current and voltage laws, fundamental analysis techniques such as Thevenin and Norton’s theorems and the superposition principle are used to model and analyze sensors, circuits, and systems. Concepts from analysis of linear, time-invariant continuous-time signals and systems are introduced as necessary, including Fourier series and characterization of systems such as filters in both the frequency domain (bandwidth, transfer function) and time domain (rise time, step response). Capacitance, inductance and mutual inductance are explored as energy storage elements, including consideration of resonance and energy losses in power systems. Concepts will be reinforced with the use of laboratory exercises and computer simulation.

Recommended background: ECE 2010, MA 1024 (or equivalent), PH 1120/21 and MA 2051 (concurrent).

Note: Students who have received credit for ECE 2111 may not receive credit for ECE 2019.

ECE 2029. INTRODUCTION TO DIGITAL CIRCUIT DESIGN.*Cat. I*

Digital circuits are the foundation upon which the computers, cell phones, and calculators we use every day are built. This course explores these foundations by using modern digital design techniques to design, implement and test digital circuits ranging in complexity from basic logic gates to state machines that perform useful functions like calculations, counting, timing, and a host of other applications. Students will learn modern design techniques, using a hardware description language (HDL) such as Verilog to design, simulate and implement logic systems consisting of basic gates, adders, multiplexers, latches, and counters. The function and operation of programmable logic devices, such as field programmable gate arrays (FPGAs), will be described and discussed in terms of how an HDL logic design is mapped and implemented. Experiments involving the design of combinational and sequential circuits will provide students a hands-on introduction to basic digital electrical engineering concepts and the skills needed to gain more advanced skills. In the laboratory, students will construct, troubleshoot, and test the digital circuits that they have developed using a hardware description language. These custom logic designs will be implemented using FPGAs and validated using test equipment.

Topics: Number representations, Boolean algebra, design and simplification of combinational circuits, arithmetic circuits, analysis and design of sequential circuits, and synchronous state machines.

Lab exercises: Design, analysis and construction of combinational and sequential circuits; use of hardware description languages to implement, test, and verify digital circuits; function and operation of FPGAs.

Recommended background: Introductory Electrical and Computer Engineering concepts covered in a course such as ECE 2010 or RBE 1001, and MA 1022.

Note: Students who have received credit for ECE 2022 may not receive credit for ECE 2029.

ECE 2049. EMBEDDED COMPUTING IN ENGINEERING DESIGN.*Cat. I*

Embedded computers are literally everywhere in modern life. On any given day we interact with and depend on dozens of small computers to make coffee, run cell phones, take pictures, play music play, control elevators, manage the emissions and antilock brakes in our automobile, control a home security system, and so on. Using popular everyday devices as case studies, students in this course are introduced to the unique computing and design challenges posed by embedded systems. Students will then solve real-world design problems using small, resource constrained (time/memory/power) computing platforms. The hardware and software structure of modern embedded devices and basic interactions between embedded computers and the physical world will also be covered in lecture and as part of laboratory experiments. In the laboratory, emphasis is placed on interfacing embedded processors with common sensors and devices (e.g. temperature sensors, keypads, LCD display, SPI ports, pulse

width modulated motor controller outputs) while developing the skills needed to use embedded processors in systems design. This course is also appropriate for RBE and other engineering and CS students interested in learning about embedded system theory and design.

Topics: Number/data representations, embedded system design using C, microprocessor and microcontroller architecture, program development and debugging tools for a small target processor, hardware/software dependencies, use of memory mapped peripherals, design of event driven software, time and resource management, applications case studies.

Lab Exercises: Students will solve commonly encountered embedded processing problems to implement useful systems. Starting with a requirements list students will use the knowledge gained during the lectures to implement solutions to problems which explore topics such as user interfaces and interfacing with the physical world, logic flow, and timing and time constrained programming. Exercises will be performed on microcontroller and/or microprocessor based embedded systems using cross platform development tools appropriate to the target platform.

Recommended Background: ECE 2010 or equivalent knowledge in basic circuits, devices and analysis; and C language programming (CS 2301 or equivalent)

Suggested Background: ECE 2029 or equivalent knowledge of digital logic, logic signals and logic operations;

Note: Students who have received credit for ECE 2801 may not receive credit for ECE 2049.

ECE 2112. ELECTROMAGNETIC FIELDS.

Cat. I

The object of this course is a comprehensive treatment of electromagnetic engineering principles covering the entire application spectrum from static to dynamic field phenomena.

The starting point will be the basic electric and magnetic field definitions of Coulomb and Biot-Savart leading to Gauss's and Ampere's laws. They form the foundation of electro- and magnetostatics fields. Students will examine capacitive and inductive systems and relate them to lumped element circuit models. By introducing temporal and spatial magnetic flux variations, Faraday's law is established. The engineering implications of this law are investigated in terms of transformer and motor actions. Incorporation of the displacement current density into Ampere's law and combining it with Faraday's law will then culminate in the complete set of Maxwell's field equations. As a result of these equations, students will develop the concept of wave propagation in the time and frequency domain with practical applications such as wireless communication, radar, Global Positioning Systems, and microwave circuits.

Recommended background: ECE 2019.

ECE 2201. MICROELECTRONIC CIRCUITS I.

Cat. I

This course is the first of a two-course sequence in electronic circuit design. It begins with a substantive treatment of the fundamental behavior of semiconductor materials and moves on to the semiconductor diode, the bipolar transistor, and the field-effect transistor. Laboratory exercises are provided to reinforce the theory of operation of these devices. Numerous circuit applications are considered, including: power supplies, transistor amplifiers, and FET switches.

Topics include: the pn junction, diode operation, transducers, rectification, voltage regulation, limiting and clamping circuits, transistor operation, biasing, small-signal and large-signal models, transistors amplifiers, and switching applications.

Recommended background: ECE 2019.

ECE 2305. INTRODUCTION TO COMMUNICATIONS AND NETWORKS.

Cat. I

This course provides an introduction to the broad area of communications and networking, providing the context and fundamental knowledge appropriate for all electrical and computer engineers, as well as for further study in this area.

The course is organized as a systems approach to communications and networking. Topics include key concepts and terminology (delay, loss, throughput, bandwidth, etc.), types of transmission media, addressing, switching, routing, networking principles and architectures, networking protocols, regulatory and applications issues.

Recommended background: ECE 2010.

ECE 2311. CONTINUOUS-TIME SIGNAL AND SYSTEM ANALYSIS.

Cat. I

This course provides an introduction to time and frequency domain analysis of continuous time signals and linear systems. Topics include signal characterization and operations; singularity functions; impulse response and convolution; Fourier series; the Fourier transform and its applications; frequency-domain

characterization of linear, time-invariant systems such as filters; and the Laplace transform and its applications.

Recommended background: MA 2051, ECE 2019, and a prior course in computer programming such as CS 2301 or CS 1101/2/4.

ECE 2312. DISCRETE-TIME SIGNAL AND SYSTEM ANALYSIS.

Cat. I

This course provides an introduction to the time and frequency domain analysis of discrete-time signals and linear systems. Topics include sampling and quantization, characterization of discrete-time sequences, the discrete-time Fourier transform, the discrete Fourier transform and its applications, the Z transform and its applications, convolution, characterization of FIR and IIR discrete-time systems, and the analysis and design of discrete-time filters. The course will include a focus on applications such as sampling and quantization, audio processing, navigation systems, and communications. Extensive use will be made of simulation tools including Matlab.

Recommended background: MA 2051, ECE 2311, and a prior course in computer programming such as CS 2301 or CS 1101/2/4.

ECE 2799. ELECTRICAL AND COMPUTER ENGINEERING DESIGN.

Cat. I

The goal of this course is to provide experience with the design of a system, component, or process. Basic sciences, mathematics, and engineering sciences are applied to convert resources to meet a stated objective. Fundamental steps of the design process are practiced, including the establishment of objectives and criteria, synthesis, analysis, manufacturability, testing, and evaluation. Student work in small teams and are encouraged to use creativity to solve specific but open-ended problems, and then present their results.

ECE 2799 is strongly recommended for all students as a preparation for the design element of the MQP. It is anticipated that ECE 2799 will be of most benefit to students when taken well in advance of the MQP (late sophomore year or early junior year).

Recommended background: At least three of ECE 2019, ECE 2029, ECE 2049, ECE 2311.

ECE 3012. INTRODUCTION TO CONTROL SYSTEMS ENGINEERING.

Cat. I

This course provides an introduction to the analysis and design of continuous-time control systems. Topics covered in the course include: modeling in the frequency and time domain, characteristics of control systems time response, reduction of multiple subsystems, analysis of systems transient response, stability, steady-state errors, root locus techniques, design of PI, PD, and PID controllers via root locus, frequency response techniques, and design via frequency response. The course will not have a formal laboratory. It will include projects which will require the use of software such as MATLAB, Simulink, or LabVIEW for analysis and design of control systems.

Recommended Background: Ordinary Differential Equations (MA 2051), Sensors, Circuits, and Systems (ECE 2019), and Continuous-time Signal and System Analysis (ECE 2311).

Students may not receive credit for both ES 3011 and ECE 3012.

ECE 3113. INTRODUCTION TO RF CIRCUIT DESIGN.

Cat. I

This course is designed to provide students with the basic principles of radio frequency (RF) circuit design. It concentrates on topics such as designing tuning and matching networks for analog and digital communication, satellite navigation, and radar systems.

After reviewing equivalent circuit representations for RF diodes, transistors, FETs, and their input/output impedance behavior, the course examines the difference between lumped and distributed parameter systems. Characteristics impedance, standing waves, reflection coefficients, insertion loss, and group delay of RF circuits will be explained.

Within the context of Maxwell's theory the course will then focus on the graphical display of the reflection coefficient (Smith Chart) and its importance in designing matching circuits. Students will learn the difference between SPICE and monolithic and microwave integrated circuit analysis, and design (MMICAD) modeling. Biasing and matching networks for single and multistage amplifiers in the 900 to 2,000 MHz range are analyzed and optimized in terms of input/output impedance matching, insertion loss, and groups delays.

Recommended background: ECE 2019, ECE 3204.

Suggested background: ECE 2112.

ECE 3204. MICROELECTRONIC CIRCUITS II.*Cat. I*

This course is the second of a two-course sequence in electronic circuit design. More complex circuits are analyzed and the effects of frequency and feedback are considered in detail. The course provides a comprehensive treatment of operational amplifier operation and limitations. The use of Bode plots to describe the amplitude and phase performance of circuits as a function of operating frequency is also presented. In addition, the concepts of analog signal sampling, analog-to-digital conversion and digital-to-analog conversion are presented along with techniques for interfacing analog and digital circuitry. Laboratory exercises are provided to reinforce student facility with the application of these concepts to the design of practical circuits.

Topics include: transducers; differential amplifiers, inverting/non-inverting amplifiers, summers, differentiators, integrators, passive and active filters, the Schmitt trigger, monostable and a-stable oscillators, timers, sample-and-hold circuits, A/D converters, and D/A converters.

Recommended background: Introductory electronic-circuit design and analog-signal analysis as found in ECE 2201 and ECE 2311.

ECE 3308. INTRODUCTION TO WIRELESS NETWORKS.*Cat. I*

This course is intended for students interested in obtaining a systems-level perspective of modern wireless networks. It starts with an overall understanding of telecommunication and computer communication networks. Then the fundamental theory of operation of wireless networks as well detailed description of example networks will be covered. Topics included in the course are an overview of computer networks, an overview of wireless network standards and products, radio channel modeling and medium access control, deployment of wireless infrastructures, and examples of voice- and data-oriented wireless networks using TDMA, CDMA, and CSMA access methods.

With extra work, this course can be successfully completed by non-ECE students; basic concepts of radio propagation, transmission, and medium access control will be introduced as needed.

Recommended background: MA 1022 and PH 1120.

Suggested background: ECE 2312 and ECE 2305.

ECE 3311. PRINCIPLES OF COMMUNICATION SYSTEMS.*Cat. I*

This course provides an introduction to analog and digital communications systems. The bandpass transmission of analog data is motivated and typical systems are analyzed with respect to bandwidth considerations and implementation techniques. Baseband and passband digital transmission systems are introduced and investigated. Pulse shaping and intersymbol interference criteria are developed in relation to the pulse rate transmission limits of bandlimited channels. Finally, digital carrier systems and line coding are introduced in conjunction with applications to modern modem transmission schemes.

Recommended background: MA 1024 and ECE 2312.

Suggested background: ECE 2305.

ECE 3500. INTRODUCTION TO CONTEMPORARY ELECTRIC POWER SYSTEMS.*Cat. I*

This course introduces basic concepts underlying the current and future methods of generation, transmission, storage, and use of electric energy. Beginning with an historical overview of the electric power system that has served well for more than 100 years, the course provides an introduction to the fundamental engineering principles underlying the design and implementation of traditional as well as modern electric power systems. Energy sources including thermal (combustion, nuclear, geothermal), solar, wind, and chemical (fuel cells) are presented, along with the environmental impacts. Concepts of three-phase systems, transmission and distribution of power, economic and regulatory aspects, as well as communications, protection, and control systems are included. Student project work is included.

Recommended background: ECE 2010 or equivalent

Suggested background: ECE 2019 or equivalent

ECE 3501. ELECTRICAL ENERGY CONVERSION.*Cat. I*

This course is designed to provide a cohesive presentation of the principles of electric energy conversion for industrial applications and design. The generation, transmission and conversion of electric energy, as well as basic instrumentation and equipment associated with electric energy flow and conversion are analyzed.

Topics: Review of poly-phase circuits. Transducers and instrumentation for power and energy measurements. Rotating machines. Electromechanical transients and stability. Switchgear equipment. Selected laboratory experiments.

Recommended background: ECE 2019.

ECE 3503. POWER ELECTRONICS.*Cat. I*

This course is an introduction to analysis and design of power semiconductor circuits used in electric motor drives, control systems, robotics and power supply.

Topics: characteristics of thyristors and power transistors. Steady-state performance and operating characteristics, device rating and protection, commutation, gating circuits, ac voltage controllers, controlled rectifiers, dc/dc converters and dc/ac inverters. Laboratory exercises.

Recommended background: ECE 2019, ECE 2201 or equivalent.

ECE 3829. ADVANCED DIGITAL SYSTEM DESIGN WITH FPGAs.*Cat. I*

This course covers the systematic design of advanced digital systems using FPGAs. The emphasis is on top-down design starting with high level models using a hardware description language (such as VHDL or Verilog) as a tool for the design, synthesis, modeling, test bench development, and testing and verification of complete digital systems. These types of systems include the use of embedded soft core processors as well as lower level modules created from custom logic or imported IP blocks. Interfaces will be developed to access devices external to the FPGA such as memory or peripheral communication devices. The integration of tools and design methodologies will be addressed through a discussion of system on a chip (SOC) integration, methodologies, design for performance, and design for test.

Topics: Hardware description languages, system modeling, synthesis, simulation and testing of digital circuits; Design integration to achieve specific system design goals including architecture, planning and integration, and testing; Use of soft core and IP modules to meet specific architecture and design goals. Laboratory exercises: Students will design and implement a complete sophisticated embedded digital system on an FPGA. HDL design of digital systems including lower level components and integration of higher level IP cores, simulating the design with test benches, and synthesizing and implementing these designs with FPGA development boards including interfacing to external devices.

Recommended background: ECE 2029 and ECE 2049

Students who have received credit for ECE 3810 may not receive credit for ECE 3829.

ECE 3849. REAL-TIME EMBEDDED SYSTEMS.*Cat. I*

This course continues the embedded systems sequence by expanding on the topics of real-time software and embedded microprocessor system architecture. The software portion of this course focuses on solving real-world problems that require an embedded system to meet strict real-time constraints with limited resources. On the hardware side, this course reviews and expands upon all the major components of an embedded microprocessor system, including the CPU, buses, memory devices and peripheral interfaces. New IO standards and devices are introduced and emphasized as needed to meet system design, IO and performance goals in both the lecture and laboratory portion of the course. Topics: Cross-compiled software development, embedded system debugging, multitasking, real-time scheduling, inter-task communication, software design for deterministic execution time, software performance analysis and optimization, device drivers, CPU architecture and organization, bus interface, memory management unit, memory devices, memory controllers, peripheral interfaces, interrupts and interrupt controllers, direct memory access. Laboratory exercises: Programming real-time applications on an embedded platform running a real-time operating system (RTOS), configuring hardware interfaces to memory and peripherals, bus timing analysis, device drivers.

Recommended background: ECE 2029 and ECE 2049.

ECE/BME 4011. BIOMEDICAL SIGNAL ANALYSIS.*Cat. II*

Introduction to biomedical signal processing and analysis. Fundamental techniques to analyze and process signals that originate from biological sources: ECGs, EMGs, EEGs, blood pressure signals, etc. Course integrates physiological knowledge with the information useful for physiologic investigation and medical diagnosis and processing. Biomedical signal characterization, time domain analysis techniques (transfer functions, convolution, auto- and cross-correlation), frequency domain (Fourier analysis), continuous and discrete signals, deterministic and stochastic signal analysis methods. Analog and digital filtering.

Recommended background: ECE 2311, ECE 2312, or equivalent.

This course will be offered in 2020-21, and in alternating years thereafter.

ECE/BME 4023. BIOMEDICAL INSTRUMENTATION DESIGN.*Cat. II*

This course builds on the fundamental knowledge of instrumentation and sensors. Lectures cover the principles of designing, building and testing analog instruments to measure and process biomedical signals. The course is intended for students interested in the design and development of electronic bioinstrumentation. Emphasis is placed on developing the student's ability to design a simple medical device to perform real-time physiological measurements.

Recommended background: BME 3012, BME 3013, ECE 2010 and ECE 2019.

This course will be offered in 2020-21, and in alternating years thereafter.

ECE 4305. SOFTWARE-DEFINED RADIO SYSTEMS AND ANALYSIS.*Cat. I*

This course provides students with hands-on exposure to the design and implementation of modern digital communication systems using software-defined radio technology. The prototyping and real-time experimentation of these systems via software-defined radio will enable greater flexibility in the assessment of design trade-offs as well as the illustration of "real world" operational behavior. Performance comparisons with quantitative analytical techniques will be conducted in order to reinforce digital communication system design concepts. In addition to laboratory modules, a final course project will synthesize topics covered in class. Course topics include software-defined radio architectures and implementations, digital signaling and data transmission analysis in noise, digital receiver structures (matched filtering, correlation), multicarrier communication techniques, radio frequency spectrum sensing and identification (energy detection, matched filtering), and fundamentals of radio resource management.

Recommended background: ECE 3311, MA 2621, familiarity with Simulink, familiarity with general programming.

ECE 4703. REAL-TIME DIGITAL SIGNAL PROCESSING.*Cat. I*

This course provides an introduction to the principles of real-time digital signal processing (DSP). The focus of this course is hands-on development of real-time signal processing algorithms using audio-based DSP kits in a laboratory environment. Basic concepts of DSP systems including sampling and quantization of continuous time signals are discussed. Tradeoffs between fixed-point and floating-point processing are exposed. Real-time considerations are discussed and efficient programming techniques leveraging the pipelined and parallel processing architecture of modern DSPs are developed. Using the audio-based DSP kits, students will implement real-time algorithms for various filtering structures and compare experimental results to theoretical predictions.

Recommended background: ECE 2049, ECE 2312, some prior experience in C programming.

Suggested background: ECE 3311.

ECE 4801. COMPUTER ORGANIZATION AND DESIGN.*Cat. I*

This course focuses on the computer organization and architectural design of standalone embedded and high-performance microprocessor systems. This course covers performance metrics, machine level representation of information, the assembly level interface, memory system organization and architecture, computer input/output, instruction set architecture (ISA) design, single cycle and multicycle CPU datapath and controlpath design as well as more advanced level topics such as pipelining, interrupts, cache and memory system design. Special attention will be paid into measuring architectural performance and into improving computer architectures at various levels of the design hierarchy to reach optimal performance. The course will include several hands-on projects and laboratory components where students will be required to perform simulations of CPU designs using architectural simulation tools such as MIPS Simulators and SimpleScalar.

Recommended Background: ECE 3849

Suggested Background: ECE 3829

ECE 4802/CS 4801. INTRODUCTION TO CRYPTOGRAPHY AND COMMUNICATION SECURITY.*Cat. I*

This course provides an introduction to modern cryptography and communication security. It focuses on how cryptographic algorithms and protocols work and how to use them. The course covers the concepts of block ciphers and message authentication codes, public key encryption, digital signatures, and key establishment, as well as common examples and uses of such schemes, including the AES, RSA-OAEP, and the Digital Signature Algorithm. Basic cryptanalytic techniques and examples of practical security solutions are explored to

understand how to design and evaluate modern security solutions. The course is suited for students interested in cryptography or other security related fields such as trusted computing, network and OS security, or general IT security.

Recommended background: ECE 2049 Embedded Computing in Engineering Design or CS 2301 Systems Programming for Non-Majors or equivalent

Suggested background: CS 2022/MA 2201 Discrete Mathematics

ECE 4902. ANALOG INTEGRATED CIRCUIT DESIGN.*Cat. II*

This course introduces students to the design and analysis of analog integrated circuits such as operational amplifiers, phase-locked loops, and analog multipliers. Topics: integrated circuit building blocks: current mirrors and sources, differential amplifiers, voltage references and multipliers, output circuits. Computer-aided simulation of circuits. Layout of integrated circuits. Design and analysis of such circuits as operational amplifiers, phase-locked loops, FM detectors, and analog multipliers. Laboratory exercises.

Recommended background: familiarity with the analysis of linear circuits and with the theory of bipolar and MOSFET transistors. Such skills are typically acquired in ECE 3204.

Suggested background: ECE 4904.

This course will be offered in 2019-20, and in alternating years thereafter.

ECE 4904. SEMICONDUCTOR DEVICES.*Cat. II*

The purpose of this course is to introduce students to the physics of semiconductor devices and to show how semiconductor devices operate in typical linear and nonlinear circuit applications. This material complements the electronics sequence of courses and will draw illustrative examples of electronic circuit applications from other courses. Topics: carrier transport processes in semiconductor materials. Carrier lifetime. Theory of p-n junctions. Bipolar transistors internal theory, dc characteristics, charge control, Ebers-Moll relations; high frequency and switching characteristics, hybrid- π model; n- and p-channel MOSFETS, CMOS.

Recommended background: ECE 2201. Suggested background: ECE 3204 (helpful but not necessary).

Students who have received credit for ECE 3901 may not receive credit for ECE 4904.

This course will be offered in 2020-21, and in alternating years thereafter.

ENGINEERING SCIENCE INTERDISCIPLINARY

ES 1020. INTRODUCTION TO ENGINEERING.*Cat. I*

This course is for first year students with an interest in engineering. The course focuses on the design process. Students are introduced to engineering through case studies and reverse engineering activities. Students will learn the steps in the design process and how engineers use this process to create new devices. Teams of students are then assigned a design project that culminates in building and evaluating a prototype of their design. Results of the design project are presented in both oral and written reports. This course does not require any prior engineering background.

Note: This course can be used towards the Engineering Science and Design distribution requirement in IE and ME.

ES 1310. INTRODUCTION TO COMPUTER AIDED DESIGN.*Cat. I*

This introduction course in engineering graphical communications and design provides a solid background for all engineering disciplines. The ability to visualize, create and apply proper design intent and industry standards for simple parts, assemblies and drawings is a necessity for anyone in a technology environment. Computer Aided Design software is used as a tool to create 2D & 3D sketches, 3D parts, 3D assemblies and 2D drawings per an industry standard. Multiview and pictorial graphics techniques are integrated with ANSI standards for dimensioning and tolerances, sectioning, and generating detailed engineering drawings. Emphasis is placed on relating drawings to the required manufacturing processes. The design process and aids to creativity are combined with graphics procedures to incorporate functional design requirements in the geometric model. No prior engineering graphics or software knowledge is assumed.

ES 2001. INTRODUCTION TO MATERIALS SCIENCE.*Cat. I*

This beginning course provides important background for all science and engineering disciplines regarding the capabilities and limitations of materials in our everyday lives. Students are introduced to the fundamental theme of materials science-- structure-property-processing relationships—in metals, ceramics, and plastics. Aspects of material structure range from the atomic to microstructural and macroscopic scales. In turn, these structural features determine the properties of materials. In particular, this course investigates connections between structure and mechanical properties, and how working and thermal treatments may transform structure and thus alter material properties. This knowledge is then applied to material selection decisions.

Recommended background: prior knowledge of college-level chemistry.

ES 2501. INTRODUCTION TO STATIC SYSTEMS.*Cat. I*

This is an introductory course in the engineering mechanics sequence that serves as a foundation for other courses in mechanical engineering. The course covers general two- and three-dimensional force and couple systems, distributed loads, resultant forces, moments of forces, free body diagrams, equilibrium of particles and finite sized bodies. Specific topics include friction, trusses, shear forces, bodies subjected to distributed loads, bending moments in beams, and first and second moments of plane areas.

Recommended background: Differential (MA 1021) and integral (MA 1022) calculus, vector algebra (MA 1023), and double and triple integration (MA 1024).

ES 2502. STRESS ANALYSIS.*Cat. I*

This is an introductory course that addresses the analysis of basic mechanical and structural elements. Topics include general concepts of stresses, strains, and material properties of common engineering materials. Also covered are two-dimensional stress transformations, principal stresses, Mohr's circle and deformations due to mechanical and thermal effects. Applications are to uniaxially loaded bars, circular shafts under torsion, bending and shearing and deflection of beams, and buckling of columns. Both statically determinate and indeterminate problems are analyzed.

Recommended background: mechanical systems (ES 2501 or equivalent), differential (MA 1021) and integral (MA 1022) calculus, vector algebra (MA 1023), and double and triple integration (MA 1024).

ES 2503. INTRODUCTION TO DYNAMIC SYSTEMS.*Cat. I*

Engineers should be able to formulate and solve problems that involve forces that act on bodies which are moving. This course deals with the kinematics and dynamics of particles and rigid bodies which move in a plane.

Topics covered will include: kinematics of particles and rigid bodies, equations of motion, work-energy methods, and impulse and momentum. In this course a basic introduction to mechanical vibration is also discussed. Basic equations will be developed with respect to translating and rotating coordinate systems.

Recommended background: Statics (ES 2501 or CE 2000).

ES 2800. ENVIRONMENTAL IMPACTS OF ENGINEERING DECISIONS.*Cat. II*

Engineering decisions can affect the environment on local and global scales. This course will introduce students to concepts that will make them aware of the ramifications of their engineering decisions, and is intended for engineering students of all disciplines. Specific topics the course will cover include: environmental issues, waste minimization, energy conservation, water conservation and reuse, regulations (OSHA, TSCA, RCRA, etc.), lifecycle assessment, risk assessment, sustainability, design for the environment, and environmental impact statements. Energy and mass balances will be applied to activities that impact the environment. Instruction will be provided through lectures, practitioner seminars, and a term project. Intended audience: all engineering majors desiring a general knowledge of the environmental impacts of engineering decisions.

Recommended background: elementary college chemistry; second year students.

This course will be offered in 2020-21, and in alternating years thereafter.

ES 3001. INTRODUCTION TO THERMODYNAMICS.*Cat. I*

This course emphasizes system and control volume modeling using conservation of mass and the First and Second Laws of Thermodynamics. Topics include an introduction to heat, work, energy, and power, properties of simple substances, and cycle analysis for power production and refrigeration.

Recommended background: basic physics, (PH 1110, PH 1111) elementary differential and integral calculus (MA 1021, MA 1022) or equivalents.

ES 3002. MASS TRANSFER.*Cat. I*

This course introduces the student to the phenomena of diffusion and mass transfer. These occur in processes during which a change in chemical composition of one or more phases occurs. Diffusion and mass transfer can take place in living systems, in the environment, and in chemical processes. This course will show how to handle quantitative calculations involving diffusion and/or mass transfer, including design of process equipment.

Topics may include: fundamentals of diffusional transport, diffusion in thin films; unsteady diffusion; diffusion in solids; convective mass transfer; dispersion; transport in membranes; diffusion with chemical reaction; simultaneous heat and mass transfer; selected mass transfer operations such as absorption, drying, humidification, extraction, crystallization, adsorption, etc.

Recommended background: fundamentals of chemical thermodynamics, fluid flow and heat transfer; ordinary differential equations (MA 2051 or equivalent).

ES 3003. HEAT TRANSFER.*Cat. I*

This course presents the fundamentals of heat transfer in the three modes of conduction, convection, and radiation. Topics include steady-state and transient heat conduction, forced external and internal convection, natural convection, heat exchanger analysis, radiation properties, and radiative exchange between surfaces.

Recommended background: knowledge of thermodynamics, fluid mechanics, and ordinary differential equations (ES 3001, ES 3004, and MA 2051) or equivalents.

ES 3004. FLUID MECHANICS.*Cat. I*

A study of the fundamental laws of statics, kinematics and dynamics applied to fluid mechanics. The course will include fluid properties, conservation of mass, momentum and energy as applied to real and ideal fluids. Laminar and turbulent flows, fluid resistance and basic boundary layer theory will also be considered.

Recommended background: basic physics, basic differential equations and vectors.

ES 3011. CONTROL ENGINEERING I.*Cat. I*

Characteristics of control systems. Mathematical representation of control components and systems. Laplace transforms, transfer functions, block and signal flow diagrams. Transient response analysis. Introduction to the root-locus method and stability analysis. Frequency response techniques including Bode, polar, and Nichols plots.

This sequence of courses in the field of control engineering (ES 3011) is generally available to all juniors and seniors regardless of department. A good background in mathematics is required; familiarity with Laplace transforms, complex variables and matrices is desirable but not mandatory. All students taking Control Engineering I should have an understanding of ordinary differential equations (MA 2051 or equivalent) and basic physics through electricity and magnetism (PH 1120/1121). Control Engineering I may be considered a terminal course, or it may be the first course for those students wishing to do extensive work in this field. Students taking the sequence of two courses will be prepared for graduate work in the field.

Recommended background: Ordinary Differential Equations (MA 2051) and Electricity and Magnetism (PH 1120, PH 1121).

Students may not receive credit for both ES 3011 and ECE 3012.

ES 3323. ADVANCED COMPUTER AIDED DESIGN.*Cat. I*

This course is intended to strengthen solid modeling and analysis skills with an emphasis on robust modeling strategies that capture design intent. The use of solid models for applications in mechanical design and engineering analysis is emphasized. Topics include: advanced feature-based modeling, variational design, physical properties, assembly modeling, mechanisms, and other analytical methods in engineering design.

Recommended background: familiarity with drafting standards (ES 1310), mechanical systems (ES 2501 or CE 2000, ES 2503), strength of materials (ES 2502 or CE 2001) and kinematics (ME 3310) is assumed. Additional background in machine design (ME 2300, ME 3320) is helpful.

ES 3501. A PROJECT-BASED INTRODUCTION TO SYSTEMS ENGINEERING.*Cat. I*

Systems Engineering is a multifaceted discipline, involving human, organizational, and various technical variables that work together to create complex systems. This course is an introduction and overview of the methods and disciplines that systems engineers use to define and develop systems, with a particular focus on capstone projects. The course will include specific integrated examples, projects, and team building exercises to aid in understanding and appreciating fundamental principles. Topics covered will include: Introduction to Systems Engineering; Requirements Development; Functional Analysis; System Design; Integration, Verification and Validation; Trade Studies and Metrics; Modeling and Simulation; Risk Management; and Technical Planning and Management.

Recommended background: Third or fourth year standing as an undergraduate student, preferably in engineering or science, or permission of the instructor.

FIRE PROTECTION ENGINEERING

FP 3070. FUNDAMENTALS OF FIRESAFETY ANALYSIS.*Cat. I*

This course introduces students of different technical disciplines to analytical methods and techniques to address problems of fire, explosions, or hazardous incidents. Emphasis will be placed on understanding the physical concepts of the problem and their interactions. Quantification will adapt existing procedures to appropriate levels of theoretical and empirical methods in the field of fire science and engineering. Computer applications will be incorporated.

Recommended background: mathematics through differential equations; engineering science; fluid mechanics.

FP 3080. INTRODUCTION TO BUILDING FIRES SAFETY SYSTEM DESIGN.*Cat. I*

This course introduces principles and applications of building fire safety design. Topics include the interaction between fire, the building, and building occupants; systems that are used to detect, suppress, and control the spread of fire; and systems that facilitate the safe evacuation of occupants during fire. Building code requirements and engineering methods for analysis and design of building fire safety systems will be explored.

Recommended background: Thermodynamics.

This course will be offered in 2020-21, and in alternating years thereafter.

Graduate Fire Protection Engineering Courses of Interest to Undergraduates

FP 520. FIRE MODELING.

(Prerequisite: FP 521 or special permission of the instructor.) Modeling of compartment fire behavior is studied through the use and application of two types of models: zone and field. The field model studied is FDS. The zone model studied is a student developed model. Focus on in-depth understanding of each of these models is the primary objective in terms of needed input, equations solved, interpretation of output and limitations. A working student model is required for successful completion of the course. Basic computational ability is assumed. Basic numerical methods are used and can be learned during the course via independent study. The zone model studied is a student developed model.

FP 521. FIRE DYNAMICS I.

(Prerequisites: Undergraduate chemistry, thermodynamics [or physical chemistry], fluid mechanics and heat transfer.) This course introduces students to fundamentals of fire and combustion and is intended to serve as the first exposure to fire dynamics phenomena. The course includes fundamental topics in fire and combustion such as thermodynamics of combustion, fire chemistry, premixed and diffusion flames, solid burning, ignition, plumes, heat release rate curves, and flame spread. These topics are then used to develop the basis for introducing compartment fire behavior, pre- and post- flashover conditions and zone modeling. Basic computational ability is assumed. Basic numerical methods are used and can be learned during the course via independent study.

FP 553. FIRE PROTECTION SYSTEMS.

(Prerequisites: Undergraduate courses in chemistry, fluid mechanics and either thermodynamics or physical chemistry.) This course provides an introduction to automatically activated fire suppression and detection systems. A general

overview is presented of relevant physical and chemical phenomena and commonly used hardware in automatic sprinkler, gaseous agent, foam and dry chemical systems. Typical contemporary installations and current installation and approval standards are reviewed.

FP 554. ADVANCED FIRE SUPPRESSION.

Advanced topics in suppression systems analysis and design are discussed with an aim toward developing a performance based understanding of suppression technology. Automatic sprinkler systems are covered from the standpoint of predicting actuation times, reviewing numerical methods for hydraulic analyses of pipe flow networks and understanding the phenomenology involved in water spray suppression. Special suppression systems are covered from the standpoint of two phase and non-Newtonian pipe flow and simulations of suppression agent discharge and mixing in an enclosure.

FP 555. DETECTION, ALARM AND SMOKE CONTROL.

(Prerequisites: FP 553 and FP 521, which can be taken concurrently.)

Principles of fire detection and using flame, heat and smoke detector technology are described. Fire alarm technology and the electrical interface with fire/smoke detectors are reviewed in the context of contemporary equipment and installation standards. Smoke control systems based on buoyancy and HVAC principles are studied in the context of building smoke control for survivability and safe egress.

FP 570. BUILDING FIRESAFETY I.

This course focuses on the presentation of qualitative and quantitative means for firesafety analysis in buildings. Fire test methods, fire and building codes and standards of practice are reviewed in the context of a systematic review of firesafety in proposed and existing structures.

FP 571. PERFORMANCE-BASED DESIGN.

(Prerequisites: FP 553, FP 521 and FP 570 or special permission of instructor.)

This course covers practical applications of fire protection engineering principles to the design of buildings. Both compartmented and non-compartmented buildings will be designed for criteria of life safety, property protection, continuity of operations, operational management and cost. Modern analytical tools as well as traditional codes and standards are utilized. Interaction with architects, code officials and an awareness of other factors in the building design process are incorporated through exercises and a design studio.

FP 572. FAILURE ANALYSIS.

Development of fire investigation and reconstruction as a basis for evaluating, and improving firesafety design. Accident investigation theory and failure analysis techniques such as fault trees and event sequences are presented. Fire dynamics and computer modeling are applied to assess possible fire scenarios and the effectiveness of fire protection measures. The products liability aspects of failure analysis are presented. Topics include products liability law, use of standard test methods, warnings and safe product design. Application of course materials is developed through projects involving actual case studies.

FP 573. INDUSTRIAL FIRE PROTECTION.

(Prerequisites: FP 553, FP 521 or special permission of instructor.) Principles of fire dynamics, heat transfer and thermodynamics are combined with a general knowledge of automatic detection and suppression systems to analyze fire protection requirements for generic industrial hazards. Topics covered include safe separation distances, plant layout, hazard isolation, smoke control, warehouse storage and flammable liquid processing and storage. Historic industrial fires influencing current practice on these topics are also discussed.

FP 575. EXPLOSION PROTECTION.

Principles of combustion explosions are taught along with explosion hazard and protection applications. Topics include a review of flammability limit concentrations for flammable gases and dusts; thermochemical equilibrium calculations of adiabatic closed vessel deflagration pressures and detonation pressures and velocities; pressure development as a function of time for closed vessels and vented enclosures; the current status of explosion suppression technology; and vapor cloud explosion hazards.

FP 580. SPECIAL PROBLEMS

Individual or group studies on any topic relating to fire protection may be selected by the student and approved by the faculty member who supervises the work. Examples include Business Practices, Combustion, People in Fires, Fire Dynamics II, Fire and Materials, Forensic Techniques, and Complex Decision Making.

FP 581. SEMINAR.

Reports on current advances in the various branches of fire protection.

FP 587. FIRE SCIENCE LABORATORY.

(Prerequisite: FP 521.) This course provides overall instruction and hands-on experience with fire science related experimental measurement techniques. The objective is to expose students to laboratory-scale fire experiments, standard fire tests and state-of-the-art measurement techniques. The Lateral Ignition and Flame Transport (LIFT) apparatus, state-of-the-art smoke detection systems, closed-up flashpoint tests and gas analyzers are among the existing laboratory apparatus. Fire related measurement techniques for temperature, pressure, flow and velocity, gas species and heat fluxes, infrared thermometry, Laser Doppler Velocimetry (LVD) and Laser Induced Fluorescence (LIF) will be reviewed.

FP 590. M.S. THESIS

Research study at the M.S. level.

FP 690. PH.D. DISSERTATION.

HUMANITIES AND ARTS

ARABIC (AB)

AB 1531. ELEMENTARY ARABIC I.

Cat. I

An intensive course to introduce the Arabic language to students with no background in Arabic. Oral language acquisition will stress structures and vocabulary required for basic communicative tasks. Emphasis will be on grammar, vocabulary, and writing system. Cultural aspects of Arabic-speaking countries introduced through course material.

This course is closed to native speakers of Arabic and heritage speakers except with written permission from the instructor.

AB 1532. ELEMENTARY ARABIC II.

Cat. I

Continuation of AB 1531. Oral language acquisition will stress structures and vocabulary required for basic communicative tasks. Emphasis will be on grammar, vocabulary, and writing system. Cultural aspects of Arabic-speaking countries introduced through course material.

This course is closed to native speakers of Arabic and heritage speakers except with written permission from the instructor.

Recommended background: AB 1531.

AB 1533. ELEMENTARY ARABIC III.

Cat. I

Continuation of AB 1532. Oral language acquisition will stress structures and vocabulary required for basic communicative tasks. Emphasis will be on grammar, vocabulary, and writing system. Cultural aspects of Arabic-speaking countries introduced through course material.

This course is closed to native speakers of Arabic and heritage speakers except with written permission from the instructor.

Recommended background: AB 1532.

ART HISTORY/ARCHITECTURE (AR)

AR 1100. ESSENTIALS OF ART.

Cat. I

This course provides an introduction to the basic principles of two and three-dimensional visual organization. The course focuses on graphic expression, idea development, and visual literacy. Students will be expected to master basic rendering skills, perspective drawing, concept art, and storyboarding through traditional and/or computer-based tools.

AR 1101. DIGITAL IMAGING AND COMPUTER ART.

Cat. I

This course focuses on the methods, procedures and techniques of creating and manipulating images through electronic and digital means. Students will develop an understanding of image alteration. Topics may include color theory, displays, modeling, shading, and visual perception.

Recommended background: AR 1100.

AR 1111. INTRODUCTION TO ART HISTORY.

Cat. I

How do we understand a work of art? Through readings and the study of objects at the Worcester Art Museum, the student will survey the major developments in world art and be introduced to various critical perspectives in art history. Students will learn how art historians work with primary materials and formulate arguments. No previous knowledge of art is required. (Formerly HU 1014.)

AR/IMGD 2101. 3D MODELING I.

Cat. I

3D modeling is concerned with how to render created forms in a virtual environment. This course covers 3D modeling applications in video game development, film production, product design and fine art. Topics may include creating and armature, modeling organic and hard surfaces and sculpting using traditional techniques applied to a 3D model. Students will create works suitable for presentation in professional quality portfolio.

Recommended background: AR1100 and AR1101.

AR 2111. MODERN ART.

Cat. I

The successive phases of modern art, especially painting, are examined in light of the late-19th-century break with the 600-year old tradition of representation.

Topics covered include: non-objective art and abstraction—theory and practice, primitivism in modern art, surrealism and the irrational, the impact of photography on modern painting, cubism and collage, regionalism and abstract expressionism as American art forms, Pop art and popular culture, and the problem of concept versus representation in art. (Formerly AR 2300.)

AR 2114. MODERN ARCHITECTURE IN THE AMERICAN ERA, 1750-2001 AND BEYOND.

Cat. I

This course studies, in a non-technical way, America's buildings and places, in the context of world architecture in modern times. The history of American architecture was shaped by the forces that shaped America, from its political emergence in the eighteenth century to the post-9/11 era. These forces include dreams of social and spiritual perfection; a tight and conflicted relation with nature; and the rise and spread of industrial capitalism. The same forces created the Modern Movement in architecture. How are modernism and American architecture interrelated? Illustrated lectures, films, and tours of Worcester architecture explore the question, while training students in the methods of architectural history and criticism.

Students who have taken AR 2113, Topics in 19th- and 20th-Century Architecture, since the 2000-2001 academic year MAY NOT take AR 2114 for credit.

AR 2115. TOPICS IN ARCHITECTURE SINCE 1960.

Cat. I

This course offers a detailed overview of the history of architecture between the consolidation of modern architecture in standard architectural practice and the present period of pluralism. Topics covered will include: modernism and its critique in the developing world; Louis I. Kahn's and Robert Venturi's critiques of modernist architecture culture; the High-Tech movement; utopian alternatives to the modernist city; the return of pre-modern urbanism; Critical Regionalism; the rise of Postmodernism 1970-80; the developer-led architectural boom of the 1980s; "Deconstructivism" and critical dissolution of rationalist form; the introduction of CAD in architectural design and its impact on the "blob architecture" of Frank Gehry and others; the development of global models of architectural practice; sustainable architecture and urbanism; global developments in other, related design fields and their consumer culture.

Recommended background: AR 2114.

AR 2202. FIGURE DRAWING.

Cat. I

The focus of this course is in study of representational figure drawing. This course will cover drawing techniques, applied to study from a live model. Topics covered will be sight size measurement, study of form and light, copying from master drawings and applying these lessons to weekly sessions with a live model. Each class will feature a demonstration on the topic followed by individual critique and study.

Recommended Background: AR 1100.

AR/IMGD 2222. 2D ANIMATION I.

Cat. I

2D Animation I teaches students how to draw, pose, breakdown and in-between characters for 2D animation, focusing on weight, balance, timing, and movement to achieve well-structured and fluid animation. Lectures and projects are conducted to train students in the twelve classical animation principles using digital 2D media. Projects and lectures are designed to practice the fundamentals of traditional frame-by-frame and hand-drawn character animation.

Recommended background: Basic knowledge of figure drawing (AR 2202) and digital art software (AR 1101) is recommended.

AR 2301. GRAPHIC DESIGN.*Cat. I*

This course introduces design principles and their application to create effective forms of graphic communication. The students will learn the fundamentals of visual communication and will work on projects to analyze, organize, and solve design problems. Topics may include: the design process; figure/ground; shape; dynamic balance; Gestalt principles; typography; layout and composition; color; production and presentation in digital formats.

AR/IMGD 2333. 3D ANIMATION I.*Cat. I*

3D Animation I teaches students how to use 3D animation software to apply classical animation principles into 3D work. Lectures focus on creating organic and compelling character animation through body mechanics, weight, and dynamic posing in addition to exposing students to learning how to think about character acting and staging within a 3D environment.

Recommended background: Basic knowledge digital art software (AR 1101) is recommended.

Suggested background: Basic knowledge of animation (IMGD/AR 2222).

AR 2401. VIDEO PRODUCTION.*Cat. I*

This course will introduce students to concepts and techniques for live action digital filmmaking. Topics will include constructing a visual narrative, principles of cinematography, visual and audio editing, working with actors, and the stylistic elements of various genres of filmmaking.

Recommended background: Basic knowledge of the history and theory of film (HU 2251 or equivalent).

AR/IMGD 2700. DIGITAL PAINTING.*Cat. I*

This course covers painting techniques as applied to texturing a 3D asset or illustration/conceptual art. Topics include are color theory, study of form, lighting, applying traditional painting ideas to the digital format, character design, generation of ideas and a history of digital painting. Each class features a demonstration on the topic followed by individual critique and study. Students work towards a final project that may be suitable for an Art portfolio.

Recommended Background: AR 1101 (Digital imaging and Computer Art); AR 2202 (Figure Drawing)

AR/IMGD 2740. 3D ENVIRONMENTAL MODELING.*Cat. II*

The objective of this course is to teach students how to create 3D environments and props for use in digital models, simulations, games, or animation. The course will examine different types of architecture used in 3D spaces. The students will learn how to create historical and fictional interior and exterior environments; to design, model, texture, and render in high details; and to import their creation into an engine for testing. Topics may include space, human scale, set design, surface texturing, and basic camera animation. Students may not receive credit for IMGD/AR 2740 and IMGD/AR 205X.

Recommended Background: Basic 3D modeling skills (AR 1101)

This course will be offered in 2020-21, and in alternating years thereafter.

AR 2750. TOPICS IN STUDIO ART.*Cat. III*

Specialty subjects are offered using the research and creative expertise of the department faculty. Content and format varies to suit the interest and needs of the faculty and students. Courses are defined through the registrar and may be repeated for different topics covered. Students may not receive additional credit for taking this course more than once with the same title.

Recommended background: AR 1100

AR/IMGD 3101. 3D MODELING II.*Cat. I*

This course will build upon the skills learned in 3D MODELING with studies in life drawing/anatomy study and application towards completed character models. Students will create high resolution sculpts for real time game environments and animation. Topics covered will be character design as it applies to 3D MODELING, creating realistic design sculpts and incorporating them into a game environment as well as the study of anatomy as it applies to organic modeling.

Recommended Background: AR 1101, IMGD/AR 2101, AR 2202

AR 3112. MODERNISM, MASS CULTURE, AND THE AVANT-GARDE.*Cat. I*

What is the role of art to be in the modern world? Can art be a vehicle for social change, or should art be a self-critical discipline that pursues primarily aesthetic ends? What is the relationship between art and mass culture? Using primary sources, this course focuses on some of the theorists and artistic trends since the mid-nineteenth century that have sought to resolve this dilemma. These include: Ruskin, Morris and the Arts and Crafts Movement; Art for Art's Sake; the German Werkbund and the Bauhaus; American industrial design.

AR/ID 3150. LIGHT, VISION AND UNDERSTANDING.*Cat. II*

By using material from the sciences and the humanities, this course examines the ways in which ideas of knowledge and of human nature have been fashioned. The specific topics include physical theories about light, biological and psychological theories of visual perception, and artistic theories and practices concerned with representation. The mixing of material from different academic disciplines is deliberate, and meant to counter the notion that human pursuits are "naturally" arranged in the neat packages found in the modern university. The course draws upon the physical and social sciences, and the humanities, to examine how those fields relate to one another, and how they produce knowledge and self-knowledge. Cultural as well as disciplinary factors are assessed in this process.

Light, Vision and Understanding is conducted as a seminar. The diverse collection of reading materials includes a number of primary texts in different fields. In addition, the students keep a journal in which they record the results of numerous individual observations and experiments concerning light and visual perception. The course can fit into several Humanities and Arts topic areas as well as serve as a starting point for an IQP. There are no specific requirements for this course, although some knowledge of college-level physics, as well an acquaintance with the visual arts, is helpful.

This course will be offered in 2020-21, and in alternating years thereafter.

AR/IMGD 3200. INTERACTIVE ELECTRONIC ARTS.*Cat. I*

This course introduces students to techniques and processes for the creation of real-time, interactive works of art. Students learn to use electronic sensors and other tools for audio, graphics, and video processing, as well as design customized software interfaces to create interactive artworks that respond to users and their environment. The course also introduces students to the work of significant contemporary arts practitioners as well as their historical precedents, with a special emphasis on inter-media works that bridge visual art, music composition, and the performing arts. Topics may include electronic musical instruments and performance interfaces, computer vision, VJing, electronically-augmented dance, controller hacking, wired clothing, networked collaboration and mobile media, and algorithmic and generative art.

Recommended Background: Animation (AR/IMGD 2101 or equivalent), and exposure to digital audio or music and introductory programming.

AR/IMGD 3222. 2D ANIMATION II.*Cat. I*

This course will build upon the techniques learned in IMGD/AR 2222. Students will learn to apply the animation principles to character animation. Students are taught how to tell a compelling, character-driven story through a focus on character acting techniques such as body language, lip syncing, facial animation, and micro expressions. Additional topics covered may include sprites for games, biped and quadruped animation, and 2D animation pipelines. Students will create animated sequences that are intended to serve a narrative structure for games and other media.

Recommended background: Knowledge of digital 2D animation techniques and classical animation principles (IMGD/AR 2222).

AR/IMGD 3333. 3D ANIMATION II.*Cat. I*

This course will build upon the techniques learned in IMGD/AR 2333. Students will learn to apply the animation principles with a focus on character acting and cinematic animation. Students are taught how to tell a compelling, character-driven story through a focus on acting techniques such as body language, lip syncing, facial animation, and micro expressions whilst incorporating digital cinematography techniques. Additional topics covered may include creating 3D simulations for hair and cloth, biped and quadruped animation, and 3D animation pipelines. Students will create animated sequences that are intended to serve a narrative structure for games and other media.

Recommended background: Knowledge of digital 3D animation techniques and classical animation principles (IMGD/AR 2333).

AR/IMGD 3700. CONCEPT ART AND CREATIVE ILLUSTRATION.*Cat. I*

This course covers drawing as it applies to concept art and illustration. The course begins with study of a human model and representational drawing. Following this, students work on drawing from the mind and applying the lessons learned from the figure drawing to creating concept art and illustration. Topics covered are shape recognition and recalling, inventing from the mind, creative starters, study of form and light, visual composition and developing a personal approach, working with individual strengths to create a compelling visual design. Students create a series of concept art exercises and apply these skills towards a personal project of their own.

Recommended Background: AR 2202 (Figure Drawing); IMGD/AR 2700 (Digital Painting)

CHINESE (CN)**CN 1541. ELEMENTARY CHINESE I.***Cat. I*

An intensive course to introduce the Chinese language (Mandarin) to students with no background in Chinese. Emphasis will be on learning the foundations of the sound system through pinyin and acquiring familiarity with tones. Oral language acquisition will stress structures and vocabulary required for basic communicative tasks. Cultural aspects of China introduced through course material.

This course is closed to native speakers of Chinese and heritage speakers except with written permission from the instructor.

CN 1542. ELEMENTARY CHINESE II.*Cat. I*

Continuation of CN 1541 for non-native, non-heritage speakers. Emphasis on oral communication and vocabulary acquisition continues. Basics of writing system introduced.

Recommended background: CN 1541.

This course is closed to native speakers of Chinese and heritage speakers except with written permission from the instructor.

CN 1543. ELEMENTARY CHINESE III.*Cat. I*

Continuation of CN 1542 Mandarin Chinese. Primary emphasis is on conversational skills, with increased character introduction. Recognition of the most-commonly-used Chinese characters will be required by term end.

Recommended background: CN 1542.

This course is closed to native speakers of Chinese and heritage speakers except with written permission from the instructor.

CN 2541. INTERMEDIATE CHINESE I.*Cat. I*

Continuation of CN 1542. Course will focus on practical conversations and recognition of Chinese characters, with greater emphasis placed on reading and writing.

Recommended background: CN 1543.

This course is closed to native speakers of Chinese and heritage speakers except with written permission from the instructor.

CN 2542. INTERMEDIATE CHINESE II.*Cat. I*

This course will build on intermediate Chinese conversational patterns. Class time will focus on dialogue and mastery of grammatical constructions, as well as character recognition and reading ability. Conversational drills, audio recordings, video, and group interaction will enhance classroom learning.

Recommended background: CN 2541 Intermediate Chinese I or the equivalent.

This course is closed to native speakers of Chinese and heritage speakers except with written permission from the instructor.

CN 2543. INTERMEDIATE CHINESE III.*Cat. I*

Continuation of CN 2542. This course continues to build on students' Chinese conversational skills with a focus on dialogue and mastery of grammatical constructions, as well as character recognition and reading ability. Conversational drills, audio recordings, video, and group interaction will enhance classroom learning.

Recommended background: CN 2542 or the equivalent.

This course is closed to native speakers of Chinese and heritage speakers except with written permission from the instructor.

CN 2544. INTERMEDIATE CHINESE IV.*Cat. I*

Continuation of CN 2543. Students continue to build their conversational skills through more complex dialogue and more complicated grammatical constructions. Character recognition and reading ability become more central to class assignments. Conversational drills, audio recordings, video, and group interaction will enhance classroom learning.

Recommended background: CN 2543 or equivalent.

This course is closed to native speakers of Chinese and heritage speakers except with written permission from the instructor.

CN 3541. ADVANCED INTERMEDIATE CHINESE I.*Cat. I*

This course focuses on increasingly sophisticated conversational patterns as well as acquiring the vocabulary necessary for reading texts. Emphasis is on developing active skills to move students to a high-intermediate level of proficiency in reading, writing, listening, and speaking, with continued attention on grammar, phrases, sentence patterns, and character recognition.

Recommended background: CN 2544 or the equivalent.

This course is closed to native speakers of Chinese and heritage speakers except with written permission from the instructor.

CN 3542. ADVANCED INTERMEDIATE CHINESE II.*Cat. I*

This course builds on advanced intermediate Chinese skills, focusing on both conversational patterns and reading/writing. Class time will focus on dialogue and mastery of increasingly complex grammatical constructions, with emphasis on character recognition and production for reading and writing. Emphasis will be placed on integrating materials in real-world applications. Not open to native or heritage speakers without written permission of instructor. Recommended background: CN 3541 Advanced Intermediate Chinese I or equivalent.

Students may not receive credit for both CN 3542 and CN 354X.

CN 3543. ADVANCED INTERMEDIATE CHINESE III.*Cat. I*

This course continues to build on students' advanced intermediate Chinese skills with increasing emphasis on reading and writing. Writing assignments will be geared towards expressing more complex topics in Chinese that are related to cultural phenomena in contemporary Chinese societies. Not open to native or heritage speakers without written permission of instructor. Recommended background: CN 3542 Advanced Intermediate Chinese II or equivalent.

Students may not receive credit for both CN 3543 and CN 355X.

ENGLISH (EN)**EN 1221. INTRODUCTION TO DRAMA: THEATRE ON THE PAGE AND ON THE STAGE.***Cat. I*

This introductory course will give the student an understanding of the forms of drama, the styles of theatre performance and production, and the emergence of new forms and styles. Research and writing projects, and performance activities will offer the student experience in the theory and practice studied in the course.

EN 1222. SHAKESPEARE IN THE AGE OF ELIZABETH.*Cat. I*

This course is an introduction to Shakespeare, his theatre, and some important concepts of his world. Students will have the opportunity to sample representative Shakespearean tragedies, comedies, and histories. In addition to class discussions and scene work, students will be able to enhance their readings by analyzing video recordings of the plays.

EN 1242. INTRODUCTION TO ENGLISH POETRY.*Cat. I*

This course surveys the poems of our language. From the Anglo-Saxon poems to the popular verse of Tennyson, the songs and the poets are legion: Chaucer, Raleigh, Spenser, Marlowe, Shakespeare, Jonson, Donne, Herrick, Milton, Blake, Wordsworth, Coleridge, Byron, Keats, Tennyson, Browning, and Hopkins. The England that nourished these writers will be viewed through their ballads, lyrics, sonnets, epigrams, and epics. "Not marble nor the gilded monuments of princes shall outlive this powerful rhyme."

EN 1251. INTRODUCTION TO LITERATURE.*Cat. I*

This course introduces the student to a variety of critical perspectives necessary to an understanding and appreciation of the major forms, or genres, of literary expression (e.g., novel, short story, poetry, drama, and essay). Writing and class discussion will be integral parts of this course.

EN 1257. INTRODUCTION TO AFRICAN AMERICAN LITERATURE AND CULTURE.*Cat. II*

This course examines the formation and history of the African American literary tradition from slave narratives to contemporary forms in black popular culture. The course will explore some genres of African American writing and their relation to American literature and to black cultural expression.

This course will be offered in 2020-21, and in alternating years thereafter.

EN 2219. CREATIVE WRITING.*Cat. I*

This foundational course in creative writing aims to help students develop or improve the skills of written expression, emphasizing presentation and discussion of original work. Offerings may include generally themed courses covering multiple genres of interest or more specialized workshops in single genres of focus such as fiction, poetry, playwriting, nonfiction, memoir, or short prose forms.

EN 2221. AMERICAN DRAMA.*Cat. I*

An investigation into the development of American drama from its beginnings to the present. The history of the emergence of the legitimate theatre in this country will be followed by reading important plays, including the works of O'Neill, Williams, Mamet, Norman, Henley, and others. Discussion of the growth of regional theatres and their importance to the continuation of theatre as a serious and non-profit art form will be included in the course. The student will investigate the importance of theatre practice in the evolution of the dramatic literature of the country.

EN 2222. INTRODUCTION TO TECHNICAL THEATRE.*Cat. I*

This course introduces students to a variety of technical theatre disciplines, including scenic, lights, sound, props, costumes and more. Each week, students will focus on different technical elements through a combination of lectures, demonstrations, and hands on workshops. Students will demonstrate their learning through various projects and involvement in the current term production.

EN 2225. THE LITERATURE OF SIN.*Cat. II*

This course begins with selections from John Milton's provocative version of Adam and Eve's original sin in *Paradise Lost*. Focusing on Milton, John Donne and others, we will examine the theme of sin—political, religious, and sexual—in early modern literature. The events of the English Reformation profoundly influenced these writers, and their personal struggles against societal institutions have greatly influenced subsequent literary expressions of rage and rebellion. Students will also be reading texts by contemporary writers such as David Mamet which address the theme of sin in the modern city.

This course will be offered in 2020-21, and in alternating years thereafter.

EN 2226. INFECTED SHAKESPEARE: VENEREAL DISEASE, MADNESS, PLAGUE.*Cat. II*

With his many references to syphilis, Bubonic Plague, mental illness, and other serious afflictions, Shakespeare illuminates the harsh reality of living in 16th and 17th-century England. This course explores Shakespeare through the historical lens of early modern medical practice. Students will study plays such as *Hamlet*, *Richard III*, and *The Winter's Tale* alongside accounts by surgeons, doctors, midwives, and others who diagnosed, dissected, and (sometimes) cured. We will also pay close attention to the superstitions, misinformation, and downright strange treatments included in some of these accounts. Through creative and expository writing, students will analyze the impact of disease on Shakespeare's writing. This course is intended for students interested in any one of the following: drama, English literature, the history of medicine, biology, other fields of life sciences.

This course will be offered in 2019-20, and in alternating years thereafter.

EN 2234. MODERN AMERICAN NOVEL.*Cat. II*

Selected works of fiction which appeared after World War I will be the focus of this course. Ernest Hemingway, William Faulkner, or other authors of the early modern period will be studied, but significant attention will also be given to contemporary novelists, such as Thomas Pynchon, Philip K. Dick, and Toni Morrison. The cultural context and philosophical assumptions of the novels will be studied as well as their form and technique.

This course will be offered in 2019-20, and in alternating years thereafter.

EN 2237. LITERATURE AND THE ENVIRONMENT.*Cat. II*

This course will examine the many ways in which dramatists, essayists, filmmakers, novelists, and poets have articulated ecological and environmental concerns. Topics to be discussed may include changing attitudes towards terms like 'nature' and 'wilderness', the effects of technology on the environment, issues of conservation and sustainability, the dynamics of population growth, the treatment of animals, the production of food, and the presence of the spiritual in nature. Materials will include works by writers such as Wendell Berry, Rachel Carson, Winona LaDuke, Wangari Maathai, Thomas Malthus, Arne Naess, Nicolas Roeg, and Gary Snyder.

This course will be offered in 2020-21, and in alternating years thereafter.

EN 2242. POPULAR FICTION: READING IN INSTALLMENTS.*Cat. I*

Students in this course will have the opportunity to read two major masterpieces of English fiction the way they should be read: slowly, carefully, and with relish. Victorian novels are long and the term is short, but by reading novels in the way in which they were read by their original readers—serially—we can experience masterworks by Charles Dickens and George Eliot at comparative leisure, examining one serial installment per class session.

EN 2243. MODERN BRITISH LITERATURE.*Cat. II*

A survey of major modern British authors. The works of many of these writers reflect the political, religious, and social issues of the twentieth century. New psychological insights run parallel with experiments in the use of myth, stream of consciousness, and symbolism. Authors studied may include Hardy, Conrad, Owen, Joyce, Lawrence, Woolf, Eliot, Yeats, and Orwell.

This course will be offered in 2019-20, and in alternating years thereafter.

EN 2251. MORAL ISSUES IN THE MODERN NOVEL.*Cat. I*

This course focuses on the problem of how to live in the modern world. Emphasis will be placed on the way moral issues evolve within the complications of individual lives, as depicted in fiction. Such authors as Conrad, Kesey, Camus and Ellison show characters struggling with the questions of moral responsibility raised by love, religion, death, money, conformity.

EN 2252. SCIENCE AND SCIENTISTS IN MODERN LITERATURE.*Cat. I*

This course surveys the ways in which modern literature has represented science and scientists. Beginning with Mary Shelley's *Frankenstein*, the origin of what Isaac Asimov calls the "damned Frankenstein complex" is examined. More complex presentations of science and scientists occur in twentieth-century works like Brecht's *Galileo*, Huxley's *Brave New World*, and Pirsig's *Zen and the Art of Motorcycle Maintenance*.

The course covers major modern works of fiction and drama, including such literary forms as the play, the novel of ideas, and the utopian novel. Attention is focused on the themes (ideas) in, and the structure of, these works.

EN 2271. AMERICAN LITERARY HISTORIES.*Cat. I*

An investigation into one or more major movements or periods in American literature, focusing on aesthetic formations such as sentimentalism, realism, modernism, or postmodernism, on cultural formations from Transcendentalism and Regionalism through the Lost Generation and the Harlem Renaissance to the Beat Generation and the Native American Renaissance, or delivered through chronological engagements by century, by decade, or by other suitable framings attending to specific communities or sets of writers.

Recommended background: None, though coursework in English (e.g. EN 1251, Introduction to Literature) or any subsequent EN offering will be helpful.

EN 2281. WORLD LITERATURES.*Cat. I*

This course will examine literary works from two or more languages, modes, and/or traditions, often connecting these works to other works of expressive culture in the visual and performing arts. Some iterations may turn on a broader survey, others on more particular engagements with wider inflections. Material introduced beyond English will rely on translations but may also include attention to work in the original language. Attention to drama, poetry, and prose from various periods and places will encourage students to connect themes across cultural, formal, and historical divides, utilizing interdisciplinary and theoretical methods in the process of their reading and writing. Students who have previously taken EN 230X cannot take this course for credit.

Recommended background: None, though coursework in English (e.g. EN 1251, Introduction to Literature) or any subsequent EN offering will be helpful, as will courses emphasizing literature and culture offered in AB, CN, GN, and/or SP.

EN 3219. ADVANCED CREATIVE WRITING.*Cat. II*

This advanced seminar in creative writing includes sustained attention to the writing of fiction, poetry, and short prose forms among other genres, culminating in final projects (essay, play, poem, story, or some combination thereof) determined by individual interest and in consultation with the instructor. Investigation will also focus on the reading and discussion of exemplary works across genres, with an emphasis on contemporary practice. In the process, regular writing exercises and class visits from established authors will help to create a community of writers grounded in diverse methods.

Suggested background: Introductory level creative writing (EN 2219 (formerly EN 3217) or equivalent).

This course will be offered in 2019-20, and in alternating years thereafter.

EN 3222. FORMS IN WORLD DRAMA.*Cat. II*

The study of the major forms of world drama beginning with the Greeks and ending with contemporary works for the stage. Study will focus upon building skills to effectively analyze form and structure through dramatic content, and to create approaches to staging the plays from an informed understanding of the elements of theatrical style. The course will include plays by preeminent playwrights from cultures around the world.

Texts to be studied will vary at each offering.

This course will be offered in 2019-20, and in alternating years thereafter.

EN 3223. FORMS IN MODERN DRAMA.*Cat. II*

The study of the forms in modern drama through application of methods of theatre analysis for dramaturgical consideration and staging. Contemporary playwrights studied will include those from around the world whose work has been seen on international stages since the 1950s. Attention to theatre movements that reflect contemporary issues will be included, and producing groups that have operated with textual revision, minimal text, or no texts will be considered.

Texts to be studied will vary at each offering.

This course will be offered in 2020-21, and in alternating years thereafter.

EN 3225. SHAKESPEARE IN PERFORMANCE.*Cat. II*

This course examines a selection of Shakespeare's plays, specifically addressing issues of performance. We will approach the plays through close reading; in relationship to the historical, cultural, and theatrical context in which they were written and originally produced; through viewing and analysis (film and live performance); and as they have been and can be interpreted for performance. We will explore the relationship between text and performance in a practical way with performance exercises and staging scenes from the plays. We will also consider how production elements (design elements including setting and costumes, casting, direction and performance choices, etc.) create and convey meaning and shape audience response. This course will be offered in 2020-21, and in alternating years thereafter.

Recommended background: Some familiarity with Shakespeare and or/theatre but the course is suitable for anyone with interest in the subject.

EN 3226. STRANGE AND STRANGERS.*Cat. II*

This course examines the concept of "strange" and the figure of the "stranger" in a wide range of written and visual texts, from Shakespeare to Albert Camus to the 2017 horror/comedy film *Get Out*. We will focus on depictions of religious, racial, gendered, and other forms of alienation and otherness, from both an insider's and outsider's perspective.

This course will be offered in 2020-21, and in alternating years thereafter.

EN 3231. SUPERNATURAL LITERATURES.*Cat. II*

Take a vacation from the rational, quantifiable, and verifiable, and dip your toes into the ineffable. Unbridled, boundary-bending, and binary-busting, supernatural literature makes space for lived (and undead) experiences outside the mainstream. This course will examine the following questions: How are supernatural stories culturally situated? How is language used in supernatural texts, and when and why does it break down? What can we learn about the "real" through studying the fantastic? Course content will vary with each offering. Potential areas of focus might include magical realism, the supernatural and folklore, the gothic and gender, the gothic and race, the contemporary ghost story worldwide, and monstrosity and the grotesque.

This course will be offered in 2020-21, and in alternating years thereafter.

EN 3234. MODERN AMERICAN POETRY.*Cat. II*

This course examines the poetries and poetics of various modern and contemporary American traditions, focusing on schools and styles from the Modernists and Objectivists through the Black Arts Movement, Confessional Poetry, the New York School, and the San Francisco Renaissance. Attention will also be given to recent innovations in digital poetry, multiethnic poetry, and performance poetry. The course will include poets such as Wallace Stevens, Gwendolyn Brooks, Elizabeth Bishop, A.R. Ammons, Joy Harjo, Jimmy Santiago Baca, Myung Mi Kim, and Saul Williams.

This course will be offered in 2020-21, and in alternating years thereafter.

EN 3238. AMERICAN AUTHORS.*Cat. II*

EN faculty with expertise in American literature will select one or more authors to focus on in this course. Examples of such authors are James Baldwin, Octavia Butler, William Faulkner, Toni Morrison, Anne Sexton, and August Wilson. These authors often criticize the political and social status quo, addressing inequities in matters of class, gender, race, and sexuality. The intention is for students to focus on such authors in depth, in preparation for their final seminar or practicum. Faculty offering the course will indicate which authors they intend to present on the HUA website well before student signups, to permit efficient program planning.

Recommended Background: None, though coursework in English (e.g. EN 1251, Introduction to Literature) or any subsequent EN offering will be helpful.

This course will be offered in 2020-21, and in alternating years thereafter.

EN 3248. THE ENGLISH NOVEL.*Cat. I*

Participants in this seminar will examine the English novel from its origins in the eighteenth century to its twentieth-century forms, exploring the rich variety of ways a writer may communicate a personal and social vision. The novels treat love, travel, humor, work, adventure, madness, and self-discovery; the novelists may include Fielding, Austen, Dickens, Eliot, Wodehouse, and Woolf.

EN 3271. AMERICAN LITERARY TOPICS.*Cat. I*

This course investigates American literature as it relates to a specific theme, issue, controversy, or question. Attention might center upon topics from childhood and friendship to captivity and freedom, and from immigration and labor to law and war, drawing on or even focusing more decidedly upon aspects of identity including but not limited to class, ethnicity, gender, race, religion, and sexuality. Authors might extend from nineteenth century exemplars including Emily Dickinson, Herman Melville, Henry David Thoreau, and Walt Whitman to twentieth and twenty-first century figures such as Philip K. Dick, Toni Morrison, Thomas Pynchon, Leslie Marmon Silko, and Richard Wright.

Recommended background: None, though coursework in English (e.g. EN 1251, Introduction to Literature) or any subsequent EN offering will be helpful.

EN ----. DRAMA/THEATRE PERFORMANCES.*TH: ISU*

One-sixth unit of credit will be awarded for successful participation on productions. Performance activities currently receiving credit are:

- TH 1225 Theatre Production Practicum
- TH 2225 Acting
- TH 2227 Advanced Acting
- TH 2229 Advanced Theatre Production Practicum
- TH 3225 Directing
- TH 3227 Advanced Directing
- TH 3229 Dramaturgy
- TH 4225 Theatre Technology Design
- TH 4227 Advanced Theatre Technology Design
- TH 4229 Advanced Dramaturgy

Credit would be given on the condition that the performance takes place in a WPI performance directed or advised by a part- or full-time WPI instructor.

Note: A maximum of four 1/6 units, or a total of two 1/3 units, may be applied toward the five courses, or five one-third units, taken prior to the final Humanities and Arts practicum.

ENGLISH FOR INTERNATIONAL STUDENTS

These courses are recommended for undergraduate non-native speakers of English pursuing their HUA depth and breadth requirement at WPI.

ISE 1800. INTRODUCTION TO ACADEMIC READING AND WRITING FOR NON-NATIVE SPEAKERS OF ENGLISH.

The goal of this course is to provide international students for whom English is not their native language the necessary skills for academic success through reading and writing assignments. Students will focus on developing vocabulary, critical reading, paragraph, and essay writing skills. Emphasis is also given to a review of English grammar through intensive written and oral practice to promote accurate and appropriate language use.

Strongly recommended for first-year international non-native English speakers. Admission determined by Writing Placement or consent of the instructor.

ISE 1801. COMPOSITION FOR NON-NATIVE SPEAKERS OF ENGLISH.

This course is for international students who want to develop their academic writing skills through a sequence of essay assignments, with emphasis on rhetorical and grammatical issues particular to second language learners (ESL). Students will concentrate on producing coherent paragraphs, developing short essays in a variety of rhetorical modes, and improving mechanics (grammar and punctuation) and vocabulary usage. Both personal and academic writing assignments provide practice in the process of writing and revising work for content and form.

Recommended Background: ISE 1800 or equivalent skills (determined by Writing Placement or consent of the instructor).

ISE 1803. ORAL COMMUNICATION FOR NON-NATIVE SPEAKERS OF ENGLISH.

This course focuses on the speaking and listening skills that are necessary in an academic setting. Students practice formal and informal communication skills, including listening comprehension, pronunciation, and conversational and presentation skills. Students are encouraged to practice oral/aural exercises with the class as a whole and in small groups. Class work will build language skills and personal confidence levels.

ISE 2800. COLLEGE WRITING FOR NON-NATIVE SPEAKERS OF ENGLISH.

In this course students will practice analytical reading, writing, and thinking intensively, through a variety of exercises and assignments. Emphasis is placed on using various methods of organization appropriate to the writer's purpose and audience. Students will read and discuss a selection of non-fiction texts; these readings will form the basis for writing assignments in summary, critique, synthesis, and persuasion. The course also stresses the ability to understand, use, and document college-level non-fiction readings as evidence for effectively formulating and accurately supporting a thesis. This course is for international students who have already studied grammar extensively and need to refine the ability to produce acceptable academic English.

Recommended Background: ISE 1801 or equivalent skills (determined by Writing Placement or consent of the instructor).

ISE 2810. LISTENING AND SPEAKING FOR NON-NATIVE SPEAKERS.*Cat. II*

This course addresses the academic needs of high-intermediate/advanced non-native English language learners by developing their listening and speaking skills. Students will engage in activities to practice and improve listening skills, and participate in speaking activities to improve comprehensibility through pronunciation improvement.

Recommended background: Oral communication skills (ISE 1803) or equivalent skills.

Note: Students who have taken ISE 281X may not receive credit for this course.

This course will be offered in 2019-2020, and in alternate years thereafter.

ISE 2820. INTENSIVE READING FOR NON-NATIVE SPEAKERS.*Cat. II*

The goal of this course is to provide non-native English language students the skills to work with the highest levels of academic and professional reading. Students will develop active and critical reading skills by annotating self-selected academic journal articles, research reports, current news reports and autobiographical literature. Students will create annotated bibliographies, summaries, literature reviews, and critical reaction papers. Students will learn to analyze, synthesize and cite multiple sources when doing academic work. Students will also increase their vocabulary of high-level academic and professional terms.

Recommended background: Composition for Non-native Speakers of English (as covered in ISE 1801) or equivalent skills.

Note: Students who have taken ISE 282X may not receive credit for this course.

This course will be offered in 2019-20, and in alternate years thereafter.

ISE 3800. LOADED LANGUAGE: DISCOURSE AND POWER IN INTERNATIONAL ENGLISH.*Cat. II*

This course, for international non-native English speakers, examines how the varieties of this global language can define identity, reflect social structures, and create and maintain power differentials. The course examines discourse, coded language and labels, accents, and strategies for communicating across cultures. We will explore the effects of World Englishes on our own minds, our classroom, our campus, our local community, and the global stage.

Recommended background: Composition for non-native speakers of English (ISE 1801) or equivalent skills.

This course satisfies the Inquiry Seminar requirement.

Note: Students who have taken ISE 380X may not receive credit for this course.

This course will be offered in 2019-2020, and in alternate years thereafter.

GERMAN (GN)

GN 1511. ELEMENTARY GERMAN I.*Cat. I*

An intensive language course designed to teach concise expression of ideas in writing and speaking. Basic grammar and significant cultural aspects are introduced through the aid of readings, audio-recordings, video, and oral group interaction. (Formerly GN 2616.)

GN 1512. ELEMENTARY GERMAN II.*Cat. I*

A continuation of Elementary German I.

Recommended background: GN 1511.

GN 2511. INTERMEDIATE GERMAN I.*Cat. I*

A continuation of Elementary German II, with increased emphasis on oral and written expression. Basic textbook is supplemented by a collection of simple literary texts by the Grimm brothers, Brecht, and Bichsel.

Recommended background: Elementary German II.

GN 2512. INTERMEDIATE GERMAN II.*Cat. I*

A continuation of Intermediate German I.

Recommended background: GN 2511.

GN 3511. ADVANCED GERMAN I.*Cat. I*

Reading and in-class discussion of a wide variety of contemporary nonfictional and fictional texts. Some video viewing. Weekly brief writing assignments and continued expansion of vocabulary. Weekly vocabulary quiz. Review of grammar and introduction to advanced stylistic problems.

Recommended background: Intermediate German II.

GN 3512. ADVANCED GERMAN II.*Cat. I*

A continuation of Advanced German I.

Recommended background: GN 3511.

This course satisfies the Inquiry Practicum requirement.

GN 3513. SURVEY OF GERMAN CIVILIZATION AND CULTURE FROM 1871 TO THE PRESENT.*Cat. II*

Conducted entirely in German, the course presents an overview of the development of modern Germany and its culture since the founding of the Second Empire. Background readings in German and English provide the basis for in-class discussion of selected authentic German texts of various kinds: literary works, official documents, political manifestos, letters, and diaries. At least one film will be shown. A number of recurring themes in German culture will inform the content of the course: authoritarianism versus liberalism, idealism versus practicality, private versus public life.

Recommended background: GN 3511 (Advanced German I) and GN 3512 (Advanced German II) or equivalent.

This course satisfies the Inquiry Practicum requirement.

This course will be offered in 2020-21, and in alternating years thereafter.

GN 3514. SEMINAR ON SELECTED TOPICS IN GERMAN LITERATURE.*Cat. II*

The content of the seminar will change from time to time. The course will focus either on an author (e.g., Goethe, Heine, Kafka, Gunter Grass, Christa Wolf), a genre (e.g., lyric poetry, drama, narrative prose), a literary movement (e.g., Romanticism, expressionism), or a particular literary problem (e.g., literature and technology, writing and the Holocaust, writing and the city). The seminar will be conducted entirely in German.

Recommended background: GN 3511 (Advanced German I) and GN 3512 (Advanced German II) or equivalent.

This course satisfies the Inquiry Practicum requirement.

This course will be offered in 2019-20, and in alternating years thereafter.

GN 3516. GERMAN FILM.*Cat. II*

Since its beginnings in the early 20th century, film has been a powerful medium for popular entertainment as well as a potent expression of society's dreams, fears, and values. Films made in the German-speaking countries are no exceptions, from early expressionist films like *The Cabinet of Dr. Caligari* through Nazi documentaries like *Triumph of the Will* to today's feature films such as *Grizzly Man* and *Run Lola Run!* Many German directors have achieved international renown. This course, conducted in German, will examine representative German-language films from various perspectives: historical, socio-political, and thematic. Films will be shown in German with English subtitles. The course will include weekly screenings, discussion sessions, and substantial written assignments.

Recommended background: GN3512 or higher.

This course satisfies the Inquiry Practicum requirement.

This course will be offered in 2020-21, and in alternating years thereafter.

Some sections of this course may be offered as Writing Intensive (WI).

HISTORY (HI)

HI 1311. INTRODUCTION TO AMERICAN URBAN HISTORY.*Cat. I*

An introduction to the history of the American city as an important phenomenon in itself and as a reflection of national history. The course will take an interdisciplinary approach to study the political, economic, social, and technological patterns that have shaped the growth of urbanization. In addition to reading historical approaches to the study of American urban history, students may also examine appropriate works by sociologists, economists, political scientists and city planners who provide historical perspective.

HI 1312. INTRODUCTION TO AMERICAN SOCIAL HISTORY.*Cat. I*

An introduction to the historical study of American society. It addresses two questions: What is social history? and how do social historians work?

HI 1313. THE US AND THE WORLD.*Cat. I*

This reading and discussion course will focus on one or two topics in the history of American foreign relations, usually during the twentieth century, using a variety of primary documents and secondary sources. In recent years the course has focused on U.S. relations with the developing world after World War II, with units on U.S. interventions in Vietnam and Afghanistan. The role of science and technology as part of international development programs is a common theme. This course is excellent preparation for any of WPI's overseas project centers.

HI 1314. INTRODUCTION TO EARLY AMERICAN HISTORY.*Cat. I*

An introduction to historical analysis through selected periods or themes in the history of America before the Civil War. A variety of readings will reflect the various ways that historians have attempted to understand the development of America.

HI 1322. INTRODUCTION TO EUROPEAN HISTORY.*Cat. I*

This course introduces students to the major currents that have defined modern European History. Themes and topics will vary and may include the philosophical impact of science on modern thought, the development of liberalism and socialism, the crisis of culture in the twentieth century. Students read selections on major episodes in European history and develop their skills in critical thinking, analysis, oral and written argument. No prior knowledge of European history is required.

Some sections of this course may be offered as Writing Intensive (WI).

HI 1330. INTRODUCTION TO THE HISTORY OF SCIENCE AND TECHNOLOGY.*Cat. I*

An introduction to the questions, methods and source materials that shape historical studies of science and technology. Sections vary in content and emphases; some may explore the interplay of science and technology across time, while other sections might exclusively develop themes within either the history of science or the history of technology. Students can receive credit only once for HI 1330, 1331, or 1332.

HI 1350. INTRODUCTION TO ENVIRONMENTAL HISTORY.*Cat. I*

An introduction to the questions, methods, and source materials that shape historical studies of the environment. This course will explore the influence of nature (i.e., climate, topography, plants, animals, and microorganisms) on human history and the reciprocal influence of people on nature.

HI 2310. TOPICS IN URBAN HISTORY.*Cat. I*

This course surveys the interplay of social, economic, demographic, political and cultural forces in shaping the growth, decline and occasional rebirth of urban spaces. Emphasis is placed upon building chronological narratives while attending to the themes, approaches, and sources historians use to reconstruct the tangled infrastructures, stratified economies, segregated spaces and political/administrative structures of cities. Geographies will vary across sections and topics may include Industrializing Cities, Race and Urban Space, Post-Industrial Cities, Urban Technological Infrastructures, or Social Justice in the City.

Students can receive credit only once for HI 2310.

HI 2311. AMERICAN COLONIAL HISTORY.*Cat. I*

This course surveys early American history up to the ratification of the Constitution. It considers the tragic interactions among Europeans, Indians, and Africans on the North American continent, the growth and development of English colonies, and the revolt against the Empire that culminated in the creation of the United States of America.

HI 2313. AMERICAN HISTORY, 1789-1877.*Cat. I*

This course surveys American history from the Presidency of George Washington to the Civil War and its aftermath. Topics include the rise of American democracy, the emergence of middle-class culture, and the forces that pulled apart the Union and struggled to put it back together.

HI 2314. AMERICAN HISTORY, 1877-1920.*Cat. I*

This course surveys the transformation of the United States into an urban and industrial nation. Topics will include changes in the organization of business and labor, immigration and the development of cities, the peripheral role of the South and West in the industrial economy, politics and government in the age of "laissez-faire," and the diverse sources and nature of late 19th- and early 20th-century reform movements.

HI 2315. THE SHAPING OF POST-1920 AMERICA.*Cat. I*

This course surveys the major political, social, and economic changes of American history from 1920 to the present. Emphasis will be placed on the Great Depression, the New Deal, suburbanization, McCarthyism, the persistence of poverty, the domestic effects of the Vietnam war, and recent demographic trends.

HI 2316. TWENTIETH CENTURY AMERICAN FOREIGN RELATIONS.*Cat. II*

This survey of American diplomatic history begins with World War I and World War II, continues through the early and later Cold War periods, including the Vietnam War, and concludes with an overview of 9/11 and wars in Iraq and Afghanistan. It includes traditional political and diplomatic history, but also broader conceptions of American foreign relations such as culture, economic development, and environment. It addresses the question of American empire, and stresses understanding U.S. policy and actions through a broad international perspective. This course is excellent preparation for any of WPI's overseas project centers.

Some sections of this course may be offered as Writing Intensive (WI).

This course will be offered in 2020-21 and in alternating years thereafter.

HI 2318. TOPICS IN LAW, JUSTICE AND AMERICAN SOCIETY.*Cat. I*

This course treats law as a powerful social, economic and political phenomenon that cannot be fully understood apart from its history. Through a focus upon a particular theme and chronology, each section surveys the role of law (constitutional, statutory, regulatory and common) and legal institutions in shaping American society and culture, as well as how the law and its institutions have been shaped by individuals, advocacy groups, and broader social, cultural and political forces. Different sections of this course might explore constitutional law and social change (e.g. civil rights, abortion, and same sex marriage); criminal law and mass incarceration; law and the construction of race; law and gender; or patents, copyrights and intellectual property. This course may be repeated for different topics, and students who took HI 2317 may take HI 2318.

HI 2320. MODERN EUROPEAN HISTORY.*Cat. I*

A survey of the major developments in European history from the nineteenth century to the present. The course will focus upon those factors and events that led to the formation of modern European society: revolutions, nationalism, industrialization, world wars, the Cold War, the creation of the European Union. No prior knowledge of European history is required. Especially appropriate for students interested in WPI's global Project Centers in Europe.

Students may not receive credit for HI 2320 and HI 2322.

HI 2324. THE BRITISH EMPIRE.*Cat. I*

This course provides a survey of the British Empire from the 18th century to the present. Topics include the formation of a multinational British state; slavery, sugar, and empire; rebellion in the Americas; settlement of Australia and New Zealand; imperial expansion and resistance in India, China and Southern Africa; industrialization and global trade; cultural dimensions of the colonial experience; gender and empire; world wars and decolonization; and reconfigurations of a global Britain. Especially appropriate for students interested in projects centers located in Britain or the former British Empire.

No prior knowledge required.

HI 2328. HISTORY OF REVOLUTIONS IN THE TWENTIETH CENTURY.*Cat. II*

A survey of some of the most important revolutionary movements of the twentieth century. We may consider topics such as racial, nationalist, feminist and non-violent revolutionary ideologies, communist revolution, the "green" revolution and cultural revolution. No prior knowledge of the history of revolutions is expected.

This course will be offered in 2019-20, and in alternating years thereafter.

HI 2335. TOPICS IN THE HISTORY OF AMERICAN SCIENCE AND TECHNOLOGY.*Cat. I*

This course surveys the interplay of science, technology and culture in American national development. Emphasis is placed upon building chronological narratives while attending to the themes, approaches, and sources historians use to explore Americans' enthusiastic but sometimes controversial embrace of science and technology. Chronologies and themes will vary across sections covering topics such as Science, Technology and Culture in Early America; Science, Technology in Industrializing America; Science and Technology in Post-1945 America; and Technology and Culture in the Rise of Urban America. This course may be repeated for different topics. No prior coursework or background in the history of science and technology is required.

HI 2341. CONTEMPORARY WORLD ISSUES IN HISTORICAL PERSPECTIVE.*Cat. II*

This course examines the historical origins of contemporary global crises and political transformations. Students keep abreast of ongoing current events through periodical literature and explore the underlying long-term causes of these events as analyzed by scholarly historical texts. Topics will vary each time the course is taught but may include such topics as the following: The Israeli-Palestinian Conflict, Democratization in Africa, the Developing World and Globalization. No prior knowledge of world history is required.

This course will be offered in 2019-20, and in alternating years thereafter.

HI 2343. EAST ASIA: CHINA AT THE CENTER.*Cat. II*

This course will explore two thousand years of Asian participation in an international system, in Asia and with the rest of the world. Whether ruled by Chinese, Turks, Mongols or Manchus, China has been the political and cultural center of East Asia. Understanding the role of this superpower is critical to Asian and world history. The course will focus on themes such as the cosmopolitan experience, the early development and application of 'modern' ideas such as bureaucracy, market economy, and paper currency, and the centrality of religious ideology as a tool in statecraft. No prior knowledge of Asian history is required.

This course will be offered in 2020-21, and in alternating years thereafter.

HI 2350. TOPICS IN THE HISTORY OF SCIENCE.*Cat. I*

This course surveys the major developments, research enterprise, controversies and cultural contexts of particular scientific fields while also engaging students in examining the questions, methods and sources that inform the history of science. Sections will vary in topic, focusing on the history of a subset selected from among the following fields: astronomy, cosmology, mathematics, biology, medicine, ecology, evolutionary ideas, the earth sciences, chemistry, physics, or the human sciences. This course may be repeated for different topics. No prior coursework or background in the history of science is required.

HI 2400. TOPICS IN ENVIRONMENTAL HISTORY.*Cat. I*

This course surveys the methods and sources that historians adopt to answer three questions central to environmental history: How have constantly changing natural environments shaped the patterns of human life in different regions? How have different human cultures perceived and attached meanings to the natural and built worlds around them, and how have those attitudes shaped their social, economic political, and cultural lives? Finally, how have people altered the world around them, and what have been the consequences of change for natural and human communities alike? Sections will vary in content and emphases alternating between North American, regional, or global approaches. This course may be repeated for different topics. No prior coursework or background in environmental history is required.

HI 2913. CAPITALISM AND ITS DISCONTENTS.*Cat. II*

This course focuses on modern capitalism as an economic, social, and cultural formation in global perspective. As capitalism has radically changed the way humans live and work, critics have articulated their various discontents. Topics to be discussed include colonialism, enslavement, industrialization, social movements, automation, climate change, and global inequality. In addition to our readings, students will directly engage with the rich materials on global labor history available at WPI and in Worcester. This course will be offered in 2021-22, and in alternating years thereafter.

HI 2921. TOPICS IN MODERN EUROPEAN HISTORY.*Cat. II*

This seminar course examines topics in the cultural, socio-economic and political history of modern Europe. Topics may vary each year among the following: sport and society, film and history, nationalism, gender and class, political economy, environmental history. Readings will include primary and secondary sources. No prior background is required.

Students may not receive credit for both HI 3321 and HI 2921.

This course will be offered in 2019-20 and in alternating years thereafter

HI 2930. TOPICS IN LATIN AMERICAN HISTORY.*Cat. II*

This seminar course examines topics in the history of Latin America. It bases those topics on issues in the region that are of critical importance in the present, and it outlines the historical origins and interrogates the historical contexts of those issues. Topics and course materials may vary each year depending on the issues addressed. The broad themes with which these topics may engage include: science, technology, and development; energy, sustainability, and the environment; inequality and social justice; migration and mobility; U.S.-Latin American relations; democracy, populism and nationalism; the Cold War and the post-Cold War global order. Readings will include primary and secondary sources. No prior background is required.

Recommended background: None.

This course will be offered in 2021-22 and in alternating years thereafter.

HI 3312. TOPICS IN AMERICAN SOCIAL HISTORY.*Cat. I*

A seminar course on analysis of selected aspects of social organization in American history, with emphasis on the composition and changing societal character of various groups over time, and their relationship to larger social, economic, and political developments. Typical topics include: communities, families, minorities, and women.

Suggested background: Some college-level American history.

HI 3314. THE AMERICAN REVOLUTION.*Cat. I*

This seminar course considers the social, political, and intellectual history of the years surrounding American independence, paying particular attention to the changes in society and ideas that shaped the revolt against Great Britain, the winning of independence, and the creation of new political structures that led to the Constitution.

HI 3316. TOPICS IN TWENTIETH-CENTURY U.S. HISTORY.*Cat. II*

In this advanced seminar course, students will explore one aspect of twentieth-century U.S. history in more depth. Topics vary each year but may include political movements such as the New Deal or the Civil Rights Movement, an aspect of American foreign policy such as the Cold War, a short time period such as the 1960s, a cultural phenomenon such as consumption, or a geographical focus such as cities or New England. The course will require substantial reading and writing. Suggested background: HI 2314 (American History, 1877-1920), HI 2315 (The Shaping of Post-1920 America), or other American history courses.

This course will be offered in 2019-20, and in alternating years thereafter.

HI 3317. TOPICS IN ENVIRONMENTAL HISTORY.*Cat. II*

In this seminar course, students will explore one aspect of U.S. or global environmental history in more depth. Topics vary each year but may include environmental thought, environmental reform movements, comparative environmental movements, natural disasters, the history of ecology, built environments, environmental justice, New England environmental history, or the environmental history of South Asia or another region of the world. The course will require substantial reading and writing. Suggested background: HI 2401 U.S. Environmental History.

This course will be offered in 2020-21, and in alternating years thereafter.

HI 3331. TOPICS IN THE HISTORY OF EUROPEAN SCIENCE AND TECHNOLOGY.*Cat. II*

A seminar course on the relationships among science, technology, and society in European culture, examined through a series of case studies. Topics from which the case studies might be drawn include: global scientific expeditions, mapmaking, and European imperialism; the harnessing of science for industrial purposes; the role of the physical sciences in war and international relations; the

function of the science advisor in government; the political views and activities of major scientists such as Einstein. Students will use primary sources and recently published historical scholarship to analyze the case studies.

Suggested background: Courses in European history and the history of science and technology.

This course will be offered in 2020-21, and in alternating years thereafter.

HI 3334. TOPICS IN THE HISTORY OF AMERICAN SCIENCE AND TECHNOLOGY.*Cat. I*

This seminar will examine a particular issue or theme in the history of American science and technology. Topics will vary from year to year, but may include: technology and the built environment; science, technology and the arts; communications of science and scientific issues with the larger public; technology and scientific illustration; science in popular culture; science and the law; or close examination of episodes in the history of American science and technology such as the American Industrial Revolution; science and technology in the years between the world wars; the Manhattan Project; science and the culture of the Cold War; or science, technology and war in American history. This course will require significant reading and writing.

Suggested background: Some familiarity with history of science or history of technology, and with United States history.

HI 3335. TOPICS IN THE HISTORY OF NON-WESTERN SCIENCE AND TECHNOLOGY.*Cat. II*

A seminar course on the relationships among science, technology, and society from cultures outside Europe and North America, examined through a series of case studies. Topics from which the case studies might be drawn include: Chinese medicine and technology; Arabic mathematics, medicine, and astronomy; Indian science and technology (including, for example, metalworking and textile production); Mayan mathematics and astronomy; Polynesian navigation; various indigenous peoples' sustainable subsistence technologies (e.g. African agriculture, Native American land management, aboriginal Australian dreamtime).

Suggested background: Courses in global history and the history of science and technology.

This course will be offered in 2019-20, and in alternating years thereafter.

HI 3341. TOPICS IN IMPERIAL AND POSTCOLONIAL HISTORY.*Cat. II*

This seminar course examines topics in the history of European imperialism, colonialism, and the postcolonial aftermath. Topics vary each year among the following: culture and imperialism, the expansion of Europe, the economics of empire, travel and exploration narratives, imperialism in literature and anthropology, decolonization in Asia and Africa, postcolonial studies. Readings will include primary and secondary sources.

This course will be offered in 2020-21, and in alternating years thereafter.

HI 3343. TOPICS IN ASIAN HISTORY.*Cat. I*

This seminar course examines topics in the cultural, socio-economic, religious and political history of East Asia. Topics vary each year and may include the following: nationalism and the writing of history, travel and exploration narratives, cross-cultural contact, the role of religion and ideology in political history, development and the environment in Asia, film and history, and the place of minorities and women in Asian societies. Suggested background: previous courses on Asia such as HU 1412, HI 2328, HI 2343, or RE 2724.

Some sections of this course may be offered as Writing Intensive (WI).

HI 3344. PACIFIC WORLDS.*Cat. II*

The Pacific Ocean covers a third of our earth's surface. Home to over a thousand languages and thousands of years of rich histories, the Pacific has been and continues to be one of the most diverse regions of cultural, social, economic, and environmental interaction. The course focuses on both local connections to the Pacific, such as the New England whaling industry, and global issues, such as the impact of climate change on Pacific islanders. Other topics to be discussed include the environment, oceanic navigation, arts, colonialism, race, and migration.

This course will be offered in 2020-21, and in alternating years thereafter.

HUMANITIES (HU)

The courses listed below are general humanities courses and are intended to provide conceptual introductions to the major disciplines within the humanities. Students will encounter the basic methods of critical analysis and discussion required for the future investigation of the specific area they choose for their humanities and arts requirement. These courses emphasize patterns of thought, methods of inquiry, appropriate vocabulary, and critical attitudes needed to appreciate most fully various areas in the humanities; they are not intended as surveys or historical overviews. Consequently, in each course the subject matter used to develop and illustrate key concepts and approaches will change regularly. Practice in analytic thinking and writing will be a significant part of each course. The skills generated by these courses will greatly aid students in developing their themes and will be essential for the completion of the Humanities and Arts Requirement.

HU 1222. INTRODUCTION TO MEDICAL HUMANITIES.

Cat. II

How do medicine, disease, health, and healing shape our experience of what it is to be human? What do literature, poetry, popular culture, or religious and spiritual traditions have to do with modern medical practices and institutions? This course provides an introduction to the interdisciplinary field of medical humanities, and its core set of concepts, questions, methodologies, and theoretical frameworks. The course will bring together and familiarize students with work from diverse fields of study, including comparative literature, the visual and performing arts, history of medicine, cultural studies, science and technology studies, anthropology, ethics, and philosophy. Potential course topics include the production and circulation of medical knowledge, embodied experiences of illness and affliction, cross-cultural perspectives on sickness and healing, the social and interpersonal dimensions of illness, illness and medicine in popular culture, and the ways in which humanistic inquiry can enhance and improve contemporary medical practices.

This course will be offered in 2020-21, and in alternating years thereafter.

HU 1411. INTRODUCTION TO AMERICAN STUDIES.

Cat. II

This interdisciplinary course introduces students to a number of basic American Studies methodologies. Emphasis will vary according to the instructor, but usually the course will cover the following: the textual and contextual analysis (at the community, national, and transnational levels) of literary works; the relationships between the literary, performing, and visual arts in a specific time period; the analysis of radio, film, television, and digital media forms at the level of production and reception; the mediation and remediation of cultural, social, and political history.

This course will be offered in 2019-20, and in alternating years thereafter.

HU 1412. INTRODUCTION TO ASIA.

Cat. I

This course will explore Asia through an interdisciplinary approach. We will examine tradition and modernity in some or all of four cultural regions—South Asia (India), East Asia (China), Southeast Asia (Vietnam or Thailand), Inner Asia (Tibet)—and globalization in Japan and/or Hong Kong. We will explore the cultural traditions of these various regions, paying special attention to history, religion, society. We will also consider modern developments in these same regions. The impact of colonialism, nationalism, revolution, industrialization and urbanization on the lives of Asian peoples will be illustrated through films and readings. No prior knowledge of Asian history or culture is expected.

HU 1500. INTRODUCTION TO GENDER, SEXUALITY & WOMEN'S STUDIES.

Cat. II

This foundational course offers an introduction to the interdisciplinary field of gender, sexuality and women's studies. The course fosters critical examination of gender, sexuality and women and asks how the interlocking systems of oppression, including colonialism, racism, sexism, homophobia, transphobia, and ethnocentrism, shape people's lives, and how individuals and groups have worked to resist these oppressions. Potential course topics include histories of gender activism, gender, sexuality and their relationships to the law, religion, reproduction, education, technology, and mental health, globalization and transnational experiences, and the role of popular culture. No prior background is required.

This course will be offered in 2020-21, and in alternating years thereafter.

HU 2222. TOPICS IN MEDICAL HUMANITIES.

Cat. II

Topics in Medical Humanities provides students with opportunities to investigate the human (cultural, religious, historical, philosophical) dimensions of medicine, illness, and healing, from various perspectives in the humanities. Specific themes and topics will vary by section and instructor, and may include both historical and contemporary concerns, consideration of local, national, and/or global scales, and interdisciplinary methods and pedagogies drawn from a range of fields, such as comparative literature, the visual and performing arts, history of medicine, cultural studies, science and technology studies, anthropology, ethics, and philosophy. Students will analyze interactions between human beings and their environments, the production and circulation of medical and psychiatric knowledge, and historical, sociological, artistic, and literary considerations of medicine, health, and healing.

This course will be offered in 2020-21, and in alternating years thereafter.

HU 2251. INTRODUCTION TO FILM STUDIES.

Cat. II

This course provides an introductory window into the history and theory of film, and may cover genres from short films, silent films, animated films, documentary films, and experimental films to historical and literary adaptations, science fiction films, screwball comedies, thrillers, and westerns. In addition, attention may be given to representative directors, significant theories of film, national traditions of filmmaking, and recent convergences between film forms and digital media. Directors covered may include Charlie Chaplin, John Ford, and Alfred Hitchcock. Film theorists covered may include Stanley Cavell, Sergei Eisenstein, and Trinh T. Minh-ha.

This course will be offered in 2020-21 and in alternating years thereafter.

Recommended background: None.

HU 2258: WORLD CINEMAS.

Cat. II

This course will examine works of film from multiple continents, drawing on film criticism and theory and attending to the development of film industries in several different cultural contexts and national traditions. Some iterations may turn on a broader survey, others on more particular engagements with wider inflections. For example, an offering emphasizing African film might attend not only to films made on the African continent but also to films emerging from the African diaspora in the Americas, and an offering emphasizing Italian film would also attend not only to the films made on the Italian peninsula but also to films emerging from the Italian diaspora in Australia and the United States. Recommended background: None, though HU 2251: Introduction to Film Studies will serve as useful preparation.

This course will be offered in 2021-2022, and in alternating years thereafter.

HU 2340. POPULAR CULTURE AND SOCIAL CHANGE IN ASIA.

Cat. II

Godzilla, kung-fu, anime, sushi, Hello Kitty, yin and yang, Pokémon, manga. All of these have become part of our American lives, but where did they come from and what meaning do they hold as cultural phenomena? In this class we will explore the popular cultures of East Asia to better understand the influences that have shaped the region's contemporary societies. Focus country will be either Japan or China, depending on term offered. Students will study various media of popular culture, such as films, songs, advertisements, video games, manga, anime, to explore the changing society of these countries. We will link the individual cultural phenomena studied to both internal and external influences, situating popular culture within transnational currents and exchanges when appropriate. No prior knowledge of Asian history is required for this class.

This course will be offered in 2019-20, and in alternating years thereafter.

HU 2501. STEM-INISM.

Cat. II

The study and practice of STEM-inism centers the equal participation and representation of all social groups in the fields of science, technology, engineering, and math (STEM). In particular, this course highlights the concepts, theories, and practices of feminism into its understanding of STEM-inism as a field of inquiry. This course provides an overview of the history of female and non-binary contributors and contributions to this field of study and practice, ranging from Hypatia to Ada Lovelace to NASA visionary Katherine Johnson to queer and trans STEM visionaries Martine Rothblatt, Joan Roughgarden, and Lynn Conway. This course may also consider the following topics: the gender gap in STEM fields, biases in medical research, sexual harassment, eugenics, reproductive justice, transgender rights, and contemporary social movements. The course will also incorporate a deliberate analysis of intersecting identity categories, including race, class, sexuality, religion, and ability.

This course will be offered in 2020-21, and in alternating years thereafter.

HU 2502. GLOBAL FEMINISMS.*Cat. II*

Bringing together transnational, postcolonial, and indigenous feminist and queer lines of thought, this course provides a global perspective on the interdisciplinary field of gender, sexuality, and women's studies. Motivated by the idea that marginalized peoples - including women, those who identify as non-binary, and ethnic, religious, and economic minorities - share common experiences of exclusion and common stories of resistance, this course fosters critical examination of the relationship between gender, sexuality, feminism, colonialism, and racism. It may consider this intersection through case studies from Africa, Asia, Latin America, and the Middle East with particular attention to places that host WPI project centers.

This course will be offered in 2021-22, and in alternating years thereafter.

HU 2900. HUMANITIES AND ARTS PROJECT PREPARATION.*Cat. I (1/6 unit)*

This course is required of students accepted to off-campus Humanities and Arts centers and programs. The course introduces students to methods for site-specific research, project-design, and analysis related to humanities and arts study. It also develops HUA disciplinary skills appropriate both to the projects students have selected and to the culture of the project center where they will be working. Students learn to develop project objectives, milestones, and deliverables in their topic areas related to their forthcoming onsite work and expectations. Students make presentations, write an organized project proposal, and develop a deliverable design for reporting their project findings. This course is a pre-requisite for off-campus Humanities and Arts project center study only.

This credit will not count toward the Humanities and Arts requirement.

Recommended background: none.

HU 3900. INQUIRY SEMINAR IN HUMANITIES AND ARTS.*Cat. I*

This seminar serves as the culmination for a student's Humanities and Arts Requirement. The seminar provides opportunities for sustained critical inquiry into a focused thematic area. The seminar seeks to help students learn to communicate effectively, to think critically, and to appreciate diverse perspectives in a spirit of openness and cooperation through research, creativity, and investigation. The specific theme of each seminar will vary and will be defined by the instructor. Prior to enrolling in the seminar, a student must have completed five courses in Humanities and Arts, at least two of which must be thematically related and at least one of which must be at the 2000-level or above.

HU 3910. PRACTICUM IN HUMANITIES AND ARTS.*Cat. I*

The practicum serves as the culmination for a student's Humanities and Arts Requirement. The practicum provides opportunities for sustained critical inquiry into a focused thematic area. The practicum seeks to help students learn to communicate effectively, to think critically, and to appreciate diverse perspectives in a spirit of openness and cooperation through research, creativity, and investigation. The specific theme of each practicum will vary and will be defined by the instructor. Prior to enrolling in the practicum, a student must have completed five courses in Humanities and Arts, at least two of which must be thematically related and at least one of which must be at the 2000-level or above. Consent of the instructor is required for enrollment.

HU—AAS-50. AMERICAN ANTIQUARIAN SEMINAR.*ISU*

Each fall the American Antiquarian Society and five Worcester colleges sponsor a research seminar at the Antiquarian Society library. The seminar is conducted by a scholar familiar with the Society's holdings in early American history, and the seminar topic is related to his or her field of research.

Selection is highly competitive. The ten participating students are chosen by a screening committee made up of representatives of the five participating colleges: Assumption College, Clark University, College of the Holy Cross, WPI, and Worcester State College.

The seminar topic and research methods combine several disciplines, and students from a wide variety of majors have participated successfully in this unique undergraduate opportunity.

INTERNATIONAL AND GLOBAL STUDIES**INTL 1100. INTRODUCTION TO INTERNATIONAL AND GLOBAL STUDIES.***Cat. I*

An introduction to the main concepts, tools, fields of study, global problems, and cross-cultural perspectives that comprise international and global studies. No prior background is required. Especially appropriate for students interested in any of WPI's global Project Centers.

INTL 1300. INTRODUCTION TO LATIN AMERICA.*Cat. I*

This course reviews the past and present of South America, Central America and the Caribbean through an interdisciplinary approach. It examines historical and contemporary issues related to social mobilization, cultural innovation, political activism, economic development, and environmental sustainability through the critical analysis of books, films, and creative arts from and about the region. It also presents an overview of Latin American relations with other parts of the world through the region's experiences with global culture, migration, imperialism, dependency, and entanglements with the United States. This course is especially appropriate for students who expect to complete their HUA, IQP, and/or MQP at WPI project centers in Latin America. No prior knowledge is expected.

Recommended background: None.

INTL 2100. APPROACHES TO GLOBAL STUDIES.*Cat. I*

This course examines the major theoretical and methodological approaches that characterize global studies. Since the end of the Cold War, new forms of transnational integration, interdependence and conflict have been considered examples of globalization. Yet this period is not the first to undergo such transformation, and the "global" is often experienced in disparate ways around the world. This course examines the diverse ways of understanding globalization in the past and present. No prior background is required. Especially appropriate for students interested in any of WPI's global Project Centers.

INTL 2110. GLOBAL JUSTICE.*Cat. II*

What is justice during an era of globalization? What are the rights and responsibilities of individuals, groups, nations, or supranational organizations in a world of profound inequalities of wealth or disparities of power? This course takes an interdisciplinary approach to historical, literary, religious, and ethical debates about global justice as well as the political and practical responses by various actors in the global South and North. Themes will vary each time the course is taught and may include globalization and distributive justice, climate justice, migration, citizenship, cosmopolitanism, human rights, ideology, reparations, racial or gender equity, nationalism and internationalism, and global democracy. No prior background required.

Recommended background: None.

This course will be offered in 2020-21, and in alternating years thereafter.

INTL 2310. MODERN LATIN AMERICA.*Cat. II*

This course uses interdisciplinary, thematic, and case study approaches in the examination of modern Latin America. It draws from the Latin America's diversity to explore topics in the past and present that are critical for students' development of a more advanced understanding of the region and its residents. The course may include the study of topics such as cultural production, nationalism, urban and rural development, migration, social and racial inequality, democracy, and social justice through the disciplines of history and global studies, literature and creative arts, social sciences, environmental studies, and others. Examples and case studies from the nineteenth, twentieth, and twenty-first centuries will be drawn especially from locations in Latin America where WPI maintains Global Project Centers.

Students may not receive credit for both INTL 221X and INTL 2310.

This course will be offered in 2020-21 and in alternating years thereafter.

INTL 2410. MODERN AFRICA.*Cat. II*

This interdisciplinary course takes a thematic approach to modern Africa. Topics and themes will vary each time the course is taught, and may include African kingdoms, the influence of Islam, the legacy of the Atlantic slave trade, imperialism and decolonization, democratization, the politics of language, or African literature and art. Examples and case studies will include locations where

WPI has programs in this diverse and dynamic region. No prior background required.

Students may not receive credit for both INTL 2410 and HU 2441.

Recommended background: None.

This course will be offered in 2021-22, and in alternating years thereafter.

INTL 2420. MIDDLE EAST, NORTH AFRICA AND MEDITERRANEAN.

Cat. I

This interdisciplinary course takes a thematic approach to the Middle East, North Africa and Mediterranean region. Themes and topics will vary each time the course is taught, and may include religion and culture, national, ethnic and linguistic identities, the Mediterranean as a contact zone, U.S. political and economic involvement in the region, postcolonialism, war and conflict, migration, forced displacement and refugees, human rights, religious freedom, popular culture, the politics of Islam and secularism, the regional intersections of Judaism, Christianity, and Islam, representations of Islam and other religions in visual culture, gender and media, and the circulation of U.S. culture. Examples and case studies will include locations where WPI has programs in this diverse and dynamic region. No prior background required.

Recommended background: None.

INTL 2510. CONTEMPORARY EUROPE: UNION AND DISUNION.

Cat. II

This interdisciplinary course takes a thematic approach to contemporary Europe, especially since the establishment of European Union's single market and common currency. Topics and themes will vary each time the course is taught and may include expansion of the EU and Euro, the impact of the free movement of goods, capital, services and people, migration and refugees, populist and nationalist movements, uneven development between regions within Europe, postcolonial relations with other parts of the world, and debates over national heritage and cultural change. Examples and case studies will include locations where WPI has programs in Europe. No prior background is required.

Recommended background: None.

This course will be offered in 2020-21, and in alternating years thereafter.

INTL 2520. RUSSIA READY: LANGUAGE AND CULTURAL CONTEXT.

Cat. II (1/6 unit)

This course will introduce students to the fundamentals of Russian language, current events and culture. Students will be expected to steadily build essential vocabulary, learn basic grammar and forms of address; they will also review major events of Russian history from the rule of Peter the Great to the Russian Revolution and the Soviet era developments - all of which are key to understanding of Russia today. All through the course, students will have assigned media topics ranging from the student life in Russia, to aerospace exploration to agricultural breakthroughs and political turmoil. Materials under study will include Russian language textbooks and grammar guides, current media, and film. This course is appropriate for students interested in all WPI's project centers in Eastern and Central Europe.

This course will be offered in on-line format.

Students may not receive credit for HU 2230 or HU 223X and INTL 2520.

INTL 2910. TOPICS IN GLOBAL STUDIES.

Cat. I

This seminar course takes an interdisciplinary approach to historical and contemporary topics in global studies. Topics vary each year and may include international development, global inequality and justice, global public health, war and terrorism, international organizations and governance, humanitarianism and human rights, travel and tourism, the Anthropocene, climate change. No prior background is required. Especially appropriate for students interested in any of WPI's global Project Centers.

INTL 3050. GLOBAL RE-ENTRY SEMINAR.

Cat. I (1/6 unit)

Global projects are often life-changing and many students want to make sense of their experience and deepen global learning after returning to campus. This course provides opportunities for self-reflection about global experiences, for connecting with peers to share stories, and for translating these experiences into skills and future professional opportunities, which may include internships, scholarships, post-graduate study or employment. Students completing this seminar will have reflected on their global experiences, articulated and identified transferable skills garnered while away, and integrated these reflections into future academic plans, personal aspirations, or career goals.

Recommended background: This course is intended for students who have participated in WPI's global programs, including global IQPs, MQPs, Humanities projects, or exchange programs, either in the US or abroad.

INTL 4100. SENIOR SEMINAR IN INTERNATIONAL AND GLOBAL STUDIES.

Cat. I

In this capstone seminar in International and Global Studies, students will reflect on what they learned in previous global experiences and critically analyze contemporary global issues. The seminar aims to develop habits of lifelong learning as students articulate strategies for translating global experiences and expertise into personal values and professional opportunities in their future careers.

MUSIC (MU)

MU 1511. INTRODUCTION TO MUSIC.

Cat. I

This course, designed for students who have little or no previous experience in music, will present an approach to the study of music that includes studying some concepts of music theory (rhythms, scales, keys, intervals, harmony). The course will also include a study of some of the great masterpieces through listening, reading, and discussion.

Recommended background: No previous experience is necessary.

MU 1611. FUNDAMENTALS OF MUSIC I.

Cat. I

This course concentrates on basic music theory of the common practice period. If time permits, instruction includes ear training, sight singing, and work on scales and intervals.

Recommended background: basic knowledge of reading music.

MU 2300. FOUNDATIONS OF MUSIC TECHNOLOGY.

Cat. II

This course will present ways to facilitate musicianship through the use of technology. Course topics include an introduction to music notation software, MIDI and audio recording, signal processing, and interactive music system programming. The course will address past, current, and emerging trends in music technology as they relate to facilitating an understanding of musical concepts. Students may not receive credit for both MU 2300 and MU 230X.

Suggested background: a basic understanding of music notation and the fundamentals of music.

This course will be offered in 2020-21, and in alternating years thereafter.

MU/PSY 2501. MUSIC AND MIND.

Cat. I

How are we able to distinguish instruments, timbres and rhythms from the intertwined sonic stream presented by the world? How do we organize these elements in time to create rhythms, melodies, phrases and pieces? How do perception and memory contribute to our understanding and navigation of a musical work? We will explore these questions by considering the cognitive and perceptual processes that shape our musical experience. Topics covered will include event distinction, temporal perception, hierarchical organization, perceptual grouping, expertise, memory and categorization. Psychological Ideas will be musically illustrated through close listening exercises involving a variety of musical works. We will consider how psychological principles are applied to music technologies, such as compression algorithms, mixing methodologies and the field of music information retrieval. We will consider experimental methods that purport to further our understanding of musical experience.

Recommended Background: Fundamentals of Music I and/or Fundamentals of Music II

MU 2611. FUNDAMENTALS OF MUSIC II.

Cat. I

Fundamentals II is a course on music theory at the advanced level beginning with secondary dominants and modulations and working through 19th-century chromatic harmony.

MU 2719. JAZZ HISTORY.

Cat. II

Through an introduction to the musical contributions of Louis Armstrong, Duke Ellington, Charlie Parker, Miles Davis and others, students are exposed to the chronological development of the language of jazz. Each jazz era is examined in detail including the musical and social contexts which helped define it. Participants are expected to build aural skills with the goal of identifying specific historical periods through the recognition of particular musical characteristics. Students examine in depth one artist of their choice.

This course will be offered in 2020-21, and in alternating years thereafter.

[This replaces MU 4623. Credit is not allowed for both MU 4623 and MU 2719.]

MU 2720. MUSIC HISTORY I: MEDIEVAL THROUGH THE BAROQUE.*Cat. II*

This course provides a historical survey of Western music from Medieval through Baroque periods with an emphasis on understanding stylistic traits and theoretical concepts of the eras. Topics include Gregorian chant and secular monophony; evolution of musical notation; development of polyphonic music; and vocal and instrumental genres such as mass, motet, madrigal, opera, cantata, sonata, and concerto, among others.

No prior background in music is necessary.

This course will be offered in 2020-21, and in alternating years thereafter.

MU 2721. MUSIC HISTORY II: CLASSICAL TO THE PRESENT.*Cat. I*

This course provides a historical survey of Western music from the Classical period to the present with an emphasis on understanding stylistic traits and theoretical concepts of the eras. Topics include the development of genres such as sonata, string quartet, concerto, symphony, symphonic poem, character piece, Lied, and opera; and 20th century trends of impressionism, primitivism, atonality, serialism, minimalism, aleatory music, and electronic music.

No prior background in music is necessary.

MU 2722. HISTORY OF AMERICAN POPULAR MUSIC.*Cat. I*

This course will explore the uniqueness of America's popular music and its origins in the music of Africa and the folk music of Europe. Particular emphasis will be given to the origins and history of rock 'n' roll examining its roots in blues and early American popular music. [This replaces MU 4625. Credit is not allowed for both MU 4625 and MU 2722.]

MU 2723. MUSIC COMPOSITION.*Cat. I*

This course will investigate the sonic organization of musical works and performances, focusing on fundamental questions of unity and variety. Using a progressive series of composition projects, the class will examine aesthetic issues that are considered in the pragmatic context of the instructions that composers provide to achieve a desired musical result. The class will examine the medium of presentation - whether these instructions are notated in prose, as graphic images, or in symbolic notation. Weekly listening, reading, and composition assignments draw on a broad range of musical styles and intellectual traditions, from various cultures and historical periods.

The class will meet for two weekly sessions of one hour and fifty minutes. Each student will be assigned a performance ensemble. Each performance ensemble will have a weekly two-hour lab. In addition, each student will keep a weekly log (online) of his or her experiences as a composer.

MU 2730. JAZZ THEORY.*Cat. I*

This course examines harmonic and melodic relationships as applied to jazz and popular music composition. Students are introduced to a wide range of jazz improvisational performance practices. Topics include compositional forms, harmonic structures, major and minor keys, blues, modal jazz, and re-harmonization techniques. Students are expected to have a basic knowledge of reading music. [This replaces MU 4624. Credit is not allowed for both MU 4624 and MU 2730.]

MU 2801. MAKING MUSIC WITH MACHINES.*Cat. II*

This course will explore automatic mechanical (electro)acoustic instruments, the people that design and build them and the music that they make. The subject is inherently interdisciplinary, so activities will engage with historical, musical, and technical matters. The history of automatic mechanical instruments reaches back centuries: we will study past designs so that we can better contextualize modern efforts, which have progressed alongside increasing computational power and machine sensing abilities. We will consider the music that has been composed using such instruments including the works of Anthonel, Nancarrow, Ligeti, Gann, and Metheny. In doing so, we will develop analytical tools required to understand such music and will illuminate relationships between electromechanical capabilities and musical ideas. The technical components of this course will introduce students to principles involved in instrument design, actuators, electronic circuits, microcontrollers, and musical programming environments. We will do all of this with our mind open to the question of how we can design new machines to make new kinds of music.

Recommended Background: Fundamentals of Music I and / or Fundamentals of Music II, experience with programming and electronic circuits is helpful.

This course will be offered in 2020-21, and in alternating years thereafter.

MU 3001. WORLD MUSIC.*Cat. II*

This course introduces students to selected musical cultures of the world, e.g., Africa, Asia, the Middle East, and Latin America, from the ethnomusicological perspective by examining their musical styles as well as cultural and social contexts. Students will be expected to read materials in interdisciplinary areas, including musical ethnographies.

No prior background in music is necessary.

This course will be offered in 2019-20, and in alternating years thereafter.

MU 3002. ARRANGING AND ORCHESTRATION.*Cat. I*

Students will study specific characteristics of instruments and the voice to enable them to successfully arrange vocal and instrumental music. Students will need to possess a basic knowledge of music theory. Suggested background for this course is MU 1611 (Fundamentals of Music I) or its equivalent.

MU 3614. TOPICS IN MIDI.*Cat. II*

This course examines topics in Music Technology in which the application of MIDI and MIDI systems play a significant role. Topics may vary each year among the following areas: sequencing, live performance, composition, and film scoring. Students can take MU 3614 only one time for credit, but a student interested in taking another version can take a second one as an ISU.

Recommended background: MU 1611 (Fundamentals of Music)

This course will be offered in 2020-21, and in alternating years thereafter.

MU 3615. TOPICS IN DIGITAL SOUND.*Cat. II*

This course examines topics in Music Technology in which Digital Sound plays a significant role. Topics may vary each year among the following areas: digital editing, audio recording, film scoring, game audio, sound effects, audio production, theatrical sound, and surround sound. Students can take MU 3615 only one time for credit, but a student interested in taking another version can take a second one as an ISU.

Recommended background: MU 1611 (Fundamentals of Music)

This course will be offered in 2020-21, and in alternating years thereafter.

MU 3616. TOPICS IN INTERACTIVE PROGRAMMING.*Cat. II*

This course examines topics in Music Technology in which Interactive Programming plays a significant role. Topics may vary each year among the following areas: real time performance controllers, algorithmic composition, interface design, sensor technology, and gesture detection.

Students can take MU 3616 only one time for credit, but a student interested in taking another version can take a second one as an ISU.

Recommended background: MU 1611 (Fundamentals of Music)

This course will be offered in 2020-21, and in alternating years thereafter.

MU 3620. ELECTRONIC MUSIC COMPOSITION.*Cat. II*

This course will address concepts of composition through the use of technology. Students will examine existing compositions in electronic music, art music, popular music, film, multimedia, games, and more, and compose new works within these genres. Students will present newly composed works each class and discuss their aesthetic values, musical functions, and technical underpinnings. Students may not receive credit for both MU 3620 and MU 362X.

Suggested background: knowledge of basic musicianship skills such as melody, harmony, and rhythm, as well as familiarity with at least one digital audio workstation or notation software.

This course will be offered in 2020-21, and in alternating years thereafter.

MU 4621. INDEPENDENT INSTRUCTION (LESSONS) IN MUSIC.*ISU*

Students electing to complete their Humanities and Arts Requirement in music may, for one of their five courses, undertake 1/3 unit (normally at 1/12 unit per term) of private vocal or instrumental instruction. (Supplemental ensemble work is also strongly recommended.) The student must receive prior approval by a member of the WPI music faculty, and the instruction must be beyond the elementary level. Lessons involve a separate fee. Note that the maximum of 1/3 unit credit for lessons may be earned in addition to 1/3 unit credit for performance (see condition A or B below). Additional work, either in performance or lessons, may be acknowledged on the WPI transcript but will carry no WPI credit. Private lessons: voice, piano, organ, winds, brass, strings, and percussion.

MUSIC ENSEMBLES (MU)

Students who sing or play a traditional band or orchestra instrument at the intermediate level or better may enroll for any of the ensembles listed below. Students will register at the beginning of A term and receive 1/6 unit at the end of B term for participation in both terms. Students may also register at the beginning of C term and receive 1/6 unit at the end of D term for participation in both terms. Students may apply up to 1/3 unit of performing ensembles to the Humanities and Arts course requirement.

MU 2631. GLEE CLUB.

Cat. I

The Glee Club is one of WPI's choral ensembles and the oldest student organization on campus. Glee Club performs many styles and periods of the vast repertoire of music featuring tenor and bass voices. Several times each year the Glee Club and Alden Voices (soprano and alto voices) join forces as the WPI Festival Chorus to perform major works of the repertoire. The Glee Club regularly performs on campus, throughout the Worcester area, and takes international and domestic tours. Rehearsals are held weekly. No audition is required. The course is open to all who are interested and sing in the tenor and bass range.

MU 2632. ALDEN VOICES.

Cat. I

Alden Voices is one of WPI's choral ensembles and also functions as a student organization on campus. Alden Voices performs many styles and periods of the vast repertoire of music featuring soprano and alto voices. Several times each year the Alden Voices and the Glee Club (tenor and bass voices) join forces as the WPI Festival Chorus to perform major works of the repertoire. Alden Voices regularly performs on campus, throughout the Worcester area, and takes international and domestic tours. Rehearsals are held weekly. No audition is required. The course is open to all who are interested and sing in the soprano and alto range.

MU 2633. BRASS ENSEMBLE.

Cat. I

The Brass Ensemble performs frequently on campus and on tour and is open to students who perform on trumpet, trombone, euphonium, French horn, tuba, or tympani. Renaissance antiphonal music is included in the repertoire. Rehearsals are held weekly. Students are expected to perform with the ensemble and to know how to read music. Permission of the instructor is necessary to register.

MU 2634. JAZZ ENSEMBLE.

Cat. I

The Jazz Ensemble performs frequently on campus and on tour and plays jazz arrangements written for a small ensemble with major emphasis on improvisation. Rehearsals are held weekly. Students are expected to perform with the ensemble and to know how to read music. Permission of the instructor is necessary to register.

MU 2635. STAGE BAND.

Cat. I

The Stage Band performs traditional and contemporary big band literature with an emphasis on stylistically appropriate interpretation and performance practice. The ensemble performs frequently on campus and on tour. Rehearsals are held weekly. Students are expected to perform with the ensemble and to know how to read music. Permission of the instructor is necessary to register.

MU 2636. CONCERT BAND.

Cat. I

The Concert Band is a large ensemble that performs several concerts a year as well as on tour. Membership is open to those who play traditional wind, brass or percussion instruments. Rehearsals are held weekly. Students are expected to perform with the ensemble and to know how to read music.

MU 2637. STRING ENSEMBLE.

Cat. I

The String Ensemble performs music for string orchestra both on campus and on tour. Members of the string ensemble also comprise the string section of the full orchestra. Rehearsals are held weekly. Students are expected to perform with the ensemble and to know how to read music.

MU 2638. CHAMBER CHOIR.

Cat. I

The Chamber Choir is WPI's smaller, audition-based, choral ensemble. This ensemble explores specific stylistic techniques as pertains to the music of the Renaissance, Baroque, twentieth century, jazz, and extended vocal techniques (electronic, digital and experimental). The ensemble meets weekly. Students are expected to be of the highest vocal caliber and should possess advanced sight-reading techniques. Open to all who are interested. Permission of the instructor is necessary to register.

PHILOSOPHY (PY)

PY/RE 1731. INTRODUCTION TO PHILOSOPHY AND RELIGION.

Cat. I

This course provides an overview of key concepts, methods and authors in both fields. These introduce the student to the types of reasoning required for the pursuit of in-depth analysis in each discipline.

Emphasis on topics and authors varies with the particular instructor.

PY 2711. EPISTEMOLOGY.

Cat. II

Epistemology is the branch of philosophy inquiring into the nature and conditions of knowledge and truth. Epistemologists ask such questions as: How should we define knowledge? Is knowledge generated by reason or experience? How has knowledge of nature been represented in Western philosophy and science? Is knowledge objective? What constitutes adequate justification for holding a belief? Do attributions of epistemic credibility vary among knowers from different social, cultural, and economic locations? How do power and ideology shape our experiences of the world? Students explore questions such as these and others as they submit their own beliefs about the nature of knowledge to philosophical examination. The course readings and situating context for inquiry will vary each time the course is taught, with each iteration focusing on a particular period or school of philosophical thought. Possible contexts include seventeenth century philosophy or other periods in the history of philosophy, critical theory, pragmatism, analytic philosophy, phenomenology, and feminist philosophy.

Recommended Background: none

This course will be offered in 2020-21, and in alternating years thereafter.

PY 2712. SOCIAL AND POLITICAL PHILOSOPHY.

Cat. II

This course examines metaphysical and moral questions that philosophers have raised about social and political life. Among questions treated might be: What are the grounds, if any, of the obligation of a citizen to obey a sovereign? Are there basic principles of justice by which societies, institutions and practices are rightly evaluated? What is democracy, and how can we tell if an institution or practice is democratic? To what degree do economic institutions put limits on the realization of freedom, democracy and self-determination? Readings might include excerpts from the works of Plato, Hobbes, Locke, Rousseau and Marx, as well as numerous contemporary philosophers.

Suggested background: familiarity with basic concepts in philosophy (as in PY/RE 1731).

This course will be offered in 2019-20, and in alternating years thereafter.

PY 2713. BIOETHICS.

Cat. II

The purpose of this course is to evaluate the social impact of technology in the areas of biology/biotechnology, biomedical engineering and chemistry. The focus of the course will be on the human values in these areas and how they are affected by new technological developments. The course will deal with problems such as human experimentation, behavior control, death, genetic engineering and counseling, abortion, and the allocation of scarce medical resources. These problems will be examined through lectures, discussions and papers.

Suggested background: knowledge of key terms and concepts as given in PY/RE 1731 and PY/RE 2731.

This course will be offered in 2019-20, and in alternating years thereafter.

PY/RE 2716. GENDER, RACE, AND CLASS.

Cat. II

This course examines the meanings of social categories such as gender, race, class, sexuality, ability, nationality, and species. What are the philosophical and religious foundations of the categorizations of beings operative in our contemporary cultures? How do attributions of same and different, normal and abnormal, rational and irrational, human and nonhuman shape social and

political processes of inclusion and exclusion? Are social categories real, constructed, or both? This course focuses primarily on intersectional approaches to oppression and identity that see social categories such as gender, race, and class as mutually constitutive rather than separable. Course readings span a range of philosophical and religious traditions including Continental philosophy, analytic philosophy, Latina/o studies, feminist theory, queer theory, critical race theory, disability studies, and environmental studies. Students may not earn credit for both PY 2716 and RE 2716.

This course will be offered in 2019-20, and in alternating years thereafter.

PY 2717. PHILOSOPHY AND THE ENVIRONMENT.

Cat. I

This course will focus on the following questions:

What is the scope of the current environmental crisis? What does this crisis reveal about the philosophical presuppositions and dominant values of our intellectual worldviews and social institutions? How can existing social theories help explain the environmental crisis? What implications does the crisis have for our sense of personal identity? What moral and spiritual resources can help us respond to it?

Readings will be taken from contemporary and historical philosophers and naturalists.

Suggested background: familiarity with basic concepts in philosophy (as in PY/RE 1731).

PY 2718. EXISTENTIALISM AND PHENOMENOLOGY.

Cat. I

This course focuses on two important movements in nineteenth and twentieth century philosophy, existentialism and phenomenology. Readings might include works by Kierkegaard, Dostoyevsky, Nietzsche, Husserl, Heidegger, Beauvoir, Sartre, Merleau-Ponty, Levinas, and Fanon, as well as contemporary readings by feminist, critical race, and queer theorists working within these traditions. Students will also encounter some of the great works of existentialist fiction and cinema. Themes that may be explored include the relationship between self and other, the tension between freedom and responsibility, the possibility of ethics after World War II, and the problem of ethical and political commitment in an alienating world.

Recommended Background: none

PY 2719. PHILOSOPHY OF SCIENCE.

Cat. I

This course is an in-depth consideration of the meaning, value, and consequences of scientific inquiry. Questions explored may include: Does science yield truth? Are the results of scientific inquiry more a reflection of the workings of the human mind than of those of the external world? Do pivotal scientific concepts like gene, electron, photon, species, and ecosystem point to entities that actually exist? Does the history of science, which includes many refutations of theories once believed to be true, raise questions about whether currently accepted theories should be trusted? By what methods does a scientific community validate knowledge claims and how are these processes affected by social, political, and economic contexts? Does a scientist have a responsibility to conduct morally conscientious research? How does the development of technology affect our spiritual and moral characters? In what ways is science similar to religion and in what ways is it different? The focus of this course may vary each time it is offered from an examination of science in general to an investigation of the foundations of specific branches of science such as physics, biology, environmental science, or social science.

Recommended Background: PY/RE 1731, Introduction to Philosophy and Religion or PY/RE 2731, Introduction to Ethics.

PY/RE 2731. ETHICS.

Cat. I

This course offers a general introduction to modern moral theory. What makes one action wrong, and another right? What are our moral duties towards others? Do moral values change over time, making beliefs about right and wrong simply "relative," or are moral values objective, holding true for all people, everywhere, at all times? Should emotions play a role in ethical deliberation, or should we aspire to be purely rational when engaged in moral thought and action? Is it okay to cheat on an exam, so long as everybody else does it? Do we have a right to use animals in laboratory experiments? Is eating meat ethical? Is it wrong to share a racist or sexist joke? Should abortion be legal? Students will learn how to apply key moral concepts to real-world problems and situations after closely studying several moral theories, including utilitarianism, Kantianism, and feminist care ethics. Other topics covered include moral relativism, psychological hedonism, and ethical egoism.

PY/RE 2732. SUFFERING, HEALING & VALUES.

Cat. II

This course examines medicine, not from a scientific or professional view, but from a specifically humanistic approach. Using essays, films, fiction, poetry and plays, we will aim to make explicit the moral values most deeply held by practitioners in the healing professions. What other kinds of values can get in the way of those most deeply held aims? What are the responsibilities of a medical professional in today's society? What are the sources of those responsibilities? The course will focus both on professional and personal dilemmas and will help students think through some moral problems that are likely to confront them in their professional and personal lives. The class should also help prepare students to navigate through the tough moral issues they are likely to face, either as a medical professional, a citizen, a parent, a child of parents, or as potentially a sick person themselves. This class proposes to grant students the reflective time to read some of the most eloquent authors on suffering, caretaking, and sickness (for example, Oliver Sacks, Jerome Groopman, Susan Sontag, Leo Tolstoy, Virginia Woolf, Tony Kushner, Tracy Kidder, Perri Klass, etc.) and to express their reflections on these resources in effective communication.

Recommended Background: PY/RE 1731 or an introductory level literature course.

This course will be offered in 2020-21, and in alternating years thereafter.

PY 2734. PHILOSOPHY AND SPIRITUALITY.

Cat. II

Spirituality is a philosophical perspective which stresses the role of virtue in happiness and morality; a psychological perspective on emotions and desire; and an essential dimension of religious life. Found in all religions, it is also personally important for the tens of millions who describe themselves as "spiritual but not religious." This course will investigate the many dimensions of spiritual thought and practice, focusing on questions such as: What Similarities/differences exist among the spiritual teachings of traditional religions? What is a spiritual experience, a spiritual lesson, a spiritual life? What is the role of spiritual practices such as yoga, meditation, and prayer? What is the place of spirituality in medicine (e.g., meditation as treatment for stress), our relation to nature (e.g., the experience of a sunset), and political life (e.g., Gandhi, King, spiritual environmentalism)? Beyond scientific knowledge, technological expertise, and common sense, is there such a thing as wisdom?

Recommended background: PY/RE 1731, Introduction to Philosophy and Religion.

This course will be offered in 2020-21, and in alternating years thereafter.

PY 3711. TOPICS IN PHILOSOPHY.

Cat. I

This course is organized around an advanced or specialized topic in philosophy and provides preparation for HU 3900 Inquiry Seminars in philosophy and religion. Emphasis on topics and authors will vary with instructor, but will typically involve the study of: a particular philosopher (e.g., Plato, Marx, Dewey, Arendt); a particular philosophical tradition (e.g., Pragmatism, Analytic Philosophy, Buddhism, Feminism); a particular philosophical problem or topic (free will, globalization, consciousness, social movement, justice); or a particular philosophical classic (Aristotle's Ethics, Hobbes's The Leviathan, Beauvoir's The Second Sex). The topical theme of the course will be provided as a modified course title in the course description posted online.

Recommended Background: None.

PY 3712. PHILOSOPHY OF RELIGION.

Cat. II

This course will focus on philosophical questions concerning the following topics: the existence and nature of God; the compatibility of God and evil; the nature of religious faith and the relationship between religion, science and ethics; interpretations of the nature of religious language; the philosophically interesting differences between Western and Eastern religions; philosophical critiques of the role of religion in social life. Authors may include: Hume, Kant, Kierkegaard, Buber, Tillich, Daly, Nietzsche and Buddha.

Suggested background: familiarity with basic religious concepts and terms (as in PY/RE 1731).

This course will be offered in 2020-21, and in alternating years thereafter.

RELIGION (RE)**RE/PY 1731. INTRODUCTION TO PHILOSOPHY AND RELIGION.***Cat. I*

This course provides an overview of key concepts, methods and authors in both fields. These introduce the student to the types of reasoning required for the pursuit of in-depth analysis in each discipline.

Emphasis on topics and authors varies with the particular instructor.

RE/PY 2716. GENDER, RACE, AND CLASS.*Cat. II*

This course examines the meanings of social categories such as gender, race, class, sexuality, ability, nationality, and species. What are the philosophical and religious foundations of the categorizations of beings operative in our contemporary cultures? How do attributions of same and different, normal and abnormal, rational and irrational, human and nonhuman shape social and political processes of inclusion and exclusion? Are social categories real, constructed, or both? This course focuses primarily on intersectional approaches to oppression and identity that see social categories such as gender, race, and class as mutually constitutive rather than separable. Course readings span a range of philosophical and religious traditions including Continental philosophy, analytic philosophy, Latina/o studies, feminist theory, queer theory, critical race theory, disability studies, and environmental studies. Students may not earn credit for both PY 2716 and RE 2716.

This course will be offered in 2019-20, and in alternating years thereafter.

RE 2721. RELIGION AND CULTURE.*Cat. I*

The purpose of this course is to examine how the two institutions of religion and culture interact and mutually influence one another. To do this a variety of definitions of religion and culture will be presented as well as an analysis of how religion interacts with such cultural phenomena as economics, politics, the state, war and the basic problem of social change. The purpose of this is to obtain a variety of perspectives on both religion and culture so that one can begin to articulate more clearly the different influences that occur in the development of one's own personal history and the culture in which one lives.

Suggested background: knowledge of key terms and concepts as given in PY/RE 1731.

RE 2722. MODERN PROBLEMS OF BELIEF*Cat. I*

This course examines the ways in which religious problems of meaning have been encountered in the context of the eclipse of religion in Western culture from the Enlightenment to the present. The class emphasizes challenges presented to traditional belief systems by modern thought in areas such as the sciences, psychology, textual criticism, and historical events, as well as some religious responses to those challenges. How do religions respond to the limits of human intellectual capacity, limits of human endurance, and limits of moral comprehension?

RE 2725. RELIGIOUS AND SPIRITUAL TRADITIONS.*Cat. I*

The primary aim of this course would be student literacy in global religions. The course examines, from historical, doctrinal, scriptural and/or philosophical perspectives, major world religious and spiritual traditions. Attention will be given to the social context in which these religious traditions developed and will examine their continuing influence. Students taking RE2725 should not receive credit for RE2723 or RE2724, since RE2725 replaces them.

Recommended background: None

RE/PY 2731. ETHICS.*Cat. I*

This course offers a general introduction to modern moral theory. What makes one action wrong, and another right? What are our moral duties towards others? Do moral values change over time, making beliefs about right and wrong simply "relative," or are moral values objective, holding true for all people, everywhere, at all times? Should emotions play a role in ethical deliberation, or should we aspire to be purely rational when engaged in moral thought and action? Is it okay to cheat on an exam, so long as everybody else does it? Do we have a right to use animals in laboratory experiments? Is eating meat ethical? Is it wrong to share a racist or sexist joke? Should abortion be legal? Students will learn how to apply key moral concepts to real-world problems and situations after closely studying several moral theories, including utilitarianism, Kantianism, and feminist care ethics. Other topics covered include moral relativism, psychological hedonism, and ethical egoism.

RE/PY 2732. SUFFERING, HEALING & VALUES.*Cat. II*

This course examines medicine, not from a scientific or professional view, but from a specifically humanistic approach. Using essays, films, fiction, poetry and plays, we will aim to make explicit the moral values most deeply held by practitioners in the healing professions. What other kinds of values can get in the way of those most deeply held aims? What are the responsibilities of a medical professional in today's society? What are the sources of those responsibilities? The course will focus both on professional and personal dilemmas and will help students think through some moral problems that are likely to confront them in their professional and personal lives. The class should also help prepare students to navigate through the tough moral issues they are likely to face, either as a medical professional, a citizen, a parent, a child of parents, or as potentially a sick person themselves. This class proposes to grant students the reflective time to read some of the most eloquent authors on suffering, caretaking, and sickness (for example, Oliver Sacks, Jerome Groopman, Susan Sontag, Leo Tolstoy, Virginia Woolf, Tony Kushner, Tracy Kidder, Perri Klass, etc.) and to express their reflections on these resources in effective communication.

Recommended Background: PY/RE 1731 or an introductory level literature course.

This course will be offered in 2020-21, and in alternating years thereafter.

RE 3721. TOPICS IN RELIGION.*Cat. I*

This course is organized around an advanced or specialized topic in religion and provides preparation for HU 3900 Inquiry Seminars in philosophy and religion. The focus will vary, but the material will be drawn from a particular religious thinker, a particular religious tradition or a particular historical or contemporary problem. The topical theme of the class will be provided as a modified course title in the course description posted online.

Recommended background: none

SPANISH (SP)**SP 1523. ELEMENTARY SPANISH I.***Cat. I*

A very intensive course that will introduce the student to the basic grammar of Spanish, emphasizing the four language skills: listening, speaking, reading and writing. It will also introduce the student to different aspects of Hispanic cultures in the U.S. and in Spanish-speaking countries. Students who have taken Spanish in high school are urged to take a placement exam before enrolling in either level of Elementary Spanish.

To enroll in this course, you must obtain written permission from one of the Spanish professors. This course is reserved for those students with only one year of high school Spanish or with no previous experience. This course is closed to native speakers of Spanish and heritage speakers except with written permission from the instructor.

SP 1524. ELEMENTARY SPANISH II.*Cat. I*

A continuation of Elementary Spanish I.

Recommended background: SP 1523.

This course is closed to native speakers of Spanish and heritage speakers except with written permission from the instructor.

SP 2521. INTERMEDIATE SPANISH I.*Cat. I*

A course designed to allow students to improve their written and oral skills, expand their vocabulary and review some important grammatical structures. Students will also read short stories and poems by some of the most representative Spanish American and Spanish authors, such as Horacio Quiroga, Jorge Luis Borges, Gabriela Mistral and Ana María Matute.

Recommended background: Elementary Spanish II.

This course is closed to native speakers of Spanish and heritage speakers except with written permission from the instructor.

SP 2522. INTERMEDIATE SPANISH II.*Cat. I*

A continuation of Intermediate Spanish I.

Recommended background: SP 2521.

This course is closed to native speakers of Spanish and heritage speakers except with written permission from the instructor.

SP 3521. ADVANCED SPANISH I.*Cat. I*

A course that continues to improve students' language skills while deepening their understanding of Hispanic cultures. Some of the topics studied are: the origins of Hispanic cultures in Spain and Spanish America; family; men and women in Hispanic societies; education; religion.

Recommended background: Intermediate Spanish II.

This course is closed to native speakers of Spanish except with written permission from the instructor.

SP 3522. ADVANCED SPANISH II.*Cat. I*

A continuation of Advanced Spanish I.

Recommended background: SP 3521.

This course satisfies the Inquiry Practicum requirement.

This course is closed to native speakers of Spanish except with written permission from the instructor.

SP 3523. TOPICS IN LATIN AMERICAN CULTURE.*Cat. II*

An introduction to various aspects of life in Latin American countries from early times to the present. Focusing on the social and political development of Latin America, the course will reveal the unity and diversity that characterize contemporary Latin American culture. Typical topics for study include: the precolombian civilizations and their cultural legacy; the conquistadores and the colonial period; the independence movements; the search for and the definition of an American identity; the twentieth-century dictatorships; and the move toward democracy.

Recommended background: SP 3521 (Advanced Spanish I) and SP 3522 (Advanced Spanish II) or equivalent.

This course will be offered in 2020-21, and in alternating years thereafter.

This course satisfies the Inquiry Practicum requirement.

SP 3524. SPANISH-AMERICAN LITERATURE IN THE TWENTIETH CENTURY.*Cat. II*

This course, taught in the Spanish language, focuses on the major literary movements in Spanish America, from the "Modernista" movement at the turn of the century to the Latin American "Boom" of the 1960s to the political literature of the '70s and '80s. The work of representative authors, such as Rubén Darío, Julio Cortázar, Rosario Castellanos, Elena Poniatowska, will be discussed.

Recommended background: SP 3521 (Advanced Spanish I) and SP 3522 (Advanced Spanish II) or equivalent.

This course will be offered in 2019-20, and in alternating years thereafter.

This course satisfies the Inquiry Practicum requirement.

SP/ID 3525. SPANISH AMERICAN FILM/MEDIA: CULTURAL ISSUES.*Cat. II*

Through Latin American and Caribbean films, and other media sources, this course studies images, topics, and cultural and historical issues related to modern Latin American and the Caribbean. Within the context and influence of the New Latin American Cinema and/or within the context of the World Wide Web, radio, newspapers, and television the course teaches students to recognize cinematographic or media strategies of persuasion, and to understand the images and symbols utilized in the development of a national/regional identity. Among the topics to be studied are: immigration, gender issues, national identity, political issues, and cultural hegemonies.

Taught in advanced level Spanish. May be used toward foreign language Minor, or Major.

Recommended Background: SP 2521 and SP 2522, and SP 3523.

This course will be offered in 2019-20, and in alternating years thereafter.

This course satisfies the Inquiry Practicum requirement.

SP/ID 3526. COMPARATIVE BUSINESS ENVIRONMENTS.*Cat. II*

The basis of this course is a comparative study and analysis of specific Latin American and Caribbean business practices and environments, and the customs informing those practices. SP/ID 3526 focuses on countries such as Mexico, Argentina, Chile, Puerto Rico, and Costa Rica. The course's main objective is to study communication strategies, business protocol, and negotiation practices in the countries mentioned above. Through oral presentations and written essays, students will have the opportunity to explore other countries in Latin America and the Caribbean.

Taught in advanced level Spanish. May be used toward foreign language Minor, or Major.

Recommended Background: SP 2521 and SP 2522.

This course will be offered in 2020-21, and in alternating years thereafter.

This course satisfies the Inquiry Practicum requirement.

SP/ID 3527. TECHNICAL AND BUSINESS SPANISH.*Cat. II*

The course focuses on the linguistic concepts, terminology, and grammar involved in business and technical Spanish. Students will be required to produce and edit business documents such as letters, job applications, formal oral and written reports, etc. The objective of this course is to help students develop the basic written and oral communication skills to function in a business environment in Latin America and the Caribbean.

Recommended background: SP 2521 and SP 2522.

This course will be offered in 2019-20, and in alternating years thereafter.

This course satisfies the Inquiry Practicum requirement.

SP 3528. SPANISH CULTURE AND CIVILIZATION.*Cat. II*

This course is an introduction to various aspects of life in Spain, from early times to the present. The main focus is on Spain's social, political, and cultural development and its experience of diversity within its European context. Typical topics for study include: The Reconquista and the Arab influence in Spanish culture, the Spanish monarchy, its evolution into a democracy, the development of modern politics, the importance of the Spanish Civil war, and the influence of writers (such as Federico García Lorca), painters (such as Pablo Picasso), and art in general in modern Spanish culture. This course is taught in Spanish.

Recommended background: SP3521 (Advanced Spanish I) and SP 3522 (Advanced Spanish II) or equivalent.

This course will be offered in 2019-20, and in alternating years thereafter.

This course satisfies the Inquiry Practicum requirement.

SP/ID 3529. CARIBBEANNESS: VOICES OF THE SPANISH CARIBBEAN.*Cat. II*

A survey of Caribbean literature and arts that takes a multimedia approach to examining the different voices that resonate from the Spanish Caribbean and what appears to be a constant search for identity. By studying the works of major authors, films, music and the plastic arts, we will examine the socio-cultural context and traditions of this region in constant search for self-definition. Special attention will be given to the influential role ethnicity, colonialism, gender and socio-economic development play in the interpretation of works from Puerto Rico, Cuba, the Dominican Republic, Colombia and Venezuela as well as those of the Caribbean diaspora. This course is taught in Spanish.

Recommended background: SP3521 (Advanced Spanish I) and SP 3522 (Advanced Spanish II) or equivalent.

This course will be offered in 2019-20, and in alternating years thereafter.

This course satisfies the Inquiry Practicum requirement.

SP/ID 3530. SPANISH FILM/MEDIA: CULTURAL ISSUES.*Cat. II*

Through Spanish films, and other media sources, this course studies images, topics, and cultural and historical issues that have had an impact in the creation of a modern Spanish nation. This course focuses on current political and ideological issues (after 1936), the importance of Spanish Civil war, gender identity, and class, cultural and power relationships. This course is taught in Spanish.

This course will be offered in 2020-21, and in alternating years thereafter.

This course satisfies the Inquiry Practicum requirement.

SP/ID 3531. CONTEMPORARY US LATINO LITERATURE & CULTURE.*Cat. II*

This course introduces students to the field of Latino studies, paying particular attention to the cultural productions of U.S. Latinos in film, theater, music, fiction writing and cultural criticism. At the same time that this course reflects upon a transnational framework for understanding the continuum between U.S. Latinos and Latin American/Caribbean communities, we closely examine more U.S. based arguments supporting and contesting the use of Latino as an ethnic-racial term uniting all U.S. Latino communities. We examine the ways in which U.S. Latinos have manufactured identities within dominant as well as counter cultural registers. In this course, special attention is given to the aesthetics of autobiography and to how Latino writers experiment with this genre in order to address changing constructions of immigration, language, exile, and identity. This course is taught in English.

This course will be offered in 2020-21, and in alternating years thereafter.

This course satisfies the Inquiry Practicum requirement.

SP 3532. STUDIES IN SPANISH LITERATURE: ARTISTIC EXPRESSION AND NATION BUILDING.*Cat. II*

This course introduces students to the study of Spanish literature through analytical readings of essays, poetry, drama, and fiction of representative Spanish writers from medieval to contemporary times. The selected authors to be studied reflect Spanish society's cultural and political efforts conducive to a nation building process. Among the topics to be covered are: Literary and artistic movements, nationalist and religious discourses, cultural miscegenation, gender issues, regional, political and class conflicts, the role of the intellectual, and strategies for the construction of identities.

This course is taught in Spanish.

Recommended Background: SP 3522 and SP 3528.

This course will be offered in 2020-21, and in alternating years thereafter.

This course satisfies the Inquiry Practicum requirement.

WRITING (WR) AND RHETORIC (RH)**WR 1010. ELEMENTS OF WRITING.***Cat. I*

This course is designed for students who wish to work intensively on their writing. The course will emphasize the processes of composing and revising, the rhetorical strategies of written exposition and argumentation, and the reading and citation practices central to academic inquiry. In a workshop setting, students will write a sequence of short papers and complete one longer writing project based on multiple source texts; learn to read critically and respond helpfully to each other's writing; and make oral presentations from written texts. Where applicable, the topical theme of the class will be provided via the Registrar's office.

WR 1011. WRITING ABOUT SCIENCE & TECHNOLOGY.*Cat. I*

This course will examine the appropriate dissemination of scientific information in common science writing genres such as science journalism, consulting reports and white papers, and policy and procedure documents. In a workshop setting, students will write and revise documents that promote broad understanding of scientific research and analysis of specialized knowledge. Course lectures and discussions investigate ethics of scientific reporting and teach students how to recognize deceptive texts and arguments (both quantitative and qualitative). The course is reading and writing intensive and is intended for students with backgrounds in a scientific discipline who are interested in applying their disciplinary knowledge.

WR 1020. INTRODUCTION TO RHETORIC.*Cat. I*

This course will apply classical and modern rhetorical concepts to analyze various texts and speeches in order to identify the means of persuasion to a particular end. Students will write short analytical papers that critically assess various rhetorical and communicative approaches. The goal of this course is to enable students to see rhetoric in action in order to both engage with the material critically as well as produce effective discourse to meet various situations.

CWR 2010. ELEMENTS OF STYLE.*Cat. I*

This course will cover basic principles of prose style for expository and argumentative writing. Students will learn to evaluate writing for stylistic problems and will learn revision strategies for addressing those problems. The ultimate goal of the course is to help students write sentences and paragraphs that are clear, concise, and graceful. In the first part of the course, students will review parts of speech, basic sentence types, and sentence and paragraph structure in order to understand how sentences are put together and the impact their construction has on readers. Then, through hands-on writing exercises and extensive revision of their own and others' writing, students will learn strategies for tightening their prose (concision), achieving "flow" (cohesion and coherence) and improving usage (language specificity and precision).

Recommended background: Basic knowledge of rhetorical writing (e.g., WR 1010, Elements of Writing, WR 1011, Writing About Science & Technology, or WR 1020, Introduction to Rhetoric).

WR 2210. BUSINESS WRITING AND COMMUNICATION.*Cat. I*

This course emphasizes the standard written genres of professional, workplace communication. Students will analyze the history, purposes, conventions, and social consequences of a variety of business communications, focusing on digital and print correspondence, reports, and proposals directed to internal and

external audiences. Students will learn about the culture of a professional environment and the role of writing in structuring identity and relationships within that context. Classes will be conducted as interactive writing workshops in which students assess and respond to rhetorical scenarios and sample texts from a variety of professional worksites. Students will create portfolios, producing professional writing samples they may use on the job market.

Suggested background: WR 1010 or WR 1011

WR 2310. VISUAL RHETORIC.*Cat. I*

This course explores how visual design is used for purposes of identification, information, and persuasion. It looks at many modes of visual communication, such as icons, logos, trademarks, signs, product packaging, infographics, posters, billboards, ads, exhibits, graffiti, page layout, films, television, videogames, and web sites. The course provides an overview of the history of graphic design movements, as well as analytical tools to understand how visual design encodes messages and the role visual communication plays in contemporary culture. Students will write about and create a number of visual media in this project-centered class.

Suggested background: WR 1010

WR/IMGD 2400. WRITING CHARACTERS FOR INTERACTIVE MEDIA & GAMES.*Cat. II*

This course will present concepts and skills necessary to create compelling characters in interactive media and games. Topics covered may include the 3 dimensions of character, growth and development of the player-character and non-player characters, dialogue, character relationships and evoking emotions through rhetorical tropes.

Recommended background: Previous experience in the fundamentals of writing for interactive media and games, such as that provided by IMGD 1002: Storytelling for Interactive Media and Games.

Students may not receive credit for both IMGD/WR 2400 and IMGD 240X.

WR 3011. TEACHING WRITING*Cat. II*

Teaching Writing introduces students to the theory and practice of written composition. Students research and read about the writing process and how best to support it through the practice of explicit teaching and tutoring. They learn specific strategies that can support writers as they plan, draft, and revise written work in a number of genres, and they study effective ways to provide helpful feedback on drafts. They also learn about and practice navigating the social, political and interpersonal dynamics of the teacher/tutor-student relationship through a tutoring internship at the Writing Center and through assignments prompting them to develop lesson plans and instructional handouts. This course will help students improve their own writing and read their own and others' writing more critically. It will be especially useful for those who plan to teach or tutor writing in the future.

Recommended background: WR 1010 Elements of Writing

This course will be offered in 2019-20, and in alternating years thereafter.

WR 3112. RHETORICAL THEORY.*Cat. I*

Rhetoric concerns both the art of mastering the available means of persuasion and the study of how oral, written, and visual communication projects the intentions of individuals and groups, makes meanings, and affects audiences. The purpose of this course therefore is two-fold. It is intended to help students become more effective communicators by learning about the rhetorical situation and various rhetorical techniques, and it is designed to help them understand how various forms of communication work by learning some of the philosophies and strategies of rhetorical analysis.

Recommended background: Introduction to Rhetoric

WR 3210. TECHNICAL WRITING.*Cat. I*

Technical writing combines technical knowledge with writing skills to communicate technology to the world. This course introduces the fundamental principles of technical communication, and the tools commonly used in the technical writing profession. Topics include user and task analysis, information design, instructional writing, and usability testing. Students learn to use the technical writing process to create user-centered documents that combine text, graphics, and visual formatting to meet specific information needs. Students create a portfolio of both hardcopy and online documentation, using professional tools such as FrameMaker, Acrobat, and RoboHelp. Recommended background: WR 1010, or equivalent writing course.

WR 3214. WRITING ABOUT DISEASE & PUBLIC HEALTH.*Cat. I*

This writing workshop focuses on the purposes and genres of writing about disease and public health. We will consider how biomedical writers communicate technical information about disease and public health to general audiences; how writers capture the human experience of disease and health care; how writers treat the public policy implications of disease; and how writers design publicity to promote public health. We will examine such genres as the experimental article, news reports, medical advice, profiles, commentary, and public health messages.

Recommended background: WR 1010 Elements of Writing or equivalent writing courses.

WR 3300. CROSS-CULTURAL COMMUNICATION.*Cat. II.*

This course will examine how people from differing cultural backgrounds communicate, in similar and different ways among themselves, and how they endeavor to communicate across cultures. Students will develop a personal and theoretical understanding of the cultural origin of people's values, ideologies, habits, idiosyncrasies, and how they affect communication across cultural, racial, ethnic and gender lines. Through observing, studying and experiencing incidents of cross-cultural communication, they will begin to examine and develop skills that are necessary for effective understanding and for successful communication among majority and minority groups.

This course will be offered in 2020-21, and in alternate years thereafter.

WR/IMGD 3400. WRITING NARRATIVE FOR INTERACTIVE MEDIA & GAMES.*Cat. II*

This writing-intensive course covers concepts and skills necessary to write and implement narrative in interactive media and games. Topics include themes and style, different types of games and platforms, systemic storytelling, linear vs. non-linear narratives, editing, writing with purpose and audience in mind, and collaboration with other members of a development team.

Recommended background: Previous experience in writing for interactive media and games, such as that provided by IMGD/WR 2400: Writing Characters for Interactive Media & Games.

Students may not receive credit for both IMGD/WR 3400 and IMGD 340X.

WR 4111. RESEARCH METHODS IN WRITING.*Cat. I*

This methodology course introduces students to issues in the study of writing such as the history and uses of literacy, the relationship of thought to language, the role of writing in producing knowledge, and research on composing. The focus of the course will be on professional and academic writing. In this project-based class, students will develop research questions, construct a relevant method study, and carry out that study. The purpose of this course is to add to students analytical approaches to writing and communicative situations.

Recommended background: WR 1010 Elements of Writing, WR 2310 Rhetoric of Visual Design, WR 3112

Rhetorical Theory.

INDEPENDENT STUDY

Independent Study course designations are by subject and level of study.

In the following course numbers, [SUBJ] = SUBJECT CODE (e.g. AE, BB, ECON, ID)

[SUBJ] 1999. INDEPENDENT STUDY.

[SUBJ] 2999. INDEPENDENT STUDY.

[SUBJ] 3999. INDEPENDENT STUDY.

[SUBJ] 4999. INDEPENDENT STUDY.

Cat. I

See Independent Study policy on page 218 for information.

INTERACTIVE MEDIA & GAME DEVELOPMENT**IMGD 1000. CRITICAL STUDIES OF INTERACTIVE MEDIA AND GAMES.***Cat. I*

This course introduces non-technical studies of computer-based interactive media and games. The course develops a vocabulary for discussing games and other interactive media, and tools for analyzing them. Students are expected to provide written critiques using the critical approaches presented in the course. The games and other interactive media critiqued may be commercially available or under development.

IMGD 1001. THE GAME DEVELOPMENT PROCESS.*Cat. I*

This course discusses the process of game development. It examines the roles of different participants in the development process and how the technical development and the artistic development proceed in tandem. Group work is emphasized, especially the importance of collaboration between technical and artistic efforts. Students are expected to participate in game development using appropriate game development tools.

Some sections of this course may be offered as Writing Intensive (WI).

IMGD 1002. STORYTELLING IN INTERACTIVE MEDIA AND GAMES.*Cat. I*

This course explores different types of story within gaming and other interactive media. It delineates between linear, branching, and emergent storytelling, identifies hybrids, and finds new modes of making compelling narrative. A variety of games are discussed, including early text-based adventures, role-playing games, shooters, and strategy games. Students will construct characters, situations, and narratives through game play and scripted cut scenes. Students will explore and use visual storytelling techniques.

IMGD 2000. SOCIAL ISSUES IN INTERACTIVE MEDIA AND GAMES.*Cat. I*

This course provides students with a realistic assessment of the potential and problems related to interactive media and games, especially computer games, and their effects on society. Topics include individual and group behavior, diversity, human responsibility, ethical and legal issues, and intellectual property. The course examines the issues from various points of view, and discover the political, social, and economic agendas of the people or groups championing those points of view. Students will write papers, participate in discussions, and research related topics.

Recommended background: IMGD 1000.

IMGD 2001. PHILOSOPHY AND ETHICS OF COMPUTER GAMES.*Cat. II*

This course introduces students to some of the political and ethical dimensions of the new entertainment modalities. Students will explore such issues as representation and power (e.g., gaming and disability, and race stereotyping in games), the phenomenology of virtual reality, capitalism and the commodification of leisure, gender and sexual violence, and cyberspace and democracy. Students will also develop critical tools for evaluating the ethical and social content of their own and others' games. In addition to writing several analytical papers on the critical theory of technology, students will be encouraged to work on game designs exploring philosophical or social themes.

Recommended background: IMGD 1000.

This course will be offered in 2019-20, and in alternating years thereafter.

IMGD 2030. GAME AUDIO I.*Cat. I*

This course serves as an introduction to game audio, where the basics of audio theory and production are discussed along with practical applications for use in game development. Topics may include music, sound effects, dialogue, soundscape design, digital signal processing, basic audio engine principles, and the aesthetic vs. technical considerations in game audio production. Lab exercises may include an introduction to audio editing and mixing, dynamics and effects processing, creating and timing sound effects to character animations, mixing for cinematics, and audio integration using a 3D engine.

Recommended background: IMGD 1000 and IMGD 1001.

This course assumes no prior knowledge of audio production.

IMGD 2048. TECHNICAL ART AND CHARACTER RIGGING.*Cat. II*

This course will focus on making digital art functional in a video game environment. Students will learn the skills necessary to create and optimize their art assets through several creative and technical solutions that are all geared towards making high quality game art.

This course will allow students to form a greater understanding of the bridge between pure art creation and interactive art implementation into a game engine. The course explores the many problems and technical restrictions one is faced with when trying to implement anything from animated characters to textures and focuses on how one can creatively apply technology to achieve high quality results.

Topics covered include: creating complex character rigs, optimizing character meshes for rigging, shader creation, optimizing UV space and baking texture files and lighting.

Recommended background: Basic knowledge of 3D modeling, texturing and animation (IMGD 2101 and IMGD 2201 or equivalent).

Students may not receive credit for both IMGD 204X and IMGD 2048.

IMGD/AR 2101. 3D MODELING I.*Cat. I*

3D modeling is concerned with how to render created forms in a virtual environment. This course covers 3D modeling applications in video game development, film production, product design and fine art. Topics may include creating and armature, modeling organic and hard surfaces and sculpting using traditional techniques applied to a 3D model. Students will create works suitable for presentation in professional quality portfolio.

Recommended background: AR1100 and AR1101.

IMGD/AR 2222. 2D ANIMATION I.*Cat. I*

2D Animation I teaches students how to draw, pose, breakdown and in-between characters for 2D animation, focusing on weight, balance, timing, and movement to achieve well-structured and fluid animation. Lectures and projects are conducted to train students in the twelve classical animation principles using digital 2D media. Projects and lectures are designed to practice the fundamentals of traditional frame-by-frame and hand-drawn character animation.

Recommended background: Basic knowledge of figure drawing (AR 2202) and digital art software (AR 1101) is recommended.

IMGD/AR 2333. 3D ANIMATION I.*Cat. I*

3D Animation I teaches students how to use 3D animation software to apply classical animation principles into 3D work. Lectures focus on creating organic and compelling character animation through body mechanics, weight, and dynamic posing in addition to exposing students to learning how to think about character acting and staging within a 3D environment.

Recommended background: Basic knowledge digital art software (AR 1101) is recommended.

Suggested background: Basic knowledge of animation (IMGD/AR 2222).

IMGD/WR 2400. WRITING CHARACTERS FOR INTERACTIVE MEDIA & GAMES.*Cat. II*

This course will present concepts and skills necessary to create compelling characters in interactive media and games. Topics covered may include the 3 dimensions of character, growth and development of the player-character and non-player characters, dialogue, character relationships and evoking emotions through rhetorical tropes.

Recommended background: Previous experience in the fundamentals of writing for interactive media and games, such as that provided by IMGD 1002: Storytelling for Interactive Media and Games.

Students may not receive credit for both IMGD/WR 2400 and IMGD 240X.

IMGD 2500. DESIGN OF TABLETOP STRATEGY GAMES.*Cat. II*

The objective of the course is to teach students how to design board strategy games. The design principles are transferable to other types of games, such as computer games. Game quality issues such as rules unambiguity, depth, complexity, branching width, balance, and historical content are examined. Basic elements and types of game rules, such as map gridding, restricted play choices, resource limitations, and depths of game economics are discussed. Central to the course is the game design project: students design, playtest, and develop their own game. One two-hour laboratory a week covers play, and playtesting, and supports the game design project.

Recommended background: IMGD 1000

This course will be offered in 2020-21, and in alternating years thereafter.

IMGD/AR 2700. DIGITAL PAINTING.*Cat. I*

This course covers painting techniques as applied to texturing a 3D asset or illustration/conceptual art. Topics include are color theory, study of form, lighting, applying traditional painting ideas to the digital format, character design, generation of ideas and a history of digital painting. Each class features a demonstration on the topic followed by individual critique and study. Students work towards a final project that may be suitable for an Art portfolio.

Recommended background: AR 1101, AR 2202

IMGD/AR 2740. 3D ENVIRONMENTAL MODELING.*Cat. II*

The objective of this course is to teach students how to create 3D environments and props for use in digital models, simulations, games, or animation. The course will examine different types of architecture used in 3D spaces. The students will learn how to create historical and fictional interior and exterior environments; to design, model, texture, and render in high details; and to import their creation into an engine for testing. Topics may include space, human scale, set design, surface texturing, and basic camera animation. Students may not receive credit for IMGD/AR 2740 and IMGD/AR 205X.

Recommended Background: Basic 3D modeling skills (AR 1101)

This course will be offered in 2020-21, and in alternating years thereafter.

IMGD 2900. DIGITAL GAME DESIGN I.*Cat. I*

Software engineering and art production are the means of digital game development, but the end is an experience. Game design is the process of creating, describing, implementing and iteratively refining that experience. This team-oriented, project-based course provides opportunities for students to develop hands-on expertise with digital game design through a combination of practical implementation, in-class critique and playtesting. A focus of the course is the functional expression of design through the use of game engine scripting.

Students keep a weekly journal of their design experiences. A final exam tests their knowledge of design concepts and terminology.

Recommended background: Intermediate programming experience (such as from CS 2102, CS 2103, or CS 1004), Knowledge of game studies (IMGD 1000 or equivalent) and the game development process (IMGD 1001 or equivalent).

IMGD 2905. DATA ANALYSIS FOR GAME DEVELOPMENT.*Cat. I*

This course will cover basic concepts of probability and data analysis as they apply to the design and analysis of interactive media and games. Students will study appropriate use of probability distributions in the design of interactive experiences, and the use of data analysis methods to understand user behavior in games and other interactive experiences.

Topics will include discrete and continuous probability distributions, programming techniques to produce samples from different distributions, descriptive statistics, exploratory data analysis and using existing tools to collect and analyze data from gameplay.

This course counts toward the Quantitative Science component of the university-wide Mathematics and Science Requirement for IMGD majors only.

Recommended background: High school algebra

IMGD 3000. TECHNICAL GAME DEVELOPMENT I.*Cat. I*

This course teaches technical Computer Science aspects of game development, with the focus of the course on low-level programming of a computer games. Topics include 2D and 3D game engines, simulation-type games, analog and digital controllers and other forms of tertiary input. Students will implement games or parts of games, including exploration of graphics, sound, and music as it affects game implementation.

Recommended background: CS 2303.

IMGD 3030. GAME AUDIO II.*Cat. II*

Game Audio II serves as an intermediate level audio design course, where digital recording principles and techniques are studied along with their practical applications for use in game development. Students will also gain deeper insight into 2-D vs. 3-D audio propagation, as well as learn more complex techniques in digital editing, mixing, signal processing, mastering, and playback strategies. Lab exercises may include interactive dialogue scripting and recording; loop-based music production; custom sound effects creation and Foley design; and audio engine integration. A team project will be the creation of a comprehensive game sound effects library over the course of the term.

Recommended background: Game Audio (IMGD 2030)

This course will be offered in 2020-21, and in alternating years thereafter.

IMGD 3100. NOVEL INTERFACES FOR INTERACTIVE ENVIRONMENTS.*Cat. II*

This course focuses on the design and evaluation of novel user interfaces that provide greater input and output expressiveness than the keyboard, mouse, or game pad. The course covers the related applications of immersive gaming, teleoperated robotics, and mobile users. Input sensors, such as those providing motion, attitude, and pressure data, are used to explore novel input methods, and how they may be effectively used to design innovative experiences. Through a combination of lecture and hands-on work, students learn to build prototype systems and to critically evaluate different alternatives. Students are expected to program several alternative input/output systems as part of this course.

Recommended background: IMGD 1001, and either CS 2301 or CS 2303

This course will be offered in 2020-21, and in alternating years thereafter.

IMGD/AR 3101. 3D MODELING II.*Cat. I*

This course will build upon the skills learned in 3D MODELING with studies in life drawing/anatomy study and application towards completed character models. Students will create high resolution sculpts for real time game environments and animation. Topics covered will be character design as it applies to 3D MODELING, creating realistic design sculpts and incorporating them into a game environment as well as the study of anatomy as it applies to organic modeling.

Recommended background: AR 1101, IMGD/AR 2101, AR 2202

IMGD/AR 3200. INTERACTIVE ELECTRONIC ARTS.*Cat. I*

This course introduces students to techniques and processes for the creation of real-time, interactive works of art. Students learn to use electronic sensors and other tools for audio, graphics, and video processing, as well as design customized software interfaces to create interactive artworks that respond to users and their environment. The course also introduces students to the work of significant contemporary arts practitioners as well as their historical precedents, with a special emphasis on inter-media works that bridge visual art, music composition, and the performing arts. Topics may include electronic musical instruments and performance interfaces, computer vision, VJing, electronically-augmented dance, controller hacking, wired clothing, networked collaboration and mobile media, and algorithmic and generative art.

Recommended background: Animation (AR/IMGD 2101 or equivalent), and exposure to digital audio or music and introductory programming.

IMGD/AR 3222. 2D ANIMATION II.*Cat. I*

This course will build upon the techniques learned in IMGD/AR 2222. Students will learn to apply the animation principles to character animation. Students are taught how to tell a compelling, character-driven story through a focus on character acting techniques such as body language, lip syncing, facial animation, and micro expressions. Additional topics covered may include sprites for games, biped and quadruped animation, and 2D animation pipelines. Students will create animated sequences that are intended to serve a narrative structure for games and other media.

Recommended background: Knowledge of digital 2D animation techniques and classical animation principles (IMGD/AR 2222).

IMGD/AR 3333. 3D ANIMATION II.*Cat. I*

This course will build upon the techniques learned in IMGD/AR 2333. Students will learn to apply the animation principles with a focus on character acting and cinematic animation. Students are taught how to tell a compelling, character-driven story through a focus on acting techniques such as body language, lip syncing, facial animation, and micro expressions whilst incorporating digital cinematography techniques. Additional topics covered may include creating 3D simulations for hair and cloth, biped and quadruped animation, and 3D animation pipelines. Students will create animated sequences that are intended to serve a narrative structure for games and other media.

Recommended background: Knowledge of digital 3D animation techniques and classical animation principles (IMGD/AR 2333).

IMGD/WR 3400. WRITING NARRATIVE FOR INTERACTIVE MEDIA & GAMES.*Cat. II*

This writing-intensive course covers concepts and skills necessary to write and implement narrative in interactive media and games. Topics include themes and style, different types of games and platforms, systemic storytelling, linear vs. non-linear narratives, editing, writing with purpose and audience in mind, and collaboration with other members of a development team.

Recommended background: Previous experience in writing for interactive media and games, such as that provided by IMGD/WR 2400: Writing Characters for Interactive Media & Games.

Students may not receive credit for both IMGD/WR 3400 and IMGD 340X.

IMGD 3500. ARTISTIC GAME DEVELOPMENT I.*Cat. I*

This course focuses on the unique problems presented to the artist when working in game development. Students will learn game art pipelines and how to prepare art assets for use in game engines. Topics may include modular level design, 3D architecture, texturing and shaders, high poly and low poly workflows, environments, lighting, particle effects, and character animation for games. Students will create original art for compelling game experiences by designing their own levels.

Recommended background: 3D modeling (IMGD/AR 2101 and 3101), digital painting (IMGD/AR 2700), 3D animation (IMGD/AR 2333).

IMGD/AR 3700. CONCEPT ART AND CREATIVE ILLUSTRATION.*Cat. I*

This course covers drawing as it applies to concept art and illustration. The course begins with study of a human model and representational drawing. Following this, students work on drawing from the mind and applying the lessons learned from the figure drawing to creating concept art and illustration. Topics covered are shape recognition and recalling, inventing from the mind, creative starters, study of form and light, visual composition and developing a personal approach, working with individual strengths to create a compelling visual design. Students create a series of concept art exercises and apply these skills towards a personal project of their own.

Recommended background: AR 2202, IMGD/AR 2700

IMGD 3900. DIGITAL GAME DESIGN II.*Cat. II*

This team-oriented, project-based course will provide opportunities for students to deepen their experience and understanding of digital game design concepts through a combination of thorough design, practical implementation, playtesting and in-class game critique.

Students will prepare and present design treatments, develop hands-on expertise with game scripting, and study methods of collecting and analyzing gameplay data. A final project and presentation will test their creativity and demonstrate their practical mastery of game design concepts.

Recommended background: IMGD 2900: Digital Game Design I, and basic knowledge of statistical data analysis such as that provided by IMGD 2905: Data Analysis for Game Development.

IMGD 4000. TECHNICAL GAME DEVELOPMENT II.*Cat. I*

This course focuses on the application of advanced Computer Science topics as they impact game development. Networking and distributed systems issues are addressed, including scalability and latency compensation techniques, for designing games for an online multi-player environments. AI, graphics and physics techniques specific to game development are discussed. Students will implement games or parts of games that apply advanced Computer Science topics.

Recommended background: IMGD 3000.

IMGD 4099. SPECIAL TOPICS IN IMGD.*Cat. II (1/6 – 1/3 unit)*

Arranged by individual faculty with special expertise, this course explores emerging and experimental topics that are not covered by the regular IMGD offerings. Content and format varies to suit the interests and needs of the faculty and students. Specific course descriptions are disseminated by IMGD program in advance of the offering. This course may be repeated for different topic offerings.

Recommended background: Varies depending on topic.

IMGD/CS 4100. ARTIFICIAL INTELLIGENCE FOR INTERACTIVE MEDIA AND GAMES.*Cat. II*

Advanced software design and programming techniques from artificial intelligence are key contributors to the experience of modern computer games and virtual environments, either by directly controlling a non-player character or through more subtle manipulation of the environment. This course will cover the current state of the art in this area, as well as prepare students for the next generation of AI contributions. We will study the application of AI techniques such as search, planning, machine learning, emotion modeling and natural language processing, to game problems such as navigation, strategy, believability and narrative control. Students will implement several small AI demonstration games.

Recommended background: IMGD 4000.

Students may not receive credit for both IMGD 4100 and IMGD 400X.

This course will be offered in 2019-20, and in alternating years thereafter.

IMGD 4200. HISTORY AND FUTURE OF IMMERSIVE AND INTERACTIVE MEDIA.*Cat. II*

This course will familiarize students with the history of the development, deployment, commercialization, and evolution of immersive and active media. The lesson plan will cover a broad range of enabling technologies, such as geometric perspective drawing, pre-20th-century panoramic displays, photography and the stereoscope, sound recording and reproduction, motion pictures, radio and television, the planetarium, immersive and 3-dimensional cinema, and special attraction venues, with a particular focus on digital games. Current trends and future directions will also be considered. Students will attend seminars and lectures, read and discuss texts on media history and aesthetics, and write an original research paper. Midterm and final exams test students' knowledge and understanding of important events and developments. A student may not receive credit for both IMGD 4200 and IMGD 5200.

Recommended background: IMGD 1000, and either IMGD 2000 or IMGD 2001.

This course will be offered in 2019-20, and in alternating years thereafter.

IMGD 4403. MOTION CAPTURE TECHNIQUES.*Cat. II*

This course will introduce students to the principles of motion capture as applied to the production of digital games and cinema. Topics will include the study of different forms of mocap technology, the design of efficient animation pipelines, techniques for combining keyed and mocap animation, and real-time capture into game engines. Students will gain experience in directing actors, blending hand-keyed animations, applying the laws of physics to motion data sets, building tools and troubleshooting captured data.

Students cannot receive credit for both IMGD 4403 and IMGD 440X.

Recommended background: Students should have knowledge of basic 3D animation principles and software such as is provided by IMGD/AR 2333: 3D Animation I. They should also have knowledge of structural anatomy and kinematics such as is provided by IMGD 2048: Technical Art and Character Rigging.

This course will be offered in 2021-22, and in alternating years thereafter.

IMGD 4500. ARTISTIC GAME DEVELOPMENT II.*Cat. I*

This course focuses on the integration and organization of the various artistic elements used in game development. The course examines user interaction, interface design, and existing paradigms in current games. Students will combine elements of level design, animation, music, sound, and writing to create an aesthetically appealing game.

Recommended background: IMGD 1002, IMGD 3500, MU 1611.

IMGD 4600. SERIOUS GAMES.*Cat. II*

This course explores the application of the technologies and design principles of interactive media and game development beyond traditional entertainment. The purpose of such applications is typically to change people's behaviors, knowledge and/or attitudes in diverse areas including health care, training, education, simulation, politics, marketing and art. Students read about, experiment with, compare and discuss examples, as well as the underlying philosophies and issues specific to this genre, such as domain analysis and rigorous evaluation. Students

in groups also research a new application and produce a detailed design document and mock-up. Advanced programming skill is not required, but a background in game design is strongly recommended.

Recommended background: IMGD 1001 and either IMGD 2000 or IMGD 2001.

Students may not receive credit for both IMGD 4600 and IMGD 404X.

This course will be offered in 2019-20, and in alternating years thereafter.

IMGD 4700. ADVANCED STORYTELLING: QUEST LOGIC AND LEVEL DESIGN.*Cat. II*

This course provides an in-depth examination of storytelling as it is currently done in 2D and 3D games through a study of quests and construction of gaming spaces. Level designers turn stories into games through building virtual spaces and populating them with non-player characters who have their own objectives. Cinematics are used to extend the narrative space. The course requires students to build multiple virtual spaces that have a history and a population with present needs. Students need to work out plotting through the logic of a quest, build several areas that supports that logic and create cinematics to extend their narrative space.

Recommended background: IMGD 1002, or equivalent knowledge.

Students may not receive credit for both IMGD 4700 and IMGD 403X.

This course will be offered in 2020-21, and in alternating years thereafter.

IMGD 4900. DIGITAL GAME DESIGN STUDIO.*Cat. II*

This studio course will provide students an opportunity to collaborate on the creation of an original game project, with an emphasis on the importance of scoping and a thorough, well-documented design. Students will form project teams, create a team Web site, and design, implement and test their project using industry-standard tools and methods.

Recommended background: IMGD 3900 (Digital Game Design II)

This course will be offered in 2019-20, and in alternating years thereafter.

INTERDISCIPLINARY

FY 1100 & FY 1101. THE GREAT PROBLEMS SEMINARS.*Cat. I*

The Great Problems Seminars (GPS) are a two course sequence designed to engage Worcester Polytechnic Institute's first-year students with current events, societal problems, and human needs. Each seminar starts with an important problem and introduces some of the key disciplinary tools that could be used to attack the problem. The focus for most of the second course will be a research project related to the GPS theme. Students will present their project work in a poster session at the end of the second term. Each seminar is developed and presented by an interdisciplinary pair of faculty. To participate, students must enroll in the two course sequence. Academic credit for the GPS will depend on the theme and the faculty who develop the seminar.

FY 1800. DISCOVERING MAJORS AND CAREERS.*(1/12 unit)*

This course is open to all students who are undecided about or are thinking about changing their academic major. Students will conduct a self-assessment utilizing career assessment tools, research majors of interest and career paths, attend major panels, speak to students/faculty in majors of interest, and participate in informational interviews with alumni. Students will meet individually with Peer Advisors and/or a CDC staff member at least three times throughout the course.

ID 2000. MAPPING YOUR MISSION.*Cat. I (1/6 unit)*

Every student that graduates from WPI has a major, but what about a mission? This course helps participants explore their personal values, strengths, and talents and the ways they can use these personal characteristics to improve the world around them. Through the course, participants will identify a personal mission and a plan to work toward achieving their mission. Participants will explore the ways their major and their mission can intersect.

Students may not receive credit for ID 200X and ID 2000.

ID/SS 2050. SOCIAL SCIENCE RESEARCH FOR THE IQP.*Cat. I*

This course is open to students accepted to off-campus IQP centers and programs. The course introduces students to research design, methods for social science research, and analysis. It also provides practice in specific research and field skills using the project topics students have selected in conjunction with sponsoring agencies. Students learn to develop social science hypotheses based upon literature reviews in their topic areas and apply concepts drawn from social psychology, anthropology, sociology, economics and other areas as appropriate. Students make presentations, write an organized project proposal, and develop a communication model for reporting their project findings.

Some sections of this course may be offered as Writing Intensive (WI).

ID 2100. DISEASE DETECTIVES: AN INTRODUCTION TO EPIDEMIOLOGY.*Cat. II*

In this course, we will learn about the principles of epidemiology and the role epidemiologist play in responding to disease outbreaks and promoting public health through exploration of a series of real life cases studies. We will analyze the burden of communicable diseases today and emerging disease. We will discuss the role of current health practices and priorities as well as global organization and institutional players. Students will be introduced to the basic principles and methods used in epidemiology to study the distribution and determinants of disease in human populations and in the development of prevention and intervention strategies. The course will take an interdisciplinary approach as epidemiologist relay on many different disciplines such as biology for understanding disease processes, statistics for making efficient and appropriate use of data, social science for understanding behavior, and engineering for analysis and assessment tools. Class sessions will consist of lecture, intensive small group discussion, and case analyses.

This course will be offered in 2020-21, and in alternating years thereafter.

ID 3100. TEACHING METHODS IN MATHEMATICS AND SCIENCE.*Cat. I*

Within the context of contemporary secondary education in mathematics and science (biology, chemistry, physics), ID 3100 introduces and demonstrates effective teaching methods as they relate to curriculum goals and current methods of assessment. These methods take into account diverse learning styles as well as various technological resources. Topics to be covered include: a brief history of education; curriculum and course guidelines (Massachusetts Education Reform and regulations 603 CMR 7.00, state curricular frameworks, national standards); legal issues; developing a course syllabus; and the issue of breadth versus depth in course planning and delivery. The course also covers practical questions of organizing, delivering and assessing a course. This course is intended primarily for students interested in completing the Massachusetts requirements for teacher licensing. This program is aimed primarily at majors in mathematics, physics, chemistry, biology, and certain engineering fields wishing to be licensed to teach in middle or high school in one of those disciplines. A portion of the course requires students to complete field work in a local classroom to assist them in beginning to acquire the appropriate skills to conduct their own classes in mathematics, science, or engineering at the secondary school level.

Recommended background: Principals of educational psychology including: understanding student characteristics, the learning process, motivation to learn, student diversity; evaluating student learning (PSY 2401)

Note, this course is typically held off campus at Doherty High School (approximately 1 mile from campus) so please plan for travel time when signing up.

ID/AR 3150. LIGHT, VISION AND UNDERSTANDING.*Cat. II*

By using material from the sciences and the humanities this course examines the ways in which ideas of knowledge and of human nature have been fashioned. The specific topics include physical theories about light, biological and psychological theories of visual perception, and artistic theories and practices concerned with representation. The mixing of material from different academic disciplines is deliberate, and meant to counter the notion that human pursuits are "naturally" arranged in the neat packages found in the modern university. The course draws upon the physical and social sciences, and the humanities, to examine how those fields relate to one another, and how they produce knowledge and self-knowledge. Cultural as well as disciplinary factors are assessed in this process.

Light, Vision and Understanding is conducted as a seminar. The diverse collection of reading materials includes a number of primary texts in different fields. In addition, the students keep a journal in which they record the results of

numerous individual observations and experiments concerning light and visual perception. The course can fit into several areas of depth as well as serve as a starting point for an IQP. There are no specific requirements for this course, although some knowledge of college-level physics, as well an acquaintance with the visual arts, is helpful.

This course will be offered in 2020-21, and in alternating years thereafter.

ID 3200. SHELTERED ENGLISH IMMERSION ENDORSEMENT COURSE FOR TEACHERS.*Cat. I*

This course is to prepare undergraduates looking to become future Commonwealth teachers with the knowledge and skills to effectively shelter their content instruction, so that the growing population of English language learners (ELLs) can access curriculum, achieve academic success, and contribute their multilingual and multicultural resources as participants and future leaders in the 21st century global economy.

Recommended background: Teaching Methods or equivalent.

ID/SP 3525. SPANISH AMERICAN FILM/MEDIA: CULTURAL ISSUES.*Cat. II*

Through Latin American and Caribbean films, and other media sources, this course studies images, topics, and cultural and historical issues related to modern Latin American and the Caribbean. Within the context and influence of the New Latin American Cinema and/or within the context of the World Wide Web, radio, newspapers, and television the course teaches students to recognize cinematographic or media strategies of persuasion, and to understand the images and symbols utilized in the development of a national/regional identity. Among the topics to be studied are: immigration, gender issues, national identity, political issues, and cultural hegemonies.

Taught in advanced level Spanish. May be used toward foreign language Minor, or Major.

Recommended Background: SP 2521 and SP 2522, and SP 3523.

This course will be offered in 2019-20, and in alternating years thereafter.

ID/SP 3526. COMPARATIVE BUSINESS ENVIRONMENTS.*Cat. II*

The basis of this course is a comparative study and analysis of specific Latin American and Caribbean business practices and environments, and the customs informing those practices. ID/SP 3526 focuses on countries such as Mexico, Argentina, Chile, Puerto Rico, and Costa Rica. The course's main objective is to study communication strategies, business protocol, and negotiation practices in the countries mentioned above. Through oral presentations and written essays, students will have the opportunity to explore other countries in Latin America and the Caribbean.

Taught in advanced level Spanish. May be used toward foreign language Minor, or Major.

Recommended Background: SP 2521 and SP 2522.

This course will be offered in 2020-21, and in alternating years thereafter.

ID/SP 3527. TECHNICAL AND BUSINESS SPANISH.*Cat. II*

The course focuses on the linguistic concepts, terminology, and grammar involved in business and technical Spanish. Students will be required to produce and edit business documents such as letters, job applications, formal oral and written reports, etc. The objective of this course is to help students develop the basic written and oral communication skills to function in a business environment in Latin America and the Caribbean.

Recommended background: SP 2521 and SP 2522.

This course will be offered in 2019-20, and in alternating years thereafter.

ID/SP 3529. CARIBBEANNESS: VOICES OF THE SPANISH CARIBBEAN.*Cat. II*

A survey of Caribbean literature and arts that takes a multimedia approach to examining the different voices that resonate from the Spanish Caribbean and what appears to be a constant search for identity. By studying the works of major authors, films, music and the plastic arts, we will examine the socio-cultural context and traditions of this region in constant search for self-definition. Special attention will be given to the influential role ethnicity, colonialism, gender and socio-economic development play in the interpretation of works from Puerto Rico, Cuba, the Dominican Republic, Colombia and Venezuela as well as those of the Caribbean diaspora. This course is taught in Spanish.

Recommended background: SP3521 (Advanced Spanish I) and SP 3522 (Advanced Spanish II) or equivalent.

This course will be offered in 2019-20, and in alternating years thereafter.

ID/SP 3530. SPANISH FILM/MEDIA: CULTURAL ISSUES.*Cat. II*

Through Spanish films, and other media sources, this course studies images, topics, and cultural and historical issues that have had an impact in the creation of a modern Spanish nation. This course focuses on current political and ideological issues (after 1936), the importance of Spanish Civil war, gender identity, and class, cultural and power relationships. This course is taught in Spanish.

This course will be offered in 2020-21, and in alternating years thereafter.

ID/SP 3531. CONTEMPORARY US LATINO LITERATURE & CULTURE.*Cat. II*

This course introduces students to the field of Latino studies, paying particular attention to the cultural productions of U.S. Latinos in film, theater, music, fiction writing and cultural criticism. At the same time that this course reflects upon a transnational framework for understanding the continuum between U.S. Latinos and Latin American/Caribbean communities, we closely examine more U.S. based arguments supporting and contesting the use of Latino as an ethnic-racial term uniting all U.S. Latino communities. We examine the ways in which U.S. Latinos have manufactured identities within dominant as well as counter cultural registers. In this course, special attention is given to the aesthetics of autobiography and to how Latino writers experiment with this genre in order to address changing constructions of immigration, language, exile, and identity. This course is taught in English.

This course will be offered in 2020-21, and in alternating years thereafter.

MATHEMATICAL SCIENCES

The second digit in mathematical sciences course numbers is coded as follows:

- 0 — Basic
- 2 — Applied mathematics (general)
- 4 — Applied mathematics (differential equations)
- 6 — Statistics and probability
- 8 — Mathematics (general)

MA 1020. CALCULUS I WITH PRELIMINARY TOPICS.*Cat. I (14-week course)*

This course includes the topics of MA 1021 and also presents selected topics from algebra, trigonometry, and analytic geometry.

This course, which extends for 14 weeks and offers 1/3 unit of credit, is designed for students whose precalculus mathematics is not adequate for MA 1021.

Although the course will make use of computers, no programming experience is assumed.

Students may not receive credit for both MA 1020 and MA 1021.

MA 1021. CALCULUS I.*Cat. I*

This course provides an introduction to differentiation and its applications.

Topics covered include: functions and their graphs, limits, continuity, differentiation, linear approximation, chain rule, min/max problems, and applications of derivatives.

Recommended background: Algebra, trigonometry and analytic geometry.

Although the course will make use of computers, no programming experience is assumed.

Students may not receive credit for both MA 1021 and MA 1020.

MA 1022. CALCULUS II.*Cat. I*

This course provides an introduction to integration and its applications.

Topics covered include: inverse trigonometric functions, Riemann sums, fundamental theorem of calculus, basic techniques of integration, volumes of revolution, arc length, exponential and logarithmic functions, and applications.

Recommended background: MA 1021. Although the course will make use of computers, no programming experience is assumed.

MA 1023. CALCULUS III.*Cat. I*

This course provides an introduction to series, parametric curves and vector algebra.

Topics covered include: numerical methods, indeterminate forms, improper integrals, sequences, Taylor's theorem with remainder, convergence of series and power series, polar coordinates, parametric curves and vector algebra.

Recommended background: MA 1022. Although the course will make use of computers, no programming experience is assumed.

MA 1024. CALCULUS IV.*Cat. I*

This course provides an introduction to multivariable calculus.

Topics covered include: vector functions, partial derivatives and gradient, multivariable optimization, double and triple integrals, polar coordinates, other coordinate systems and applications.

Recommended background: MA 1023. Although the course will make use of computers, no programming experience is assumed.

MA 1033. THEORETICAL CALCULUS III.*Cat. I*

This course will cover the same material as MA 1023 Calculus III but from a different perspective. A more rigorous study of sequences and series will be undertaken: starting from the least upper bound property in \mathbb{R} , the fundamental theorems for convergent series will be proved. Convergence criteria for series will be rigorously justified and L'Hospital's rule will be introduced and proved.

Homework problems will include a blend of computational exercises as usually assigned in MA 1023 Calculus III and problems with a stronger theoretical flavor.

Recommended background: Differential and integral calculus (MA 1021 and MA 1022, or equivalent).

Note: Students can receive credit for this class and MA 1023 Calculus III.

MA 1034. THEORETICAL CALCULUS IV.*Cat. I*

This course will cover the same material as MA 1024 Calculus IV from a more mathematically rigorous perspective. The course gives a rigorous introduction of differentiation and integration for functions of one variable. After introducing vector functions, differentiation and integration will be extended to functions of several variables.

Recommended background: Theoretical Calculus III (MA 1033, or equivalent).

Note: Students can receive credit for this class and MA 1024 Calculus IV.

MA 1120. CALCULUS II. (SEMESTER VERSION)*Cat. I (14-week course)*

The topics for integral calculus (MA 1022) are covered in this course: the concept of the definite integral, the Fundamental Theorem of Calculus, integration techniques, and applications of integration. Applications include: area, volume, arc length, center of mass, work, force, and exponential growth and decay. Logarithmic and exponential functions are studied in depth. Arithmetic and geometric sequences and series will also be covered. Key historical events in the development of integral calculus are examined. Technology will be used as appropriate to support the material being studied.

This course extends for 14 weeks and offers 1/3 unit of credit. It is designed for students who would benefit from additional contact hours and who need to strengthen their mathematical background. Although the course will make use of computers, no programming experience is assumed.

Students may not receive credit for both MA 1120 and MA 1022 or MA 1102.

MA 1801. DENKSPORT.*Cat. I (1/12 Unit)*

Problem solving is a fundamental mathematical skill. In this course students will be exposed to problems coming from a wide range of mathematical disciplines; and will work together in a collaborative environment to explore potential solutions. Discussion problems may be inspired by the research of faculty leading the discussion, by past mathematical competitions (such as the Putnam Competition) or elsewhere. This course meets once per week, with an emphasis on discussion and exploration of problems. There will be no exam and no assigned homework. Grading is by participation only. This course may be taken multiple times; content will vary depending on the speakers. Grading for this course will be on a Pass/NR basis.

Recommended background: Curiosity about Mathematics

MA 1971. BRIDGE TO HIGHER MATHEMATICS.*Cat. I*

The principal aim of this course is to practice mathematical problem interpretation, proof techniques, and question formulation. The course is intended not only for beginning students in the mathematical sciences, but also for all students interested in mathematical art and rigor. Students in the course will be expected to explain, justify, defend, disprove, conjecture and verify mathematical statements, both orally and in writing, in order to develop proof-writing skills.

(These skills should prove useful in more advanced mathematics courses). Topics covered include basic logic; basic set theory; definitions and properties of functions; definitions and properties of binary relations; fundamental proof techniques, including proof by induction. Depending on student background and instructor preferences, the course objectives may be conveyed through a selection of problems from various mathematical sub-disciplines, through discussions of current events in the mathematical sciences, including recently solved problems and open challenges facing today's scientists, or through discussions of applications of mathematics.

Recommended background: at least two courses in Mathematical Sciences at WPI, or equivalent.

MA 2051. ORDINARY DIFFERENTIAL EQUATIONS.

Cat. I

This course develops techniques for solving ordinary differential equations. Topics covered include: introduction to modeling using first-order differential equations, solution methods for linear higher-order equations, qualitative behavior of nonlinear first-order equations, oscillatory phenomena including spring-mass system and RLC-circuits and Laplace transform. Additional topics may be chosen from power series method, methods for solving systems of equations and numerical methods for solving ordinary differential equations.

Recommended background: MA 1024.

MA 2071. MATRICES AND LINEAR ALGEBRA I.

Cat. I

This course provides an introduction to the theory and techniques of matrix algebra and linear algebra. Topics covered include: operations on matrices, systems of linear equations, linear transformations, determinants, eigenvalues and eigenvectors, least squares, vector spaces, inner products, introduction to numerical techniques, and applications of linear algebra. Credit may not be earned for this course and MA 2072.

Recommended background: None, although basic knowledge of equations for planes and lines in space would be helpful.

MA 2072. ACCELERATED MATRICES AND LINEAR ALGEBRA I.

Cat. I

This course provides an accelerated introduction to the theory and techniques of matrix algebra and linear algebra, aimed at Mathematical Sciences majors and others interested in advanced concepts of linear algebra. Topics covered include: matrix algebra, systems of linear equations, linear transformations, determinants, eigenvalues and eigenvectors, the method of least squares, vector spaces, inner products, non-square matrices and singular value decompositions. Students will be exposed to computational and numerical techniques, and to applications of linear algebra, particularly to Data Science. Credit may not be earned for this course and MA 2071.

Recommended background: Basic knowledge of matrix algebra

MA 2073. MATRICES AND LINEAR ALGEBRA II.

Cat. I

This course provides a deeper understanding of topics introduced in MA 2071, and continues the development of linear algebra. Topics covered include: abstract vector spaces, linear transformations, matrix representations of a linear transformation, determinants, characteristic and minimal polynomials, diagonalization, eigenvalues and eigenvectors, the matrix exponential, inner product spaces. This course is designed primarily for Mathematical Science majors and those interested in the deeper mathematical issues underlying linear algebra.

Recommended background: MA 2071 or MA 2072.

MA 2201/CS 2022. DISCRETE MATHEMATICS.

Cat. I

This course serves as an introduction to some of the more important concepts, techniques, and structures of discrete mathematics providing a bridge between computer science and mathematics. Topics include sets, functions and relations, propositional and predicate calculus, mathematical induction, properties of integers, counting techniques and graph theory. Students will be expected to develop simple proofs for problems drawn primarily from computer science and applied mathematics.

Recommended background: None.

MA 2210. MATHEMATICAL METHODS IN DECISION MAKING.

Cat. I

This course introduces students to the principles of decision theory as applied to the planning, design and management of complex projects. It will be useful to students in all areas of engineering, actuarial mathematics as well as those in

such interdisciplinary areas as environmental studies. It emphasizes quantitative, analytic approaches to decision making using the tools of applied mathematics, operations research, probability and computations. Topics covered include: the systems approach, mathematical modeling, optimization and decision analyses. Case studies from various areas of engineering or actuarial mathematics are used to illustrate applications of the materials covered in this course.

Recommended background: MA 1024. Suggested background: Familiarity with vectors and matrices. Although the course makes use of computers, no programming experience is assumed. Students who have received credit for CE 2010 may not receive credit for MA 2210.

MA 2211. THEORY OF INTEREST I.

Cat. I

An introduction to actuarial mathematics is provided for those who may be interested in the actuarial profession. Topics usually included are: measurement of interest, including accumulated and present value factors; annuities certain; amortization schedules and sinking funds; and bonds.

Recommended background: Single variable calculus (MA 1021 and MA 1022 or equivalent) and the ability to work with appropriate computer software.

Students may not receive credit for both MA 2211 and MA 3211

MA 2212. THEORY OF INTEREST II.

Cat. I

This course covers topics in fixed income securities. Topics are chosen to cover the mechanics and pricing of modern-day fixed income products and can include: yield curve theories; forward rates; interest rate swaps; credit-default swaps; bonds with credit risk and options; bond duration and convexity; bond portfolio construction; asset-backed securities, including collateralized debt obligations and mortgage-backed securities with prepayment risk; asset-liability hedging; applications of binomial interest rate trees.

Recommended background: An introduction to theory of interest (MA 2211 or equivalent) and the ability to work with appropriate computer software.

MA 2251. VECTOR AND TENSOR CALCULUS.

Cat. I

This course provides an introduction to tensor and vector calculus, an essential tool for applied mathematicians, scientists, and engineers.

Topics covered include: scalar and vector functions and fields, tensors, basic differential operations for vectors and tensors, line and surface integrals, change of variable theorem in integration, integral theorems of vector and tensor calculus. The theory will be illustrated by applications to areas such as electrostatics, theory of heat, electromagnetics, elasticity and fluid mechanics.

Recommended background: MA 1024.

MA 2271. GRAPH THEORY.

Cat. II

This course introduces the concepts and techniques of graph theory—a part of mathematics finding increasing application to diverse areas such as management, computer science and electrical engineering. Topics covered include: graphs and digraphs, paths and circuits, graph and digraph algorithms, trees, cliques, planarity, duality and colorability.

This course is designed primarily for Mathematical Science majors and those interested in the deeper mathematical issues underlying graph theory.

Undergraduate credit may not be earned both for this course and for MA 3271.

Recommended background: MA 2071.

This course will be offered in 2020-21, and in alternating years thereafter.

MA 2273. COMBINATORICS.

Cat. II

This course introduces the concepts and techniques of combinatorics—a part of mathematics with applications in computer science and in the social, biological, and physical sciences. Emphasis will be given to problem solving. Topics will be selected from: basic counting methods, inclusion-exclusion principle, generating functions, recurrence relations, systems of distinct representatives, combinatorial designs, combinatorial algorithms and applications of combinatorics.

This course is designed primarily for Mathematical Sciences majors and those interested in the deeper mathematical issues underlying combinatorics.

Undergraduate credit may not be earned both for this course and for MA 3273.

Recommended background: MA 2071.

This course will be offered in 2019-20, and in alternating years thereafter.

MA 2431. MATHEMATICAL MODELING WITH ORDINARY DIFFERENTIAL EQUATIONS.*Cat. I*

This course focuses on the principles of building mathematical models from a physical, chemical or biological system and interpreting the results. Students will learn how to construct a mathematical model and will be able to interpret solutions of this model in terms of the context of the application. Mathematical topics focus on solving systems of ordinary differential equations, and may include the use of stability theory and phase-plane analysis. Applications will be chosen from electrical and mechanical oscillations, control theory, ecological or epidemiological models and reaction kinetics. This course is designed primarily for students interested in the deeper mathematical issues underlying mathematical modeling. Students may be required to use programming languages such as Matlab or Maple to further investigate different models.

Recommended background: multivariable calculus (MA 1024 or equivalent), ordinary differential equations (MA 2051 or equivalent), and linear algebra (MA 2071 or equivalent).

MA 2610. APPLIED STATISTICS FOR THE LIFE SCIENCES.*Cat. I*

This course is designed to introduce the student to statistical methods and concepts commonly used in the life sciences. Emphasis will be on the practical aspects of statistical design and analysis with examples drawn exclusively from the life sciences, and students will collect and analyze data. Topics covered include analytic and graphical and numerical summary measures, probability models for sampling distributions, the central limit theorem, and one and two sample point and interval estimation, parametric and non-parametric hypothesis testing, principles of experimental design, comparisons of paired samples and categorical data analysis. Undergraduate credit may not be earned for both this course and for MA 2611.

Recommended background: MA 1022.

MA 2611. APPLIED STATISTICS I.*Cat. I*

This course is designed to introduce the student to data analytic and applied statistical methods commonly used in industrial and scientific applications as well as in course and project work at WPI. Emphasis will be on the practical aspects of statistics with students analyzing real data sets on an interactive computer package.

Topics covered include analytic and graphical representation of data, exploratory data analysis, basic issues in the design and conduct of experimental and observational studies, the central limit theorem, one and two sample point and interval estimation and tests of hypotheses.

Recommended background: MA 1022.

MA 2612. APPLIED STATISTICS II.*Cat. I*

This course is a continuation of MA 2611.

Topics covered include simple and multiple regression, one and two-way tables for categorical data, design and analysis of one factor experiments and distribution-free methods.

Recommended background: MA 2611.

MA 2621. PROBABILITY FOR APPLICATIONS.*Cat. I*

This course is designed to introduce the student to probability.

Topics to be covered are: basic probability theory including Bayes theorem; discrete and continuous random variables; special distributions including the Bernoulli, Binomial, Geometric, Poisson, Uniform, Normal, Exponential, Chi-square, Gamma, Weibull, and Beta distributions; multivariate distributions; conditional and marginal distributions; independence; expectation; transformations of univariate random variables.

Recommended background: MA 1024.

MA 2631. PROBABILITY THEORY.*Cat. I*

The purpose of this course is twofold:

- To introduce fundamental ideas and methods of mathematics using the study of probability as the vehicle. These ideas and methods may include systematic theorem-proof development starting with basic axioms; mathematical induction; set theory; applications of univariate and multivariate calculus.

- To introduce the student to probability. Topics to be covered will be chosen from: axiomatic development of probability; independence; Bayes theorem; discrete and continuous random variables; expectation; special distributions including the binomial and normal; moment generating functions; multi-variate distributions; conditional and marginal distributions; independence of random variables; transformations of random variables; limit theorems.

This course is designed primarily for Mathematical Sciences majors and those interested in the deeper mathematical issues underlying probability theory. A more applications-oriented course with similar content is MA 2621 Probability for Applications which is primarily designed for students in departments other than Mathematical Sciences.

Recommended background: Multivariable Differential and Integral Calculus (MA 1024, or equivalent).

Undergraduate credit may not be earned both for this course and for MA 2621 Probability for Applications.

MA 3212. ACTUARIAL MATHEMATICS I.*Cat. I*

A study of actuarial mathematics with emphasis on the theory and application of contingency mathematics in various areas of insurance. Topics usually included are: survival functions and life tables; life insurance; property insurance; annuities; net premiums; and premium reserves.

Recommended background: An introduction to the theory of interest, and familiarity with basic probability (MA 2211 and either MA 2621 or MA 2631, or equivalent).

MA 3213. ACTUARIAL MATHEMATICS II.*Cat. I*

A continuation of the study of actuarial mathematics with emphasis on calculations in various areas of insurance, based on multiple insureds, multiple decrements, and multiple state models. Topics usually included are: survival functions; life insurance; property insurance; common shock; Poisson processes and their application to insurance settings; gross premiums; and reserves.

Recommended background: An introduction to actuarial mathematics (MA 3212 or equivalent)

MA 3231. LINEAR PROGRAMMING.*Cat. I*

The mathematical subject of linear programming deals with those problems in optimal resource allocation which can be modeled by a linear profit (or cost) function together with feasibility constraints expressible as linear inequalities. Such problems arise regularly in many industries, ranging from manufacturing to transportation, from the design of livestock diets to the construction of investment portfolios.

This course considers the formulation of such real-world optimization problems as linear programming problems, the most important algorithms for their solution, and techniques for their analysis. The core material includes problem formulation, the primal and dual simplex algorithms, and duality theory. Further topics may include: sensitivity analysis; applications such as matrix games or network flow models; bounded variable linear programs; interior point methods.

Recommended background: Matrices and Linear Algebra (MA 2071, or equivalent).

MA 3233. DISCRETE OPTIMIZATION.*Cat. II*

Discrete optimization is a lively field of applied mathematics in which techniques from combinatorics, linear programming, and the theory of algorithms are used to solve optimization problems over discrete structures, such as networks or graphs. The course will emphasize algorithmic solutions to general problems, their complexity, and their application to real-world problems drawn from such areas as VLSI design, telecommunications, airline crew scheduling, and product distribution. Topics will be selected from: Network flow, optimal matching, integrality of polyhedra, matroids, and NP-completeness.

Recommended background: At least one course in graph theory, combinatorics or optimization (e.g., MA 2271, MA 2273 or MA 3231).

This course will be offered in 2020-21, and in alternating years thereafter.

MA 3257/CS 4032. NUMERICAL METHODS FOR LINEAR AND NONLINEAR SYSTEMS.*Cat. I*

This course provides an introduction to modern computational methods for linear and nonlinear equations and systems and their applications.

Topics covered include: solution of nonlinear scalar equations, direct and iterative algorithms for the solution of systems of linear equations, solution of nonlinear systems, the eigenvalue problem for matrices. Error analysis will be emphasized throughout.

Recommended background: MA 2071. An ability to write computer programs in a scientific language is assumed.

MA 3457/CS 4033. NUMERICAL METHODS FOR CALCULUS AND DIFFERENTIAL EQUATIONS.*Cat. I*

This course provides an introduction to modern computational methods for differential and integral calculus and differential equations.

Topics covered include: interpolation and polynomial approximation, approximation theory, numerical differentiation and integration, numerical solutions of ordinary differential equations. Error analysis will be emphasized throughout.

Recommended background: MA 2051. An ability to write computer programs in a scientific language is assumed. Undergraduate credit may not be earned for both this course and for MA 3255/CS 4031.

MA 3471. ADVANCED ORDINARY DIFFERENTIAL EQUATIONS.*Cat. II*

The first part of the course will cover existence and uniqueness of solutions, continuous dependence of solutions on parameters and initial conditions, maximal interval of existence of solutions, Gronwall's inequality, linear systems and the variation of constants formula, Floquet theory, stability of linear and perturbed linear systems. The second part of the course will cover material selected by the instructor. Possible topics include: Introduction to dynamical systems, stability by Lyapunov's direct method, study of periodic solutions, singular perturbation theory and nonlinear oscillation theory.

Recommended background: MA 2431 and MA 3832.

This course will be offered in 2019-20, and in alternating years thereafter.

MA 3475. CALCULUS OF VARIATIONS.*Cat. II*

This course covers the calculus of variations and select topics from optimal control theory. The purpose of the course is to expose students to mathematical concepts and techniques needed to handle various problems of design encountered in many fields, e. g. electrical engineering, structural mechanics and manufacturing.

Topics covered will include: derivation of the necessary conditions of a minimum for simple variational problems and problems with constraints, variational principles of mechanics and physics, direct methods of minimization of functions, Pontryagin's maximum principle in the theory of optimal control and elements of dynamic programming.

Recommended background: MA 2051.

This course will be offered in 2020-21, and in alternating years thereafter.

MA 3627. INTRODUCTION TO THE DESIGN AND ANALYSIS OF EXPERIMENTS.*Cat. II*

This course will teach students how to design experiments in order to collect meaningful data for analysis and decision making. This course continues the exploration of statistics for scientific and industrial applications begun in MA 2611 and MA 2612. The course offers comprehensive coverage of the key elements of experimental design used by applied researchers to solve problems in the field, such as random assignment, replication, blocking, and confounding. Topics covered include the design and analysis of general factorial experiments; two-level factorial and fractional factorial experiments; principles of design; completely randomized designs and one-way analysis of variance (ANOVA); complete block designs and two-way analysis of variance; complete factorial experiments; fixed, random, and mixed models; split-plot designs; nested designs.

Recommended background: Applied Statistics (MA 2611 and MA2612, or equivalent).

This course will be offered in 2020-21, and in alternating years thereafter.

MA 3631. MATHEMATICAL STATISTICS.*Cat. I*

This course introduces students to the mathematical principles of statistics. Topics will be chosen from: Sampling distributions, limit theorems, point and interval estimation, sufficiency, completeness, efficiency, consistency; the

Rao-Blackwell theorem and the Cramer-Rao bound; minimum variance unbiased estimators and maximum likelihood estimators; tests of hypotheses including the Neyman-Pearson lemma, uniformly most powerful and likelihood ratio tests.

Recommended background: MA 2631.

MA 3823. GROUP THEORY.*Cat. I*

This course provides an introduction to one of the major areas of modern algebra. Topics covered include: groups, subgroups, permutation groups, normal subgroups, factor groups, homomorphisms, isomorphisms and the fundamental homomorphism theorem.

Recommended background: MA 2073.

MA 3825. RINGS AND FIELDS.*Cat. II*

This course provides an introduction to one of the major areas of modern algebra. Topics covered include: rings, integral domains, ideals, quotient rings, ring homomorphisms, polynomial rings, polynomial factorization, extension fields and properties of finite fields. Recommended background: MA 2073.

This course will be offered in 2019-20, and in alternating years thereafter.

MA 3831. PRINCIPLES OF REAL ANALYSIS I.*Cat. I*

Principles of Real Analysis is a two-part course giving a rigorous presentation of the important concepts of classical real analysis. Topics covered in the sequence include: basic set theory, elementary topology of Euclidean spaces, metric spaces, compactness, limits and continuity, differentiation, Riemann-Stieltjes integration, infinite series, sequences of functions, and topics in multivariate calculus.

Recommended background: at least one course focused on proof-based mathematics (e.g., MA 1971 Bridge to Higher Mathematics, MA 1033 Theoretical Calculus III).

MA 3832. PRINCIPLES OF REAL ANALYSIS II.*Cat. I*

MA 3832 is a continuation of MA 3831. For the contents of this course, see the description given for MA 3831.

Recommended background: introductory knowledge in real analysis (e.g., MA 3831 Principles of Real Analysis I, or equivalent).

MA 4213. LOSS MODELS I – RISK THEORY.*Cat. I*

This course covers topics in loss models and risk theory as it is applied, under specified assumptions, to insurance. Topics covered include: economics of insurance, short term individual risk models, single period and extended period collective loss models, and applications.

Recommended background: An introduction to probability (MA 2631 or equivalent).

MA 4214. LOSS MODELS II – SURVIVAL MODELS.*Cat. I*

Survival models are statistical models of times to occurrence of some event. They are widely used in areas such as the life sciences and actuarial science (where they model such events as time to death, or to the development or recurrence of a disease), and engineering (where they model the reliability or useful life of products or processes). This course introduces the nature and properties of survival models, and considers techniques for estimation and testing of such models using realistic data. Topics covered will be chosen from: parametric and nonparametric survival models, censoring and truncation, nonparametric estimation (including confidence intervals and hypothesis testing) using right-, left-, and otherwise censored or truncated data.

Recommended background: An introduction to mathematical statistics (MA 3631 or equivalent).

MA 4216. ACTUARIAL SEMINAR.*Cat. I (0 credit)*

This pass/fail graduation requirement will be offered every term, under the supervision of the actuarial professors. In order to receive a passing grade, students will need to complete some or all of the following: attend speaker talks, attend company visits to campus, take part and help out with Math Department activities, take part and help out with Actuarial Club activities, prepare for actuarial exams, or complete other activities as approved by the instructor(s).

Recommended background: Interest in being an actuarial mathematics major.

MA 4222. TOP ALGORITHMS IN APPLIED MATHEMATICS.*Cat. II*

This course will introduce students to the top algorithms in applied mathematics. These algorithms have tremendous impact on the development and practice of modern science and engineering. Class discussions will focus on introducing students to the mathematical theory behind the algorithms as well as their applications. In particular, the course will address issues of computational efficiency, implementation, and error analysis. Algorithms to be considered may include the Krylov Subspace Methods, Fast Multipole Method, Monte Carlo Methods, Fast Fourier Transform, Kalman Filters and Singular Value Decomposition. Students will be expected to apply these algorithms to real-world problems; e.g., image processing and audio compression (Fast Fourier Transform), recommendation systems (Singular Value Decomposition), electromagnetics or fluid dynamics (Fast Multipole Method, Krylov Subspace Methods, and Fast Fourier Transform), and the tracking and prediction of an object's position (Kalman Filters). In addition to studying these algorithms, students will learn about high performance computing and will have access to a machine with parallel and GPU capabilities to run code for applications with large data sets.

Recommended background: Familiarity with matrix algebra and systems of equations (MA 2071, MA 2072, or equivalent), numerical methods for the solution of linear systems or differential equations (MA 3257, MA 3457, or equivalent), and concepts from probability (MA 2621, MA 2631, or equivalent). The ability to write computer programs in a scientific language is assumed.

This course will be offered in 2021-22, and in alternating years thereafter.

MA 4235. MATHEMATICAL OPTIMIZATION.*Cat. II*

This course explores theoretical conditions for the existence of solutions and effective computational procedures to find these solutions for optimization problems involving nonlinear functions.

Topics covered include: classical optimization techniques, Lagrange multipliers and Kuhn-Tucker theory, duality in nonlinear programming, and algorithms for constrained and unconstrained problems.

Recommended background: Vector calculus at the level of MA 2251.

This course will be offered in 2019-20, and in alternating years thereafter.

MA 4237. PROBABILISTIC METHODS IN OPERATIONS RESEARCH.*Cat. II*

This course develops probabilistic methods useful to planners and decision makers in such areas as strategic planning, service facilities design, and failure of complex systems.

Topics covered include: decisions theory, inventory theory, queuing theory, reliability theory, and simulation.

Recommended background: Probability theory at the level of MA 2621 or MA 2631.

This course will be offered in 2019-20, and in alternating years thereafter.

MA 4291. APPLIED COMPLEX VARIABLES.*Cat. I*

This course provides an introduction to the ideas and techniques of complex analysis that are frequently used by scientists and engineers. The presentation will follow a middle ground between rigor and intuition.

Topics covered include: complex numbers, analytic functions, Taylor and Laurent expansions, Cauchy integral theorem, residue theory, and conformal mappings.

Recommended background: MA 1024 and MA 2051.

MA 4411. NUMERICAL ANALYSIS OF DIFFERENTIAL EQUATIONS.*Cat. II*

This course is concerned with the development and analysis of numerical methods for differential equations.

Topics covered include: well-posedness of initial value problems, analysis of Euler's method, local and global truncation error, Runge-Kutta methods, higher order equations and systems of equations, convergence and stability analysis of one-step methods, multistep methods, methods for stiff differential equations and absolute stability, introduction to methods for partial differential equations.

Recommended background: MA 2071 and MA 3457/CS 4033. An ability to write computer programs in a scientific language is assumed.

This course will be offered in 2020-21, and in alternating years thereafter.

MA 4451. BOUNDARY VALUE PROBLEMS.*Cat. I*

Science and engineering majors often encounter partial differential equations in the study of heat flow, vibrations, electric circuits and similar areas. Solution techniques for these types of problems will be emphasized in this course.

Topics covered include: derivation of partial differential equations as models of prototype problems in the areas mentioned above, Fourier Series, solution of linear partial differential equations by separation of variables, Fourier integrals and a study of Bessel functions.

Recommended background: MA 1024 or and MA 2051.

MA 4473. PARTIAL DIFFERENTIAL EQUATIONS.*Cat. II*

The first part of the course will cover the following topics: classification of partial differential equations, solving single first order equations by the method of characteristics, solutions of Laplace's and Poisson's equations including the construction of Green's function, solutions of the heat equation including the construction of the fundamental solution, maximum principles for elliptic and parabolic equations. For the second part of the course, the instructor may choose to expand on any one of the above topics.

Recommended background: MA 2251 and MA 3832.

This course will be offered in 2020-21, and in alternating years thereafter.

MA 4603/BCB 4004. STATISTICAL METHODS IN GENETICS AND BIOINFORMATICS.*Cat. II*

This course provides students with knowledge and understanding of the applications of statistics in modern genetics and bioinformatics. The course generally covers population genetics, genetic epidemiology, and statistical models in bioinformatics. Specific topics include meiosis modeling, stochastic models for recombination, linkage and association studies (parametric vs. nonparametric models, family-based vs. population-based models) for mapping genes of qualitative and quantitative traits, gene expression data analysis, DNA and protein sequence analysis, and molecular evolution. Statistical approaches include log-likelihood ratio tests, score tests, generalized linear models, EM algorithm, Markov chain Monte Carlo, hidden Markov model, and classification and regression trees.

Recommended background: MA 2612, MA 2631 (or MA 2621), and BB 2920.

This course will be offered in 2019-20, and in alternating years thereafter.

MA 4631. PROBABILITY AND MATHEMATICAL STATISTICS I.*Cat. I (14 week course)*

Intended for advanced undergraduates and beginning graduate students in the mathematical sciences and for others intending to pursue the mathematical study of probability and statistics, this course begins by covering the material of MA 3613 at a more advanced level. Additional topics covered are: one-to-one and many-to-one transformations of random variables; sampling distributions; order statistics, limit theorems.

Recommended background: MA 2631 or MA 3613, MA 3831, MA 3832.

MA 4632. PROBABILITY AND MATHEMATICAL STATISTICS II.*Cat. I (14 week course)*

This course is designed to complement MA 4631 and provide background in principles of statistics.

Topics covered include: point and interval estimation; sufficiency, completeness, efficiency, consistency; the Rao-Blackwell theorem and the Cramer-Rao bound; minimum variance unbiased estimators, maximum likelihood estimators and Bayes estimators; tests of hypothesis including uniformly most powerful, likelihood ratio, minimax and Bayesian tests.

Recommended background: MA 3631 or MA 4631.

MA 4635. DATA ANALYTICS AND STATISTICAL LEARNING.*Cat. I*

The focus of this class will be on statistical learning – the intersection of applied statistics and modeling techniques used to analyze and to make predictions and inferences from complex real-world data. Topics covered include: regression; classification/clustering; sampling methods (bootstrap and cross validation); and decision tree learning.

Students may not receive credit for both MA 463X and MA 4635.

Recommended background: Linear Algebra (MA 2071 or equivalent), Applied Statistics and Regression (MA 2612 or equivalent), Probability (MA 2631 or equivalent). The ability to write computer programs in a scientific language is assumed.

MA 4891. TOPICS IN MATHEMATICS.*Cat. I***MA 4892. TOPICS IN ACTUARIAL MATHEMATICS.***Cat. II*

Topics covered in this course would vary from one offering to the next. The purpose of this course will be to introduce actuarial topics that typically arise in the professional actuarial organization's curriculum beyond the point where aspiring actuaries are still in college. Topics might include ratemaking, estimation of unpaid claims, equity linked insurance products, simulation, or stochastic modeling of insurance products.

Recommended background: Could vary by the specific topics being covered, but would typically include an introduction to the theory of interest and an introduction to actuarial mathematics (MA 2211 and MA 3212 or equivalent).

This course will be offered in 2020-21, and in alternating years thereafter.

MA 4895. DIFFERENTIAL GEOMETRY.*Cat. II*

The course gives an introduction to differential geometry with a focus on Riemannian geometry. Starting with the geometry of curves and surfaces in the three-dimensional Euclidean space and Riemannian metrics in 2 and higher dimensions, the course introduces the first fundamental form, tangent bundles, vector fields, distance functions and geodesics, followed by covariant derivatives and second fundamental form. The proof of Gauss's Theorema Egregium is highlighted. Additional topics are by instructor's discretion. Students may not receive credit for both MA 489X and MA 4895.

Recommended background: Advanced Linear Algebra and Real Analysis (e.g., MA 2073 Theoretical Linear Algebra and MA 3831 Principles of Real Analysis, or equivalent)

MECHANICAL ENGINEERING

The second digit in mechanical engineering course numbers is coded as follows:

- 0 — General mechanical engineering
- 1 —
- 2 —
- 3 — Design
- 4 — Thermal—fluids
- 5 — Engineering mechanics
- 6 — Fluid mechanics—hydraulics
- 7 — Aerospace
- 8 — Materials
- 9 — Engineering experimentation

ME 1520. THE TECHNOLOGY OF ALPINE SKIING.*Cat. II*

This course explores science and engineering issues associated with equipment and technique for alpine skiing, particularly racing. A diverse group of technical subjects related to engineering mechanics are discussed: tribology, beams, rigid body motion, material science, machining and biomechanics. Specifically we will examine: ski-snow interactions, technique for gliding, turning and stepping, selection of line in racing; equipment design, testing and performance; and ski injuries. We will also address issues in the epidemiology of skiing injuries, the calculation of the cost of ski injuries to society, the impact of ski equipment technology on litigation and the impact of litigation on equipment and trail design.

This course will be offered in 2020-21, and in alternating years thereafter.

ME 1800. MANUFACTURING SCIENCE, PROTOTYPING, AND COMPUTER-CONTROLLED MACHINING.*Cat. I*

This course introduces students to manufacturing science and engineering and prototype part production. It emphasizes CNC (computer-controlled) machining. Students will learn how to go from a solid (CAD, computer-aided design) model to a machined part, using CAM software (computer-aided manufacturing) and CNC machining. They will also be exposed to associated issues in manufacturing process analysis, engineering design, material science, and in dimensional and surface metrology. Using machining as an example, the science of manufacturing processes is developed in a combination of class work and laboratory experience. The laboratory experience includes an experimental component that relates process variables in machining with performance and machined part quality. Students whose project work will necessitate fabrication of parts and those who want a background in manufacturing process science and engineering should take this course.

ME 2300. INTRODUCTION TO ENGINEERING DESIGN.*Cat. I*

This project based course introduces students to the engineering design process including; identifying the need, benchmarking, writing design specifications, evaluating alternative designs and selecting a final design. Student groups will construct and evaluate a working prototype of their design. Additional topics include; creativity, product liability, reverse engineering, patents, and codes of ethics for engineers. Extensive written reports and oral presentations are required.

Recommended background: computer-aided design (ES 1310), mechanics (ES 2501, ES 2502), and manufacturing (ME 1800).

ME/CHE 2301. NANOBIO TECHNOLOGY LABORATORY EXPERIENCE.*Cat. II*

The current developments and experimental skills in nanoscale bioscience and biotechnology will be introduced. Experimental skills such as nanomaterials synthesis, electron microscopy and introductory biotechnology techniques are presented. This course will provide students training in laboratory technique and data handling.

Recommended background: CH 1010 or equivalent.

This course will be offered in 2020-21, and in alternating years thereafter.

ME 2312. INTRODUCTION TO COMPUTATIONAL SOLUTIONS FOR ENGINEERING PROBLEMS.*Cat. I*

The purpose of this course is to introduce concepts of programming and numerical methods using Matlab within an engineering framework. The course will review basic linear algebra, statics, stress analysis, and engineering governing equations with solution pathways developed and presented as numerical programming problems. The fundamental programming techniques cover a variety of input and output formats typically encountered in engineering situations. Control and conditional loops, recognition and controlling numerical error, numerical integration and differentiation will be introduced and developed within an engineering framework.

Recommended background: Statics (ES 2501), Stress Analysis (ES 2502), General Physics-Mechanics (PH 1110), Differential and Integral Calculus (MA 1021, MA 1022) or equivalents.

ME 2820. MATERIALS PROCESSING.*Cat. I*

An introduction to material processing in manufacturing. This course provides important background for anyone interested in manufacturing, design engineering design, sales, or management.

Processing of polymers, ceramics, metals and composites is discussed. Processes covered include: rolling, injection molding, forging, powder metallurgy, joining and machining. The relationships between materials, processes, processing parameters and the properties of manufactured parts are developed. During the course the students should develop the ability to choose materials, processes, and processing parameters for designing manufacturing procedures to take a prototype part to production.

Recommended background: ME 1800 Materials Selection and Manufacturing Processes, and ES 2001 Introduction to Materials Science.

ME 3310. KINEMATICS OF MECHANISMS.*Cat. I*

An introduction to the synthesis and analysis of linkages, cams and gear trains is presented. The design process is introduced and used to solve unstructured design problems in linkage and cam design. Algebraic and graphical techniques to analyze the displacement, velocity and acceleration of linkages and cams are developed. Computer programs for the design and analysis of linkages are used by students. Results of student design projects are presented in professional engineering reports.

Recommended background: Ordinary Differential Equations (MA 2051), statics (ES 2501), dynamics (ES 2503).

ME 3311. DYNAMICS OF MECHANISMS AND MACHINES.*Cat. II*

This course provides an in-depth study of forces in dynamic systems. Dynamic force analysis is developed using matrix methods. Computer programs are used to solve the sets of simultaneous equations derived by students for realistic, unstructured design problems. Inertial and shaking forces, elementary mechanical vibrations, torque-time functions, rotational and reciprocating balance and cam dynamics are covered using the internal combustion engine as a

design example. Students execute unstructured design projects and prepare professional engineering reports on the results. Computers are used extensively to solve the dynamic equations.

Recommended background: Ordinary Differential Equations (MA 2051), statics (ES 2501), dynamics (ES 2503), kinematics (ME 3310), linear algebra.

This course will be offered in 2020-21, and in alternating years thereafter.

ME 3320. DESIGN OF MACHINE ELEMENTS.

Cat. I

This is an introductory course in mechanical design analysis, and it examines stress and fatigue in many machine elements. Common machine elements are studied and methods of selection and design are related to the associated hardware.

Topics covered include: combined stresses, fatigue analysis, design of shafts, springs, gears, bearings and miscellaneous machine elements.

Recommended background: mechanics (ES 2501, ES 2502, ES 2503), materials (ME 1800, ME 2820), computer programming (CS 1101 or CS 1102).

ME 3411. INTERMEDIATE FLUID MECHANICS.

Cat. I

This course provides a mixture of theory and applications and covers topics not found in the introductory course in fluid mechanics. Topics include kinematics of fluid flow, potential flow, Navier-Stokes and the theory of viscous flow, basic turbulence, boundary layer theory, and introduction to compressible flow.

Recommended background: Introductory fluid mechanics (ES 3004, or equivalent).

ME 3501. ELEMENTARY CONTINUUM MECHANICS.

Cat. II

In typical mathematics courses, students learn principles and techniques by solving many short and specially prepared problems. They rarely gain experience in formulating and solving mathematical equations that apply to real life engineering problems. This course will give students this type of applied mathematical experience.

The course emphasizes the application of basic laws of nature as they apply to differential elements which lead to differential equations that need to be solved; all of these ideas are used in higher level engineering science courses such as fluid mechanics, heat transfer, elasticity, etc. Emphasis will be placed on understanding the physical concepts in a problem, selecting appropriate differential elements, developing differential equations, and finding ways to solve these equations. Limitations on the mathematical solutions due to assumptions made will be considered.

Recommended background: Ordinary Differential Equations (MA 2051), statics (ES 2501), dynamics (ES 2503).

This course will be offered in 2020-21, and in alternating years thereafter.

ME 3506. REHABILITATION ENGINEERING.

Cat. I

This project based design course focuses on the design and use of devices to aid persons with disabilities. Human factors and ergonomics are integrated into all phases of the design process with particular emphasis on the user interface.

Topics include: defining the problem, developing design specifications, development of preliminary designs, selection, realization and evaluation of a final design. Students will also learn how physical, and cognitive parameters, safety, economics, reliability and aesthetics need to be incorporated into the design process.

Recommended background: mechanics (ES 2501, ES 2502, ES 2503), design (ME 2300), materials (ME 1800) and electrical engineering (ECE 2010).

ME 3820. COMPUTER-AIDED MANUFACTURING.

Cat. I

This introductory course in modern control systems will give students an understanding of the basic techniques, and the range of equipment used in most computer controlled manufacturing operations. The class work is reinforced by hands-on laboratories in the Robotics/CAM lab. Modeling and analysis of machining processes, and applications of PLC (programmable logic control) are included.

Class topics include: Manufacturing Automation, Microcomputers for Process Monitoring and Control, Computer Numerical Control, Switching Theory and Ladder Logic, Transducers and Signal Conditioning, and Closed Loop Digital Control. The laboratories allow students to program and implement several types of the controllers, and will provide an introduction to the topic of industrial robotics.

Recommended background: manufacturing (ME 1800), materials processing (ME 2820), elementary computer/logic device programming.

ME 3901. ENGINEERING EXPERIMENTATION.

Cat. I

A course designed to develop analytical and experimental skills in modern engineering measurement methods, based on electronic instrumentation and computer-based data acquisition systems. The lectures are concerned with the engineering analysis and design as well as the principles of instrumentation, whereas the laboratory periods afford the student an opportunity to use modern devices in actual experiments.

Lecture topics include: review of engineering fundamentals and, among others, discussions of standards, measurement and sensing devices, experiment planning, data acquisition, analysis of experimental data, and report writing.

Laboratory experiments address both mechanical and thermal systems and instrumentation in either traditional mechanical engineering (heat transfer, flow measurement/visualization, force/torque/strain measurement, motion/vibration measurement) or materials engineering (temperature and pressure measurements in materials processing, measurement of strain and position in mechanical testing of materials). Each year students will be notified which type of experiments will be used in each term offering. Students may also consult with their academic advisor or the Mechanical Engineering department office.

Recommended background: mathematics (MA 2051), thermo-fluids (ES 3001, ES 3003, ES 3004), mechanics (ES 2501, ES 2502, ES 2503), materials (ES 2001).

ME 3902. PROJECT-BASED ENGINEERING EXPERIMENTATION.

Cat. I

This course is designed to develop experimental skills in engineering measurement methods, based on electronic instrumentation and computer-based data acquisition systems, such as the Raspberry Pi (a primarily digital microprocessor) and an Arduino (a primarily analog microcontroller). The lectures are concerned with the engineering design requirements as well as the principles of instrumentation, whereas the laboratory modules afford the student an opportunity to use these devices in actual experiments. Lecture topics include: discussions of standards, measurement and sensing devices, experiment planning, data acquisition, analysis of experimental data, and report writing. Laboratory experiments address mechanical (force/torque/strain measurements, motion/vibration measurements), energy (heat transfer, temperature, flow measurements), materials measurements (materials processing, measurement of strain and position in mechanical testing of materials), and instrumentation. The course culminates with an open-ended project of the students choosing. This open-ended project will illuminate the skills gained by the student to utilize multiple sensors and equipment to monitor and/or control physical situations.

Recommended background: introductory heat transfer (ES3003 or equivalent), introductory stress and dynamic mechanics (ES 2502 & ES 2503 or equivalents), introductory electrical and computer engineering (ES2010 or equivalent) and introductory materials (such as ES 2001 or equivalent).

ME 4320. ADVANCED ENGINEERING DESIGN.

Cat. I

This course integrates students' background in ME in a one-term design project that is usually taken from a local company. Students must organize themselves and the project to successfully realize a product that meets customer needs. Activities include problem definition, design analysis, mathematical modelling, CAD modelling, manufacturing, testing, liaison to vendors, customer relations, marketing, technical management, purchasing, report writing, and oral presentations.

Recommended background: mechanisms (ME 3310, ME 3311), stress analysis (ES 3502), design (ME 3320), thermo-fluids (ES 3001, ES 3003, ES 3004), materials (ES 2001), manufacturing (ME 1800).

ME/RBE 4322. MODELING AND ANALYSIS OF MECHATRONIC SYSTEMS.

Cat. I

This course introduces students to the modeling and analysis of mechatronic systems. Creation of dynamic models and analysis of model response using the bond graph modeling language are emphasized. Lecture topics include energy storage and dissipation elements, transducers, transformers, formulation of equations for dynamic systems, time response of linear systems, and system control through open and closed feedback loops. Computers are used extensively for system modeling, analysis, and control. Hands-on projects will include the reverse engineering and modeling of various physical systems. Physical models may sometimes also be built and tested.

Recommended background: mathematics (MA 2051, MA 2071), fluids (ES 3004), thermodynamics (ES 3001), mechanics (ES 2501, ES 2503)

ME 4422. DESIGN AND OPTIMIZATION OF THERMAL SYSTEMS.*Cat. I*

This course introduces students to design of small and large scale optimal thermal systems. The hardware associated with thermal systems includes fans, pumps, compressors, engines, expanders, turbines, heat and mass exchangers, and reactors, all interconnected with some form of conduits. Generally, the working substances are fluids. These types of systems appear in such industries as power generation, electric and gas utilities, refrigeration and cryogenics, air conditioning and heating, food, chemical, petroleum, and other process industries.

This course is intended for mechanical engineering students, especially those seeking a concentration in Thermal-Fluids. Additionally, this course might be of interest to students in Aerospace Engineering and Chemical Engineering.

Recommended Background: Knowledge in thermodynamics (ES 3001), fluid mechanics (ES 3004), heat transfer (ES 3003), and introduction to design (ME 2300)

ME 4424. RADIATION HEAT TRANSFER APPLICATION AND DESIGN.*Cat. II*

Radiation Heat Transfer Applications will develop the student's knowledge of radiation and multi-mode heat transfer. Fundamentals of radiation will be covered: radiative properties of surfaces; view factors; exchange between black and grey surfaces; emission and absorption of gases; and flame radiation. Use of numerical methods will be emphasized as appropriate for solution of applications: the select numerical methods (numerical integration, matrix methods, ODE solutions) can be learned during the course. The course will conclude with a design exercise to be completed by each student. Each exercise will highlight radiation in a realistic scenario that requires multi-mode heat transfer and fluid mechanics analysis to develop the design solution. Exercise topics will come from subjects such as: solar power plants, solar effects on buildings, furnaces, fire safety in the built environment, etc.

Recommended background: differential and integral calculus, and ordinary differential equations (MA 2051 or equivalent), and thermodynamics, fluid mechanics and heat transfer (ES 3001, 3004, 3003 or equivalents).

Students may not receive credit for both ME 4424 and ME 442X.

This course will be offered in 2020-21, and in alternating years thereafter.

ME 4429. THERMOFLUID APPLICATION AND DESIGN.*Cat. I*

This course integrates thermodynamics, fluid mechanics and heat transfer through the use of design projects involving modern technologies, such as electronic cooling, vapor compression power and refrigeration cycles. Activities include problem definition, design creation and analysis, mathematical modeling, cost analysis and optimization.

Recommended background: knowledge in thermodynamics, fluid mechanics, heat transfer and introduction to design (ES 3001, ES 3004 and ES 3003, ME 2300 or equivalent).

ME 4430. INTEGRATED THERMOMECHANICAL DESIGN AND ANALYSIS.*Cat. II*

Current state-of-the-art computer based methodologies used in the design and analysis of thermomechanical systems will be presented and illustrated by selected laboratory demonstrations, and used in projects. Projects will include thermal, mechanical, electronic, and photonic loads of steady state and dynamic nature and will integrate design, analysis, and testing. Students will prepare a technical report and present their results. Topics will include, but not be limited to, thermomechanics of fiber optic telecommunication cables, high-energy beam interactions with materials, shape memory alloys, microelectronics, MEMS and mechatronics.

Recommended background: MA 2051, ES 2001, ES 2502, ES 3003, ME 3901, and an introduction to design.

This course will be offered in 2020-21, and in alternating years thereafter.

ME/BME 4504. BIOMECHANICS.*Cat. II*

This course emphasizes the applications of mechanics to describe the material properties of living tissues. It is concerned with the description and measurements of these properties as related to their physiological functions. Emphasis on the interrelationship between biomechanics and physiology in medicine, surgery, body injury and prostheses.

Topics covered include: review of basic mechanics, stress, strain, constitutive equations and the field equations, viscoelastic behavior, and models of material behavior. The measurement and characterization of properties of tendons, skin,

muscles and bone. Biomechanics as related to body injury and the design of prosthetic devices.

Recommended background: mechanics (ES 2501, ES 2502, ES 2503, ME 3501), mathematics (MA 2051).

This course will be offered in 2019-20, and in alternating years thereafter.

ME 4506. MECHANICAL VIBRATIONS.*Cat. I*

This course is an introduction to the fundamental concepts of mechanical vibrations, which are important for design and analysis of mechanical and structural systems subjected to time-varying loads. The objective of the course is to expose the students to mathematical modeling and analysis of such systems

Topics covered include: formulation of the equations of motion using Newton's Laws, D'Alembert's Principle and energy methods; prediction of natural frequency for single-degree-of-freedom systems; modeling stiffness characteristics, damping and other vibrational properties of mechanical systems; basic solution techniques by frequency response analysis and convolution integral methods. Examples may include analysis and design for transient passage through resonance; analysis and design of vibration measurement devices; introductory rotordynamics.

The course is mainly focused on analysis of single-degree-of-freedom systems, however a basic introduction into multidegree-of-freedom systems is also presented. Computer-based project may be suggested.

Recommended background: Ordinary Differential Equations (MA 2501), Statics (ES 2501), Dynamics (ES 2503).

ME 4512. INTRODUCTION TO THE FINITE ELEMENT METHOD.*Cat. I*

This course serves as an introduction to finite element analysis (FEA) for stress analysis problems. Finite element equations are developed for several element types from stiffness and energy approaches and used to solve simple problems. Element types considered include spring, truss, beam, two-dimensional (plane stress/strain and axisymmetric solid), three-dimensional and plates. Stress concentrations, static failures, and fatigue failures are considered for each element type. Emphasis will be placed on knowing the behavior and usage of each element type, being able to select a suitable finite element model for a given problem, and being able to interpret and evaluate the solution quality. A commercial, general-purpose finite element computer program is used to solve problems that are more complex. Projects are used to introduce the use of FEA in the iterative design process.

Recommended background: Mathematics (MA 2051, MA 2071), Mechanics (ES 2501 & ES 2502 or CE 2000 & CE 2001).

ME/BME 4606. BIOFLUIDS.*Cat. II*

This course emphasizes the applications of fluid mechanics to biological problems. The course concentrates primarily on the human circulatory and respiratory systems. Topics covered include: blood flow in the heart, arteries, veins and microcirculation and air flow in the lungs and airways. Mass transfer across the walls of these systems is also presented.

Recommended background: continuum mechanics (ME 3501), fluids (ES 3004).

This course will be offered in 2020-21, and in alternating years thereafter.

ME 4718. ADVANCED MATERIALS WITH AEROSPACE APPLICATIONS.*Cat. I*

This course covers topics on the design, fabrication and behavior of advanced materials used in structural and propulsion components of aerospace vehicles. The design, fabrication, and properties of polymer, metal and ceramic matrix composites used in aerospace structures are presented. The fabrication and behavior of aluminum and titanium alloys used in propulsion components as well as the processing and performance of Nickel-based superalloys are also presented. The fundamentals of coatings for high temperature oxidation, hot corrosion, and thermal protection are introduced.

Recommended background: Introduction to Materials Science (ES 2001), Stress Analysis (ES 2502) or equivalent.

ME 4810. AUTOMOTIVE MATERIALS AND PROCESS DESIGN.*Cat. II*

This course focuses on materials used in the automotive industry. Students complete a term-long project that integrates design, materials selection and processing considerations. Activities include: problem definition, development of design specifications, development and analysis of alternative designs, conceptual designs and materials and process selection. Students will consider cost, and environmental impact of alternative material choices. Students will present their results in intermediate and final design reviews.

Recommended background: materials science (ES 2001), stress analysis (ES 2502), or equivalent.

This course will be offered in 2019-20, and in alternating years thereafter.

ME 4813. CERAMICS AND GLASSES FOR ENGINEERING APPLICATIONS.*Cat. II*

This course develops an understanding of the processing, structure, property, performance relationships in crystalline and vitreous ceramics. The topics covered include crystal structure, glassy structure, phase diagrams, microstructures, mechanical properties, optical properties, thermal properties, and materials selection for ceramic materials. In addition the methods for processing ceramics for a variety of products will be included.

Recommended Background: ES 2001 or equivalent.

This course will be offered in 2019-20, and in alternating years thereafter.

ME/BME 4814. BIOMATERIALS.*Cat. I*

A course specializing in material selection and special problems associated with biomedical engineering.

Topics covered include: fundamentals of metals, plastics, and ceramics and how they can be applied to biomedical applications. Case histories of successful and unsuccessful material selections. Current literature is the primary source of material.

Recommended background: materials (ES 2001).

ME/RBE 4815. INDUSTRIAL ROBOTICS.*Cat. I*

This course introduces students to robotics within manufacturing systems. Topics include: classification of robots, robot kinematics, motion generation and transmission, end effectors, motion accuracy, sensors, safety systems, robot control and automation. This course is a combination of lecture, laboratory work, and project work, and utilizes industrial robots. Through the laboratory work, students will become familiar with robotic programming (using a robotic programming language RAPID) and the robotic teaching mode. The experimental component of the laboratory exercise measures the motion and positioning capabilities of robots as a function of several robotic variables and levels, and it includes the use of experimental design techniques.

Recommended background: manufacturing (ME 1800), kinematics (ME 3310), control (ES 3011), and computer programming.

ME 4821. PLASTICS.*Cat. II*

This course develops the processing, structure, property, performance relationships in plastic materials. The topics covered include polymerization processes, chain structure and configuration, molecular weights and distributions, amorphous and crystalline states and glass-rubber transition. The principles of various processing techniques including injection molding, extrusion, blow molding, thermoforming and calendaring will be discussed. The physical and mechanical properties of polymers and polymer melts will be described with specific attention to rheology and viscoelasticity. Pertinent issues related to environmental degradation and recyclability will be highlighted.

Recommended Background: ES 2001 or equivalent.

This course will be offered in 2019-20, and in alternating years thereafter.

ME 4832. CORROSION AND CORROSION CONTROL.*Cat. II*

An introductory course designed to acquaint the student with the different forms of corrosion and the fundamentals of oxidation and electro-chemical corrosion.

Topics covered include: corrosion principles, environmental effects, metallurgical aspects, galvanic corrosion, crevice corrosion, pitting, intergranular corrosion, erosion corrosion, stress corrosion, cracking and hydrogen embrittlement, corrosion testing, corrosion prevention, oxidation and other high-temperature metal-gas reactions.

Recommended background: materials (ES 2001).

This course will be offered in 2019-20, and in alternating years thereafter.

ME 4840. PHYSICAL METALLURGY.*Cat. I*

Fundamental relationships between the structure and properties of engineering materials are studied. Principles of diffusion and phase transformation are applied to the strengthening of commercial alloy systems. Role of crystal lattice defects on material properties and fracture are presented.

Strongly recommended as a senior-graduate level course for students interested in pursuing a graduate program in materials or materials engineering at WPI, or other schools.

Recommended background: materials (ES 2001, ME 2820).

ME 4875/MTE 575. INTRODUCTION TO NANOMATERIALS AND NANOTECHNOLOGY.*Cat. I*

This course introduces students to current developments in nanoscale science and technology. The current advance of materials and devices constituting of building blocks of metals, semiconductors, ceramics or polymers that are nanometer size (1-100 nm) are reviewed. The profound implications for technology and science of this research field are discussed. The differences of the properties of matter on the nanometer scale from those on the macroscopic scale due to the size confinement, predominance of interfacial phenomena and quantum mechanics are studied. The main issues and techniques relevant to science and technologies on the nanometer scale are considered. New developments in this field and future perspectives are presented. Topics covered include: fabrication of nanoscale structures, characterization at nanoscale, molecular electronics, nanoscale mechanics, new architecture, nano-optics and societal impacts.

Recommended background: ES 2001 Introduction to Materials or equivalent
Some sections of this course may be offered as Writing Intensive (WI).

ISU. SPECIAL TOPICS.*Cat. I*

For students who wish to pursue in depth various mechanical engineering topics.

Topics covered include: theoretical or experimental studies in subjects of interest to mechanical engineers.

Registration as a junior or senior is assumed.

MILITARY SCIENCE

ML 1011. FOUNDATIONS OF OFFICERSHIP I.*Cat. I (0 units w/grade)*

Introduction to issues and competencies that are central to a commissioned officer's responsibilities. Establishes a framework for understanding officership, leadership, and Army values. Additionally, the semester addresses "life skills" including fitness and time management. Participation in weekly training leadership laboratories; off campus training sessions (field training exercises) and other special events is required.

ML 1012. FOUNDATIONS OF OFFICERSHIP II.*Cat. I (1/9 unit after completion of 1011 and 1012)*

This course continues the studies begun in ML 1011. Students make oral presentations on the elements of leadership, enhancing effective communication. Students begin to develop leadership potential by instilling self-confidence and fostering teamwork through basic survival techniques (e.g., water survival). Participation in weekly training leadership laboratories; off campus training sessions (field training exercises) and other special events is required.

ML 1021. BASIC LEADERSHIP I.*Cat. I (0 units w/grade)*

ML 1021 expands upon the fundamentals introduced in the previous term by focusing on communications, leadership, and problem solving. "Life skills" lessons in this semester include: problem solving, goal setting, interpersonal communication skills, and assertiveness skills. Participation in weekly training leadership laboratories; off campus training sessions (field training exercises) and other special events is required.

ML 1022. BASIC LEADERSHIP II.*Cat. I (1/9 unit after completion of 1021 and 1022)*

ML 1022 continues by providing cadets with interesting lessons yielding immediately useful skills. The course also gives accurate information about life in the Army, including the organization of the Army, employment benefits, and work experiences of junior officers. Participation in weekly training leadership laboratories; off campus training sessions (field training exercises) and other special events is required.

ML 2011. INDIVIDUAL LEADERSHIP STUDIES I.*Cat. I (1/12 unit)*

Introduces students to team building techniques. Students build upon the basic leader principals and leadership development methodologies to refine their understanding of leadership. How to build teams, how to influence, how to communicate, how and when to make decision, and creative problem-solving. Participation in weekly training leadership laboratories; off campus training sessions (field training exercises) and other special events is required.

Recommended background: ML 1022

ML 2012. INDIVIDUAL LEADERSHIP STUDIES II.*Cat. I (1/12 unit)*

The curriculum focuses on building character. Where years one, three and four focus on mastering definitions, concepts, ideas and principles, year two focuses on direct, physical experiences. Year two centers on giving cadets the opportunity to apply, practice and experience leadership principles. Cadets are asked to reflect upon their actions and those of others. Participation in weekly training leadership laboratories; off campus training sessions (field training exercises) and other special events is required.

Recommended background: ML 2011

ML 2021. LEADERSHIP AND TEAMWORK I.*Cat. I (1/12 unit)*

Students continue the study of leader principals and are introduced to formal policies such as equal opportunity, ethics, and values. Military communication skills are trained along with the principles of camouflage. Complex cases of risk management are studied. Students will submit a written information paper. Participation in weekly training leadership laboratories; off campus training sessions (field training exercises) and other special events is required.

Recommended background: ML 2012

ML 2022. LEADERSHIP AND TEAMWORK II.*Cat. I (1/12 unit)*

This course covers small unit movement and military tactics. It combines previous study in weapons, movement and communications to teach the combination of firepower and maneuver to the student. This course also teaches the student the elements of how the military trains its personnel. A written decision paper and practical exercise in conducting training is included in this course. Participation in weekly training leadership laboratories; off campus training sessions (field training exercises) and other special events is required.

Recommended background: ML 2021

ML 3011. LEADERSHIP AND PROBLEM SOLVING I.*Cat. I (1/6 unit)*

This course focuses on development of individual leadership abilities. This course reviews leadership styles, management strategies and training techniques for leaders of small units. Promoting and developing communication skills and teamwork are addressed. Examines leadership of small units conducting conventional combat operations and tactical employment of weapon systems. Development of oral communication skills through military briefings and issuance of operations orders. Special attention is placed on evaluations through practical exercises. Participation in weekly training leadership laboratories; off campus training sessions (field training exercises) and other special events is required. Recommended background: Students must have completed the basic course or ROTC Leadership Training course and have signed a personal contract with the US Army. Department Head approval is required.

ML 3012. LEADERSHIP AND PROBLEM SOLVING II.*Cat. I (1/6 unit)*

Student learns how to conduct crisis planning and management. Discussion of roles and functions of combat arms, combat support, and combat service support branches. Case studies of small-unit operations are studied. Introduction to Army special operations, military operations other than war, and trends in the military. Students write self-evaluations throughout this course. Students are graded on their performance during leadership practical exercises. Attendance at monthly labs and formal social functions is required. Students write self-evaluations through this course. Students are graded on their performance during leadership practical exercises. Participation in weekly training leadership laboratories; off campus training sessions (field training exercises) and other special events is required.

Recommended background: ML 3011

ML 3021. LEADERSHIP AND ETHICS I.*Cat. I (1/6 unit)*

ML 3021 is designed to continue the development as leaders by presenting instruction in the three foundational areas of leadership, interpersonal communication, and values and ethics. The leadership module contains an examination of Army leadership doctrine followed by expansion on key leadership concepts and provide feedback for cadet leadership self-development efforts. Participation in weekly training leadership laboratories; off campus training sessions (field training exercises) and other special events is required.

ML 3022. LEADERSHIP AND ETHICS II.*Cat. I (1/6 unit)*

The main thrust of the communication module is the opportunity for cadets to present an information briefing and receive feedback from both instructor and fellow students. The last module of the term contains lessons that focus on values, ethics, ethical decision-making, consideration of others, and spiritual needs. Participation in weekly training leadership laboratories; off campus training sessions (field training exercises) and other special events is required.

Recommended background: ML 3021

ML 4011. LEADERSHIP AND MANAGEMENT I.*Cat. I (1/6 unit)*

ML 4011 begins with a series of lessons designed to enable the cadets to make informed career decisions as they prepare their accessions documents. Lessons concentrate on Army operations and training management, communications and leadership skills and support the beginning of the final transition from cadet to lieutenant. The course focuses cadets, early in the year, on attaining knowledge and proficiency in several critical areas they will need to operate effectively as Army officers. These areas include: the Army's training management system, coordinating activities with staffs, and counseling skills. While the proficiency attained in each of these areas will initially be at the apprentice level, cadets will continue to sharpen these skills as they perform their roles as cadet officers in the ROTC battalion and as new lieutenants after commissioning. At the end of this semester cadets should possess the fundamental skills, attributes, and abilities to operate as competent leaders in the cadet battalion and confidently shoulder the responsibilities entrusted to them. Participation in weekly training leadership laboratories; off campus training sessions (field training exercises) and other special events is required.

ML 4022. LEADERSHIP AND MANAGEMENT II.*Cat. I (1/6 unit)*

This Course focuses on completing the transition from cadet to lieutenant. As an expansion of the Ethics instruction in ML 3021, the course starts with an examination of unit ethical climate and the commander's role as the moral anchor of the unit. This is followed by a module addressing military law and leadership. The next module reinforces previous instruction on the organization of the Army and introduces how the Army organizes for operations from the tactical to strategic level. This is followed by instruction on administrative and logistical management that focuses on the fundamentals of soldier and unit level support. Next is a short module that focuses on preparing cadets for their forthcoming commissioning and military service. At the core of this semester is the Advanced Course's Capstone Exercise. This twelve-lesson exercise directly reinforces all modules from this term, and also incorporates and reinforces many learning objectives from modules throughout the entire curriculum. The Capstone Exercise requires cadets, both individually and collectively, to apply their knowledge to solve problems and confront situations commonly faced by junior officers. Upon completion of this course the cadets will be prepared to shoulder the responsibility of being a commissioned officer in the United States Army. Participation in weekly training leadership laboratories; off campus training sessions (field training exercises, Military Staff Ride and other special events is required.

ML 4023. OFFICERSHIP.*Cat. I (1/6 unit)*

This course is a continuation of ML 4022.

ML 4024. TRANSITION TO LIEUTENANT.*Cat. I (1/6 unit)*

Cadets organize and lead all the junior cadets. This course covers the military legal system, personnel actions and personal finances. It certifies fundamental competencies in land navigation, tactics, counseling, and interpersonal communications. This course requires three hours of class work and three hours of physical fitness per week. Participation in weekly training leadership laboratories; off campus training sessions (field training exercises) and other special events is required.

Recommended background: ML 4023

PHYSICAL EDUCATION

GENERAL PHYSICAL EDUCATION COURSES

PE 1002. INTRO TO VOLLEYBALL & SQUASH.

Cat. I (1/12 unit)

Introduction to the sports through skill development and play.

PE 1003. INTRODUCTION TO BADMINTON.

Cat. I (1/12 unit)

Introduction to the sport through skill development and play.

PE 1006. WELLNESS.

Cat. I (1/12 unit)

Introductory course designed to acquaint students with knowledge and skills necessary to make choices that foster health and well-being.

PE 1007. BASIC WATER SAFETY.

Cat. I (1/12 unit)

For the intermediate to advanced swimmer only. Students will learn about water recreational activities and how to remain safe while participating in them. Opportunity to learn the necessary means for safety in/near water and basic rescue techniques.

PE 1008. ROWING FOR FITNESS.

Cat. I

This course will teach basic rowing training techniques and principles with the goal for students to develop and implement an individualized conditioning program for themselves. All classes will be conducted on-campus through the use of rowing machines located in the Sports and Recreation Center.

PE 1009. WALKING FOR FITNESS.

Cat. I

This course will teach basic walking techniques and principles with the goal for students to develop and implement an individualized conditioning program for themselves.

PE 1011. TOUCH FOOTBALL.

Cat. I (1/12 unit)

Introduction to basic rules and individual/team skill development with practical application through game competition.

PE 1012. BASKETBALL.

Cat. I (1/12 unit)

Introduction to basic rules and individual/team skill development with practical application through game competition.

PE 1013. SOFTBALL.

Cat. I (1/12 unit)

Introduction to basic rules and individual/team skill development with practical application through game competition.

PE 1015. BADMINTON & TABLE TENNIS.

Cat. I (1/12 unit)

Instruction will focus on basic strokes and techniques. Rules, strategy and play will be integrated as students' skills develop.

PE 1016. SQUASH & RACQUETBALL.

Cat. I (1/12 unit)

Instruction will focus on basic strokes and techniques. Rules, strategy and play will be integrated as students' skills develop.

PE 1017. BEGINNING SWIMMING.

Cat. I (1/12 unit)

For the non-swimmer. Students will receive instruction in basic survival skills and the primary techniques to learn to swim safely.

PE 1018. CO-ED VOLLEYBALL.

Cat. I (1/12 unit)

Introduction to basic rules and individual/team skill development with practical application through game competition.

PE 1019. SOCCER.

Cat. I

Introduction to basic rules and individual/team skill development with practical application through game competition.

PE 1054. PLYOMETRICS.

Cat. I (1/12 unit)

This course will teach the use of body weight to develop personal strength and conditioning.

PE 1055. PHYSICAL CONDITIONING.

Cat. I (1/12 unit)

This course will teach basic strength training principles and techniques. Students will develop and implement an individualized conditioning program.

PE 1059. WEIGHT TRAINING FOR BEGINNERS.

Cat. I (1/12 unit)

The goal of course is to provide students with the knowledge and skills in basic weight training. This course is designed to educate students about the proper use of weight training equipment and how to create their own weight training exercise program. The basic essentials for starting a weight training routine.

PE 1070. LEISURE EDUCATION: REDEFINING SOCIAL NORMS.

Cat. I (1/12 unit)

Introductory course designed to explore various leisure education alternatives.

PE 1077. SWIMMING FOR FITNESS.

Cat. I (1/12 unit)

For the intermediate to advanced swimmer. This class is geared toward swimming for fitness purposes. Workouts will be administered each class period with students developing the knowledge to create workouts for themselves.

PE 1078. AQUATIC CONDITIONING.

Cat. I

This course will teach aquatic conditioning (aerobics, walking, strength and interval training) with the goal for students to develop and implement an individualized aquatic conditioning program for themselves. For the intermediate and advanced swimmer. All classes will be conducted on-campus through the use of the pool located in the Sports and Recreation Center.

PE 1080. AQUATIC GAMES.

Cat. I (1/12 unit)

Students will develop an understanding and appreciation of a variety of aquatic games through skill development and game play.

PE 1099. HEALTHY ALTERNATIVE PHYSICAL EDUCATION COURSES.

Cat. I (1/12 unit)

In each term, specific PE courses are offered to provide a variety of wellness, dance and healthy alternatives to traditional PE sport-based classes. The specific courses are subject to change on a yearly basis in order to provide flexibility in the PE offerings based upon the latest trends in wellness and dance. The focus of these classes is more on individual fitness, wellness and education, with instruction provided to all students in the classes.

CLUB SPORTS PROGRAM (PE 1200-series)

PE 1201	Club Sport - Alpine Ski Team
PE 1202	Club Sport - Badminton
PE 1203	Club Sport - Ballroom Dancing
PE 1204	Club Sport - Dance Team
PE 1205	Club Sport - Fencing Team
PE 1206	Club Sport - Ice Hockey Team
PE 1207	Club Sport - Karate
PE 1208	Club Sport - Men's Rugby Team
PE 1209	Club Sport - Women's Rugby Team
PE 1210	Club Sport - Men's Ultimate Frisbee Team
PE 1211	Club Sport - Women's Ultimate Frisbee Team
PE 1212	Club Sport - Men's Lacrosse Team
PE 1213	Club Sport - Women's Lacrosse Team
PE 1214	Club Sport - Men's Volleyball Team
PE 1215	Club Sport - Outing: Bouldering
PE 1216	Club Sport - Pep Band
PE 1217	Club Sport - Sailing
PE 1218	Club Sport - Social Dance
PE 1219	Club Sport - SOMA: Capoeira
PE 1220	Club Sport - SMAS: Boffer Games
PE 1221	Club Sport - Running

VARSITY ATHLETICS PROGRAM (PE 2000-series)

PE 2001	Varsity Football Team
PE 2002	Varsity Men's Soccer Team
PE 2003	Varsity Women's Soccer Team
PE 2004	Varsity Field Hockey Team
PE 2005	Varsity Women's Volleyball Team
PE 2006	Varsity Men's & Women' Cross Country Team
PE 2007	Varsity Wrestling Team
PE 2008	Varsity Men's Basketball Team
PE 2009	Varsity Women's Basketball Team
PE 2010	Varsity Men's & Women's Swim Team
PE 2011	Varsity Men's & Women's Indoor Track Team
PE 2012	Varsity Baseball Team
PE 2013	Varsity Softball Team
PE 2014	Varsity Men's & Women's Outdoor Track Team
PE 2015	Varsity Men's Crew Team
PE 2016	Varsity Women's Crew Team

PHYSICS

The second digit in physics course numbers is coded as follows.

- 1 — General physics
- 2 — Theoretical mechanics, statistical physics, kinetic theory, etc.
- 3 — Electricity and magnetism, electromagnetic theory
- 4 — Quantum mechanics
- 5 — Particular topics
- 6 — Laboratory

INTRODUCTORY PHYSICS SEQUENCE

There are four course topics in the introductory physics sequence. The four topics are Classical Mechanics (PH 1110/PH 1111), Electricity and Magnetism (PH 1120/PH 1121), Modern Physics (PH 1130), and Oscillations and Waves (PH 1140). Each course includes a laboratory component.

Students should take either PH 1110 or PH 1111, but not both; similarly, either PH 1120 or PH 1121, but not both. The primary difference between the PH 1110-PH 1120 option and PH 1111-PH 1121 is that the material in PH 1111- PH 1121 is treated somewhat more formally and rigorously than in PH 1110-PH 1120, thus presuming a better-than-average mathematics background. The recommended mathematics background for each course is indicated in the respective course description and should be considered carefully in each case.

Because the topics covered in the two mechanics and in the two electricity and magnetism courses are the same, it is possible to cross over from one sequence to the other. For example, PH 1120 could be taken after PH 1111, or, upon consulting with the course instructor, PH 1121 could be taken after successful completion of PH 1110. Finally, it should be noted that any combination of the first two introductory courses provides adequate preparation for both of the remaining courses in Modern Physics (PH 1130), and Oscillations and Waves (PH 1140).

The courses in classical mechanics and electricity and magnetism are regarded as essential preparation for many fundamental engineering courses as well as for further work in physics. PH 1130 gives a first introduction to modern physics and is designed to provide a context for the appreciation of present-day advances in physics and high-technology applications. PH 1140 deals in depth with oscillating systems, a topic area of fundamental importance in physics, and whose engineering applications span the range from electromagnetic oscillations to the mechanical vibrations of machinery and structures.

PH 1110. GENERAL PHYSICS—MECHANICS.

Cat. I

Introductory course in Newtonian mechanics.

Topics include: kinematics of motion, vectors, Newton's laws, friction, work-energy, impulse-momentum, for both translational and rotational motion.

Recommended background: concurrent study of MA 1021.

Students may not receive credit for both PH 1110 and PH 1111.

PH 1111. PRINCIPLES OF PHYSICS—MECHANICS.

Cat. I

An introductory course in Newtonian mechanics that stresses invariance principles and the associated conservation laws.

Topics include: kinematics of motion, vectors and their application to physical problems, dynamics of particles and rigid bodies, energy and momentum conservation, rotational motion.

Recommended background: concurrent study of MA 1023 (or higher).

Students with limited prior college-level calculus preparation are advised to take PH 1110.

Students may not receive credit for both PH 1111 and PH 1110.

PH 1120. GENERAL PHYSICS—ELECTRICITY AND MAGNETISM.

Cat. I

An introduction to the theory of electricity and magnetism.

Topics include: Coulomb's law, electric and magnetic fields, capacitance, electrical current and resistance, and electromagnetic induction.

Recommended background: working knowledge of the material presented in PH 1110 or PH 1111 and concurrent study of MA 1022.

Students may not receive credit for both PH 1120 and PH 1121.

PH 1121. PRINCIPLES OF PHYSICS—ELECTRICITY AND MAGNETISM.

Cat. I

An introduction to electricity and magnetism, at a somewhat higher mathematical level than PH 1120.

Topics include: Coulomb's Law, electric fields and potentials, capacitance, electric current and resistance, magnetism, and electromagnetic induction.

Recommended background: working knowledge of material covered in PH 1111 and concurrent study of MA 1024 (or higher). Students concurrently taking MA 1022 or MA 1023 are advised to take PH 1120.

Students may not receive credit for both PH 1121 and PH 1120.

PH 1130. MODERN PHYSICS.

Cat. I

An introduction to the pivotal ideas and developments of twentieth-century physics.

Topics include: special relativity, photoelectric effect, X-rays, Compton scattering, blackbody radiation, DeBroglie waves, uncertainty principle, Bohr theory of the atom, atomic nuclei, radioactivity, and elementary particles.

Recommended background: familiarity with material covered in PH 1110 and PH 1120 (or PH 1111 and PH 1121) and completion of MA 1021 and MA 1022.

PH 1140. OSCILLATIONS, AND WAVES.

Cat. I

An introduction to oscillating systems and waves.

Topics include: free, clamped forced, and coupled oscillations of physical systems, traveling waves and wave packets, reflection, and interference phenomena.

Recommended background: working knowledge of the material covered in PH 1110 and PH 1120 (or PH 1111 and PH 1121) and completion of MA 1021, MA 1022 and MA 1023.

PH 2101. PRINCIPLES OF THERMODYNAMICS.

Cat. I

The course provides fundamental preparation for any specialized application of thermodynamics. The material covered includes a general description of large number systems, states, canonical state variables, state functions, response functions, and equations of state. Focus will be given to the physical meanings of free-energies, enthalpy, chemical potential, and entropy. Connections will be made to equilibrium states, reversible versus irreversible processes, phases and phase transformation, as well as the arrow of time as applied across disciplines.

Recommended background: introductory mechanics and multi-variable calculus

PH 2201. INTERMEDIATE MECHANICS I.

Cat. I

This course emphasizes a systematic approach to the mathematical formulation of mechanics problems and to the physical interpretation of the mathematical solutions.

Topics covered include: Newton's laws of motion, kinematics and dynamics of a single particle, vector analysis, motion of particles, rigid body rotation about an axis.

Recommended background: PH 1110, PH 1120, PH 1130, PH 1140, MA 1021, MA 1022, MA 1023, MA 1024 and concurrent registration in or completion of MA 2051.

PH 2202. INTERMEDIATE MECHANICS II.*Cat. I*

This course is a continuation of the treatment of mechanics started in PH 2201. Topics covered include: rigid-body dynamics, rotating coordinate systems, Newton's law of gravitation, central-force problem, driven harmonic oscillator, an introduction to generalized coordinates, and the Lagrangian and Hamiltonian formulation of mechanics.

PH 2301. ELECTROMAGNETIC FIELDS.*Cat. I*

Introduction to the theory and application of electromagnetic fields, appropriate as a basis for further study in electromagnetism, optics, and solid-state physics.

Topics: electric field produced by charge distributions, electrostatic potential, electrostatic energy, magnetic force and field produced by currents and by magnetic dipoles, introduction to Maxwell's equations and electromagnetic waves.

Recommended background: introductory electricity and magnetism, vector algebra, integral theorems of vector calculus as covered in MA 2251.

PH 2501. PHOTONICS.*Cat. II*

An introduction to the use of optics for transmission and processing of information. The emphasis is on understanding principles underlying practical photonic devices. Topics include lasers, light emitting diodes, optical fiber communications, fiber lasers and fiber amplifiers, planar optical waveguides, light modulators and photodetectors. Recommended background is PH 1110, PH 1120, PH 1130 and PH 1140 (or their equivalents).

This course will be offered in 2020-21, and in alternating years thereafter.

PH 2502. LASERS.*Cat. II*

An introduction to the physical principles underlying lasers and their applications. Topics will include the coherent nature of laser light, optical cavities, beam optics, atomic radiation, conditions for laser oscillation, optical amplifiers (including fiber amplifiers), pulsed lasers (Q switching and mode locking), laser excitation (optical and electrical), and selected laser applications. Recommended background is PH 1110, PH 1120, PH 1130 and PH 1140 (or their equivalents).

This course will be offered in 2019-20, and in alternating years thereafter.

PH 2510. ATOMIC FORCE MICROSCOPY.*Cat. II*

Atomic force microscopes (AFMs) are instruments that allow three-dimensional imaging of surfaces with nanometer resolution and are important enabling tools for nanoscience and technology. The student who successfully completes this course will understand the functional principles of AFMs, be able to run one, and interpret the data that are collected.

Recommended background: PH 1110 and 1120. Suggested background: PH 1130 and PH 1140.

This course will be offered in 2019-20, and in alternating years thereafter.

Some sections of this course may be offered as Writing Intensive (WI).

PH 2520. INTRODUCTION TO ASTROPHYSICS.*Cat. II*

A selective study of components of the universe (the solar system, stars, nebulae, galaxies) and of cosmology, based on astronomical observations analyzed and interpreted through the application of physical principles, and organized with the central purpose of presenting the latest understanding of the nature and evolution of the universe. Some topics to be covered include the Big Bang & Inflation; Stellar Behavior & Evolution; White Dwarfs, Neutron Stars, & Supernovae; Black Holes; Dark Matter & Dark Energy.

Recommended background is PH 1110 (or PH 1111), PH 1120 (or PH 1121), and especially PH 1130.

Suggested background: PH 1140.

This course will be offered in 2019-20, and in alternating years thereafter.

PH 2540. SOLAR SYSTEMS.*Cat. II*

This course covers physics of the solar system and exo-planetary systems. Topics introduced will include the sun, moons and planets; the interplanetary space environment; gravitational interplay, planet atmospheres, surfaces and interiors; interplanetary travel, exploration and habitation; challenges of terraforming, comparison of planetary environments to Earth's biosphere; and the conditions required to support life.

Recommended background: a working knowledge of mechanics (PH 1110 or 1111), electrodynamics (PH 1120 or 1121), modern physics (PH 1130), and differential and integral calculus (MA 1021 and MA 1022).

This course will be offered in 2020-21, and in alternating years thereafter.

PH/AE 2550. ATMOSPHERIC AND SPACE ENVIRONMENTS.*Cat. I*

This course introduces the ambient atmospheric and space environments encountered by aerospace vehicles. Topics include: the sun and solar activity; the solar wind; planetary magnetospheres; planetary atmospheres; radiation environments; galactic cosmic rays; meteoroids; and space debris.

Recommended background: mechanics (PH 1110/1111 or equivalent), electromagnetism (PH 1120/1121 or equivalent), and ordinary differential equations (MA 2051 or equivalent).

PH 2601. PHOTONICS LABORATORY.*Cat. II*

This course provides an experimental approach to concepts covered in Photonics (PH 2501), Lasers (PH 2502), and Optics (PH 3504). Through a series of individually tailored experiments, students will reinforce their knowledge in one or more of these areas, while at the same time gaining exposure to modern photonics laboratory equipment. Experiments available include properties of optical fibers, optical fiber diagnostics, optical communications systems, properties of photodetectors, mode structure and threshold behavior of lasers, coherence properties of laser light, characterization of fiber amplifiers, diffraction of light, polarization of light, interferometry.

Recommended background: PH 1110/1111, PH 1120/1121, PH 1130, PH 1140, and one or more of the courses PH 2501, PH 2502, or PH 3504. No prior laboratory background is expected.

This course will be offered in 2020-21, and in alternating years thereafter.

PH 2651. INTERMEDIATE PHYSICS LABORATORY.*Cat. I*

This course offers experience in experimentation and observation for students of the sciences and others. In a series of subject units, students learn or review the physical principles underlying the phenomena to be observed and the basis for the measurement techniques employed. Principles and uses of laboratory instruments including the cathode-ray oscilloscope, meters for frequency, time, electrical and other quantities are stressed. In addition to systematic measurement procedures and data recording, strong emphasis is placed on processing of the data, preparation and interpretation of graphical presentations, and analysis of precision and accuracy, including determination and interpretation of best value, measures of error and uncertainty, linear best fit to data, and identification of systematic and random errors. Preparation of high-quality experiment reports is also emphasized. Representative experiment subjects are: mechanical motions and vibrations; free and driven electrical oscillations; electric fields and potential; magnetic materials and fields; electron beam dynamics; optics; diffraction-grating spectroscopy; radioactive decay and nuclear energy measurements.

Recommended background: the Introductory Physics course sequence or equivalent. No prior laboratory background beyond that experience is required.

Students who have received credit for PH 2600 or PH 3600 may not receive credit for PH 2651.

PH 3206. STATISTICAL PHYSICS.*Cat. I*

An introduction to the basic principles of thermodynamics and statistical physics.

Topics covered include: basic ideas of probability theory, statistical description of systems of particles, thermodynamic laws, entropy, microcanonical and canonical ensembles, ideal and real gases, ensembles of weakly interacting spin 1/2 systems.

Recommended background: knowledge of quantum mechanics and thermodynamics at the level of ES 3001.

PH 3301. ELECTROMAGNETIC THEORY.*Cat. I*

A continuation of PH 2301, this course deals with more advanced subjects in electromagnetism, as well as study of basic subjects with a more advanced level of mathematical analysis. Fundamentals of electric and magnetic fields, dielectric and magnetic properties of matter, quasi-static time-dependent phenomena, and generation and propagation of electromagnetic waves are investigated from the point of view of the classical Maxwell's equations.

PH 3401. QUANTUM MECHANICS I.*Cat. I*

This course includes a study of the basic postulates of quantum mechanics, its mathematical language and applications to one-dimensional problems. The course is recommended for physics majors and other students whose future work will involve the application of quantum mechanics.

Topics include wave packets, the uncertainty principle, introduction to operator algebra, application of the Schrodinger equation to the simple harmonic oscillator, barrier penetration and potential wells.

Recommended background: Junior standing, MA 4451, and completion of the introductory physics sequence, including the introduction to the 20th century physics.

Suggested background: knowledge (or concurrent study) of linear algebra, Fourier series, and Fourier transforms.

PH 3402. QUANTUM MECHANICS II.

Cat. I

This course represents a continuation of PH 3401 and includes a study of three-dimensional systems and the application of quantum mechanics in selected fields.

Topics include: the hydrogen atom, angular momentum, spin, perturbation theory and examples of the application of quantum mechanics in fields such as atomic and molecular physics, solid state physics, optics, and nuclear physics.

Recommended background: PH 3401.

PH 3501. RELATIVITY.

Cat. II

This course is designed to help the student acquire an understanding of the formalism and concepts of relativity as well as its application to physical problems.

Topics include the Lorentz transformation, 4-vectors and tensors, covariance of the equations of physics, transformation of electromagnetic fields, particle kinematics and dynamics.

Recommended background: knowledge of mechanics and electrodynamics at the intermediate level.

This course will be offered in 2020-21, and in alternating years thereafter.

PH 3502. SOLID STATE PHYSICS.

Cat. II

An introduction to solid state physics.

Topics include: crystallography, lattice vibrations, electron band structure, metals, semiconductors, dielectric and magnetic properties.

Recommended background: prior knowledge of quantum mechanics at an intermediate level.

Suggested background: knowledge of statistical physics is helpful.

This course will be offered in 2020-21, and in alternating years thereafter.

PH 3503. NUCLEAR PHYSICS.

Cat. II

This course is intended to acquaint the student with the measurable properties of nuclei and the principles necessary to perform these measurements. The major part of the course will be an introduction to the theory of nuclei.

The principal topics will include binding energy, nuclear models and nuclear reactions. The deuteron will be discussed in detail and the nuclear shell model will be treated as well as the nuclear optical model.

Recommended background: some knowledge of the phenomena of modern physics at the level of an introductory physics course and knowledge of intermediate level quantum mechanics.

This course will be offered in 2019-20, and in alternating years thereafter.

PH 3504. OPTICS.

Cat. II

This course provides an introduction to classical physical optics, in particular interference, diffraction and polarization, and to the elementary theory of lenses. The theory covered will be applied in the analysis of one or more modern optical instruments.

Recommended background: knowledge of introductory electricity and magnetism and of differential equations.

Suggested background: PH 2301.

This course will be offered in 2019-20, and in alternating years thereafter.

PH 4201. ADVANCED CLASSICAL MECHANICS.

Cat. I

A review of the basic principles and introduction to advanced methods of mechanics, emphasizing the relationship between dynamical symmetries and conserved quantities, as well as classical mechanics as a background to quantum mechanics.

Topics include: Lagrangian mechanics and the variational principle, central force motion, theory of small oscillations, Hamiltonian mechanics, canonical transformations, Hamilton-Jacobi Theory, rigid body motion, and continuous systems.

Recommended background: PH 2201 and PH 2202.

This is a 14-week course.

Graduate Physics Courses of Interest to Undergraduates

PH 511/PH 4201. CLASSICAL MECHANICS.

PH 514. QUANTUM MECHANICS I.

PH 515. QUANTUM MECHANICS II.

PH 522. THERMODYNAMICS AND STATISTICAL MECHANICS.

PH 533. ADVANCED ELECTROMAGNETIC THEORY.

NSE 510. INTRODUCTION TO NUCLEAR SCIENCE AND ENGINEERING.

NSE 520. APPLIED NUCLEAR PHYSICS

See Graduate Catalog for details.

ROBOTICS ENGINEERING

RBE 1001. INTRODUCTION TO ROBOTICS.

Cat. I

Multidisciplinary introduction to robotics, involving concepts from the fields of electrical engineering, mechanical engineering and computer science. Topics covered include sensor performance and integration, electric and pneumatic actuators, power transmission, materials and static force analysis, controls and programmable embedded computer systems, system integration and robotic applications. Laboratory sessions consist of hands-on exercises and team projects where students design and build mobile robots.

Undergraduate credit may not be earned for both this course and for ES 2201.

Recommended background: mechanics (PH 1110/PH 1111).

RBE 2001. UNIFIED ROBOTICS I: ACTUATION.

Cat. I

First of a four-course sequence introducing foundational theory and practice of robotics engineering from the fields of computer science, electrical engineering and mechanical engineering. The focus of this course is the effective conversion of electrical power to mechanical power, and power transmission for purposes of locomotion, and of payload manipulation and delivery. Concepts of energy, power and kinematics will be applied. Concepts from statics such as force, moments and friction will be applied to determine power system requirements and structural requirements. Simple dynamics relating to inertia and the equations of motion of rigid bodies will be considered. Power control and modulation methods will be introduced through software control of existing embedded processors and power electronics. The necessary programming concepts and interaction with simulators and Integrated Development Environments will be introduced. Laboratory sessions consist of hands-on exercises and team projects where students design and build robots and related sub-systems.

Recommended background: ES 2201/RBE 1001, ES 2501 (can be taken concurrently), ECE 2029 and PH 1120 or PH 1121.

RBE 2002. UNIFIED ROBOTICS II: SENSING.

Cat. I

Second of a four-course sequence introducing foundational theory and practice of robotics engineering from the fields of computer science, electrical engineering and mechanical engineering. The focus of this course is interaction with the environment through sensors, feedback and decision processes. Concepts of stress and strain as related to sensing of force, and principles of operation and interface methods for electronic transducers of strain, light, proximity and angle will be presented. Basic feedback mechanisms for mechanical systems will be implemented via electronic circuits and software mechanisms. The necessary software concepts will be introduced for modular design and implementation of decision algorithms and finite state machines. Laboratory sessions consist of hands-on exercises and team projects where students design and build robots and related sub-systems.

Recommended background: RBE 2001, CS 1101 or CS 1102

RBE 3001. UNIFIED ROBOTICS III: MANIPULATION.*Cat. I*

Third of a four-course sequence introducing foundational theory and practice of robotics engineering from the fields of computer science, electrical engineering and mechanical engineering. The focus of this course is actuator design, embedded computing and complex response processes. Concepts of dynamic response as relates to vibration and motion planning will be presented. The principles of operation and interface methods various actuators will be discussed, including pneumatic, magnetic, piezoelectric, linear, stepper, etc. Complex feedback mechanisms will be implemented using software executing in an embedded system. The necessary concepts for real-time processor programming, re-entrant code and interrupt signaling will be introduced. Laboratory sessions will culminate in the construction of a multi-module robotic system that exemplifies methods introduced during this course.

Recommended background: RBE 2002, ECE 2049, CS 2102 or CS 2103, MA 2051, and MA 2071.

RBE 3002. UNIFIED ROBOTICS IV: NAVIGATION.*Cat. I*

Fourth of a four-course sequence introducing foundational theory and practice of robotics engineering from the fields of computer science, electrical engineering and mechanical engineering. The focus of this course is navigation, position estimation and communications. Concepts of dead reckoning, landmark updates, inertial sensors, and radio location will be explored. Control systems as applied to navigation will be presented. Communication, remote control and remote sensing for mobile robots and tele-robotic systems will be introduced. Wireless communications including wireless networks and typical local and wide area networking protocols will be discussed. Considerations will be discussed regarding operation in difficult environments such as underwater, aerospace, hazardous, etc. Laboratory sessions will be directed towards the solution of an open-ended problem over the course of the entire term.

Recommended background: RBE 3001, ES 3011, MA 2621, or MA 2631.

RBE 3100. SOCIAL IMPLICATIONS OF ROBOTICS.*Cat. I*

This course introduces students to the social, moral, ethical, legal, and current or future philosophical issues within the context of robotic systems and related emerging technology. Students will be expected to contribute to classroom presentations, discussions and debates, and to complete a number of significant writing assignments. This course is recommended for juniors and seniors.

Recommended background: A general knowledge of robots and robotic systems.

Students may not receive credit for both RBE 3100 and RBE 310X.

RBE/ME 4322. MODELING AND ANALYSIS OF MECHATRONIC SYSTEMS.*Cat. I*

This course introduces students to the modeling and analysis of mechatronic systems. Creation of dynamic models and analysis of model response using the bond graph modeling language are emphasized. Lecture topics include energy storage and dissipation elements, transducers, transformers, formulation of equations for dynamic systems, time response of linear systems, and system control through open and closed feedback loops. Computers are used extensively for system modeling, analysis, and control. Hands-on projects will include the reverse engineering and modeling of various physical systems. Physical models may sometimes also be built and tested.

Recommended background: mathematics (MA 2051, MA 2071), fluids (ES 3004), thermodynamics (ES 3001), mechanics (ES 2501, ES 2503)

RBE/ME 4815. INDUSTRIAL ROBOTICS.*Cat. I*

This course introduces students to robotics within manufacturing systems. Topics include: classification of robots, robot kinematics, motion generation and transmission, end effectors, motion accuracy, sensors, safety systems, robot control and automation. This course is a combination of lecture, laboratory and project work, and utilizes industrial robots. Through the laboratory work, students will become familiar with robotic programming (using a robotic programming language RAPID) and the robotic teaching mode. The experimental component of the laboratory exercise measures the motion and positioning capabilities of robots as a function of several robotic variables and levels, and it includes the use of experimental design techniques.

Recommended background: manufacturing (ME 1800), kinematics (ME 3310), control (ES 3011), and computer programming.

SOCIAL SCIENCE AND POLICY STUDIES

DEV	Development
ECON	Economics
ENV	Environmental Studies
GOV	Political Science, Government and Law
PSY	Psychology
SD	System Dynamics
SOC	Sociology
SS	General Social Science
STS	Society/Technology Studies

DEVELOPMENT (DEV)

DEV 1200. INTERNATIONAL DEVELOPMENT AND SOCIETY.*Cat. I*

What is development? How has international development been understood and what has been done about it? How do development scholars explain why some countries are rich while others are poor? How can students understand and incorporate development studies in the contexts of their own global engagements? This course addresses these questions by looking at theories, ideologies, and processes that have influenced and embodied development thinking and practice over the past five decades. We will examine the role of colonization, modernization, dependency, globalization, democratization, industrialization, and urbanization in processes of development in countries across the globe. The course encourages students to think critically about what development is, about how it is carried out and, most importantly of all, about what it can achieve.

DEV 1200 provides excellent preparation for international projects and careers.

Recommended background: None.

DEV 2200. CASE STUDIES IN INTERNATIONAL DEVELOPMENT POLICY AND ENGINEERING.*Cat. II*

The engineers and scientists of tomorrow have a crucial role to play in discovering and implementing solutions to daunting international challenges related to food, water, energy, sanitation and infrastructure. The urgency of such challenges grows alongside and increasingly globalized workplace, where a growing number of graduates find themselves working outside the US, and invited to engage cultures, worldviews, value systems and physical environments that are very unlike their own. This course prepares students with 'global competency', to enable them to more effectively and ethically tackle problems in the context of starkly different socioeconomic, political, social and physical realities. Students will develop the knowledge, skills and understanding required to consider, accommodate and effectively integrate contextual difference into engineering practice by exploring the complexity of project design, the potential for unintended consequences, and how technologies are transformed in different contexts. This course will prepare students for a broad range of international IQP and MQPs.

Recommended background: None.

This course will be offered in 2020-21, and in alternating years thereafter.

DEV 4400. SCIENCE, ENGINEERING AND DESIGN IN INTERNATIONAL DEVELOPMENT.*Cat. II*

This course provides students with a set of skills that will allow them to address complex problems and design challenges in development engineering. Students will learn to participate in and lead innovation and creativity in collaborative settings. This course includes design projects and case studies, many related to projects at WPI. Student teams will work with preliminary data to define the problem. They will then collect and analyze interview and survey data to learn about user needs. Students will explore how to understand end-user needs. Students will use a variety of tools to analyze their data, ideate potential solutions, and prototype. The teams will use their projects to develop plans for rapid improvement, scaling, continuous improvement and a rigorous impact evaluation.

Recommended background: None.

This course will be offered in 2021-22, and in alternating years thereafter.

ECONOMICS (ECON)

ECON 1110. INTRODUCTORY MICROECONOMICS.

Cat. I

The course focuses upon the implications of reliance upon markets for the allocation of resources in a society, at the household, firm, and community level. Outcomes of current market systems are examined in terms of the efficient use of natural and other economic resources, as well as their impact upon the environment, fairness, and social welfare. of special interest in these analyses is the role of prices in the determination of what commodities are produced, their means of production, and distribution among households. In cases where current market outcomes have features subject to widespread criticism, such as the presence of excessive pollution, risk, discrimination, and poverty, the analysis is extended to suggest economic solutions. There are no prerequisites for the course.

ECON 1120. INTRODUCTORY MACROECONOMICS.

Cat. I

This course is designed to acquaint students with the ways in which macroeconomic variables such as national income, employment and the general level of prices are determined in an economic system. It also includes a study of how the techniques of monetary policy and fiscal policy attempt to achieve stability in the general price level and growth in national income and employment. The problems of achieving these national goals (simultaneously) are also analyzed. The course stresses economic issues in public policy and international trade.

ECON 2110. INTERMEDIATE MICROECONOMICS.

Cat. II

The topics addressed in this course are similar to those covered in ECON 1110 (Introductory Microeconomics) but the treatment proceeds in a more rigorous and theoretical fashion to provide a firm platform for students majoring in Economics or Business, or those having a strong interest in economics. Mathematics at a level comparable to that taught in MA 1021-MA 1024 is frequently applied to lend precision to the analysis. The course rigorously develops the microeconomic foundations of the theory of the firm, the theory of the consumer, the theory of markets, and the conditions required for efficiency in economic systems.

Recommended background: ECON 1110.

This course will be offered in 2019-20, and in alternating years thereafter.

ECON 2117. ENVIRONMENTAL ECONOMICS.

Cat. II

This course investigates the effect of human activity upon the environment as well as the effect of the environment on human well-being. It pays special attention to the impact of production and consumption of material goods upon the quantity and quality of environmental goods. The analysis focuses on the challenges presented in mixed economies where markets are combined with government intervention to manage pollution and scarcity. The course reviews efforts to measure the costs and benefits of improving environmental conditions and evaluates current and potential policies in terms of the costs of the environmental improvements they may yield. Attention is also paid to the special difficulties which arise when the impacts of pollution spill across traditional political boundaries. Recommended background: ECON 1110.

This course will be offered in 2020-21, and in alternating years thereafter.

ECON 2120. INTERMEDIATE MACROECONOMICS.

Cat. II

This course is an advanced treatment of macroeconomic theory well suited for students majoring in Economics or Business, or others with a strong interest in economics. The topics addressed in ECON 2120 are similar to those covered in ECON 1120, however the presentation of the material will proceed in a more rigorous and theoretical fashion.

Recommended background: ECON 1110.

This course will be offered in 2020-21, and in alternating years thereafter.

ECON 2125. DEVELOPMENT ECONOMICS.

Cat. II

This course is a general introduction to the field of development economics. The focus is on ways in which a developing country can increase its productive capacity, both agricultural and industrial, in order to achieve sustained economic growth. The course proceeds by first examining how economic growth and economic development are measured and how the various nations of the world compare according to well-known social and economic indicators. Theories of

economic growth and theories of economic development are then examined, as are the various social and cultural structures that are thought to influence economic progress. The inputs to economic growth and development (land, labor, capital, entrepreneurial ability, education, technical change), and the possible distributions of income and levels of employment that result from their use, is considered next. Domestic economic problems and policies such as development planning, the choice of sectorial policies, the choice of monetary and fiscal policies, rapid population growth, and urbanization and urban economic development are then examined. The course concludes with a consideration of international problems and policies such as import substitution and export promotion, foreign debt, foreign investment, and the role of international firms. In conjunction with a traditional presentation of the above topics, the course curriculum will include the use of computer simulation models and games. These materials have been formulated with a simulation technique, system dynamics, that has its origins in control engineering and the theory of servomechanisms. As a result, students will find them complementary to their work in engineering and science. In addition, the various development theories and simulation and gaming results will be related, where possible, to specific developing nations where WPI has on-going project activities (e.g., Costa Rica and Thailand). This course is recommended for those students wishing to do an IQP or MQP in a developing nation.

Recommended background: ECON 1120.

This course will be offered in 2019-20, and in alternating years thereafter.

ECON 2126. PUBLIC ECONOMICS.

Cat. II

This course examines the economics of government expenditure and taxation. On the expenditure side, the course will review why governments often choose to be involved in the provision of healthcare, education, national defense, a clean environment, and infrastructure such as roads and bridges. It will also delve into the rationale behind programs such as social security. Regarding taxation, the course will cover income, consumption, and corporate taxes, including the use of corrective taxes to address market failures due to externalities. Within each topic, the relevant economic theories will be presented, and then students will practice applying the theories to real-world examples. As such, there will be plenty of opportunity to discuss policy implications and debate proposed policy changes.

Recommended background: Some introductory economics, such as Introductory Micro- or Macroeconomics (ECON 1110 or ECON 1120; or equivalent).

Students who completed ECON 212X: Public Economics cannot receive credit for ECON 2126: Public Economics.

ECON 2130. ECONOMETRIC MODELING.

Cat. II

Econometrics helps governments and businesses make more informed economic decisions. This course introduces the application of statistics and economic theory to formulating, estimating, and testing models about relationships among key variables. Topics include basic data analysis, regression analysis (including estimation, inference, assumptions, violations of assumptions, corrections for violations, dummy variables), and forecasting. Students will have the opportunity to use real-world socioeconomic data to test and interpret economic theories using econometric software. Successful students should also be able to formulate, estimate, and interpret their own testable relationships in other projects or fields of study.

Recommended Background: Some previous exposure to Economics, such as ECON 1110 and/or ECON 1120.

Students may not get credit both for ECON 1130 and ECON 2130

ECON 2135. INFORMATION ECONOMICS AND POLICY.

Cat. II

This course provides an introduction to the economics, business strategies, and regulatory and legal aspects of telecommunication markets. The analysis of complex interactions between technology, Federal and state government policies, copyright legislation, and forces driving supply and demand is performed using Economic and Industrial Organization theories combined with computer simulation techniques. Topics include, among others: the economics of telephony services, cable TV, satellite communication, spectrum auctions, WLAN, and peer-to-peer file sharing. Special attention will be paid to the analysis of the latest regulatory and legal developments in the telecommunications industry.

Recommended background: ECON 1110 or ECON 2110.

This course will be offered in 2020-21, and in alternating years thereafter.

ECON 2145. BEHAVIORAL ECONOMICS.*Cat. I*

Behavioral economics incorporates insights from psychology and sociology into economic models of decision-making. While traditional economic theory typically assumes individuals are self-interested and have an infinite ability to analyze and understand their decision-making environment, behavioral economics relaxes these assumptions in light of evidence from the field of experimental economics. Topics in the course include social preferences, mental accounting, decision-making under uncertainty and intertemporal choice. Additional topics may include the economics of social identity, preference formation and learning. Decision-making processes will be examined using simple economic experiments conducted in class.

Recommended background: ECON 1110.

ECON 2155. EXPERIMENTAL ECONOMICS.*Cat. II*

Experimental economics is a set of methods for testing hypotheses about behavior. Traditional economic analysis using naturally occurring data is often confounded by the complexities of the real world. Economic experiments, on the other hand, give researchers the control required for isolating behaviors of interest. As such, economic experiments can be useful tools for testing existing theories and establishing empirical regularities assisting in the development of new theories. In this course, we cover the basic principles of experimental design. We also study a number of classic experiments, on topics ranging from the efficiency of markets to decision-making under uncertainty and behavioral game theory. Students will participate in mock experiments and will begin putting their new skills into practice by designing their own experiments, which may serve as the basis for IQPs/MQPs. If time permits, we will discuss some of the basic methods for analyzing experimental data, which presents challenges somewhat different from naturally occurring data due to small sample sizes.

Recommended Background: ECON 1110

This course will be offered in 2019-20, and in alternating years thereafter.

ECON/ETR 2910. ECONOMICS AND ENTREPRENEURSHIP.*Cat. I*

This course is designed to provide an introduction to economics, an introduction to entrepreneurship, and an understanding of the linkages between economics and entrepreneurship. Students will apply these concepts to the assessment of opportunities that might arise from participation in WPI projects. Students will engage in exploring how economics and entrepreneurship can inform opportunity assessment within an ambiguous and uncertain context. These decisions are always made with incomplete information and there is typically no single correct answer but rather multiple possible answers -- each with pluses and minuses.

Recommended background: None

Students may not earn credits for both ECON 2910/ETR 2910 and ECON 291X/ETR 291X

ENVIRONMENTAL AND SUSTAINABILITY STUDIES (ENV)

ENV 1100. INTRODUCTION TO ENVIRONMENTAL STUDIES.*Cat. I*

The study of environmental problems and their solutions requires an interdisciplinary approach. This course will examine current environmental issues from the intersection of several key disciplines including: environmental philosophy and history, environmental policy, and science. The course will develop these different approaches for analyzing environmental problems, explore the tensions between them, and present a framework for integrating them. Topics such as environmental justice, developing nations, globalization, and climate change policy will be explored.

ENV 1500. INTRODUCTION TO GEOGRAPHICAL INFORMATION SYSTEMS.*Cat. II*

This course introduces Geographic Information Systems (GIS) as a powerful mapping and analytical tool. Topics include GIS data structure, map projections, and fundamental GIS techniques for spatial analysis. Laboratory exercises concentrate on applying concepts presented in lectures and will focus on developing skills using ArcGIS. These exercises include examples of GIS applications in environmental modeling, socio-demographic change and site suitability analyses. Although the course is computer-intensive, no programming background is required.

This course will be offered in 2019-20, and in alternating years thereafter.

Note: Students may not receive credit for both ENV 150X and ENV 1500.

ENV 2201. PLANNING FOR SUSTAINABLE COMMUNITIES.*Cat. II*

Sustainability planning seeks to anticipate and balance environmental, social, and economic impacts of human actions. This course presents an overview of how various perspectives can contribute to frameworks for environmental land use planning and management. Students are encouraged to think critically about problems land and natural resource use pose to society. Technical principles and analysis of sustainability planning are introduced and applied to challenges that communities currently face such as food, fiber and energy production, environmental conservation, hazard mitigation and resilience, water security, economic development, and waste management. Techniques to engage a diverse set of stakeholders in a collaborative planning process are examined along with the role of technology.

This course will be offered in 2019-20, and in alternating years thereafter.

ENV 2310. ENVIRONMENTAL GOVERNANCE AND INNOVATION.*Cat. II*

With global attention dominated by environmental catastrophe and despair, we will spotlight new work that has brought together scientists, environmentalists, engineers, and artists to tackle the most serious problems facing communities. We will explore the political ecology implications of control over essential resources and the positive consequences of rethinking and democratizing basic social needs for a more sustainable future. Recent exciting case studies will feature examples of simple solutions that inspire elegant, transferable, and inexpensive applications of technological design. We will examine the role and obligation that scientists have to collaborate with interdisciplinary and public policy efforts that benefit people with sustainable approaches to architecture, food, energy, transportation, and infrastructure.

Recommended background: introductory environmental studies course.

Students may not receive credit for both ENV 230X and ENV 2310.

This course will be offered in 2019-20, and in alternating years thereafter.

ENV 2400. ENVIRONMENTAL PROBLEMS AND HUMAN BEHAVIOR.*Cat. II*

This course examines how people think about and behave toward the environment. Environmental problems can ultimately be attributed to the environmental decisions and actions of human beings. These behaviors can in turn be understood as resulting from the nature and limitations of the human mind and the social context in which behavior takes place. Knowledge of the root causes of environmentally harmful behavior is essential for designing effective solutions to environmental problems. The goals of the course are (1) to provide students with the basic social science knowledge needed to understand and evaluate the behavioral aspects of such important environmental problems as air and water pollution, global warming, ozone depletion, preserving biological diversity, and hazardous waste and (2) to help students identify and improve shortcomings in their knowledge and decisions related to the environment. Topics will include, but not be limited to: environmental problems as "tragedies of the commons"; public understanding of global warming and global climate modeling; folk biology; risk perception; intelligent criticism of environmental claims; making effective environmental choices; strategies for promoting pro-environmental behavior; and human ability to model and manage the global environmental future.

Recommended background: ENV 1100.

Suggested background: PSY 1400, PSY 1401, or PSY 1402.

Students may not receive credit for both PSY 2405 and ENV 2400.

This course will be offered in 2019-20, and in alternating years thereafter.

ENV 2600. ENVIRONMENTAL PROBLEMS IN THE DEVELOPING WORLD.*Cat. II*

Environment and development are often seen as incompatible, in part because many poor people in the developing world depend directly on natural resources for their livelihoods. At the same time, poor people are often seen as responsible for causing environmental degradation because they lack the knowledge, skills and resources to manage the environment effectively. The vicious circle is completed as environmental degradation exacerbates poverty. However, optimists argue that poor people can and do contribute positively to environmental outcomes, that states and organizations can facilitate their efforts and that environmental interventions can coincide with development. This course will examine these different perspectives on environmental problems in the developing world through the insights and critiques of social science. Subjects

covered include sustainable development, population, environmental risks, gender, urbanization, environmental decision making, and non-governmental organizations (NGOs). The goals of this course are to think critically about the various links between environment and development and the role of governmental and non-governmental organizations in promoting sustainable development in the developing world.

Recommended Background: ENV 1100

This course will be offered in 2019-20, and in alternating years thereafter.

ENV 2700. SOCIAL MEDIA, SOCIAL MOVEMENTS, AND THE ENVIRONMENT.

Cat. II

Social media platforms are changing the world of social movements, giving rise to a new generation of social activism. Social media can enable local actors to link with others from across the globe to incite social and environmental change. Social media has enabled people to document and share injustices (e.g., violence; dumping of toxic waste) in places where freedom of the press is limited or non-existent, and it has enabled people across different social groups (race, class, etc.) to engage with one another on issues of shared concern. Social media has also allowed people to share resources (financial, expertise, and organizational) with other social actors across the globe, empowering communities in novel ways. This course introduces students to the phenomena of social and environmental movements, theories on why they succeed and fail, and how social media has changed the landscape of social mobilization. This course will draw on interdisciplinary readings, concepts, and case studies from the social sciences, with emphasis on geography, public policy, sociology, and media studies. Course work will include small group projects, analyses of current social movement cases, and a final project. The final project will consist of interviewing members of a current social movement (potentially using social media), evaluating whether particular social media applications have helped to enable social mobilization, and designing new or revised social media tools to further enhance social mobilization.

Recommended background: introductory environmental studies (ENV1100 or equivalent).

ENV 2900. THE GREEN ECONOMY AND MODELS FOR ALTERNATIVE FORMS OF DEVELOPMENT.

Cat. II

This course examines the limitations of traditional economic models and charts a new course for current policies and practices. To chart this path we draw upon and synthesize examples from existing alternative economies (e.g., different forms of dematerialization, hybrid organizations, solidary economy, sharing economy). The course critically examines current paradigms of greening and seeks to expand thinking that will encompass new, alternative, and socially just conceptions of economy and economic development. A particular emphasis is laid on the spatial implications of de-growth oriented activities which partly challenge existing models and research methods in economic geography.

Suggested background: Basic knowledge of economics and environmental governance.

This course will be offered in 2019-20, and in alternating years thereafter.

ENV 3100. ADVENTURES IN SUSTAINABLE URBANISM.

Cat. II

This course will take students on an adventure, both in the class and in the field. Students will examine the history of sustainable development, its antecedents, the factors that have influenced its evolution, and how the sustainable city came into existence. Students will be invited on a number of virtual field trips to sustainable cities from around the world. The goal will be to explore the underlying factors of sustainable urbanism, why it looks the way it does in different places, and how students can exercise their own agency in developing alternatives. Students will also develop their own field trips for publication on the course website.

Suggested background: introduction to environmental studies and a passion for urban exploration.

This course will be offered in 2019-20, and in alternating years thereafter.

ENV 4400. SENIOR SEMINAR IN ENVIRONMENTAL STUDIES.

Cat. I

This course is intended for Environmental Studies majors. The course is designed to integrate each student's educational experience (e.g., core environmental courses, environmental electives, and environmental projects) in a capstone seminar in Environmental Studies. Through seminar discussions and

writing assignments students will critically reflect on what they learned in their previous courses and project experiences. In teams, students will prepare a final capstone paper and presentation that critically engages their educational experience in environmental studies and anticipates how their courses and experiences will translate into their future personal and professional environmental experiences.

Recommended background: ENV 1100, ENV 2200 or ENV 2400, completion or concurrent enrollment in IQP and MQP.

POLITICAL SCIENCE, GOVERNMENT AND LAW (GOV)

GOV 1301. U.S. GOVERNMENT.

Cat. I

This course is an introduction to the fundamental principles, institutions, and processes of the constitutional democracy of the United States. It examines the formal structure of the Federal system of government, including Congress, the presidency, the judiciary, and the various departments, agencies, and commissions which comprise the executive branch. Emphasis is placed on the relationships among Federal, state and local governments in the formulation and administration of domestic policies, and on the interactions among interest groups, elected officials and the public at large with administrators in the policy process. The various topics covered in the survey are linked by consideration of fiscal and budgetary issues, executive management, legislative oversight, administrative discretion, policy analysis and evaluation and democratic accountability.

GOV 1303. AMERICAN PUBLIC POLICY.

Cat. I

American Public Policy focuses on the outcomes or products of political institutions and political controversy. The course first addresses the dynamics of policy formations and stalemate, the identification of policy goals, success and failure in implementation, and techniques of policy analysis. Students are then encouraged to apply these concepts in the study of a specific policy area of their choosing, such as foreign, social, urban, energy or environmental policy. This course is an important first step for students wishing to complete IQPs in public policy research. Students are encouraged to complete GOV 1303 prior to enrolling in upper level policy courses such as GOV 2303, GOV 2304 or GOV 2311. There is no specific preparation for this course, but a basic understanding of American political institutions is assumed.

Some sections of this course may be offered as Writing Intensive (WI).

GOV 1310. LAW, COURTS, AND POLITICS.

Cat. II

This course is an introduction to law and the role courts play in society. The course examines the structure of judicial systems, the nature of civil and criminal law, police practice in the enforcement of criminal law, and the responsibilities of judges, attorneys and prosecutors. Additional topics for discussion include the interpretation of precedent and statute in a common law system and how judicial discretion enables interest groups to use courts for social change. The student is expected to complete the course with an understanding of how courts exercise and thereby control the power of the state. As such, courts function as political actors in a complex system of governance. It is recommended that students complete this course before enrolling in GOV 2310, Constitutional Law.

This course will be offered in 2019-20, and in alternating years thereafter.

GOV 1320. TOPICS IN INTERNATIONAL POLITICS.

Cat. II

GOV 1320 is a survey course designed to introduce students to the basic concepts of international relations: power and influence, nations and states, sovereignty and law. These concepts will be explored through the study of issues such as diplomacy and its uses, theories of collective security and conflict, and international order and development. The study of international organizations such as the UN, the European Union or the Organization of American States will also supplement the students' understanding of the basic concepts. The course may also include comparative political analysis of states or regions. It is designed to provide the basic background materials for students who wish to complete IQPs on topics that involve international relations or comparative political systems.

This course will be offered in 2019-20, and in alternating years thereafter.

GOV 2302. SCIENCE-TECHNOLOGY POLICY.*Cat. II*

This course is an examination of the relationship between science-technology and government. It reviews the history of public policy for science and technology, theories and opinions about the proper role of government and several current issues on the national political agenda. Examples of these issues include genetic engineering, the environment and engineering education. It also examines the formation of science policy, the politics of science and technology, the science bureaucracy, enduring controversies such as public participation in scientific debates, the most effective means for supporting research, and the regulation of technology. Throughout the course we will pay particular attention to the fundamental theme: the tension between government demands for accountability and the scientific community's commitment to autonomy and self-regulation.

Recommended background: GOV 1301 or GOV 1303.

This course will be offered in 2019-20, and in alternating years thereafter.

GOV 2310. CONSTITUTIONAL LAW: FOUNDATIONS OF GOVERNMENT.*Cat. II*

Constitutional Law is the study of Supreme Court decisions interpreting the U.S. Constitution. The Foundations course focuses on the powers of the Congress, the Presidency and the Judicial Branch, especially the Supreme Court's understanding of its own power. These cases reveal, in particular, the evolution of Federal power with the development of a national economy and the shifting balance of power among the three branches of government. Issues of state power in a federal system are also addressed. Lastly, these materials are examined in the context of the great debates regarding how judges interpret the Constitution. How are the words and intent of the Founders applicable to the legal and political conflicts of the twenty-first century?

This course will be offered in 2020-21, and in alternating years thereafter.

GOV 2311. ENVIRONMENTAL POLICY AND LAW.*Cat. I*

This course deals with environmental law as it relates to people, pollution and land use in our society. A case method approach will be used to illustrate how the courts and legislators have dealt with these social-legal problems. The course is designed to have the student consider: 1) the legal framework within which environmental law operates; 2) the governmental institutions involved in the formulation, interpretation and application of environmental law; 3) the nature of the legal procedures and substantive principles currently being invoked to resolve environmental problems; 4) the types of hazards to the environment presently subject to legal constraints; 5) the impact that the mandates of environmental law have had, and will have, on personal liberties and property rights; 6) the role individuals and groups can play within the context of our legal system to protect and improve man's terrestrial habitat and the earth's atmosphere; and 7) some methods and sources for legal research that they may use on their own.

Recommended background: GOV 1303 or GOV 1310.

GOV 2312. INTERNATIONAL ENVIRONMENTAL POLICY.*Cat. II*

Environmental issues present some of the major international problems and opportunities facing the world today. Worst-case scenarios envision irrevocable degradation of the earth's natural systems, but virtually every analysis sees the need for major change worldwide to cope with problems such as global warming, deforestation, ozone layer depletion, loss of biodiversity, and population growth, not to mention exponential increases in "conventional" pollutants in newly industrialized countries. The global environment issues represent a "second-generation" of environmental policy in which the focus of concern has moved from national regulations to international law and institutions. In addition, the environment has emerged as a major aspect of international trade, conditioning corporate investment and accounting for some \$200 billion in sales of pollution control equipment in 1991. Exploration of the genesis and implications of these phenomena is the essence of the course.

Typically, the material begins with the nature of global environmental problems, drawing on literature from large-scale global modeling as well as particular analyses of the problems mentioned above. Approximately half the course focuses on international laws and institutions, including multilateral treaties (e.g., the Montreal Protocol limiting CFC use, ocean dumping, biodiversity), international institutions (UNEP, the Rio Convention, the OECD) and private initiatives (international standards organizations, ICOLP (Industry Committee for Ozone Layer Protection), etc.) In addition, US policy toward global environmental issues will be compared with that in Japan, Europe and developing countries, from which it differs significantly. Students will design

and undertake term projects that address particular issues in detail in an interdisciplinary manner.

Recommended background: GOV 1303.

This course will be offered in 2019-20, and in alternating years thereafter.

GOV 2313. INTELLECTUAL PROPERTY LAW.*Cat. II*

Intellectual property includes ideas, and the works of inventors, authors, composers and other creative people. Patents, copyrights and trademarks establish legal rights in intellectual property. Alternatively, control over the use of an idea might be maintained by treating it as a trade secret. In these ways, the ideas of inventors and creators are protected and others are prohibited from appropriating the ideas and creative works of others. This course addresses the concept of intellectual property and the public policies that support the law of patent, copyright and trademark. Subjects include the process of obtaining patents, trademarks and copyrights; requirements of originality and, for patents, utility; infringement issues; and the problems posed by international trade and efforts to address them through the World Intellectual Property Organization.

Recommended background: GOV 1310 or GOV 2310.

This course will be offered in 2019-20, and in alternating years thereafter.

GOV/ID 2314. CYBERLAW AND POLICY.*Cat. II*

Rapidly developing technologies for computing, information management and communications have been quickly adopted in schools, businesses and homes. The growth of the Internet and of e-commerce, in particular, have given rise to an entirely new set of legal issues as the courts, Congress and international bodies struggle to keep pace with changing technology. This course addresses the government's role in the development of these technologies and the legal issues that result including questions regarding privacy rights, speech and defamation, and the application of patent and copyright law. Policy questions such as surveillance of e-mail, regulation of content, mandates on the use of filters, and the responsibilities and liability of internet service providers are also discussed. Additional policies studied include attempts to control Internet content and enforce international judgments (resulting from e-commerce or cyber-crime) by foreign states and/or international organizations. Students are expected to integrate knowledge of technology with law, politics, economics and international affairs.

This course will be offered in 2020-21, and in alternating years thereafter.

GOV 2315. PRIVACY: LAWS, POLICY, TECHNOLOGY, AND HOW THEY FIT TOGETHER.*Cat. II*

This course will begin by examining privacy in different societies, starting with Eastern Europe during the Cold War and moving west. We will look first at privacy and the threats to it from government, then privacy and the threats posed by business. We will consider various technologies (including online social networks, communication Devices, the Internet), and different regimes for protecting privacy (including law, regulation, and technology). The course is designed to develop critical thinking about the interactions between technology, policy, and the law as well as learning about the privacy tradeoffs one makes in using modern technologies.

Recommended background: GOV 1310 (Law, Courts, and Politics) or GOV 2310 (Constitutional Law).

This course will be offered in 2020-21, and in alternating years thereafter.

GOV 2319. GLOBAL ENVIRONMENTAL POLITICS.*Cat. II*

It is apparent that environmental problems have outgrown national policy frameworks. Thus, institutions have emerged at the international and transnational levels to coordinate collective problem solving. But governance involves more than just the practicality of problem solving; it also involves uncertainty, controversy, power and politics. This course will examine the ways in which global environmental governance has been conceived: from establishing international institutions and agreements, to less tangible ways of interacting. We will examine themes such as scales of governance (from the United Nations to communities), policy networks, the role of NGOs, think tanks and special interests and the role of knowledge in global environmental debates. Students will then use this conceptual and theoretical basis to analyze major global environmental issues including: deforestation; biodiversity; endangered species; and climate change. The goals of this course are to gain an understanding of the main positions in global environmental debates; critically analyze these positions; and gain insight into the politics of global environmental policy and governance.

Recommended Background: GOV 1303 or GOV 1320

This course will be offered in 2019-20, and in alternating years thereafter.

GOV 2320. CONSTITUTIONAL LAW: CIVIL RIGHTS AND LIBERTIES.*Cat. II*

Civil Rights and Liberties examines decisions of the Supreme Court which interpret the Bill of Rights and the Equal Protection Clause of the 14th Amendment. These court decisions elaborate the content and meaning of our rights to speak, publish, practice religion, and be free from state interference in those activities. Privacy rights broadly, the right to be free from unreasonable search and seizure, and due process rights for criminal suspects are also addressed. Finally, rights to be free from discrimination based on race, religion, ethnicity, gender and sexual orientation are examined in the context of equal protection law.

Students completing this course will receive credit toward the Minor in Law and Technology among the courses satisfying the requirement in "legal fundamentals."

This course will be offered in 2020-21, and in alternating years thereafter.

PSYCHOLOGY (PSY)**PSY 1400. INTRODUCTION TO PSYCHOLOGICAL SCIENCE.***Cat. I*

Psychological science is the experimental study of human thought and behavior. Its goal is to contribute to human welfare by developing an understanding of why people do what they do. Experimental psychologists study the entire range of human experience, from infancy until death, from the most abnormal behavior to the most mundane, from the behavior of neurons to the actions of nations. This course offers a broad introduction to important theories, empirical findings, and applications of research in psychological science. Topics will include: use of the scientific method in psychology, evolutionary psychology, behavioral genetics, the anatomy and function of the brain and nervous system, learning, sensation and perception, memory, consciousness, language, intelligence and thinking, life-span development, social cognition and behavior, motivation and emotion, and the nature and treatment of psychological disorders.

PSY 1401. COGNITIVE PSYCHOLOGY.*Cat. I*

This course is concerned with understanding and explaining the mental processes and strategies underlying human behavior. The ways in which sensory input is transformed, reduced, elaborated, stored, and recovered will be examined in order to develop a picture of the human mind as an active processor of information. Topics will include perception, memory, problem-solving, judgment and decision making, human-computer interaction, and artificial intelligence. Special attention will be paid to defining the limitations of the human cognitive system. Students will undertake a project which employs one of the experimental techniques of cognitive psychology to collect and analyze data on a topic of their own choosing.

Suggested background: PSY 1400.

PSY 1402. SOCIAL PSYCHOLOGY.*Cat. I*

Social psychology is concerned with how people think about, feel for, and act toward other people. Social psychologists study how people interact by focusing on the individual (not society as a whole) as the unit of analysis, by emphasizing the effect on the individual of the situation or circumstances in which behavior occurs, and by acquiring knowledge through empirical scientific investigation. This course will examine the cause of human behavior in a variety of domains of social life. Topics will include, but not be limited to, person perception, attitude formation and change, interpersonal attraction, stereotyping and prejudice, and small group behavior. Special attention will be given to applied topics: How can the research methods of social psychology be used to help solve social problems? Students will work together in small groups to explore in depth topics in social psychology of their own choosing.

Suggested background: PSY 1400.

PSY 1404. DEVELOPMENTAL PSYCHOLOGY.*Cat. II*

This course surveys human development from conception to death, with an emphasis on the scientific analysis of developmental patterns. The course will cover the biological, cognitive, emotional, social, personality, linguistic, and moral development of the individual at all stages. Students may not receive credit for PSY140X and PSY 1404.

Recommended background: An introductory background in psychological science or experimental methods (PSY 1400).

Students may not receive credit for both PSY 140X and PSY 1404.

Some sections of this course may be offered as *Writing Intensive (WI)*.

PSY 1412. MENTAL HEALTH.*Cat. II*

This course will introduce the wide variety of psychological disorders that exist in society (personality, anxiety, mood, psychotic, etc.). For each disorder discussed, possible causes, symptoms, preventions, and treatments will be examined. The course will cover psychopathologies throughout the entire spectrum of the lifespan (infancy to adulthood). Empirical research on understanding, diagnosing, and treating the different disorders will be emphasized.

Suggested background: Introductory psychology (PSY 1400 or equivalent).

Students may not receive credit for both PSY 1412 and PSY 141X.

PSY 1504. STRATEGIES FOR IMPROVING COGNITIVE SKILLS.*Cat. I*

Life experience provides us with little insight into the basic workings of our own minds. As a result, we tend to approach many of the important problems and decisions of our professional and personal lives with only a dim awareness of the limitations and capabilities of the human cognitive system and how its performance can be improved. The purpose of this course is (1) to provide students with the basic psychological knowledge needed to understand and evaluate such important cognitive skills as memory, problem solving, decision making, and reasoning and (2) to provide students the practical skills and experience necessary to improve and assess their cognitive performance. Topics will include but not be limited to memory improvement, study skills, effective problem solving techniques, creativity, numeracy, making effective choices, risky decision making, dynamic decision making, intelligent criticism of assumptions and arguments, and evaluating claims about the mind.

Suggested background: PSY 1400.

PSY 2401. THE PSYCHOLOGY OF EDUCATION.*Cat. II*

This course is concerned with the learning of persons in educational settings from pre-school through college. Material in the course will be organized into five units covering a wide range of topics: Unit 1: Understanding Student Characteristics - Cognitive, Personality, Social, and Moral Development; Unit 2: Understanding the Learning Process - Behavioral, Humanistic, and Cognitive Theories of Learning; Unit 3: Understanding Motivation to Learn; Unit 4: Understanding Student Diversity - Cultural, Economic, and Gender Effects upon Learning; Unit 5: Evaluating Student Learning - Standardized Tests, Intelligence, Grades, and other Assessment Issues. Students planning IQPs in educational settings will find this course particularly useful. Instructional methods will include: lecture, discussion, demonstration, and project work. Course will also focus on current issues in technological education and international higher education.

Recommended background: PSY 1400 or PSY 1401.

This course will be offered in 2019-20, and in alternating years thereafter.

PSY 2406. CROSS-CULTURAL PSYCHOLOGY: HUMAN BEHAVIOR IN GLOBAL PERSPECTIVE.*Cat. II*

This course is an introduction to the study of the ways in which social and cultural forces shape human behavior. Cross-Cultural psychology takes a global perspective of human behavior that acknowledges both the uniqueness and interdependence of peoples of the world. Traditional topics of psychology (learning, cognition, personality development) as well as topics central to social psychology, such as intergroup relations and the impact of changing cultural settings, will be explored. Cultural influences on technology development and transfer, as they relate to and impact upon individual behavior, will also be investigated. Students preparing to work at international project centers, International Scholars, and students interested in the global aspects of science and technology will find the material presented in this course especially useful.

Recommended background: PSY 1400 or PSY 1402.

This course will be offered in 2020-21, and in alternating years thereafter.

PSY 2407. PSYCHOLOGY OF GENDER.*Cat. II*

This course will provide an overview of the psychological study of gender and will utilize psychological research and theory to examine the influence of gender on the lives of men and women. This course will examine questions such as: What does it mean to be male or female in our society and other societies? How do our constructs of gender develop over our life span? How does our social world (e.g., culture, religion, media) play a role in our construction of gender? and What are the psychological and behavioral differences and similarities between men and women?

Recommended background: PSY 1400 or PSY 1402.

This course will be offered in 2019-20, and in alternating years thereafter.

PSY 2408. HEALTH PSYCHOLOGY.*Cat. II*

In health psychology, we will review global and domestic health-related problems to discuss the links between health and psychology and discuss potential interventions. Health psychology is interdisciplinary in nature and relevant to students interested in health-related topics whether from a psychological, biological, biomedical, global, or preventative measures. Major health problems will be discussed: for example, AIDS is the number one cause of death worldwide; obesity (in children and adults) is a growing epidemic; the aging U.S. population will cause unprecedented health needs. Finally, stress infiltrates chronic health outcomes such as cancer, diabetes, and cardiovascular disease. We will also review what 'positive health' means including nutrition, exercise, social support, managing stress, and habits for maintaining good health.

Students will engage in research-based learning when considering psychological, cultural, and biological interventions for real world health crises.

Recommended background: Introduction to Psychological Science (PSY 1400) and/or Social Psychology (PSY 1402).

PSY 2410. SCHOOL PSYCHOLOGY.*Cat. II*

School psychology focuses on understanding children and adolescents' mental health, behavioral health and learning needs in order to work with educators and parents to help students succeed academically and socially. This course will provide an overview of the field of school psychology, drawing from educational, developmental, and cognitive research. Students will critically examine the theoretical, methodological, and practical approaches to understanding how in and out of school interventions and contexts influence the academic, social, and emotional development of children. Topics will include school readiness and transitions, behavioral and self-regulatory skills, socio-cultural diversity and skill gaps, assessment tools and classification, teacher-child interactions, and school-based interventions that promote positive development. This course differs from PSY 2401: They Psychology of Education in that it focuses on school systems rather than education more broadly. Students planning IQPs in educational settings will find this course particularly useful.

Recommended background: Introduction to Psychological Science (PSY 1400), Cognitive Psychology (PSY 1401), and/or The Psychology of Education (PSY 2401), or an approved equivalent.

PSY/MU 2501. MUSIC AND MIND.*Cat. I*

How are we able to distinguish instruments, timbres and rhythms from the intertwined sonic stream presented by the world? How do we organize these elements in time to create rhythms, melodies, phrases and pieces? How do perception and memory interact to allow us navigate a musical work? We will explore these questions by considering the cognitive and perceptual processes that shape our musical experience. Topics will include event distinction, temporal perception, hierarchical organization, perceptual grouping, expertise, memory and categorization. We will illustrate these ideas in musical contexts by listening to a variety of musical works. We will consider how psychological principles are applied to music technologies, such as compression algorithms, mixing methodologies and the field of music information retrieval. We will consider experiments that focus on some of these topics to further our understanding about how we experience music.

Note: Students that received credit for MU 202X may not receive credit for MU 2501. Students also may not receive credit for both MU 2501 and PSY 2501. This course can count for either the HUA or the SSPS requirement, but it cannot double count for both the HUA and SSPS graduation requirements.

Recommended background: Fundamentals of Music I and/or Fundamentals of Music II.

PSY 2502. PSYCHOPHYSIOLOGY.*Cat. II*

"Mind-Body" connection may be an overused term, but in social science research, there is a growing use of physiological measures to infer psychological states, that is, to "get under the skin." Sophisticated physiological measures are now commonly used to examine psychological processes. We will review the biological measures (e.g., sympathetic and parasympathetic nervous system, facial electromyography, and neuroendocrine monitoring) that can provide insight into emotional, cognitive, attitudinal, and motivational responses to psychological events, such as social rejection or helping others. The primary

focus of the course is to investigate how psychophysiology can be applied to the study of social psychological phenomena, specifically (e.g., how can prejudice or related biases in attitudes be measured 'under the skin', social evaluation, lie detection, emotion regulation, stress of conformity, the benefits of prosocial behavior).

Recommended background: Introduction to Psychological Science (PSY 1400), Social Psychology (PSY 1402), and/or Experimental Design and Analysis (PSY 3500).

PSY 2504. HUMAN SEXUALITY.*Cat. II*

Do women have less sexual arousal than men? How do religion, laws, and public policies influence perceptions of sex? What effects does pornography have on sexual attitudes and behaviors? How widespread is sexual and domestic violence?

In this class, we will explore questions relating to our sexuality. Human sexuality is the study of the biological, evolutionary, social, cultural, and political perspectives relating to sex and the meaning behind "masculinity", "femininity", and "asexual" or "genderqueer". We will discuss topics such as: gender roles, transgender, sexual orientation, the anatomy and physiology of the act of sex, relationships, sexual aggression, pornography, contraception, pregnancy, abortion, sexuality and aging, and the role of religion, law, policies, and cultural. We will think about how our sexuality influences how we think and act in the world around us. We will examine sexuality within the United States and throughout the world. This course is designed to increase awareness and sensitivity to sexuality and issues relating to it. Discussions in class will be candid and on sensitive and controversial topics.

Recommended background: Introduction to Psychological Science (PSY 1400), Social Psychology (PSY 1402), and/or Psychology of Gender (PSY 2407).

PSY 3000. PSYCHOLOGY AND LAW.*Cat. II*

How does the courtroom work and where does psychology come into play? Is it really "innocent until proven guilty"? Do people confess to crimes they never committed? How accurate are eyewitnesses? In this course, we will discuss and examine questions like these and many more. This course examines empirical research in the interface of psychology and law. We will learn about standard practices in the criminal justice system and empirical psychological research devoted to understanding these practices. As a discussion-based course, we will tackle topics such as: courtroom procedures, confessions, death penalty, deception, decision making, deliberations, eyewitnesses, expert testimony, jury selection, memory, police, and pretrial publicity. We will also explore how and when psychologists can impact legal guidelines and policies.

Recommended background: Introduction to Psychological Science (PSY 1400), Social Psychology (PSY 1402) and/or Cognitive Psychology (PSY 1401). Courses in Government and Policy Studies will also be beneficial.

PSY 3500. EXPERIMENTAL DESIGN AND ANALYSIS.*Cat. II*

In this course, students will learn about different processes used when designing experiments. In addition, they will learn about different analyses that can be used based on different experimental designs. Students will design and run a simple experiment in the course. In addition, students will analyze the data and present their findings. Topics covered in the course include experimental design, experimental methods, ethical issues related to human participants research, use of statistical analyses and programs to analyze data, and hypothesis testing.

Recommended background: Familiarity with the fundamentals of psychological science and cognitive or social psychology (PSY 1400 and PSY 1401 or PSY 1402, or equivalent).

Students may not receive credit for both SS 2400 and PSY 3500.

This course will be offered in 2019-20 and in alternate years thereafter.

Psychology Research Courses

PSY 2900. INTRODUCTION TO RESEARCH IN PSYCHOLOGICAL SCIENCE.

ISU (Credits are variable from 1/6-1/3 unit)

This course provides an opportunity for students learn how to conduct psychological research in a research laboratory in psychological sciences. Recommended background: a base understanding of Psychological Science (PSY 1400, PSY 1401, PSY 1402, or equivalent). Permission of the instructor is necessary to register. This course may be repeated for credit.

PSY 3900. RESEARCH IN PSYCHOLOGICAL SCIENCE.

ISU (Credits are variable from 1/6-1/3 unit)

This course provides an opportunity for students to conduct psychological research in a research laboratory in psychological sciences. Recommended background: a fundamental understanding of psychological science research (PSY 2900, PSY 3500, or equivalent). Permission of the instructor is necessary to register. This course may be repeated for credit.

PSY 4900. ADVANCED RESEARCH IN PSYCHOLOGICAL SCIENCE.

ISU (Credits are variable from 1/6-1/3 unit)

This course provides an opportunity for students to conduct advanced psychological research in a research laboratory in psychological sciences. Recommended background: an advanced understanding of psychological science research (PSY 3500, PSY 3900, or equivalent). Permission of the instructor is necessary to register. This course may be repeated for credit.

Psychology Special Topics Courses

PSY 1800. SPECIAL TOPICS IN PSYCHOLOGICAL SCIENCE.

Cat II (Credits will be assigned by the instructor ranging from 1/6-1/3 unit)

This course provides an opportunity for students with little to no background in psychological science to learn about a special topic within Psychological Science. This course may be repeated for different topics.

PSY 2800. SPECIAL TOPICS IN PSYCHOLOGICAL SCIENCE.

Cat II (Credits will be assigned by the instructor ranging from 1/6-1/3 unit)

This course provides an opportunity for students with some background and interest in psychological science to learn about a special topic within Psychological Science. Recommended background: An introductory background in psychological science (PSY 1400, PSY1401, PSY 1402, or equivalent). This course may be repeated for different topics.

PSY 3800. SPECIAL TOPICS IN PSYCHOLOGICAL SCIENCE.

Cat II (Credits will be assigned by the instructor ranging from 1/6-1/3 unit)

This course provides an opportunity for students with a solid background and interest in psychological science to learn about a special topic within Psychological Science. Recommended background: one 2000-level Psychological Science courses (or equivalent). This course may be repeated for different topics.

PSY 4800. SPECIAL TOPICS IN PSYCHOLOGICAL SCIENCE.

Cat II (Credits will be assigned by the instructor ranging from 1/6-1/3 unit)

This course provides an opportunity for students with a strong background and interest in psychological science to learn about a special topic within Psychological Science. Recommended background: two 2000 and/or 3000 level Psychological Science courses. This course may be repeated for different topics.

SYSTEM DYNAMICS (SD)

SD 1510. INTRODUCTION TO SYSTEM DYNAMICS MODELING.

Cat. I

The goal of this course is to provide students with an introduction to the field of system dynamics computer simulation modeling. The course begins with the history of system dynamics and the study of why policy makers can benefit from its use. Next, students systematically examine the various types of dynamic behavior that socioeconomic systems exhibit and learn to identify and model the underlying nonlinear stock-flow-feedback loop structures that cause them. The course concludes with an examination of a set of well-known system dynamics models that have been created to address a variety of socioeconomic problems. Emphasis is placed on how the system dynamics modeling process is used to test proposed policy changes and how the implementation of model-based results can improve the behavior of socioeconomic systems.

SD 2520. MODELING ECONOMIC AND SOCIAL SYSTEMS.

Cat. II

The purpose of this course is to prepare students to construct original system dynamics computer simulation models of economic and social systems from real world situations. They are coached to experiment with these models to understand unintended consequences of policy and to design effective policy interventions. Such a modeling process can be used to examine the possible impacts of policy changes and technological innovations on socioeconomic systems. The curriculum in this course covers a detailed examination of the steps of the system dynamics modeling process: problem identification (including data collection and analysis), feedback structure conceptualization, model formulation, model testing and analysis, model documentation and presentation, and policy implementation, illustrated by examples from business, economy and social systems. This course together with either SS1505 or SD1510 can provide the basic background for the students to use system dynamics in their IQP/MQP projects. Students will not be granted credit for both SD1520 and SD2520.

Recommended background: Fundamental systems thinking concepts as presented in SS1505, SD1510, or permission of the instructor.

SD 2530. ADVANCED TOPICS IN SYSTEM DYNAMICS MODELING.

This course focuses on advanced issues and topics in system dynamics computer simulation modeling. A variety of options for dealing with complexity through the development of policy models, large-scale models and the partitioning of complex problems are discussed. Topics include model building, model validation, model analysis, the use of summary statistics and sensitivity measures, and policy design. The application of system dynamics to theory building and social policy are also reviewed.

Recommended background: SD 1510.

SD 3550. SYSTEM DYNAMICS SEMINAR.

This special topics course is conducted as a research seminar, with many sessions being reserved for student presentations. Students will read, evaluate, and report on research papers representing the latest developments in the field of system dynamics. Classical system dynamics models may also be replicated and discussed. Students will complete projects that address specific problems using the system dynamics method.

Recommended background: SD 1510.

SOCIOLOGY (SOC)

SOC 1202. INTRODUCTION TO SOCIOLOGY AND CULTURAL DIVERSITY.

Cat. I

This course encourages students to explore how a sociological toolkit may be used to examine the impetus for social and historical changes and the effect such changes have on how individuals live, work, and find their place in this world. It operates from the premise that individual lives are not just personal but social—as humans we are shaped by the societies in which we live and the social forces at work within them. Major theoretical perspectives and concepts will be discussed over the course of the semester with primary emphasis on the roles that culture, dimensions of inequality and social change play in shaping individual lives. Students will also explore the influence that social institutions such as the family, religion, education, healthcare, government, economy, and environment have on how humans function within society.

GENERAL SOCIAL SCIENCE (SS)

SS 1505. GAMES FOR UNDERSTANDING COMPLEXITY.*Cat. I*

This course addresses the theory and practice of developing solutions to complex social and environmental problems through interaction with roleplaying games and computer simulations designed to promote learning and improve decision-making. By interacting with a selection of games and case studies, students will learn to recognize the systemic causes of complex social and environmental problems and gain experience developing and using simulations to test policies for creating sustainable futures. Special attention will be given to appropriate modeling practices and the design of simulation experiments. The course is run in a laboratory format in which students work in groups to play games, develop simulation models and present them to the class for feedback before they revise and refine their work iteratively for final evaluation.

Recommended background: None

Students who completed SS 150X cannot receive credit for SS 1505.

SS/ID 2050. SOCIAL SCIENCE RESEARCH FOR THE IQP.*Cat. I*

This course is open to students accepted to off-campus IQP centers and programs. The course introduces students to research design, methods for social science research, and analysis. It also provides practice in specific research and field skills using the project topics students have selected in conjunction with sponsoring agencies. Students learn to develop social science hypotheses based upon literature reviews in their topic areas and apply concepts drawn from social psychology, anthropology, sociology, economics and other areas as appropriate. Students make presentations, write an organized project proposal, and develop a communication model for reporting their project findings.

SOCIETY/TECHNOLOGY STUDIES

STS 1200. FUNDAMENTALS OF GLOBAL HEALTH.*Cat. I*

The focus of global health research and practice is improving the overall health and health equity of all people worldwide. In this course, we will use an interdisciplinary approach to explore the major biological, social, political, environmental and economic determinants of health. We will analyze the dual burden of communicable and non-communicable disease facing the world's populations including study of current health systems, global health practices and priorities as well as major organization and institutional players. Class sessions will consist of lecture, intensive small group discussion, and global health case analyses. After successful completion of this course, students will be able to explain the basic principles of public health; discuss the determinants of health; describe how globalization has changed the patterns of the spread of disease and the methods needed to control disease; evaluate the complex, multi-faceted links between health, social and economic factors; and identify critical issues in the delivery of health care services, with a particular emphasis on challenges faced with regard to different cultural and economic settings.

STS 4000. SENIOR SEMINAR IN GLOBAL PUBLIC HEALTH.*Cat. II*

The course is designed to integrate each student's educational experience and interests in Global Public Health, (e.g., core global public health courses, specializations, and experience). Through seminar discussions and writing assignments students will critically reflect on what they learned in their previous courses and project experiences. In teams, students will prepare a final capstone paper and presentation that critically engages their educational experience in global public health and anticipates how their courses and experiences will translate into their future personal and professional. The course is especially designed as the capstone seminar for Global Public Health minors, but is also open to non-minors.

Recommended background: previous courses in global public health, and completion or concurrent registration with a global public health-related MQP, IQP or ISU.

This course will be offered in 2019-20, and in alternating years thereafter.

UNIVERSITY POLICIES AND PROCEDURES

SECTION 4

University Policies and Procedures	208
Grades	208
Grade Appeal and Grade Change Policy	209
Transfer Credit	211
Graduation with Honors	211
Commencement	212
Early Completion	212
Designation of Major Area of Study	212
Double Major	212
Designation of Class Year	212
Academic Honesty Policy	212
Guidelines for the Determination of Satisfactory Academic Progress, Academic Warning, Academic Probation and Academic Suspension	214
Administrative Obligations and Holds	215
Directory Information and Release of Information	215
Office of the Registrar	216
Part-Time Degree Students	219
Non-Degree Students	219

GRADES

DISTRIBUTION OF GRADES

Academic grades of undergraduate students may be released to parent(s) of a student claimed as a dependent for tax purposes. WPI presumes that all undergraduate students are dependents of their parent(s) unless they file a Declaration of Independent Status petition form with the Registrar's Office. These forms are available in the Registrar's Office. After the Registrar's Office receives a Declaration of Independent Status petition form from an undergraduate student, the Office will not release the student's academic grades to the parent(s) of such student until such time as the student rescinds their Declaration, in writing filed with the Registrar's Office, or his/her parent(s) provide acceptable proof of tax-dependent status to the Registrar's Office.

GRADING SYSTEM

Projects: The following term grades are possible: A, B, C, SP (Satisfactory Progress), NAC (Not Acceptable) and NR (No record).

Courses: The following grades are possible: A, B, C, NR, and I (Incomplete). An instructor may also assign an "I" in an Independent Study course. AT (attended) is used to denote participation in seminars or college-sponsored programs.

Students such as Consortium (CO), nondegree-seeking students, and Graduate students will receive traditional A, B, C, D, F, Withdrawal and Pass/Fail grades.

GRADES FOR COMPLETION OF DEGREE REQUIREMENTS

The overall evaluation of degree requirements (for the MQP, the IQP and the Humanities and Arts Requirement) will be graded in the student's respective grade system. The transcript will contain an abstract describing the content of the completed project.

NO RECORD (NR)

The NR (No Record) grade is assigned by a faculty member for course or project work for which credit has not been earned. This grade applies to PLAN students (admitted, degree-seeking) only. The NR grade does not appear on the students' transcripts or grade reports.

INCOMPLETE (I)

An I grade, when assigned, will be changed to NR after one term unless extended in writing by the instructor to the Registrar's Office. The I grade is not assigned for Qualifying Projects.

SATISFACTORY PROGRESS (SP)

In project work (IQP, MQP only) extending beyond one term for which a grade is not yet assigned, an interim grade of SP (Satisfactory Progress) may be used on grade sheets. In such cases, the SP evaluation will count as units earned toward meeting the 15-unit rule, the distribution requirements, and the minimum standards for satisfactory academic progress. SP grades remain on the transcript until changed to the final grade as submitted on the Completion of Degree Requirement Form or through the grade change form procedure.

OTHER GRADES

A ? or Q signifies a grade that has not been submitted.

QUALIFYING PROJECT GRADING

The Faculty of WPI has endorsed the following grading guidelines for qualifying project activity:

1. Each term a student is registered for a qualifying project, the student receives a term grade reflecting assessment of his or her accomplishments for that term.
2. Upon completion of a project, each student will receive an overall project grade (also known as the "CDR grade," since it certifies completion of the degree requirement) reflecting his or her individual overall accomplishments for the project.
3. The term grades and the overall project grade reflect both the *products* of the project (e.g., results, reports, etc.) and also the *process* by which they were attained. The term grades and the overall project grade may be different.

The following are some characteristics that faculty should use in communicating expectations and evaluating the quality of each student's project work.

The degree to which the student:

- developed effective or creative goals or approaches,
- demonstrated initiative and originality,
- showed depth and critical thought in analysis,
- produced high quality results,
- took the lead in discussion, planning, and analysis,
- produced a clear, professional-level report with excellent drafts along the way,
- anticipated work that needed to be done and completed it in a timely manner, and
- worked to advance the success of the team.

For both terms and overall project, the available grades and interpretations are:

A: This grade denotes *excellent work* that attains all of the project goals and learning outcomes. The product and process of this work meet all of the expectations and exceed them in several areas.

B: This grade denotes *consistently good work* that attains the project goals and learning outcomes. The product and process of this work meet but generally do not exceed all of the expectations.

C: This grade denotes *acceptable work* that partially attains project goals and learning outcomes. The product and process of this work meet some but not all expectations.

SP: This grade denotes *satisfactory progress* and certifies sufficient accomplishments to earn credit for that term. Faculty who assign this grade should provide clear feedback to the student regarding his or her progress during the term. The use of the SP grade is discouraged except in circumstances where the faculty member is unable to judge the quality of the work, yet can attest that the granting of credit is appropriate. This is a temporary grade and must be replaced by a permanent grade consistent with the criteria outlined above by, if not before, the end of the project.

NR: This grade denotes work that did not attain the project goals or learning outcomes and is *insufficient for registered credit*. Both product and process were inconsistent with acceptable project work at WPI as outlined above.

NAC: This grade is reserved for *performance that is unacceptable*. It might mean that a student's performance (or lack of it) has seriously impeded group progress, or it has embarrassed the group, a project sponsor, or WPI. Note that this grade remains on the transcript.

4. Project goals should be established and clearly articulated early in the project. This may be done in the form of a formal project proposal. Learning outcomes for the qualifying projects have been established by the faculty and are published in the undergraduate catalog.
5. Project advisors should clearly convey in writing their expectations for learning and performance to project students at the start of the project, and provide students with substantive feedback on a regular basis during the project.

CUMULATIVE POINT AVERAGE

WPI does not maintain a Cumulative Grade Point Average for undergraduate students. A student who needs a cumulative point average for external use may apply to the Registrar and receive a numerical equivalent. This information is usually provided only for students applying to graduate or professional schools when the application process requires a translation. Cumulative point averages will not be printed on student's transcripts nor shall class rankings be developed from them.

When requested by the student, the numerical equivalent of the cumulative point average will be based on a point assignment of A = 4.0, B = 3.0, C = 2.0 while DIST and AC grades will be 4.0 and 2.75 respectively.

DEAN'S LIST

The Dean's List is created and published twice a year: in January to review student work completed during the AB terms and in May to review student work completed during the CD terms. To be named to the Dean's List a student must:

Complete 4/3 units with grades of A's, and at least an additional 2/3 units with grades of B or above.

For example, a student with 4A's, 2B's and 1C (or 1 NR) in 1/3-unit courses during a semester is eligible for the Dean's List. Credits earned in Physical Education, Military Science, and Air Force Aerospace Studies are not used in the evaluation for the Dean's List. For the purposes of determining the Dean's List only, an SP grade for project work will be considered a B grade. The Dean's List recognizes outstanding work completed during the most recent semester. Student requests to re-evaluate their eligibility for the Dean's List due to a grade change after the semester review is completed will be considered only in unusual circumstances and at the discretion of the Dean of Undergraduate Studies.

GRADE APPEAL AND GRADE CHANGE POLICY

The purpose of the Grade Appeal Policy is to provide the student with a safeguard against receiving an unfair final grade, while respecting the academic responsibility of the instructor. Thus, this procedure recognizes that,

- Every student has a right to receive a grade assigned upon a fair and unprejudiced evaluation based on a method that is neither arbitrary nor capricious; and,
- Instructors have the right to assign a grade based on any method that is professionally acceptable, submitted in writing to all students, and applied equally.

Instructors have the responsibility to provide careful evaluation and timely assignment of appropriate grades. Course and project grading methods should be explained to students at the beginning of the term. WPI presumes that the judgment of the instructor of record is authoritative, and the final grades assigned are correct.

A grade appeal shall be confined to charges of unfair action toward an individual student and may not involve a challenge of an instructor's grading standard. A student has a right to expect thoughtful and clearly defined approaches to course and project grading, but it must be recognized that varied standards and individual approaches to grading are valid. The grade appeal considers whether a grade was determined in a fair and appropriate manner; it does not attempt to grade or re-grade individual assignments or projects. It is incumbent on the student to substantiate the claim that his or her final grade represents unfair treatment, compared to the standard applied to other students. Only the final grade in a course or project may be appealed. In the absence of compelling reasons, such as clerical error, prejudice, or capriciousness, the grade assigned by the instructor of record is to be considered final.

In a grade appeal, only arbitrariness, prejudice, and/or error will be considered as legitimate grounds for an appeal.

Arbitrariness: The grade awarded represents such a substantial departure from accepted academic norms as to demonstrate that the instructor did not actually exercise professional judgment.

Prejudice: The grade awarded was motivated by ill will, and is not indicative of the student's academic performance.

Error: The instructor made a mistake in fact.

This grade appeal procedure applies only when a student initiates a grade appeal and not when the instructor decides to change a grade on his or her own initiative. This procedure does not cover instances where students have been assigned grades based on academic dishonesty or academic misconduct, which are included in WPI's Academic Honesty Policy. Also excluded from this procedure are grade appeals alleging discrimination, harassment or retaliation in violation of WPI's Sexual Harassment Policy, which shall be referred to the appropriate office at WPI as required by law and by WPI policy.

The Grade Appeal Procedure strives to resolve a disagreement between student and instructor concerning the assignment of a grade in an expeditious and collegial manner. The intent is to provide a mechanism for the informal discussion of differences

of opinion, and for the formal adjudication by faculty only when necessary. In all instances, students who believe that an appropriate grade has not been assigned must first seek to resolve the matter informally with the instructor of record. If the matter cannot be resolved informally, the student must present his or her case to the Faculty Review Committee before the end of the second week of the term after the disputed grade is received (D term grades may be appealed the following A term). Any exceptions to this deadline for submission of appeal can only be made by the Office of the Provost.

STUDENT GRADE APPEAL PROCEDURE

1. A student who wishes to question a grade must discuss the matter first with the instructor of record within one week after the start of the next regular academic term (A – D) after receiving the grade. Late appeals will only be reviewed at the discretion of the Faculty Review Committee (FRC). In most cases, the discussion between the student and the instructor should suffice and the matter will not need to be carried further. The student should be aware that the only valid basis for grade appeal beyond Step One is to establish that an instructor assigned a grade that was arbitrary, prejudiced, or in error.
2. If the student's concerns remain unresolved after the discussion with the instructor, the student may submit a written request to meet with the appropriate Department Head, within one week of speaking with the instructor. For a grade in a course, independent study, Inquiry Seminar or Practicum, or Major Qualifying Project (MQP), the appropriate person is the instructor's Department Head. For a grade in an Interactive Qualifying Project (IQP), the appropriate person is the Dean of the Interdisciplinary and Global Studies Division (IGSD). If the instructor of record is a Department Head or the Dean of the IGSD, then the student should request to meet with the representative from the Provost's office (the Dean of Undergraduate Studies, or alternative if necessary), who will serve as the appropriate Department Head/Dean in this step. The appropriate Department Head/Dean will meet within one week with the student, and, if he or she believes that the complaint may have merit, with the instructor. After consultation with the Department Head/Dean, the instructor may choose to let the grade remain, to change a course grade, or to petition the Committee on Academic Operations to change a grade for a Degree Requirement (CDR grade for MQP, IQP, or Humanities and Arts Inquiry Seminar or Practicum). The Department Head/Dean will communicate the result of these discussions to the student.
3. If the matter remains unresolved after Step Two, the student should submit a written request within one week to the Provost's Office to request an ad hoc Faculty Committee for Appeal of a Grade. The Provost's representative (the Dean of Undergraduate Studies, or alternate) will meet with the student, and will ask the FRC to appoint the ad hoc Committee for Appeal of a Grade. The Chair of the FRC will select the members of the ad hoc committee and serve as its non-voting chair. The ad hoc committee for all undergraduate appeals will be composed of three FRC members.

Appointees to the ad hoc committee must not have any apparent conflicts of interest with the student or instructor of record. The Chair of the FRC requests a written statement from the student and a written response from the instructor. The ad hoc committee examines the written information and may gather additional information as it sees fit.

4. Through its inquiries and deliberations, the ad hoc committee is charged to determine whether the grade was assigned in a fair and appropriate manner, or whether clear and convincing evidence of arbitrariness, prejudice, and/or error might justify changing the grade. The ad hoc committee will make its decisions based on a majority vote.
5. If the ad hoc committee concludes that the grade was assigned in a fair and appropriate manner, the ad hoc committee will report its conclusion in writing to the student and instructor. This decision of the ad hoc committee is final and not subject to appeal.
6. If the ad hoc faculty committee determines that compelling reasons exist for changing the grade, it would request that the instructor make the change, providing the instructor with a written explanation of its reasons. At this point, the instructor may change the grade. If the instructor declines to change the grade, he or she must provide a written explanation for refusing. If the ad hoc faculty committee concludes that the instructor's written explanation justifies the original grade, the ad hoc committee will report this in writing to the student and instructor and the matter will be closed. If the ad hoc faculty committee concludes that it would be unjust to allow the original grade to stand, the ad hoc committee will then determine what grade is to be assigned. The new grade may be higher than, the same as, or lower than the original grade. Having made this determination, the three members of the committee will sign the grade change form and transmit it to the Registrar. The instructor and student will be advised of the new grade. Under no circumstances may persons other than the original faculty member or the review committee change a grade. The written records of these proceedings will be filed in the student's file in the Registrar's Office.

FACULTY GRADE CHANGE PROCEDURE

The Student Grade Appeal Procedure affirms the principle that grades should be considered final. The principle that grades for courses or projects should be considered final does not excuse an instructor from the responsibility to explain his or her grading standards to students and to assign grades in a fair and appropriate manner. The appeal procedure also provides an instructor with the opportunity to change a grade for a course or project on his or her own initiative. The appeal procedure recognizes that errors can be made and that an instructor who decides that it would be unfair to allow a final grade to stand due to error, prejudice or arbitrariness may request a change of grade for a course or project without the formation of an *ad hoc* committee. An instructor may request a grade change in one of two ways. First, for courses, an instructor may submit a course grade change via BannerWeb to the Registrar at any time prior to a student's graduation. Second, for Degree Requirements (MQP, IQP), an instructor must submit a petition to the Committee on Academic Operations (CAO) to change the grade.

TRANSFER CREDIT

TRANSFER CREDIT BEFORE MATRICULATION TO WPI

After a student has been accepted and final transcripts received, the Office of Admissions coordinates the formal evaluation of credit accepted towards a WPI degree. Courses taken at regionally accredited post-secondary institutions that are comparable to courses offered at WPI will be reviewed for course content and level by the WPI department offering the comparable course. Only those courses in which the transfer student received a grade of C or better will be evaluated for possible transfer credit. Please note vocational, correspondence, pre-college or review courses are not transferable. Also, non-credit CEU courses, adult enrichment or refresher courses, and CLEP examinations are not recognized for transfer credit.

TRANSFERING CREDIT AFTER MATRICULATION TO WPI

If you are currently a WPI student who wishes to take courses at a regionally accredited post-secondary institution, you must obtain a WPI Transfer Credit Authorization form from the Registrar's Office. This form and the course description must be taken to the WPI department head or transfer faculty approved by the department head for approval **before** the course is taken. On the form, the department head specifies a minimum grade for transfer. This minimum grade depends on the institution at which the course is taken and how critical the course is to the department. Please note, most departments do **not** accept on-line courses for transfer credit. Confirm this with the relevant department before registering and completing any on-line courses. Courses that have not been pre-approved may not receive transfer credit. The completed form must be filed in the Registrar's Office before taking the course. After successful completion of the course, an official transcript should be sent to WPI. Students can check the web for posting of credit. Please note vocational, correspondence, pre-college or review courses are not transferable. Also, noncredit CEU courses, adult enrichment or refresher courses, and CLEP examinations are not recognized for transfer credit.

TRANSFERRING CONSORTIUM COURSES

Courses taken through the consortium do not need to be transferred into WPI. Courses will automatically be part of the WPI transcript. However, if you are taking the course through the consortium to fulfill a WPI distribution requirement, you should check with the Registrar's Office to see if the course has been pre-approved to satisfy the requirement. If not, you will need approval from the relevant department head before taking the course.

To apply for approval of a consortium course to satisfy a specific WPI distribution requirement, a student must obtain a WPI Transfer Credit Authorization form from the Registrar's Office. This form and the course description must be taken to the WPI department head for approval before the course is taken. The WPI department head decides whether the proposed course meets the department distribution requirement. If it does, the department head specifies on the form a minimum grade for satisfying the distribution requirement. This minimum

grade depends on the institution at which the course is taken and how critical the course is within the department. Courses that have not been pre-approved may receive WPI elective credit. The complete form must be filed in the Registrar's Office before taking the course.

GRADUATION WITH HONORS

For all degree candidate students graduating from WPI after May 1, 2011, graduation honors will be determined as follows:

Graduation With High Distinction

An *A* grade on all *four* of the following:

- MQP
- IQP
- Inquiry Seminar/Practicum
- Eight units of work registered at WPI (exclusive of PE and of the MQP, IQP and the Inquiry Seminar/Practicum component of the Humanities and Arts Requirement).

Graduation With Distinction

A grade of *A* on the following criteria:

- MQP
- IQP
- Inquiry Seminar/Practicum
- Four units of work registered at WPI (exclusive of PE and of the MQP, IQP and the Inquiry Seminar/Practicum component of the Humanities and Arts Requirement).

or

a grade of *A* on the following criteria:

- Two of the three projects: MQP, IQP and the Inquiry Seminar/Practicum
- Six units of work registered at WPI (exclusive of PE and of the MQP, IQP and the Inquiry Seminar/Practicum component of the Humanities and Arts Requirement).

For all degree candidate students graduating from WPI from May 1, 1986, to June 1, 2010, graduation honors will be determined as follows:

Graduation with High Distinction

An *A* or *DIST* grade on any four of the following:

- MQP
- IQP
- Inquiry Seminar/Practicum
- Six units of work registered at WPI (exclusive of PE and of the MQP, IQP, or the Inquiry Seminar/Practicum component of the Humanities and Arts Requirement).

Graduation with Distinction

An *A* or *DIST* grade on any three of the above.

HONORS FOR DOUBLE MAJORS

If a student completes two majors, the student is awarded a degree with "Distinction" or "High Distinction" if the student meets the criteria above in either or both majors; if both awards are received, the degree is awarded with "High Distinction."

COMMENCEMENT

COMMENCEMENT POLICY

The policy for allowing certain undergraduate students who have not completed all degree requirements to participate in Commencement exercises is:

1. Undergraduate students who have not met all degree requirements will be eligible to participate in Commencement exercises only if *all of the following* are true:
 - a. At the end of D term, the student is within 1/3 unit of one activity in all requirements for graduation.
 - b. The student has completed at least 2 of the 3 WPI Project Requirements (Humanities and Arts Requirement, IQP, and MQP).
2. Undergraduate students who meet these conditions will be permitted to participate in Commencement exercises but will not receive their diploma. The names of such students will **not** be included in the Commencement program. The actual degree will be conferred only after all degree requirements have been completed.
3. All WPI undergraduate students will be notified of these policies and procedures each B term.
4. Undergraduate students seeking an exception to this policy have the right to petition the Committee on Academic Operations for a waiver due to extenuating circumstances. Petitions must be received no later than noon (12 p.m.) the Wednesday before Commencement Day.

EARLY COMPLETION

Students completing 100% of WPI graduation requirements by the end of A-term or C-term will be eligible for a 50% tuition adjustment for the semester of completion. Eligible students must complete the form available in the Registrar's Office and submit by the end of B-term (for C-term completion) or D-term (for A-term completion). Students/responsible parties will be billed for the full semester and then tuition charges will be reduced by 50% once the graduation requirements have been signed off and the student's withdrawal has been officially processed. Qualified students receiving financial aid from WPI will retain 50% of any WPI scholarship, and their loan eligibility will be reviewed on an individual basis. Students living in WPI housing will still be financially responsible for paying the full semester's worth of room and board.

Students are permitted to enroll in a maximum of 4/3 units (12 credits), excluding PE, in either A or C term. Students registered beyond 4/3 units will be charged the overload fee.

DESIGNATION OF MAJOR AREA OF STUDY

Designation of a student's major area of study on the transcript is determined by his or her completion of published academic activity distribution requirements, as well as by the Major Qualifying Project. The authority and responsibility of certification of the disciplinary or interdisciplinary area will lie with the appropriate departmental or IGSD Program Review Committee (PRC) in consultation with the student and his or her academic advisor.

For examples of major areas of study, please see page 8.

DOUBLE MAJOR

DISTRIBUTION REQUIREMENTS

The distribution requirements of each major must be met, but requirements common to both majors may have to be met only once. A minimum of three units of qualifying project work is thus required for fulfillment of the project portion of the double major requirements: one unit in each of the two major areas of study, and one unit of an IQP. See page 7 for details and options.

For students wishing to pursue double majors not involving social science, the program audit for each intended major must be completed and certified by the review committee of each department involved. Academic activities appropriate to both majors may be counted in both majors.

For the policy in the special situation of double majors involving the social sciences, see page 118.

If a student wishes to complete two Interdisciplinary (individually designed) Majors Programs, the double major must be proposed in a single Educational Program Proposal, which must be approved by the student's Program Advisory Committee for each major. The Committees shall ensure that the majors are substantially nonoverlapping.

If a student's double major includes an Interdisciplinary (individually designed) Major Program, the double majors must be described in the Educational Program Proposal for the Interdisciplinary Major.

DESIGNATION OF CLASS YEAR

Class year will normally be designated as year of matriculation plus four with the additional requirement that the accumulation of 34/3 units is necessary for fourth-year status, 22/3 units for third-year status, and 10/3 units for second-year status. The class year of transfer students will be determined on an individual basis. Class year designations will be reviewed at the end of Term E each year and changed if the credit accumulation does not meet the above specifications. After Term E, students may petition to be redesignated in their original class if they meet the minimum unit requirements.

ACADEMIC HONESTY POLICY

Academic honesty is a fundamental principle of learning and a necessary foundation for all academic institutions, particularly those dedicated to independent project-based education, such as WPI. Violations of the principle deny the violators an opportunity to obtain confident command of the material they are credited with knowing, cheat their classmates out of deserved rewards and recognition, debase the institution, and demean the degree that it awards. It is, therefore, a matter of great and mutual concern to all members of the WPI community that a concerted effort be made to maintain high standards of integrity, both to protect the value of the educational process in which we are engaged and to maintain the credibility of the institution.

DEFINITION

Individual integrity is vital to the academic environment because education involves the search for and acquisition of knowledge and understanding, which are, in themselves, intangible. Evaluation of each student's level of knowledge and

understanding is a vital part of the teaching process, and requires tangible measures such as reports, examinations, and homework. Any act that interferes with the process of evaluation by misrepresentation of the relation between the work being evaluated (or the resulting evaluation) and the student's actual state of knowledge is an act of academic dishonesty. The following acts are examples of academic dishonesty at WPI:

Fabrication

Examples:

- Altering grades or other official records
- Changing exam solutions after the fact
- Inventing or changing laboratory data
- Falsifying research
- Inventing sources
- Sabotage of another student's work or academic record

Plagiarism

Examples:

- Misrepresenting the work of another as one's own
- Inaccurately or inadequately citing sources including those from the Internet

Cheating

Examples:

- Use of purchased term papers
- Copying on exams, homework, or take-home exams
- Use of unauthorized materials or sources of information such as "cheat sheet," pre-programmed calculator
- Assistance of another person in cases where prohibited

Facilitation

Examples:

- Sharing test questions or answers from an exam with another student
- Letting another student copy a solution to a homework problem, exam, or lab
- Taking an exam for another student
- Assistance in any act of academic dishonesty of another student

RESPONSIBILITIES OF FACULTY MEMBERS AND STUDENTS

Faculty members should outline their policies concerning evaluation procedures and their expectations pertaining to academic integrity at the beginning of each course. Faculty must ensure that student performance is judged solely on the basis of academic work in courses and projects. Because of the differences in disciplines and the type of work involved, faculty interpretation regarding what constitutes academic dishonesty may vary across campus. Since project-based education places a strong emphasis on group work, faculty and students should be particularly attentive to the distinction between group work and individual performance expectations. Faculty and students are responsible for knowing and understanding WPI's policy and procedure for dealing with academic dishonesty. Faculty are encouraged to implement measures designed to minimize or prevent academic dishonesty.

PROCEDURES

The WPI faculty and administration have developed a set of procedures designed to ensure uniform (and fair) treatment of undergraduate or graduate students suspected of academic dishonesty. Students or others who suspect a faculty member of professional dishonesty should consult the academic department head or the provost.

- Faculty shall report to the department chair any suspected act of academic dishonesty.
- The chair shall review cases referred to him/her to determine if there is reason for believing that academic dishonesty may be involved.
- Faculty shall allow the student to continue in the course without prejudice, pending resolution of the case.
- The chair or instructor shall check with the dean or associate dean of students to determine if the student has any record of prior offenses involving academic dishonesty.
- The chair or instructor shall consult with the student involved. If the act of academic dishonesty is admitted and is the first violation of that nature, the chair or instructor may resolve the complaint within the department, provided the penalty is accepted by the student in writing. The maximum penalty that can be applied at the department level is dismissal from a course or a project without credit. In all cases, a signed, written report on the matter, including the action taken, shall be sent to the Dean of Students Office and to the student's Academic Advisor.
- For the second and subsequent violations, the case shall be submitted to the Campus Hearing Board for resolution.
- The Campus Hearing Board shall hear the allegations, following standard procedures for disciplinary hearings established by WPI. The board may impose normal disciplinary sanctions and may recommend loss of any credit or grade for the course or project. If a student is found not responsible on a complaint of academic dishonesty, he/she may not be failed or penalized by the instructor on the grounds of dishonesty. The instructor shall assign a grade based on his or her assessment of the student's mastery of the material being evaluated.
- Disciplinary records for any act of academic dishonesty shall be retained in the Dean of Students Office for two years from the date of graduation or withdrawal from WPI, except when the sanction includes suspension or expulsion. In cases resulting in suspension or expulsion from WPI, disciplinary records shall be kept in perpetuity. Records for cases that are pending completion of the hearing and/or the sanction shall be kept in perpetuity. Judicial records are kept separate from a student's academic records. A student's judicial record may be shared internally as appropriate to determine if a past record exists. Records shall be available to prospective employers and other authorized individuals, in accordance with federal regulations that require written permission from the student involved.

GUIDELINES FOR THE DETERMINATION OF SATISFACTORY ACADEMIC PROGRESS, ACADEMIC WARNING, ACADEMIC PROBATION AND ACADEMIC SUSPENSION

SATISFACTORY ACADEMIC PROGRESS

In order to assist the student, parents, and the academic advisor in determining whether a student is making academic progress, WPI has adopted the following guidelines.

To maintain Satisfactory Academic Progress, a student must:

1. Complete at least 4/3 units of academic work for the fall semester (A and B terms); and
2. Complete at least 4/3 units of academic work for the spring semester (C and D terms).

Note: Air Force Aerospace Studies (AS), Military Science (ML), and Physical Education (PE) courses are not included in any evaluation of Academic Progress.

Academic Progress is evaluated at the end of each semester and any student who does not maintain Satisfactory Academic Progress will move down one level of academic standing (to warning, from warning to probation, or from probation to suspension). First-year students who earn no academic credit (see note above) during their first two terms at WPI will be placed on Academic Suspension. Thereafter, any student who earns no academic credit in a semester will move down two levels in academic standing.

ACADEMIC WARNING

Each student's academic record will be reviewed at the conclusion of terms B and D according to the guidelines above. If a student's performance falls short of either guideline 1 or 2, the student, parent and academic advisor will be notified that the student is not making satisfactory progress. This notification will place the student on Academic Warning for two terms. At this time, the student is urged, with the help of the advisor, to identify the nature of the academic difficulty and to formulate a course of action for overcoming the difficulty. Students on academic warning may apply to the Global Projects Program, but WPI reserves the right to withdraw acceptance to students who are subsequently placed on academic probation.

ACADEMIC PROBATION

During the next review of academic progress, should the student fail, once again, to maintain satisfactory academic progress, the student, parent and academic advisor will be notified. This notification will place the student on Academic Probation for two terms. Academic Probation will prevent the student from receiving financial aid, will result in loss of eligibility for team sports, will prevent the student from obtaining undergraduate employment in the Co-op Program and will prevent participation in the Global Projects Program.

ACADEMIC SUSPENSION

Should a student on Academic Probation fail to make satisfactory academic progress during the next review period, the student will be *suspended* from WPI. The notification will prevent the student from enrolling as a full-time student *or* a part-time student for at least the next two terms. Subsequent readmission is subject to approval (with possible conditions) of a petition through the Registrar to the Committee on Academic

Operations (CAO). As a general rule, a student readmitted after suspension will be placed on an Academic Probation status.

New students (first year or transfer) who fail to obtain academic credit for the first two terms shall be placed on Academic Suspension and not allowed to enroll for the following two terms. To apply for readmission, a student must submit a petition to the Committee on Academic Operations (CAO).

IMPROVEMENT IN STATUS

Students on Academic Warning or Academic Probation have the opportunity to improve their status by progressing through the levels in reverse order. If a student on Academic Probation satisfactorily meets the guidelines at the end of the next review period, he or she will be moved to the list of students on Academic Warning. A student on Academic Warning would be moved back to Satisfactory Academic Progress status.

SUMMER REVIEW PERIOD

An exception to the guidelines stated above can occur when a student registers for Term E. At the conclusion of Term E, a review will be conducted which will include E-term and the previous four terms. If the student has completed 10/3 units acceptable work, the student's academic progress status will improve. Thus, a student on Warning status after the Term D review will start terms A and B on Satisfactory Academic Progress. A student placed on Academic Probation after the Term D review will be on Warning status for terms A and B.

SUMMER ACADEMIC SUCCESS PROGRAM

Students who finish the academic year on Academic Warning or Academic Probation status, but who have passed at least 2 units of academic work during the previous four terms, are eligible to participate in the Summer Academic Success Program. Students who participate in the program enroll in ID 1000- Summer Academic Success Program, a five-week academic skills course, as well as two E Term courses. Successful completion of the courses and ID 1000 will result in the academic status rising one level (Academic Probation to Academic Warning, or Academic Warning to Satisfactory Academic Progress). The Office of Academic Advising coordinates the Summer Academic Success Program.

PART-TIME STUDENTS

Students pursuing the bachelor's degree as part-time students will be subject to the same review schedule and standards as full-time students. All part-time students will be reviewed after the Fall and Spring semesters and must satisfactorily complete at least one-third of the academic activities for which he/she has registered. For more information on part-time status, please see page 219.

GRADE CHANGES AND ACADEMIC STATUS

Students who are placed on Academic Warning or Academic Probation at the end of a given semester may receive a grade change (either incomplete to letter or letter to letter) that may improve the standing. The Registrar will re-review a student's standing if the grade change comes in by the last day of the immediately following term. Please note that, depending on the timing of this re-review, the improved standing may not have an effect on financial aid implications. This option is not available to students on suspension. Suspended students must petition the Committee on Academic Operations for reconsideration or to return from suspension.

PETITIONS

Students may petition through the Registrar's Office to the Committee on Academic Operations (CAO) for reconsideration of the status of the following:

- Academic Probation
- Academic Suspension
- Readmission after Suspension

Students who petition for reconsideration of status must accomplish the following:

1. Obtain a petition form from the Registrar's Office webpage.
2. Complete the form and obtain advisor's approval and signature.
3. Submit the form to the Registrar's Office within three weeks of the issuance of grades for B, D, or E term reviews except for readmission after suspension.

DEADLINES FOR READMISSION AFTER SUSPENSION

July 20 for Term A

November 15 for Term C

ADMINISTRATIVE OBLIGATIONS AND HOLDS

The college reserves the right to hold grades, transcripts, registration and/or diploma for any student who has an outstanding administrative obligation with the college.

DIRECTORY INFORMATION AND RELEASE OF INFORMATION

The items listed below are designated as Directory Information and may be released at the discretion of the institution. Under the provisions of the Family Educational Rights and Privacy Act of 1974, as amended, students have the right to withhold the disclosure of any or all of the categories of Directory Information. Written notification to withhold directory information must be received by the Registrar's Office during the first week of the fall semester. Forms are available in the Registrar's Office. A request to withhold directory information in no way restricts internal use of the material by the college.

Directory information will include the student's campus mailbox, full name, year, major, advisor, e-mail address, home address, local address, local phone, photograph, date and place of birth, dates of attendance, degrees and awards received, and most recent or previous educational agency or institution.

Unless a student notifies the Registrar's Office in writing to the contrary, the college considers all undergraduate students to be dependents of their parents. In compliance with the Family Educational Rights and Privacy Act, the college reserves the right to disclose information about the status of dependent students to their parents without the students' written consent. Petition forms for Declaration of Independent Status are available in the Registrar's Office upon request (see information under Distribution of Grades, page 208).

POLICY ON RELEASING INFORMATION ON DECEASED STUDENTS

The education records of deceased students may be released or disclosed, at the time of death, upon written request, to a spouse, a parent, the executor of the estate, the eldest surviving child, the eldest surviving sibling, and surviving descendent, or pursuant to a court order or subpoena. Only the Registrar may release the academic records of deceased students. The person requesting the records must provide as much of the following information as possible within the written request:

Student's name (and maiden name, if applicable).

Student's Social Security number.

Student's date of birth.

The dates that the deceased student attended WPI.

Death Certificate (Photo copy is acceptable).

The petitioner must also provide the following personal information within his/her written request:

Name.

Address.

Phone Number.

Evidence that he/she is qualified to receive the records, based on the above criteria or, in the absence of evidence, a statement certifying the same.

Signature.

Date of request.

REGISTRATION

During the spring, students will receive information regarding course offerings for the following academic year. After consulting with academic advisors, students will make course selections via the online registration system. Students with holds will be prevented from registering until the obligation is met.

A calendar is published by the Registrar's Office prior to the add/drop period which specifies the time periods and fees for late changes. Students are responsible for the dates and should contact the Registrar's Office if they need information to avoid late fees. Requests for exceptions to published deadlines must be submitted in writing to the Registrar's Office and will be granted based on documented extenuating circumstances, i.e., medical, military obligations.

CHECK-IN

At the beginning of terms A and C, students will receive check-in information. Check-in is an on-line confirmation that students will be attending classes or working on a project for that particular semester. In addition, by checking-in, students acknowledge that they will be financially responsible for paying all charges associated with that particular semester. All students must check-in whether or not course changes are to be made.

COURSE CHANGES

There is an add/drop period at the start of each term and the exact deadlines depend on the length of the course session (7, 10, or 14 weeks).

For 7-week courses (undergraduate and graduate), a student can add a course without a fee through the fifth day of classes. On the sixth through the tenth day of classes, students can add courses (with instructor approval) with a \$100 late fee. Students can drop courses on days 1-10 of each term without incurring a late fee. For undergraduates in 7-week courses, no adds or drops are allowed after the tenth day of the term. For graduate students in 7-week courses who drop a course after the tenth day, but before the end of the fifth week of the term, a W (Withdrawal) will be assigned. No tuition or fees will be refunded after the tenth day of the term.

For 14-week courses (undergraduate and graduate), students can make course changes (add or drop) without penalty through the tenth day of the semester. A \$100 late fee will be charged for course adds after the tenth day of the semester and instructor permission is required. No drops are allowed after the tenth day of the semester; for graduate students, course withdrawals are permitted through the tenth week of the semester, and a grade of W (Withdrawal) will be assigned. No tuition or fees will be refunded after the tenth day of the semester. Consult the University calendar for specific dates.

For 10-week courses (undergraduate and graduate), students can make course changes (add or drop) without penalty through the tenth day of the semester. A \$100 late fee will be charged for course adds after the tenth day of the semester and instructor permission is required. No drops are allowed after the tenth day of the semester; for graduate students, course withdrawals are permitted through the seventh week of the semester, and a grade of W (Withdrawal) will be assigned. No tuition or fees will be refunded after the tenth day of the semester.

Note: If a degree-seeking student is dropping or withdrawing from all registered course activity, they must either take an institutional leave of absence or officially withdraw from the University.

WAIT LISTS

When a seat in a class becomes available to a student on the wait list, he or she will be notified via e-mail. The e-mail contains instructions on how to claim the available seat. If a student does not receive an e-mail, it means no seat is available for him/her in the wait-listed class.

OVERLOADS OF COURSES

The standard course load for WPI students is one unit per term (exclusive of courses for ROTC and Physical Education, which do not count towards overloads). Students may register in advance for a maximum of one unit in any term.

Registration for courses which will result in an overload may take place, on a space-available basis, as of the first day of the term in which that course is offered.

A student may not include any portion of qualifying work as part of an overload without the approval of both the academic and project advisors. Written approval will be requested before registration can be completed in such cases.

Overload charges will be computed each semester based on the course and project load based on the student's registration after the add/drop period in the second term of the semester.

Note: undergraduates taking graduate courses receive more credit for said courses and are billed accordingly. Please take this into account when considering overload fees.

To compute overload charges, see Expenses, page 246.

WITHDRAWAL FROM COURSES

Students who wish to withdraw from a course or project will be assigned a grade of NR (No Record) by the instructor. The student should contact the instructor and indicate that he/she will not be continuing in the class.

RECORDS AND AUDITS

TRANSCRIPT FEES

WPI has recently contracted with Credentials Solutions to manage transcript orders. All transcript requests should now be made online and are \$5.00 per transcript to be paid by credit card using Credential Solutions.

Please visit <https://www.wpi.edu/offices/registrar> for more information.

DEGREE AUDITS

WPI has developed a computerized degree evaluation which lists students' courses as they apply to the respective department distribution requirements. The degree evaluation is available online.

GRADUATION

Each student must file an application for degree with the Registrar's Office in accordance with the following schedule:

To graduate in:

May – prior A-term

September – prior D-term

December – prior D-term

PROJECTS

PROJECT PLANNING

During the academic planning period, which starts in February, students who intend to conduct project work during the following year should set aside time to plan their projects, meet with faculty, and form project teams. The faculty will list IQP project opportunities on the Projects Program web page in February. (Some Project Centers and special programs may have an application process before that.) Each academic department typically will list MQPs on the department's web site and will hold a projects information meeting for students in their major. Students are also encouraged to meet with faculty individually.

The most important and difficult part of a project is the planning which precedes the execution. The planning phase of your project will involve developing a background, talking to people in the field, finding out what has already been done in the area, and determining what your goals are and what you need to do to accomplish them. If any special equipment, financing, or resources will be needed for execution of the project, it is especially important to make this known early to ensure that it will be available to you. In addition, most faculty members require a project proposal before registration of the project.

PROJECT REGISTRATION

Students who intend to do project work must complete a project registration form by no later than the beginning of the first term of that project work. The Project Registration Form is available on-line at the Registrar's Office web site, under Forms for Students. Once completed on-line, it must be submitted electronically to the project advisor for approval. Any student who will travel to an off-campus location, such as a Residential Projects Program site, is also required to fill out an electronic project registration form.

Project registration for terms A-E will be accepted up to the 10th day of the term (not including weekends) without penalty. A project involving an off-campus sponsor (MQP mostly, but some IQP) carries the further obligation of compliance with the rules and regulations of the sponsor. Often, these are specified in a formal contract between the sponsor and WPI, and are legally binding. At the time of registration, any affected student will be required to indicate the sponsor on the electronic registration form.

For an MQP, the project advisor or an associate advisor must be a member of the faculty in the discipline which corresponds to the major area of study of the student.

PAY AND CREDIT (for students working on sponsored projects)

A student may receive pay for work associated with a registered project under the following conditions:

1. The work done for pay is clearly distinguished from the work defined for academic credit for the project. This distinction must be clearly articulated in a conflict of interest statement signed by all participating parties before the project begins.
2. Results obtained from paid or unpaid work performed while students are not registered for project credit at WPI may be used in projects only after consultation with the project advisor. When possible, such consultation should take place before work begins.

CHANGE OF REGISTRATION INFORMATION

For all changes in projects, students must use the electronic Project Registration Form. Students may make changes to the project by making an addendum to the previously registered project and submitting the changes electronically to the project advisor for approval.

CHANGING PROJECT ADVISOR

To change the project advisor for a degree-required project, students should stop by the Registrar's Office.

PROJECT CONFERENCES

Students should report to their project advisor's office at the beginning of the term to make arrangements for subsequent meetings.

OVERLOAD WITH PROJECT

Students may not register for an overload (more than 7/3 units per semester) without the electronic approval of the academic advisor.

PROJECT COMPLETION

During the final term of registration for the project and sufficiently prior to the deadline for submittal of Completion of Degree Requirement Forms, students must submit their completed project report to the project advisors. Students are also required to submit a copy of the document to the participating off-campus organization sufficiently prior to the end of the term so that proprietary and confidential information in the report can be identified and removed. Most off-campus organizations require 30 days for this review, and the grade and final report cannot be submitted to the Registrar by the project advisor until this review has been done.

Directions for submitting the project report electronically are available in the Gordon Library or on-line. A final project report is submitted electronically at wpi.edu/+eprojects (See Electronic Project Submission on page 15.)

A completed electronic Completion-of-Degree-Requirement (eCDR) form, must be printed for signature by each student and signed individually by the advisor as the final step in the submission process. The eCDR form must be submitted in person by the project advisor or a member of the academic department of the advisor to the Office of the Registrar by no later than the tenth day of the next academic term.

A student who has filed an application to receive their degree in May must submit a completed eCDR to the Office of the Registrar by the last Thursday in D-term.

REGISTRATION POLICY FOR DEGREE REQUIREMENTS

The completion of a degree requirement (MQP, IQP or Humanities and Arts Requirement) will not be recorded in the Registrar's Office after the tenth day of classes of a term unless the student is registered for a minimum of 1/6 unit *of the same activity* in that term. The deadline for receipt of the Completion Form is no later than the tenth day of classes for the next term. Any exceptions to this policy must be handled by written petition from the project advisor.

Note: Candidates for degrees must meet graduation deadlines if they differ from the above. Deadlines for degree candidates will be strictly enforced!

Only Completion of Degree Requirement (CDR) forms which are complete, correct and consistent with the student's registration records will be accepted by the Registrar's Office. (See PROJECTS AND RESEARCH section, page 14.)

OFF-CAMPUS INSURANCE AND LEGAL AGREEMENTS

WPI's insurance program includes a broad range of coverage for students doing projects in cooperation with off-campus organizations. This insurance coverage requires proper documentation of individual student participation. All students doing project work with off-campus organizations must complete the pertinent portion of the project registration form. In certain cases, where the project is included as part of a regular course, the course instructor must submit to the Projects Office a list of the students going off campus and the name(s) and address(es) of the organization(s) involved.

WPI has entered into a variety of agreements with off-campus organizations, covering a wide range of issues common to the projects program. Students agree to abide by these agreements during the registration for the project.

INDEPENDENT STUDY

Independent Study provides the opportunity for an individual student or group of students, with the approval and under the direction of one or more faculty advisors, to study and to explore in greater depth an area of particular interest to the student and faculty member. An independent study may be used as a substitute for an existing WPI course, as an opportunity to study a topic not currently offered as a course at WPI, or to conduct directed undergraduate research.

Independent Study registration for terms A-E will be accepted up to the 10th day of the term (not including week-ends) without penalty.

An independent study may be used to assign credit in a particular discipline only when at least one of the faculty advisors has an appointment in the department or program associated with the discipline or with the approval of the appropriate Department Head or Program Director. If disciplinary credit is not assigned to the independent study, the academic credit will be identified as Interdisciplinary (ID) and the credit will be assigned as free elective on the student's transcript.

OFFICIAL WITHDRAWAL OR LEAVE OF ABSENCE

There are many reasons why a student may need or wish to take time away from WPI. There may be personal or medical issues interfering with their academics; opportunities for professional experience; family or community commitments; or the desire to just take a break.

- Institutional Leave of Absence (LOA): Request this if you are planning to return to WPI. Leaves may be granted for the remainder of the current semester (if applicable) and the immediately following semester (not counting summer). Leaves may be renewed for one additional semester, and an extension must be requested before the expiration date of the current leave. If a student does not return by the expiration date, they will be automatically withdrawn. For students with federal funding in their

financial aid awards you will be reported to federal agencies as a federally withdrawn student. This may have impacts on deferment and loan repayment start times. Please contact the Office of Student Aid & Financial Literacy for further details.

- Official Withdrawal: Request this if you are leaving permanently and not planning to return to WPI.

Any reduction in charges is based on the student's certified last date of attendance. See page 246 for information concerning tuition charges.

Students who have attended through the 12th week of a semester (or the 5th week of B or D terms) may not withdraw or take an LOA for that semester and will be academically reviewed. They may withdraw or take an LOA for the following semester.

See Return from Leave of Absence section for information about returning to WPI after a leave. Students who officially withdraw are expected to apply through Undergraduate Admission if they decide they would like to return at a later date to pursue undergraduate study.

See full list below for more information and other types of withdrawals or leaves.

Restrictions to WPI access:

- You will be dropped from any classes and/or projects you have scheduled for future terms.
- You will not be able to live in university housing, and if applicable, will not be able to select or keep your future academic year assignment.
- You may not be able to retain your spot for an IQP/MQP Project Center.
- If you have financial aid, your financial aid will be readjusted.
- You will not be able to participate in campus activities, including clubs, sports, etc.
- Students on Institutional Leave of Absence will retain use of their WPI email. All other access will be removed.
- Students on Official Withdrawal will NOT retain use of their WPI email. All other access will also be removed.

Procedure:

1. Students should inform themselves about the consequences to the following if applicable
 - Financial Aid
 - Visa Status
 - Housing
 - Billing, including potential tuition adjustments
 - Health insurance: If insured by student health insurance please check for coverage options.
 - Undergraduate students schedule an appointment with Academic Advising

And any other considerations.

2. Complete the appropriate form available at <https://www.wpi.edu/offices/registrar>
 - Undergraduate Institutional Leave of Absence Form
 - Undergraduate Official Withdrawal Form

3. If seeking a medical leave of absence, please make an appointment with the appropriate office below
 - If seeking a medical leave of absence for psychological reasons, schedule an appointment with the Student Development and Counseling Center (SDCC).
 - If seeking a medical leave of absence for all other medical reasons, schedule an appointment with WPI's Office of Health Services.
4. Submit completed form to Registrar's Office

RETURN FROM LEAVE OF ABSENCE

Students who have been away from WPI for a voluntary institutional leave of absence or medical leave of absence may request to return from leave of absence. The return from leave of absence process has been designed to make sure that students are ready to return successfully to WPI. **Students must submit a request to return before the leave of absence expires. If the leave expires you will be automatically withdrawn.**

All students requesting to return to WPI must complete the Request to Return from Leave of Absence Form and submit it to the Registrar's Office by the applicable deadlines. Please note that students returning from a medical LOA must be cleared by the appropriate office. Forms and information are available at <https://www.wpi.edu/offices/registrar>.

Deadlines: Fall Semester: July 20th
 Spring Semester: December 1st
 Summer Session: May 1st

PART-TIME DEGREE STUDENTS

Students may apply for Part-Time Student status on a **semester** basis at the Registrar's Office. Part-time students pay tuition on the basis of registered credit at the start of each semester, including credits for ROTC and PE. Campus housing will not be allowed. Part-time students may not engage in varsity/club sports, may not participate in any extracurricular activities, and are only eligible to apply for limited federal and state financial aid (institutional financial aid is not available) including any form of on-campus student employment. The following registration procedures apply:

- Students who wish to enroll as part-time students must apply by July 20 for the Fall semester and by November 15 for the Spring semester. Such status will allow a maximum of one unit per each semester of the academic year.
- Changing between full-time/part-time status is not allowed at mid-semester.
- Part-time students wishing to return as full-time students must be readmitted according to the procedures specified under Readmission in the Admissions section of this catalog, page 242.

For the Guidelines for Determination of Satisfactory Progress for Part-time Students, see page 214.

NON-DEGREE STUDENTS

Students wishing to take courses on a full-time or part-time basis as a non-degree student may do so by contacting the Registrar's Office. Non-degree students are permitted to earn a maximum of 18 credits (6/3rds) in a non-degree status. Non-degree students will be tracked through the Registrar's Office. Non-degree students pay tuition on the basis of registered credit at the start of each semester. Campus housing will not be allowed. Non-degree students may not engage in varsity/club sports, may not participate in any extracurricular activities, may be required to register for courses on a space-available basis, and *are not eligible for financial aid or any form of on-campus student employment.*

PROJECT REGISTRATION TOPIC CODES

MQP MAJORS AND COORDINATORS

	Majors	Coordinators
AE	Aerospace Engineering	N. Gatsonis
BIO	Biology and Biotechnology	J. Rulfs
BBC	Biology and Biotechnology with Concentration	J. Rulfs
BC	Biochemistry	D. Heilman
BU	Business	A. Hall-Phillips
BME	Biomedical Engineering	G. Pins
CE	Civil Engineering	T. El-Korchi
CH	Chemistry	D. Heilman
CHE	Chemical Engineering	W. Clark
CS	Computer Science	C. Wills
ECS	Economics/Science	O. Pavlov
ECE	Electrical and Computer Engineering	J. McNeill
EVS	Environmental and Sustainability Studies	L. Elgert
EV	Environmental Engineering	J. Bergendahl
HU	Humanities	D. Spanegel
ID	Interdisciplinary	R. Vaz
IE	Industrial Engineering	S. Johnson
IMG	Interactive Media & Game Development	J. deWinter
INGS	International and Global Studies	P. Hansen
MA	Mathematical Sciences	J. Petrucelli
MAC	Actuarial Mathematics	J. Abraham
ME	Mechanical Engineering	B. Savilonis
MFE	Manufacturing Engineering	K. Rong
MGE	Management Engineering	A. Hall-Phillips
MIS	Management Information Systems	E. Loiacono
PH	Physics	D. T. Petkie
PHE	Applied Physics	D. T. Petkie
RBE	Robotics Engineering	C. Pinciroli
STP	Society, Technology & Policy	P. Stapleton
PW	Professional Writing	E. Boucher
PSS	Psychological Science	J. Skorinko

HUMANITIES AND ARTS ADVISORS

Topics	Project Advisor	Topics	Project Advisor
Topics in American Studies	J. Aguilar, K. Boudreau, S. Bullock, C. Clark, J. Cocola, J. Cullon, L. Davis, H. Droessler, B. Eddy, J. Hanlan, L. Schachterle, D. Spanagel	Topics in Literature (Contemporary)	J. Aguilar, K. Boudreau, J. Cocola, M. Ephraim, K. McIntyre, K. Moncrief, S. Nikitina, L. Schachterle
Topics in Asian Studies	J. deWinter, W. Du, J. Rudolph, H. Zheng	Topics in Literature (Global)	J. Aguilar, K. Boudreau, J. Brattin, J. Cocola, D. DiMassa, M. Ephraim, A. Madan, K. Moncrief, S. Nikitina, A. Rivera
Topics in Art	R. Bigonah, F. Chery, A. Gonzalez, E. Gutierrez, M. Keller, J. Rosenstock, M.D. Samson,	Topics in Medical Humanities	B. Eddy, B. Faber, S. Lessing, L. Higgins
Topics in Drama/Theatre	K. Moncrief, D. Giapoudzi	Topics in Middle East and African Studies.	M. Brahimi, M. El Hamzaoui, R. Moody, Y. Telliel
Topics in Environmental Studies	C. Clark, J. Cocola, J. Cullon, R. Gottlieb, J. Sanbonmatsu, W. San Martin, D. Spanagel	Topics in Modern Languages (Arabic)	M. Brahimi, M. El Hamzaoui
Topics in European Studies	U. Brisson, D. DiMassa, P. Hansen, J. McWeeny, S. Nikitina	Topics in Modern Languages (Chinese)	W. Du, H. Zheng
Topics in Gender Studies	L. Davis, M. Ephraim, J. McWeeny, R. Moody	Topics in Modern Languages (German)	U. Brisson, D. DiMassa
Topics in Global Studies	D. DiMassa, H. Droessler, J. Galante, P. Hansen, S. Lessing, A. Madan, R. Moody, G. Pfeifer, A. Rivera, J. Rudolph, W. San Martin, Y. Telliel	Topics in Modern Languages (Other)	A. Rivera
Topics in History (American)	S. Bullock, J. Cullon, L. Davis, H. Droessler, J. Hanlan	Topics in Modern Languages (Spanish)	A. Madan, A. Rivera
Topics in History (Global)	H. Droessler, J. Galante, P. Hansen, J. Rudolph, W. San Martin	Topics in Music	S. Barton, F. Bianchi, V.J. Manzo, J. Rohde, D. Weeks
Topics in History (Science and Technology)	C. Clark, J. Cullon, W. San Martin, D. Spanagel	Topics in Philosophy	R. Gottlieb, J. McWeeney, G. Pfeifer, J. Sanbonmatsu
Topics in Intercultural and Global Competency - Humanities (Interrelated)	E. Boucher, U. Brisson, A. Danielski, J. deWinter, D. DiMassa, H. Droessler, W. Du, M. El Hamzaoui, J. Galante, P. Hansen, S. Lessing, A. Madan, J. McWeeney, R. Moody, S. Nikitina, G. Pfeifer, A. Rivera, J. Rudolph, W. San Martin, Y. Telliel, H. Zheng	Topics in Religion	B. Eddy, R. Moody, Y. Telliel
Topics in Latin American Studies	J. Galante, A. Madan, A. Rivera, W. San Martin	Topics in Urban Studies	J. Cullon, B. Eddy, J. Hanlan, D. Spanagel
Topics in Literature (American)	J. Aguilar, K. Boudreau, J. Cocola, J. Harmon, K. McIntyre, S. Nikitina, L. Schachterle	Topics in Writing (Creative)	J. Aguilar, J. Cocola, M. Ephraim, J. Harmon, K. McIntyre
		Topics in Writing (Professional)	E. Boucher, J. deWinter, B. Faber, J. Harmon, L. Higgins, S. Lessing, K. Lewis, R. Madan, S. Nikitina, Y. Telliel
		International Students	E. Boucher, A. Danielski, M. El Hamzaoui
		IMGD	F. Chery, J. deWinter, A. Gonzalez, E. Gutierrez D. O'Donnell, J. Rosenstock

RESOURCES AND SPECIAL PROGRAMS

SECTION 5

Resources and Special Programs	222
The Gateway Park	222
Special Programs for First Year Students	222
Graduate Courses	222
Combined Bachelor/Master's Program	222
Information Technology Services	223
Music and Theatre Facilities	224
George C. Gordon Library	225
Student Services	226
Student Exchanges	227
Language Requirements	227
HECCMA Course Cross-Registration	228
Cooperative Education	228
Summer Session (Term E)	230
Awards and Prizes	231
Societies, Registration and Licensing	234

THE GATEWAY PARK

In 2010, WPI added Gateway Park — a growing center of research, innovation, and commerce — to the campus footprint. It began as a joint venture with the Worcester Business Development Corporation to transform a blighted and underutilized area into a clean, thriving, mixed-use facility for a range of academic, research, and commercial enterprises.

Today Gateway Park includes facilities located at [50 Prescott Street \(Gateway II\)](#), [60 Prescott Street \(Gateway I\)](#), and [85 Prescott Street](#) that house a number of academic and research programs, such as [Robotics Engineering](#), the [Biomanufacturing Education and Training Center \(BETC\)](#), an expanded state-of-the-art [Fire Protection Engineering research and burn laboratory](#), the [Foisie Business School](#), and the [Life Sciences and Bioengineering Center](#). Gateway Park is also home to a number of WPI administrative offices and two commercial enterprises.

SPECIAL PROGRAMS FOR FIRST YEAR STUDENTS

INSIGHT PROGRAM

In WPI's Insight Program, groups of 25-30 first year students are advised by a faculty mentor who makes a real commitment to these students during the first two terms. Each faculty advisor works with two upper class students, a Community Advisor and a Resident Advisor. Together they plan and run a number of activities for the first year students, frequently on the residence hall floor. Examples of these activities include workshops on time management, study skills, or test-taking strategies, as well as social events such as laser tag, pizza parties and apple picking. The Insight program purposefully blends the academic and social aspects of life at WPI, helping students form a strong support network.

GREAT PROBLEMS SEMINARS

This is a two course sequence designed to serve as an introduction to project work and university level research with a focus on themes of global importance. Each seminar has at its core an important problem. Students explore the complexity of our global issues, and demonstrate their ability to solve some aspect of the big problem. The skills the students develop are exactly what they need to be successful both in project work at WPI and in their future careers.

Examples: In Food Sustainability, students and faculty focus on issues surrounding food: nutrition, production, economics, and policy issues. Student projects have included plans for urban gardens, extending Meals on Wheels to younger but non-mobile seniors and nutritional information in the dining hall.

In the Power the World, the production, distribution and use of all forms of energy and associated ethical issues are reviewed. Student projects have included stove design for indigenous people, improvements on solar powered emergency medical devices and energy audits of campus buildings.

Themes will change from year to year. Enrollment is limited.

DISCOVERING MAJORS AND CAREERS

Discovering Majors and Careers is a class for first year students undecided about academic majors. This 1/12 unit course can be taken on top of a regular course load. Students enrolled in this course will utilize a variety of tools including self-assessments, panels, campus resources, and informational interviews with alumni to help identify personal interests, WPI majors, related careers, and life goals. The program has a terrific track record in choosing majors that align with interests and skills.

ADDITIONAL RESOURCES ON THE WEB

The Undergraduate Programs Web Site
(www.wpi.edu/Academics/Undergraduate/)

The Academic Advising Office (www.wpi.edu/+OAA)

The First Year Web Site (www.wpi.edu/+FYE)

GRADUATE COURSES

WPI students may enroll in graduate courses as part of their regular undergraduate studies without being admitted to the graduate program. An exception: In order to enroll in graduate courses offered by the Robert A. Foisie School of Business, the student must have been admitted to a dual BS/MS program, regardless of department. Graduate courses applied toward the undergraduate degree are awarded undergraduate units with a conversion rate of 1 graduate credit = 1/6 undergraduate unit.

COMBINED BACHELOR/MASTER'S PROGRAM

INTRODUCTION

WPI undergraduates can begin work on a graduate degree by enrolling in a combined Bachelor's/Master's program. This accelerated course of study allows students to obtain an MS degree after only five years of full-time work (i.e., typically one year after completion of the BS). Students often obtain the BS and MS in the same field or department, but with careful planning some students complete the combined BS/MS program in two different fields; the combination of a BS in Civil Engineering and an MS in Fire Protection Engineering is a common example. (Throughout this section, "MS" will be used to refer to all Master's-level degrees; most students who complete the combined program obtain the MS).

PLANNING YOUR PROGRAM

Because BS/MS students use some approved courses to satisfy the requirements of both degrees simultaneously, it is crucial for them to plan their curriculum early in their undergraduate career.

The specific course and MQP requirements for a BS/MS program are determined individually, so students should consult with their own advisor as well as the graduate coordinator in the department in which they plan to pursue their MS degree early in their Junior year. This consultation, or series of consultations, should produce a slate of approved undergraduate courses that will be used for graduate credit. Sometimes the instructors of

these courses will ask BS/MS students to complete additional work, or will otherwise hold them to higher standards of achievement.

A student's advisor and graduate coordinator will also determine what role the MQP will play in the BS/MS program. Sometimes the MQP provides a foundation for a thesis. In cases where the BS and MS are not awarded in the same field, the MQP usually relates to the graduate program's discipline.

Once the specific course and MQP requirements have been established, students complete a Course Selection Form which is submitted to the relevant department(s) for approval. This written agreement constitutes the set of conditions that must be met for a student to complete the BS/MS program. They are a plan for completing the requirements for both degrees and they will not supersede or otherwise obviate departmental and university-wide requirements for either degree. The completed, signed form must be submitted to the Registrar before the student may matriculate in the combined program.

HOW TO APPLY

Students almost always apply for admission to the BS/MS program in their Junior year, typically after they have established their curriculum and other program requirements and completed the Course Selection Form with their faculty advisors. Applications are submitted to the Office of Graduate Admissions and are processed with all other graduate applications. Once a decision has been reached, the Office of Graduate Admissions will notify the student, usually within six weeks of completing the application.

PROGRAM REQUIREMENTS

Only registered WPI undergraduates may apply for admission to the combined BS/MS programs. Students are considered undergraduates, no matter what courses they have completed, until they have met all of the requirements for the Bachelor's degree. In order to receive the BS and the MS, all of the requirements for both degrees must be completed.

In most departments a student may take up to four years to complete the Master's portion of the BS/MS program. There are exceptions, however, so students are advised to discuss their timetable with the appropriate advisor or graduate coordinator. Students who stop registering for classes for an extended length of time may be asked to petition the Committee for Graduate Studies and Research to continue their program.

CREDIT EQUIVALENCE AND DISTRIBUTION

No more than 40% of the credit hours required for the Master's degree, and which otherwise meet the requirements for each degree, may be used to satisfy the requirements for both degrees. In some departments, students may not double-count more than 30% of their graduate credits. Consult the graduate catalog for the requirements of your program.

Double-counted courses are recorded on the transcript using the credit hours/units and grades appropriate at the graduate or undergraduate levels. For students in the combined BS/MS program, approved undergraduate courses are assigned graduate credit with a conversion rate of 1/3 WPI undergraduate unit = 2 graduate credit hours, while graduate courses applied toward the undergraduate degree are awarded undergraduate units with a conversion rate of 1 graduate credit hour = 1/6 undergraduate unit.

INFORMATION TECHNOLOGY SERVICES

WPI Information Technology Services offers a wide range of information technology resources to the WPI community to support teaching, learning, research and student life.

ACCESS

The WPI computer account acts as an undergraduate student's WPI virtual identity while the student is actively registered. Usage is governed by the Acceptable Use Policy. The account provides access to many technology resources including:

Network:

- Wired and wireless network available in all academic buildings, residence halls, and participating Greek houses
- High speed Internet connectivity including connection to Internet2
- Virtual Private Network (VPN) provides secure remote access to WPI on-campus information technology resources
- Information Security monitors the WPI network and provides data malware protection

University Systems:

- University services, such as email, learning management system, eProjects, web site, software applications, remote desktop, databases, etc. are enabled by System Operations and Web Development teams.
- Enterprise-wide technology solutions such as Banner, Workday, and their related data systems, enable administrative departments to run the critical business functions of the University. They provide students and faculty access to student registration, advising, and financial information. They also enable students to update their biographical information, set proxy, and check grades online.

Software

Students can access numerous software applications including academic courseware:

- in public computer labs
- via remote services
- via network download for some applications
- discounted purchase via online store

COMPUTER LABS

Over 700 public computers are available across campus for student use. Many are located in open access labs within academic buildings and throughout the Gordon Library. Public computer labs offer a consistent user interface and software profile. Speciality labs for students include:

- Multimedia Lab enabling high-end digital editing is available in the Gordon Library
- Maker space, prototyping and recording labs are housed in the Foisie Innovation Studio
- Design Studio offers powerful workstations for CAD/FEA/FEM projects and coursework in Higgins Labs

PRINTING SERVICES

The Gordon Library Information Commons Print Center is available to meet students' scanning and printing needs. Printers are also located throughout the Gordon Library as well as within some computer labs. For additional printing services listed below see Technology Support and Instruction:

- Large-format poster printing
- Rapid prototyping/3D printing

COLLABORATION AND LEARNING RESOURCES

Collaboration and learning are supported through specialized software and applications, technology-enhanced spaces, and equipment loans.

- Learning Management Software: Canvas course web sites
- Tools: Office 365 (email/calendar/contact, task, document management), DigiCation portfolio, FusionForge, Skype for Business
- Web-conferencing: Zoom allows remote participants to conduct meetings in real-time in a web-based environment from any location with a web-enabled device and a high speed Internet connection
- Tech Suites: Technology-enhanced meeting spaces with wireless screensharing designed for student project group use
- Learning Spaces: Active learning classrooms, electronic classrooms, and electronically enabled conference rooms
- Equipment Loans: Laptops, digital cameras, audio recorders, hard drives, projectors, etc.

TECHNOLOGY SUPPORT AND INSTRUCTION*Technology Service Desk*

Gordon Library, Main Floor; (508) 831-5888; its@wpi.edu; <https://its.wpi.edu>

- In-person technology support provided at the Service Desk
- Requests for assistance can be submitted via phone, email or web
- IT Service, Software, and Knowledge Catalog provides answers to common issues

Academic Technology Center

Fuller Labs, Room 117; (508) 831-5220; atc@wpi.edu

- In-person technology support on audio-visual equipment loaned out for multi-media projects and campus events sponsored by WPI student organizations
- Large-format poster printing

Academic and Research Computing

Higgins Labs, <https://www.wpi.edu/research/resources/support/academic-research-computing>

- Instructor-led scientific and engineering software applications training
- Data management and access to cloud collaboration space
- Numerous high performance computational resources available for student research projects
- Large-format poster printing located in Higgins Labs
- Enterprise level rapid prototyping/3D printing located in Higgins Labs

MUSIC AND THEATRE FACILITIES**COMPUTER MUSIC LABORATORIES***Alden Memorial and Sanford Riley Hall*

These laboratories support creative and research activity in a variety of music- and sound-related applications including real-time virtual orchestra design and production techniques. The lab contains hardware and software for multi-track digital recording and editing, signal processing, algorithmic composition, sound synthesis, MIDI sequencing, music notation, and music programming. The computer music classroom is located in the basement of Alden Hall.

FIRST BAPTIST CHURCH

The Choral Department is housed in the First Baptist Church, located on the north corner of WPI's campus. Each of the four choirs (Glee Club, Alden Voices, Festival Chorus, and Chamber Choir) hold their weekly rehearsals at the church, along with many a cappella groups. The ensembles regularly rehearse in the spacious and versatile Gordon Hall, while giving three performances a year in the resonant sanctuary. The office for the Director of Choral Activities and choral library are also located within the church.

GREAT HALL OF ALDEN*Alden Memorial: First Floor*

The Great Hall is used for major productions in Music and Theatre. It is the venue for the VOX Musical Theatre performances as well as choral and instrumental performances. In addition, the Hall is sometimes used for festive and gala campus functions.

ALDEN HALL THEATRE SPACES*Alden Memorial: First Floor*

Alden Hall houses many of the performance activities at WPI, both academic and extra-curricular. The Green Room serves as a space for rehearsals, meetings and other academic projects of the theatre community. The sub-basement of Alden Hall houses a scenic design studio and a Props & Costumes closet. These areas are maintained and shared by the Department of Humanities and Arts Drama/Theatre division and Masque, the WPI undergraduate student theatre club..

JAZZ HISTORY DATABASE LAB

The Jazz History Database lab, located in the basement of Alden Hall, is an interactive multimedia museum focused on artists deserving of wider recognition and dedicated to the preservation of "at-risk" jazz artifacts. The rare and unique materials on this website have been contributed by individuals, academics, institutions and media from the U.S. and Internationally. The Jazz History Database is hosted by Worcester Polytechnic Institute (WPI) under the direction of Professor Richard Falco, Director of Jazz Studies. Academic credit is awarded to students working in teams to preserve materials for archiving and inclusion in the database.

THE LITTLE THEATRE*Sanford-Riley, Lower Level*

Made possible with a major gift from the George I. Alden Trust, the Little Theatre is the University's first dedicated academic theatre facility. With a combination of flexible and fixed seating, this 99-111 seat facility has a permanent lighting grid and sound system, a high-tech control booth, a greenroom/dressing room, and handicapped accessibility. The Little Theatre is well suited for a wide range of theatrical performances and is the laboratory for the Drama/Theatre division of the Department of Humanities and Arts. Audiences appreciate the intimate relationship they have with the production and the Little Theatre often sells out each show. Undergraduates who work in the Little Theatre may earn academic credit in theatre classes and projects; other students take part in activities in the Little Theatre as part of Masque or Alpha Psi Omega; and many others participate simply for the enjoyment of taking part in a live play onstage. For more information, see <http://users.wpi.edu/~theatre>.

MUSIC, PERCEPTION AND ROBOTICS LAB*Alden Memorial: B21*

The Music, Perception and Robotics Lab explores how creative expression can be inspired by and enhanced through technological tools and understanding of human auditory perception. The lab designs, builds, composes for and performs with musical robots. It conducts psychological research that examines human musical perception and creativity. It synthesizes these efforts by developing software that allows human musicians to interact with robotic ones.

SPAULDING RECITAL HALL AND OTHER ROOMS FOR REHEARSAL AND PERFORMANCE*Alden Memorial: Lower Level*

Alden Center for the Performing Arts houses the Spaulding Recital Hall, Perreault Chamber Rehearsal Room, the Janet Earle Choral Rehearsal Room, three practice rooms, and the Knight Lecture Room. Available for practice are Steinway grand pianos and the Three Manual Aeolian-Skinner pipe organ in the main Concert Hall. There are three concert grand pianos for recitals, ensemble work and concerts. WPI has some instruments that can be made available to students upon request.

OTHER MUSIC FACILITIES

Music facilities also include The Janet Earle Room, The Perreault Chamber Rehearsal Room, the music classroom, practice rooms, computer music labs and storage facilities.

DRAMA/THEATRE RESOURCE LIBRARY

The Department of Humanities and Arts Drama/Theatre Resource Library, housed in Salisbury Labs Room 18 and available as posted, contains publications, magazines, published scripts, and other information to assist students working on projects (MQP, IQP, practica, ISU) in Drama/Theatre. Scripts for current productions can usually be found nearby the Resource Library on the table in the center of the main Humanities and Arts area. Most resource items and display scripts must be used in the immediate area, and this service is not per se a lending library.

GEORGE C. GORDON LIBRARY

The George C. Gordon Library welcomes more than 400,000 visitors each year, and provides resources and innovative services that support teaching, learning, scholarship, and community at WPI. Gordon Library Information Services, the ITS Service Desk, and the Technology for Teaching and Learning (TTL) group of the Academic Technology Center (ATC) are conveniently co-located near the library's main entrance on the second floor. The adjacent Class of 1970 Library Café serves food and beverages. Students may access the library from 8am to 1am Monday-Thursday, with special weekend hours and extended hours to 3am during finals.

The library's four floors contain a wide variety of individual and group study spaces. Tech Suites are private collaborative work rooms equipped with large monitors and wireless screen-sharing technology, and can be reserved for student use. Additional group study spaces are located throughout the building. Among them is Studio@Gordon, an active and informal collaboration space on the ground floor.

The library offers both wireless and wired computer network access throughout the library's open study areas, with over 125 computers that offer free access to dozens of high quality software packages. The Multimedia Lab on the first floor offers specialized multimedia software and hardware, and a public KIC Click Mini book scanner for quick and easy scanning of books and other materials. The adjacent Shuster Lab for Digital Scholarship offers 6 high-end workstations equipped with digital scholarship and multimedia software and Huion 20" graphics tablet monitors; large monitors for wireless screen sharing and presentations; two high-end scanners; and a docucam. It is available for student use whenever not scheduled by faculty or staff for special class use or events.

The staff of Gordon Library offers many services to support student learning. Research and instruction librarians help students with research problems and questions, offer library instruction and orientation sessions, and provide research consultations to individuals and project groups.

The library's information resources support the curriculum and research needs of the WPI community. The library offers an extensive collection of print and electronic books and journals, as well as more than 250 research databases, all selected to support WPI courses, projects, and scholarship. The library also provides access to books by WPI faculty authors, recreational reading, music, videos, and video games.

The library catalog, electronic journal and book collections, specialized research databases, course-specific information, and many other resources are available from the library's web site (wpi.edu/library) which features powerful search options and links to research guides, journals, articles, databases, and other digital resources and services. Access to WPI users who are off-campus is available through an institutional login.

Through the Digital WPI platform (digital.wpi.edu), the library collects and offers global digital access to WPI student work including GPS posters, IQP and MQP reports, graduate theses and dissertations, as well as selected WPI faculty research.

All students can request materials not held in Gordon Library through a free interlibrary loan service. WPI students also have access to the collections of other academic libraries within Central Massachusetts through the library's membership

in the Academic and Research Collaborative (ARC). Students can obtain an ARC cross-borrowing card which allows direct borrowing at many regional academic libraries.

The Archives and Special Collections, located on the ground floor, serves as the institutional memory of WPI and curates the university's collection of manuscripts, rare books, photographs, art, and objects. Its staff works with the campus community to access historical resources related to WPI, Industrial Revolutions, and regional history. Highlights from the collection include university history, the Morgan Construction Company records, and a world-class collection of material related to the life, world, and works of Charles Dickens. These items can be explored through ArchivesSpace (archives.wpi.edu), and are available to researchers by visiting the Fellman Dickens Reading Room, with select digitized and digital-born material hosted at Digital WPI (digital.wpi.edu).

Special exhibits are offered in the library's galleries. WPI authors are regularly invited to talk about their work in the library's Meet the Author series, and other programming occurs regularly to serve the WPI community.

For more information, please visit the library website at wpi.edu/library.

STUDENT SERVICES

STUDENT DEVELOPMENT AND COUNSELING CENTER

The Student Development & Counseling Center (SDCC) is dedicated to promoting the safety, emotional health, and personal growth of all WPI students, as well as to cultivating a supportive campus.

The SDCC offers free, confidential mental health counseling and consultation services for individuals, couples, and groups, as well as crisis intervention and referrals to local specialists as necessary. Without exception, each student will be treated with compassion and respect, and counselors will work with them to set goals, identify obstacles, and move in a valued direction.

Additionally, the SDCC hosts trainings, workshops, and presentations that are designed to foster personal growth and skills for success.

Students interested in learning more about the SDCC and its services are encouraged to email us at sdcc@wpi.edu, call us at 508-831-5540, or visit us during our operating hours. The main office is located at #16 Einhorn Road. We are open Monday-Thursday from 8:00 am-7:00 pm and Friday from 8:00 am-5:00 pm, with walk-in hours from 2:00 pm-3:00 pm each day while students are in session. Our summer hours are 8:00 am-4:30 pm.

ACADEMIC RESOURCES CENTER

WPI's Academic Resources Center (ARC), located in Daniels Hall, provides academic support services that are designed to enrich and enhance the learning experience of all WPI undergraduate students. Its student-based collaborative learning environment offers individualized assistance in a variety of subjects, as well as a comprehensive peer tutoring program.

The ARC offers individual and group tutoring (MASH) sessions. All peer tutors and MASH Leaders are certified by the

College Reading and Learning Association, and help students in a variety of academic subjects. Peer tutors are available by appointment, whereas MASH sessions are drop-in. To schedule an appointment with a peer tutor visit tutortrac.wpi.edu. To view the MASH schedule visit: www.wpi.edu/+OAA.

MASH (MATH AND SCIENCE HELP) PROGRAM

MASH is an academic support program for students in mathematics, science, and computer science courses. Offered to all students enrolled in a supported course, MASH provides assistance in regularly scheduled study sessions beginning the first week of the term.

Each group tutoring session is guided by a MASH leader, an undergraduate student who has taken the course before and who, therefore, understands the course material and what the instructor expects. MASH leaders attend lectures, and conduct three 50-minute MASH sessions each week. By attending class and demonstrating effective student behavior, MASH leaders can assist students with the language of the discipline, the integration of lecture and readings, and the development of good study habits.

Through the MASH program, students become actively involved with the content material in a supportive environment. MASH participants master new concepts, learn to put ideas into perspective, and develop a better way to study.

OFFICE OF DISABILITY SERVICES

The Office of Disability Services (ODS) coordinates accommodations and provides support for WPI students with documented disabilities to equally participate in programs and campus life. The office strives to foster an environment that supports and encourages self-advocacy, independence, and personal growth. Accommodations can be provided to students with disabilities that are permanent in nature as well as temporary injuries for short-term accommodation support. More information on how to disclose a disability, supports available through the Office, or general questions can be found on our webpage at: www.wpi.edu/+disabilities.

Our services are confidential and available to any student enrolled in a WPI course, though disclosure to the Office is voluntary. Students seeking accommodations or services are responsible for identifying themselves to the ODS as well as providing documentation of their disability by a licensed professional.

ODS is located in Daniels Hall, Room 124. We are open Monday-Friday 8am to 5pm with walk-in hours available A-D terms from 2 to 3pm. Please call the office at 508-831-4908, or email disabilityservices@wpi.edu, or stop into Daniels 124 to schedule an appointment.

THE WRITING CENTER

The WRITING CENTER, located on the second floor of Salisbury Labs (SL 233), employs ~20 peer writing tutors trained to help undergraduate and graduate students with any type of communication project: course papers and project reports, application documents, dissertations, oral presentations and slides, website and document design, and more. Through one-on-one appointments, tutors talk through project goals,

help writers brainstorm and organize ideas, provide a critical reader's feedback, and provide mini-reviews of grammar and punctuation rules. To make an appointment, visit our website at www.wpi.edu/+writing. Faculty interested in designated tutoring for courses should contact Writing Center Director, Ryan Madan, at x6561 or ryanmadan@wpi.edu

WRITING COURSES AND ADVISORS

For information on WPI's writing programs, see Humanities and Arts faculty as follows:

Students interested in the Professional Writing major or the Writing and Rhetoric minor should contact Esther Boucher-Yip (SL 109) about these programs.

The HUA advisors for undergraduate international students whose native language is not English are Esther Boucher-Yip and Althea Danielski (SL 105).

STUDENT EXCHANGES

As technology and commerce become increasingly international in outlook, students in engineering, science and business must learn about countries and cultures other than their own. To respond to this need, WPI offers its students an extensive range of opportunities to broaden their academic and cultural perspectives through participation in the Global Projects Program. WPI also offers traditional exchange programs.

The principal academic emphasis in all exchanges is upon course work. In such programs, students must work closely with their advisor, the academic advisor of the exchange program, and the program coordinator at the site to design an individual program of study. Students have the responsibility of obtaining prior tentative approval from their department that courses taken abroad will count towards departmental distribution requirements. For final transfer credit evaluation, students must provide upon return the necessary detailed information on the content of courses taken abroad and the satisfactory completion of all work. In some exchanges, opportunities exist to complete project work (IQP, MQP, and Humanities and Arts requirement). The exchanges offer exceptional possibilities for projects comparing American and overseas applications of technology and the impact of technology on society. For WPI students on these exchanges, time is usually available for additional travel, before or after the formal academic period.

For more information on these programs, consult with Leanne Johnson in the Interdisciplinary and Global Studies Division or the academic advisor listed for each program.

LANGUAGE REQUIREMENTS

The usual language of instruction at most of the exchange institutions is the official language of the host country. While these institutions may offer a few courses taught in English, most lectures will be given in a foreign language. Thus, exchange students who intend to complete substantial course work must acquire the necessary language background. In some cases intensive language instruction can be arranged on site. In other cases, students acquire the language background through courses taught at WPI or other colleges, or by self-study. A few exceptions exist at some technical universities where the official language of instruction may be English.

UNIVERSITY OF APPLIED SCIENCES; KONSTANZ, GERMANY; EXCHANGE

Students who already know German or are planning to begin studying it have the opportunity to study in Germany for a semester at the Hochschule für Technik, Wirtschaft und Gestaltung (HTWG: university of applied sciences; <http://www.htwg-konstanz.de/>) in Konstanz, Germany. The city of Konstanz, located at the western end of Lake Constance (in German, der Bodensee) and right on the border with Switzerland, is one of Germany's most beautiful cities, with a well-preserved medieval and renaissance city center. The snow-covered Alps are visible across the lake and the HTWG campus is on the bank of the Rhine where it flows out of the lake and heads north. The city is pedestrian friendly, has great food, and there are unlimited opportunities for biking, boating, swimming, skiing, and hiking in the immediate vicinity. Weekend travel to Austria, Italy, and France is easy and Switzerland is literally right across the street. Students who begin their study of German in Terms A, B, C can complete the Humanities and Arts requirement by attending the HTWG in Terms D and E. WPI will not charge these students extra tuition for Term E. Students whose German is already at an intermediate or advanced level may take either advanced language courses or technical courses at the HTWG. Admission to this exchange program is competitive.

NEOMA BUSINESS SCHOOL, REIMS & ROUEN, FRANCE; EXCHANGE

Perfect opportunity for any Foisie Business School major or minor to spend a fall or spring semester in France, immersing yourself in French culture while studying at NEOMA Business School. NEOMA is one of the top ten business schools in France and ranked as one of the best business schools in Europe by the Financial Times. Courses at NEOMA are taught in English and French.

Students may study in either Reims or Rouen, France. Reims, a historic city in the Champagne Region, has a rich legacy, offering a prestigious home to one of the most celebrated and festive of wines – champagne! Thanks to the high-speed train (TGV), Reims is only 45 minutes from Paris and 30 minutes from Roissy-Charles de Gaulle airport. Rouen is located on the River Seine with a beautiful medieval city center. Rouen was fashioned by history, and has seen the likes of Joan of Arc, William the Conqueror and Claude Monet walk its streets. Dynamic festivals and events bring present day Rouen to life. The campus in Rouen offers students beautiful surroundings in seven hectares of woodland and is equipped with state-of-the-art equipment. It is located less than two hours from Paris and the coast of Normandy.

Students participating in this exchange program pay regular WPI tuition, but pay semester room and board to NEOMA. FBS staff will help students map out a curriculum at NEOMA, ensuring all NEOMA credits will transfer back into WPI. Admission to this exchange program is competitive.

HECCMA COURSE CROSS-REGISTRATION

The Higher Education Consortium of Central Massachusetts (HECCMA) consists of the following institutions: Anna Maria College, Assumption College, Becker College, Clark University, College of the Holy Cross, Cummings School of Veterinary Medicine at Tufts University, Massachusetts College of Pharmacy and Health Sciences, Quinsigamond Community College, University of Massachusetts Medical School, WPI and Worcester State University. Full-time WPI students who cross-register for courses at other HECCMA colleges pay no extra fees. Students are limited to one course per semester. The no-charge plan does not include evening colleges or summer school. For cross registration information visit www.heccma.org.

Students interested in registering for HECCMA courses should discuss their program with their advisors, and then obtain regulations and registration forms from the Registrar's Office.

COOPERATIVE EDUCATION

CO-OP

The WPI Cooperative Education Program (known as Co-op) provides an opportunity for students to alternate time in the classroom with extended periods of paid, full-time, career-related work experience in industry or government agencies. The program, which is optional at WPI, entails work assignments during the summer or during the academic year. The following are the options of duration for undergraduate students:

1. Summer and A term
2. Summer, A term and B term
3. C term, D term and Summer
4. D term and Summer
5. Summer, A term, B term, C term and D term
6. A term, B term, C term, D term and summer

Most students elect to participate in one Co-op assignment, though students may choose to complete up to two. Students who participate in the Co-op program can graduate on time especially when they have Advanced Placement coursework and/or have planned ahead. It is recommended that students pre-plan during their first or second year at school. Preparation of a complete four year plan with the student's academic advisor is required to ensure compatible scheduling of work periods and academic courses.

In order to qualify for the Co-op program, students must meet the following requirements:

1. Must be a current, full time, undergraduate WPI student in good standing. Note: If any of the following conditions apply a student may petition for eligibility.
 - a. Not in good academic standing (i.e. on academic warning or probation)
 - b. Have financial holds on their account

- c. Have a judicial record. Note: having a judicial record does not automatically preclude you from participating in a Co-op.
 - d. Want to register for up to 1/3 unit of course while on Co-op.
2. International students must complete one full academic year at WPI before being eligible for Co-op, due to US Federal Government regulations. In addition, the Co-op must be related to the major (not minor). For questions, please contact International House.
3. Understand the impact Co-op would have on your federal and institutional financial aid through a meeting with the Office of Student Aid & Financial Literacy.
4. Understand the impact your Co-op will have on your course schedule and outline your four year plan, including projects, Co-op, etc. and have it reviewed through a required meeting with your Faculty Advisor.
5. Approval will be needed from your Faculty Advisor, Office of Student Aid & Financial Literacy, Supervisor at your Co-op, Bursar, Dean of Students Office, Career Development Center (CDC), and International House (if applicable). Approvals are done electronically through Handshake, beginning with you entering your Co-op information in your Handshake Account's Experiences section. The deadline for fall Co-ops is August 1; the deadline for spring Co-ops is December 1. Co-ops received after deadline are reviewed on a case by case basis. Submissions after the add/ drop deadline will not be approved.
6. To be considered, the Co-op must be full time (at least 30 hours per week), paid, 4-8 months in duration and related to your major and career goals.
7. Understands and accepts the Terms of Agreement. (see website for more info at wpi.edu/+coop)

ADVANTAGES TO STUDENTS AND EMPLOYERS

Co-op offers several advantages to students:

1. Students gain experience, build their resume and bring theory into practice.
2. Co-op earnings enable students to pay a significant portion of their college expenses.
3. Sharpen skills and abilities as an emerging professional.
4. Test out career options to help clarify career goals and interests.
5. Return to school with new knowledge and experience in their field.
6. Position themselves for future opportunities; Co-op participants are preferred full time hires.
7. Transcript will show Co-op and indicate company name.

Co-op also offers several benefits to employers:

1. Co-op students can handle assignments that may be difficult for untrained personnel, but that do not require the talents of experienced professionals
2. The program gives employers the chance to judge the actual on-the-job performance of potential permanent employees.
3. Retention rates for permanent employees recruited through a Co-op program are higher than for those hired through other routes.

THE CO-OP PROCESS

Students interested in participating in Co-op should contact the Career Development Center to set up a Co-op information appointment. The following is a list of things that need to be done prior to the CDC processing a Co-op application:

1. Meet with your faculty advisor and the Office of Academic Advising to develop an academic plan including Co-op and your degree requirements.
2. Students with financial aid must schedule a meeting with the Office of Student Aid & Financial Literacy to discuss a Co-op's impact on your financial aid status.
3. Meet with the Career Development Center to learn how to search and apply for Co-ops. This includes resume and cover letter writing, job search strategies and resources, interview skills, and salary negotiation. The Career Development Center encourages you to use appointments, drop ins or attend workshops to prepare. If you would like to learn more about Co-op please schedule a Co-op Information appointment.
4. Please read the Terms of Agreement (visit wpi.edu/+coop for information). When submitting the Undergraduate Co-op Forms you are confirming you have read, understand and will abide by the terms.
5. Remain registered for courses until your Co-op is processed. The Office of the Registrar will then un-enroll you from courses and register you for Co-op.
6. Apply, interview, and accept a Co-op position and utilize the CDC for support. After officially accepting an offer, you should immediately withdraw applications with any other companies. Politely let them know you have accepted another position so other students may benefit. The CDC can help you with communicating this; if you need assistance or would like to role-play the scenario please make an appointment with a CDC Staff Member or visit the CDC during drop-in hours. Employers will appreciate your professionalism.
7. Complete the Undergraduate Co-op Program Forms which are found in your Handshake account. To begin, enter your Co-op in the Experiences section, which will then include your acknowledgement to abide by the Terms of Agreement, allow review of your Judicial Record through the Dean of Students Office, Bursar for financial holds, approval by your Faculty Advisor that you have communicated your four year academic course plan, the Co-op experience, and that you are in good academic standing, supervisor at the company, the Office of Student Aid & Financial Literacy, Career Development Center, International House (if applicable), and for you to upload a copy of the job description, and an offer letter mentioning start date, end date, salary and supervisor contact information. Should you be submitting a petition, you will submit this while filling out the aforementioned forms.
8. The CDC will initially confirm that your Co-op meets the Eligibility Requirements of the Undergraduate Co-op Program. After the CDC's initial confirmation on your Co-op, the approval process begins. Once all approvals are received and granted, notification will be sent to the Registrar, the Office of Student Aid & Financial Literacy, the Bursars Office, and if applicable, International House and Residential Services, as well as to you and your faculty advisor and supervisor. The Registrar at this point will un-enroll you from academic courses in the terms you will be away and register you for CP 100_ (the applicable courses that align with your time on Co-op).
9. Make arrangements for your housing in the new location/ Sublet your current off-campus apartment/Return your residence hall key before traveling to your Co-op. If you do not make arrangements for your current housing or return your residence hall key to Residential Services you will be charged for housing.
10. You may now start your Co-op on the date agreed upon with your employer. Enjoy your experience, and know the Career Development Center is here to support you through this experience.

Employers seeking to fill a Co-op position provide the CDC with a job description on Handshake, our web-based system. Students will then apply to those positions through Handshake by forwarding their resume and cover letter to the appropriate companies. In addition, students can look for Co-op experiences on their own initiative. Some employers interview candidates on campus; others review resumes and then invite selected students for on-site interviews. The final hiring decision is left to the employer. The student is free to interview with more than one employer and to identify opportunities outside of WPI's postings, ultimately choosing among the employment offers received. Once a decision is made, students are required to stop interviewing and applying for other positions and alert pending employers that they are no longer looking.

INFORMATION AND REGISTRATION

Students interested in exploring the possibility of participating in the program should contact:

Career Development Center
Project Center, Lower Level
(508) 831-5260
coop@wpi.edu
www.wpi.edu/+coop

With course offerings directed at meeting student needs, a variety of sessions, and both traditional and blended classes, E-term provides flexibility for students looking to work over the summer and still take advantage of these academic opportunities. E-term is a great time to

- Get back into good academic standing
- Lighten the load for the next year
- Speed up your time to degree completion
- Stay on track in the BS/MS program

E-term offers an exceptional opportunity to participate in certain types of project activity on a convenient basis since classrooms and laboratories will be less crowded and outside field work will enjoy better weather conditions. E-term also offers an excellent opportunity to complete a qualifying project through a full-time effort during a single term.

Since class sizes are generally smaller in E-term, students will enjoy more individually-oriented course work – a real benefit for classes that students find challenging or courses that are designed to prepare students for more advanced classes in their major.

Students planning to participate in Term E should register at the regular spring registration period. For more information, including payment and financial aid information, visit the E-term webpage at: <https://www.wpi.edu/academics/undergraduate/summer-courses>

Students from other campuses are also invited to take advantage of E-term offerings at WPI. Admission to the summer session does not imply admission to regular academic year programs. Students desiring to continue their work at WPI following the summer session should seek admission following standard WPI admissions procedures issued through the Admissions Office.

EARLY RESEARCH EXPERIENCE IN E TERM (EREE)

The Early Research Experience in E Term (EREE) program is designed to provide early research experience to interested students who have not yet had an authentic research experience. We will provide current first and second-year students an initial immersive research experience with a WPI faculty mentor. The goal of this program is to create pathways to deep and meaningful research experiences in STEM fields for undergraduate students, especially those from traditionally underrepresented groups in STEM including underrepresented minorities, first-generation students, transfer students, and women.

Students apply to participate in this research program and are selected and matched to an appropriate research opportunity. They work full time as part of a research team in the summer. All EREE students attend weekly professional development workshops, and share their research at a summer undergraduate research celebration at the end of the program.

Awards and prizes are determined by the academic department or by selected committees.

COLLEGE AWARDS

SALISBURY PRIZE AWARDS

These historic awards are made to highly meritorious seniors. These awards were established by Stephen Salisbury, a WPI founder and former president of the Board of Trustees.

TWO TOWERS PRIZE

This prize is awarded to the student who, through general academic competence, campus leadership, regular course work and special work in research and projects, best exemplifies a combined proficiency in the theoretical and practical union implicit in the Two Towers concept, which is at the heart of WPI's Two Towers tradition.

SIGMA XI AWARDS IN ENGINEERING AND SCIENCE

These awards in engineering and science are given to the students and their advisors for the Major Qualifying Projects which are judged to be the best in originality, contribution to the field, professional competence, and for the most useful applications.

PRESIDENT'S IQP AWARDS

These awards are given to student teams whose conception, performance, and presentation of their Interactive Qualifying Projects have been judged outstanding in focusing on the relationships among science, technology, and the needs of society.

PROVOST'S MQP AWARDS

These awards offer recognition to those students who have completed outstanding Major Qualifying Projects as a demonstration of their competency in a chosen academic discipline. Each academic department conducts its own competition to select the winners.

CLASS OF 1879 AWARD

Endowed by the Class of 1879, this prize is awarded by the Humanities and Arts Department yearly for excellent work in the culminating project for the Humanities and Arts Requirement. Projects must demonstrate exceptional creativity and skill in conceiving, developing, and expressing a theme within any discipline within the humanities and arts.

UNITED TECHNOLOGIES CORPORATION MINORITY AWARD

This award is presented to an outstanding minority undergraduate student.

OUTSTANDING WOMEN STUDENT AWARDS

Marietta E. Anderson Award, an award which is presented to the most outstanding woman student in one of the three lower classes who not only has a superior academic record, but also has been a work-study student, participated in recognized extracurricular activities, and has been a volunteer for college-sponsored activities.

Funds from an anonymous donor provide the following awards to women students preparing for careers in engineering or science. Awards are based on academic excellence, contributions to the WPI community, and professional goals. The awards are named each year for women who have played significant roles at WPI.

Bonnie-Blanche Schoonover Award, honoring WPI's former librarian.

Ellen Knott Award, honoring a long-time secretary in the Mechanical Engineering Department.

Gertrude R. Rugg Award, honoring WPI's late Registrar Emerita.

WILMER L. AND MARGARET M. KRANICH PRIZE

Students who are seniors or completing their junior year will be nominated by faculty for the annual award. The award will go to a student majoring in engineering, science or business who best exemplifies excellence in the humanities and in the full integration of humanities into his/her undergraduate experience. Double-majors who fulfill one major in Humanities and Arts are not eligible.

CHARLES O. THOMPSON SCHOLARS

Named in honor of the first president of WPI, this honor recognizes outstanding performance by first-year students.

To be eligible for membership, students must receive all A's and B's, with a minimum of six A's, in their academic subjects during the first three terms at WPI. Selections are made in Term D.

A cash award is presented to the outstanding first year student. Charles O. Thompson Scholars are eligible to apply for this award by submitting an essay to the Office of Undergraduate Studies during D Term.

SPECIAL AWARDS

ALPHA PHI OMEGA SERVICE AWARD

AMERICAN INSTITUTE OF CHEMISTS FOUNDATION

Chemistry and Biochemistry

An award by the New England chapter of the American Institute of Chemists to honor outstanding seniors majoring in chemistry and biochemistry.

AMERICAN SOCIETY FOR METALS: CHESTER M. INMAN '14 OUTSTANDING STUDENT AWARD

Mechanical Engineering

The Worcester Chapter of the American Society for Metals presents \$200 to a student for excellence in a Major Qualifying Project dealing with processing or materials science.

HAROLD S. BLACK AWARD

Electrical and Computer Engineering

This award was established in 2001 to honor the memory of inventor Harold S. Black '21. The award is given by the faculty of the Electrical and Computer Engineering (ECE) Department to one or more ECE seniors who have demonstrated outstanding creativity and enthusiasm in engineering problem solving, practical implementation of problem solutions, and exemplary character in their contributions to the welfare of the WPI community.

CENTRAL NEW ENGLAND AICHE AWARD FOR SIGNIFICANT CONTRIBUTION***Chemical Engineering***

This award is given to an individual in recognition of significant contributions to the American Institute of Chemical Engineers.

COMMUNITY SERVICE AWARD PRESENTED IN THE MEMORY OF EDWIN B. COGLIN '23***Alumni Office***

This award recognizes individuals who have demonstrated an extraordinary personal commitment above and beyond their normal involvement on campus in both academic and extracurricular activities.

COMPUTER SCIENCE OUTSTANDING JUNIOR AWARD***Computer Science***

This award is presented to a computer science junior who has an excellent academic record and who shows promise for continuing success.

COMPUTER SCIENCE OUTSTANDING SENIOR AWARD***Computer Science***

This award is presented to one or more computer science seniors who have an outstanding record and who have contributed to the enrichment and professional development of fellow students.

JAMES F. DANIELLI AWARD***Biology and Biotechnology***

This award, given by the Department of Biology & Biotechnology, honors the memory of Dr. James F. Danielli, a former department head and world-famous scholar.

FRANK D. DEFALCO AWARD***Civil and Environmental Engineering***

Award to WPI undergraduate Civil Engineering students who has completed two and one half years towards a B.S., interested in career constructed facilities and a member of ASCE student chapter.

ETA KAPPA NU OUTSTANDING STUDENT AWARD***Electrical and Computer Engineering***

The electrical and computer engineering honor society presents this award to the outstanding senior and junior in recognition of their academic achievement and their service to the WPI community.

GENERAL CHEMISTRY ACHIEVEMENT AWARD***Chemistry and Biochemistry***

This award is given to the student who has completed the freshman chemistry course with superior academic performance. Department award.

ALLAN GLAZER AWARD***Mechanical Engineering***

Established in 1992 by the family and friends of Allan Glazer '47, this award is given to a junior majoring in mechanical engineering who has demonstrated outstanding academic achievement, special ingenuity in problem solving, and enthusiasm for engineering challenges.

GOAT'S HEAD AWARD***Student Government Association***

Awarded annually to the outstanding new Senator of the year.

THE ROBERT H. GODDARD AWARD***Physics***

Established by the classes of 1908 and 1909 as a memorial to Dr. Goddard, this prize is awarded for outstanding achievement, scholarship, consistent effort and dedication of purpose in both theoretical and experimental areas of physics.

HEALD BROTHERS SCHOLARSHIP***Mechanical Engineering***

This scholarship identifies and supports outstanding young men and women who represent, in modern form, the spirit of "Yankee Ingenuity" that characterizes the evolution of the great manufacturing enterprises from the beginnings of the American Industrial Revolution.

ANDREW HOLT MEMORIAL AWARD***Civil and Environmental Engineering***

This award is presented to a civil engineering senior who has consistently earned academic honors and who shows excellent promise for success.

STEVEN J. KAHN AWARD***Humanities and Arts***

This award is presented to the outstanding senior in the WPI Glee Club in recognition of his contribution, commitment, and unwavering loyalty to the organization.

THE WILLARD ELLIOT LAWTON-SAMUEL JAMES PLIMPTON AWARD***Physics***

Established in honor of Professors Lawton and Plimpton, this award is presented to a student who has shown improvement in scholarship, not only in grades but also in depth of understanding.

LINCOLN ARC WELDING FOUNDATION AWARD***Civil and Environmental Engineering***

This award recognizes outstanding achievement in solving design, engineering, fabrication, and research problems.

MEDWIN HONORS STRING QUARTET SCHOLARSHIP***Humanities and Arts***

Scholarship money is given to the members of the Medwin Honors string Quartet (4 string players, 2 violins, 1 viola, 1 cellist), who are selected by audition each year.

THE ALFRED R. AND JANET H. POTVIN AWARD***Biomedical Engineering***

Separate awards are given to the outstanding undergraduate and graduate student in Biomedical Engineering in recognition of their academic performance and their service to WPI and/or the outside community.

CARL F. MEYER IMPROVEMENT AWARD IN CIVIL ENGINEERING***Civil and Environmental Engineering***

Established by Professor Emeritus Meyer, this award is presented to the civil engineering senior who has demonstrated the most improvement in academic and professional attitude since entering the department.

RICHARD V. OLSON AWARD*Mathematical Sciences*

Established to honor the memory of mathematics Professor Richard V. Olson, this annual award to a WPI sophomore recognizes outstanding performance in basic mathematics courses.

EDWARD C. PERRY AWARD*Mechanical Engineering*

This award is given annually to an engineering student or students for an outstanding major qualifying project in the area of mechanical design. The award is made possible through a bequest from Miriam Perry Goll and honors the memory of her father, Edward C. Perry '04, a design engineer with General Electric Company throughout his professional career.

PI TAU SIGMA AWARD FOR EXCELLENCE*Mechanical Engineering*

The mechanical engineering honor society, Pi Tau Sigma, presents this award to the outstanding junior mechanical engineering student.

ROBOTICS ENGINEERING OUTSTANDING JUNIOR AWARD*Robotics Engineering*

This award is presented to a robotics engineering junior who has an excellent academic record and who shows promise for continuing success.

ROBOTICS ENGINEERING OUTSTANDING SENIOR AWARD*Robotics Engineering*

This award is presented to one or more robotics engineering seniors who have an outstanding record and who have contributed to the enrichment and professional development of fellow students.

SENIOR MATHEMATICAL SCIENCES MAJOR AWARD*Mathematical Sciences*

This award is presented to the senior mathematical sciences major who has shown outstanding performance and who has made valuable contributions to the WPI mathematical community.

SOCIETY OF MANUFACTURING ENGINEERING SCHOLARS AWARD*Mechanical Engineering*

An SME Student Chapter member, recommended by the faculty and confirmed by the officers of SME chapter 25, who has demonstrated excellent scholarship, leadership, service, potential to contribute to the profession of Manufacturing Engineering.

The award includes scholarship assistance (\$900) for full-time study if the winner enrolls in WPI's graduate MFE program.

SOCIETY OF MANUFACTURING ENGINEERING UNDERGRADUATE SCHOLARSHIP AWARD*Mechanical Engineering*

Awarded to a 1st, 2nd, or 3rd year SME Student Chapter member, recommended by the faculty and confirmed by the officers of SME chapter 25, who has demonstrated excellent scholarship and commitment.

SOCIETY OF MANUFACTURING ENGINEERS OUTSTANDING STUDENT AWARD*Mechanical Engineering*

Awarded to the top three SME Student Chapter members each year, regardless of year, who have not already received the award.

SOCIETY OF MANUFACTURING ENGINEERS MQP AWARD*Mechanical Engineering*

An SME Student Chapter member, selected by a panel of practicing manufacturing engineers to have the best MQP in the area of Manufacturing Engineering.

STUDENT-ALUMNI INTERACTION AWARD*Alumni Office*

This award is presented by the WPI Alumni Association in recognition of individuals who, through their involvement on campus, have facilitated the continuing development of interaction between students and alumni. Recipients are full-time undergraduate students who have demonstrated extraordinary personal commitment to WPI and the Alumni Association above and beyond the normal involvement on campus.

The award is designed to recognize students who have stepped forward to become leaders in the alumni and student communities and, in doing so, have benefited both WPI students and alumni in a unique and purposeful way.

ACS UNDERGRADUATE AWARD IN ANALYTICAL CHEMISTRY*Chemistry and Biochemistry*

Award which is intended to encourage student interest in analytical chemistry and to recognize a student who displays an aptitude for a career in the field. This award is for third-year students.

ENGINEERING SOCIETIES

All engineers are professionals in accordance with the definition of engineering, one of which states that “engineering is the profession in which a knowledge of the mathematical and natural sciences gained by study, experience and practice is applied with judgment to develop ways to utilize, economically, the materials and forces of nature for the benefit of mankind.” Professional engineers also observe a code of ethics, exercise judgment and discretion while providing their services, and are involved in a confidential relationship with their clients. Professional engineers enjoy legal status, use professional titles, and associate together through professional societies.

An excellent way to begin learning about the status of the professional engineer is to join the student branch of a professional society relevant to your interests. At WPI, students are encouraged to join the student branches of such societies as the American Society for Metals (ASM), American Society of Mechanical Engineers (ASME), the Institute of Electrical and Electronic Engineers (IEEE), the American Society of Civil Engineers (ASCE), the American Institute of Chemical Engineers (AIChE), the American Institute of Aeronautics and Astronautics (AIAA), the Association of Computing Machinery (ACM), the American Nuclear Society (ANS), APICS, the Institute of Industrial Engineers (IIE), the Society of Automotive Engineers (SAE), the Society of Manufacturing Engineers (SME), the Society of Fire Protection Engineers (SFPE), the Society of Women Engineers (SWE), the American Chemical Society, (ACS), and the Society of Hispanic Professional Engineers (SHPE). For information on these organizations, see the appropriate department head.

ENGINEERING REGISTRATION AND LICENSING

In order to become a “Professional Engineer” (P.E.) and enjoy the legal status which affords certain rights, privileges and responsibilities, engineers must qualify through the formal procedures of registration and licensing. Procedures vary from state to state, but in most cases, the applicant must pass a Fundamentals of Engineering Examination.

FUNDAMENTALS OF ENGINEERING EXAMINATION

To become legally registered as a professional engineer (P.E.), candidates must submit data regarding formal education and technical ability to the appropriate state Board of Registration for Professional Engineers. Two major examinations, The Fundamentals of Engineering Examination (also called Engineering-in-Training, E.I.T.) and the Professional Practice Examination (P.P.E.), must be successfully completed as a measure of technical ability. The Fundamentals Examination

must be taken first; the Professional Practice Examination must then be taken after a designated period of substantial professional experience, usually a minimum of four years. File applications for E.I.T. by January 1. The E.I.T. Examination will be given in mid-April and late-October. File applications for Professional Practice Examinations (P.P.E.) six months in advance.

There are several possible qualification paths to registration as a P.E. The quickest and most common route is to obtain a degree from an ABET (Accreditation Board for Engineering and Technology-formerly ECPD) accredited curriculum, and to acquire the specified amount of suitable professional level experience in addition to passing the two examinations mentioned above. There are seven ABET accredited curricula at WPI-biomedical engineering, civil engineering, chemical engineering, electrical and computer engineering, industrial engineering, manufacturing engineering, and mechanical engineering. Persons with an unaccredited degree can still become registered in most, but not all, states by submitting evidence of a longer “apprenticeship” period (variable by states) before taking the two examinations. Students should strive, if at all possible, to pursue a program which is accredited by ABET and should work closely with their advisors and appropriate major departments to assure that the total program qualifies for accreditation, since this will greatly facilitate the achievement of registration in the future.

ALL SENIOR ENGINEERING MAJORS IN BME, CE, CHE, ECE, AND ME ARE URGED TO TAKE THE FUNDAMENTALS OF ENGINEERING EXAMINATION WHICH IS GIVEN ON CAMPUS EACH FALL AND SPRING. There will never be a better time!

Refresher courses for students, alumni and practicing engineers are available. Successful completion of this examination is normally the first step in eventually obtaining the right to use the initials “P.E.”

WPI’s Office of Continuing Education sponsors an eleven session EIT Refresher course from mid-January through mid-April on the WPI Campus. The course, which is taught by WPI faculty, includes reviews of the major topics covered on the exam. For further information, call 508-831-5517.

DESCRIPTION OF FUNDAMENTALS OF ENGINEERING EXAMINATION (F.E.E.)

Typical Date Given: Last Saturday in October (also in April).

Typical Application Deadline: First week in September (also in January).

Duration: Eight hours.

Type: Multiple choice, open book.

CAREER DEVELOPMENT AND GRADUATE SCHOOL

SECTION 6

Career Development and Graduate School Advising	236
Career Development Center	236
Graduate Study at WPI	237

CAREER DEVELOPMENT AND GRADUATE SCHOOL ADVISING

CAREER DEVELOPMENT CENTER

The Career Development Center (CDC) at WPI serves all degree seeking undergraduate and graduate students in the development of life-long skills related to careers, the internship/co-op and job search process, and the pursuit of graduate studies. The CDC serves all undergraduate and graduate students in addition to offering free lifetime alumni services.

The Career Development Center (CDC) provides a variety of services to students including the following:

1. **INDIVIDUAL APPOINTMENTS** – Students can easily schedule one-on-one appointments with a CDC Staff Member online through their Handshake account in order to get help on a wide variety of topics. Students can choose to discuss topics ranging from major selection, exploring career options, searching for internships/co-ops/jobs, interviewing, applying to graduate school, and evaluating and negotiating job offers.
2. **DROP-IN HOURS** – Students can also be seen by a CDC Staff Member during advertised drop-in hours. During these times, an appointment is not required and students can get help on a first-come, first-served basis with their resume/cv, cover letter, interviewing skills, job offer evaluation and negotiation, and other quick 15 minute questions.
3. **HANDSHAKE** – All students are provided with an account for the CDC's web-based system called Handshake. Handshake contains internship, co-op, part-time, and full-time job opportunities posted by employers for WPI students. Handshake also contains a company directory and information about upcoming events and career fairs hosted by the CDC. In addition, Handshake's resources section has special subscription resources (free of charge) that the CDC provides for students.
4. **SUBSCRIPTION RESOURCES** – The CDC maintains a subscription to several resources to assist students in their career development and job search process, which are housed in Handshake. Among the many resources the CDC offers to students are: MyPlan (self-assessments, majors and careers database, graduate school search), CareerShift (internship/job, company, and contacts search), Going-Global (country/state-specific career resources and H-1B visa company database, interviewstream (interview practice and feedback), Vault (Career, Industry and company exploration) and Versatile PhD (Industry career options for PhDs). These are free for students to use.
5. **CAREER OUTLOOK PAGES** – The CDC has put together a webpage with short descriptions of what can be expected from different WPI majors and careers, including average salaries, companies that have hired WPI graduates in a particular field, sample job titles, professional associations and clubs, popular industries, and more.
6. **CAREER FAIRS** – Each year the CDC organizes career fairs for students to network with employers and obtain information on full-time, summer internship and co-op opportunities. The CDC hosts 2 in person events and many more events virtually.
7. **CAREER WORKSHOPS** – Throughout the year, the CDC delivers frequent workshops for students on a wide variety of career development topics. Common workshop topics include: resumes/cover letters, internship/co-op/job search strategies, networking, interview skills, job offers and negotiation, and applying to graduate school, among others.
8. **NETWORKING NIGHTS and CAREER EXPOS** – The CDC hosts networking nights and career expos throughout the year to give students an opportunity to network with alumni, fellow students, and industry professionals.
9. **COMPANY INFORMATION SESSIONS** – Companies host events on-campus to present on their organization, culture, and technology while networking and sharing opportunities with students. Check your WPI Handshake account for upcoming events.
10. **JOB OPPORTUNITIES** – Job Postings are presented to WPI students and alumni exclusively by employers who want to hire WPI talent within the CDC Handshake system. Review and apply to Cooperative Education, Internships and Job positions to develop work experience.
11. **ON-CAMPUS INTERVIEWS** – Each year over 1,000 interviews are held on campus with a variety of private, non-profit, and government organizations. Employers interview students for full-time, summer internship, and co-op opportunities. For a list of companies actively seeking candidates for interviews, please utilize your Handshake account
12. **RESUME DATABASE** – Students and recent alumni may elect to make their resume viewable to employers through Handshake. If available, employers can access your "public" resume and may result in an interview request leading to a future opportunity.
13. **GRADUATE STUDIES** – The Career Development Center (CDC) and the graduate coordinators in each department can help students search for graduate programs at WPI (BS/MS, MS, MEng, PhD) or elsewhere and assist with preparing for and applying to graduate school.
14. **ALUMNI ASSISTANCE** – WPI alumni have free lifetime access to the CDC's services, whether they are seeking new employment or making a career change.

LOCATION: The Career Development Center is located in the lower level of the Project Center. The CDC can be contacted by phone at 508-831-5260 or by email at cdc@wpi.edu. The website is www.wpi.edu/+CDC

INTRODUCTION

WPI offers more than fifty graduate degree programs that enable students to deepen and enrich their understanding of a field, and to develop their professional expertise.

GRADUATE PROGRAMS**Aerospace Engineering**

- Master of Science in Aerospace Engineering
- Ph.D. in Aerospace Engineering

Bioinformatics and Computational Biology

- Master of Science in Bioinformatics and Computational Biology
- Ph.D. in Bioinformatics and Computational Biology

Biology and Biotechnology*

- Master of Science in Biology/Biotechnology
- Master of Science in Biotechnology
- Ph.D. in Biology and Biotechnology

Biomedical Engineering*

- Master of Science in Biomedical Engineering
- Master of Engineering in Biomedical Engineering
- Ph.D. in Biomedical Engineering

Business

- Master of Business Administration (M.B.A.)
- Master of Science in Information Technology
- Master of Science in Innovation with User Experience
- Master of Science in Management
- Master of Science in Marketing and Innovation
- Master of Science in Operations Analytics and Management
- Master of Science in Supply Chain Management
- Ph.D. in Business Administration
- Graduate Certificate

Chemical Engineering

- Master of Science in Chemical Engineering
- Professional Master of Science in Chemical Engineering
- Ph.D. in Chemical Engineering

Chemistry and Biochemistry

- Master of Science in Chemistry
- Master of Science in Biochemistry
- Ph.D. in Chemistry
- Ph.D. in Biochemistry

Civil and Environmental Engineering

- Master of Science in Civil Engineering
- Master of Science in Environmental Engineering
- Interdisciplinary Master of Science in Construction Project Management
- Master of Engineering in Civil Engineering
- Ph.D. in Civil Engineering
- Graduate Certificate
- Advanced Certificate

Computer Science

- Master of Science in Computer Science
- Master of Science in Computer Science Specializing in Computer Security
- Ph.D. in Computer Science
- Graduate Certificate
- Advanced Certificate

Data Science

- Master of Science in Data Science
- Graduate Certificate
- Ph.D. in Data Science

Electrical and Computer Engineering

- Master of Science in Electrical and Computer Engineering
- Master of Engineering in Electrical and Computer Engineering
- Master of Engineering in Power Systems Engineering
- Ph.D. in Electrical and Computer Engineering
- Graduate Certificate
- Advanced Certificate

Fire Protection Engineering

- Master of Science in Fire Protection Engineering
- Ph.D. in Fire Protection Engineering
- Graduate Certificate
- Advanced Certificate

Interactive Media & Game Development

- Master of Science in Interactive Media & Game Development

Interdisciplinary Programs

- Master of Science in:
 - Power Systems Management
 - System Dynamics and Innovation Management
 - Systems Modeling
- Ph.D., Interdisciplinary Studies
- Graduate Certificate in Nuclear Science and Engineering
- Graduate Certificate in System Dynamics and Innovation Management

Learning Sciences and Technologies

- Master of Science in Learning Sciences and Technologies
- Ph.D. in Learning Sciences and Technologies

Manufacturing Engineering

- Master of Science in Manufacturing Engineering
- Ph.D. in Manufacturing Engineering
- Graduate Certificate

Materials Process Engineering

- Master of Science in Materials Process Engineering

Materials Science and Engineering

- Master of Science in Materials Science and Engineering
- Ph.D. in Materials Science and Engineering

Mathematical Sciences

- Master of Mathematics for Educators (M.M.E.)
- Master of Science in Applied Mathematics
- Master of Science in Applied Statistics
- Professional Master of Science in Financial Mathematics
- Professional Master of Science in Industrial Mathematics
- Ph.D. in Mathematical Sciences
- Ph.D. in Statistics

Mechanical Engineering

- Master of Science in Mechanical Engineering
- Ph.D. in Mechanical Engineering
- Graduate Certificate in Mechanical Engineering for Technical Leaders

Physics

- Master of Science in Physics
- Ph.D. in Physics

Robotics Engineering

- Master of Science in Robotics Engineering
- Ph.D. in Robotics Engineering
- Graduate Certificate

STEM for Educators

- Master of Science in Mathematics for Educators (MMED)
- Master of Science in Physics for Educators (MPED)

Social Science and Policy Studies

- Master of Science in System Dynamics
- Ph.D. in System Dynamics
- Graduate Certificate in System Dynamics

Systems Engineering

- Master of Science in Systems Engineering
- Ph.D. in Systems Engineering
- Graduate Certificate
- Advanced Certificate

* *Fall semester admission only.*

At WPI, the Master of Engineering degree is rooted in practice; its aim is to cultivate advanced professional and technical competence. It does not require a thesis and is most appropriate for students who plan to pursue careers in industry.

The Master of Science has a stronger theoretical component than the Master of Engineering degree. Its aim is to prepare students for careers in research and development or academia. The M.S. is the more natural precursor to the Ph.D., although students with an M.Eng. can also successfully obtain this credential. WPI offers both thesis-based and non-thesis Master of Science degrees.

The Ph.D. indicates that a student has undertaken original research and has demonstrated mastery of his or her field through the completion of a substantial project. Ph.D. students present their research findings in a dissertation that is subject to review by the faculty and, in some cases, by professional peers outside of WPI.

WPI's M.B.A. program leverages the University's technical and scientific strengths, focusing on the integration of business and technology. Some key areas of study include: technology commercialization; data quality; health systems innovation; leading change; and user experience.

Finally, the Professional Master of Science and the Master of Mathematics for Educators degrees are akin to the Master of Engineering degree in that they are practice-oriented in both conception and scope.

Further information and the specific requirements for these advanced degrees may be found in the Graduate Catalog (<http://www.wpi.edu/+gradcat>).

ADMISSION

Prospective graduate students are encouraged to discuss their academic plans with the graduate coordinator of their desired program.

Students may take graduate courses without being formally admitted to a degree program; that is, as a non-matriculating student. But each department limits the number of courses a non-matriculating student may count towards a degree. In some

programs, a student may complete as many as four courses without being admitted. No department permits a student to complete more than four courses before a formal admission decision has been made. If you plan to enroll in classes as a non-matriculating student, be sure to contact your department to learn what restrictions have been placed on course work completed before admission to a degree program.

Students should contact the Office of Graduate Admissions (grad@wpi.edu) if they have questions about their application or the application process. In general, each department requires its applicants to submit a completed application, original transcripts of all previous academic work, and three letters of recommendation. The Graduate Record Examination (GRE) is required in some programs and strongly recommended in others. Be sure to check the website for your program to learn its application requirements.

Once a student's application is complete, the Office of Graduate Admissions sends it to the department for review. When the faculty have reached a decision, the Office of Graduate Admissions will notify the student with a formal letter. Decisions are usually rendered four to six weeks after the application has been completed.

Applications for graduate study are accepted year-round. WPI alumni and current WPI undergraduate students are exempt from the \$70 application fee.

REGISTRATION AND TUITION PAYMENT

Registration for graduate courses begins several months before the beginning of each semester. Students are encouraged to register for their courses as early as possible.

Tuition for courses taken by graduate students is \$1,513 per credit hour for the 2018-2019 academic year. Undergraduate courses listed as "one-third unit" are equivalent to two graduate credit hours.

Tuition and fees, including health insurance, must be paid by the due date on the electronic bill (eBill) or at the time of registration.

COMBINED BS/MS PROGRAMS

For information on combined BS/MS programs, see page 222.

FINANCIAL AID**INTRODUCTION**

Prospective graduate students who wish to be considered for WPI assistantships and fellowships are strongly advised to submit their applications by January 1st for Fall admission and October 1st for Spring admission. Assistantships and fellowships typically include full or partial remission of tuition and a monthly stipend. Only full-time graduate students are considered for assistantships and fellowships and preference is given to students who are actively conducting research. Students indicate that they want to be considered for funding on their graduate application forms. There is no separate application for assistantship or fellowship support at WPI.

ASSISTANTSHIPS

There are two types of assistantships at WPI. Teaching assistants support the faculty in the grading of papers, the supervision of laboratory sections, and other teaching duties. Research assistants, on the other hand, are usually given some facet of a larger sponsored-research project that typically becomes a part of the student's thesis or dissertation. Fellowship assignments are made by the faculty in each department and are approved by the Office of the Provost.

NSF GRADUATE RESEARCH FELLOWSHIPS

The National Science Foundation awards multi-year fellowships to promising science and engineering students in the early stages of their graduate careers. These highly-competitive, prestigious awards provide three years of support and are available to both Master's and Ph.D. students, as long as the degree is research-based. You can learn more at the NSF website:

<http://www.nsf.gov/funding/>.

GEM FELLOWSHIPS

WPI is a member of the GEM consortium. Students who belong to underrepresented minority groups and want to pursue the Master's or Ph.D. degree in a field of science or engineering may apply for funding from the consortium to continue their studies at a GEM member school. More information can be found at the GEM website: <http://www.gemfellowship.org/>.

LOANS

Graduate students may also receive additional financial assistance in the form of federal and private student loan funds. In order to apply for these loans, students are required to submit the Free Application for Federal Student Aid (FAFSA) form. This form can be completed online at www.fafsa.gov. For more information you can contact the Office of Financial Aid website at <http://www.wpi.edu/+finaid>.

SCHOLARSHIPS AND GRANTS FOR GRADUATE STUDY ABROAD

RHODES SCHOLARSHIPS

Rhodes scholarships cover tuition, fees, and a stipend for two years of study in selected fields of science and engineering at Oxford University. They are awarded through state and regional competitions. Students interested in applying for a Rhodes Scholarship should begin to assemble their dossier during the Junior year. Applicants should have completed enough of the Bachelor's degree to assure its completion before their projected matriculation at Oxford. For more information, contact Prof. Peter Hansen in the Department of Humanities and Arts.

FULBRIGHT GRANTS

A wide variety of grants for graduate study abroad, usually for research toward the doctorate, is available through the federally-funded Fulbright Grants Program. For more information, contact Prof. Peter Hansen in the Department of Humanities and Arts.

PART-TIME GRADUATE PROGRAMS: ONLINE AND CAMPUS-BASED STUDY

Part-time graduate programs provide flexible educational opportunities for working students. Online, evening, and on-site corporate programs are taught by WPI faculty to serve the educational needs of technical and management professionals around the world.

Master of Science degrees for part-time students are offered in applied math, applied statistics, chemistry and biochemistry, computer and communications networks, computer science, financial math, industrial math, information technology, management, marketing and innovation, innovation with user experience, operations analytics and management, manufacturing management, operations analytics and management, supply chain management, physics, and system dynamics. The part-time MS is also offered in biomedical/clinical engineering, electrical and computer engineering, fire protection, manufacturing, materials science, mechanical engineering, supply chain management, and robotics engineering. The Master of Engineering degree can be completed part-time in biomedical, civil and environmental engineering. The Master of Business Administration (M.B.A.) is also offered on a part-time basis.

Graduate-level certificate programs are also available in some departments. For more details, see the Graduate Catalog.

Although the number of courses in each discipline may be limited in any given year, courses are scheduled so that part-time students are generally able to complete the requirements for the master's level degree in three to four years. Online and evening courses are offered year-round.

Students may enroll in individual graduate courses without being admitted to a graduate degree program. Those who wish to obtain a degree must apply for formal admission prior to completing two courses for graduate certificate programs and four courses for master's degree programs. Exceptions to this rule exist, so interested students should verify the actual number of courses they may take prior to matriculation within the specific program department.

A more detailed description of the part-time programs and of specific course offerings is available in the Graduate Catalog. Questions about each program should be related to the department heads or the graduate coordinators.

FIVE YEAR PROGRAMS

WPI offers unique five-year programs in Fire Protection Engineering, Industrial Mathematics, and Financial Mathematics. Each program begins with admission to the freshman year at WPI and ends with both a Bachelor's and Master's degree following five years of study.

High school students indicate their interest in one of these programs when they apply for admission to the undergraduate program at WPI. Applicants who are accepted into one of these programs will receive a letter of admission to both the undergraduate and graduate programs. Students in these programs are strongly urged to major in a field closely related to the graduate degree program. For example, most students choosing the Fire Protection Engineering program will have an undergraduate

major in Mechanical or Civil Engineering. An academic advisor will assist students in course selection. Admission to the fifth year of study (i.e., the graduate program) is contingent on successful completion of the undergraduate degree and good academic standing.

For more information about these programs, contact the graduate coordinators or administrators in the Departments of Mathematics or Fire Protection Engineering.

GRADUATE COURSE LISTINGS

Graduate courses of interest to undergraduates are listed by title in the "Course Description" section of this catalog. A complete list is included in the graduate catalog. Most courses meet once per week in a fourteen-week format. The credits applied in either case are as shown to the right of the course title. Undergraduate students taking graduate courses may use the conversion factor: 1 graduate credit = 1/6 undergraduate unit. Students register for research or projects by using an individual program number rather than a course designation.

FOR MORE INFORMATION ON GRADUATE STUDY AT WPI

Consult the graduate catalog for more information about WPI's graduate programs. The departmental graduate coordinators are available to answer any program-specific questions you may have.

For more information about applying to WPI's graduate programs, please contact:

WPI Office of Graduate Admissions

www.grad.wpi.edu

grad@wpi.edu

Voice: 508-831-5301

FAX: 508-831-5717

Graduate Catalog online: <http://www.wpi.edu/+gradcat>

ADMISSION, EXPENSES, FINANCIAL AID AND HOUSING

Admission to WPI	242
Expenses	245
Financial Aid	247
Housing	251

SECTION 7

INTRODUCTION

WPI recruits, selects, and enrolls students who are the best match for our dynamic and distinctive educational offerings. Our admissions professionals review all students holistically taking into account each student's qualitative and quantitative materials within their specific context.

Selection for admission to WPI is based upon many factors including, but not limited to, academic preparation, grades, trends in academic performance, the personal essay, recommendations, co-curricular and extracurricular activities, and standardizes test scores (if submitted by the applicant). Candidates are allowed to submit supplemental material that they believe is relevant to the admissions committee's evaluation of their application.

VISITING & INTERVIEWING

WPI offers opportunities for students to explore campus, interview with admissions staff, and engage with students and faculty including:

- Daily information sessions & tours (weekdays & select Saturdays)
- Virtual online campus tour
- Fall Open House (for prospective & applying students)
- Personal interviews (on-campus and off-campus)
- Accepted Student Days (for accepted students)
- Envision overnight programs (for accepted students)

Visit www.wpi.edu/+visit for more information or to register for a visit or event.

Admissions Office Hours

The admissions office is open Monday – Friday 8:30am–5:00pm throughout the academic year. Summer hours (mid-May through the end of August) are 8:00am–4:00pm.

Contact Information

- Phone: (508) 831-5286
- Email: admissions@wpi.edu

ADMISSIONS REQUIREMENTS

The basic academic requirements for first-time first-year applicants include:

- Four years of English
- Four years of math (including pre-calculus)
- Two years of lab science

Other application requirements for the evaluation process include:

- Official high school transcript
- Recommendations from a teacher (preferably math or science) and a guidance counselor
- A personal essay

WPI is a test-optional university. Applicants to WPI are not required to submit SAT or ACT scores. Candidates who wish to have their test scores considered can either self-report their scores or send an official score report from the College Board or ACT. If applicants choose to self-report scores at the time of application, they must send official scores when enrolling at WPI. WPI's institutional code is 3969 for the College Board and 1942 for the ACT.

International students whose first language is not English are required to submit either TOEFL or IELTS scores.

APPLYING TO WPI

WPI is a member of the Common Application, and the Common Application is the exclusive method by which first year candidates apply to WPI. All first year candidates must complete their application no later than January 15 for consideration.

Application deadlines*:

Early Action	November 1
Early Decision I	November 1
Early Decision II	January 15
Regular Decision	January 15

Notification deadlines*:

Early Action	January 15
Early Decision I	December 15
Early Decision II	February 15
Regular Decision	March 15

*Dates are subject to change. Visit www.wpi.edu/admissions/undergraduate for the most up-to-date information regarding deadline and notification dates.

FINANCIAL AID

Students applying for financial aid must check the appropriate box on the application for admission to be considered for financial aid. Financial aid candidates should submit the College Scholarship Service (CSS) Profile Application and the Free Application for Federal Student Aid (FAFSA), which are available online at www.cssprofile.org and www.fafsa.gov. For all admission applicants, these forms should reach the WPI Office of Student Aid & Financial Literacy by the same deadline dates listed above for Admission applications. Financial Aid is available for U.S. citizens and/or permanent residents of the U.S. A limited amount of need-based financial aid is available for International Students. In order to apply for need-based assistance, international students must complete the international CSS Profile online at www.cssprofile.org.

APPLICATION FEE

A \$65 application fee is required for all applicants. WPI endorses the fee waiver policy of the College Entrance Examination Board.

NOTIFICATION

All candidates for admission will receive an online acknowledgment of the receipt of their application. Admissions decisions are available exclusively through WPI's online portal and are not mailed to applicants. Decisions will be available to all applicants no later than April 1.

DECISION TO MATRICULATE

Accepted candidates must inform the college by 11:59pm on May 1 of their decision to matriculate and submitting a \$500 non-refundable tuition deposit. Any deposits mailed in must be post-marked on or before May 1. WPI reserves the right to return deposits received after this date.

REVOCATION OF ADMISSION

In rare cases the admissions office may revoke the admission of an accepted or deposited student for reasons including (but not limited to):

- A change in academic performance
- Academic dishonesty
- Behavioral or disciplinary issues
- Actions deemed unacceptable by the admissions committee

ADVANCED PLACEMENT

WPI awards credit to students who score a score a “4” or “5” on most Advanced Placement Examinations. The Office of Academic Advising will notify such students of their earned credit by mail to the home address during early August. You can visit the Registrar’s Office web site www.wpi.edu/offices/registrar/policies-procedures/ap-credit for a complete list of AP credits for exams taken.

Humanities

The Humanities and Arts Department will accept a maximum of 1/3 unit of AP credit towards the Humanities and Arts requirement. AP credit beyond one course (1/3 unit) in the Humanities and Arts may be counted toward other requirements such as free elective credit or particular majors and minors at WPI. For most humanities disciplines, students who score a 4 or 5 in the AP test will receive credit in the relevant discipline. Special cases in language and studio art are explained below.

AP credit in languages

Students who score a 4 or higher on the College Board AP exam in Chinese language and culture, German Language, Spanish language, or Spanish literature, automatically receive 1/3 unit of credit in the language. This can be applied to the breadth component of the HUA Requirement or to the HUA language track option. In either case, the student will receive credit for one of the following Elementary 1000-level language courses and cannot enroll in that course for additional credit: CN 1541, GN 1511, SP 1523.

Students who took Arabic, Chinese, German, or Spanish in high school – but who do not earn AP credit for it at WPI – can get 1/3 unit retroactive credit for that language if they meet the following 3 criteria: 1) studied it for three or more years in high school and maintained at least a B average for all three years and; 2) place into at least the 2nd term of the appropriate WPI language sequence; and 3) successfully complete two terms of that language at WPI, earning grades of B or higher in both courses. The exception is Spanish: students studying Spanish must complete Intermediate I (SP 2521) and Intermediate II (SP 2522) with a grade B or higher. To request 1/3 unit retroactive language credit, please use the appropriate form on the Humanities and Arts website (<https://www.wpi.edu/academics/departments/humanities-arts/resources>). Students may receive credit for either the AP exam or 3 years of high school language study, but not both. For questions about this policy, please contact the Humanities and Arts Department.

AP Credit in studio art

Students who score a 4 or 5 in the AP test in studio art are eligible for HUA credit after a successful portfolio review by art faculty.

Computer Science

Advanced placement in computer science can be earned for the “Computer Science AP A” exam. Credit for CS 1000 is granted for scoring a “4” or “5” on the CS AP A exam. No credit will be granted for “Computer Science AP Principles” exam.

The Computer Science department advises CS Majors who earn a “4” or a “5” on the CS AP A exam to enroll in CS 1102 (Accelerated Introduction to Program Design). Students who wish to pursue a CS Minor after earning a “4” or a “5” on the

CS AP A exam may consider enrolling in CS 2119 (Application Building with Object-Oriented Concepts) or CS 2301 (Systems Programming for Non-Majors).

Students who took CS AP Principles exam and have substantial programming experience should consult with the CS course instructors as to which course to take.

Natural Sciences

Students who pass the advanced placement test in Biology or Physics B with a “4 or 5” will be awarded 1/3 unit of advanced placement credit. This credit will show on the transcript as “L”. For students who score “4 or 5” in Physics C (Mechanics) will be awarded 1/3 unit in Physics 1110/ 1111. Students who score “4 or 5” in Physics C (Electricity and Magnetism) will be awarded 1/3 advanced placement credit for Physics 1120/1121. For those students who pass Physics B will be awarded 1/3 unit in Physics 1000. Students who score 4/5 on the Chemistry Advanced Placement Examination or 6/7 on the Chemistry International Baccalaureate Exam are automatically awarded 1/3 unit of credit for CH 1010. In addition, any student can earn credit for the general chemistry courses, CH 1010-1040, by achieving scores of 70 or better on course-specific examinations offered by the Department of Chemistry and Biochemistry. Exams must be taken in the order in which the courses are offered, and a student may not take any exam past the first failed exam. For example, a student who passes the CH 1010 exam but fails the CH 1020 exam is not eligible to take the CH 1030 exam. This student will receive credit for CH 1010 only. Students who receive AP or IB credit for CH 1010 are eligible to take the CH 1020 exam without having first passed the CH 1010 exam. Note this policy applies only to WPI students.

Mathematics

Students who pass the AB mathematics examination with a “4” or “5” will be awarded 2/3 unit of advanced placement credit for MA 1021 and MA 1022. Students with a “4” or “5” on the advanced placement BC exam will be awarded 1 unit advanced placement credit for MA 1021, MA 1022 and MA 1023. In the four-course 1021-1024 mathematics sequence, students who arrive at WPI prepared to start with the second (or third) course in the WPI sequence, and who successfully pass that course and the one that follows it, will be considered to have established advanced placement credit for the first one (or two) courses. To qualify for the credit, the two WPI calculus courses must be passed on first attempt during the student’s first year (by the end of term D). The courses credited retroactively will be listed by number without an assigned grade and will count toward the distribution requirement in mathematics.

Project Lead The Way (PLTW)

WPI awards credit to current WPI students who completed a PLTW Engineering course in high school, received a minimum of a “B” in the course, and earned on the PLTW End-of-Course Assessment either a stanine score of 6 or higher (before July 2018) or a minimum scale score of 410 for IED, 410 for POE, 420 for CEA, 430 for CIM, 450 for DE. WPI also honors PLTW transfer credits from other select PLTW university partners, such as RIT. Please visit the WPI Project Lead The Way web site (www.wpi.edu/+pltw) for more information and to apply for credit. A staff member will notify students of their earned credit..

NEW STUDENT ORIENTATION

During the week prior to classes, the Campus Center and Student Activities Department coordinates a comprehensive new student orientation program for all first-year and transfer students. New student orientation provides an introduction to the WPI experience, ranging from academic work and expectations and project-based education, to student life and campus activities. Led by upperclass student team leaders and faculty advisors, new students to WPI attend team meetings that are designed to familiarize them with the overall campus environment.

TRANSFER STUDENTS

Each fall, WPI welcomes applications from full- and part-time transfer students from accredited two- and four-year institutions. We look for candidates with demonstrated strength in math, science, and computer or engineering coursework; transfer admission to WPI is highly competitive. Candidates must be enrolled in, or have recently completed, courses in calculus and in two laboratory sciences at the time of application. Successful transfer candidates typically have a cumulative college GPA of 3.5 or higher. Additionally, successful transfer candidates have typically completed at least one full year of college (post high school graduation) by the time of intended enrollment. Transfer candidates must be in good academic and disciplinary standing at all institutions in which they have been an enrolled student.

Applicants should be aware of the accelerated pace of WPI's academic calendar, which consists of four, seven-week terms instead of two semesters. A full-time course load is defined as three courses per term with classes meeting four or five days per week, while a part-time course load may not exceed three total courses in two consecutive terms. All transfer students must enroll at WPI for a minimum of two full academic years in order to complete a degree. Additionally, undergraduate classes are only offered during the day.

Transfer Admissions & Financial Aid

The fall entrance application deadline is May 15th, with the review process typically beginning in March each year. Please note WPI does not offer a January application option. In addition to submitting the Application (available for transfer candidates after January 1st), transfer applicants should provide their official college transcripts for each post-secondary institution attended, a Mid-Term Report of coursework currently in progress, a final official high school transcript, two letters of recommendation (one must be from a college academic instructor), and the Transfer College Report. International transfer applicants must submit English translations and course-by-course evaluations (from a current NACES member) for all non-US transcripts, proof of English Language Proficiency, and Proof of Financial Ability (if accepted to WPI) demonstrating funding for the total cost of education and living expenses (an I-20 will not be issued without this form). Additional information about the transfer application process can be found at admissions www.wpi.edu/.

Transfer students may be eligible for need-based scholarship and loan funds from a variety of sources including WPI, the federal government, and some state government agencies. Financial aid is not available for part-time candidates or for international (non-U.S. citizen) transfer students. More information is available at www.wpi.edu/+finaid.

Transfer Agreements & Transfer Credit

WPI currently holds formal articulation agreements with specified programs of studies at both Quinsigamond Community College and Cape Cod Community College. However, WPI will grant appropriate transfer credit from any accredited two-year or four-year institution.

WPI is only able to offer a transfer credit evaluation once a transfer student is offered admission and enrolls at WPI and after enrollment for first year students, typically beginning in mid-May; Newly enrolled WPI students (both transfer and first-year) should send a transfer credit review request to transfer@wpi.edu, and provide college transcripts and course descriptions or syllabi for each course to be considered from work completed prior to their enrollment at WPI. The Transfer Admissions team coordinates the process with WPI faculty who evaluate the coursework to determine credit eligibility. Each academic department at WPI reviews courses under their program, and provides a decision to the Transfer Admissions team. Admissions communicates any credit updates to the WPI Registrar's Office as well as WPI Academic Advising. In general, courses that are the academic equivalent of a WPI course with a grade of a B or better will be considered for transfer credit. College-level and lab-based chemistry and biology, calculus, calculus-based physics with lab, engineering science, and most social science and humanities and arts courses are typically considered for transfer credit. To be eligible for credit review, the courses must be completed on a college campus taught by college instructors. Early college, early entrance programs, or college coursework provided in partnership with a college or university but offered at the high school taught by high school teachers are not eligible for credit at WPI, with the exception of Project Lead The Way (PLTW). Online coursework is also typically not eligible. Additional courses that are not transferable include pre-calculus, non-calculus based physics or engineering science, and computer courses in BASIC.

Humanities & Arts Requirement for Transfer Students

As part of the WPI Plan, all WPI students must complete the Humanities and Arts Requirement. As such, all transfer students should review their humanities and arts coursework accepted for transfer credit at WPI and plan with the Humanities and Arts Department's coordinator for transfer students to determine next steps towards the completion of the HUA Requirement. All transfer students entering WPI with fewer than two units of humanities and arts credit must complete thematically related work in humanities and arts. This will include an inquiry seminar or practicum to the extent that the overall humanities and arts credit totals two units. The HUA Requirement is considered fulfilled for transfer students who have completed the equivalent of two units of humanities and arts work prior to their matriculation at WPI. A Completion of Degree Requirement form (or CDR) must be submitted once the HUA Requirement has been satisfied. This form can be obtained at the WPI Registrar's Office, and will be completed by the Humanities and Arts Department coordinator for transfer students. For those transfer students who have satisfied the HUA Requirement based on work completed at their previous institution(s) and who submit the approved CDR form to the WPI Registrar's Office will have this information posted to their student account. This process normally takes place prior to or during the first term of full-time enrollment at WPI.

INTERNATIONAL STUDENTS

The presence of international students serves as a means of strengthening the knowledge and understanding of foreign countries and cultures and is highly encouraged and supported at WPI. Programs and support services for international students and exchange programs are given high priority. As an institution of higher learning, WPI is dedicated to international education.

In addition to the standardized tests listed prior, international applicants must provide proof of English language proficiency. English language proficiency may be demonstrated by the official results of:

- TOEFL (Test of English as a Second Language)-Minimum score: 550 paper based or 80 internet based.
- IELTS (International English Language Testing System) 6.5 or higher with no band below 6.0.

THE ENGLISH AS A SECOND LANGUAGE (ESL) PROGRAM

The ESL Summer Institute is an intensive five-week non-credit course of study in English for specific purposes for international students and others whose first language is not English. This ESL program is designed to help prepare these international students for regular courses in engineering, science and technology before the regular academic year begins.

For students who need additional support during the regular academic year, the ESL Seminar, a tutorial course designed to help the student further strengthen linguistic skills, is offered.

During the regular academic year, ESL for Spouses is a noncredit course offered to interested partners accompanying WPI students and professors.

EXPENSES

ESTIMATED EXPENSES

Expenses for the 2020-21 year were not established at the time of this publication. They will be published via the web at a later date. For the 2019-20 year, the expenses were as follows:

Tuition	\$51,604
Student Life Fee	316
Health & Wellness Fee	400
Total Tuition and Fees	\$52,320
Room (Typical Freshman Double)	8,736
Board (7-Day, 19-Meal Plan)	6,566
Books and Supplies (Estimated)	1,000
Personal Expenses	1,200
New Student Orientation Fee	200
	<hr/>
	\$70,022

Basic tuition entitles full-time students to full academic and student services including counseling, placement and recreational facilities. Other costs must be anticipated, such as laundry, clothing, travel expenses, entertainment and personal expenses.

SPECIAL STUDENT

1/3 unit (3 credits) \$4,299

Health insurance is required for all students. Students may waive their right to participate in the WPI health insurance plan if proof of comparable coverage is provided annually by completing a waiver online. For 2019-20, the cost was \$1,252 for the academic year.

PAYMENT OF TUITION DEPOSIT**ENTERING STUDENTS**

Payment of a nonrefundable \$500 deposit is required upon acceptance of admission to WPI. The \$500 will be credited to the student's tuition.

ENROLLMENT AND TUITION DUE DATES

Enrollment for students pursuing a baccalaureate degree will occur three times per year:

1. Fall semester-at the beginning of Term A.
2. Spring semester-at the beginning of Term C.
3. Summer session-at the beginning of Term E.

There will be no check-in at the start of Terms B and D, although a course change period will be available for students continuing from the previous term.

Special tuition features relative to Term E enrollment are available on the E-term web site.

Bills are electronically mailed twice per year, per semester. Fall bills will be mailed in July and are due in August. Spring bills are mailed in December and due in January. All respective due dates are listed on the eBill. Students who enroll two weeks prior to the start of a semester are required to pay at the time they register.

For E-Term (Summer) if a WPI student registers prior to a week before the first day of class they will receive an eBill, E-Term typically has two due dates, an E1 due date and an E2. If a student registers within one week before or after the start of the E-Term session payment is due at the time of registration. *Non-matriculated students, (not enrolled in a WPI degree program) payment is due at the time of registration. Failure to pay will result in being dropped from any course(s).*

FINANCIAL OBLIGATIONS, HOLDS, AND LATE FEES

*The college reserves the right to hold grades, official transcripts, registration and/or diploma for any student who has an outstanding financial obligation with the college.

Late fees will be assessed on balances not paid by the due dates.

A student may be administratively withdrawn due to an outstanding financial obligation for a term, which may require the student to apply for financial re-admission.

Students who elect to petition any charge on their Student Account must do so in writing prior to the final day of classes in the respective term (B term for Fall or D term for Spring). No late petition will be reviewed or approved if submitted after a term has commenced.

Failure to pay your financial obligation may result in the account being referred to an outside collection agency and reported to a credit bureau agency, which will negatively affect your credit rating. You will be responsible for all costs associated with the collection of this debt to the maximum amount allowed by Massachusetts general statutes.

* WPI fully supports the Veterans Benefits and Transition Act of 2018. Sec. 103 amends US code to prevent schools from penalizing Ch. 31 or 33 students if/when the VA is late making payments. WPI policy supports and agrees to the VA recommendations of the following while waiting for VA payments: WPI agrees to not prevent enrollment, charge a late penalty fee(s), require alternative or additional sources of funding or deny access to school resources.

OVERLOAD CHARGES

There will be a tuition surcharge on registration which contains academic overloads in excess of $2\frac{1}{3}$ ($7/3$) units per semester. Physical education and military science are not included in the determination of overloads. The overload charge will be based upon the total registration credit held by the student at the close of the initial course change period in B- and D-terms. (Please consult the Registrar's Office or the Office of the Bursar for current fees.) Fall overload billing will take place during Term B and spring overload billing during Term D. The current Term E charge system will not be affected.

TUITION CHARGES UPON WITHDRAWAL OR SUSPENSION

Tuition charges upon formal withdrawal from the college during each semester are:

	Charge
1. Withdrawal after enrollment but prior to first day of classes of a semester	Charged 0%
2. Withdrawal weeks 1 & 2	10%
3. Withdrawal week 3	20%
4. Withdrawal week 4	30%
5. Withdrawal week 5	40%
6. Withdrawal weeks 6-8	50%
7. Withdrawal week 9	60%
8. Withdrawal week 10	80%
9. Withdrawal week 11 and after	100%

To qualify for a reduction in tuition, students must submit an Official Withdrawal form to the Registrar's Office. The date of the student's last date of attendance determines the charge.

There is no reduction in tuition/fees in the case of withdrawal from individual courses.

Students who have paid full tuition for eight semesters may be allowed to enroll as part-time students on a per-course basis and be charged tuition accordingly. (Two summer terms enrolled as a full-time student may be counted as a semester.) Students must submit the Application for Part-time Status to the Registrar's Office at least two weeks before the beginning of the fall or spring semester.

Health insurance, health fee, and social fee are neither pro-rated nor refunded.

After all adjustments have been made, any balance due to WPI is payable immediately.

ROOM & BOARD CHARGES UPON WITHDRAWAL OR SUSPENSION 2018-19

	Charge
1. Withdrawal after enrollment but prior to first day of classes of a semester	Charged 0%
2. Withdrawal weeks 1 & 2	10%
3. Withdrawal week 3	20%
4. Withdrawal week 4	30%
5. Withdrawal week 5	40%
6. Withdrawal weeks 6-8	50%
7. Withdrawal week 9	60%
8. Withdrawal week 10	80%
9. Withdrawal week 11 and after	100%

FINANCIAL AID UPON WITHDRAWAL/SUSPENSION

Students who withdraw or are suspended from WPI and are receiving any type of financial will have their funding adjusted based on their official withdrawal/suspension date and institutional, federal, and state refund calculations. If federal funds are required to be returned to the Federal Department of Education, they will be returned before any other forms of aid and in the following order per federal guidelines: Unsubsidized Federal Direct Loan, Subsidized Federal Direct Loan, Federal PLUS Loan, Federal Pell Grant, and Federal Supplemental Educational Opportunity Grant. WPI Scholarships (merit and/or need based) and WPI Institute Loans are then reduced up to the amount of remaining credit sources. Because each refund calculation is unique to a student's withdrawal date, costs incurred and aid he/she is receiving, students are encouraged to contact the WPI Office of Student Aid & Financial Literacy about their aid adjustments if they have any questions.

WPI is committed to assisting students and their parents in finding ways to finance the cost of a WPI education through financial aid assistance and private financing options. Central to WPI's program is the concept of financial need. This concept is based on the assumption that parents and students together accept the responsibility for educational expenses to the extent they are able. Over 94% of WPI undergraduates are receiving financial help from federal, state, and/or institutional resources (includes need and merit based aid). A combination of grants, loans and/or work study assistance from federal, state and WPI funding are allocated to students who demonstrate financial need. The proportion of grant, or "gift" assistance, versus loan and work, may be determined by the college on the following criteria: the magnitude of the financial need, the student's academic performance, and the availability of funds.

APPLICATION PROCEDURES – PROSPECTIVE STUDENTS

Students are required to file the Free Application for Federal Student Aid (FAFSA) and the CSS (College Scholarship Service) Profile Application. In the case of separation or divorce, the student's noncustodial parent must also complete a CSS Profile. Students list WPI's school code under the section on each form where it designates which schools are to receive the form. In addition, students whose financial aid applications are selected for verification* are required to submit additional documentation for themselves and their parents, if considered dependent. Generally, tax filers are required to either successfully utilize the IRS's Data Retrieval Tool on the FAFSA or submit a copy of their tax return transcript. Non tax filers are required to submit a copy of their W-2 statements as well as a non-filer statement from the IRS.

*Please visit www.wpi.edu/+faverification for more information on the verification process.

EARLY ACTION AND EARLY DECISION APPLICATION FOR FINANCIAL AID

Applicants must indicate on their admission application they are applying for financial aid. For those students applying for early action admission, the CSS Profile Application (and CSS Profile from Noncustodial parent, if applicable) can be submitted as early as October 1st, but no later than the posted Admission application deadlines. The FAFSA and the CSS Profile Application are available online at www.fafsa.gov and www.cssprofile.org.

Successful candidates for early action admission will be notified of financial aid eligibility on a rolling basis. Applicants will then have from the date of their aid eligibility letter until the candidates' common reply date, May 1st, to either accept or decline the aid offered.

REGULAR DECISION APPLICATION FOR FINANCIAL AID

Applicants must indicate on their admission application they are applying for financial aid. Successful candidates for admission will be notified of a financial aid decision in late March if a complete financial aid application has been submitted. Applicants will then have from the date of the financial aid decision until the candidates' common reply date, May 1st, to either accept or decline the aid offered.

To ensure a complete review, the WPI Office of Student Aid & Financial Literacy must receive the FAFSA and the CSS Profile Application by January 15th. Applications completed after this date will be reviewed subject to available funding. The Office of Student Aid & Financial Literacy encourages students to complete the FAFSA and the CSS Profile Application (and CSS Profile from Noncustodial parent, if applicable), when the FAFSA and CSS Profile Application open October 1st to ensure that WPI's filing deadline of January 15th is met.

UPPERCLASS APPLICATION FOR FINANCIAL AID

Upperclass students who receive need based financial aid must reapply for financial aid every year by completing the FAFSA. In a few cases, some upperclass students will also be required to submit the CSS Profile Application in addition to these requirements. Typically, upperclass students who will need to complete the CSS Profile Application are those whose parents are recently separated or divorced, students who are re-admitted to WPI, students whose custodial and noncustodial parents have changed since the prior academic year, and students who did not apply for need based financial aid in the prior academic year. The WPI Office of Student Aid & Financial Literacy reserves the right to request that a CSS Profile Application be completed by any upperclass student applying for need based financial aid.

Filing information on the FAFSA (and CSS Profile Application, if necessary) is due by April 15th. In addition, students whose financial aid applications are selected for verification* are required to submit additional documentation for themselves and their parents, if considered dependent. Generally, tax filers are required to either successfully utilize the IRS's Data Retrieval Tool on the FAFSA or submit a copy of their tax return transcript. Non tax filers are required to submit a copy of their W-2 statements as well as a non-filer statement from the IRS. The complete application provides consideration for grants, scholarships, loans and federal on-campus employment for the following academic year. Students and their parent(s) are expected to obtain and submit all requested forms in a timely manner for each year of planned enrollment. If any of the required forms are submitted late, there will be a delay in the student receiving an eligibility letter and there may be a reduction in his/her grant or scholarship eligibility for the year in which he/she is applying for need based financial assistance. The amount of financial aid upperclass students receive will depend on their academic performance from the prior academic year, their family's demonstrated financial need which is determined from the FAFSA, and the CSS Profile Application, if required.

*Please visit www.wpi.edu/+faverification for more information on the verification process..

TRANSFER STUDENTS

Transfer students may apply for financial aid eligibility beginning with their first term of matriculation and must indicate interest in financial aid on the admission application. Please note that financial aid is not available for part time or international (non-U.S. citizen) transfer students. Transfer aid applications will be reviewed based on the same documentation required for first year applicants and are packaged on a funds available basis. The FAFSA and CSS Profile (and CSS Profile from Noncustodial parent, if applicable) are due by May 15.

In addition, students whose financial aid applications are selected for verification* are required to submit additional documentation for themselves and their parents, if considered dependent. Generally, tax filers are required to either successfully utilize the IRS's Data Retrieval Tool on the FAFSA or submit a copy of their tax return transcript. Non tax filers are required to submit a copy of their W-2 statements as well as a non-filer statement from the IRS.

*Please visit www.wpi.edu/+faverification for more information on the verification process.

FORMS OF AID

FEDERAL PELL GRANTS

Federal Pell Grants are awarded to high need students from low and lower middle-income families. For the 2019-20 academic year these grants range from \$657 to \$6,195 per academic year. A Student Aid Report (SAR) is sent electronically to all students who file a Free Application for Federal Student Aid (FAFSA). The WPI Office of Student Aid & Financial Literacy will verify the data on the form, making corrections if necessary.

FEDERAL SUPPLEMENTAL EDUCATIONAL OPPORTUNITY GRANTS (FSEOG)

Federal SEOG funds are allocated to institutions by the Federal government. These funds, which are awarded to students as campus based grants, are awarded to high need students who are also eligible for the Federal Pell Grant.

FEDERAL DIRECT STUDENT LOAN

There are two types of Federal Direct Loans offered to students by the federal government: the Federal Direct Subsidized Loan and the Federal Direct Unsubsidized Loan. A student's federal financial need will determine which loan(s) he/she will be offered in the financial aid award.

Federal Direct Subsidized Loans are loans on which the federal government pays the interest while the student is enrolled in school at least half time and during periods of grace.

Students not eligible for the Federal Direct Subsidized Loan may borrow through the Federal Direct Unsubsidized Stafford Loan Program. In the Unsubsidized Loan Program, the federal government does not pay the interest on the loan. Rather, the student has the option to either pay the interest or capitalize it and postpone repayment of principal and interest until after graduation or falling below at least half time enrollment.

Repayment of both principal and interest for the Subsidized and Unsubsidized Federal Direct Loans begins at the end of the 6 month "grace period" following the last day of enrollment or withdrawal from school. Students have ten years to repay their Federal Direct Loans.

Students must file a FAFSA so that WPI can determine need-based eligibility for the Federal Direct Loan. The federal government sets annual borrowing limits according to the student's year in school or grade level. As of the 2012-13 academic year, first year students may borrow up to \$3,500, second year students up to \$4,500 and third and fourth year students up to \$5,500. Students cannot borrow in excess of \$23,000 over the life of their undergraduate education. All qualifying students may also borrow \$2,000 in the Unsubsidized Loan per year.

The WPI Office of Student Aid & Financial Literacy recommends and approves the amount a student may borrow for the Subsidized and Unsubsidized Federal Direct Loan. For all new borrowers, a Master Promissory Note (MPN) must be completed. This may be done electronically or on paper. Students will be notified of the availability of the note to be signed. The Master Promissory Note only needs to be signed once during the student's undergraduate time at WPI.

FEDERAL WORK STUDY PROGRAM

Federal Work Study (FWS) funds are allocated annually to colleges who offer federally funded work opportunities to high need financial aid applicants. FWS is included in the financial aid eligibility letter to students if they qualify for these funds. If a student accepts a FWS offer, he/she may work a maximum of 10 hours per week at the current MA State minimum wage.

Students who are awarded and accept the FWS funding are expected to complete 15 hours of community service during the academic year. In order to meet this requirement, students can obtain information on various community service opportunities from the WPI Student Activities Office (SAO). Approval of community service sites and hours of work must be granted by the WPI Office of Financial Aid or the Student Activities Office before students can begin work.

Students awarded FWS funding can choose to do one of the following:

1. Work on campus in an academic or administrative office during the academic year. During the year, the student also needs to work in a WPI SAO approved community service position for fifteen hours. The WPI SAO will work with students to find available opportunities to meet this requirement.
2. Work on or off campus in a WPI SAO approved community service position during the academic year. Students who work during the academic year in a community service position will meet their required 15 hours of community service in this position.

Obtaining a FWS position (and the required 15 hours of community service) either on or off campus is the responsibility of the student. Available FWS positions are posted at the beginning of each academic year on the WPI Human Resources Website: <https://www.wpi.edu/student-experience/resources/student-employment>. FWS earnings are paid by direct deposit on a bi-weekly basis to the student employee; they cannot be deducted from your tuition bill. Work is available in a variety of academic, administrative, or community service settings on and off campus. The off campus positions are community service positions and must be set up through SAO. Students who work in community service positions are paid current MA State minimum wage per hour in order to cover travel expenses to and from their jobs. The amount of FWS funds offered in a student's award letter indicates maximum earnings allowed, but is not a guarantee. The best procedure is to take an available position at the start of the academic year and work as much as the schedule allows up to the maximum 10 hours per week. If a student declines an offer of work, it will not affect the other components of his/her award package. However, please note that due to limited funding, if a student declines FWS funding or employment, this fund will not be renewed in future academic years. In addition, if a student earns less than \$500 in

FWS funds during the academic year this fund is awarded or fails to complete the required 15 hours in community service, his/her FWS funding will not be renewed in future years. Please note that you can also lose your eligibility for FWS funds in future years if your financial need decreases or you do not meet the financial aid application deadline.

Students are prohibited from FWS employment if one of the following situations occurs: the student falls below the WPI established satisfactory academic progress levels for retention of aid, the student enrolls on a less than full time basis, or the student registers as a part-time/"Special Student."

STATE SCHOLARSHIP PROGRAMS

The MASSGrant is awarded to Massachusetts residents whose combined family contribution falls within state-determined parameters. Students must file the FAFSA by the state-designated deadline and follow all state program procedures to apply.

Massachusetts has reciprocity agreements with Pennsylvania and Vermont. These states allow their residents attending institutions in Massachusetts to "carry" need-based state grants into Massachusetts. Awarding from other state scholarship programs depends on annual state funding levels.

The Massachusetts Gilbert Matching Grants Program is allocated annually to WPI. These funds are awarded to Massachusetts residents who fall within a certain financial need.

STATE FUNDED STUDENT LOAN PROGRAMS

The Commonwealth of Massachusetts provides the Massachusetts No Interest Loan (MA NIL) Program through annual allocations to participating colleges and universities. Students who file the FAFSA and meet state eligibility criteria are eligible for the Massachusetts No Interest Loan on a funds available basis.

WPI COLLEGE SCHOLARSHIP

WPI awards College Scholarships and other restricted or endowed "gift" assistance, to students who have a demonstrated financial need based on review of the completed financial aid application, including the FAFSA, the CSS Profile Application (if first year applicant), IRS Data Retrieval Tool, and W-2 forms (if selected for verification). WPI gift aid may be combined with federal and state grants to make up a student's total portion of "gift" assistance, before loans and work are packaged.

WPI INSTITUTE STUDENT LOAN PROGRAM

The WPI Institute Loan is an institutional need-based loan awarded to students. Repayment of the principal and interest begins 9 months after the last day of enrollment or withdrawal from college.

FEDERAL DIRECT PLUS LOANS

Federal Direct PLUS Loans are available annually to parents of dependent undergraduate students. Repayment begins when the funds are advanced to the school with the option to defer repayment until after the student graduates or falls below half time enrollment status. Parents have 10 years to repay the Federal Direct PLUS Loan.

WPI DEPARTMENT-FUNDED WORK PROGRAM

Students who are not eligible for Federal Work Study funds may seek employment opportunities through departments or offices on campus that set aside funds for hiring undergraduate employees. These employment funds vary from year to year in terms of monies available or the number of students allowed per department/office. Students may also inquire about department-funded summer positions on campus.

FINANCIAL AID POLICIES

Financial aid is awarded one year at a time. Aid applicants are required to reapply annually by the beginning of Term D. An annual review of each applicant's financial need is assessed to assure that aid is renewed equitably as different circumstances cause needs to change. The WPI Office of Student Aid & Financial Literacy determines a student's financial need through a review of the completed financial aid application. Financial aid eligibility letters are mailed to upperclass students in early July for the following academic year.

STUDENT CONTRIBUTION

It is expected that the student's family will contribute its maximum financial effort and that the student will also make a maximum effort through savings from annual earnings and by accepting a proportion of financial aid in the form of loans and/or in-school employment, if eligible. Students at WPI are expected to contribute a minimum \$2,750 each academic year from summer or other annual earnings. While this minimum student contribution is used, the WPI Office of Student Aid & Financial Literacy must review previous calendar year student earnings and student savings/assets as the basis for determining the annual student contribution.

INDEPENDENT/DEPENDENT STUDENT STATUS

WPI believes that the primary responsibility for an undergraduate education lies with the student and parent(s), to whatever extent possible. Therefore, all undergraduates applying for WPI institutional funds are required to provide parental information regardless of federal dependency status.

Although a student may meet federal guidelines to be considered an independent student, and therefore receive federal funds as an independent student, the ability of parents to assist their children, regardless of age and dependency status, is a factor WPI considers in determining eligibility for institutional need-based grants. Because of this, the WPI Office of Student Aid & Financial Literacy will require parental information from all students applying for need based institutional aid.

AID RETENTION/PROGRESS TOWARD A DEGREE

There are four key elements to the retention of eligibility for Institutional (WPI) financial aid as it relates to academics:

1. All full time students are expected to register and enroll in 36 credits per academic year*. Students must pass a minimum of 33 academic credits to keep the same level of funding the following year. Please note that AP courses, transfer credit, incompletes or extensions cannot be counted in the number of credits passed. The student is responsible for resolving any incomplete grades with the faculty member assigning the grade.

Federal and/or State Financial Aid

For retention of federal and/or state financial aid funding. Please refer to these aid policies at <https://www.wpi.edu/admissions/tuition-aid/applying-for-aid/policies>.

WPI Need Based Scholarships

WPI need based scholarships awarded to students will not increase in future academic years regardless of changes in a student's financial need. However, student's WPI need based scholarships can decrease based on a lower financial need and/or poor academic performance (from the prior academic year).

WPI Merit Scholarships

WPI merit scholarships will not increase or decrease based on changes to a student's financial need. However, a student's merit scholarship will decrease or be eliminated if a student does not pass a minimum of 33 academic credits per year.

2. Eligibility for consideration for all types of financial aid for the following academic year is lost if a student is placed on Academic Probation (end of B or D term).

Financial Aid Appeals

Students placed on Academic Probation or Federal Financial Aid Suspension may, in cases which involve unusual and extenuating circumstances such as documented medical problems, file a financial aid petition with the WPI Office of Student Aid & Financial Literacy. Financial Aid Appeals can be obtained in the WPI Office of Student Aid & Financial Literacy (2nd floor Bartlett Center) or online at <https://www.wpi.edu/+faforms>. The petition will be reviewed by the Financial Aid Appeal Committee. Determination on financial aid appeals will be made on a case by case basis.

3. Regardless of academic progress status, eligibility for WPI financial assistance is available for the shorter of the two following periods: 16 terms (4 years) of enrollment at WPI, as a full time or part time student, (NOT 16 terms of receiving financial aid), or completion of your Bachelor Degree requirements at WPI.
4. Students must be enrolled full time to be eligible for WPI need based and merit based scholarship funding, as well as most federal and state grant programs and work study. A student is considered to be a full time student if they are being charged full time tuition and fees. Students are responsible for knowing their enrollment status and should enroll in the number of credits per year necessary to maintain their aid eligibility.

PLEASE NOTE: With the exception of the Federal Direct Loan, the Global Scholar Stipend, and the Foisie Scholar Stipend programs, financial aid is not available for enrollment during term E (Summer School) at WPI. This includes all forms of assistance including WPI Merit Scholarships. If you enroll during term E and borrow a Federal Direct Loan, the amount you borrow will be reduced from your Federal Direct Loan eligibility for the next academic year (terms A-D).

**there are exceptions such as students on an approved reduced course load. Please contact the Office of Student Aid & Financial Literacy if you have concerns.*

INTERNATIONAL STUDENTS

International students (who do not have official documentation of Permanent Residence Status in the United States) are ineligible for all sources of federal and state aid administered by the WPI Office of Student Aid & Financial Literacy. Limited scholarships are available for entering international students through the WPI Office of Student Aid & Financial Literacy.

ALTERNATIVE FINANCIAL PROGRAMS

Alternate financing programs are available to many students and their families who do not apply for aid or who need additional resources beyond federal, state, and institutional financial aid offered. WPI offers the TMS (Tuition Management Systems) payment plan which allows parents to pay their annual charges over 12 months rather than in two semester payments. Students and parents are encouraged to contact the WPI Bursar's Office for further information on the TMS payment plan option.

There are many long-term financing programs available to assist students and their families in spreading their educational costs over 10 to 20 years. Many of these loans allow students and their families to borrow the difference between the cost of attendance determined by the college and total financial aid received for the academic year.

Please contact the WPI Office of Student Aid & Financial Literacy or visit <https://www.wpi.edu/admissions/tuition-aid/types-of-aid/loans-financing>.

FEDERAL PLUS LOANS

Federal PLUS Loans are available annually to parents of dependent undergraduate students. Repayment begins when the funds are advanced to the school with the option to defer repayment until after the student graduates or falls below half time enrollment status. Parents have 10 years to repay the Federal PLUS Loan.

RESERVE OFFICER TRAINING CORPS (ROTC) SCHOLARSHIPS**ARMY ROTC SCHOLARSHIP PROGRAM**

For information on Army ROTC Scholarships, please contact the Army ROTC office at WPI at (508) 831-5268.

NAVAL ROTC SCHOLARSHIP PROGRAM

For information on Navy ROTC Scholarships, please contact the Naval ROTC Unit at Holy Cross College in Worcester (508) 832-2433.

AIR FORCE ROTC SCHOLARSHIP PROGRAM

For information on Air Force ROTC Scholarships, please contact the WPI Department of Aerospace Studies at WPI at (508) 831-5747.

PLEASE NOTE THE COMBINATION OF ALL SOURCES OF AID CANNOT EXCEED A STUDENT'S BUDGETED COST OF ATTENDANCE.

RESIDENCE HALLS

WPI provides its undergraduate students with a variety of housing options. The WPI residence halls offer first year students a choice of single, double, triple, and quadruple occupancy rooms as well as suites designed for four to eight persons.

Residence hall living at WPI offers opportunities that can be a valuable part of higher education. For this reason, on-campus housing is required for all first-year students. First-year students admitted for Term A, who meet all application deadlines, are guaranteed housing in the residence halls for that entire academic year.

There are also a variety of on campus upperclass student housing options. These include three, four, five and seven person apartments, residential houses, as well as traditional residence hall environments. Off campus housing alternatives include rooms in homes, apartments and community from home. Additionally for Fraternity and Sorority members there is Greek Chapter Housing available. Upperclass students are not guaranteed on-campus housing. The Housing and Dining Contract is a legally binding contract which extends from the beginning of Term A through Term D as long as the student is enrolled at WPI.

RESIDENCE HALL STAFF

Resident Advisors (RAs) are the core of the residential life staff in the residence halls. RAs serve as a source of assistance in resolving students' academic, personal, and social concerns. They plan and implement social and educational programs in the halls, and enforce all WPI policies and regulations in an effort to develop an effective living-learning environment in the residence halls.

The administrative responsibility for the operation of the residence halls rests with the professional staff in Residential Services. They counsel and advise students, work with maintenance and dining hall staffs, and handle many administrative processes for students living on campus.

OCCUPANCY

Residence halls normally open at 9:00 a.m. four days before Term A begins and close at 12:00 noon two days after the last day of classes for Term D. Housing and food service privileges are not transferable, nor may any person take up de facto residence without paying rent. The traditional residence halls will be closed during the December recess period. Apartment style residence halls remain open during the December recess period, but students must register to maintain access.

FURNISHINGS AND FACILITIES

Students are responsible for the neatness and cleanliness of their rooms. Residence halls are furnished with a twin-size bed, a desk and chair, closet space, and drawer space for each student. All residence halls are smoke free environments. Data network services and cable television are included in room rates. Residents provide their own pillows, linens, blankets, and other personal furnishings.

ID Card and Coin-operated laundry facilities are available on the campus.

The following are some of the things not permitted in the residence halls:

- Sale, use or possession of illegal drugs
- Pets, except small fish
- Refrigerators larger than 4.3 cubic feet in size, 3D printers
- Gambling
- Use of alcoholic beverages in violation of Massachusetts State Laws
- Firearms, weapons, explosives, incendiary or toxic chemicals, starting pistols, paint ball guns, knives
- Cooking, except in kitchen areas provided
- Candles or other flame-emitting devices
- Smoking of any kind

For a complete copy of the housing and dining contract, please visit the WPI website.

Mail and express packages should be addressed to the student by name, and box number, WPI, 100 Institute Road, Worcester, MA 01609-2280.

ROOMMATES

One of the most memorable aspects of campus life can be the relationship you will build with your roommate(s). Roommates often find that a meaningful relationship is developed through the sharing of thoughts and feelings; in other words, communication. We encourage you to be as open as possible so that you and your roommate can begin early to create a relationship based on respect and understanding. This relationship can help make residence hall living one of the most enjoyable part of your college career.

ROOM CHARGES

Since room and board rates for 2020-2021 were not established at the time of this publication, they will be announced separately.

Room Rates for 2019-2020

(Note: Room rates listed are for the entire academic year)

RESIDENCE HALLS	FULL YEAR
Daniels, Institute, Morgan, Riley, Messenger, Stoddard, Founders, Trowbridge	
Double, Triple, Quad	\$8,736
Single	\$9,242

East and Faraday Halls

Double	\$9,778
Single	\$10,208
Studio	\$10,342

APARTMENTS	FULL YEAR
Triple	\$8,856
Double	\$9,334
Single	\$9,850

Note: Each apartment, East and Faraday location, is equipped with basic furnishings including stove and refrigerator.

RESIDENTIAL HOUSING FULL YEAR**Elbridge, Hackfield, Schussler**

Triple	\$8,856
Double.	\$9,334
Single	\$9,850

Payment for housing and food service fees are made in two installments, one each at the beginning of Terms A and C. Reduced charges, if applicable, will be processed according to the established withdrawal policy of the college. Students entering the residence halls other than at the beginning of Term A or C will be issued a prorated billing for the period. This bill must be paid in full prior to occupancy.

Students are expected to care for the physical facilities of the residence halls. Damage to the facilities beyond the normal wear and tear shall be the financial responsibility of the residents. Damage to common areas of the residence halls will be divided among residents of that wing, floor, or building.

First year students can expect to receive a link to the Housing and Dining Application in June, after their \$500 tuition deposit is received by the Office of Admissions.

First Year students should be prepared to select their housing through the online housing selection service in early to mid-July.

MEALS

Students residing in Morgan, Daniels, Riley, Stoddard, Trowbridge, Messenger, Institute and Founders are required to participate in one of the four meal plans. All other students are welcome to purchase a meal plan as well. The MEALS PLUS PLANS are a combination of traditional meal plans plus additional funds to be utilized at the student's discretion.

Once a student has contracted for food service, this is a legally-binding agreement, and students are obligated to assume financial responsibility for the entire academic year.

Board Plan Rates for the 2019-2020 academic year

(Note: Students are required to be on a meal plan for the entire academic year)

MEAL PLAN	BONUS POINTS	FULL YEAR
19	\$75 Bonus Points (per semester)	\$6,566
14	\$175 Bonus Points (per semester)	\$6,566
Gompei 200	\$100 Bonus Points (per semester)	\$6,566
VIP	\$100 in Bonus Points (per semester)	\$7,660

Descriptions of the board plans are available at:

<http://www.dineoncampus.com/wpi>

OFF-CAMPUS LIVING

After the first year, on-campus housing is not guaranteed, so if you decide to look for an off-campus apartment, make plans well in advance. Information is available on the WPI website for you to research questions about small claims court, housing codes, leases, tenants' rights, etc. The following are a few hints for you as you begin your search for off-campus housing.

Leases: Contract periods for off-campus housing vary in length, from twelve-month and nine-month to summer only and three-month leases. As you consider various places, find out what types of leases are available.

Be Prepared: You'll want to plan realistically for expenses such as utilities, transportation, repairs, laundry, and food. Also, try to pick your roommates carefully and ahead of time.

LODGING LAWS

You should also be aware that the City of Worcester has a zoning code that prohibits more than three unrelated persons living together unless the landlord or owner has obtained a lodging house license .

TRUSTEES ADMINISTRATION AND FACULTY

SECTION 8

Trustees, Administration and Faculty	254
Trustees	254
Administration	256
Faculty	257
Index	280
Policies & Practices	284
Currency of Information	284
Accreditation	285
Directions	285
Campus Map	286

TRUSTEES

The administration of the college is entrusted to a Corporation consisting of not less than 12 members, consisting of life, ex-officio, at-large and alumni members. Emeriti members are elected by the Corporation in an advisory capacity. (Dates in parentheses following each name indicate year of election to membership.)

OFFICERS OF THE CORPORATION

JOHN T. MOLLEN
Chair

JOYCE KLINE '87
Vice Chair

ANDREW ABERDALE '89
Vice Chair

LAURIE A. LESHIN
President

JEFFREY S. SOLOMON
Treasurer

DAVID BUNIS
Secretary

CURRENT MEMBERS

ANDREW ABERDALE '89 (2015)
Chief Financial and Administrative Officer
Target Logistics Management

JOSEPH ADAMS '75 (2016)
Retired President
MWH Global Inc.

MICHAEL E. ASPINWALL '75 (2015)
Managing Partner
CCP Equity Partners

JAMES P. BAUM '86 (2013)
Venture Partner
OpenView Venture Partners

LORRAINE BOLSINGER (2017)
Retired Vice President, XLP Accelerated Leadership Program
General Electric Company

LINWOOD BRADFORD '89 (2018)
Chairman and CEO
Conning

MICHAEL DOLAN '75 (2006)
Retired Senior Vice President
Exxon Mobil Corp.

HENRY FITZGERALD '75 (2012)
Retired Vice President
Genzyme Biotechnology

WILLIAM FITZGERALD III '83 (2013)
Vice President and General Manager
GE Aviation

MARNI HALL '97 (2016)
Vice President, Clinical Evidence
IQVIA

ROBERT HART '79 (2015)
President and CEO
Trumerica Multifamily

JEREMY HITCHCOCK '04 (2017)
Founder and CEO
Minim

DEBORA JACKSON '89 (2011)
Director, Lifelong Learning
Yale Divinity School

STUART C. KAZIN '61 (2009)
Retired Vice President
Lotus Development/IBM Corporation

CARLETON KILMER '64 (2016)
Retired Senior Partner
Accenture

JOYCE KLINE '87 (2016)
Managing Director
Accenture

DAVID LAPRE '74 (2015)
President
DGL Advisors, LLC

FRANCESCA MALTESE (2008)
Retired Development Manager
The O'Connell Development Group

ROBERT R. MARTIN '75 (2007)
Owner
ZizWiz Consulting

ERICA MASON '96 (2013)
Artist

NEIL McDONOUGH (2011)
President and CEO
Flexcon Company, Inc.

LINDA MCGOLDRICK (2008)
Chief Executive Officer
Zillion Group

JOHN T. MOLLEN (2007)
Retired EVP, Human Resources
EMC Corporation

DANIEL MORGAN (2015)
President
Lighthouse 888 LLC

GEORGE OLIVER '82 (2011)
Chairman and CEO
Johnson Controls

MARK O'NEIL '80 (2017)
Retired Executive Vice President & COO
Cox Automotive

KAREN M. TEGAN PADIR '90 (2008)
Chief Product Officer
Wood Mackenzie

STEPHEN RUSCKOWSKI '79 (2019)
Chairman, President & CEO
Quest Diagnostics

MARK E. RUSSELL (2015)
Vice President of Engineering, Technology and Mission Assurance
 Raytheon Company

JOAN SZKUTAK '79 (2011)
Managing Partner
 JB Szkutak Consulting LLC

DOROTHEA C. WONG '92 (2008)
Executive Director, Global Operations Supply Chain
 Collins Aerospace

EX-OFFICIO MEMBER

LAURIE A. LESHIN (2014)
University President

TRUSTEES EMERITI

PAUL W. BAYLISS '60 (1989)
 Dover, NH

ROBERT H. BECKETT '57 (1986)
 Blue Bell, PA

CURTIS R. CARLSON '67 (2002)
 Portola Valley, CA

THOMAS A. CORCORAN (1993)
 Potomac, MD

RICHARD A. DAVIS '53 (1977)
 West Lebanon, NH

WILLIAM A. DELPHOS '74 (1984)
 McLean, VA

MICHAEL A. DIPIERRO '68 (1994)
 Naples, FL

WARNER FLETCHER (1994)
 Worcester, MA

ANSON C. FYLER '45 (1972)
 Vero Beach, FL

JOHN J. GABARRO '61 (1987)
 Boston, MA

BARBARA J. B. GATISON '74 (1990)
 Lehigh Acres, FL

CLAIRE L. GAUDIANI (2001)
 New York, NY

STEVEN C. HALSTEDT '68 (2003)
 Englewood, CO

JAMES N. HEALD, II (1967)
 Worcester, MA

DAVID HEEBNER (1994)
 Naples, FL

JOHN E. HOSSACK '46 (1965)
 Marblehead, MA

M. HOWARD JACOBSON (1977)
 Westborough, MA

PAUL J. KEATING, II '64 (1992)
 Leominster, MA

PAUL S. KENNEDY '67 (1998)
 Worcester, MA

GORDON P. LANKTON (1980)
 Worcester, MA

ARTHUR J. LOVETERE '60 (1989)
 Atlanta, MI

CLAUDE P. MANCEL '71 (1992)
 Belgium

F. WILLIAM MARSHALL JR. (1986)
 Palm City, FL

ALFRED A. MOLINARI, JR. '63 (1996)
 Southborough, MA

PHILIP MORGAN (1994)
 Boston, MA

JUDITH NITSCH '75, HON '15 (1989)
 Weston, MA

DAVID P. NORTON '62 (1990)
 Concord, MA

JOHN F. O'BRIEN (1991)
 Needham, MA

STANLEY C. OLSEN (1975)
 Lecanto, FL

DONALD K. PETERSON '71 (1997)
 Annapolis, MD

WINDLE B. PRIEM '59 (1991)
 Palm Beach, FL

CAROL L. REINISCH (1987)
 Falmouth, MA

DONALD E. ROSS '54 (1985)
 Manchester, NH

FREDERICK D. RUCKER '81 (1996)
 Oakton, VA

PHILIP B. RYAN '65 (1999)
 Bedford, NH

JOHN J. SHIELDS (SIM '69) (1990)
 Naples, FL

GORDON H. SIGMAN, JR. '59 (1988)
 Port St. Lucie, FL

H. KERNER SMITH (1993)
 Falmouth, MA

GLENN YEE '74 (1999)
 Hong Kong

RONALD L. ZARRELLA '71 (1988)
 Rochester, NY

MICHAEL P. ZARRILLI '71 (1999)
 Greenwich, CT

DONALD P. ZERESKI (SIM '74) (2002)
 Northborough, MA

ADMINISTRATION

Numerals following name indicate year(s) of initial appointment.

LAURIE A. LESHIN (2014)

University President

B.S., Arizona State University, 1987;

M.S., California Institute of Technology, 1989; Ph.D., 1994.

DAVID A. BUNIS (2017)

Senior Vice President and General Counsel

Secretary of the Corporation

B.A., Brandeis University, 1983;

J.D., Boston University, 1987.

PHILIP N. CLAY (1993)

Vice President, Student Affairs

B.A., St. Lawrence University, 1982;

M.A., Binghamton University, 1986.

MAUREEN DEIANA (2010)

Assistant Vice President, Chief Marketing Officer

B.S., Lesley University, 1993.

DANA L. HARMON (2002)

Director, Physical Education, Recreation and Athletics

B.A., Bellarmine College, 1987;

M.S., University of Massachusetts/Amherst, 1994.

MICHELLE JONES-JOHNSON (2016)

Vice President for Talent Development and Chief Diversity Officer

B.A., University of Michigan, 1989;

M.A., University of Phoenix, 1995;

M.B.A., Syracuse University, 2010.

WILLIAM J. MCAVOY (2011)

Vice President for University Advancement

B.S. University of Connecticut, 1978;

M.P.A., Suffolk University, 1987.

AMY M. MORTON (2010)

Vice President, Chief of Staff

B.A., Providence College, 1990.

PATRICIA L. PATRIA (2018)

Vice President for Information Technology and

Chief Information Officer

M.B.A., Suffolk University.

JEFFREY S. SOLOMON (2005)

Executive Vice President/CFO

Treasurer of the Corporation

B.S., Bentley College, 1985;

M.S., Brandeis University, 2001.

WINSTON O. SOBOYEJO (2016)

Senior Vice President and Provost, Ad Interim

B.sc., King's College, London, 1985;

Ph.D., Churchill College, Cambridge University, England, 1988.

BOGDAN M. VERNESCU (1991)

Vice Provost for Research

Professor, Mathematical Sciences

B.S., University of Bucharest, 1982; M.S., 1982;

Ph.D., Institute of Mathematics - Bucharest, 1989.

ACADEMIC AFFAIRS

TERRI ANNE CAMESANO (2000)

Dean of Graduate Studies;

Professor, Chemical Engineering

B.S., University of Rochester, 1995;

M.S., University of Arizona, 1997;

Ph.D., Pennsylvania State University, 2000.

ARTHUR C. HEINRICHER, JR. (1992)

Dean of Undergraduate Studies;

Professor, Mathematical Sciences

B.S., University of Missouri/St. Louis, 1980;

Ph.D., Carnegie Mellon University, 1986.

JEAN KING (2017)

Peterson Family Dean of Arts and Sciences;

Professor of Biology and Biotechnology

B.S., St. Francis College, Brooklyn 1979;

M.S., City University of New York 1982;

Ph.D., New York University 1988.

JOHN A. MCNEILL (1994)

Professor, Electrical and Computer Engineering,

and Interim Dean of Engineering

A.B., Dartmouth College, 1983;

M.S., University of Rochester, 1991;

Ph.D., Boston University, 1994.

KENT RISSMILLER

Dean, Interdisciplinary and Global Studies Division, ad interim;

Associate Professor, Social Science and Policy Studies

A.B., Muhlenberg College, 1976;

J.D., Franklin Pierce Law Center, 1980;

M.A., Syracuse University, 1981; Ph.D., 1986.

WINSTON O. SOBOYEJO (2016)

Bernard M. and Sophia Gordon Dean of Engineering;

Professor, Mechanical Engineering and Biomedical Engineering

B.Sc., King's College, London, 1985;

Ph.D., Churchill College, Cambridge University, England, 1988.

STEVEN S. TAYLOR (2002)

Professor and Dean ad interim Foisie Business School

B.S., MIT, 1982;

M.A., Emerson College, 1993;

Ph.D., Boston College, 2000.

RICHARD F. VAZ (1983)

Co-Director, Center for Project-Based Learning;

Professor, Electrical and Computer Engineering and IGSD

B.S., Worcester Polytechnic Institute, 1979;

M.S., 1984; Ph.D., 1987.

BOGDAN M. VERNESCU (1991)

Vice Provost for Research;

Professor, Mathematical Sciences

B.S., University of Bucharest, 1982; M.S., 1982;

Ph.D., Institute of Mathematics - Bucharest, 1989.

SUZANNE L. WEEKES (1998)

Interim Associate Dean of Undergraduate Studies

Professor, Mathematical Sciences

B.S., Indiana University, 1989;

M.S., University of Michigan, 1990; Ph.D., 1995.

KRISTIN K. WOBBE (1995)
Co-Director of the Center for Project Based Learning and Director of the Great Problems Seminars Program
Professor, Chemistry and Biochemistry
 B.A., St. Olaf College, 1983;
 Ph.D., Harvard University, 1991.

ACADEMIC DEPARTMENT HEADS

LT COL JACK SKILES III

Air Force Aerospace Studies

JOSEPH B. DUFFY

Biology and Biotechnology

KRISTEN BILLIAR

Biomedical Engineering

DIANE M. STRONG, AD INTERIM

Business

SUSAN ROBERTS

Chemical Engineering

ARNE GERICKE

Chemistry and Biochemistry

CARRICK EGGLESTON

Civil and Environmental Engineering

CRAIG E. WILLS

Computer Science

DONALD R. BROWN, AD INTERIM

Electrical and Computer Engineering

ALBERT SIMEONI

Fire Protection Engineering, ad interim

KATHRYN MONCREIF

Humanities and Arts

LUCA CAPOGNA

Mathematical Sciences

JAMAL S. YAGOOBI

Mechanical Engineering

LTC ADAM D. HEPPE

Military Science

DANA L. HARMON

Physical Education

DOUGLAS T. PETKIE

Physics

EMILY M. DOUGLAS

Social Science and Policy Studies

FACULTY

(As of January 2018)

Numerals following name indicate year(s) of initial appointment.

Generally, in this listing, faculty with the titles “associate professor” or “professor” are tenured, and with the title “assistant professor” are on the tenure track. Faculty with titles other than these three are full-time but not tenured or tenure track.

CURTIS ABEL (2015)

Professor of Practice

B.S., M.E., Ph.D., Carnegie Mellon University; 1985, 1991;

Postdoctoral Fellow in Engineering Design, Cambridge

University, 1994;

M.B.A., Cornell University 2000.

JONATHAN P. ABRAHAM (2004)

Professor of Practice, Mathematical Sciences

B.S. University of Iowa, 1980;

F.S.A., Society of Actuaries, 1991.

LAILA ABU-LAIL (2011)

Assistant Teaching Professor, Civil and Environmental Engineering

B.S., Jordan University of Science and Technology, Jordan, 2003;

M.S., Worcester Polytechnic Institute, 2006;

Ph.D., Worcester Polytechnic Institute, 2011.

DAVID S. ADAMS (1984)

Professor, Biology and Biotechnology

B.S., Oklahoma State University, 1974;

M.S., University of Houston, 1976;

Ph.D., University of Texas, 1979.

WILLIAM A. B. ADDISON, JR. (1986)

Associate Professor, Humanities and Arts

B.A., University of South Carolina, 1965;

M.A., University of Virginia, 1967;

M.Phil., Columbia University, 1974; Ph.D., 1986.

MAHDI AGHELI-HAJIABADI (2013)

Assistant Research Professor, Mechanical Engineering

B.Sc., Isfahan University of Technology, Iran, 2006;

M.Sc., Tarbiat Modares University, Iran, 2009;

Ph.D., Worcester Polytechnic Institute, 2013.

EMMANUEL O. AGU (2002)

Professor, Computer Science

B.Eng., University of Benin, Nigeria, 1994;

M.S., University of Massachusetts/Amherst, 1996; Ph.D., 2001.

JOSEPH R. AGUILAR (2018)

Assistant Teaching Professor, Humanities and Arts

B.A., Westmont College, 2001;

M.F.A., Oregon State University, 2007;

Ph.D., University of Missouri, 2013.

LEONARD D. ALBANO (1992)

Associate Professor, Civil and Environmental Engineering

B.S., Tufts University, 1982;

M.S., Northwestern University, 1983;

Ph.D., Massachusetts Institute of Technology, 1992, P.E.

DIRK ALBRECHT (2013)

Associate Professor, Biomedical Engineering

B.S., University of California-San Diego, 1997;

M.S., 2001; Ph.D., 2005.

- SAKTHIKUMAR AMBADY (2013)
Associate Teaching Professor, Biomedical Engineering;
Director, MQP Labs and Undergraduate Teaching Facilities
D.V.M., Andhra Pradesh Agricultural University, India, 1984;
Ph.D., University of Massachusetts, Amherst, 1996.
- MIHNEA ANDREI (2019)
Post-Doctoral Scholar, Mathematical Sciences
B.S., Worcester Polytechnic Institute, 2014;
M.Sc., Worcester Polytechnic Institute, 2014;
Ph.D., University of California at Santa Barbara, 2019
(expected)
- DIRAN APELIAN (1990)
Professor, Mechanical Engineering;
Howmet Professor of Engineering;
Director, Metal Processing Institute
B.S., Drexel University, 1968;
Sc.D., Massachusetts Institute of Technology, 1972.
- PADMANABHAN K. ARAVIND (1984)
Professor, Physics
B.S., Delhi University (India), 1971; M.S., 1973;
Ph.D., Northwestern University, 1980.
- I LT. CYNTHIA L. ARCHAMBEAU (2016)
Air Force and Aerospace Studies
B.S., UMASS Amherst, 2012.
- JOSÉ M. ARGÜELLO (1996)
Professor, Chemistry and Biochemistry;
Walter and Mariam B. Rutman Distinguished;
Professorship in Chemistry
B.S., National University of Cordoba, Argentina, 1979;
Ph.D., National University of Rio Cuarto, Argentina, 1985.
- ANDREA ARNOLD (2017)
Assistant Professor, Mathematical Sciences
B.S., Duquesne University of the Holy Spirit, 2009;
Ph.D., Case Western University, 2014.
- HOLLY K. AULT (1983)
Associate Professor, Mechanical Engineering
B.S., Worcester Polytechnic Institute, 1974; M.S., 1983;
Ph.D., 1988.
- MARJA BAKERMANS (2013)
Associate Teaching Professor, Global School and Biology and
Biotechnology
B.S., Bucknell University, 1996;
M.S., The Ohio State University, 1996; Ph.D., 2008.
- THOMAS BALISTRIERI (2015)
Assistant Teaching Professor, Interdisciplinary and Global Studies
M.A., Pacific Lutheran University, 1975;
Ph.D., Mississippi State University, 1981.
- ISA BAR-ON (1982)
Professor, Mechanical Engineering
B.S., Hebrew University of Jerusalem, 1974;
M.S., 1977; Ph.D., 1984.
- SCOTT BARTON (2012)
Associate Professor, Humanities and Arts
B.A., Colgate University, 1998;
M.M., Brooklyn College Conservatory of Music, 2006;
Ph.D., University of Virginia, 2012.
- JOSEPH E. BECK (2008)
Associate Professor, Computer Science
B.S., Carnegie Mellon University, 1993;
Ph.D., University of Massachusetts, Amherst, 2001.
- MELISSA BELZ (2013)
Associate Teaching Professor, IGSD
B.S., University of Massachusetts, 1995;
M.A., Oxford Brooks University, 2000;
Ph.D., Kansas State University, 2012.
- JOHN A. BERGENDAHL (2000)
Associate Professor, Civil and Environmental Engineering
B.S., University of Connecticut, 1985; M.S., 1996;
Ph.D., 1998.
- NICHOLAS BERTOZZI (2016)
Senior Instructor, Robotics Engineering
B.S., Northeastern University, 1977; M.S., 1982.
- SHAMZNAZ VIRANI BHADA (2013)
Assistant Professor, Electrical and Computer Engineering
B.S., University of Pune, India, 1999;
M.S., Wright State University, Dayton, 2002;
Ph.D., University of Alabama, Huntsville, 2008.
- MEHUL BHATIA (2017)
Assistant Teaching Professor, Mechanical Engineering
B.E., Sardar Patel University, India, 2007
M.S., New Jersey Institute of Technology, 2008;
Ph.D., Arizona State University, 2013.
- FREDERICK BIANCHI (1994)
Professor, Humanities and Arts
B.A., Cleveland State University, 1980;
M.S., Ball State University, 1982; Ph.D., 1985.
- ROSHANAK BIGONAH (2009)
Senior Instructor/Lecturer, Humanities and Arts
B.A., Worcester State College, 1989;
M.Ed., Lesley University, 2005.
- KRISTEN L. BILLIAR (2002)
Professor, Biomedical Engineering, and Head of Department
B.S., Cornell University, 1991;
M.S., University of Pennsylvania, 1992; Ph.D., 1998.
- STEPHEN J. BITAR (1994)
Instructor, Electrical and Computer Engineering
B.S., Worcester Polytechnic Institute, 1985; M.S., 1995.
- MARCEL Y. BLAIS (2005)
Associate Teaching Professor, Mathematical Sciences
B.S., Fairfield University, 1999;
Special Masters, Cornell University, 2003; Ph.D., 2006.
- JOHN J. BLANDINO (2001)
Associate Professor, Mechanical Engineering
B.S., Rensselaer Polytechnic Institute, 1987;
M.S., Massachusetts Institute of Technology, 1989;
Ph.D., California Institute of Technology, 2001.
- YEVGENIY BOGDANOV (2002)
Assistant Teaching Professor, Electrical and Computer Engineering
B.S., Worcester Polytechnic Institute, 1997; M.S., 1998;
Ph.D., 2002.

- ESTHER F. BOUCHER-YIP (2012)
Associate Teaching Professor, Humanities and Arts
B.A., University of Malaya, 1994; Dip.Ed.(TESL), 1995;
M.Phil., University of Cambridge, 1999;
Ed.D., University of Leicester, 2005.
- KRISTIN BOUDREAU (2009)
Professor, Humanities and Arts
B.A., Cornell University, 1987;
M.A., University of Rochester, 1989; Ph.D., 1992.
- MOHAMED BRAHIMI (2016)
Instructor/Lecturer, Humanities and Arts
B.A., Communication, Suffolk University, 2007;
M.S., Political Science, Suffolk University, 2008.
- JOEL J. BRATTIN (1990)
Professor, Humanities and Arts
A.B., University of Michigan, 1978;
Ph.D., Stanford University, 1985.
- ULRIKE BRISSON (2006)
Associate Teaching Professor, Humanities and Arts
B.S., University of Hannover-Germany;
M.A., The Pennsylvania State University, 1995; Ph.D., 2000.
- DREW R. BRODEUR (2010)
Associate Teaching Professor, Chemistry and Biochemistry
B.S., University of Rhode Island (URI), 2006;
B.A., 2006; Ph.D., 2011.
- CHRISTOPHER A. BROWN (1989)
Professor, Mechanical Engineering
B.A., University of Vermont, 1975;
M.S., 1979; Ph.D., 1983.
- DAVID C. BROWN (1980)
Professor, Computer Science; Professor, Mechanical Engineering
B.S., North Staffordshire Polytechnic, 1970;
M.S., University of Kent at Canterbury, 1974;
M.S., Ohio State University, Columbus, 1976; Ph.D., 1984.
- DONALD R. BROWN (2000)
Interim Department Head of Electrical and Computer Engineering
Associate Professor, Electrical and Computer Engineering
B.S., University of Connecticut, 1992; M.S., 1996;
Ph.D., Cornell University, 2000.
- CRYSTAL BROWN (2019)
Assistant Teaching Professor, Social Sciences and Policies Studies
B.S., Pennsylvania State University, 2006;
M.S., Ph.D., University of Oregon, 2016, 2019.
- FLOYD BROWNEWELL (2019)
Professor of Practice, Biology and Biotechnology
B.S., Slippery Rock University, Pennsylvania, 1988;
B.S., M.A., Johnson State College, Vermont, 1994
Ph.D., University of Vermont, 2000;
- MICHAEL A. BUCKHOLT (2001)
Associate Teaching Professor, Biology and Biotechnology
B.S., The Pennsylvania State University, 1987;
Ph.D., Worcester Polytechnic Institute, 1992.
- STEVEN C. BULLOCK (1989)
Professor, Humanities and Arts
B.A., Houghton College, 1978;
M.A., SUNY-Binghamton, 1980;
A.M., Brown University, 1982; Ph.D., 1986.
- SHAWN C. BURDETTE (2011)
Associate Professor, Chemistry and Biochemistry
B.S., Case Western Reserve University, 1997;
Ph.D., Massachusetts Institute of Technology, 2002.
- NANCY A. BURNHAM (2000)
Professor, Physics
B.A., Colgate University, 1980;
M.S., University of Colorado, Boulder, 1985; Ph.D., 1987.
- BRUCE E. BURSTEN (2015)
Professor, Chemical Engineering
S.B., University of Chicago, 1974;
Ph.D., University of Wisconsin, Madison, 1978.
- TIFFINY A. BUTLER (2015)
Assistant Teaching Professor, Mechanical Engineering
B.S., Eastern University, 2007;
M.S., Temple University, 2009; Ph.D., 2014.
- BERK ÇALLI (2018)
Visiting Assistant Professor, Computer Science/Robotics Engineering
B.S., M.S., Sabanci University, 2006, 2008;
Ph.D., Delft University of Technology, the Netherlands, 2015.
- TERRI ANNE CAMESANO (2000)
Dean of Graduate Studies;
Professor, Chemical Engineering
B.S., University of Rochester, 1995;
M.S., University of Arizona, 1997;
Ph.D., Pennsylvania State University, 2000.
- LUCA CAPOGNA (2013)
Professor, Mathematical Sciences, and Head of Department
B.S., University of Rome II (Tor Vergata), 1990;
Ph.D., Purdue University, 1996.
- FABIO CARRERA (1991)
Teaching Professor
B.S., Worcester Polytechnic Institute, 1984; M.S., 1996;
Ph.D., Massachusetts Institute of Technology, 2004.
- FARLEY CHERY (2016)
Assistant Teaching Professor, Interactive Media and Game Development
B.F.A., Collins College, 2005;
M.F.A., Full Sail University, 2010.
- JAMES CHIARELLI (2012)
Instructor/Lecturer, Interdisciplinary and Global Studies
B.A., Boston University;
M.A., University of Missouri-Columbia;
- KENNY CHING (2019)
Assistant Professor, Foisie Business School
B.Sc., John Hopkins University, 2003;
S.M., Ph.D., Massachusetts Institute of Technology, 2013,
2015.

- PETER R. CHRISTOPHER (1963)
Professor, Mathematical Sciences
A.B., Clark University, 1959; M.A., 1963; Ph.D., 1982.
- EDWARD A. CLANCY (2000)
Professor, Electrical and Computer Engineering
B.S., Worcester Polytechnic Institute, 1983;
M.S., Massachusetts Institute of Technology, 1987; Ph.D., 1991.
- ANDREW CLARK (2015)
Assistant Professor, Electrical and Computer Engineering
B.S., University of Michigan, Ann Arbor, 2007; M.S., 2008
Ph.D., University of Washington, Seattle, 2014.
- CONSTANCE A. CLARK (2006)
Associate Professor, Humanities and Arts
B.S., State University of New York/Stony Brook, 1978;
M.A., University of Colorado/Boulder, 1996; Ph.D., 2002.
- WILLIAM M. CLARK (1986)
Associate Professor, Chemical Engineering
B.S., Clemson University, 1979;
Ph.D., Rice University, 1984.
- MARK L. CLAYPOOL (1998)
Professor, Computer Science
B.A., Colorado College, 1990;
M.S., University of Minnesota, 1993; Ph.D., 1996.
- JEANNINE M. COBURN (2016)
Assistant Professor, Biomedical Engineering
B.S., University of Massachusetts, Amherst, 2006;
Ph.D., Johns Hopkins University, 2012.
- JAMES M. COCOLA (2009)
Associate Professor, Humanities and Arts
A.B., Harvard College, 1998;
Ph.D., University of Virginia, 2009.
- DANIELLE COTE (2015)
Assistant Professor, Mechanical Engineering
B.S., Worcester Polytechnic Institute, 2005; M.S., 2010;
Ph.D., 2014.
- RAGHVENDRA V. COWLAGI (2013)
Associate Professor, Mechanical Engineering
B.E., University of Mumbai, India, 2003;
Indian Institute of Technology Bombay, Mumbai, India, 2005;
Ph.D., Georgia Institute of Technology, Atlanta, 2011.
- PATRICK H. CROWE (2019)
Instructor/Lecturer, Humanities and Arts
B.S., in Mechanical Eng. and Humanities & Arts/Drama,
Worcester Polytechnic Institute, 2011.
- JOSEPH F. CULLON (2013)
Associate Teaching Professor, Humanities and Arts
B.S., Cornell University, 1991;
M.S., University of Wisconsin, Madison, 1995; M.A., 1998;
Ph.D., 2003.
- JOSHUA CUNEO (2017)
Instructor, Computer Science
B.S., Georgia Institute of Technology, 2008; M.S., 2010.
- BLAKE H. CURRIER (2013)
Assistant Teaching Professor, Physics
B.S., Worcester Polytechnic Institute; Ph.D., 2013.
- ROBERT DANIELLO (2015)
Assistant Teaching Professor, Mechanical Engineering
B.B., University of Massachusetts, Amherst, 2006; M.S., 2009;
Ph.D. 2013.
- ALTHEA DANIELSKI (2016)
Assistant Teaching Professor, Humanities and Arts
B.A., Wesleyan University, 1992;
M.A., SIT Graduate Institute, 2004;
A.B.E. University of Minnesota, 2009.
- RAVINDRA DATTA (1998)
Professor, Chemical Engineering
B.T., Indian Institute of Technology (India), 1972;
Ph.D., University of California, Santa Barbara, 1981.
- JOHN-MICHAEL DAVIS (2019)
Assistant Teaching Professor, Interdisciplinary and Global Studies
B.A., Wilfrid Laurier University, 2009;
M.Sc., McGill University, 2012;
M.A., Ben Gurion University, 2013;
Ph.D., Memorial University of Newfoundland, 2017.
- LINDSAY G. DAVIS (2018)
Assistant Teaching Professor, Humanities and Arts
B.A., University of Vermont, 2005
M.A., Dartmouth College, 2009;
Ph.D., the George Washington University, 2018.
- COREY DEHNER (2012)
Associate Teaching Professor, IGSD
Ph.D., Northeastern University, 2009.
- NICHOLAS A. DEMBSEY (1995)
Professor, Fire Protection Engineering
B.S., University of Michigan, Ann Arbor, 1986
M.S., University of California at Berkeley, 1988; Ph.D., 1995.
- MICHAEL A. DEMETRIOU (1997)
Professor, Mechanical Engineering
B.S., University of Southern California, 1987; M.S., 1989;
M.S., 1990; Ph.D., 1993.
- CHRYSANTHE DEMETRY (1993)
Associate Professor, Mechanical Engineering;
Director, Morgan Teaching and Learning Center
B.S., Worcester Polytechnic Institute, 1988;
Ph.D., Massachusetts Institute of Technology, 1993.
- ROBERT E. DEMPSKI (2009)
Associate Professor, Chemistry and Biochemistry
B.S., Bucknell University, 1997;
Ph.D., Massachusetts Institute of Technology, 2003.
- N. AARON DESKINS (2009)
Associate Professor, Chemical Engineering
B.S., University of Utah, 2001;
Ph.D., Purdue University, 2006.
- LORENZO DE CARLI (2018)
Assistant Professor, Computer Science
B.Sc., Politecnico di Torino. Italy, 2005;
M.Sc., Politecnico di Torino. Italy, 2007.
Ph.D., University of Wisconsin, Madison, 2016.

- JENNIFER DEWINTER (2009)
Professor and Associate Head of Department, Humanities and Arts
B.A., Eastern Washington University, 2000; M.A., 2002;
Ph.D., University of Arizona, 2008.
- DAVID DIBIASIO (1980)
Associate Professor, Chemical Engineering
B.S., Purdue University, 1972; M.S., 1977; Ph.D., 1980.
- FRANK A. DICK (2007)
Associate Teaching Professor, Physics
B.S., University of Texas/San Antonio, 1984;
M. S., Worcester Polytechnic Institute, 2005; Ph.D., 2007.
- DANIEL A. DIMASSA (2014)
Assistant Professor, Humanities and Arts
B.A., University of Notre Dame, 2006;
M.A.R., Yale Divinity School, 2008
M.A., University of Pennsylvania, 2010; Ph.D., 2014.
- MIKHAIL F. DIMENTBERG (1994)
Professor, Mechanical Engineering
M.S.C., Moscow Institute of Power Engineering, 1958;
Ph.D., 1963; Doctor of Technical Sciences, 1971.
- JAMES P. DITTAMI (1985)
Professor, Chemistry and Biochemistry
A.B., College of The Holy Cross, 1975;
M.S., Boston College, 1978;
Ph.D., Rensselaer Polytechnic Institute, 1983.
- ANTHONY G. DIXON (1980)
Professor, Chemical Engineering
B.S., Edinburgh University, 1975; Ph.D., 1978.
- SOUSSAN DJAMASBI (2004)
Professor, Foisie Business School
B.S., Christian Albert University (Germany), 1988;
M.S., University of New Mexico, Albuquerque, 1991;
Ph.D., University of Hawaii, Manoa, 2004.
- LESLIE DODSON (2016)
Assistant Teaching Professor, Undergraduate Studies
B.A., Lake Forest College;
M.S., Journalism, Northwestern University;
Ph.D., Technology, Media & Society, University of Colorado, Boulder.
- JOSEPH DOIRON (2019)
Assistant Teaching Professor, Interdisciplinary and Global Studies
B.A., Xavier University, 2002;
M.A., Tufts University, 2005;
Ph.D., Boston University, 2017.
- TANJA DOMINKO (2006)
Associate Professor, Biology and Biotechnology
DVM, University of Ljubljana (Slovenia), 1985; M.S., 1986;
Ph.D., University of Wisconsin - Madison, 1996.
- YARKIN DOROZ (2018)
Assistant Teaching Professor, Computer and Electrical Engineering
B.S., M.S., Sabanci University, Istanbul, 2009, 2011;
Ph.D., Worcester Polytechnic Institute, 2017.
- DANIEL J. DOUGHERTY (2002)
Professor, Computer Science
B.A., University of Maryland, 1974; Ph.D., 1982.
- EMILY M. DOUGLAS (2017)
Professor, Social Science and Policy Studies, and Head of Department
B.A., Clark University, 1995
M.S., University of Massachusetts, 1999; Ph.D., 2002.
- JAMES K. DOYLE (1992)
Associate Professor, Social Science and Policy Studies
B.A., University of California/Berkeley, 1982;
M.A., University of Colorado/Boulder, 1990; Ph.D., 1991.
- TATIANA DOYTCHINOVA (2012)
Senior Instructor, Mathematical Sciences
B.S., M.S., Mathematics, Moscow State University, 1987;
M.S., Applied Mathematics, Carnegie Mellon University, 1999;
M.S., Applied Statistics, Worcester Polytechnic Institute, 2001.
- HOLGER DROESSLER (2019)
Assistant Professor, Humanities and Arts
M.A., Ludwig-Maximilians University, 2008;
A.M., History, Ph.D., Harvard University, 2011;2015.
- WEN-HUA DU (2017)
Assistant Teaching Professor, Associate Director of the China Hub, Humanities and Arts Department
B.A., Soochow University, Taiwan;
M.A., National Taiwan Normal University, Taiwan;
Ph.D., University of Wisconsin.
- R. JAMES DUCKWORTH (1987)
Associate Professor, Electrical and Computer Engineering
B. Eng., Bradford University, 1981;
Ph.D., Nottingham University, 1984.
- JEANINE D. DUDLE (2017)
Associate Professor, Civil and Environmental Engineering
B.S., Cornell University, 1993;
M.S., University of Massachusetts/Amherst, 1995; Ph.D., 1999.
- JOSEPH B. DUFFY (2006)
Associate Professor, Biology and Biotechnology, and Head of Department
B.S., Cornell University, 1987;
Ph.D., University of Texas, 1992.
- BETHEL L. EDDY (2007)
Associate Professor, Humanities and Arts
B.S., Northeast Louisiana University, 1978;
M.A., University of North Carolina/Greensboro, 1992;
M.A., Princeton University, 1995; Ph.D., 1998.
- CARRICK EGGLESTON (2019)
Professor, Civil and Environmental Engineering, and Head of Department
A.B., Dartmouth College, Hanover, NH, 1983;
Ph.D., Stanford University, 1991.
- LAUREN ELGERT (2011)
Associate Professor, Social Science and Policy Studies
B.A., Trent University, 1999;
M.Sc., University of Alberta, Edmonton, 2003;
Ph.D., London School of Economics, 2011.
- MOHAMMED EL HAMZAOUI (2018)
Instructor, Humanities and Arts
B.A., Sidi Mohamed Ben Abdullah University, Morocco, 2009;
M.A., 2011.

- TAHAR EL-KORCHI (1987)
Professor, Civil and Environmental Engineering
B.S., University of New Hampshire, 1980;
M.S., 1982; Ph.D., 1986.
- MICHAEL B. ELMES (1990)
Professor, Foisie Business School
B.S., Union College, 1975;
M.A., Colgate University, 1979;
Ph.D., Syracuse University, 1989.
- MOHAMED Y. ELTABAKH (2011)
Associate Professor, Computer Science
B.S., Alexandria University (Egypt), 1999; M.S., 2001;
M.S., Purdue University, 2005; Ph.D., 2010.
- FATEMEH EMDAD (2015)
Associate Teaching Professor, Data Sciences
B.Sc., Shiraz University, Shiraz, 1992;
M.Sc., Tehran Tarbiat Moallem University, Tehran, 1995;
M.Sc., Colorado State University, 2002; Ph.D., 2007.
- MARION H. EMMERT (2011)
Associate Professor, Chemistry and Biochemistry
Diploma, Albert-Ludwigs-Universität Freiburg, Germany, 2004;
Ph.D., Westfälische Wilhelms-Universität Münster, Germany, 2009.
- MICHAEL ENGLING (2019)
Assistant Teaching Professor, Computer Science
B.S., University of Tampa, 1986;
M.S., Lehigh University, 1989;
M.S., Ph.D., Stevens Institute of Technology, 2014, 2017.
- MICHELLE EPHRAIM (1999)
Associate Professor, Humanities and Arts
B.A., Tufts University, 1991;
M.A., University of Wisconsin, Madison, 1993; Ph.D., 1998.
- BRENTON D. FABER (2011)
Professor, Humanities and Arts
B.A., University of Waterloo, 1992;
M.A., Simon Fraser University, 1993;
Ph.D., University of Utah, 1998.
- NATALIE G. FARNY (2013)
Assistant Professor, Biology and Biotechnology
B.S., Boston College, 2000;
Ph.D., Harvard University, 2009.
- MOHAMAD FARZIN MOGHADAM (2017)
Assistant Teaching Professor, Civil and Environmental Engineering
B.A., Shahid Beheshti University, Tehran, Iran, 2006;
M.S., Tarbiat Modares University, Tehran, Iran, 2009;
M.Arch., University of Amherst, 2013; Ph.D., 2017.
- JOSEPH D. FEHRIBACH (1992)
Associate Professor, Mathematical Sciences
B.A., Centre College, 1980;
M.A., Duke University 1982; Ph.D., 1985.
- GREGORY S. FISCHER (2008)
Professor, Mechanical Engineering
B.S., Rensselaer Polytechnic Institute, 2002;
M.S.E., Johns Hopkins University, 2003; Ph.D., 2008.
- MUSTAPHA S. FOFANA (1997)
Associate Professor, Mechanical Engineering
B.S./M.S., Budapest Technical University, 1986;
M.A.S., University of Waterloo, 1989; Ph.D., 1993.
- KATHERINE FOO (2017)
Assistant Teaching Professor, Interdisciplinary and Global Studies
B.A., Williams College, 2002;
M.S./M.L.A., University of Michigan, 2008;
Ph.D., Clark University, 2015.
- JIE FU (2015)
Assistant Professor, Robotics Engineering
B.S., Beijing Institute of Technology, 2007; M.S., 2009;
Ph.D., University of Delaware, 2013.
- COSME FURLONG-VAZQUEZ (1999)
Professor, Mechanical Engineering
B.Eng., University of the Americas, 1989;
M.S., Worcester Polytechnic Institute, 1992; Ph.D., 1999.
- JOHN S. GALANTE (2016)
Assistant Teaching Professor, Humanities and Arts
B.S., Tufts University, 2000;
M.A., Columbia University, 2008;
Ph.D., University of Pittsburgh, 2016
- THOMAS GANNON (1991)
Professor of Practice, Electrical and Computer Engineering
B.S., Illinois Institute of Technology, 1970;
M.S., Purdue University, 1971;
Ph.D., Stevens Institute of Technology, 1977.
- NIKOLAOS A. GATSONIS (1994)
Professor, Mechanical Engineering;
Director, Aerospace Engineering Program
B.S., Aristotelian University of Thessaloniki, 1983;
M.S., University Michigan, 1986;
M.S., Massachusetts Institute of Technology, 1987;
Ph.D., 1991.
- GLENN R. GAUDETTE (2006)
Professor, Biomedical Engineering
B.S., University of Massachusetts/Dartmouth, 1989;
M.S., Georgia Institute of Technology, 1992;
Ph.D., State University of New York/Stony Brook, 2002.
- MICHAEL A. GENNERT (1987)
Professor, Computer Science;
S.M.E.E., S.B.C.S., S.B.E.E., Massachusetts Institute of
Technology, 1980; Sc.D., 1987.
- ARNE GERICKE (2011)
Professor, Chemistry and Biochemistry, and Head of Department;
John C. Metzger, Jr. Professor in Chemistry
B.S., University of Hamburg (Germany), 1988; Dr. rev. nat., 1994.
- DESPOINA GIAPOUDZI (2018)
Visiting Instructor, Humanities and Arts
B.S., Worcester Polytechnic Institute, 2016.
- DOMINIC GOLDING (2007)
Teaching Professor, IGSD
B.A., Exeter College, 1981;
M.A., Clark University, 1986; Ph.D., 1988.
- EDWARD GONSALVES (1996)
Instructor, Foisie Business School
B.S., M.S., Worcester Polytechnic Institute, 1981; 1994.

- ADRYEN GONZALEZ (2018)
Instructor, Humanities ad Arts
B.F.A., California College of the Arts, 2016.
- ROGER S. GOTTLIEB (1981)
Professor, Humanities and Arts
B.A., Brandeis University, 1968; Ph.D., 1975.
- JOHN GOULET (1993)
Teaching Professor, Mathematical Sciences
B.S., Worcester Polytechnic Institute, 1973;
M.S., Rensselaer Polytechnic Institute, 1974; Ph.D., 1976.
- RONALD GRIMM (2014)
Assistant Professor, Chemistry and Biochemistry
B.S., Case Western Reserve University, 1999;
Ph.D., California Institute of Technology, 2005.
- SELÇUK I. GUCERI (2011)
Professor, Mechanical Engineering
B.S., M.S., Middle East Technical University, 1960;
Ph.D., North Carolina State University, 1976.
- ULKUHAN GULER (2018)
Visiting Assistant Professor, Electrical and Computer Engineering
B.Sc., Istanbul Technical University, Turkey, 1999;
M.Sc., the University of Tokyo, Japan, 2003
Ph.D., Bogazici University, Turkey, 2014.
- TIAN GUO (2016)
Assistant Professor, Computer Science
B.Eng., Nanjing University, China, 2010;
M.S., Ph.D., University of Massachusetts, Amherst, 2013, 2016.
- EDWARD R. GUTIERREZ (2016)
Assistant Professor, Humanities and Arts/IMGD
B.A., California Institute of the Arts, Valencia, 1983;
M.A., Academy of Art University, San Francisco, 2007.
- ADRIENNE HALL-PHILLIPS (2011)
Associate Professor, Foisie Business School
Faculty Program Director, B.S. in Business and B.S. in
Management Engineering
B.S., North Carolina AT&T State University, 2000;
M.S. Purdue University, 2008; Ph.D., 2011.
- MARGARITA HALPINE (2006)
Assistant Teaching Professor, Humanities and Arts
B.A., College of New Rochelle, 1976;
M.A., Columbia University, 1980; M. Ph., 1984;
Ph.D., University of Connecticut, 1995.
- JAMES P. HANLAN (1975)
Professor of History, Humanities and Arts
A.B., College of the Holy Cross, 1967;
M.A., Clark University, 1971; Ph.D., 1979.
- PETER H. HANSEN (1992)
Professor, Humanities and Arts;
Director, International and Global Studies
B.A., Carleton College, 1984;
M.A., Harvard University, 1986; Ph.D., 1991.
- JOSHUA HARMON (2013)
Associate Teaching Professor, Humanities and Arts
B.A., Marlboro College, 1994;
M.A., Cornell University, 1997.
- LANE HARRISON (2015)
Assistant Professor, Computer Science
B.S., UNC-Charlotte, 2009; Ph.D., 2013.
- NEIL T. HEFFERNAN (2002)
Professor, Computer Science
B.A., Amherst College, 1993;
M.S., Carnegie Mellon University, 1998; Ph.D., 2001.
- DESTIN HEILMAN (2006)
Associate Teaching Professor, Chemistry and Biochemistry
B.S., The Pennsylvania State University, 2000;
Ph.D., University of Massachusetts Medical School, 2006.
- GEORGE T. HEINEMAN (1996)
Associate Professor, Computer Science
B.A., Dartmouth College, 1989;
M.S., Columbia University, 1990; Ph.D., 1996.
- ARTHUR C. HEINRICHER, JR. (1992)
Dean of Undergraduate Studies;
Professor, Mathematical Sciences
B.S., University of Missouri/St. Louis, 1980;
Ph.D., Carnegie Mellon University, 1986.
- LTC ADAM D. HEPPE (2018)
Department Head for Army ROTC
B.S., Engineering Management, West Point, 2002;
M.B.A., Webster University, 2014.
- ROBERT HERSH (2004)
Instructor, IGSD
B.A., University of Sussex, Brighton, England, 1978;
M.A., University of Michigan, Ann Arbor, 1984;
Certification, United Nations Environmental Programme, 1991;
M.A., Tufts University, 1992.
- HUONG NGO HIGGINS (1998)
Professor, Foisie Business School
B.A., (French), University of Ho Chi Minh City, 1990;
B.A., (English), 1990;
M.A., Georgia State University, 1996; Ph.D., 1998.
- LORRAINE D. HIGGINS (2003)
Teaching Professor, Humanities and Arts;
Director of Communication Across the Curriculum
B.A., Carnegie Mellon University, 1985; M.A., 1991;
Ph.D., 1992.
- ZHIKUN HOU (1991)
Professor, Mechanical Engineering
B.S., Fudan University, 1974;
M.S., Tongji University, 1981;
M.S., California Institute of Technology, 1986; Ph.D., 1990.
- FRANK HOY (2009)
Professor, Foisie Business School
Director, Collaborative for Entrepreneurship and Innovation;
Paul Beswick Professorship of Innovation and Entrepreneurship
B.B.A., University of Texas at El Paso, 1967;
M.B.A., University of North Texas, 1970;
Ph.D., Texas A&M University, 1979.

- XIN-MING HUANG (2006)
Professor, Electrical and Computer Engineering
B.S., Northwestern Polytechnic University (China), 1994;
M.Eng., 1996;
Ph.D., Virginia Polytechnic Institute and State University, 2001.
- MAYER HUMI (1971)
Professor, Mathematical Sciences
B.S., Hebrew University of Jerusalem, 1963; M.S., 1964;
Ph.D., Weizmann Institute of Science, 1969.
- GERMANO S. IANNACCHIONE (1998)
Professor, Physics
B.S., University of Akron, 1987; M.S., 1990;
Ph.D., Kent State University, 1993.
- JAGANNATH JAYACHANDRAN (2018)
Assistant Professor, Mechanical Engineering
B.S., Vellore Institute of Technology, India, 2007;
M.S., Ph.D., University of Southern California, 2013; 2016.
- SONGBAI JI (2016)
Associate Professor, Biomedical Engineering
B.S., M.S., Shanghai Jiatong University, China 1996, 1999;
M.S., D.Sc., Washington University in St. Louis, 2003.
- J. SCOTT GIUSTO (2004)
Associate Professor, Interdisciplinary and Global Studies Division
B.S., Empire State College (SUNY), 1992;
M.A., University of Albany (SUNY), 1998;
Ph.D., Clark University, 2004.
- MICHAEL JOHNSON (2003)
Associate Teaching Professor, Mathematical Sciences
B.S. Worcester State College, 1997; B.S., 1998;
M.S., Worcester Polytechnic Institute, 2001.
- SHARON A. JOHNSON (1988)
Professor, Foisie Business School
Area Head (Operations and Industrial Engineering)
B.S., University of Michigan, 1983;
M.S., Cornell University, 1986; Ph.D., 1989.
- SNEHALATA KADAM (2014)
Assistant Teaching Professor, Physics
B.Sc., Shivaji University, Kolhapur, India, 1994; M.Sc., 1996;
Ph.D., University of Tuebingen, Germany, 2003.
- RUDRA KAFLE (2015)
Assistant Teaching Professor, Physics
B.S. Tribhuvan University, Kathmandu, Nepal, 1992; M.S., 1996;
M.S., Worcester Polytechnic Institute, 2007; Ph.D., 2012.
- GEORGE A. KAMINSKI (2008)
Associate Professor, Chemistry and Biochemistry
B.S./M.S., Moscow Institute of Physics and Technology, 1990;
M.S., Yale University, 1993; Ph.D., 1998.
- NIKHIL KARANJGAOKAR (2015)
Assistant Professor, Mechanical Engineering
B.Tech., National Institute of Technology, Calicut, 2006;
M.S., Carnegie Mellon University, 2007;
Ph.D., University of Illinois at Urbana-Champaign, 2013.
- HEKTOR KASHURI (2008)
Assistant Teaching Professor, Physics
B.S., University of Tirana (Albania), 1997;
ICTP Diploma, The Abdus Salam ICTP (Italy), 2000;
Ph.D., Northeastern University, 2008.
- NIKOLAOS KAZANTZIS (2001)
Professor, Chemical Engineering
B.S., University of Theseloniki (Greece), 1990;
M.S., University of Michigan, 1992; M.S.E., 1993;
Ph.D., 1997.
- MARIE KELLER (2006)
Assistant Teaching Professor, Humanities and Arts
B.F.A., Rhode Island School of Design, 1994;
M.F.A., New York Academy of Art, 1996.
- JEAN KING (2017)
Peterson Family Dean of Arts and Sciences;
Professor of Biology and Biotechnology
B.S., St. Francis College, Brooklyn 1979;
M.S., City University of New York 1982;
Ph.D., New York University 1988.
- PAUL E. KIRBY (2015)
Instructor, Humanities and Arts
B.A., Assumption College, 1966;
B.Ph., Laval University, 1967;
Grad-non-degree student In Philosophy, UMASS, 1970;
- STEVEN KMIOTEK (2012)
Professor of Practice, Chemical Engineering
Ph.D., Worcester Polytechnic Institute, 1986.
- XIANGNAN KONG (2014)
Assistant Professor, Computer Science and Data Science
B.S., Nanjing University, Nanjing, China, 2006; M.A., 2009;
Ph.D., University of Illinois at Chicago, 2014.
- RENATA KONRAD (2009)
Associate Professor, Foisie Business School
B.A.S., University of Toronto, 1999; M.A.S., 2004;
Ph.D., Purdue University, 2009.
- JANICE KOOKEN (2019)
Assistant Research Professor, Social Science and Policy Studies
B.S., Queens College of the City of New York, 1982;
M.S., University of Illinois at Chicago, 1998;
Ph.D., University of Connecticut, 2015.
- NIMA KORDZADEH (2017)
Assistant Professor, Foisie Business School
B.S., Sharif University of Technology, Tehran, Iran, 2006;
M.B.A., 2009;
Ph.D., University of Texas at San Antonio, 2014.
- DMITRY A. KORKIN (2014)
Associate Professor, Computer Science
B.Sc., Moscow State University, Moscow, Russia, 1997;
M.Sc., Moscow State University, Moscow, Russia, 1999;
Ph.D., University of New Brunswick, NB, Canada, 2003.
- J. ROBERT KRUEGER (2004)
Associate Professor, Social Science and Policy Studies
B.S., Oklahoma State University, 1991;
M.S.L., Vermont Law School, 1992;
M.A., Clark University, 1998; Ph.D., 2004.

- UMA T. KUMAR (1996)
Associate Teaching Professor, Chemistry and Biochemistry
Ph.D., University of Cincinnati, 1993.
- COURTNEY KURLANSKA (2017)
Assistant Teaching Professor, Interdisciplinary and Global Studies
B.A., Brandeis University, 1999;
M.S., University of New Orleans, 2005;
Ph.D., State University of New York, Albany, 2012.
- DIANA A. LADOS (2006)
Professor, Mechanical Engineering
B.S./M.S., Polytechnic University of Bucharest, 1997;
M.S., Southern Illinois University, 1999;
Ph.D., Worcester Polytechnic Institute, 2004.
- CHRISTOPHER R. LAMBERT (2001)
Associate Teaching Professor, Bioengineering Institute
B.S., University College (Wales), 1979;
Ph.D., University of Paisley (Scotland), 1983.
- ADAM C. LAMMERT (2019)
Assistant Professor, Biomedical Engineering
B.A., Vassar College, 2004;
M.S., North Carolina State University, 2006;
Ph.D., University of Southern California, 2014.
- CHRISTOPHER J. LARSEN (1996)
Professor, Mathematical Sciences
B.S., Carnegie Mellon University, 1989;
J.D., University of Maryland School of Law, 1992;
M.S., Carnegie Mellon University, 1994; Ph.D., 1996.
- KWONMOO LEE (2014)
Assistant Professor, Biomedical Engineering
B.S., Pohang University of Science and Technology, South Korea, 1996; M.S., 1998;
Ph.D., Massachusetts Institute of Technology, 2010.
- KYUMIN LEE (2014)
Assistant Professor, Computer Science
B.S., Kyonggi University, South Korea, 2005;
M.S., Sungkyunkwan University, South Korea, 2007;
Ph.D., Texas A & M University, 2013.
- SUZANNE LEPAGE (2007)
Instructor, Civil Engineering
B.S. Worcester Polytechnic Institute, 1995; M.S., 2010.
- SHANA LESSING (2019)
Assistant Teaching Professor, Humanities and Arts
B.A., Sarah Lawrence College, 2002;
M.A., Columbia University, 2007;
Ph.D., City University of New York, expected November 2019.
- FIONA LEVEY (2013)
Associate Teaching Professor, Mechanical Engineering
B.Sc., University of Witwatersrand, South Africa, 1992;
Ph.D., 2001.
- GREGORY LEWIN (2019)
Assistant Teaching Professor, Mechanical Engineering
B.A., Carleton College, 1990
M.S., University of Virginia, 1999;
Ph.D., University of Virginia, 2003.
- KEVIN LEWIS (2017)
Professor of Practice, Humanities and Arts
B.S., Worcester State University, 1992;
M.A., Northeastern University, 1998;
- YANHUA LI (2015)
Assistant Professor, Computer Science
B.E., Sichuan University, Chengdu, China, 2003; M.Sc, 2006;
Ph.D., Beijing University, China, 2009.
Ph.D., University of Minnesota, 2013.
- ZHI (JANE) LI (2017)
Assistant Professor, Mechanical Engineering
B.S., China Agricultural University, China, 2006;
M.Sc., University of Victoria, BC, Canada, 2009;
Ph.D., University of California, Santa Cruz, 2014.
- JIANYU LIANG (2004)
Professor, Mechanical Engineering
B.S., Central South University (China), 1995; M.E., 1998;
Ph.D., Brown University, 2004.
- SIMONA LIGUORI (2018)
Assistant Research Professor, Chemical Engineering
M.S., Calabria University, Italy, 2008; Ph.D., 2011.
- SHICHAO LIU (2018)
Assistant Professor, Civil and Environmental Engineering
B. Eng., M. Eng., Tianjin University, China, 2009;
Ph.D., University of Texas at Austin, 2014.
- YUXIANG LIU (2013)
Assistant Professor, Mechanical Engineering
B.S., University of Science and Technology of China, Hefei, Anhui, China, 2002; M.S., 2005;
Ph.D., University of Maryland, College Park, 2011.
- ELEANOR T. LOIACONO (2000)
Professor, Foisie Business School
B.A., Boston University, 1992;
M.B.A., Boston College, 1996;
Ph.D., University of Georgia, 2000.
- ELIZABETH LONG LINGO (2015)
Assistant Professor, Foisie Business School
B.A., University of Massachusetts, Amherst, 1993;
A.M., Harvard University, 2002; Ph.D., 2005.
- FRED J. LOOFT (1980)
Professor, Electrical and Computer Engineering;
Academic Director of Systems Engineering
B.S., University of Michigan, 1973; M.S., 1974, 1976;
Ph.D., 1979.
- REINHOLD LUDWIG (1986)
Professor, Electrical and Computer Engineering
Diplom-Ingenieur, University of Wuppertal (West Germany), 1983;
Ph.D., Colorado State University, 1986.
- ROGER YIN-MAN LUI (1983)
Professor, Mathematical Sciences
B.S., University of Minnesota, 1975; Ph.D., 1981.

- KONSTANTIN A. LURIE (1989)
Professor, Mathematical Sciences
M.Sc., Leningrad Polytechnical Institute (USSR), 1959;
Ph.D., A.F. Ioffe Physical-Technical Institute, Academy of
Sciences (USSR), 1964; D.Sc., 1972.
- JOHN C. MACDONALD (2001)
Associate Professor, Chemistry
B.A., Bowdoin College, 1987;
Ph.D., University of Minnesota, 1993.
- AARTI S. MADAN (2010)
Associate Professor, Humanities and Arts
B.A., Birmingham-Southern College, 2004;
M.A., University of Pittsburgh, 2007; Ph.D., 2010.
- RYAN S. MADAN (2011)
Associate Teaching Professor, Humanities and Arts;
Director, Writing Center
B.A., University of California, Los Angeles, 2002;
Ph.D., University of Pittsburgh, 2013.
- YOUSEF MAHMOUD (2016)
Assistant Professor, Electrical and Computer Engineering
B.Sc., Al-Balqaa University, Jordan, 2009;
M.Sc., Masdar Institute of Science and Technology, Abu-Dhabi,
UAE, 2012;
Ph.D., University of Waterloo, ON, Canada, 2016.
- SERGEY N. MAKAROV (2000)
Professor, Electrical and Computer Engineering
M.S., St. Petersburg State University (Russia), 1982;
Ph.D., 1986.
- MAKHLLOUF M. MAKHLLOUF (1989)
Professor, Mechanical Engineering;
Director, Aluminum Casting Research Laboratory
B.S., American University (Cairo), 1978;
M.S., New Mexico State University, 1981;
Ph.D., Worcester Polytechnic Institute, 1990.
- RAJIB B. MALICK (1998)
Professor, Civil and Environmental Engineering,
and Associate Head of Department;
Ralph H. White Family Distinguished Professorship
B.S., Jadavpur University (India), 1989;
M.S., Auburn University, 1993; Ph.D., 1997.
- AMITY L. MANNING (2014)
Assistant Professor, Biology and Biotechnology
B.A., Brandeis University, 2002; B.S., 2002;
Ph.D., Geisel School of Medicine at Dartmouth, 2008.
- OREN MANGOUBI (2019)
Assistant Professor, Mathematical Sciences, Data Science Program
B.S., Yale University, 2011;
Ph.D., Massachusetts Institute of Technology, 2016.
- V.J. MANZO (2012)
Associate Professor, Humanities and Arts
B.A., Kean University, 2005;
M.M., New York University, 2007;
Ph.D., Temple University, 2012.
- IVAN MARDILOVICH (1999)
Assistant Teaching Professor, Chemistry and Biochemistry
Ph.D., Peoples' Friendship University of Russia, 1982.
- WILLIAM J. MARTIN (2000)
Professor, Mathematical Sciences
B.A., State University of New York/Potsdam, 1986;
M.A., 1986; Ph.D., University of Waterloo (Canada), 1992.
- LAUREN M. MATHEWS (2003)
Associate Professor, Biology and Biotechnology
B.A., Connecticut College, 1996;
Ph.D., University of Louisiana/Lafayette, 2001.
- PAUL P. MATHISEN (1993)
Associate Professor, Civil and Environmental Engineering
B.S., University of Massachusetts, 1984;
S.M., Massachusetts Institute of Technology, 1989; Ph.D., 1993.
- INGRID E. MATOS-NIN (2003)
Associate Teaching Professor, Humanities and Arts
B.A., Universidad de Puerto Rico/Mayaguez, 1981;
B.A., Pontificia Universidad Católica de Puerto Rico, 1984;
M.A., 1988; B.S., 1997;
Ph.D., Boston University, 2004.
- ANITA E. MATTSON (2016)
Associate Professor, Chemistry and Biochemistry
B.S., Northern Michigan University, 2002;
Ph.D., Northwestern University, Evanston, 2007.
- CAROLYN D. MAYER (2018)
Post-Doctoral Scholar, Mathematical Sciences
B.A., Bowdoin College, 2015;
M.S., Ph.D., University of Nebraska, Lincoln, 2015, 2018.
- STEPHEN MCCAULEY (2015)
Assistant Teaching Professor, Interdisciplinary and Global Studies
B.A., Loyola College, Maryland, 1996;
M.A., University of Maryland, 2001;
Ph.D., Clark University, 2009.
- KATHARINE L. MCINTYRE (2018)
Assistant Professor, Humanities and Arts
B.A., Harvard University, 2004;
M.F.A., Oregon State University, 2006;
Ph.D., University of Missouri, 2013.
- JOHN A. MCNEILL (1994)
Professor, Electrical and Computer Engineering, and
Interim Dean of Engineering
A.B., Dartmouth College, 1983;
M.S., University of Rochester, 1991;
Ph.D., Boston University, 1994.
- JENNIFER MCWEENY (2012)
Associate Professor, Humanities and Arts
B.A., The Colorado College, 1998;
M.A., University of Hawaii, 2000;
M.A., University of Oregon, 2003; Ph.D., 2005.
- DAVID MEDICH (2012)
Associate Professor, Physics, and Associate Head of Department
B. S., Union College, 1990;
M.A., State University of New York at Buffalo, 1993;
Ph.D. University of Massachusetts/Lowell, MA 1997.

- YITZHAK MENDELSON (1983)
Professor, Biomedical Engineering
B.S., State University of New York at Buffalo, 1975; M.S., 1976;
Ph.D., Case Western Reserve University, 1983.
- WILLIAM R. MICHALSON (1992)
Professor, Electrical and Computer Engineering
B.S. E.E., Syracuse University, 1981;
M.S., Worcester Polytechnic Institute, 1985; Ph.D., 1989.
- FABIENNE MILLER (2007)
Associate Professor, Foisie Business School
Faculty Program Director, M.B.A. & M.S. in Management
M.M., Ecole de Management de Lyon, 1985;
M.P.A., Montana State University, 1998;
Ph.D., Michigan State University, 2007.
- BRAJENDRA MISHRA (2015)
Kenneth G. Merriam Professor and
Associate Director of the Metals Processing Institute (MPI)
B.Tech., Indian Institute of Technology, Kharagpur, 1981;
M.S., University of Minnesota, Minneapolis, 1983; Ph.D., 1986.
- JAMIE P. MONAT (2004)
Director, Executive Education;
Adjunct Assistant Professor of Management, and Professor
of Practice, Corporate and Professional Education
B.S., Princeton University, 1973;
M.S., Stanford University, 1974; Ph.D., 1978.
- KATHRYN M. MONCRIEF (2019)
Professor, Humanities and Arts, and Head of Department
B.A., Doane College, 1989;
M.A., University of Nebraska, 1991;
Ph.D., University of Iowa, 2000.
- REBECCA A. MOODY (2018)
Assistant Teaching Professor, Humanities and Arts
B.A., Oklahoma State University, 1998;
M.A., The University of Texas at Austin, 2006;
M.A., M.Phil., Ph.D., Syracuse University, 2010; 2013; 2018;
- BRIAN MORIARTY (2009)
Professor of Practice, Interactive Media and Game
Development Program
B.A., Southeastern Massachusetts University, 1978;
E.Ed., Framingham State College, 2009.
- UMBERTO MOSCO (2005)
Professor, Mathematical Sciences;
Harold J. Gay Chaired Professorship in Mathematics
Laurea in Mathematical Sciences, University of Rome, 1959;
Laurea in Physics, University of Rome, 1961;
Libera Docenza in Mathematical Methods in Physics, Italy, 1967.
- MAQSOOD ALI MUGHAL (2018)
Assistant Teaching Professor, Electrical and Computer Engineering
B.S., Sir Syed University of Engineering and Technology,
Pakistan, 2009;
M.S., Arkansas State University, 2010; M.S., 2014; Ph.D., 2015.
- KÖKSAL MU (2017)
Assistant Teaching Professor, Electrical and Computer Engineering
B.Sc., Yildiz Technical University, Turkey, 2004;
M.Sc., Middle East Technical University, Turkey, 2009;
Ph.D., 2016.
- BALGOBIN NANDRAM (1989)
Professor, Mathematical Sciences
B.Sc., University of Guyana, 1977, Dip. Ed., 1979;
M.Sc., University of London, Imperial College, 1981;
Ph.D., University of Iowa, 1989.
- SNEHA PRABHA NARRA (2018)
Assistant Professor, Mechanical Engineering
B.E., Osmania University, India, 2012;
M.S., Carnegie Mellon University, 2013; M.E., 2015;
Ph.D., 2017.
- HUSSEIN NASRALAH (2018)
Post-Doctoral Scholar, Mathematical Sciences
B.A., University of Michigan, Ann Arbor, 2012;
M.A., Ph.D., Wayne State University, Detroit, 2018.
- RODICA NEAMTU (2017)
Associate Teaching Professor, Computer Science
B.Sc., University of Craiova, Romania, 1990; M.S., 1991;
Ph.D., Worcester Polytechnic Institute, 2017.
- INNA NECHIPURENKO (2020)
Assistant Professor, Biology and Biotechnology
B.S., Business Administration and Biology, Bloomsburg
University of Pennsylvania, 2005;
Ph.D., Case Western University, 2012.
- BENJAMIN C. NEPHEW (2018)
Assistant Research Professor, Biology and Biotechnology
B.S., Hobart College, 1998;
Ph.D., Tufts University, 2003.
- CHUN-KIT (BEN) NGAN (2018)
Assistant Teaching Professor, Computer Science/Data Science
B.Eng., Hong Kong University, Hong Kong, 1998;
M.B.A., California State University, 2006;
Ph.D., George Mason University, 2013.
- SVETLANA NIKITINA (2004)
Associate Teaching Professor, Humanities and Arts
B.A./M.A., Moscow University (Russia), 1984; Ph.D., 1988;
Ed.M., Harvard University, 1999.
- KATHY A. NOTARIANNI
Associate Professor, Fire Protection Engineering
B.S., Worcester Polytechnic Institute, 1986; M.S., 1989;
M.S., Carnegie Mellon University, 1997; Ph.D., 2000.
- KAREN KASHMANIAN OATES (2010)
Professor of Biology and Biotechnology;
B.S., Rochester Institute of Technology, 1973;
Ph.D., The George Washington University, 1985.
- PADRAIG O’CATHAIN (2016)
Assistant Professor, Mathematical Sciences
B.A., National University of Ireland Galway, 2007;
M. Litt., National University of Ireland Galway, 2008
Ph.D., National University of Ireland Galway, 2011.
- DEAN O’DONNELL (1993)
Assistant Teaching Professor, Humanities and Arts
B.S., Worcester Polytechnic Institute, 1986;
M.F.A., Brandeis University, 1990.

- DAVID J. OLINGER (1990)
Associate Professor, Mechanical Engineering
B.S., Lafayette College, 1983;
M.S., Rensselaer Polytechnic Institute, 1985;
M.S., Yale University, 1988; Ph.M., 1988; Ph.D., 1990.
- XAVIER RAMOS OLIVE (2019)
Post-Doctoral Scholar, Mathematical Sciences
B.Sc., Mathematics, Polytechnic University at Catalonia, 2013;
B.SC., Physics, University of Barcelona, 2014;
Ph.D., University of California, Riverside, 2019.
- CARISSA PEREZ OLSEN (2017)
Assistant Professor, Chemistry and Biochemistry
B.A. Cornell University, 2005;
Ph.D., University of Washington, Seattle, 2011.
- SARAH D. OLSON (2011)
Associate Professor, Mathematical Sciences
B.A. Providence College, 2003;
M.S., University of Rhode Island, 2005;
Ph.D., North Carolina State University, 2008.
- CAGDAS ONAL (2013)
Associate Professor, Mechanical Engineering
B.Sc., Sabanci University, Istanbul, Turkey, 2003; M.Sc., 2005;
Ph.D., Carnegie Mellon University, 2009.
- ERIN OTTMAR (2015)
Assistant Professor, Social Sciences and Policy Studies
B.A., University of Richmond, 2005;
Ph.D., University of Virginia, 2011.
- RANDY PAFFENROTH (2014)
Associate Professor, Mathematical Sciences/Data Science
B.S., Boston University, 1992;
Ph.D., University of Maryland, College Park, 1999.
- RAYMOND L. PAGE (2006)
Professor of Practice, Biomedical Engineering
B.S., West Virginia University, 1987; M.S., 1989;
Ph.D., Virginia Polytechnic Institute and State University, 1993.
- KAVEH PAHLAVAN (1985)
Professor, Electrical and Computer Engineering
M.S., University of Teheran, 1975;
Ph.D., Worcester Polytechnic Institute, 1979.
- BALAJI PANCHAPAKESAN (2014)
Professor, Mechanical Engineering
B.S., NIT, India, 1994;
Ph.D., University of Maryland, College Park, 2001.
- OLEG V. PAVLOV (2002)
Associate Professor, Social Science and Policy Studies
B.S., University of Southern California, 1994; Ph.D., 2000.
- CREIGHTON PEET (2000)
Teaching Professor, Interdisciplinary and Global Studies Division
B.A., Harvard College, 1966;
P.Phil., Columbia University, 1978; Ph.D., 1978.
- THELGE BUDDIKA PEIRIS (2014)
Assistant Teaching Professor, Mathematical Sciences
B.S., University of Sri Jayewardenepura, Sri Lanka, 2005;
M.S., Southern Illinois University, 2010.
Ph.D., Southern Illinois University, 2014.
- DOUGLAS T. PETKIE (2016)
Professor and Department Head, Physics
B.S., Carnegie Mellon University, 1990;
Ph.D., Ohio State University, Columbus, 1996.
- GEOFFREY PFEIFER (2013)
Associate Teaching Professor, Global School and Humanities and Arts
B.A., University of Colorado, 2003.
M.A., University of New Mexico, 2005;
Ph.D., University of South Florida, 2012.
- CARLO PINCIROLI (2016)
Assistant Professor, Computer Science
M.S., Politecnico di Milano, Italy, 2005;
M.S., University of Illinois at Chicago, 2005;
Ph.D., Université Libre de Bruxelles, 2014.
- GEORGE D. PINS (2000)
Professor, Biomedical Engineering, and Associate Head of Department
B.S., Rutgers College of Engineering, 1989;
Ph.D., Rutgers University, 1996.
- DAVID C. PLANCHARD (2011)
Instructor, Mechanical Engineering
B.S., Northeastern University, 1980;
M.S., Worcester Polytechnic Institute, 1992.
- MARKO B. POPOVIC (2010)
Assistant Research Professor, Physics
B.S., Belgrade University, 1995;
M.S., Ohio State University, 1996;
Ph.D., Boston University, 2001.
- BARRY POSTERRO (2015)
Associate Teaching Professor, Mathematical Sciences
B.S., Worcester Polytechnic Institute, 1999; M.S., 2000;
M.S., 2010.
- ADAM C. POWELL, IV (2018)
Associate Professor, Mechanical Engineering
S.B., Massachusetts Institute of Technology, 1992, Ph.D., 1997.
- REETA PRUSTY RAO (2005)
Professor, Biology and Biotechnology
B.S., Birla Institute of Technology and Science (India), 1991;
M.S., Drexel University, 1994;
Ph.D., Penn State University Medical College, 1999.
- MILOSH PUCHOVSKY (2002)
Professor of Practice, Fire Protection Engineering
B.S., Worcester Polytechnic Institute, 1988; M.S., 1991.
- CRAIG B. PUTNAM (2010)
Instructor and Associate Program Director, Robotics Engineering Program
B.S., St. Lawrence University, 1974;
M.S., Penn State University, State College, 1976;
ABD, MSTE, Tufts University (current)
- RICHARD S. QUIMBY (1982)
Associate Professor, Physics
B.S., Clarkson College of Technology, 1975;
Ph.D., University of Wisconsin at Madison, 1979.

- PRADEEP RADHAKRISHNAN (2014)**
Assistant Teaching Professor, Mechanical Engineering
 B.E., PSG College of Technology, India, 2006;
 M.S.E., The University of Texas at Austin, 2010; Ph.D., 2014.
- MICHAEL J. RADZICKI (1990)**
Associate Professor, Social Science and Policy Studies
 B.A., St. Norbert College, 1979;
 M.A., University of Notre Dame, 1982; Ph.D., 1985.
- NIMA RAHBAR (2012)**
Associate Professor, Civil and Environmental Engineering
 B.S., Sharif Institute of Technology, 1998;
 M.S., Northeastern University, 2003;
 Ph.D., Princeton University, 2008.
- SUNDARI RAMABHOTLA (2019)**
Assistant Teaching Professor, Electrical and Computer Engineering
 B.S., JNTU (India), 2007;
 M.S., California State University, Long Beach, 2010;
 Ph.D., Texas Tech University, 2015.
- L. RAMDAS RAM-MOHAN (1978)**
Professor, Physics; Professor, Electrical and Computer Engineering
 B.S., Delhi University (India), 1964;
 M.S., Purdue University, 1967; Ph.D., 1971.
- ALI S. RANGWALA (2006)**
Professor, Fire Protection Engineering
 B.S., Government College of Engineering (India), 2000;
 M.S., University of Maryland, 2002;
 Ph.D., University of California, San Diego, 2006.
- PRATAP M. RAO (2013)**
Associate Professor, Mechanical Engineering
 B.S., Worcester Polytechnic Institute, 2007;
 Ph.D., Stanford University, 2013.
- DANIEL REICHMAN (2019)**
Assistant Professor, Computer Science
 B.A., The Open University, Israel, 2002;
 B.A., The Hebrew University, Israel, 2002;
 Ph.D., Tel Aviv University, 2010;
 M.Sc., Ph.D., Weizmann Institute of Science, Israel, 2004, 2014.
- AMANDA ZOE REIDINGER (2014)**
Instructor, Biomedical Engineering
 B.S., Virginia Commonwealth University, 2008;
 Ph.D., Worcester Polytechnic Institute, 2015.
- FARNOUSH RESHADI (2020)**
Assistant Professor, Foise Business School
 B.Sc., Bu-Ali Sina University, Iran, 2009;
 M.Sc., Iran University of Technology, 2012;
 Ph.D., University of Tehran, Iran, 2020.
- GONZALO CONTADOR REVETRIA (2019)**
Post-Doctoral Scholar, Mathematical Sciences
 M. Eng., Universidad De Chile, 2011;
 M.S., University of Wisconsin, 2018;
 Ph.D., University of Virginia, expected 2019.
- MARK W. RICHMAN (1985)**
Associate Professor, Mechanical Engineering
 B.S., State University of New York at Buffalo;
 M.S., University of Michigan, 1979;
 Ph.D., Cornell University, 1983.
- KENT J. RISSMILLER (1988)**
*Dean, Interdisciplinary and Global Studies Division, ad interim;
 Associate Professor, Social Science and Policy Studies*
 A.B., Muhlenberg College, 1976;
 J.D., Franklin Pierce Law Center, 1980;
 M.A., Syracuse University, 1981; Ph.D., 1986.
- ANGEL A. RIVERA (1994)**
Associate Professor, Humanities and Arts
 B.A., University of Puerto Rico, 1983; M.A., 1987;
 Ph.D., Rutgers University, 1994.
- CHARLES D. ROBERTS (2018)**
*Assistant Professor, Computer Science/Interactive Media and
 Game Development*
 B.M., James Madison University, 1997;
 M.A., Columbia University, 2005;
 MA, University of California at Santa Barbara, 2009,
 Ph.D., 2014.
- LOUIS ROBERTS (2015)**
Associate Teaching Professor, Biology and Biotechnology
 B.S. Worcester Polytechnic Institute, 1992;
 Ph.D., Cornell University, 1998.
- SUSAN C. ROBERTS (2015)**
Professor and Department Head, Chemical Engineering
 B.S., Worcester Polytechnic Institute, 1992;
 Ph.D., Cornell University, 1998.
- ANGELA C. INCOLLINGO RODRIGUEZ (2018)**
Assistant Professor, Social Science and Policy Studies
 B.A., Rutgers University, 2012;
 M.A., University of California, Los Angeles, 2015; Ph.D., 2018.
- JOSHUA ROHDE (2017)**
Assistant Teaching Professor, Humanities and Arts
 Bachelor of Music, B.S., University of Minnesota, 2011;
 M.A., University of Birmingham, 2014;
 Master of Sacred Music, Doctor of Musical Arts, Boston
 University, 2017.
- MARSHA W. ROLLE (2007)**
Associate Professor, Biomedical Engineering
 B.S., Brown University, 1995;
 Ph.D., University of Washington, 2003.
- DERREN ROSBACH (2012)**
*Associate Teaching Professor, Global School and Civil Engineering
 and Undergraduate Studies*
 Ph.D., Virginia Polytechnic Institute, 2010.
- JOSHUA P. ROSENSTOCK (2005)**
Associate Professor, Humanities and Arts
 B.A., Brown University, 1996;
 M.F.A., School of Art Institute of Chicago, 2004.
- JENNIFER M. RUDOLPH (2007)**
*Professor, Humanities and Arts, and Associate
 Head of Department*
 A.B., University of Chicago, 1985;
 M.A., University of Washington, 1993; Ph.D., 1999.
- CAROLINA RUIZ (1998)**
Associate Professor, Computer Science
 B.S., University of Los Andes, Colombia, 1988; B.S., 1989;
 M.S., 1990;
 Ph.D., University of Maryland, College Park, 1996.

JILL RULFS (1990)

Associate Professor, Biology and Biotechnology, and Associate Head of Department
B.S., University of Massachusetts, 1973;
Ph.D., Tufts University, 1982.

ELKE A. RUNDENSTEINER (1996)

Professor, Computer Science
B.S., Johann Wolfgang Goethe University, Frankfurt, West Germany; M.S., 1984;
M.S., Florida State University, 1987;
Ph.D., University of California, Irvine, 1992.

ELIZABETH F. RYDER (1996)

Associate Professor, Biology and Biotechnology
A.B., Princeton University, 1980;
M.S., Harvard School of Public Health, 1985;
Ph.D., Harvard Medical School, 1993.

JAMES E. RYAN (2019)

Associate Teaching Professor, Foisie Business School
B.S., M.S., Ph.D., Auburn University, 1981, 2001, 2006.

SARA SABERI (2016)

Assistant Professor, Foisie Business School
B.Sc., Shiraz University, Iran, 2004;
M.Sc., Isfahan University of Technology, Iran, 2006;
Ph.D., University Putra Malaysia, 2011;
Ph.D., University of Massachusetts, Amherst, 2015

KHALID SAEED (1997)

Professor, Social Science and Policy Studies
B.S., University of Engineering and Technology, Parkistan, 1968;
M.E., Asian Institute of Technology, Thailand, 1975;
Ph.D., Massachusetts Institute of Technology, 1981.

AHMET CAN SABUNCU (2017)

Assistant Teaching Professor, Mechanical Engineering
B.Sc., Yildiz Technical University, Turkey, 2005;
M.Sc., Istanbul Technical University, Turkey, 2007;
Ph.D., Old Dominion University, 2011.

AARON R. SAKULICH (2012)

Associate Professor, Civil and Environmental Engineering
B.S., Drexel University, 2009; Ph.D., 2009.

GUILLERMO F. SALAZAR (1983)

Associate Professor, Civil and Environmental Engineering
B.S., University of La Salle (Mexico), 1971;
M.Eng., University of Toronto, 1977;
Ph.D., Massachusetts Institute of Technology, 1983.

M. DAVID SAMSON (1991)

Associate Professor, Humanities and Arts
B.A., University of Chicago, 1980;
Ph.D., Harvard University, 1988.

JOHN SANBONMATSU (2003)

Associate Professor, Humanities and Arts
B.A., Hampshire College, 1984;
Ph.D., University of California at Santa Cruz, 2000.

WILLIAM SANGUINET (2015)

Senior Instructor/Lecturer, Mathematical Sciences
B.S., M.S., Ph.D., Worcester Polytechnic Institute, 2010, 2013, 2017.

WILLIAM SAN MARTIN (2018)

Assistant Teaching Professor, Humanities and Arts
B.A., Pontificia Universidad Católica de Chile, 2006;
M.A., 2011;
Ph.D., University of California, Davis, 2018.

JOSEPH SARKIS (2013)

Professor, Foisie Business School
B.S., State University of New York, Buffalo, 1985; M.B.A., 1986; Ph.D., 1992.

MARCUS SARKIS (2013)

Professor, Mathematical Science
B.S., Instituto Tecnológico de Aeronáutica (Brazil), 1984;
M.S., Pontificia Universidade Católica de Rio de Janeiro (Brazil), 1989;
Ph.D., New York University, 1994.

GABOR SARKOZY (1996)

Professor, Computer Science
Diploma, Budapest Eötvös Loránd University, 1990
M.S., Rutgers University, 1994; Ph.D., 1994.

ROBERT P. SARNIE (2019)

Professor of Practice In Finance, Foisie Business School
B.S., Bridgewater State College, 1988;
M.S., Suffolk University, 1996.

BRIAN J. SAVILONIS (1981)

Professor, Mechanical Engineering
B.S., Worcester Polytechnic Institute, 1972; M.S., 1973;
Ph.D., State University of New York, 1976.

SUZANNE F. SCARLATA (2015)

Professor, Chemistry and Biochemistry
B.A., Temple University, 1979;
Ph.D., University of Illinois, Urbana-Champaign, 1984.

CHRISTOPHER SCARPINO (2011)

Instructor, Mechanical Engineering
B.A., University of Pittsburgh at Johnstown, 1985; B.S., 1990;
M.S., Worcester Polytechnic Institute, 1994.

LANCE E. SCHACHTERLE (1970)

Professor, Humanities and Arts
A.B., Haverford College, 1966;
A.M., University of Pennsylvania, 1968; Ph.D., 1970.

BRIGITTE I. SERVATIUS (1987)

Professor, Mathematical Sciences
Magister der Naturwissenschaften der Universität Graz, Austria, 1978;
Ph.D., Syracuse University, 1987.

HERMAN J. SERVATIUS (1995)

Senior Instructor/Lecturer, Mathematical Sciences
M.S., Math, and Computer & Information Science, Syracuse University, 1982, 1986;
Ph.D., Syracuse University, 1987.

HRIDAYA SHAH (2019)

Assistant Teaching Professor, Physics
B.E., Ganpat University, India, 2003;
M.S., Ph.D., University of Massachusetts, Lowell, 2015; 2017.

- PURVI SHAH (2013)
Assistant Professor, Foiesie Business School
Bachelor of Commerce, University of Mumbai, India, 2000;
Master of Management Studies, University of Mumbai,
India, 2003;
M.B.A., Texas Tech University, Lubbock, 2009; Ph.D., 2013.
- SCARLET SHELL (2014)
Assistant Professor, Biology and Biotechnology
B.A., Smith College, 2001;
Ph.D., University of California, 2008.
- SATYA SHIVKUMAR (1990)
Professor, Mechanical Engineering
B.S., Regional Engineering College, 1978;
M.S., Indian Institute of Technology, 1980;
M.S., Stevens Institute of Technology, 1987; Ph.D., 1987.
- INGRID SHOCKEY (2008)
*Associate Teaching Professor, Interdisciplinary and
Global Studies Division*
B.A., Clark University, 1987;
M.A., Brandeis University, 1991; Ph.D., 1996.
- CRAIG A. SHUE (2011)
Associate Professor, Computer Science
B.S., Ohio University, 2004;
M.S., Indiana University, 2006; Ph.D., 2009.
- ALBERT SIMEONI (2017)
*Professor, Fire Protection Engineering, and Head
of Department ad interim*
B.Sc., University of Corsica, 1994;
M.Eng., IUSTI, Marseille, 1996;
M.Sc., University of Provence, 1996;
Ph.D., University of Corsica, 2000.
- RICHARD D. SISSON, JR. (1976)
*Director of Manufacturing and Materials Engineering;
Professor, Mechanical Engineering;
George F. Fuller Professorship (2004-2007) (2007-2010)
(2010-2013)*
B.S., Virginia Polytechnic Institute, 1969;
M.S., Purdue University, 1971; Ph.D., 1975.
- LTC JACK SKILES (2018)
- JEANINE L. SKORINKO (2007)
Professor, Social Science and Policy Studies
A.A., Simon's Rock College, 1999;
B.A., Rice University, 2001;
M.A., University of Virginia, 2004; Ph.D., 2007.
- ALEXANDER D. SMITH (2010)
Associate Professor, Social Science and Policy Studies
B.A., York University, 2003;
M.A., University of Toronto, 2004;
Ph.D., University of Calgary, 2010.
- GILLIAN SMITH (2017)
Assistant Professor, Computer Science
B.S., University of Virginia, 2006;
M.S., University of California, 2009; Ph.D., 2012;
- THERESE M. SMITH (2018)
Assistant Teaching Professor, Computer Science
S.B., Massachusetts Institute of Technology, 1975;
M.S., Iowa State University of Science and Technology, 1982;
M.S., Ph.D., University of Connecticut, 2014, 2016;
- WINSTON O. SOBOYEJO (2016)
Professor and Senior Vice President and Provost, Ad Interim
B.sc., King's College, London, 1985;
Ph.D., Churchill College, Cambridge University, England, 1988.
- CARL SODERHJELM (2018)
Assistant Research Professor, Mechanical Engineering
M.Sc., Lund University, Sweden, 2013;
Ph.D., Worcester Polytechnic Institute, 2017.
- ERIN T. SOLOVEY (2018)
Assistant Professor, Computer Science
M.S., Tufts University, 2007;
Ph.D., Tufts University, 2012.
- GBETON SOMASSE (2015)
Assistant Teaching Professor, Social Science and Policy Studies
B.A., University of Abomey-Calavi, Benin, 1996;
M.Sc., ENSEA, Abidjan, Cote d'Ivoire, 2001;
M.A., University Cheikh Anta Diop, Dakar, Senegal, 2005;
M.A., Clark University, 2011; Ph.D., 2015.
- QINGSHUO SONG (2019)
Associate Professor, Mathematical Sciences
M.A., Wayne State University, 2005; Ph.D., 2006;
B.S., Nankai University, China, 1996; M.A., 1999.
- DAVID I. SPANAGEL (2005)
Associate Professor, Humanities and Arts
B.A., Oberlin College, 1982;
M.S. Ed., University of Rochester, 1984;
Ph.D., Harvard University, 1996.
- ANTHONY SPANGENBERGER (2019)
Assistant Research Professor, Mechanical Engineering
B.S., Ph.D., Worcester Polytechnic Institute, 2012; 2017.
- JAGAN SRINIVASAN (2012)
Associate Professor, Biology and Biotechnology
Goa University, India, 1993; M.S., 1995
Ph.D., Max Planck Institute for Developmental Biology, 2003.
- JOSEPH STABILE (2015)
Instructor, Mechanical Engineering
M.S., University of Arizona, 1982;
M.S., University of Colorado, 1998.
- SARAH E. STANLICK (2019)
Assistant Professor, Interdisciplinary and Global Studies Division
B.A., Lafayette College, 2004;
M.A., Brandeis University, 2008;
Ph.D., Lehigh University, 2012.
- PATRICIA A. STAPLETON (2013)
Assistant Professor, Social Science and Policy Studies
B.A., Ursinus College, Pennsylvania, 2002;
M.A., Rutgers University, 2004;
M. Phil., CUNY, New York, 2010; Ph.D., 2012.

- ELIZABETH J. STEWART YANG (2018)
Assistant Professor, Chemical Engineering
B.S., Worcester Polytechnic Institute, 2008;
M.S., University of Michigan, Ann Arbor, 2010; Ph.D., 2015.
- ELISABETH A. STODDARD (2014)
Assistant Teaching Professor, Global School and Social Science and Policy Studies
B.A., University of Vermont, 2001;
M.S., Tufts University, 2008;
Ph.D., Clark University, 2014.
- SARAH STRAUSS (2019)
Professor, Global School
B.S., Dartmouth College, 1984
M.S., San Jose State University, 1987;
Ph.D., University of Pennsylvania, 1997.
- IZABELA STROE (2008)
Associate Teaching Professor, Physics
B.S., University of Bucharest (Romania), 1993; M.S., 1995;
Ph.D., Clark University, 2005.
- DIANE M. STRONG (1995)
Professor and Department Head ad interim, Foisie Business School
B.S., University of South Dakota, 1974;
M.S., New Jersey Institute of Technology, 1978;
M.S., Carnegie Mellon University, 1983; Ph.D., 1988.
- STEPHAN STURM (2012)
Associate Professor, Mathematical Sciences
M.S., University of Vienna, 2004;
Ph.D., TU Berlin, 2010.
- JOHN M. SULLIVAN, JR. (1987)
Professor, Mechanical Engineering, and Associate Head of Department
B.S., University of Massachusetts, 1973;
B.S., Mec.E., 1977; M.S., Mec.E., 1978;
Ph.D., Dartmouth College, 1986.
- BERK SUNAR (2000)
Professor, Electrical and Computer Engineering
B.S., Middle East Technical University (Turkey), 1995;
Ph.D., Oregon State University, 1998.
- RALPH SUTTER (2012)
Instructor/Lecturer, Interactive Media & Game Development
B.A., New England Institute of Art, 2010.
- ROBERT SWARZ (1991)
Professor of Practice, Electrical and Computer Engineering
B.E., New York University, 1967; Ph.D., 1973;
M.S., Rensselaer Polytechnic Institute, 1969;
M.B.A., Boston University, 1981.
- ZACHARY TAILLEFER (2019)
Assistant Teaching Professor, Mechanical Engineering & Aerospace Engineering
B.S., M.S., Ph.D., Worcester Polytechnic Institute, 2011, 2012, 2017.
- DALIN TANG (1988)
Professor, Mathematical Sciences
B.A., Nanjing Institute of Technology, 1981;
Ph.D., University of Wisconsin at Madison, 1988.
- MINGJIANG TAO (2007)
Associate Professor, Civil and Environmental Engineering
B.S., Fuzhou University (China), 1997;
M.S., Tongji University (China), 2000;
Ph.D., Case Western Reserve University, 2003.
- STEVEN S. TAYLOR (2002)
Professor and Dean ad interim, Foisie Business School
B.S., Massachusetts Institute of Technology, 1982;
M.A., Emerson College, 1993;
Ph.D., Boston College, 2000.
- ANDREW R. TEIXEIRA (2017)
Assistant Professor, Chemical Engineering
B.S., Worcester Polytechnic Institute, 2009;
Ph.D., University of Massachusetts, Amherst, 2014.
- YUNUS D. TELLIEL (2018)
Assistant Professor, Humanities and Arts
B.A., Sabanci University, Istanbul Turkey, 2004;
M.Phil., The City University of New York (CUNY), 2012;
Ph.D., 2017.
- BURT S. TILLEY (2009)
Associate Professor, Mathematical Sciences
B.A., University of Lowell, 1988; B.S., 1998;
Ph.D., Northwestern University, 1994.
- MICHAEL TIMKO (2013)
Associate Professor, Chemical Engineering
B.S., The Ohio State University, 1998;
M.S., Massachusetts Institute of Technology, 2001; Ph.D., 2004.
- LYUBOV V. TITOVA (2014)
Associate Professor, Physics
B.Sc., Precarpathian University, Ukraine, 1998;
M.Sc., University of Notre Dame, 2002;
Ph.D., University of Notre Dame, 2005.
- GEOFFREY A. TOMPSETT (2013)
Assistant Research Professor, Chemical Engineering
B.S., M.S., University of Auckland, 1993;
Ph.D., University of Waikato, 1997.
- WALTER T. TOWNER (2007)
*Associate Teaching Professor, Foisie Business School;
Director, Center for Innovative Manufacturing Solutions*
B.S. Worcester Polytechnic Institute, 1983;
M.B.A., Babson College, 1989;
M.S., Worcester Polytechnic Institute 2001, 2003; Ph.D., 2013.
- ANDREW C. TRAPP (2011)
Associate Professor, Foisie Business School;
B.S., Rochester Institute of Technology, 2000;
M.S., Bowling Green State University, 2006;
Ph.D., University of Pittsburgh, 2011.
- ROBERT W. TRAVER (2003)
Teaching Professor, Global School
A.B., Dartmouth College 1975;
M.S., Purdue University, 1980;
Grad Diploma, University of Canterbury, NZ, 1981;
Ed.D., Harvard University, 1991.
- KAREN TROY (2013)
Associate Professor, Biomedical Engineering
B.S., Washington University, St. Louis, 1999; B.S., 1999;
Ph.D., University of Iowa, 2003.

- SETH TULER (2002)
Associate Professor, IGSD
B.A., The University of Chicago, 1984;
M.S., Massachusetts Institute of Technology, 1987;
Ph.D., Clark University, 1996.
- BENGISU TULU (2006)
Associate Professor, Foisie Business School;
B.S., Middle East Technical University (Turkey), 1997;
M.S. 2000;
M.S., Claremont Graduate University, 2003; Ph.D., 2006.
- JAMES L. URBAN (2019)
Assistant Professor, Fire Protection Engineering,
A.B., Case Western Reserve University, 2012;
M.S., Ph.D., University of California, Berkeley, 2014, 2017.
- STEVEN VAN DESSEL (2013)
Associate Professor, Civil and Environmental Engineering
Diploma of Architect, Sint-Lucas Instituut, Brussels, 1990;
Ph.D., University of Florida, 2000.
- RICHARD F. VAZ (1983)
Co-Director of the Director, Center for Project-Based Learning;
Director, Center for Project-Based Learning and IGSD
B.S., Worcester Polytechnic Institute, 1979;
M.S., 1984; Ph.D., 1987.
- KRISHNA VENKATASUBRAMANIAN (2012)
Assistant Professor, Computer Science;
B.S., Webster University, 2001;
M.S., Arizona State University, 2004; Ph.D., 2009.
- BOGDAN M. VERNESCU (1991)
Vice-Provost Research;
Professor, Mathematical Sciences
B.S., University of Bucharest, 1982; M.S., 1982;
Ph.D., Institute of Mathematics - Bucharest, 1989.
- LUIS VIDALI (2009)
Associate Professor, Biology and Biotechnology
B.S., National Autonomous University of Mexico, 1993;
Ph.D., University of Massachusetts, Amherst, 1999.
- DARKO VOLKOV (2004)
Associate Professor, Mathematical Sciences
B.Sc., University of Paris (France), 1993;
Ph.D., Rutgers University, 2001.
- SAM WALCOTT (2019)
Associate Professor, Mathematical Sciences
B.A., Cornell University, 2001;
Ph.D., Cornell University, 2006.
- HAROLD WALKER (2018)
Schwab Professor of Environmental Engineering,
Civil and Environmental Engineering
B.S., California Polytechnic State University, San Luis Obispo,
1991;
M.S., University of California, Irvine, 1994; Ph.D., 1996.
- ROBERT J. WALLS (2016)
Assistant Professor, Computer Science
B.S., M.S., University of Texas at Arlington, 2007, 2009;
Ph.D., University of Massachusetts, Amherst, 2014.
- FANGFANG WANG (2019)
Associate Professor, Mathematical Sciences
B.S., Huazhong Normal University, China, 2003;
Ph.D., Wuhan University, China, 2010.
- GU WANG (2015)
Assistant Professor, Mathematical Sciences
B.S., Peking University, 2007; M.S., 2010;
Ph.D., Boston University, 2013.
- LIBO WANG (1990)
Research Associate Professor, Mechanical Engineering
Diploma, Tsinghua University (China), 1966;
Ph.D., Drexel University, 1991.
- YAN WANG (2010)
Professor, Mechanical Engineering
B.E., Tianjin University, China, 2001; M.S., 2004;
Ph.D., University of Windsor, Ontario, 2008.
- PAMELA J. WEATHERS (1979)
Professor, Biology and Biotechnology
B.S., Marquette University, 1969;
Ph.D., Michigan State University, 1974.
- SUZANNE L. WEEKES (1998)
Interim Associate Dean of Undergraduate Studies
Professor, Mathematical Sciences
B.S., Indiana University, 1989;
M.S., University of Michigan, 1990; Ph.D., 1995.
- DOUGLAS G. WEEKS (1980)
Teaching Professor, Humanities and Arts,
and Associate Head for the Arts;
Coordinator of Music
B.S., University of New Hampshire, 1964;
M.S., Gorham State, 1968;
M.M., University of Massachusetts., 1970;
Ed.D., Boston University, 1987.
- CHAOZEN WEI (2019)
Post-Doctoral Scholar, Mathematical Sciences
B.S., Sichuan University, China, 2012;
Ph.D., The State University of New York at Buffalo, 2017
- QI WEN (2011)
Associate Professor, Physics
B.S., Lanzhou University (China), 1998; M.Eng., 2001;
M.S., Brown University, 2005; Ph.D., 2007.
- JONATHAN WEINSTOCK (2019)
Assistant Teaching Professor, Computer Science
B.S., Penn State University;
M.A., Ph.D., Temple University;
- JOANN WHITEFLEET-SMITH (1995)
Associate Teaching Professor, Biology and Biotechnology
B.A., Hope College, 1976;
M.S., Purdue University, 1979;
Ph.D., University of Wisconsin-Madison, 1984.
- JACOB WHITEHILL (2016)
Assistant Professor, Computer Science
B.S., Stanford University, 2001;
M.S., University of the Western Cape, South Africa, 2007;
Ph.D., University of California, San Diego, 2012.

- CATHERINE F. WHITTINGTON (2018)
Assistant Professor, Biomedical Engineering
B.Sc., Louisiana Tech University, 2006;
Ph.D., Purdue University, 2012.
- JENIFER WILCOX (2018)
Professor, Chemical Engineering
B.S., Wellesley College, 1998;
M.A., Ph.D., University of Arizona, Tucson, 2004.
- CRAIG E. WILLS (1990)
Associate Professor, Computer Science, and Head of Department
B.S., University of Nebraska, 1982;
M.S., Purdue University, 1984; Ph.D., 1988.
- E. VANCE WILSON
Associate Teaching Professor, Foisie Business School
B.A., Reed College, 1974;
M.S., B.A., San Diego State University, 1992;
Ph.D., University of Colorado at Boulder, 1995.
- KRISTIN K. WOBBE (1995)
Co-Director of the Center for Project Based Learning and Director of the Great Problems Seminars Program
Professor, Chemistry and Biochemistry;
B.A., St. Olaf College, 1983
Ph.D., Harvard University, 1991.
- SARAH WODIN-SCHWARTZ (2015)
Assistant Teaching Professor, Mechanical Engineering
B.S., Smith College, 2007;
M.S., University of California, Berkeley, 2009; Ph.D., 2013.
- WILSON WONG (2015)
Assistant Teaching Professor, Computer Sciences
B.S., Massachusetts Institute of Technology, 1989;
M.B.A., Cornell University, 1991;
Ph.D., Bentley University, 2013.
- DUNCAN WRIGHT (2019)
Post-Doctoral Scholar, Mathematical Sciences
M.A., University of Northern Iowa, 2014;
Ph.D., University of South Carolina, 2019 (expected)
- KUN-TA WU (2017)
Assistant Professor, Physics
B.S., National Taiwan University, Taipei, Taiwan, 2003;
M.S., 2005;
Ph.D., New York University, 2014.
- MIN WU (2017)
Assistant Professor, Mathematical Sciences
B.S., Nanjing University, China, 2007;
M.S., University of California, Irvine, 2008; M.Phil., 2012.
- ZHEYANG WU (2009)
Associate Professor, Mathematical Sciences
B.S., Chong Qing University, China, 1998;
M.S., University of New Orleans, 2004;
M.Phil., Yale University, 2007; Ph.D., 2009.
- SHARON WULF (2007)
Professor of Practice, Foisie Business School
B.S., Providence College, 1976;
M.B.A., Northeastern University, 1977;
Ph.D., Columbia Pacific University, 1984.
- ALEXANDER M. WYGLINSKI (2007)
Professor, Electrical and Computer Engineering
B. Eng., McGill University (Canada), 1998; Ph.D., 2004;
M.S., Queen's University (Canada), 2000.
- JING XIAO (2018)
Professor and Director of the Robotics Engineering Program
B.S., Beijing Normal University, China, 1982;
M.S., University of Michigan, Ann Arbor, 1984; Ph.D., 1990.
Ph.D., University of Michigan, Ann Arbor, 1990.
- JAMAL S. YAGOOBI (2012)
Professor, Mechanical Engineering, and Head of Department;
George I. Alden Professorship in Engineering
B.S., Sharif University of Technology (Tehran), 1978;
M.S., University of Illinois (Urbana-Champaign), 1981;
Ph.D., 1984.
- VADIM V. YAKOVLEV (1999)
Assistant Teaching Professor, Mathematical Sciences
M.S., Saratov State University (USSR), 1979; Ph.D., 1984.
- MEI YANG (2017)
Assistant Research Professor, Mechanical Engineering
B.S., Sichuan University, China, 1999; M.S., 2002;
M.S., Pennsylvania State University, 2006;
Ph.D., Worcester Polytechnic Institute, 2012.
- ERIC M. YOUNG (2017)
Assistant Professor, Chemical Engineering
B.S., Chemical Eng. & Biological Eng. University of Maine at Orono, 2008;
Ph.D., University of Texas at Austin, 2013.
- ALI YOUSEFI (2019)
Assistant Professor, Computer Science
B.Sc., Iran University of Science and Technology, 1998;
M.Sc., Sharif University of Technology, Iran, 2000;
Ph.D., University of Southern California, 2014.
- SEYED ZEKAVAT (2018)
Professor, Physics
B.Sc., Shiraz University, Iran;
M.Sc., Sharif University of Technology, Iran;
Ph.D., Colorado State University.
- XIANGRUI ZENG (2019)
Assistant Professor, Robotics Engineering Program and Mechanical Engineering
B.S., M.S., Tsinghua University, China, 2009, 2012;
Ph.D., The Ohio State University, 2016;
- HAICHONG "KAI" ZHANG (2019)
Assistant Professor, Biomedical Engineering/Robotics Engineering
B.S., Kyoto University, Japan, 2011; M.S., 2013;
M.S., John Hopkins University, 2015; Ph.D., 2017.
- PATRICIA ZHANG (2019)
Assistant Professor, Chemistry and Biochemistry
B.S., The University of Texas, 2012;
Ph.D., Princeton University, 2017.

ZHONGQIANG ZHANG (2014)

Assistant Professor, Mathematical Sciences

B.S., Qufu Normal University, China, 2003;
M.S., Shanghai University, China, 2006; Ph.D., 2011;
Ph.D., Brown University, 2014.

ZIMING ZHANG (2019)

Assistant Professor, Electrical and Computer Engineering

B.S., Northeastern University, 2005;
M.S., Simon Fraser University, 2010;
Ph.D., Oxford Brookes University, 2013.

HUILI ZHENG (2015)

Assistant Teaching Professor, Humanities and Arts

B.A., Nanjing University, Nanjing, China, 1995; M.A., 1998;
M.A., University of Toronto, 2003;
Ph.D., University of California, 2010.

YIHAO ZHENG (2019)

Assistant Professor, Mechanical Engineering

B.S.E., Shandong University, China, 2012;
M.S.E., Ph.D., University of Michigan, Ann Arbor, 2014, 2016;

YU ZHONG (2017)

Associate Professor, Mechanical Engineering

B.S., Sichuan University, China, 1997; M.S., 2000;
Ph.D., The Pennsylvania State University, State College, 2005.

H. SUSAN ZHOU (2005)

Associate Professor, Chemical Engineering

B.S., Huazhong University (China), 1996;
M.S., Clarkson University, 1999;
Ph.D., University of California, Irvine, 2002.

JOE ZHU (1998)

Professor, Foisie Business School

Program Director, Ph.D. Program

M.S., Southeast University (China), 1992; Ph.D., 1995;
Ph.D., University of Massachusetts, Amherst, 1998.

KEITH ZIZZA (2011)

Instructor, Computer Science/IMGD

B.S., Northern Essex Community College, UMASS Lowell,
1993.

JIAN ZOU (2014)

Associate Professor, Mathematical Sciences

B.S., Shandong University, China, 2000; M.S., 2002;
M.S., University of Connecticut, 2005; Ph.D., 2009.

ALEX A. ZOZULYA (1998)

Professor, Physics

B.S., Moscow Engineering Physical Institute, 1978;
Ph.D., Lebedev Physics Institute of the Academy of Sciences of
the USSR, 1984.

WALTER ZURAWSKY (2015)

Associate Teaching Professor, Chemical Engineering

B.S., Temple University, 1979;
M.S., University of Illinois Urbana-Champaign, 1983;
Ph.D., 1984.

FACULTY EMERITI

Numerals following name indicate years of service.

ALLEN BENJAMIN (1963-1980)

Professor Emeritus, Civil Engineering

RONALD R. BIEDERMAN (1968-2004)

Professor Emeritus, Mechanical Engineering

JOHN M. BOYD (1966-1994)

Professor Emeritus, Mechanical Engineering

DAVID BROWN (1980-2017)

Professor Emeritus, Computer Science

A. FATTAH CHALABI (1959-1991)

Professor Emeritus, Civil Engineering

RONALD D. CHEETHAM (1973-2006)

Professor Emeritus, Biology and Biotechnology

EDWARD N. CLARKE (1965-1994)

Professor Emeritus

KEVIN A. CLEMENTS (1970-2008)

Professor Emeritus, Electrical and Computer Engineering

THEODORE C. CRUSBERG (1969-2010)

Professor Emeritus, Biology and Biotechnology

DAVID CYGANSKI (1980- 2018)

Professor Emeritus, Electrical and Computer Engineering

ROBERT A. D'ANDREA (1974-2005)

Professor Emeritus, Civil and Environmental Engineering

PAUL DAVIS (1970-2012)

Professor Emeritus, Mathematical Sciences

FRANK D. DEFALCO (1960-1999)

Professor Emeritus, Civil and Environmental Engineering

JAMES S. DEMETRY (1971-2000)

Professor Emeritus, Electrical and Computer Engineering

RICHARD D. DESROSIERS (1972-1991)

Professor Emeritus, Civil Engineering

DAVID B. DOLLENMAYER (1990-2012)

Professor Emeritus, Humanities and Arts

ALEXANDER EMANUEL (1974-2018)

Professor Emeritus, Electrical and Computer Engineering

WILLIAM FARR (1989-2018)

Professor Emeritus, Mathematical Sciences

DAVID FINKEL (1988-2016)

Professor Emeritus, Computer Science

ROBERT W. FITZGERALD (1963-2005)

*Professor Emeritus, Civil and Environmental Engineering and
Fire Protection Engineering*

MALCOM S. FITZPATRICK (1977-2006)

Professor Emeritus, Civil and Environmental Engineering

LEE FONTANELLA (1993-2002)

Professor and Department Head Emeritus, Humanities and Arts

ARTHUR GERSTENFELD (1976-2011)

Professor Emeritus, Management

MICHAEL J. GINZBERG (2015-2020)
Professor and Dean Emeritus, Robert A. Foisie School of Business

LEONARD GOODWIN (1974-1989)
Professor Emeritus, Social Science and Policy Studies

LEON S. GRAUBARD (1969-2002)
Professor Emeritus, Management

ROBERT J. HALL (1956-1990)
Professor Emeritus, Mechanical Engineering and Management; Former Director of Continuing Education

WILLIAM J. HARDELL (1960-1994)
Professor Emeritus, Mathematical Sciences

EDMUND M. HAYES (1964-1997)
Professor Emeritus, Humanities and Arts

CHARLES R. HEVENTHAL (1963-1990)
Professor Emeritus, Humanities

HAROLD W. HILSINGER (1962-1998)
Professor Emeritus, Physics

MICHA HOFRI (1998-2018)
Professor Emeritus, Computer Science

ALLEN HOFFMAN (1970-2017)
Professor Emeritus, Mechanical Engineering

CHICKERY KASOUF (1990-2018)
Professor Emeritus, Management

NICHOLAS K. KILDAHL (1976-2005)
Professor Emeritus, Chemistry and Biochemistry

ROBERT E. KINICKI (1978-2016)
Professor Emeritus, Computer Science

DIETER KLEIN (1979-1999)
Professor Emeritus, Management

MICHAEL W. KLEIN (1979-1995)
Professor Emeritus, Physics

KAREN LEMONE (1981-2008)
Professor Emeritus, Computer Science

KENT P. LJUNGQUIST (1977-2016)
Professor Emeritus, Humanities and Arts

YI (ED) HUA MA, (1967-2015)
Professor Emeritus, Chemical Engineering

J. J. MALONE (1971-2000)
Professor Emeritus, Mathematical Sciences

JO ANN MANFRA (1972-2006)
Professor Emeritus, Humanities and Arts

JOHN A. MAYER (1956-1990)
Professor Emeritus, Mechanical Engineering

BRUCE C. MC QUARRIE (1960-1990)
Professor Emeritus, Mathematical Sciences

LAURA J. MENIDES (1976-2005)
Professor Emeritus, Humanities and Arts

WILLIAM R. MOSER (1981-2000)
Professor Emeritus, Chemical Engineering

WESLEY T. MOTT (1987-2017)
Professor Emeritus, Humanities and Arts

DONALD F. NELSON (1981-2004)
Professor Emeritus, Physics

FRANCIS NOONAN (1978-2008)
Professor Emeritus, Management

MERL M. NORCROSS (1952-1994)
Professor Emeritus, Physical Education and Athletics

ROBERT NORTON (1981-2012)
Professor Emeritus, Mechanical Engineering

JOHN T. O'CONNOR (1970-2010)
Professor Emeritus, Social Science and Policy Studies, and Management

JOHN A. ORR (1977-2016)
Professor Emeritus, Electrical and Computer Engineering

JAMES C. O'SHAUGHNESSY (1986-2012)
Professor Emeritus, Civil and Environmental Engineering

GILBERT H. OWYANG (1961-1990)
Professor Emeritus, Electrical Engineering

E. MALCOLM PARKINSON (1974-2008)
Professor Emeritus, Humanities and Arts

EDWARD A. PARRISH (1995-2004)
Professor Emeritus and President Emeritus

JAMES W. PAVLIK (1974-2007)
Professor Emeritus, Chemistry and Biochemistry

PEDER PEDERSEN (1987-2011)
Professor Emeritus, Electrical and Computer Engineering

JOSEPH PETRUCCELLI (1978-2018)
Professor Emeritus, Mathematical Sciences

ROBERT A. PEURA (1968-2008)
Professor Emeritus, Biomedical Engineering

GEORGE PHILLIES (1985-2015)
Professor Emeritus, Physics

ROBERTO PIETROFORTE (1992-2017)
Professor Emeritus, Civil and Environmental Engineering

RYSZARD PRYPUTNIEWICZ (1978-2015)
Professor Emeritus, Mechanical Engineering

JOSEPH D. SAGE (1957-1994)
Professor Emeritus, Civil Engineering

ALFRED A. SCALA (1966-2011)
Professor Emeritus, Chemistry and Biochemistry

STANLEY M. SELKOW (1980-2012)
Professor Emeritus, Computer Science

THOMAS A. SHANNON (1973-2005)
Professor Emeritus, Humanities and Arts

RUTH SMITH (1983-2017)
Professor Emeritus, Humanities and Arts

MICHAEL M. SOKAL (1970-2005)
Professor Emeritus, Humanities and Arts

KENNETH A. STAFFORD (1999-2019)

Professor Emeritus, Robotics Engineering

ROBERT W. THOMPSON (1976-2015)

Professor Emeritus, Chemical Engineering

HELEN VASSALLO (1968-2018)

Professor Emeritus, Management

DOMOKOS VERMES (1990-2016)

Professor Emeritus, Mathematical Sciences

SUSAN VICK (1981-2018)

Professor Emeritus, Humanities and Arts

HOMER F. WALKER (1997-2018)

Professor Emeritus, Mathematical Sciences

ADRIAAN WALTHER (1972-2001)

Professor Emeritus, Physics

STEPHEN J. WEININGER (1965-2005)

Professor Emeritus, Chemistry and Biochemistry, and Interdisciplinary and Global Studies

ALVIN H. WEISS (1966-1994)

Professor Emeritus, Chemical Engineering

JERALD A. WEISS (1962-1988)

Professor Emeritus, Physics

JOHN F. WILD (1962-1992)

Professor Emeritus, Physics

DOUGLAS W. WOODS (1970-2000)

Professor Emeritus, Social Science and Policy Studies

ROBERT G. ZALOSH (1990-2006)

Professor Emeritus, Fire Protection Engineering

JOHN F. ZEUGNER (1971-2005)

Professor Emeritus, Humanities and Arts

SPECIAL PROFESSORSHIPS

DIRAN APELIAN

Howmet Professorship of Mechanical Engineering

JOSÉ ARGÜELLO

Walter and Mariam B. Rutman Distinguished Professorship in Chemistry (2012-)

NIKOS GATSONIS

John Woodman Higgins Professorship of Engineering (2016-2019)

ARNE GERICKE

John C. Metzger, Jr. Professor in Chemistry (2011-)

FRANK HOY

Paul Beswick Professorship of Innovation and Entrepreneurship (2009-)

JEAN KING

Peterson Family Professorship in Life Sciences and Biology (2017-)

DIANA LADOS

Milton Prince Higgins II Distinguished Professorship in Mechanical Engineering (2014-2017)

RAJIB MALLICK

Ralph H. White Family Distinguished Professorship (2012-)

BRAJENDRA MISHRA

Kenneth G. Merriam Distinguished Professorship in Manufacturing (2015-)

KATHRYN MONCRIEF

Paris Fletcher Distinguished Professorship in the Humanities (2019-)

UMBERTO MOSCO

Harold J. Gay Professorship in Mathematics (2005-)

KAREN KASHMANIAN OATES

Peterson Family Professorship in Life Sciences and Biology (2010-)

CARISSA PEREZ OLSEN

Leonard P. Kinnicutt Professorship (2016-2019)

RICHARD D. SISSON, JR.

George F. Fuller Professorship in Mechanical Engineering (2016-2019)

WINSTON SOBOYEJO

Bernard M. and Sophia Gordon Dean of Engineering (2016-)

HAROLD W. WALKER

Schwaber Professor of Environmental Engineering (2017-)

YAN WANG

William B. Smith Professor (2017-2023)

JAMAL YAGOOBI

George I. Alden Professorship in Engineering (2012-)

BOARD OF TRUSTEES' AWARD FOR OUTSTANDING SERVICE

1989 WILLIAM R. GROGAN

BOARD OF TRUSTEES' AWARD FOR OUTSTANDING RESEARCH AND CREATIVE SCHOLARSHIP

1981 KEVIN A. CLEMENTS

1982 AUDREY M. HARRIS

1983 LEONARD GOODWIN AND DAVID P. MC KAY

1984 ALVIN H. WEISS

1985 LEONARD B. SAND

1986 ALEXANDER E. EMANUEL

1987 MICHAEL W. KLEIN

1988 THOMAS A. SHANNON AND MICHAEL M. SOKAL

1989 ALLEN H. HOFFMAN

1990 PAUL W. DAVIS AND L. RAMDAS RAM-MOHAN

1991 RSYZARD J. PRYPUTNIEWICZ

1992 GEORGE D. J. PHILLIES

1993 WESLEY T. MOTT

1994 YI H. MA

1995 DONALD F. NELSON

1996 DAVID CYGANSKI

1996 ALBERT SACCO, JR.

1996 CHRISTOPHER H. SOTAK

1997 DAVID C. BROWN
1998 KENT P. LJUNGUIST
1999 WILLIAM R. MOSER
2000 PAMELA J. WEATHERS
2001 BARBARA E. WYSLOUZIL
2002 W. GRANT MCGIMPSEY
2003 STEVEN C. BULLOCK
2004 NIKOLAOS A. GATSONIS
2005 HOMER F. WALKER
2006 DIRAN APELIAN
2007 ELKE A. RUNDENSTEINER
2008 JOEL J. BRATTIN
2009 ANTHONY G. DIXON
2010 DALIN TANG
2011 KAVEH PAHLAVAN
2012 JOSÉ ARGÜELLO
2013 ROGER GOTTLIEB
2014 DIANE STRONG
2015 UMBERTO MOSCO
2016 RICHARD D. SISSON, JR.
2017 NEIL T. HEFFERNAN
2018 KRISTIN BOUDREAU
2019 YAN WANG

**BOARD OF TRUSTEES' AWARD FOR
OUTSTANDING TEACHING**

1975 ROMEO L. MORUZZI
1976 JOHN M. BOYD
1977 FRANK D. DEFALCO
1978 THOMAS H. KEIL
1979 CARLTON W. STAPLES
1980 ALLEN H. HOFFMAN
1981 JAMES W. PAVLIK
1982 ALEXANDER E. EMANUEL
1983 HARTLEY T. GRANDIN, JR.
1984 DAVID CYGANSKI
1985 JOHN F. ZEUGNER
1986 DAN H. WOLAVER
1987 RICHARD D. SISSON, JR.
1988 PATRICK P. DUNN
1989 HAROLD W. HILSINGER
1990 DAVID S. ADAMS
1991 ROBERT LONG II
1992 ANDREAS N. ALEXANDROU
1993 RICHARD F. VAZ
1994 L. RAMDAS RAM-MOHAN
1995 JAMES S. DEMETRY

1996 VAN BLUEMEL
1996 NICHOLAS K. KILDAHL
1997 SUSAN VICK
1998 LEONARD D. ALBANO
1999 JOHN A. MCNEILL
2000 STEPHEN J. WEININGER
2001 STEPHEN N. JASPERSON
2002 CHRYSANTHE DEMETRY
2003 HELEN G. VASSALLO
2004 JUDITH E. MILLER
2005 ROBERT L. NORTON
2006 JEANINE D. PLUMMER
2007 JOHN A. GOULET
2008 PETER R. CHRISTOPHER
2009 STEPHEN J. BITAR
2010 SATYA SHIVKUMAR
2011 WILLIAM W. FARR
2012 SERGEY MAKAROV
2013 MARK RICHMAN
2014 SHARON WULF
2015 GARY POLLICE
2016 KENT P. LJUNGUIST
2017 STEPHEN J. KMIOTEK
2018 NATALIE FARNY
2019 KENNETH STAFFORD

**TRUSTEES' AWARD FOR OUTSTANDING
ACADEMIC ADVISING** (Formerly Tau Beta Pi Award, 1991-1999)

1991 JOHN F. ZEUGNER
1992 MARY M. HARDELL
1993 JOHN GRIFFIN
1994 KENT P. LJUNGUIST
1995 ROBERT A. D'ANDREA
1996 LEONARD D. ALBANO
1997 JILL RULFS
1998 MICHAEL A. GENNERT
1999 RICHARD F. VAZ
2000 DAVID S. ADAMS
2001 ALEXANDER E. EMANUEL
2002 PHILLIP E. ROBAKIEWICZ
2003 JONATHAN R. BARNETT
2004 GEORGE D. PINS
2004 ANN GARVIN
2005 JEANINE D. PLUMMER
2006 CAROLANN KOLECI
2007 JON P. ABRAHAM
2008 KRISTEN BILLIAR

2009 SERGEY N. MAKAROV
 2010 HOLLY K. AULT
 2011 DAVID S. ADAMS
 2012 MARSHA ROLLE
 2013 DESTIN HEILMAN
 2014 CHRYSANTHE DEMETRY
 2015 SONIA CHERNOVA
 2016 JON ABRAHAM
 2017 JOHN M. SULLIVAN
 2018 SOUSSAN DJAMASBI
 2019 SCARLET SHELL

**DENISE NICOLETTI TRUSTEES' AWARD FOR
 SERVICE TO COMMUNITY**

2003 JAMES P. O'ROURKE
 2004 WILLIAM A. BALLER
 2005 HOLLY K. AULT
 2006 ALLEN H. HOFFMAN
 2007 ELIZABETH TOMASZEWSKI
 2008 CHRISTOPHER BARTLEY
 2009 HOSSEIN HAKIM
 2010 KENNETH A. STAFFORD
 2011 ROBERT KRUEGER
 2012 CHRISTINE DREW
 2013 JANET BEGIN RICHARDSON
 2014 CHRYSANTHE DEMETRY
 2015 SUZANNE WEEKES
 2016 BRIAN SAVILONIS
 2017 ADRIENNE HALL-PHILLIPS
 2018 ARTHUR C. HEINRICHER
 2019 LINDA LOOFT

**TRUSTEES' AWARD FOR OUTSTANDING
 STAFF MEMBER**

2014 CAROL GAROFOLI
 WAYNE ATCHUE
 2015 MARGARET BRODMERKLE
 JENNIFER CLUETT
 2016 MICHAEL DORSEY
 RHONDA PODELL
 2017 PAUL REILLY
 LISA WALL
 2018 ALLISON DARLING
 SUZANNE SONTGERATH

- Academic Advising 10
 Academic Honesty Policy 212
 Academic Probation 214
 Academic Progress 214
 Academic Resources Center 226
 Academic Suspension 214
 Academic Warning 214
 Accreditation 285
 Actuarial Mathematics 101
 Actuarial Mathematics Major Program Chart 100
 Administration 256
 Administrative Obligations and Holds 215
 Admission 242
 Admissions Requirements 242
 Advanced Placement 243
 Application Fee 242
 Applying to WPI 242
 - Decision to Matriculate 242
 - English as a Second Language (ESL) Program 245
 - Financial Aid 242
 - International Students 245
 - New Student Orientation 244
 - Notification 242
 - Revocation of Admission 242
 - Transfer Students 244
 - Visiting & Interviewing 242
- Advising 10
 Aerospace Engineering 29, 125
 Aerospace Engineering Major Course Flow Chart 31
 Aerospace Engineering Program Chart 30
 Air Force Aerospace Studies 32, 126
 Applied Physics 111
 Architectural Engineering 33, 128
 Architectural Engineering Program Chart 35
 Athletic Programs 110
 Awards and Prizes 231
- Bachelor/Master's Program 222
 Basic Sciences 129
 Biochemistry 54
 Bioinformatics and Computational Biology 36, 129
 Bioinstrumentation 42
 Biology and Biotechnology 37, 130
 Biology and Biotechnology Lab Courses 133
 Biomaterials 43
 Biomaterials and Tissue Engineering 43
 Biomechanics 42
 Biomedical Engineering 39, 135
 Biomedical Engineering Lab Courses 137
 Biomedical Engineering Program Chart 41
 Biomedical Engineering Specializations 42
 Biomedical Instrumentation, Biosignals and Image Processing 42
 Biosignals 42
 Business 44
 Business/Management Engineering/Management Information Systems Overview of Degree Requirements 45
 Business, Robert A. Foisie School of 44, 138
 - Accounting (ACC) 138
 - Business (BUS) 138
 - Entrepreneurship (ETR) 139
 - Finance (FIN) 140
 - Management Information Systems (MIS) 140
 - Marketing (MKT) 141
 - Operations and Industrial Engineering (OIE) 141
 - Organizational Behavior and Change (OBC) 142
- Campus Map 286
 Career Development and Graduate School Advising 236
 Career Development Center 236
 Change of Registration Information 217
 Changing Project Advisor 217
 Check-In 216
 Chemical Engineering 52, 142
 Chemistry 55
 Chemistry and Biochemistry 54, 144
 - Advanced Chemistry Courses 147
 - Biochemistry Courses 146
 - Experimental Chemistry Sequence 145
 - General Chemistry Sequence 144
 - Inorganic and Physical Chemistry Courses 146
 - Organic Chemistry Courses 145
- Civil and Environmental Engineering 57, 148
 Civil Engineering Program Chart 59
 Class Year 212
 College Awards 231
 Combined Bachelor/Master's Program 222
 Commencement 212
 Commitment to Pluralism 4
 Computer Science 60, 150
 Computer Science Concentrations 63
 Computer Science Courses for Majors Flow Chart 62
 Computer Science Courses for Non-Majors Flow Chart 64
 Computer Science Program Chart 63
 Concentration in Psychobiology 120
 Concentrations 11
 Concentrations for Chemical Engineering Majors 53
 Concentrations for Humanities and Arts Majors 77
 Cooperative Education 228
 Counseling Center 226
 Course Changes 216
 Course Descriptions 124
 Courses Qualifying for Engineering Distribution Areas 124
 Cross-Registration 228
 Currency of Information 284
- Data Science 65, 154
 Data Science Courses for Majors Flow Chart 68
 Data Science Major Program Chart 67
 Degree Audits 216
 Degree Options 11
 Degree Requirements 7
 Department and Program Descriptions 29
 Designation of Class Year 212
 Designation of Major Area of Study 212
 Directions 285
 Directory Information and Release of Information 215
 Double Major 212
 Double Majors 12

- Early Completion 212
 Economic Science Program 118
 Electrical and Computer Engineering 70, 155
 Electrical and Computer Engineering Course Flow Chart 72
 Engineering Registration and Licensing 234
 Engineering Science Courses 73
 Engineering Science Interdisciplinary 158
 Engineering Societies 234
 English as a Second Language (ESL) Program 245
 Enrollment and Tuition Due Dates 245
 Environmental Concentration 59
 Environmental Engineering 74
 Environmental Engineering Program Chart 75
 Exchanges 227
 Expenses 245
 Enrollment and Tuition Due Dates 245
 Estimated Expenses 245
 Financial Aid Upon Withdrawal/Suspension 246
 Financial Obligations, Holds 246
 Late Fees 246
 Overload Charges 246
 Payment of Tuition Deposit 245
 Room & Board Charges Upon Withdrawal or Suspension 246
 Tuition Charges Upon Withdrawal or Suspension 246
 Faculty 257
 Financial Aid 247
 Alternative Financial Programs 250
 Application Procedures - Prospective Student 247
 Financial Aid Policies 249
 Forms of Aid 248
 Reserve Officer Training Corps (ROTC) Scholarships 250
 Financial Obligations, Holds, and Late Fees 246
 Fire Protection Engineering 76, 160
 First Year Students 222
 Fundamentals of Engineering Exam 60
 Fundamentals of Engineering Examination (F.E.E.) 234
 Gateway Park 222
 George C. Gordon Library 225
 Geosciences (GE) 129
 Global Projects Program 19
 Goal of WPI 3
 Grade Appeal and Grade Change Policy 209
 Grades 208
 Cumulative Point Average 209
 Dean's List 209
 Grades for Completion of Degree Requirements 208
 Grading System 208
 Incomplete 208
 No Record 208
 Other Grades 208
 Project Grading 208
 Satisfactory Progress 208
 Graduate Courses 222
 Graduate Programs 237
 Graduate Study 237
 Admission 238
 Combined BS/MS Programs 238
 Financial Aid 238
 Five Year Programs 239
 Part-Time Graduate Programs: Online and Campus-Based Study 239
 Registration and Tuition Payment 238
 Scholarships and Grants for Graduate Study Abroad 239
 Graduation 216
 Graduation with Honors 211
 HECCMA Course Cross-Registration 228
 Holds 215
 Honesty Policy 212
 Housing 251
 Furnishings and Facilities 251
 Lodging Laws 252
 Meals 252
 Occupancy 251
 Off-Campus Living 252
 Residence Halls 251
 Residence Hall Staff 251
 Room Charges 251
 Roommates 251
 Humanities and Arts 76, 161
 Humanities and Arts Advisors 220
 Humanities and Arts Courses
 Arabic (AB) 161
 Art History/Architecture (AR) 161
 Chinese (cn) 163
 English (EN) 163
 English for International Students 166
 German (GN) 166
 History (HI) 167
 Humanities (HU) 170
 International and Global Studies 171
 Music Ensembles (MU) 174
 Music (MU) 172
 Philosophy (PY) 174
 Religion (RE) 176
 Writing (WR) and Rhetoric (RH) 178
 Humanities and Arts Minors 80
 American Studies 80
 Chinese Studies 81
 Drama/Theatre 82
 English 82
 History 83
 Language (German or Spanish) 82
 Media Arts 83
 Music 83
 Philosophy and Religion 84
 Writing and Rhetoric 84
 Humanities and Arts Requirement 22
 Humanities and Arts with American Studies Concentration 77
 Humanities and Arts with Environmental Studies Concentration 78
 Humanities and Arts with Humanities Studies of Science and Technology Concentration 79
 Image Processing 43
 Independent Study 179, 218
 Individually Sponsored On-Campus IQP Programs 21
 Center for Sustainable Food Systems 21
 Energy Sustainability Project Center 21
 STEM Education Project Center 21
 Sustaining WPI Project Center 21
 Individually Sponsored Residential Projects 21
 Industrial Engineering 48

- Industrial Engineering Overview of Degree Requirements 49
- Information Technology Services 223
- Interactive Media & Game Development 84, 179
- Interactive Media & Game Development (Bachelor of Arts) 85
- Interactive Media & Game Development Technology (Bachelor of Science) 86
- Interactive Qualifying Project 18
- Interdisciplinary 182
- Interdisciplinary and Global Studies 87
- Interdisciplinary Minors 88
- International and Global Studies 92
- International Development, Environment, and Sustainability 90
- International Development, Environment, and Sustainability (IDEaS) (Bachelor of Arts Degree) 90
- International Students 245
- Language Requirements 227
- Late Fees 246
- Leave of Absence 218
- Liberal Arts and Engineering (Bachelor of Arts Degree) 95
- Library 225
- Major Area of Study 212
- Major Areas of Study 8
- Major in Environmental and Sustainability Studies 91
- Major Qualifying Project 17
- Management Engineering 47
- Management Information Systems 47
- MASH (Math and Science Help) Program 226
- Materials Engineering 107
- Mathematical Sciences 97, 184
- Mathematical Sciences Major Program Chart 99
- Mechanical Engineering 102, 189
- Mechanical Engineering Department Concentrations 103
- Mechanical Engineering Program Chart 105
- Military Science 108, 192
- Military Science Course Flow Chart 108
- Minor in Aerospace Engineering 32
- Minor in Architectural Engineering 34
- Minor in Astrophysics 114
- Minor in Biochemistry 56
- Minor in Bioinformatics and Computational Biology 37
- Minor in Biology 38
- Minor in Business 50
- Minor in Chemistry 56
- Minor in Computer Science 63
- Minor in Data Science 66
- Minor in Electrical and Computer Engineering 73
- Minor in Entrepreneurship 50
- Minor in Environmental and Sustainability Studies 91
- Minor in Global Public Health 88
- Minor in Industrial Engineering 50
- Minor in Interactive Media & Game Development 87
- Minor in International and Global Studies 92
- Minor in Law and Technology 121
- Minor in Management Information Systems 51
- Minor in Manufacturing Engineering 106
- Minor in Materials 107
- Minor in Mathematics 102
- Minor in Mechanical Engineering 106
- Minor in Nanoscience 89
- Minor in Physics 113
- Minor in Robotics Engineering 117
- Minor in Science and Engineering for Development 92
- Minor in Social Entrepreneurship 51
- Minor in Statistics 101
- Minor in Sustainability Engineering 89
- Minors 11
- Minors in Social Science 121
- Mission of WPI 3
- MQP Learning Outcomes 17
- MQP Majors and Coordinators 219
- MQP Project Centers 17
- Tufts University Cummings School of Veterinary Medicine 17
- University of Massachusetts Medical School Project Center 17
- Music and Theatre Facilities 224
- Neoma Business School, Reims & Rouen, France; Exchange 227
- New Student Orientation 244
- Non-Degree Students 219
- Obligations 215
- Off-Campus Insurance and Legal Agreements 218
- Off-Campus Programs 19
- Office of Disability Services 226
- Office of the Registrar 216
- Official Withdrawal or Leave of Absence 218
- On-Campus IQP Programs 21
- Overloads of Courses 216
- Overload with Project 217
- Part-Time Degree Students 219
- Pay and Credit 217
- Payment of Tuition Deposit 245
- Physical Education 194
- Physical Education, Recreation, and Athletics 109
- Physics 110, 195
- Physics and Applied Physics Programs Advising 111
- Policies and Procedures 208
- Policies & Practices 284
- Pre-Professional Programs 114
- Five-Year Dual Bachelor/M.S. in Management (MSMG) 114
- Pre-Health Programs 115
- Pre-Law Programs 115
- Teacher Preparation Program 115
- Prizes 231
- Probation 214
- Professionally Accredited Programs 9
- Professional Writing 79
- Program in Actuarial Mathematics 101
- Program in Applied Physics 111
- Program in Mathematical Sciences 98
- Project Completion 217
- Project Conferences 217

- Project Grading 208
Project Lead The Way 243
Project Planning 217
Project Registration 217
Project Registration Topic Codes 219
Projects 217
Projects and Research 14
Psychological Science Program 119
- Qualifying Project Grading 14
- Records and Audits 216
Registration 216
Registration Policy for Degree Requirements 217
Release of Information 215
Resources and Special Programs 222
Return from Leave of Absence 219
Robotics Engineering 116, 197
- Social Science and Policy Studies 117, 198
 Development 198
 Economics 199
 Environmental And Sustainability Studies 200
 General Social Science 206
 Political Science, Government and Law 201
 Psychology 203
- Society/Technology Studies 206
Sociology 205
System Dynamics 205
Social Science Requirement 27
Societies, Registration and Licensing 234
Society, Technology, and Policy Program 120
Spanish (SP) 176
Special Awards 231
Special Programs 222
Special Programs for First Year Students 222
Statement of Values for Undergraduate Education at WPI 3
Student Development and Counseling Center 226
Student Exchanges 227
Student Services 226
Student Development and Counseling Center 226
Subareas of Civil Engineering 58
Summer Session (Term E) 230
Suspension 214
- Tissue Engineering 43
Transcript Fees 216
Transfer Credit 211
Transfer Students 244
Trustees 254
Tuition Charges Upon Withdrawal or Suspension 246
Two Towers Tradition: The Second Century 5
- Undergraduate Learning Outcomes 4
University of Applied Sciences; Konstanz, Germany; Exchange 227
University Policies and Procedures 208
- Wait Lists 216
Warning 214
Withdrawal from Courses 216
WPI Plan 5
Writing Center 226
Writing Courses and Advisors 227

NOTICE OF NONDISCRIMINATORY POLICY AS TO STUDENTS

It is the policy of Worcester Polytechnic Institute that each qualified individual, regardless of race, color, sex, religion, sexual orientation, national origin, age as defined by law, or handicap, shall have equal opportunity in education, employment or services of Worcester Polytechnic Institute. It is the policy of WPI to follow U.S. federal government eligibility guidelines in the administration of its institutional financial aid program.

STUDENT RESPONSIBILITIES FOR ETHICAL AND PROFESSIONAL CONDUCT

WPI expects all its students to demonstrate the highest sense of honor in respecting academic and professional traditions such as acknowledging the borrowing or use of other people's ideas. Willful violations (like plagiarism) of such academic traditions or of legal restrictions (like those regarding copyright) will be considered violations of the "Campus Code" as described in the Student Planner.

WPI education is strongly committed to project-based learning, to providing students with access to state-of-the-art technology, and to working with professionals, on and off campus. Therefore, when students are exposed to proprietary and/or confidential information, they must accept responsibilities appropriate to their preparation for life-long careers in which codes of ethics govern professional conduct.

Facilities such as the off-campus projects, employment sites, and on-campus laboratories permit students to gain experience with techniques at the forefront of industrial and research development. With this access comes the added responsibility of safeguarding students of any agreements they sign regarding conditions or restrictions for access to certain equipment or information will also be considered a violation of the "Campus Code" as described in the Student Planner.

Record of any penalties assigned by the WPI Campus Judicial System which result from violation of standards of ethical conduct will become a permanent part of that student's disciplinary record.

STUDENT ABSENCE DUE TO RELIGIOUS BELIEFS

Section 2B, Chapter 151C of the General Laws of the Commonwealth of Massachusetts: "Any student in an educational or vocational training institution, other than a religious or denominational educational or vocational training institution, who is unable, because of his/her religious beliefs, to attend classes or to participate in any examination, study, or work requirement on a particular day shall be excused from any such examination or study or work requirement, and shall be provided with an opportunity to make up such examination, study, or work requirement which he/she may have missed because of such absence on any particular day; provided, however, that such makeup examination or work shall not create an unreasonable burden upon such school. No fees or any kind shall be charged by the institution for making available to the said student such opportunity. No adverse or prejudicial effects shall result to any students because of his/her availing himself/herself of the provisions of this section."

POLICY FOR INSTITUTIONAL CHARGES AND REFUNDS FOR STUDENTS CALLED TO MILITARY ACTION

WPI recognizes the obligations of our students who are called to active duty by the U.S. Military. To support these students WPI has established this policy to facilitate their transition from, and back to active student status.

Such students shall receive 100% refund for the uncompleted term(s) of the semester at the date of the notice. If such student has a loan obligation to WPI they will be granted an in-school deferment status during the period of active duty service, not to exceed a total of three years.

To initiate the process to be classified "On leave for military service" the student must indicate, in writing, that he/she is requesting school deferment status while being called to active duty. A copy of the official call to active duty notice from the military must be included with this request and be submitted to the Registrar's Office.

CURRENCY OF INFORMATION

The information contained in this Undergraduate Catalog is not a complete statement of all the policies, practices, rules and regulations of Worcester Polytechnic Institute. Any statement made in this publication is for current informational purposes only and is subject to change by the governing body of WPI or its duly authorized representatives. Certain policies, rules and regulations are not published in this publication but are promulgated directly by the appropriate department. Members of the WPI community are expected to abide by the current policies, practices, rules and regulations of the college, even

though they may not be contained in this publication or may not be consistent with the information contained in this publication, whether due to a properly authorized change or to a printing error.

Changes, deletions, and additions authorized by the governing body of WPI, after the printing of this catalog, are posted on WPI's web page at www.wpi.edu/ as a supplement to the undergraduate catalog, and includes the effective date of the action.

Worcester Polytechnic Institute is accredited by the New England Association of Schools and Colleges, Inc., through its Commission on Institutions of Higher Education.

Accreditation of an institution of higher education by the New England Association indicates that it meets or exceeds criteria for the assessment of institutional quality periodically applied through a peer review process. An accredited college or university is one which has available the necessary resources to achieve its stated purposes through appropriate educational programs, is substantially doing so, and gives reasonable evidence that it will continue to do so in the foreseeable future. Institutional integrity is also addressed through accreditation.

Accreditation by the New England Association is not partial but applies to the institution as a whole. As such, it is not a guarantee of every course or program offered, or the competence of individual graduates. Rather, it provides reasonable assurance about the quality of opportunities available to students who attend the institution.

Inquiries regarding the accreditation status by the New England Association should be directed to the Office of the Provost.

The aerospace engineering, architectural engineering, biomedical engineering, chemical engineering, civil engineering, electrical and computer engineering, environmental engineering, industrial engineering, and mechanical engineering programs are accredited by the Engineering Accreditation Commission of ABET, <http://www.abet.org>

The Chemistry and Biochemistry Department and its program at WPI are approved by the American Chemical Society for a major in chemistry or biochemistry. Those chemistry majors who complete a program satisfying the guidelines established by the American Chemical Society are certified to that organization as having received an undergraduate professional education in chemistry or biochemistry.

The undergraduate and graduate business offerings in the Robert A. Foisie School of Business are accredited by AACSB International, the Association to Advance Collegiate Schools of Business. AACSB International is a not-for-profit organization consisting of more than 900 educational organizations and corporations. Its mission is excellence in management education in colleges and universities. Headquartered in Tampa, Florida, AACSB International is the premier accrediting agency and service organization for business schools.

DIRECTIONS

DRIVING TO WPI

FROM THE EAST:

Take Mass. Turnpike (I-90) to Exit 11A (I-495). Proceed north to I-290, then west into Worcester. Take Exit 18, turn right at end of ramp, then an immediate right before next traffic light. At next light, proceed straight through, bearing to the right on Salisbury St. At the WPI sign, turn left onto Boynton St., then right onto Institute Rd., then right onto West St. Visitor parking is on the left after footbridge.

FROM THE NORTH:

Take I-495 south to I-290. Follow directions as from east.

FROM THE SOUTH AND WEST:

Take Mass. Turnpike (I-90) to Exit 10 (Auburn). Proceed east on I-290 into Worcester. Take Exit 17, turn left at end of ramp, follow Rte. 9 west through Lincoln Sq., straight onto Highland St., then right at light onto West St. and through first intersection. Visitor parking is on the left after footbridge.

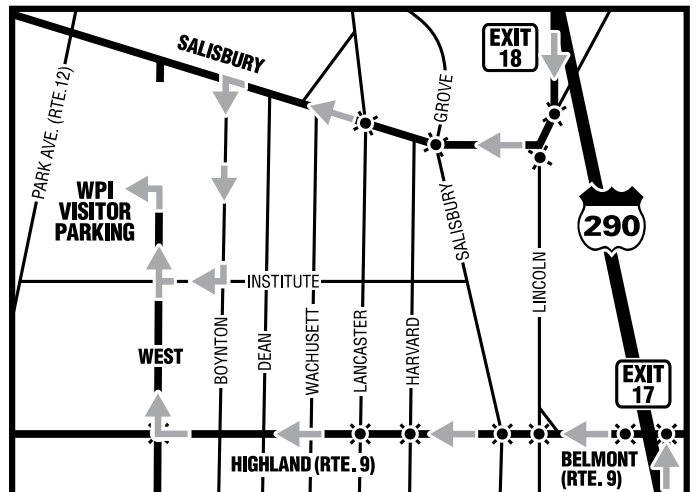
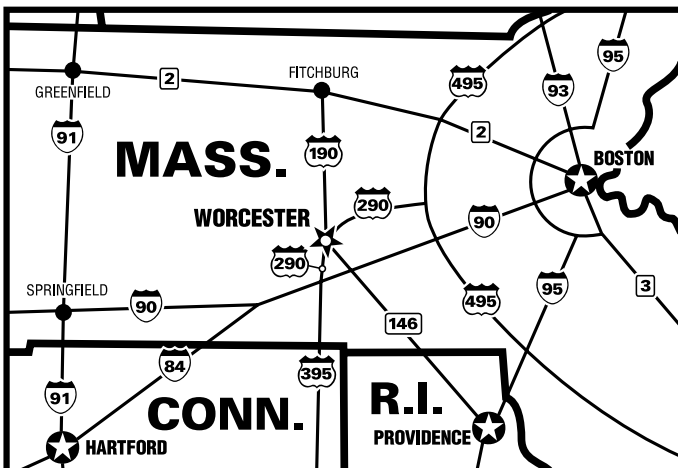

Campus Map



100 Institute Road
Worcester, MA, 01609

GPS Address
(Parking Garage):
151 Salisbury Street

KEY

- University Buildings
- Student Residences
- Greek Houses
- P Parking



RESIDENTIAL BUILDINGS

- A Hackfield House
- B Stoddard Complex
- C Morgan Hall
- D Ellsworth Apartments
- E Trowbridge House
- F Daniels Hall
- G Fuller Apartments
- H Messenger Hall
- I Sanford Riley Hall
- J Schussler House
- K Salisbury Estates
- L Elbridge House
- M East Hall
- N Founders Hall
- O Institute Hall
- P Faraday Hall

GREEK HOUSES

- G1 Alpha Xi Delta
- G2 Alpha Tau Omega
- G3 Alpha Pi
- G4 Alpha Gamma Delta
- G5 Phi Sigma Sigma
- G6 Sigma Phi Epsilon
- G7 Phi Gamma Delta
- G8 Alpha Chi Rho
- G9 Sigma Pi
- G10 Phi Sigma Kappa
- G11 Theta Chi
- G12 Zeta Psi
- G13 Lambda Chi Alpha
- G14 Phi Kappa Theta
- G15 Tau Kappa Epsilon
- G16 Sigma Alpha Epsilon
- G17 Chi Omega

See reverse side for campus directory.

Visit maps.wpi.edu for interactive map.

UNIVERSITY BUILDINGS

- 1 37 Lee Street
- 2 One Drury Lane
- 3 15 Regent Street
- 4 27 Hackfield Road
- 5 32 Hackfield Road
- 6 Sports & Recreation Center
- 7 Harrington Auditorium
- 8 Einhorn Road
- 9 28 Trowbridge Road
- 10 20 Trowbridge Road
- 11 Higgins House
- 12 Rubin Campus Center
- 13 Foisie Innovation Studio
- 14 Bartlett Center
- 15 15-19 Schussler Road
- 16 Goddard Hall
- 17 Olin Hall
- 18 Higgins Laboratories
- 19 Aiden Memorial
- 20 Schussler Road
- 21 Project Center
- 22 Stratton Hall
- 23 157 West Street
- 24 Atwater Kent Laboratories
- 25 Salisbury Laboratories
- 26 Washburn Shops and Stoddard Laboratories
- 27 Power House
- 28 Boynton Hall
- 29 Fuller Laboratories
- 30 Gordon Library
- 31 Kaven Hall
- 32 Skull Tomb
- 33 Campus Police
- 34 35/37 Institute Road
- 35 108 Grove Street
- 36 85 Prescott Street
- 37 60 Prescott Street
- 38 50 Prescott Street

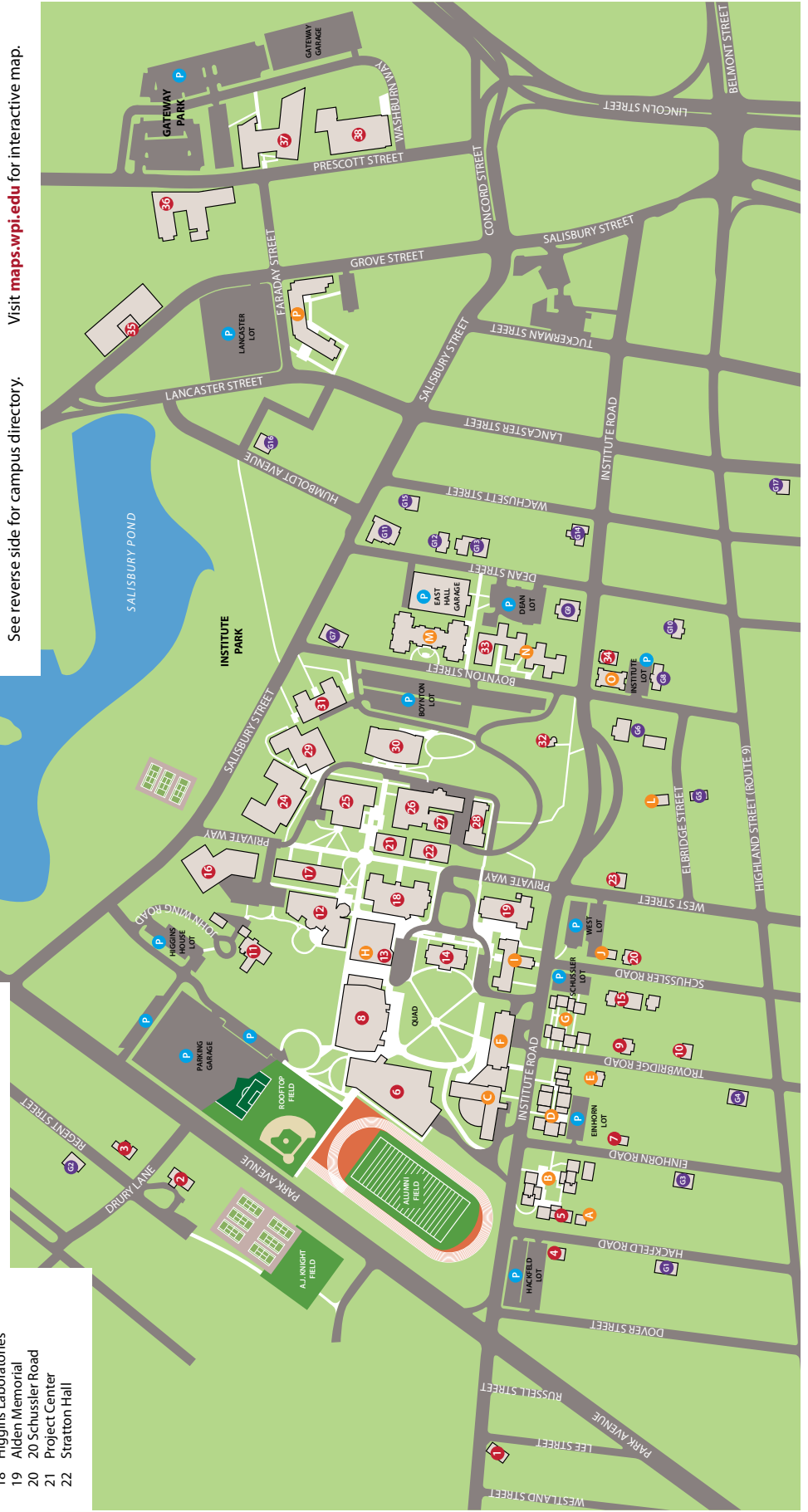



Worcester Polytechnic Institute
100 Institute Road
Worcester, MA 01609-2280
wpi.edu