

# WPI

## UNDERGRADUATE CATALOG 2008 – 2009

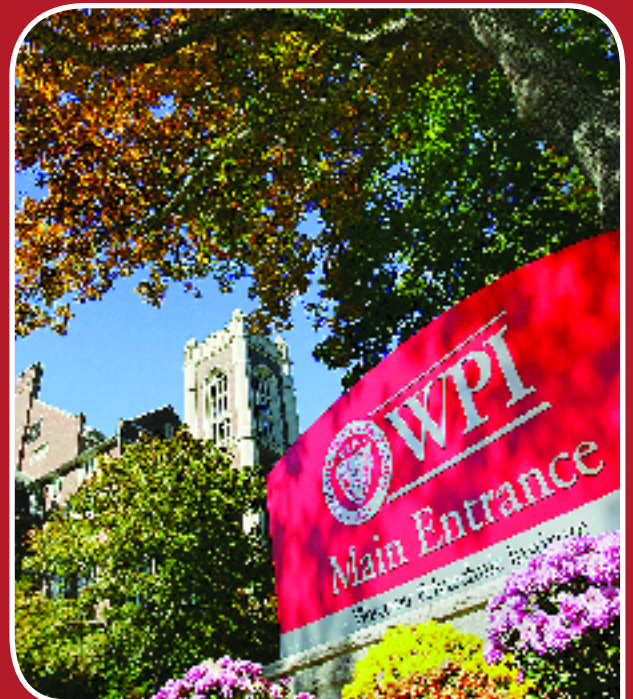
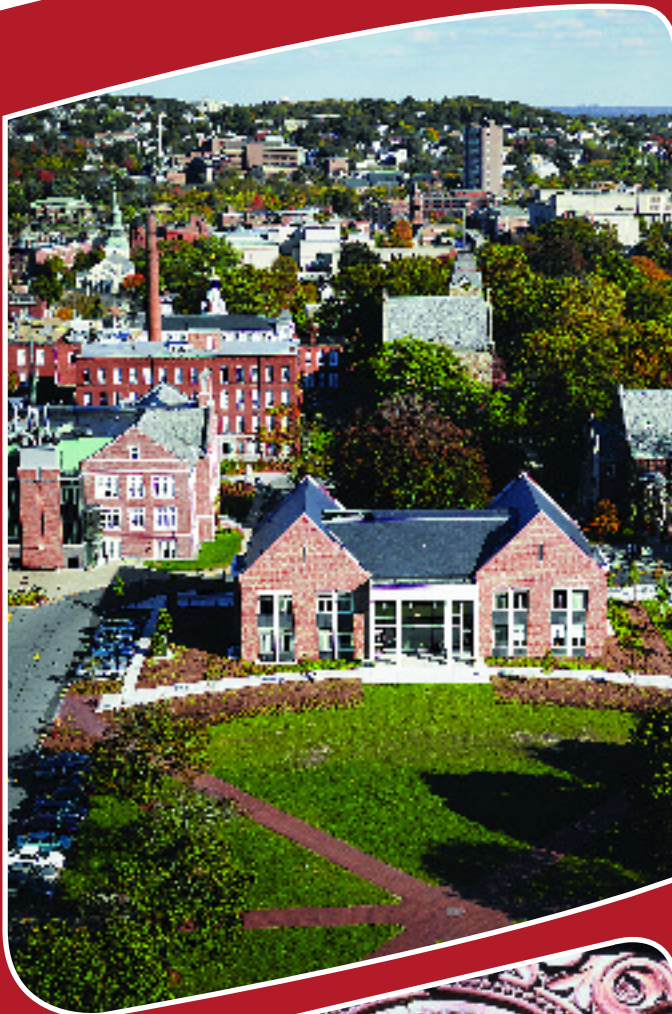

# CHRONOLOGY OF ACADEMIC SCHEDULE AND EVENTS

---

## 2007-2008 ACADEMIC YEAR

---

January 2	Tuition for Terms C and D Due
January 6	Residence Halls Open for Term C
<b>January 7-11</b>	<b>Web Enrollment for Spring Semester</b>
January 9	Deadline for Completion of Degree Requirement Forms for February 2008 Candidates
<b>January 10</b>	<b>First Day of Classes, Term C</b>
January 14	First Day of Classes for Graduate Courses
January 30	President's IQP Award Competition
February 14	Advising Appointment Day (No Undergraduate Classes)
February 28	Last Day of Classes, Term C
February 29	Reserved for Weather-Cancellation Makeup
February 29- March 10	Spring Recess
<b>March 11</b>	<b>First Day of Classes, Term D</b>
April 15	Project Presentation Day (No Undergraduate Classes)
April 24	Deadline for Completion of Degree Requirement Forms for May 2008 Candidates
April 25	Last Day of Classes for Semester Courses
April 29	Last Day of Classes, Term D
May 1	12 noon - Residence Halls Close
May 16	Baccalaureate Ceremony
May 17	Spring Commencement
May 26	Memorial Day Holiday
<b>May 27</b>	<b>First Day of Classes, Summer Session</b>
June 5-8	Alumni Reunion
July 4	Independence Day Holiday (No Classes)
August 27	Deadline for Completion of Degree Requirement Forms for Fall 2008 Candidates

---

## 2008-2009 ACADEMIC YEAR

---

July 31	Tuition for Terms A and B Due
August 24	Residence Halls Open for NEW Students; New Student Orientation (Freshmen/Transfer) Begins
August 25	Residence Halls and Apartments Open for Returning Students
<b>August 25-29</b>	<b>Web Enrollment for Fall Semester</b>
August 27	Deadline for Completion of Degree Requirement Forms for Fall 2008 Graduation
<b>August 28</b>	<b>First Day of Classes, Term A</b>
August 28	(Thurs.) Follow Monday Class Schedule
September 1	Labor Day Holiday (No Classes)

September 2	First Day of Classes for Graduate Courses
September 19-21	Parent's Day
September 26	President's IQP Awards Entry Deadline
October 3-4	Homecoming
October 16	Last Day of Classes, Term A
October 17-27	Fall Recess
<b>October 28</b>	<b>First Day of Classes, Term B</b>
October 28	(Tues.) Follow Friday Class Schedule
November 26-30	Thanksgiving Recess (Last Day of Class - Undergraduates - November 25) (Last Day of Class - Graduate Students - November 24)
December 18	Last Day of B-term Classes
December 19	12 noon - Residence Halls Close for Term Break
December 19- January 14, 2009	Winter Recess
January 5	Tuition for Terms C and D Due
January 11	Residence Halls Open for Term C
<b>January 12-16</b>	<b>Web Enrollment for Spring Semester</b>
January 14	Deadline for Completion of Degree Requirement Forms for February 2009 Candidates
<b>January 15</b>	<b>First Day of Classes, Term C</b>
January 19	Martin Luther King Day (No Classes)
January 20	First Day of Classes for Graduate Courses
January 28	President's IQP Award Competition
February 19	Advising Appointment Day (No Undergraduate Classes)
March 6	Last Day of Classes, Term C
March 7-15	Spring Recess
<b>March 16</b>	<b>First Day of Classes, Term D</b>
April 20	Patriots Day (No Classes)
April 23	Project Presentation Day (No Undergraduate Classes)
April 30	Deadline for Completion of Degree Requirement Forms for May 2009 Candidates
May 1	Last Day of Classes for Semester Courses
May 5	Last Day of Classes, Term D
May 7	12 noon - Residence Halls Close
May 15	Baccalaureate Ceremony
May 16	Spring Commencement
May 25	Memorial Day Holiday
June 4-7	Alumni Reunion
July 4	Independence Day
August 26	Deadline for Completion of Degree Requirement Forms for Fall 2009 Candidates

# UNDERGRADUATE CALENDAR 2008-2009

		S	M	T	W	R	F	S			S	M	T	W	R	F	S		
<b>A</b>	<b>AUG</b>	27	28	29	30	31	1	2	<b>FEB</b>	8	9	10	11	12	13	14	<b>D</b>	<b>FEBRUARY 19</b> ACAD. ADVISING DAY (PROJ. OPPORTUNITIES)	March 6 = MONDAY schedule
		3	4	5	6	7	8	9		15	16	17	18	19	20	21			
		10	11	12	13	14	15	16		22	23	24	25	26	27	28			
		17	18	19	20	21	22	23		1	2	3	4	5	6	7			
		24	25	26	27	28	29	30		8	9	10	11	12	13	14			
	<b>SEPT</b>	31	1	2	3	4	5	6	<b>MAR</b>	15	16	17	18	19	20	21		<b>APRIL 20</b> PATRIOTS DAY	April 21 = THURSDAY schedule
		7	8	9	10	11	12	13		22	23	24	25	26	27	28			
		14	15	16	17	18	19	20		29	30	31	1	2	3	4			
		21	22	23	24	25	26	27		5	6	7	8	9	10	11			
		28	29	30	1	2	3	4		<b>APR</b>	12	13	14	15	16	17			
5	6	7	8	9	10	11	19	20	21		22	23	24	25					
12	13	14	15	16	17	18	26	27	28		29	30	1	2					
19	20	21	22	23	24	25	3	4	5		6	7	8	9					
26	27	28	29	30	31	1	<b>MAY</b>	10	11		12	13	14	15	16	<b>Graduation</b>			
2	3	4	5	6	7	8		17	18	19	20	21	22	23					
9	10	11	12	13	14	15		24	25	26	27	28	29	30					
16	17	18	19	20	21	22		31	1	2	3	4	5	6					
23	24	25	26	27	28	29		<b>JUNE</b>	7	8	9	10	11	12	13		<b>E</b>		
30	1	2	3	4	5	6	14		15	16	17	18	19	20					
7	8	9	10	11	12	13	21		22	23	24	25	26	27					
14	15	16	17	18	19	20	28		29	30	1	2	3	4					
21	22	23	24	25	26	27	<b>JULY</b>		5	6	7	8	9	10	11	<b>JULY 3</b> INDEPENDENCE DAY (observed)			
28	29	30	31	1	2	3		12	13	14	15	16	17	18					
4	5	6	7	8	9	10		19	20	21	22	23	24	25					
11	12	13	14	15	16	17		26	27	28	29	30	31	1					
18	19	20	21	22	23	24		<b>AUG</b>	2	3	4	5	6	7	8				
25	26	27	28	29	30	31	9		10	11	12	13	14	15					
1	2	3	4	5	6	7	16		17	18	19	20	21	22					

SEPTEMBER 1  
LABOR DAY

August 28 =  
MONDAY schedule

October 28 =  
FRIDAY schedule

NOVEMBER 27  
THANKSGIVING

JANUARY 19  
MARTIN LUTHER  
KING DAY

# GRADUATE CALENDAR 2008-2009

		S	M	T	W	R	F	S			S	M	T	W	R	F	S		
<b>FALL</b>	<b>AUG</b>	27	28	29	30	31	1	2	<b>FEB</b>	8	9	10	11	12	13	14	<b>SPRING</b>		
		3	4	5	6	7	8	9		15	16	17	18	19	20	21			
		10	11	12	13	14	15	16		22	23	24	25	26	27	28			
	17	18	19	20	21	22	23	1		2	3	4	5	6	7				
	24	25	26	27	28	29	30	8		9	10	11	12	13	14				
	31	1	2	3	4	5	6	15		16	17	18	19	20	21				
	<b>SEPT</b>	7	8	9	10	11	12	13	<b>MAR</b>	22	23	24	25	26	27	28			
		14	15	16	17	18	19	20		29	30	31	1	2	3	4			
		21	22	23	24	25	26	27		5	6	7	8	9	10	11			
	28	29	30	1	2	3	4	<b>APR</b>		12	13	14	15	16	17	18			
	5	6	7	8	9	10	11			19	20	21	22	23	24	25			
	12	13	14	15	16	17	18			26	27	28	29	30	1	2			
19	20	21	22	23	24	25	3		4	5	6	7	8	9					
26	27	28	29	30	31	1	<b>MAY</b>		10	11	12	13	14	15	16				
2	3	4	5	6	7	8			17	18	19	20	21	22	23				
9	10	11	12	13	14	15		24	25	26	27	28	29	30					
16	17	18	19	20	21	22		31	1	2	3	4	5	6					
23	24	25	26	27	28	29		7	8	9	10	11	12	13					
30	1	2	3	4	5	6		<b>JUNE</b>	14	15	16	17	18	19	20				
7	8	9	10	11	12	13	21		22	23	24	25	26	27					
14	15	16	17	18	19	20	28		29	30	1	2	3	4					
21	22	23	24	25	26	27	5		6	7	8	9	10	11					
28	29	30	31	1	2	3	<b>JULY</b>		12	13	14	15	16	17	18				
4	5	6	7	8	9	10			19	20	21	22	23	24	25				
11	12	13	14	15	16	17		26	27	28	29	30	31	1					
18	19	20	21	22	23	24		2	3	4	5	6	7	8					
25	26	27	28	29	30	31		<b>AUG</b>	9	10	11	12	13	14	15				
1	2	3	4	5	6	7			16	17	18	19	20	21	22				

SEPTEMBER 1  
LABOR DAY

FALL

NOVEMBER 27  
THANKSGIVING

JANUARY 19  
MARTIN LUTHER  
KING DAY

APRIL 20  
PATRIOTS DAY

Graduation

MAY 25  
MEMORIAL DAY

SUMMER

JULY 3  
INDEPENDENCE  
DAY (observed)

Chronology of Academic Schedule and Events . . . . .	IFC
Undergraduate Calendar 2008-2009 . . . . .	i
Graduate Calendar 2008-2009 . . . . .	ii
The Mission of WPI . . . . .	3
The Goal of WPI . . . . .	3
A Statement of Values for Undergraduate Education at WPI . . . . .	3
WPI Undergraduate Learning Outcomes . . . . .	4
WPI's Commitment to Pluralism . . . . .	4
The Two Towers Tradition: The Second Century . . . . .	5
The WPI Plan . . . . .	5
WPI: A Global Technological University . . . . .	6
Global Program Sites . . . . .	6

---

**SECTION 1:  
THE WPI PLAN . . . . . 8**

WPI Degree Requirements . . . . .	9
Major Areas of Study . . . . .	10
Professionally Accredited Programs . . . . .	11
Academic Advising . . . . .	11
Degree Options . . . . .	12
Concentrations . . . . .	12
Minors . . . . .	12
Double Majors . . . . .	13
Projects . . . . .	14
The Major Qualifying Project . . . . .	16
MQP Project Centers . . . . .	16
The Interactive Qualifying Project . . . . .	17
Global Perspective Program . . . . .	19
Residential Programs . . . . .	19
Programs in the United States . . . . .	19
Programs in Europe . . . . .	21
Programs in Africa . . . . .	22
Programs in Asia . . . . .	23
Programs in Latin America . . . . .	24
Program in the South Pacific . . . . .	24
Individually Sponsored Residential Projects (ISRPS) . . . . .	24
On-campus IQP Programs . . . . .	25
Humanities and Arts Requirement . . . . .	26
The Social Science Requirement . . . . .	30

---

**SECTION 2:  
DEPARTMENT AND PROGRAM DESCRIPTIONS . . . . . 32**

Aerospace Engineering . . . . .	32
Air Force Aerospace Studies . . . . .	34
Biology and Biotechnology . . . . .	35
Biomedical Engineering . . . . .	36
Chemical Engineering . . . . .	42
Chemistry and Biochemistry . . . . .	45
Civil and Environmental Engineering . . . . .	47
Computer Science . . . . .	52
Computer Science Minor . . . . .	55
Electrical and Computer Engineering . . . . .	56
Minor in Computer Engineering . . . . .	59
Engineering Science Courses . . . . .	60
Engineering Physics . . . . .	60
Environmental Programs . . . . .	60
Environmental Engineering . . . . .	61
Fire Protection Engineering . . . . .	64
Humanities and Arts . . . . .	64
Drama/Theatre Minor . . . . .	67
Minor in Foreign Language (German or Spanish) . . . . .	67
Music Minor . . . . .	67
Writing and Rhetoric Minor . . . . .	68
Industrial Engineering . . . . .	68
Interactive Media and Game Development . . . . .	69
Interdisciplinary Programs . . . . .	70
Professional Writing . . . . .	71
Teacher Licensing . . . . .	71
International Studies . . . . .	72
Law and Technology Minor . . . . .	73
Liberal Arts and Engineering (Bachelor of Arts Degree) . . . . .	74
Management . . . . .	76
Entrepreneurship Minor . . . . .	78
Management Minor . . . . .	78
MIS Minor . . . . .	78
Organizational Leadership Minor . . . . .	79
Manufacturing Engineering . . . . .	79
Manufacturing Engineering Minor . . . . .	81
Materials Engineering . . . . .	81
Minor in Materials . . . . .	81
Mathematical Sciences . . . . .	82
Statistics Minor . . . . .	87
Mathematics Minor . . . . .	87
Mechanical Engineering . . . . .	88
Military Science . . . . .	92
Physical Education, Recreation, and Athletics . . . . .	93
Physics . . . . .	94
Physics Minor . . . . .	96
Pre-Law Programs . . . . .	97



Pre-MBA Program (Dual Degree) . . . . .	97
Pre-Medical, Pre-Dental and Pre-Veterinary Programs . . . . .	98
Project-Based Learning Community Option (PLC) . . . . .	98
Robotics Engineering . . . . .	98
Social Science and Policy Studies . . . . .	99
Social Science Minors . . . . .	102

---

### **SECTION 3: COURSE DESCRIPTIONS . . . . . 103**

Courses Qualifying for Engineering Distribution Areas . . . . .	104
Course Descriptions . . . . .	104
Air Force Aerospace Studies . . . . .	105
Basic Sciences (Geology) . . . . .	106
Biology and Biotechnology . . . . .	106
Biomedical Engineering . . . . .	110
Chemical Engineering . . . . .	112
Chemistry and Biochemistry . . . . .	114
Civil and Environmental Engineering . . . . .	117
Computer Science . . . . .	119
Electrical and Computer Engineering . . . . .	122
Engineering Science Interdisciplinary . . . . .	126
Fire Protection Engineering . . . . .	127
Humanities and Arts . . . . .	128
Interactive Media and Game Development . . . . .	140
Interdisciplinary . . . . .	141
Management . . . . .	142
Mathematical Sciences . . . . .	146
Mechanical Engineering . . . . .	149
Military Science . . . . .	154
Physical Education . . . . .	155
Physics . . . . .	156
Robotics Engineering . . . . .	158
Social Science and Policy Studies . . . . .	159

---

### **SECTION 4: UNIVERSITY POLICIES AND PROCEDURES . . . . . 165**

University Policies and Procedures . . . . .	166
Grades . . . . .	166
Grade Appeal and Grade Change Policy . . . . .	167
Transfer Credit . . . . .	168
Graduation with Honors . . . . .	169
Commencement . . . . .	169
Designation of Major Area of Study . . . . .	169
Double Major . . . . .	170
Designation of Class Year . . . . .	170
Academic Honesty Policy . . . . .	170
Guidelines for the Determination of Satisfactory Academic Progress, Academic Warning, Academic Probation and Academic Suspension . . . . .	171
Administrative Obligations and Holds . . . . .	172
Directory Information and Release of Information . . . . .	172
Office of the Registrar . . . . .	174

---

### **SECTION 5: RESOURCES AND SPECIAL PROGRAMS . . . . . 177**

The Gateway Park . . . . .	178
Special Programs for First Year Students . . . . .	178
Combined Bachelor/Master's Program . . . . .	178
Computer Resources . . . . .	179
Music and Theatre Facilities . . . . .	180
George C. Gordon Library . . . . .	180
Academic Technology Center . . . . .	181
Student Services . . . . .	181
Entrepreneurship . . . . .	183
Student Exchanges . . . . .	183
Worcester Consortium Course Cross-registration . . . . .	185
Cooperative Education Program . . . . .	185
Summer Session (Term E) . . . . .	186
Awards and Prizes . . . . .	186
Societies, Registration and Licensing . . . . .	189

---

### **SECTION 6: CAREER DEVELOPMENT AND GRADUATE SCHOOL . . . 190**

Career Development Center . . . . .	191
Graduate Studies . . . . .	191
WPI Graduate Program . . . . .	192

---

### **SECTION 7: ADMISSION, EXPENSES, FINANCIAL AID AND HOUSING . . . . . 194**

Admission to WPI . . . . .	195
Expenses . . . . .	198
Financial Aid . . . . .	200
Housing . . . . .	204

---

### **SECTION 8: TRUSTEES, ADMINISTRATION AND FACULTY . . . . . 206**

Trustees . . . . .	207
Administration . . . . .	209
Faculty . . . . .	218
Index . . . . .	234
Policies & Practices . . . . .	237
Currency of Information . . . . .	237
Accreditation . . . . .	238
Directions . . . . .	238
Campus Map . . . . .	IBC

WPI educates talented men and women in engineering, science, management, and humanities in preparation for careers of professional practice, civic contribution, and leadership, facilitated by active lifelong learning. This educational process is true to the founders' directive to create, to discover, and to convey knowledge at the frontiers of academic inquiry for the

betterment of society. Knowledge is created and discovered in the scholarly activities of faculty and students ranging across educational methodology, professional practice, and basic research. Knowledge is conveyed through scholarly publication and instruction.

*Adopted by the Board of Trustees, May 22, 1987*

## THE GOAL OF WPI

WPI was founded in 1865 to create and convey the latest science and engineering knowledge in ways that would be most useful to the society from which its students came. Since that time, the disciplines of human inquiry have expanded extraordinarily, as have WPI's constituencies. The WPI curriculum, accordingly, has been reshaped numerous times, but it has remained true to its original mission of fusing academic inquiry with social needs, of blending abstraction with immediacy, of linking new knowledge to applications.

The goals of the undergraduate program are to lead students to develop an excellent grasp of fundamental concepts in their principal areas of study; to lay a foundation for life-long renewal of knowledge; to gain a mature understanding of themselves; and, most importantly, to form a deep appreciation of the interrelationships among basic knowledge, technological advance, and human need. These principles are today manifest in the *WPI Plan*, a unique, project-oriented program which emphasizes intensive learning experiences and direct application

of knowledge. WPI remains committed to continued educational improvement and innovation.

The goals of WPI's programs of graduate instruction and research are to create and convey knowledge at the frontiers of academic inquiry. These endeavors are founded on the principle that vigorously pursued and rigorously assessed scholarship is the lifeblood of the institution. High quality graduate instruction conveys the arts of scholarship to new generations, and it assists working professionals in maintaining currency in a world where knowledge becomes obsolete with ever-increasing rapidity.

A WPI education encompasses continuous striving for excellence coupled with an examination of the contexts of learning so that knowledge is won not only for its own sake but also for the sake of the human community of which the people of WPI are part.

*Endorsed by the WPI Faculty on March 5, 1987, and by the Board of Trustees on October 16, 1987.*

## A STATEMENT OF VALUES FOR UNDERGRADUATE EDUCATION AT WPI

1. WPI's programs shall emphasize fundamental concepts, knowledge, and skill, and ensure that students are able to apply them within the context of their major disciplines.
2. WPI's programs shall emphasize the development of students as effective thinkers and communicators, able to use evidence to present their ideas with logic, clarity, and persuasion.
3. Programmatic breadth in general, and balance between technical and humanistic components in particular, are the hallmarks of a WPI undergraduate education. In addition to educating students in their major discipline, WPI's programs shall provide students with a broad preparation for fulfilling lives as responsible professionals and informed citizens.
4. Grounded in project and course experiences, a WPI education shall provide a firm foundation for life-long learning in a variety of fields. WPI programs shall emphasize inquiry-based learning and open-ended problem solving. Students shall bear a considerable responsibility for learning outside of the classroom.
5. WPI's programs shall be sufficiently flexible so as to allow students significant choice in and responsibility for planning their courses of study. Faculty, via the central teaching tasks of project and academic advising, shall ensure that student learning experiences encourage critical reflection, decision making, and personal growth.
6. WPI's programs shall emphasize the scientific, technical, societal, and humanistic contexts in which knowledge is applied and constructed. Education activities shall challenge students to make connections between disciplines, to consider multiple viewpoints, and to appreciate the consequences of their actions. The curriculum shall prominently feature integrative and interdisciplinary activities.
7. WPI's learning environment and educational activities shall balance personal responsibility and individual accountability with cooperation, collaboration and mutual respect. Members of the community shall be encouraged to value academic integrity, and to become conscious of the value that such integrity confers to themselves and to the community.
8. WPI shall be committed to assessment and improvement of student learning.

Graduates of WPI will:

1. have a base of knowledge in mathematics, science, and humanistic studies.
2. have mastered fundamental concepts and methods in their principal areas of study.
3. understand and employ current technological tools.
4. be effective in oral, written and visual communication.
5. function effectively both individually and on teams.
6. be able to identify, analyze, and solve problems creatively through sustained critical investigation.
7. be able to make connections between disciplines and to integrate information from multiple sources.
8. be aware of how their decisions affect and are affected by other individuals separated by time, space, and culture.
9. be aware of personal, societal, and professional ethical standards.
10. have the skills, diligence, and commitment to excellence needed to engage in lifelong learning.

---

## WPI'S COMMITMENT TO PLURALISM

---

Pluralism, as a social condition, means that several distinct ethnic, religious, and racial communities live side by side, have equitable access to resources, are willing to affirm each other's dignity, are ready to benefit from each other's experiences, and are quick to acknowledge each other's contributions to the common welfare. Recognizing the importance of pluralism to creativity, innovation, and excellence, WPI is dedicated to creating an atmosphere that encourages diversity in all aspects of campus life—from academics, to residence hall living, to social interactions among students, faculty, and staff. The Institute recognizes the special obligation of promoting a multicultural community based on mutual respect and tolerance. This commitment is part of WPI's institutional plan for encouraging pluralism and increasing diversity, a plan that proclaims the importance of having students understand and appreciate other cultures, and prepares them fully to pursue rewarding careers in an increasingly global economy.

*Concepts endorsed by the WPI Faculty on April 21, 1994.*





# THE TWO TOWERS TRADITION: THE SECOND CENTURY

WPI, the nation's third oldest private technological university, was established in 1865 by the New England industrialists John Boynton, Ichabod Washburn, and their associates. Boynton and Washburn endowed the first two buildings on campus, as academic classrooms and practical shops. Boynton Hall and the Washburn Shops — renovated today into state-of-the-art facilities — still preserve their distinctive original towers. These “Two Towers” represent WPI's continued commitment to academic excellence through real-life project experience that synthesizes classroom learning.

The “Two Towers” tradition of academic achievement and practical application is reflected in WPI's motto, “Lehr und Kunst” or “Theory and Practice.”

WPI has awarded graduate degrees since 1898, adding new programs regularly in response to the developing needs of the professional world. WPI is among the top 50 science colleges in the nation in terms of the percentage of undergraduates who receive doctorates. Presently, WPI offers the master's degree in 31 disciplines and the doctorate in 15.

The current student body of over 4,000 men and women includes about 1,100 full- and part-time graduate students. Currently, students attend WPI from almost every state and over 70 foreign nations.



## THE WPI PLAN

In 1970 WPI adopted a revolutionary new undergraduate program known as the *WPI Plan*. The Plan replaced the traditional rigidly-prescribed curriculum — typical of conventional engineering education — with a flexible, exciting, and academically challenging program aimed at helping students to learn *how to learn*.

The Plan continues the “Two Tower” tradition by synthesizing classroom experience in projects that solve real-world problems. The WPI project program prepares graduates for their future professional lives by helping them learn how to identify, investigate and report on open-ended problems. Alumni indicate that project experiences also prepare them uniquely well for managing team efforts, and for communicating both in oral and written forms according to professional standards.

All WPI students complete two major projects in addition to requirements in general education and in their major fields. The Major Qualifying Project (or MQP) challenges students to solve problems typical of those to be encountered in their professional discipline. The Interactive Qualifying Project (or IQP) presents an issue at the intersection of science, technology, and culture, and emphasizes the need to learn about how technology affects societal values and structures. Students also achieve intellectual breadth through degree requirements in the social sciences and humanities and arts. In addition, students achieve some depth within the Humanities and Arts by completing an Inquiry Seminar or Practicum on a theme emerging from a self-selected series of courses. Taken together, these activities emphasize that professionals must learn not only to create technology, but also to assess and manage the social and human consequences of that technology.

## Global Program Sites



WPI students must prepare to live and work in the interdependent world of the next century. Professionals no longer can study, and live in ignorance of other countries and cultures, as professional practice and commerce increasingly cross over national boundaries.

WPI thus emphasizes real-world project experience, and provides extensive opportunities for studying the kinds of global issues that will dominate professional and political life in the 2000's.



# THE WPI PLAN

## SECTION 1

WPI Degree Requirements . . . . .	9
Major Areas of Study . . . . .	10
Professionally Accredited Programs . . . . .	11
Academic Advising . . . . .	11
Degree Options . . . . .	12
Concentrations . . . . .	12
Minors . . . . .	12
Double Majors . . . . .	13
Projects . . . . .	14
The Major Qualifying Project . . . . .	16
MQP Project Centers . . . . .	16
The Interactive Qualifying Project . . . . .	17
Global Perspective Program . . . . .	19
Residential Programs . . . . .	19
Programs in the United States . . . . .	19
Programs in Europe . . . . .	21
Programs in Africa . . . . .	22
Programs in Asia . . . . .	23
Programs in Latin America . . . . .	24
Program in the South Pacific . . . . .	24
Individually Sponsored Residential Projects (ISRPS) . . . . .	24
On-campus IQP Programs . . . . .	25
Humanities and Arts Requirement . . . . .	26
The Social Science Requirement . . . . .	30

## WPI DEGREE REQUIREMENTS (effective for students matriculating after August 1, 2008)

WPI's academic requirements are specifically designed to develop an overall educational experience which meets the goals of the college. Each requirement plays a supporting role as follows:

- To provide intellectual breadth and a better understanding of themselves and the diversity and creativity of human experience, every WPI student must complete a **Humanities and Arts Requirement**;
- To provide an understanding of the priorities of other sectors of society, develop the ability to communicate effectively with disparate groups, organize and derive solutions to complex problems, and gain an awareness of the interrelationships between technology and people, every WPI student must complete an **Interactive Qualifying Project (IQP)**;
- To provide a capstone experience in the professional discipline, to develop creativity, instill self-confidence and enhance the ability to communicate ideas and synthesize fundamental concepts, every student must complete a **Major Qualifying Project (MQP)**;
- To provide for learning through an academic program with fabric and course balance while encouraging individual student choices within that framework, every student must fulfill **Distribution Requirements**.

### WPI TERMS AND CREDIT UNITS

The Bachelor degree from WPI normally is based upon a residency at WPI of 16 terms. WPI operates on a system with four seven-week *terms*, two in the autumn semester (Terms A and B) and two in the spring semester (Terms C and D). A summer session, Term E, is also available. The normal academic load for each term is defined as *one unit* of work, usually divided among three courses or projects. Thus, the usual credit unit for courses or independent study/projects is 1/3 unit. *Qualifying Projects*, defined on pages 38-39, require one full unit of activity which may be concentrated into a single term (especially if conducted off-campus) or spread throughout an academic year. The degree will be awarded upon completion of the following:

### DEGREE REQUIREMENTS

1. **The Humanities and Arts Requirement** (See page 26)  
Qualification by overall evaluation of two units of work in the humanities and arts.  
To provide intellectual breadth and a better understanding of themselves and the diversity and creativity of human experience, every WPI student must complete a **Humanities and Arts requirement**.
2. **The Interactive Qualifying Project** (See page 17)  
Successful completion of a qualifying project relating science and/or technology to society (the Interactive Qualifying Project, or IQP) representing at least one unit of credit in project or independent study work. The format of the documentation is to be in accordance with current WPI policy on such documentation.

An IQP shall address a topic relating science and/or technology to society. In this context, both "society" and "technology" should be construed as broadly as possible. Technology refers to the application of rational and efficient principles to a body of knowledge or to the control of space, matter and/or human beings. Thus, the IQP encompasses not only techniques of production embodied in tools and machines, but also advances in methods of social and economic organization, in managerial techniques, and in methods of analysis in science, mathematics, and engineering. Society refers not only to a grouping of individuals but also to the culture, values, laws, customs, and institutions shared by these individuals.

3. **The Major Qualifying Project** (See page 16)  
Successful completion of a qualifying project in the major area of study (the Major Qualifying Project, or MQP) representing at least one unit of credit in project or independent study work. The format of the documentation is to be in accordance with current WPI policy on such documentation.
4. **Distribution Requirements** (See program description for specified departments – page 31)  
Satisfaction of published academic activity distribution requirements in or relating to the major area of study. These requirements total no more than ten units (including the MQP) and are specified by general topical subject area, not by specific courses. Completion of distribution requirements will be certified by the appropriate departmental or Interdisciplinary and Global Studies Division (IGSD) Program Review Committee (PRC), upon recommendation by the student's academic advisor. For students desiring designation of a major area for which a determination regarding distribution requirements has not previously been made and published, a faculty committee will be appointed by the department head or IGSD dean to review and approve the student's program of study.
5. **Social Sciences** (See page 30)  
Completion of 2/3 unit of work in the social sciences, exclusive of qualifying project.
6. **Residency Requirement**  
A minimum of eight units *must* be completed satisfactorily in residence at WPI. (It is anticipated the normal residence at WPI will be 16 terms.)
7. **Minimum Academic Credit**  
The minimum academic credit required for the Bachelor degree is 15 units. Credit accumulated beyond the published distribution requirements shall be accomplished by the addition of "free elective" work.
8. **Physical Education** (See page 93)  
Qualification in physical education shall be established by completing 1/3 unit of course work (four PE classes) or its equivalent. Such an equivalent, for example, may be participation in club or varsity sports.

Guidelines for the construction of the most common major programs are given alphabetically by area in the “Department and Program Descriptions” section beginning on page 31. The exact program of study for any student, however, is developed by the student with the aid of an advisor.

All of the majors below, with the exception of Liberal Arts and Engineering, are awarded with the B.S. degree. Some programs are listed that are developed through the departments indicated in parentheses. In the past, WPI has graduated students in the following fields, but this list should not be interpreted as necessarily putting any restriction on a student’s “major:”

Actuarial Mathematics (MA)

Aerospace Engineering (ME)

Biochemistry (CBC)(certified by the American Chemical Society)

Biology/Biotechnology (BB)

Concentrations in:

Bioprocess

Cell and Molecular Biology and Genetics

Computational Biology

Ecology and Environmental Biology

Organismal Biology

Biomedical Engineering (BME)(accredited by ABET)

Specializations in:

Biomaterials

Biomechanics

Biomedical Imaging

Biosensors and Bioinstrumentation

Tissue Engineering

Chemical Engineering (CHE)(accredited by ABET)

Concentrations in:

Biochemical

Biomedical

Environmental

Materials

Chemistry (CBC)(certified by the American Chemical Society)

Concentrations in:

Medicinal Chemistry

Specializations in:

Computational Chemistry and Molecular Modeling

Gene Regulation

Ion Transport

Materials

Medicinal Chemistry

Membrane Proteins

Molecular Spectroscopy

Nanoscale Design

Natural Products Synthesis

Plant-Virus Biochemistry

Photochemistry

Photophysics

Sensors

Supramolecular Chemistry

Civil Engineering (CEE)(accredited by ABET)

Subareas in:

Structural and Geotechnical Engineering

Environmental Engineering

Transportation Engineering

Urban and Environmental Planning

Construction Engineering and Project Management

Concentration in:

Environmental

Computer Science (CS)(accredited by ABET)

Computers with Applications (CS)

Economic Science (SSPS)

Concentrations in:

Sustainable Economic Development

Computational Economics

Electrical and Computer Engineering (ECE)(accredited by ABET)

Subdisciplines in:

Robotics

Power Systems Engineering

RF Circuits and Microwaves

Aerospace

Communications and Signal Analysis

Biomedical Engineering

Analog Microelectronics

Computer Engineering

Engineering Physics (PH)

Environmental Engineering (CEE; CH; CHE; ME)

Environmental Policy and Development (SSPS)

Humanities and Arts (HU)

Concentrations in:

American Studies

Environmental Studies

Humanities Studies of Science and Technology

Industrial Engineering (MG) (accredited by ABET)

Interactive Media and Game Development (HU; CS)

Interdisciplinary (by arrangement)(IGSD)

International Studies (IGSD)

Liberal Arts and Engineering (B.A. degree)(HU)

Management (MG)(accredited by AACSB)

Management Engineering (MG)(accredited by AACSB)

Concentrations in:

Operations Management

Biomedical Engineering

Civil Engineering

Electrical and Computer Engineering

Mechanical Engineering

Manufacturing Engineering

Management Information Systems (MG)(accredited by AACSB)

Manufacturing Engineering (ME)(accredited by ABET)

Mathematical Sciences (MA)

Subareas in:

Algebraic and Discrete Mathematics

Computational and Applied Analysis

Operations Research

Probability and Statistics



Mechanical Engineering (ME)(accredited by ABET)

Concentrations in:

Aerospace Engineering

Biomechanical

Engineering Mechanics

Mechanical Design

Manufacturing

Materials Science and Engineering

Thermal-Fluid Engineering

Physics (PH)

Professional Writing (IGSD)

Psychological Science (SSPS)

Robotics Engineering (CS; ECE; ME)

Society, Technology and Policy (SSPS)

System Dynamics (SSPS)

Programs for students interested in medicine, law or pre-college education can be readily developed from many of the above majors.

Interdisciplinary (individually-designed) majors (ID) may also be developed under the B.S. or B.A. degree; see Interdisciplinary Programs, page 70.

WPI undergraduate diplomas designate “Bachelor of Science” or “Bachelor of Arts” as appropriate. The transcript will list the student’s major. If a Minor or Concentration was completed, this will also be included on the transcript.

The number of majors associated with a single WPI Bachelor of Science degree is **limited to two**.

---

## PROFESSIONALLY ACCREDITED PROGRAMS

---

WPI is accredited as an institution by the New England Association of Schools and Colleges. In addition, a number of major areas are accredited within their specific disciplines. Seven majors at WPI are accredited by the Engineering Accreditation Commission of ABET. These majors are *biomedical engineering, civil engineering, chemical engineering, electrical and computer engineering, industrial engineering, mechanical engineering, and manufacturing engineering*. *Computer Science* is accredited by the Computing Accreditation Commission of ABET. Please note that some departments bearing those particular names may also grant designated majors through their programs that are not ABET accredited. The titles of majors are carried on the students’ transcripts and have a bearing on engineering licensing and other professional activities.

The Chemistry and Biochemistry Department and its program at WPI are approved by the American Chemical Society for a major in chemistry. Those chemistry majors who complete a program satisfying the guidelines established by the American Chemical Society are certified to that organization as having received an undergraduate professional education in chemistry.

The undergraduate and graduate business offerings in the Department of Management are accredited by AACSB International, the Association to Advance Collegiate Schools of Business. AACSB International is a not-for-profit organization consisting of more than 1,000 educational organizations and corporations. Its mission is excellence in management education in colleges and universities. AACSB International is the premier accrediting agency and service organization for business schools.

---

## ACADEMIC ADVISING

---

WPI’s advising program is based on a cooperative and understanding relationship between the students and advisors. Under the WPI Plan, ***students have the final responsibility*** for designing their own educational experience at WPI which includes ***understanding all their degree requirements and making sure all those requirements have been satisfied for graduation***. The role of the faculty advisor is to help his/her advisees design a program of study which reflects the students’ interests and professional goals. While advisors are willing to suggest specific programs of study, they will not insist that

students follow a particular path. Advisors also help students choose among academic alternatives, help them interpret catalogs requirements and review degree audits and grade reports with them. Students are expected to understand these documents and their implications for academic progress and act accordingly. Therefore it is critical that students take the initiative to consult regularly with their academic advisors.

For more information about advising, contact Dale Snyder, Director of Academic Advising, at 508-831-5381.

## CONCENTRATIONS

### DEFINITION

A Concentration is an option associated with a Major which provides recognition for focused and coordinated academic work either within the Major or within an area of study closely related to the Major.

### RULES

1. All Concentrations require completion of two units of integrated academic study plus an MQP with a topic and content appropriate to the given Concentration.
2. Concentrations deemed to belong exclusively or primarily within the stated Major must be accommodated within the distribution requirements of that Major.
3. Concentrations deemed to have a substantial interdisciplinary nature can exceed the normal 10-unit allotment of the Major by as much as 1 unit, provided that the additional requirements do not include or permit academic work designated by the Major prefix or coursework normally taken to satisfy the Major's portion of the distribution requirements. Furthermore, Concentrations of an interdisciplinary nature are permitted to use up to 1 unit of the academic program beyond the distribution requirements of the Major, including the IQP, Sufficiency, Social Science requirement, and Free Electives, as deemed appropriate.
4. The requirements of the Concentration must be designed to offer choices for the student within the Major area and, if relevant, outside the distribution requirements of the Major; however, the Concentration requirements must not preclude meeting the normal distribution requirements for the Major.
5. Rules and guidelines for each Concentration will be formulated by the faculty associated with the governing Major, and must be reviewed by the Committee on Academic Operations (CAO) and subsequently approved by the Faculty. CAO is empowered to rule on whether a proposed Concentration is disciplinary or interdisciplinary.
6. An individual program of study leading to a Major with a Concentration will be planned by a student in consultation with his/her academic advisor. The student's intention to pursue a Concentration will be declared by application to the appropriate Program Review Committee in accordance with that Committee's schedule of deadlines. Application deadlines should be designed to enable Committee review and communication of decisions to students at a sufficiently early point that flexibility of schedule still exists. Extenuating circumstances may be considered at the discretion of the Program Review Committee.
7. Concentrations and minors are additional degree designations. Any credit earned for an additional degree designation must not overlap with credit earned for another additional degree designation by more than one unit. Also, no credit-bearing activity may be triple-counted towards degree designations or degree requirements.

Listings of Concentrations may be found in the "Department and Program Descriptions" section beginning on page 31.

## MINORS

### DEFINITION

A Minor is a thematically-related set of academic activities leading to a degree designation in addition to but separate from that granted by the Major. A Minor should be available to students of any Major, with the exception of a Minor which overlaps with a Major area to such an extent that it is not sufficiently distinct from that Major. The Committee on Academic Operations (CAO) is responsible for the review of proposed Minor Programs and decisions regarding allowed Major/Minor combinations.

### RULES

1. A Minor requires completion of two or more units of thematically related activity. The concluding 1/3 unit of the Minor must be a capstone experience that marks completion of the Minor.
2. It is expected that Minor requirements will be structured so that all acceptable Major/Minor combinations can be accommodated within a normal 16 term framework.
3. A Minor may include any portion of the academic program, excluding the MQP and the final Type 5 IS/P of the Sufficiency. Academic activities used in satisfying the regular degree requirements may be double-counted toward meeting all but one unit of the Minor requirements, subject to the following restrictions:
  - a. The first unit of double-counted work may include at most 1/3 unit of the IQP, 3/3 units of the Sufficiency (excluding the final Type 5 IS/P), or a combination thereof.
  - b. At least one unit of the Minor, including the capstone activity, must be free elective choices.
4. The Program Review Committee for a Minor area will consist of faculty members designated by the sponsoring faculty members.
5. A Minor area must be proposed by a sponsoring group of faculty and must be defined by the purpose of achieving an educational goal beyond those apparent or implicit in the regular degree requirements. Student-initiated Minor Programs must be developed with the approval of a sponsoring group of faculty advisors. Each Minor Program must be reviewed by CAO for its individual merit.
6. Concentrations and minors are additional degree designations. Any credit earned for an additional degree designation must not overlap with credit earned for another additional degree designation by more than one unit. Also, no credit-bearing activity may be triple-counted towards degree designations or degree requirements.

Minors are described in the "Program Description" section of this catalog. Minors sponsored by a department are described following the department. Others are listed alphabetically by title. As of the printing of this catalog, the following Minors have been approved:

Computer Science; Drama/Theatre; Computer Engineering; Entrepreneurship; Foreign Language; International Studies; Law and Technology; Management; Management Information Systems; Manufacturing Engineering; Materials; Music; Organizational Leadership; Physics; Social Science; Economics; Political Science and Law; Psychology; Sociology; System Dynamics; Statistics; Writing & Rhetoric.

Interdisciplinary or Individually Designed (ID) minors are approved by the Committee on Academic Operations (CAO).

The form needed to add a minor or to propose an interdisciplinary or individually designed minor can be found at the Registrar's website, under the form section: <http://www.wpi.edu/Admin/Registrar/Forms/index.html>. Please contact the Registrar's Office at 508-831-5211 if you have any questions.

## DOUBLE MAJORS

An option for some students who wish to broaden their WPI experience is the completion of two distinct majors through the double major option. The choice to pursue a double major should be made early in a student's career. The limit on the number of majors that a student may complete per degree is two.

For double majors, the diploma may list both majors (in order of preference by the student), either major, or no major as indicated by the student.

The following modifications are made to the degree requirements for students who elect to pursue a double major:

### 1. The Humanities and Arts Requirement.

Satisfactory completion of an MQP in Humanities and Arts or International Studies will satisfy the Humanities and Arts requirement.

### 2. The Interactive Qualifying Project.

If one of the majors of a double major is in Social Science and Policy Studies, a single project bearing at least one unit credit may be used to satisfy both the MQP requirement for the SSPS major and the IQP requirement. In order to be used to satisfy both requirements, the combined social science MQP and IQP must meet the goals of both projects. It must be interactive in nature involving an aspect of technology, and must also be an application of social science knowledge and analytical techniques. In order to select a single project that satisfies both the goals of the MQP and the goals of the IQP, the decision to pursue a social science double major needs to be made fairly early in the student's career.

### 3. The Major Qualifying Project.

At least one separate and distinct major qualifying project of at least one unit of work must be completed for each major, unless a student receives permission from MQP advisors to pursue a single interdisciplinary MQP of at least 4/3 units of credit (see page 16).

### 4. Distribution Requirements.

The distribution requirements of each major must be met, but requirements common to both majors have to be met only once. The MQP requirements for Double Majors may be fulfilled in either one of two ways:

- Two distinct projects, one in each major, each of at least one unit of credit.
- One interdisciplinary project of at least 4/3 units of credit, and having significant work associated with each major. An interdisciplinary project must be jointly advised by at least two faculty members, one associated with each of the relevant departments or programs. An interdisciplinary MQP involving social science may not be used as an IQP.

This second option takes advantage of the value of interdisciplinary work at the intersection of the two majors. Students choosing this second option must complete an interdisciplinary MQP approval form in advance of project registration, and this form must be signed by all advisors. This form must contain a summary of the proposed project work indicating the content relating to each major. All faculty advisors have equal status in approving the final project, and a single grade is submitted for each term's work and a single project grade is submitted on the CDR form. Should an interdisciplinary MQP, once completed, be deemed acceptable as an MQP for one of the two majors, but not for the other, and/or if the faculty advisors can not agree on a single grade after much effort to do so, the project may be considered as the MQP for a single major. This conversion can only occur with the consent of the student and the advisor(s) from the single major being selected.

The interdisciplinary MQP option is available only at the discretion of the faculty and only when both faculty members involved agree on the project content. Students planning to use this option should identify and consult with their faculty advisors well before the end of their junior year.

Note: It is anticipated that in some cases a student pursuing a double major will join a project team whose other members are pursuing a single major. The double-majoring student will bring the interdisciplinary content to the project, and this additional work will be represented by the additional credit that that student (perhaps only that student) earns, and with an enlarged report prepared by that student.

For students wishing to pursue double majors, the program audit for each intended major must be completed and certified by the review committee of each department involved. Academic activities appropriate to both majors may be counted in both majors. For the policy in the special situation of double majors involving the social sciences, see page 101. For specific policies, see pages 101 and 170.

No student shall complete more than two undergraduate majors.

Project activity is an integral part of the educational experience for all students under the WPI Plan. The two types of qualifying projects are:

1. A project in the major field of study (the Major Qualifying Project, or MQP).
2. A project which relates technology and science to society or human needs (the Interactive Qualifying Project, or IQP).

Projects should be chosen in consultation with the student's academic advisor and must be accepted by a project advisor before project registration can be completed. Many project opportunities come from off-campus organizations, and provide challenges to solve real-world problems and thus gain experience invaluable for seeking jobs and for professional practice.

Students are encouraged to develop their own projects, to solicit support for their ideas from potentially interested faculty, and to form teams to pool resources and share points of view.

The Major Qualifying Project should focus on the synthesis of all previous study to solve problems or perform tasks in the major field with confidence, and communicate the results effectively.

The Interactive Qualifying Project should challenge students to relate social needs or concerns to specific issues raised by technological developments.

#### **PAY AND CREDIT**

The WPI Faculty approved the following project policies in 1973:

1. A student may receive pay for related work that is above and beyond the work clearly defined for academic credit for a project.
2. Wherever possible remuneration for this extra work will be paid by WPI to the student from funds directly obtained through grants from the company to the college.
3. Results obtained from paid or unpaid work performed while students are not registered for project credit at WPI may be used in projects only after consultation with the project advisor. When possible such consultation should take place before the work begins.
4. Students who wish to pursue project work off-campus for WPI credit can do so only if 1) they are registered for that term at WPI, 2) their project advisors have established appropriate methods of supervising the off-campus work. Such supervision must make adequate provision for periodic review and advising.

#### **RESOURCES - GETTING STARTED**

Students are encouraged to avail themselves of the many resources and advice areas found in the Projects Program web page ([www.wpi.edu/Academics/Projects](http://www.wpi.edu/Academics/Projects)).

In addition, personal advice can be provided by meeting with the Projects Administrator (Daniels Hall) or the project coordinators listed on page 176.

#### **AVAILABLE PROJECTS**

Students may obtain information about new or ongoing projects from a variety of sources. Principal sources include discussions with other students, especially those currently involved in a project, the Projects Program web site, department offices, or their web pages. Off-campus projects are discussed annually in the fall. In the spring, "Available Projects" on the Projects Program web site ([www.wpi.edu/Academics/Projects/](http://www.wpi.edu/Academics/Projects/)) can be used as a directory of specific projects or as a source of ideas for developing your own projects. Some students will find a project listed which fits their needs and interests exactly. In other cases, the listing will serve to lead students to a faculty member with whom project involvement can be negotiated. The proposals in the Projects Program web page are updated periodically to provide an accurate listing of available projects.

#### **PROJECT ADVISOR**

Academic advisors can assist students in identifying a project. They are aware of the project interests of many other faculty members, and have a list of faculty interests which will enable a student to find a faculty member who can help to develop a project idea. Faculty associated with the Interdisciplinary and Global Studies Division (IGSD) are available to assist students in interdisciplinary and interactive projects. The Projects Office can also assist in finding an appropriate project advisor. See pages 261-262.

#### **PROJECT PERFORMANCE AND TIME-ON-TASK**

A student is normally expected to expend 15-17 hours per week on the average for each 1/3 unit of credit for project work, and expected achievement is based upon that commitment.

A project group, whether it involves one student or more, should have a minimum of one scheduled conference per week with the advisor(s). Additional time should be scheduled when the effort exceeds 1/3 unit per student or when more students are involved.

Students should be prepared to submit interim project reports to the advisor each week. Students are also encouraged to complete a proposal at the beginning of the project activity to define the scope and timeline for completion of the effort. In addition, oral reports may be required as determined by the advisor. At the end of the project, a report must be prepared to the satisfaction of the project advisor. For projects sponsored by off-campus organizations, both a written and oral report for the sponsors is normally expected.

#### **ELECTRONIC PROJECT SUBMISSION**

WPI requires that all undergraduate students submit their Interactive Qualifying Project (IQP) and Major Qualifying Project (MQP) electronically ("eProjects").

Students must be registered for a minimum of 1/6 unit of qualifying project credit in the term in which the final project report is submitted. An eProject must be submitted via the web site, [wpi.edu/+eprojects](http://wpi.edu/+eprojects), following the steps outlined there.

No matter which format is used to create the original report document (Microsoft Word, La Tex, or other), the final report must be converted to a PDF format in order to be submitted as

an eProject. For information on converting to a PDF, go to [wpi.edu/+ATC/Collaboratory/HowTo/](http://wpi.edu/+ATC/Collaboratory/HowTo/). Every eProject must include a title page and must follow the formatting guidelines described at [wpi.edu/+Projects/finishing.html](http://wpi.edu/+Projects/finishing.html).

The deadline for the submission of the initial report draft and the final document may be established at the discretion of the project advisor. Drafts and reports need *not* be accepted by the advisor after the established deadline.

The final PDF is required, but additional related files such as simulations, computer programs, multimedia, and data sets may be submitted as a component of the project.

A project that is completed by a team of students, except in extenuating circumstances, will submit ONE project report from the group. After the MQP or IQP team submits the final version of the project report, the advisor must review the work and approve or reject it online at [wpi.edu/+eproject](http://wpi.edu/+eproject).

The final project report should be carefully proofread. Once the submitted project has been approved by the advisor and released for archiving by the Registrar's Office, it is considered an academic record and cannot be edited.

A completed electronic Completion-of-Degree-Requirement (eCDR) form, must be printed for signature by each student and signed individually by the advisor as the final step in the submission process. The eCDR form must be submitted in person by the project advisor or a member of the academic department of the advisor to the Office of the Registrar by no later than the second day of the next academic term.

### **GROUP QUALIFYING PROJECT EFFORTS**

Students meeting a qualifying project degree requirement by participation in a group, or team effort, will submit, at the discretion of the project advisor, either a single, comprehensive written report from the group, or individual written reports from each member of the group. A single, comprehensive written report must, however, include some means by which each individual's contribution to the group effort may be clearly identified. This identification may take the form of an "authorship page," simply a list of individual chapters and their respective authors, or of a prefacing statement in which each contributing group member is named as having carried out one or more specific tasks within the overall project effort.

In the case where one or more students leave an ongoing group project after having contributed at least one unit each of project effort, those students, again at the discretion of the project advisor, will submit either a single written report or individual written reports in satisfying the qualifying project documentation requirement. The same means of identifying individual contributions will be employed as described above.

### **CENTER FOR COMMUNICATION ACROSS THE CURRICULUM**

*(Upper Level; Project Center)*

Accompanying strong emphasis on project work at WPI is strong emphasis on high quality presentation of materials such as proposals, written reports, term papers, and abstracts. To assist you in developing your writing and oral presentation skills, WPI has established a Center for Communication Across the Curriculum that offers writing and presentation consultations, style guidelines, writing manuals and presentation videotapes. Style guidelines, writing manuals and specially prepared handouts concerned with report writing are available. Small group or individual conferences scheduled by appointment with the writing tutors constitute an additional service provided by the Center to help students with their writing skills. For further information, contact Dr. Higgins at x5503.

### **DISSEMINATION OF PROJECT REPORTS**

MQPs and IQPs completed for off-campus agencies are usually distributed within the sponsoring agency by the agency project liaison. A project report may be restricted from public viewing if it contains confidential or proprietary information of a sponsoring agency.

Students are responsible for keeping personal copies of project reports for their own permanent professional records. In this way, reports can be reviewed for later use, and incorporated into a professional portfolio.

Thus, MQPs and IQPs are best viewed as research reports which establish good professional practices as well as being potential sources for further study and research.

### **OFF-CAMPUS INSURANCE AND LEGAL AGREEMENTS**

WPI's insurance program includes a broad range of coverage for students doing projects in cooperation with off-campus organizations. This insurance coverage requires proper documentation of individual student participation. All students doing project work with off-campus organizations must complete the pertinent portion of the project registration form. In certain cases, where the project is included as part of a regular course, the course instructor must submit to the Projects Office a list of the students going off campus and the name(s) and address(es) of the organization(s) involved.

WPI has entered into a variety of agreements with off-campus organizations, covering a wide range of issues common to the projects program. Students agree to abide by these agreements during the registration for the project.

The qualifying project in the major field of study should demonstrate application of the skills, methods, and knowledge of the discipline to the solution of a problem that would be representative of the type to be encountered in one's career. The project's content area should be carefully selected to complement the student's total educational program. In defining the project area within which a specific topic is to be selected, the student and academic advisor should pay particular attention to the interrelationships that will exist between the bodies of knowledge represented by courses, independent studies, and Preliminary Qualifying Projects; and by the Interactive Qualifying Projects.

MQP activities encompass research, development, and application, involve analysis or synthesis, are experimental or theoretical, emphasize a particular subarea of the major, or combine aspects of several subareas. In many cases, especially in engineering, MQP's involve capstone design activity. Long before final selection of a project topic, serious thought should be given as to which of these types of activities are to be included. Beyond these considerations, the MQP can also be viewed as an opportunity to publish, to gain experience in the business or public sectors.

Off-campus MQPs are also very valuable for access to state-of-the-art resources and contacts for future professional work.

### GETTING STARTED ON AN MQP

Project topics are originated by students, faculty, or practicing professionals participating in WPI's off-campus project programs. A faculty member in each academic department acts as Project Coordinator for all majors within the department. The Project Coordinator has assembled MQP topic descriptions being proposed and has identified the faculty who will serve as project advisors for each topic. All project opportunities—MQP, IQP, PQP, on-campus originated and off-campus originated—are made available to the student body through a planned information-sharing program of activities during C and D terms of the academic year prior to the start of the project.

### PROJECT PROPOSALS

Students are strongly encouraged to begin their MQPs with a project proposal. A detailed guide to preparing project proposals is available in department offices or on the Projects Program web page ([www.wpi.edu/Academics/Projects/](http://www.wpi.edu/Academics/Projects/)).

## MQP PROJECT CENTERS

Each Project Center has a WPI faculty member as the director, well-defined procedures for completing project work, and selective admissions processes. The Centers tend to be highly structured and require superior performance.

At the present time, the WPI project centers close to campus are:

- Gillette Company Project Center.
- Lincoln Laboratory Project Center.
- Sun Microsystems, Inc. Project Center.
- UMass Memorial Health Care, University of Massachusetts Medical Center, and Tufts School of Veterinary Medicine Project Centers.

See also page 19 for residential Project Centers at a distance from WPI.

---

## LINCOLN LABORATORY PROJECT CENTER

---

MIT Lincoln Laboratory located in Lexington, MA was founded in 1951 as a Federally Funded Research and -Development Center of MIT. The Laboratory's fundamental mission is to apply science and advanced technology to critical problems of national security. The scope of problems includes air defense, communications, space surveillance, missile defense, tactical surveillance systems and air traffic control.

The WPI-MIT Lincoln Laboratory MQP Program is a one-term, off-campus, multidisciplinary for students to complete their MQP requirements. Students participating in the program will be required to complete a Preliminary Qualifying Project (PQP) in D-Term 2007 or at the end of summer employment at Lincoln Laboratory. During this PQP, the students will learn about the project, perform background research, and interact with their project sponsor at Lincoln Laboratory. One of the outcomes of the PQP will be detailed proposal describing the general area of the project, the specific problem to be addressed, and the approach the students will take to solve the problem.

During A-Term 2007, the students will work full-time (five days a week) for 7 weeks at Lincoln Laboratory on their projects. They will work with a mentor from Lincoln Laboratory and with one or more WPI faculty advisors.

Admission to the WPI-MIT Lincoln Laboratory MQP Program is based on the following criteria: academic standing, and performance, essay response, evidence of maturity and independence, availability of projects in a specific area, qualifications relevant to the project offered, and results of an interview.

Project opportunities typically exist in the following disciplines:

- Computer Science
- Electrical and Computer Engineering
- Mathematics
- Mechanical Engineering
- Physics

---

## SUN MICROSYSTEMS, INC. PROJECT CENTER

---

MQPs for CS, IMGD, ECE, and RBE majors

Co-Directors: Professors G. Heineman & G. Pollice

These MQPs will take place at Sun Microsystems' Burlington campus, roughly 1 hour from campus. This is the "east coast campus" for this Fortune 500 company. The research labs at the Burlington Sun Microsystems campus have been active in developing cutting-edge research prototypes and truly innovative products.

We envision a set of projects that lie within the core disciplines of CS and ECE as well as opportunities to work on interdisciplinary projects for IMGD and RBE majors. The proposed projects range from the game industry's first open source, enterprise grade, highly scalable, online game server (Project DarkStar) to a programmable infrastructure for small wireless devices (Project SunSpot). There is also a project that investigates the Fortress language, seen as the successor to the Java programming language.



---

## GILLETTE COMPANY PROJECT CENTER

---

Gillette is the world leader in grooming products. Their South Boston Manufacturing Center (SBMC) is their primary location for the manufacture of shaving systems such as the Mach 3 and Venus razors, where over a billion units are produced each year. Many major qualifying project opportunities are available, principally in mechanical and manufacturing engineering. Projects can range from the design of equipment for automated production systems to the analysis and modeling of the kinematics, dynamics, and vibrations of existing systems. Students who do these projects will have the opportunity to solve real engineering problems, interact with professional engineers at one of the most automated assembly facilities in the world, and demonstrate their presentation skills. Those interested in exploring project opportunities at Gillette should contact Professor Robert L. Norton, Mechanical Engineering Department.

---

## UMASS MEMORIAL HEALTH CARE/UNIVERSITY OF MASSACHUSETTS MEDICAL SCHOOL/ TUFTS UNIVERSITY SCHOOL OF VETERINARY MEDICINE PROJECT CENTERS

---

Biomedical projects (MQP, IQP, PQP, and thesis) are available at UMass Memorial Health Care, University of Massachusetts Medical School (UMMS), and Tufts University School of Veterinary Medicine (TUSVM) for students from all disciplines on campus. Each of these centers is located close to WPI.

It is recommended that students spread their projects over the entire academic year. However, in some cases, full-time activity for a term can be accommodated. Students interested in project opportunities should contact the Biomedical Engineering Department Projects Faculty Coordinator well in advance of their planned project -activity.

---

# THE INTERACTIVE QUALIFYING PROJECT

---

At WPI, students are expected to develop an understanding of how science and technology are embedded in the fabric of society. The Interactive Qualifying Project (IQP) challenges students to address a problem that lies at the intersection of science or technology with society. During the IQP, students work in interdisciplinary teams, often with an external sponsoring organization, to develop solutions to real world problems. In doing so, students learn something about the role of science and technology, its impact on society, its place in meeting human needs and human efforts to regulate, control, promote and manage our changing technologies. The IQP is equivalent to three courses, typically undertaken in a student's junior year. It can be completed over three terms, or as a full course load for a student for one term, and it can be completed on-campus, or at one of our many residential project centers in the U.S. and abroad. For more on the IQP see the websites of the Interdisciplinary and Global Studies Division (IGSD) at <http://www.wpi.edu/Academics/Depts/IGSD/iqp.html>. For more on the IQP and study abroad, see the Global Perspectives Program website: <http://www.wpi.edu/Academics/GPP/index.html>. Completed IQPs are electronically archived at WPI's Gordon Library, are indexed and are available to the public (<http://www.wpi.edu/Academics/Library/Collections/Projects/>).

### **IQP LEARNING OUTCOMES**

The Faculty adopted the following statement defining learning outcomes for the IQP. Successful completion of an IQP is an important element in helping students achieve WPI's overall undergraduate learning outcomes.

Students who complete an Interactive Qualifying Project will:

1. Demonstrate an understanding of the project's technical, social and humanistic context.
2. Define clear, achievable goals and objectives for the project.
3. Critically identify, utilize, and properly cite information sources, and integrate information from multiple sources to identify appropriate approaches to addressing the project goals.

4. Select and implement a sound methodology for solving an interdisciplinary problem.
5. Analyze and synthesize results from social, ethical, humanistic, technical or other perspectives, as appropriate.
6. Maintain effective working relationships within the project team and with the project advisor(s), recognizing and resolving problems that may arise.
7. Demonstrate the ability to write clearly, critically and persuasively.
8. Demonstrate strong oral communication skills, using appropriate, effective visual aids.
9. Demonstrate an awareness of the ethical dimensions of their project work.

### **PREPARING FOR AND FINDING AN IQP**

Students are encouraged to view the IQP as a learning opportunity – a chance to gain knowledge outside their major field – while working with others to solve open-ended, complex problems. The best approach is to consult with one's academic advisor and select courses to be taken in the first and second year at WPI that can provide a foundation for an IQP in the junior year. Often project preparation involves developing an understanding of the social sciences and humanities, as the concepts and analytical techniques of these disciplines are important in understanding the social context of science and technology. In addition, students enrolled in the Global Perspective Program will be expected to complete a course devoted to project preparation in advance of their travel.

Project topics originate with external organizations, faculty and students. Students who complete IQPs at a residential project center through the Global Perspective Program work on project topics identified by external sponsoring organizations. Students can explore these opportunities at the Global Opportunities Fair organized each September by the Interdisciplinary and Global Studies Division (IGSD). Students completing projects on campus are encouraged to seek faculty members that share their interests to advise projects. Faculty interested in

advising specific IQPs will post their project topics on-line at the IQP Registry. See <http://www.wpi.edu/Academics/Projects/available.html>. The IGSD also hosts an On-Campus Project Opportunities Fair each March where students can meet faculty advisors to discuss projects being offered on campus during the following year.

The IGSD (<http://www.wpi.edu/Academics/Depts/IGSD/index.html>) offers administrative support for project activities. Students are welcome to seek further assistance from the staff on the second floor of the Project Center.

### WHAT ARE IQPS ABOUT? SCIENCE, TECHNOLOGY AND SOCIETY

Most, but not all, IQPs are indexed according to the following IQP Divisions. These Divisions assist students in locating projects by topical area in the Registry of IQP opportunities (<http://www.wpi.edu/Academics/Projects/available.html>). These Divisions are also used as subject categories for the Library's archive of completed projects.

**Division 41: *Technology and Environment.*** Subjects have included a wide range of environmental problems, for example, water quality and supply, climate change, open space and growth, hazardous waste and acid rain.

**Division 42: *Energy and Resources.*** These projects have focused on energy supply, alternative energy technologies, conservation, and the economic and policy choices made or proposed to govern this industry.

**Division 43: *Health Care and Technology.*** Projects in this division have focused on the technologies and cost of health care delivery in the US. Ethical questions in health care have also been addressed, including abortion, stem cell research, cloning, and "right to die" issues.

**Division 44: *Urban and Environmental Planning.*** Land use planning, historic preservation, urban renewal, transportation systems and the impacts of infrastructure design are among the subjects studied in this division

**Division 45: *Science and Technology – Policy and Management.*** IQPs in this area focus on public policy as it is used to promote or constrain technology. Examples include both public and private efforts to promote scientific research, manage innovation and understand how changes in technology result in a changing business and economic environment.

**Division 46: *Social Studies of Science and Technology.*** Students working on these projects use a sociological approach to understanding the impact of technology on society. Topics have included equity issues (gender, race, ethnicity), technological literacy, and technology assessment and forecasting.

**Division 47: *Safety Analysis and Liability.*** The study of safety analysis introduces students to the subjects of risk analysis, negligence, and standards of care in product design and use. Projects have also focused on fire risk and safety, risks associated with natural disasters and risk management.

**Division 48: *Humanistic Studies of Technology.*** Humanistic studies illuminate the social context of science and technology. History, literature, philosophy, religion and the fine arts all speak of the nature of human problems and the scientific and technological approaches used to address personal and social problems. Each discipline provides analytic methods for examining society/technology problems. Students working in this division should prepare by taking appropriate humanities courses before beginning their project.

**Division 49: *Economic Growth, Stability and Development.*** Division 49 focuses both on problems of stability and change in mature economies, and the economic problems of developing nations. Tools of economics are used to understand the relationship between technology and growth. Projects address policy issues of appropriate technology, technology transfer among countries and trade, among others.

**Division 50: *Social and Human Services.*** These projects address the problems and technologies involved in the provision of community services, broadly defined. Projects have addressed services for the mentally or physically disabled, for juveniles, seniors, consumers, and public school students.

**Division 51: *Education in a Technological Society.*** Many WPI students have helped design and test science and engineering curricula for students at all grade levels, from elementary to high school. Projects in this area have also addressed the design and testing of computer assisted learning environments and other applications of technology to learning.

**Division 53: *Law and Technology.*** Legal systems regulate technology in all aspects of life, from food safety to pollution control to intellectual property (patents, copyright). Projects in this division explore the role of courts, agency regulations and legislation in controlling the impacts and use of technology.

**Division 54: *Historic and Artistic Preservation Technology.*** The technologies of art conservation and restoration, combined with the policy and values issues involved in the preservation historic places and works of art, form the subject matter of IQPs completed in this division.

In addition to IQP and MQP opportunities on campus, through the Global Perspective Program, overseen by the Interdisciplinary and Global Studies Division, WPI students have many opportunities to complete a project for a term at one of WPI's residential project sites. Project work conducted at these sites provides teams of students with extraordinary opportunities to learn by solving problems provided by industrial, non-profit, non-governmental or government agencies.

Application for IQP work in these programs begins in the fall with the Global Opportunities Fair. At the Fair, IQP and exchange program directors will be available to talk with students about these opportunities. Students should apply in the fall of the year preceding the year in which they would like to participate. Further information is available at the Interdisciplinary and Global Studies Division in the Project Center.

All students accepted to an off-campus IQP Center will be registered for the preparation course ID 2050 in the term immediately preceding their time off campus. Students must also be making satisfactory progress in their academic program.

Prior to leaving campus for a project program site, each student is required to complete a project registration form as described on page 174.

## RESIDENTIAL PROGRAMS

All programs offer the students the opportunity to complete a project in one term of full-time work. Advance preparation is required. Faculty advisors are in residence at IQP and Humanities and Arts sites and some MQP sites.

	TERMS OFFERED				
	A	B	C	D	E
Limerick, Ireland*	<input type="checkbox"/>				
Ifrane, Morocco**	<input type="checkbox"/>				
Cape Town, South Africa		<input type="checkbox"/>			
Washington, D.C.		<input type="checkbox"/>			
Worcester, Massachusetts		<input type="checkbox"/>	<input type="checkbox"/>		
London, England**		<input type="checkbox"/>			<input type="checkbox"/>
Wall Street, NY*		<input type="checkbox"/>			
Nantucket Island, Massachusetts		<input type="checkbox"/>			
Venice, Italy		<input type="checkbox"/>			
San José, Costa Rica		<input type="checkbox"/>			
Bangkok, Thailand			<input type="checkbox"/>		
Budapest, Hungary			<input type="checkbox"/>		
Hong Kong, Peoples' Republic of China			<input type="checkbox"/>		
London, England				<input type="checkbox"/>	<input type="checkbox"/>
Nancy, France*			<input type="checkbox"/>		
Silicon Valley, California*			<input type="checkbox"/>		
Boston, Massachusetts				<input type="checkbox"/>	
Copenhagen, Denmark				<input type="checkbox"/>	
Melbourne, Australia				<input type="checkbox"/>	
San Juan, Puerto Rico				<input type="checkbox"/>	
Windhoek, Namibia				<input type="checkbox"/>	
Wuhan, Peoples Republic of China					<input type="checkbox"/>

\* MQP opportunities only.

\*\* Humanities and Arts opportunities only.

## PROGRAMS IN THE UNITED STATES

### WASHINGTON PROJECT CENTER - IQP

Director: Prof. D. DiBasio, Goddard Hall 127

Students work on projects with prestigious sponsoring agencies while living in the heart of Washington, D.C., just blocks from the White House. The Washington Project Center is located in an attractive neighborhood near The Mall, shopping, businesses, embassies and international agencies. Take advantage of this ideal location and easy access to the subway to enjoy an endless supply of free museums, national monuments, and impressive buildings that house the seat of national government.

Past projects have been completed with such agencies as the Smithsonian, the Environmental Protection Agency, the U.S. Patent and Trademark Office, the National Science Foundation and the Consumer Product Safety Commission. This is an opportunity to examine the inner workings of government and the importance of national action in areas of the environment, science education, urban issues, and consumer protection.

### BOSTON PROJECT CENTER - IQP

Director: Prof. F. Carrera, Project Center

The Boston project site is a residential program with resident faculty advisors. This world-class city, featuring a wealth of cultural, educational, recreational, and tourist opportunities, is an exciting, vital and stimulating environment in which to live and work.

Projects focus on the improvement of the quality of life of the city for its inhabitants and visitors. Most projects will focus on environmental issues, as well as on urban maintenance, management and planning issues, and will include field work in the city's neighborhoods and in the greater Boston area. The data collected will usually be archived in databases and displayed on Geographical Information Systems, as a prelude to a careful analysis to produce insightful conclusions and recommendations. Past projects include: a plan for the reduction of neighborhood disruption during the work on the Big Dig (for the North End Neighborhood Association); an analysis of the impacts of Historic Districts on surrounding neighborhoods and a method of streamlining construction permits in those districts (for the Boston Landmark Commission); the creation of a computerized information system for the management and maintenance of street trees (for the city of Cambridge Department of Public Works); the collection and analysis of environmental data about Chelsea Creek (for the Environmental Protection Agency); the improvement of public safety through the inventory and mapping of all underground fuel tanks (for the Boston Fire Department), as well as projects for various departments of the cities of Boston, Cambridge, Brookline, Quincy and Newton.

---

## NANTUCKET ISLAND PROJECT CENTER - IQP

---

Director: Professor M. Elmes, Washburn Shops

The Nantucket Island project site is a residential program with resident faculty advisors. This historic island is 14 miles long with an average width of about 3.5 miles and has about 10,000 year round residents. It was once a booming whaling center but is now primarily a tourist destination, particularly during the summer months. It is a National Historic District and has changed little since the 17th century (with cobblestone streets, old shops and lamps, seaside cottages, and historical museums). It has excellent public beaches that extend around the island, and 40% of the island is protected conservation land.

The Nantucket Island Project Center will start in B'08, and students who are accepted will be pioneers in this exciting new venture. Nantucket is unique for a number of reasons: it is a high-end, tourist destination in the summer when approximately 40,000 tourists visit the island and draw on the island's limited resources; it is a historic site deeply committed to historic preservation and museum studies; and it is also an environmentally-sensitive site where much of the land is protected and where problems such as beach erosion and invasive species (such as white-tail deer) have created new challenges (such as overgrazing and Lyme disease). As such, projects will tend to focus on environmental challenges (e.g., waste management, tourism impacts, sustainability) and on museum studies (e.g., providing information and maps to tourists; making museum information more accessible to the public). Titles of potential projects include the following: Exploring Nantucket's Flora, Fauna and Features (Maria Mitchell Association), Recommending Updates to The Natural Science Museum and the Museum at the Vestal Street Observatory (Maria Mitchell Association), Creating an Interpretively-effective Audio Tour of the Town of Nantucket (Nantucket Historical Association), and Exploring the Feasibility of a Bus/Trolley System for Tourists on the Island (Egan Maritime Foundation).

---

## WORCESTER COMMUNITY PROJECT CENTER - IQP

---

Director: Prof. R. Krueger, Project Center

Students will work in offices in the central Worcester -region and commute daily from their residences.

The Worcester Community Project Center (WCPC) - develops projects around five core competencies: 1) planning for community sustainability, 2) green building design, 3) economic development, 4) historic, cultural, and environmental preservation and outreach, and 5) environmental justice. The WCPC has been recognized around the City and the region as a valuable community resource. As a result, students have the opportunity to work on a number of "high profile" community projects. Typically, these projects make significant contributions to improving the city we live in. Project sponsors range from municipal government, the Mayor's Office, the Broad Meadow Brook Audubon Sanctuary, the Regional Environmental Council, the Greater Worcester Land Trust, the Worcester Art Museum, Centro Las Americas and various community development corporations.

Recent projects include a historical analysis of Institute Park (sponsored by Benoit Reardon Architects and the Worcester Art Museum); green building design for Friendly House (sponsored by WPI and Friendly House); brownfield redevelopment in Worcester (sponsored by the Honorable Timothy P. Murray, Mayor, City of Worcester); "Sustained Planning for a Sustainable Worcester" (sponsored by WPI and the City Office of Neighborhood Services); mapping of Worcester's open spaces (sponsored by Broad Meadow Brook Audubon Sanctuary); developing an on-line artist database (sponsored by Arts Worcester and the City Manager's Office).

---

## SILICON VALLEY PROJECT CENTER - MQP

---

Co-Directors: Prof. D. Finkel, Fuller Labs 231

Prof. J. Orr, Boynton Hall

Silicon Valley, California, is home to many of the most dynamic companies in the computer industry and in other related high-technology industries. Long-established companies such as Sun, Intel and Hewlett-Packard, and research centers such as SRI International and NASA Ames Research Center, mix with recent successes such as eBay and small start-ups to provide a dynamic and exciting atmosphere. The projects will expose students to both the cutting-edge technology and the dynamic entrepreneurship of Silicon Valley.

Students participating in the Silicon Valley Project Center will participate in a Preliminary Qualifying Project (PQP) during B-Term 2007. During this PQP, the students will perform background research in the area of their project, learn about the company and the industry where they will be performing their project, and hold discussions with their company mentor about their project work.

The projects will be conducted during C-Term 2008 in Silicon Valley. The students will work full-time at the sponsor's site for approximately nine weeks, from early January through early March. They will work with a mentor from the sponsoring company and with a WPI faculty advisor. The project work will include the completion of an MQP report and presentation on the project to the sponsoring organization. Admission to the Silicon Valley Project Center is based on academic standing and performance, essay response, evidence of maturity and independence, availability of projects in a specific area, qualifications relevant to the project offered, and results of an interview.

Projects may be available in Computer Science, in -Electrical and Computer Engineering, and in Interactive Media and Game Development.

---

## WALL ST. PROJECT CENTER - MQP

---

Directors: Prof. A. Gerstenfeld, Washburn Shops 212

Prof. R. Brown, Atwater Kent 307

New York is one of the world's most exciting cities. Some of the best theater and museums are found there. Wall Street is known as the world center of investments and banking and is seen as the capital of business and technology. It has proved to be a training ground for the leaders of the future. New York is a place where people both work and play hard. It is fast moving and allows the opportunity to apply many of the skills learned at WPI.

At the Wall Street Project Center, students complete MQP's while working with a wide variety of agencies, such as Morgan Stanley, Deutsche Bank, Lehman Brothers, and J.P. Morgan. Wall Street, now much more than investments, is the center of world commerce; there is a need for WPI projects involving computer science, management, industrial engineering, and mathematical sciences. Some of our projects include work-flow analysis, risk analysis (country risk limits), system usability, and data-base corruption issues. Other projects include user on-line functionality, and user help functions for global settlement systems. The projects are challenging and important to the clients as well as to the students.

---

## PROGRAMS IN EUROPE

---

### BUDAPEST PROJECT CENTER - MQP

---

Director: Prof. G. Sarkozy, Fuller Labs

Hungary has gone through a deep-rooted transformation during the past 15 years, and today it is a free and democratic country with a smoothly working market economy. The country has enjoyed a steady GDP growth, a bullish stock market and a decreasing inflation rate as well. As a result of these changes Hungary became a full member of the European Union on May 1, 2004. Hungary is a link between Eastern and Western Europe. New investment is revitalizing the country, and grand old Budapest is being restored. It's the country's cultural, political, intellectual, and commercial heart - and it teems with cafés, restaurants, markets, and bars. Budapest offers breathtaking Old World grandeur and thriving cultural life. Situated on both banks of the Danube River, the city unites the colorful hills of Buda and the wide, businesslike boulevards of Pest. The city is simultaneously peaceful and bustling, a big metropolis and yet friendly, it treasures the old and embraces the new. These days with all the changes happening, Budapest is one of the most exciting places in Europe.

These CS MQPs will be at the Computer and Automation Research Institute in Budapest. This Institute is the national research center in Hungary for information technology, computer science and their related fields. In addition to pursuing basic and applied research, system design and system integration, consulting and software development are also among the activities of the Institute. The Institute puts a special emphasis on education related activities; it is closely affiliated with several Hungarian and European universities, including the Budapest University of Technology and Economics (BME) and the Eotvos Lorand University of Sciences, Budapest (ELTE).

---

### DENMARK PROJECT CENTER - IQP

---

Directors: Prof. P. C. Pedersen, Atwater Kent 205  
T. H. Thomsen, International House

The IQP project sites are in or near Copenhagen, the capital of Denmark, located on the island of Zealand. The Danish population numbers 5.3 million and inhabits an area of 16,630 sq. miles. In addition to farming, Denmark has a diverse and highly technological industry, with emphasis on electronics, pharmaceuticals, shipbuilding, furniture craft and alternative energy sources. The Danish culture is very open to interdisci-

plinary academic questioning, the foundation of every IQP. Danes are brought up to question and debate the impact of technology on the quality of life and is a leader in utilizing the positive aspects of modern technology while trying to lessen its negative impacts.

IQP projects in Denmark span a wide range of topics, with an emphasis on environmental issues and technology for people with disabilities. Alternative transportation, food quality, technology to assist visually impaired people with disabilities are all topics of great interest to both the public and private sector. Not-for-profit agencies are also expected to sponsor several future projects.

---

### LIMERICK PROJECT CENTER - MQP

---

Directors: Prof. R. Vaz, Project Center  
Prof. R. Brown, Atwater Kent 307

Visitors to Ireland encounter spectacular scenery including 3,500 miles of coastline, a rich cultural and literary heritage, vibrant cities and villages, and a warm and friendly populace eager to help visitors feel at home. Ireland also enjoys one of the fastest-growing economies in the EU. Limerick is Ireland's third largest city, and a center for both tourism and business, yet it retains the charm and feel of a small community in many ways. Limerick's center is located on the River Shannon, and features both medieval and Georgian influences; the outskirts of the city are home to a number of high-technology business parks and a major university. The areas surrounding Limerick are famous for their natural beauty and historical significance; the Republic of Ireland is small enough so that it can be explored from end to end in a series of weekend excursions.

MQPs in the Limerick area involve working at local electronics firms and research facilities. Students spend 10 weeks in Limerick, working fulltime in collaboration with local engineers on the projects. MQPs in Limerick typically focus on analog and mixed-signal hardware design, digital design and embedded systems, signal processing and communications, and software engineering. Specific project descriptions are not available until the beginning of the projects, as project sponsors typically provide the opportunity for students to work on cutting-edge problems of immediate interest to the sponsors.

Admission to the ECE MQP Program in Limerick is based on the following criteria: academic standing and performance, evidence of maturity and independence, qualifications relevant to the anticipated projects, faculty references, and the results of an interview.

---

### LONDON PROJECT CENTER - IQP

---

Director: Prof. P. Davis, Stratton Hall

Students at the London Project Center spend seven weeks in one of the world's finest capital cities. Some of the best theater and museums are found here, as well as neighborhood pubs where relaxation, music and conversation are an age-old tradition. A vibrant city, which has undergone rapid change, today London is known for its diverse cultures and interests - truly a city for everyone. This juxtaposition of past and present, tradition and modernity makes London a city with much to offer.

At the London Project Center, students complete IQPs while working with a wide variety of agencies. Recent or current project sponsors include Her Majesty's Tower of London, the Victoria and Albert Museum, the Museum of Science and Industry, the Association of Chief Executives of National Voluntary Organizations, and the London Boroughs of Merton, Lewisham and Brent.

---

## **LONDON HUMANITIES PROGRAMS**

---

Coordinator: Prof. J. Delorey, Alden Hall 205

WPI offers Humanities and Arts Projects in London in Terms B and E. London Humanities and Arts Projects are interdisciplinary and intended for students with many backgrounds in the humanities and arts. London was once the center of a global empire and its influence continues to radiate throughout the British Isles and well beyond. Humanities and Arts students in London study topics that might include history, literature, music, theatre, or culture, and work on projects that build on at least three previous courses in humanities and arts. As an interdisciplinary program, the London Humanities and Arts experience is not limited to the history or literature of Britain, but all projects take advantage of the unique resources available in London. These include some of the world's most vibrant theatre and the arts, outstanding museums, ambitious architecture, the libraries of the University of London, collections of film or sound recordings, and much more. London Humanities and Arts Projects are appropriate for students with a background in art history/architecture, drama/theatre, history, literature, music, philosophy, religion, or writing/rhetoric. Students planning a minor or major in International Studies, Humanities and Arts, or Technical Scientific, and Professional Communication, also may study in London in conjunction with this program.

---

## **NANCY PROJECT CENTER - MQP**

---

Director: Prof. T. Camesano, Goddard Hall 218B

Nancy, France is a medieval city of about 350,000, located in the heart of the beautiful Lorraine region. The city is well connected by train to Paris, Frankfurt, and Brussels (each about 200 miles), and Luxemburg (75 miles). The "vielle ville" (old city) region of Nancy is known for its small streets, beautiful mansions, museums, and historic walks. There is a large student population, as well, and Nancy offers plenty of sports, concerts, movies, shopping, and eating places that are of interest to students.

The projects will be done in collaboration with the chemical engineering school of the Institut National Polytechnic de Lorraine (INPL), and l'Ecole Nationale Supérieure des Industries Chimiques (ENSIC). The projects will take place in one or more of the following: Laboratoire de Chimie Physique Macromoléculaire (LPCM, Physical Chemistry of Macromolecules), Département de Chimie Physique des Réactions (DPCR, Physical Chemistry of Reactions), Laboratoire de Thermo-dynamique des Séparations (LTS, Thermodynamics and Separation Processes), or Laboratoire des Sciences du Génie Chimique (LSCG, Chemical Engineering Sciences). Projects are anticipated in testing a polymeric drug -delivery system, image analysis of bacteria from a wastewater treatment process, bacterial biofilm formation in bioreactors, and possibly in fuel cells.

---

## **VENICE PROJECT CENTER - IQP**

---

Director: Prof. F. Carrera, Project Center

Called the most beautiful city in the world, Venice features a haunting atmosphere which exudes the splendor of its past. A city without cars, yet with an outstanding historical, artistic, and architectural heritage, much of its uniqueness comes from its symbiotic relationship with the sea and the lagoon. Yet, despite its millenary history, the historic city of Venice is so trying to adapt to our XXI century lifestyles, while preserving its environmental, artistic and cultural heritage. The rising cost of living in Venice has led to a dramatic exodus of its population which decreased since WWII from about 200,000 to around 60,000, while tourism has ballooned to 12 million visitors per year. Venice is a microcosm that reflects and magnifies many of the issues confronting the rest of the world, and at the same time it is a place that will allow you to experience a unique - more relaxed - pace of living.

Since the founding of the VPC in 1988, the IQPs in Venice provide an opportunity for students to see the implementation of their projects for the benefit of an entire city. Projects are conducted for Venetian, American and international organizations and include environmental, socioeconomic, artistic, cultural, and technical concerns important to the revitalization of this historic city. The over 120 projects completed in Venice include: studies on aspects of the Canals of Venice; which resulted in the publication of a book under the auspices of UNESCO; a number of projects on the preservation of Venetian art; several environmental studies on the lagoon ecosystem, which are contributing to the creation of a Lagoon Park; a variety of projects for the improvement of the urban quality of life in the city and the lagoon islands, which have resulted among other things, in the re-engineering of the Venetian cargo delivery system and the design of a vacuum sewer system to prevent discharges in the city's canals.

---

## **PROGRAMS IN AFRICA**

---

---

### **CAPE TOWN PROJECT CENTER - IQP**

---

Director: Prof. S. Justo, Project Center

Cape Town is located at the southern tip of South Africa. It is a city of many flavors, encompassing both developed nation aspects and developing nation characteristics. It is accessible to some of the loveliest and most interesting terrain that Southern Africa has to offer. Students will be able to visit the African bush (to see wild animals in well maintained and controlled parks), experience a cosmopolitan African city, and work on projects in some of the poorest and neediest areas of the region. Cape Town has wonderful resources and climate.

South Africa has the infrastructure of a developed nation but very limited resources for those areas that were neglected under apartheid. There will be a focus on energy resources, water conservation and the provision of housing, health care and other issues of sustainability to under-developed areas. The projects will be sponsored by government and non-governmental organizations (NGO's) and will focus on issues of sustainable development for the region. Students will have opportunities to



work in informal housing settlements, in semi-rural areas, under the guidance of local experts.

The preparation for these projects will require no prior knowledge of Africa and will focus on the specific projects the students will undertake as well as the historical context.

---

## NAMIBIA PROJECT CENTER - IQP

---

Director: Prof. C. Peet, Project Center

Namibia is a southern African nation of extensive national parks, deserts, seaside ports, livestock farms, and towns, with an excellent infrastructure of maintained roads, clean water, and good services. Students will live in Windhoek, the modern capital city, on the campus of the Polytechnic of Namibia, WPI's partner university in Namibia. They will work in the city as well as other parts of the country. There will be an opportunity to visit national parks and other tourist attractions and a limited opportunity to become familiar with African rural life.

Namibia's well-developed government agencies at both the national and municipal levels will sponsor many of the projects, and these projects will generally focus around issues of sustainable development. In particular, projects typically investigate alternative energy sources, improved water and sanitation management, improved preventive health education, low-income housing, micro-level income generating activities and tourism development. Local towns and peri-urban informal settlements will be the venue of some of the projects. No prior knowledge of Africa is needed, but the preparation will include a heavy commitment to learning about the culture of Namibia in addition to preparing specifically for the projects.

---

## MOROCCO HUMANITIES PROGRAM

---

Coordinator: Prof. W.A. Addison, Salisbury Labs 238

Students will study at Al Akhawayn University (AUI), located in Ifrane, Morocco. Ifrane is 120 miles east of Morocco's capital Rabat and 35 miles from the historic imperial cities of Fes and Meknes-cities famous for their revered mosques and colorful Berber migrants. With a population of about 15,000, Ifrane is a peaceful resort and recreational village in the foothills of the Atlas Mountains, known for its French colonial architecture as well as a royal palace. Al Akhawayn University is a semi-private, English-speaking university founded by King Hassan II of Morocco and King Fahd of Saudi Arabia. Since about half the faculty hold American graduate degrees, AUI resembles in some respects an American university. Throughout Morocco, cous cous is the favorite meal in local restaurants and traditional pastries and fresh mint tea are typical snacks at sidewalk cafés.

Two-thirds unit of AUI courses will be devoted to the history of the Arab World, Islamic Civilization, and contemporary issues in North Africa. One-third unit will be an independent study project based upon course work and upon tours to Moroccan historic and cultural sites under the supervision of the on-site advisor. These projects may focus upon a variety of areas, including history, religion, art and architecture, as well as contemporary socio-political issues, with the goal of providing greater understanding of Arab and Muslim peoples. The unit of work will either conclude the sufficiency or can be credit toward a Humanities and Arts or International Studies minor or major.

---

## PROGRAMS IN ASIA

---

### BANGKOK PROJECT CENTER - IQP

---

Directors: Prof. C. Demetry, Washburn Shops  
Prof. R. Vaz, Project Center

Situated in the heart of Southeast Asia, Thailand presents many of the opportunities and challenges common to developing nations. Students at the Bangkok Project Center have a unique opportunity to become acquainted with the people of Thailand and to help address local problems by working on a variety of social and environmental projects. Some projects provide the opportunity to work with underserved communities, and some give students the opportunity to experience life in the countryside. Despite its challenges, Thailand is intensely beautiful: a land of gilded temples and golden beaches. The Thai people are among the friendliest and most hospitable in the world and have a great talent for enjoying life. Accommodations on the prestigious Chulalongkorn University campus position WPI students to meet Thai students and to explore the city's many attractions.

WPI students work in project teams on IQPs sponsored by local nonprofit organizations, universities, governmental and non-governmental organizations. Projects are conducted on a wide variety of topics and are arranged in advance through resident coordinators in Bangkok. Project themes often center on health and human services, community development, sustainable development and appropriate technology, and environmental issues.

---

### HONG KONG PROJECT CENTER - IQP

---

Director: Prof. C. Peet, Project Center

Hong Kong provides a gateway to the most dynamic and important region on the planet. The wealth of the world has moved to Asia, and Hong Kong plays a crucial role in the development of China-currently the most significant economy in Asia. This city radiates energy as it rapidly modernizes and takes the lead in economic development, hi-rise building, efficient transportation, artistic expression, educational reform and environmental conservation. Students will live in furnished apartments with small kitchens, with 2-3 students in each apartment, in a typical Chinese residential neighborhood, somewhat different from typical tourist areas of Hong Kong.

In Hong Kong WPI works with a number of educational, social service and environmental organizations and institutions. Hong Kong University, Hong Kong Polytechnic University and Hong Kong University of Science and Technology have sponsored projects, while other sponsors include Friends of the Earth, Hong Kong Council of Social Service, St. James Settlement and Caritas. New sponsors are sought on a regular basis. In addition, WPI has a Memorandum of Understanding with Hong Kong Polytechnic University (HKPU), giving WPI students access to library and other facilities on the conveniently located campus in TsimShaTsui, Kowloon, as well as enabling some HKPU students to work with WPI students on their projects, especially in the first half of January.

IQPs will deal with urban planning, a greener environment, sustainable resource use, education reform and innovation, economic and social issues, and other topics as appropriate.

---

## WUHAN PROJECT CENTER - MQP

---

Director: Prof. Y. Rong, Washburn Shops 307T

As manufacturing industry becomes more and more global, many research, design, and manufacturing activities go to China. To experience working with professionals from different backgrounds and in a different cultural environment, 10 ME students from WPI will be selected to work with 10 students from Huazhong University of Science and Technology (HUST), Wuhan, China. Five projects defining problems and providing solutions with social constraints will be completed. HUST is a major university in China with excellent engineering programs. The mechanical engineering major has been consistently ranked among the top major in China. Wuhan is a large and industrialized city in central China, with a rich cultural heritage and easy access to Beijing and Shanghai, as well as other cities, by train or airplane. Students will stay on HUST's campus, but may travel to other cities based on the project requirements. Students will have a chance to merge into Chinese culture and experience people's daily life in China. The projects will be completed within 7-8 weeks.

These ME MQPs will be conducted at HUST, with 2-3 trips to other cities. The WPI students will work with HUST students in mixed teams, with co-advisors from both WPI and HUST. The projects are real world problems and sponsored by local companies (some of them are foreign invested) and institutions, in the area of mechanical product and system design, the manufacturing processes, and lean manufacturing implementations.

---

## PROGRAMS IN LATIN AMERICA

---

### COSTA RICA PROJECT CENTER - IQP

---

Director: Prof. S. Vernon-Gerstenfeld, Project Center

Costa Rica is a land of contrasts: banana plantations, flaming volcanoes, misty black sand beaches and a thriving modern capitalist economy. A remarkably stable country, politically and economically, Costa Rica offers an opportunity for students to become immersed in a Central American culture where democracy, economic development, and concern for the environment are a permanent part of the landscape. Students stay in the capital city of San José, but ample opportunity is found to visit the country's attractions. Many projects have fieldwork associated with them.

Costa Rica's unique environment provides students opportunities to focus on environmental conservation and sustainable development by working with government agencies dedicated to those issues and with selected museums and private organizations. Prior knowledge of Spanish language is not required for participation. All students, however, must complete a two-week intensive language program on site.

---

## PUERTO RICO PROJECT CENTER - IQP

---

Director: Prof. S. Vernon-Gerstenfeld, Project Center

The Puerto Rico Project Center offers an opportunity to be immersed in a Caribbean culture that is a unique and harmonious blend of Spanish and North American influences found nowhere else in the world. Located in San Juan, the Center offers the attractions of a large metropolitan area within easy reach of El Yunque national rain forest, white sand beaches, historic El Morro Spanish fortress, Arcibo Observatory, and many other sites of interest.

Projects are completed in teams and span a wide variety of topics including the environment, public health, housing, social welfare, transportation, and land use. Sponsoring agencies have included many offices of the government of the commonwealth as well as local industries.

---

## PROGRAM IN THE SOUTH PACIFIC

---

### AUSTRALIA PROJECT CENTER - IQP

---

Directors: Prof. H. Ault, Higgins Labs 207

Melbourne, situated along Australia's southeast coast, is the country's second largest city. A city of parks and gardens, specializing in arts festivals, sporting events, and fine dining, it was voted "the world's most livable city" in an international survey. Melbourne, Boston's sister city, is also a fine place from which to explore the diversity of Australian life; only a short distance from mountains, deserts, beaches, mining towns, and extensive parklands and wildlife reserves.

IQPs involve outreach to the Australian public on issues or topics regarding science, technology and society. The projects usually focus on disabilities, fire protection or the environment.

---

## INDIVIDUALLY SPONSORED RESIDENTIAL PROJECTS (ISRP<sub>s</sub>)

---

Many students and faculty augment the educational opportunities available at WPI's formal project centers and programs with individually sponsored residential, off-campus projects. All such programs must adhere to common, carefully structured risk management protocols such as those developed and implemented at established project centers. Otherwise, students, faculty, and WPI are exposed to unnecessary risk.

Hence, the Provost requires completion of the following risk management protocol by all faculty intending to advise students who will earn academic credit while in residence off-campus in individually sponsored projects.

1. Two terms in advance of the off-campus activity: Faculty advisor sends a letter of intent to the Provost's office. The letter describes the scope of the anticipated project, where it will happen, how many students will participate, and the term that the students will be off-campus.

2. Ten weeks prior to departure: Faculty advisor completes and submits a completed ISRP form to the IGSD (with a copy sent to Natalie Mello in the IGSD). The ISRP form is co-signed by the academic department head (MQP or Sufficiency) or Dean of IGSD (IQP). At this time a signed Transcript and Judicial Release Form must be submitted for each potential student participant.
3. Eight weeks prior to departure: All students expecting to participate in an ISRP should be in good academic standing at this time. WPI reserves the right to withdraw acceptance to students who are subsequently placed on academic warning. Students placed on academic probation are not eligible to participate. Upon review of academic and judicial records for each student the IGSD will inform the advisor of students who may be disqualified due to poor academic performance or judicial history at WPI.

4. Six weeks prior to departure: Student participant(s) submit the following forms to the faculty advisor: the Acknowledgement of Voluntary Participation, the Off-Campus Students' Health Update and Records Release Form, and the WPI Off-Campus Travel Information Form.
5. Five weeks prior to departure: The advisor submits these completed forms (item 3) to the IGSD. Please note that all forms can be found at the IGSD Web Page.

Please note that all forms can be located on the Web at <http://www.wpi.edu/Academics/Depts/IGSD/>  
 Project registration will not be complete until the conditions of this protocol are met.

At the completion of step 2, WPI's risk managers will review the information provided and make a recommendation to the Dean of IGSD, who will assist the Provost in making a final decision to approve or disapprove the activity based on considerations of risk management. The faculty advisor will learn of this decision no later than the first day of the term preceding the proposed activity.

	E Term Away	A Term Away	B Term Away	C Term Away	D Term Away
Proposal made to Provost's Office	By January 10th	By March 10th	By May 10th	By September 10th	By November 10th
Completed ISRP form submitted to Provost's Office	By March 15th	By June 20th	By August 25th	By October 25th	By January 5th
Completed Health & Safety Forms for each student submitted to the IGSD	By April 20th	By July 25th	By September 25th	By December 5th	By February 5th

## ON-CAMPUS IQP PROGRAMS

### LIVING MUSEUMS PROGRAM

The Living Museums Program provides students with unusual opportunities to carry out IQP projects at various culturally rich museums of New England. Museums synthesize knowledge and combine artifacts with primary and secondary documents, often to create an entire social and physical environment. Thus, as students work with professional staff, documents, and artifacts at museum sites, they gain an understanding of the past and present, and begin to see how distinct aspects of human life fit together to form a specific culture. At the outstanding museums participating in the program, students can select projects from a varied list of areas ranging from medieval warfare at the Higgins Armory Museum in Worcester to the rich history and literary culture of Concord, MA, at the Concord Museum and the Thoreau Lyceum.

Special projects are available each summer in Term E at several museums and historical institutions such as : Mechanics Hall, Worcester, MA; the Worcester Historical Museum; Fruitlands Museum in Harvard, MA, Martha's Vineyard, and Higgins Armory Museum.

## GENDER, RACE, AND TECHNOLOGY

Prof. S. Vernon-Gerstenfeld, IGSD

Student projects in this program research issues in two general areas: (a) the participation of women and people of color in engineering and science education and in engineering professions, and (b) the effects of particular technologies on women, African Americans, Hispanics, Native Americans, and other specific racial or ethnic groups.

Projects are often coadvised, with one advisor from humanities or social science, and one advisor from science, engineering, or computer science disciplines.

Past and ongoing project topic areas include:

- effects of automation on office workers
- women in science and engineering professions
- underrepresented groups in science and engineering professions
- sex differences in learning styles in technical subjects
- ethics and reproductive technologies
- science and math education for precollege Native Americans, Hispanics and African Americans.

Project ideas in these or other areas related to gender, race, and technology can be initiated by students or faculty. For more information, contact Prof. Susan Vernon- Gerstenfeld, Project Center 216.

## RECENT CHANGES IN THIS REQUIREMENT

Effective with the class entering in the fall of 2007 the requirements in the Humanities and Arts have changed. The set of requirements previously referred to as the “Sufficiency” has been modified, and this new set of requirements will no longer be referred to as the Sufficiency. Students entering prior to A term of 2007 may elect to follow either the previous (“Sufficiency”) or new Humanities and Arts Requirements. Students entering for A term, 2007 or later must follow the new requirements. In this catalog, the term “Sufficiency” will still appear as the transition to the new requirements proceeds.

## OVERVIEW

The Humanities and Arts Requirement empowers students to meet the broad educational goals of WPI. The balance between technological and humanistic education and the emphasis on inquiry-based approaches to student learning have been and remain hallmarks of a WPI education. In concert with WPI's other degree requirements, the humanities and arts requirement embodies the institute's definition of an educated person. The humanities and arts requirement engages students with theory and practice - *Lehr und Kunst* - through the following educational goals.

### GOALS OF THE HUMANITIES AND ARTS REQUIREMENT

- to introduce students to the breadth, diversity, and creativity of human experience as expressed in the humanities and arts;
- to develop students' ability to think critically and independently about the world;
- to enhance students' ability to communicate effectively with others in a spirit of openness and cooperation;
- to enrich students' understanding of themselves;
- to deepen students' ability to apply concepts and skills in a focused thematic area through sustained critical inquiry;
- to encourage students to reflect on their responsibilities to others in local, national and global communities;
- to kindle in students a life-long interest in the humanities and arts.

### MEETING THE REQUIREMENT

Students fulfill the humanities and arts degree requirement by completing two units of work consisting of six student-selected courses. In selecting these courses, students complete breadth and depth components of the requirement. To ensure breadth, students select at least one course each from two of three different intellectual clusters. To ensure depth, students complete one unit of thematically-related work which must include at least one course at the 2000-level or above and culminate in an inquiry seminar or practicum (HU3900 or equivalent). Students may take six courses in a foreign language as an exception to the breadth component, but their sequence of foreign language courses must culminate in a seminar or practicum. At the end of the seminar or practicum, every student will submit documentation to certify completion of the requirement.

### BREADTH COMPONENT:

To ensure intellectual breadth, students must select at least one course from at least two of the following three intellectual clusters:

- art/art history, drama/theatre, and music (AR, MU, TH);
- languages, literature, and writing/rhetoric (EN, WR, RH, SP, GN);
- history, philosophy and religion (HI, HU, PY, RE).

WPI offers a flexible curriculum to entrust students with a significant amount of choice and responsibility for planning their own course of study. At the same time, WPI requires students to take at least one course each in at least two of three intellectual clusters to provide exposure to the creativity of the fine and performing arts, modes of communication in languages and literature, and the cultural analysis of the past and present. Students are encouraged to experiment and to take courses beyond the minimum requirement of one course in two different areas. By providing exposure to multiple areas, the breadth component encourages students to appreciate the fundamental unity of knowledge and the interconnections between and among diverse disciplinary fields.

The one exception to this breadth requirement is that students may take all six courses in a foreign language. Development of proficiency in a foreign language necessitates sustained engagement in the language beyond the elementary and intermediate level. Foreign language instruction is broadly interdisciplinary and includes elements of the history, literature, and culture of a particular language area. A student in foreign languages must still meet the depth component of the requirement through completion of a practicum or seminar in the language. A student who begins foreign language study is not compelled to remain in that subject, but could choose to switch to another subject of study and complete the depth component in another thematic area.

### DEPTH COMPONENT:

To ensure depth, students complete at least one unit (three courses) in a focused thematic area that includes and culminates with an inquiry seminar or practicum. At least one of the two thematically-related courses that precede the seminar or practicum must be at the 2000-level or above.

The WPI Plan calls for students to develop a meaningful grasp of a thematic area of the humanities and arts. After taking courses in at least two different areas of the humanities and arts, students pursue deeper study by choosing at least two courses in a focused thematic area that leads to an inquiry seminar or practicum. Students are strongly encouraged to take 2000-level courses and one 3000-level course in a focused thematic area prior to a culminating activity. To ensure that students develop a program of increasing complexity, the depth component requires that students take at least one course at the 2000-level or above before the seminar or practicum. The structure of the requirement remains flexible so that students will become intentional learners as they select their own sequence of thematically-related courses.

In most areas, students complete the depth component of the requirement by taking an Inquiry Seminar. In areas such as drama/theatre, music, the visual arts, or foreign languages, it

may be appropriate for students to complete the depth component of the requirement with a Practicum. In either format, the combination of courses and seminar or practicum provides a deeper engagement with sustained critical inquiry and the integration of theory and practice in an area of the humanities and arts.

The Humanities and Arts department defines specific materials that each student submits at the end of the seminar or practicum to document completion of the breadth and depth components of the requirement. For example, a Humanities and Arts Requirement Portfolio could include a list of the courses taken to fulfill the breadth and depth components and a selection of each student's individual work from the culminating seminar or practicum. Such a portfolio would not include material from all courses, nor would it include all material from the culminating seminar or practicum. Rather, a portfolio would enable each student to demonstrate that they have met the goals of the Humanities and Arts Requirement and to reflect on their progress toward achieving the overall learning outcomes of WPI.

It is expected that in most cases the final grade of the seminar or practicum will be used as the overall evaluation for the Completion of Degree Requirement (CDR) for the Humanities and Arts Requirement.

### INQUIRY SEMINAR OR PRACTICUM

The culmination of the depth component of the humanities and arts requirement is an inquiry seminar or practicum. The educational goals for the seminar or practicum are the same regardless of the format.

#### GOALS OF THE INQUIRY SEMINAR OR PRACTICUM:

- *Critical inquiry*: to develop each student's ability to apply concepts and skills learned in the humanities and arts, the seminar/practicum offers opportunities to engage in sustained critical inquiry, analysis, or problem-solving in a focused thematic area.
- *Research and investigation*: to engage students in research, discovery, creativity, or investigation, the seminar/practicum provides opportunities for students actively and critically to seek and evaluate new information and insights using multiple sources. These opportunities need not necessarily be research papers.
- *Communication and writing*: to develop each student's ability to communicate effectively both orally and in writing, the seminar/practicum includes discussion of appropriate communications skills and provides opportunities to revise written work after receiving feedback from the instructor.
- *Intellectual independence*: to foster independence of thought, the seminar/practicum offers significant opportunities for individual, self-directed work.
- *Conversation and dialogue*: to promote individual reflection and the appreciation of diverse perspectives, the seminar/practicum consists of classroom activities other than traditional lecture to encourage discussion and collaborative learning in a spirit of openness, cooperation, and dialogue with peers. The thematic focus, structure, and assignments for each seminar or practicum are to be determined by each individual instructor to achieve these goals.

### INQUIRY SEMINAR

The Inquiry Seminar, usually taken in the sophomore year, represents the culmination of the Humanities and Arts Requirement. The Seminar provides an opportunity for students to explore a particular topic or theme in the humanities in greater depth. The Seminar has two primary goals. The first is to foster independence of student thought, typically through some form of self-directed activity. The second is to encourage a cooperative, dialogic approach to inquiry, through open exchanges with peers in a small, intensive classroom setting (typically 12 students or fewer). Students learn how to frame questions in the context of a particular discipline or field of study, and to explore or investigate problems using methods appropriate to work in the humanities and arts.

As the student's capstone experience in the humanities and arts, the Inquiry Seminar is intended to help students take their knowledge of the humanities to a higher level. The purpose of the Inquiry Seminar, therefore, is not to provide a broad survey or general introduction to a given discipline, but to provide a structured forum in which students might approach a specific humanities-related problem or theme at a deeper, more sustained level of intellectual engagement than would normally be possible within a traditional course setting. The pedagogical idea behind the Inquiry Seminar is that work in the humanities and arts is at once an intensely personal enterprise, in which the individual freely draws on her or his own particular interests, abilities, passions, and commitments, and at the same time a form of ethical community in which the practitioner is always in conversation with and accountable to others.

While the specific content and requirements of the Inquiry Seminar vary from instructor to instructor, all Inquiry Seminars incorporate self-directed learning as a significant part of the curriculum. It is the department's expectation, therefore, that by the time they enroll in the Seminar, students should have sufficient background in the humanities and arts to be able to work independently and to pose questions of their own. Students will be asked to research and write a term paper, to assemble a portfolio of writings or exercises, or otherwise to demonstrate their ability to pose a question of relevance to humanities inquiry, and to answer it. At the same time, the Seminars are designed to foster an atmosphere of intellectual collaboration and discovery. Students are required to participate fully in seminar discussion, to share the results of their own research or activities, and to engage the ideas and interests of their peers in a constructive and collegial way.

### INQUIRY PRACTICUM

Students in the performing arts have the option to complete their Humanities and Arts sequence with an Inquiry Practicum in music or drama/theatre. A practicum shares the same goals and objectives of an inquiry seminar but provides students with a production/performance experience which emphasizes the hands-on, practical application of skills and knowledge gained from previous Humanities and Arts courses. Samples of practicums in music include composing, arranging, or performing a solo recital. Drama/Theatre students may choose to act, direct, or design for a campus production. In addition to weekly meetings, students may be required to attend rehearsals and performances. The design of the final project is determined through conversations between instructors and students. Due to the unique nature of the practicum, permission of the instructor is required to enroll in a practicum.

**FOREIGN LANGUAGES: PRACTICUM OR SEMINAR**

Students in foreign languages may complete the Humanities and Arts Requirement in one of the following three ways:

1. *practicum in the sixth and final course in a foreign language.*  
The practicum will include evaluative components or exams to demonstrate overall language skills in four areas: listening, speaking, reading, and writing. The practicum will require students to demonstrate breadth of cultural knowledge of the language area. (Examples of practicum courses: GN 3512, GN 3515; SP 3522; SP 3527)
2. *advanced language seminar after five previous courses in the foreign language.* The seminar will explore a thematic topic and provide opportunities for individual inquiry. (Seminar examples: GN 3513, GN 3514; SP 3523, SP 3524, SP 3525, SP 3526, SP 3528, SP 3529, SP 3530, SP 3531)
3. *advanced language seminar after advanced-level language courses combined with courses from other areas of study.*  
Students who demonstrate basic oral, written, and cultural knowledge of a foreign language in a placement test at the advanced level may combine courses from other areas for their requirement. (Seminar examples are the same as option 2.)

Option 1 and 2 require students to take six courses in a foreign language. For example, in option 1, a student without prior language training might begin with GN 1511 Elementary German I and conclude with a practicum in GN 3512 Advanced German II. In option 2, for example, a student might start with SP 2521 Intermediate Spanish I followed by five Spanish courses which culminate in one of the designated seminars. In option 3, students who demonstrate knowledge of the foreign language at the advanced level may mix courses from other areas in their course sequence. For example, a student might take two courses from history, philosophy, music, etc. along with four advanced Spanish courses which would culminate in a designated seminar. Students in all three options for foreign languages would be required to submit the same materials to demonstrate completion of the requirement as students whose culminating experience was an inquiry seminar or practicum in another area of the Humanities and Arts.

**TRANSITION IN DEGREE REQUIREMENTS**

As stated above, the new degree requirement in Humanities and Arts take effect for the class entering WPI in the fall of 2007. All current students, who have yet to complete their Sufficiency Requirement, may follow either of the following options:

1. Current students may complete their Humanities and Arts requirements by following the rules that were in effect at the time that they enrolled. Faculty will be available to advise individual students in ISP/Sufficiencies during the 2007-2008 academic year, but we anticipate that most students will enroll in either inquiry seminars or practicums. Students who wish to complete their Humanities and Arts requirement by enrolling in an ISP may only do so with the consent of the instructor. Students completing foreign language Sufficiency course sequences will continue to do so by completing 6 courses in language study.

**OR**

2. Current students may complete their Humanities and Arts requirement by completing courses in Humanities and Arts and then completing an inquiry seminar or practicum in place of the ISP. Before enrolling in the inquiry seminar or practicum, students need only complete 2 courses in the discipline of the inquiry seminar/practicum. (This is a relaxation of the five thematically related courses requirement of the past and does not impose any new requirements on current students). For clarity, students who have enrolled before the fall of 2007 will not be obligated to complete either the breadth requirement (at least one course in two of three disciplinary clusters) or the requirement that one course in the depth area be taken at the 2000 level or above. Advisors, however, should encourage students to select courses that will meet these requirements whenever possible.

Students who transfer less than six Humanities and Arts courses from another institution must complete an inquiry seminar or practicum to complete the Humanities and Arts requirement. Students who transfer six or more courses in Humanities and Arts will have the option of submitting a CDR form or engaging in additional work (or documentation of work) to earn an "A" on the CDR, in accordance with current transfer rules (see below).

All students, whether enrolled before or after the Fall of 2007, may have the option of completing their Humanities and Arts requirement while enrolled for 1 unit of coursework at an off-campus project center where one-third unit of the coursework shall include an inquiry seminar or practicum. Other than dropping the term "Sufficiency", there is no change to the Off-campus Humanities and Arts study option (See page 29 of the Catalog).

**TRANSFER STUDENTS AND THE HUMANITIES AND ARTS REQUIREMENT**

Transfer credit in the Humanities and Arts at WPI is granted on a course-for-course basis. All Transfer and 3-2 Program students entering WPI with *fewer than six courses or their equivalent of transfer credit in the Humanities and Arts* must complete work in the Humanities and Arts, including an Inquiry Seminar/Practicum to the extent that the overall Humanities and Arts credit totals two units.

No credit toward the Humanities and Arts requirement is given for introductory-level foreign-language courses unless the entire program is in that foreign language. Usually only one transfer course in Freshman English can be applied toward the requirement. In all cases, the professor for the Inquiry Seminar/Practicum has the final decision on what courses are acceptable within the student's sequence leading up to the project. Up to one unit (i.e. three courses) of transferred work in the Humanities and Arts that is not credited toward the Humanities and Arts Requirement can be credited toward the fifteen-unit graduation requirement; such courses shall receive credit under the category of EL 1000.

If a Transfer or 3-2 Program student *has completed two units of acceptable college-level work in the Humanities and Arts prior to entering WPI*, a Completion of Degree Requirement form will be submitted by the Humanities and Arts Department Coordinator for Transfer Students at the request of the student. The grade for such a Humanities and Arts Requirement met by transfer credit is normally a grade of "CR". Students whose grades on transferred courses average A can engage in additional work or submit samples of their previous work and may be awarded an A for the Humanities and Arts Requirement.



Alternately a transfer student may elect to undertake an Inquiry Seminar/Practicum in an effort to achieve an A grade. These evaluation options must be exercised prior to the Department's submission of the Completion of Degree Requirement form to the Registrar.

Decisions concerning credit toward the Humanities and Arts requirement are made by the Humanities and Arts Coordinator for Transfer Students, Professor James Hanlan. He can be contacted in room 28 of Salisbury Laboratories, or at extension 5438, or email [jphanlan@wpi.edu](mailto:jphanlan@wpi.edu).

## **GUIDELINES FOR GRANTING TRANSFER CREDIT TO U.S. STUDENTS FOR FOREIGN LANGUAGE STUDY**

### **A. Credit for study on the high school level:**

1. Transfer credit of 1/3 unit is given for Advanced Placement with a score of 4 or 5.
2. Students with three or more years of foreign-language study in high school, but who have not taken the Advanced Placement examination in that language, may receive 1/3 unit credit for their high school language study upon satisfactory completion of two courses in the same language on the intermediate level or above. (Note: Courses in German and Spanish in addition to those offered at WPI, as well as courses in other languages, are available at other colleges in the Consortium.)
3. In either case 1. or 2. above, in order to receive 1/3 unit credit, students must begin their WPI course sequence at the Elementary II level or above.

### **B. Credit for study at other colleges and universities:**

1. Language study which is done at other universities and colleges prior to entering WPI, or done with the prior written permission of the student's Humanities and Arts Consultant (not the Department Head) as part of an agreed-upon Humanities and Arts sequence, transfers on a course-for-course basis.
2. Language study which is done at foreign universities, language institutes, cultural institutes, etc., prior to entering WPI, or done with the prior written permission of the student's Humanities and Arts Consultant (not the Department Head) as part of an agreed-upon Humanities and Arts sequence, is assessed by the Foreign Languages Consultant on the basis of matriculation papers and the level or work accomplished.

## **OTHER OPTIONS**

### **SOCIAL SCIENCE COURSES**

Humanities and Arts advisors may allow students to include one social science course in their Humanities and Arts sequence on the basis of that course's suitability to the development of students' particular humanities themes.

Such a course must be more than "related to" or "in support of" a given theme. It must be at the interface of humanities (normally history) and blend in with certain Humanities and Arts courses. A course in American government, for example, could logically be included in any number of American history sequences.

The inclusion of a social science course in the Humanities and Arts requirement of any student requires the written "advice and consent" of his or her Humanities and Arts advisor after the theme has been determined and before the student registers for the seminar.

One of the following social science courses (and no other) may be included in the Humanities and Arts sequence:

- GOV 1301 U.S. Government
- PSY 1402 Introduction to Social Psychology
- STS 2208 The Society - Technology Debate

### **INTERDISCIPLINARY STUDY AT THE AMERICAN ANTIQUARIAN SOCIETY**

A unique opportunity for interdisciplinary work in the humanities and arts is offered by the American Studies Seminar sponsored each fall by the American Antiquarian Society. Organized in collaboration with Worcester's five undergraduate colleges and universities, this seminar focuses on topics that allow students to investigate the Society's rich holdings in early American history, literature, and culture. The Society's unparalleled collection of documents is a short walk from the campus. Information on application deadlines and academic credit toward the Humanities and Arts requirement is available from the WPI Campus Representative to the American Antiquarian Society.

### **OFF-CAMPUS HUMANITIES AND ARTS OPTION**

WPI offers the option to complete the Humanities and Arts Requirement during one term of study at several Project Centers. Normally, students complete the requirement through at least six courses or independent-study projects on campus. However, the "Off-Campus" option allows students to combine at least three courses on campus with one term studying the humanities and arts at a Project Center. Since this one-term project is equivalent to three courses, students may use it to complete the requirement.

Off-campus projects are available in Germany for the study of foreign languages and in London and Morocco for other fields. These off-campus programs have a flexible format. Students devote themselves to one term studying the history, literature, language or culture at the project site with a WPI faculty advisor. The program might combine a thematic seminar in an area of the faculty advisor's expertise with visits to museums, the theatre, musical performances, or cultural excursions.

Although themes or areas of emphasis vary from year to year, all off-campus Humanities and Arts activities culminate in a written report in an area of interest to the student.

To be eligible for this one-unit activity, students must have already completed three courses in humanities and arts before they leave campus. Students may apply to the off-campus program before they have taken all three courses. However, students may not participate in the program unless they successfully complete one unit of work in humanities and arts before the term of the project. In addition, students going to any Project Center must complete all of the forms required by the Interdisciplinary and Global Studies Division. Requirements:

- Students must have completed at least three courses in the Humanities and Arts at WPI, or have earned equivalent course credit approved by the Humanities and Arts Department, before the term of the off-campus activity. The Department may allow students to count transfer or advanced placement credits toward the three course minimum;

- Students must be accepted into the off-campus Humanities and Arts program by the Humanities and Arts Department, and complete all forms required by the Interdisciplinary and Global Studies Division, in order to register for these projects.
- Students might be required by the faculty advisor to complete a PQP or attend required meetings before the off-campus project;
- Students must submit a written report or paper at the end of the project. Students also may be required to submit written updates at various times in the course of the project. In all cases, the faculty advisor at the project site will determine the precise form of the written requirements.
- Students may be required to give an oral presentation at the end of the project;
- Under normal circumstances, students must complete the project within one term in order to receive the full unit of credit;
- Only members of the Humanities and Arts faculty at WPI may advise off-campus Humanities and Arts projects.

### OFF-CAMPUS RECOMMENDATIONS

All off-campus programs benefit from advance planning. Discuss the possibility of an off-campus activity with your academic advisor at the beginning of the freshman year. Consult with the WPI faculty who will advise these off-campus projects as early as possible, since they may be able to suggest useful courses or other background resources for the projects. Also keep in mind that three courses are the minimum required, but many students find it advantageous to take additional courses before going away.

The interdisciplinary London and Morocco programs are open to students with a background in areas of the humanities

and arts besides foreign languages, including art history and architecture, drama/theatre, history, literature, music, philosophy, religion, or writing/rhetoric. After taking at least three courses in any of these areas on campus, you could then go to London to complete your project. Some students also have gone to London with this program to study beyond the Humanities and Arts requirement for international studies, history, literature, music, theatre, or other areas.

WPI offers programs in the German language at Darmstadt. This program requires completion of foreign language courses through the level of intermediate II or above (2000-level or above) before going abroad. For students who have taken foreign language courses in high school, language placement exams are available during New Student Orientation. Some students with basic foreign language preparation have completed their arts projects in Germany. We welcome a creative approach to off-campus study.

More advanced students may participate in these off-campus programs by doing work toward a minor or major. A student who had already completed their Humanities and Arts requirement on campus, for example, might be able to work in the humanities and arts on an Independent Study Project that could count toward a minor. Or a student at one of these sites could work on a Major Qualifying Project in fields such as Humanities and Arts, International Studies, or Professional Writing.

The Humanities and Arts Department advertises upcoming project locations and application deadlines at the Global Opportunities Fair each September. Future project opportunities might include other foreign locations or projects that provide the context for an intensive study of humanistic themes associated with particular locales within the United States. Contact the Department of Humanities and Arts for more information.

---

## THE SOCIAL SCIENCE REQUIREMENT

---

Social science deals with the behavior of individuals and groups as well as the functioning of the economic and political systems and institutions that shape and control our lives. As such, it offers a perspective that is essential for anyone desiring a well-rounded education.

Therefore, WPI, in common with other colleges, requires some exposure to the social sciences for its graduates. In satisfying the two-course social science requirement, students are free to take courses in any of the traditional social sciences: economics, political science, sociology, and psychology. Courses with the following prefixes may be counted toward the social science requirement: ECON, GOV, PSY, SD, SOC, SS, STS. The social science courses offered at WPI are grouped into two broad categories. The first consists of core courses that introduce students to the social sciences and help them understand the scope and limits of social science approaches and how they

might be related to the design of Interactive Qualifying Projects. The second, more advanced, set of courses looks in depth at particular issues and problems, providing students with a more detailed understanding of social science disciplines and their use in social problem solving and interactive projects.

To obtain maximum benefit from their study of social science, students should choose courses that will provide knowledge and skills relevant to their Interactive Qualifying Project. These courses should be taken prior to or concurrent with undertaking the IQP and should be selected, if possible, after the student has identified the general topic area in which his or her interactive project work will be carried out.

More information on the alternatives available and the factors that should be considered in choosing courses to satisfy the social science requirement are available on the Social Science and Policy Studies department website at [www.wpi.edu/Academics/Depts/SSPS](http://www.wpi.edu/Academics/Depts/SSPS).

# DEPARTMENT AND PROGRAM DESCRIPTIONS

Aerospace Engineering . . . . .	32
Air Force Aerospace Studies . . . . .	34
Biology and Biotechnology . . . . .	35
Biomedical Engineering . . . . .	36
Chemical Engineering . . . . .	42
Chemistry and Biochemistry . . . . .	45
Civil and Environmental Engineering . . . . .	47
Computer Science . . . . .	52
Computer Science Minor . . . . .	55
Electrical and Computer Engineering . . . . .	56
Minor in Computer Engineering . . . . .	59
Engineering Science Courses . . . . .	60
Engineering Physics . . . . .	60
Environmental Programs . . . . .	60
Environmental Engineering . . . . .	61
Fire Protection Engineering . . . . .	64
Humanities and Arts . . . . .	64
Drama/Theatre Minor . . . . .	67
Minor in Foreign Language (German or Spanish) . . . . .	67
Music Minor . . . . .	67
Writing and Rhetoric Minor . . . . .	68
Industrial Engineering . . . . .	68
Interactive Media and Game Development . . . . .	69
Interdisciplinary Programs . . . . .	70
Professional Writing . . . . .	71
Teacher Licensing . . . . .	71
International Studies . . . . .	72
Law and Technology Minor . . . . .	73
Liberal Arts and Engineering (Bachelor of Arts Degree) . . . . .	74
Management . . . . .	76
Entrepreneurship Minor . . . . .	78
Management Minor . . . . .	78
MIS Minor . . . . .	78
Organizational Leadership Minor . . . . .	79
Manufacturing Engineering . . . . .	79
Manufacturing Engineering Minor . . . . .	81
Materials Engineering . . . . .	81
Minor in Materials . . . . .	81
Mathematical Sciences . . . . .	82
Statistics Minor . . . . .	87
Mathematics Minor . . . . .	87
Mechanical Engineering . . . . .	88
Military Science . . . . .	92
Physical Education, Recreation, and Athletics . . . . .	93
Physics . . . . .	94
Physics Minor . . . . .	96
Pre-Law Programs . . . . .	97
Pre-MBA Program (Dual Degree) . . . . .	97
Pre-Medical, Pre-Dental and Pre-Veterinary Programs . . . . .	98
Project-Based Learning Community Option (PLC) . . . . .	98
Robotics Engineering . . . . .	98
Social Science and Policy Studies . . . . .	99
Social Science Minors . . . . .	102

## SECTION 2

## AEROSPACE ENGINEERING

**DIRECTOR:** N. A. Gatsonis

**PROFESSORS:** N.A. Gatsonis, F. Loeff, R. Sisson

**ASSOCIATE PROFESSORS:** J. Blandino, M. Demetriou, D. Olinger, M. Richman

**ASSISTANT PROFESSOR:** I. Hussein

**PROFESSOR OF PRACTICE:** R. Labonte

### MISSION STATEMENT

The Aerospace Program at WPI aims to graduate students with a comprehensive education that will enable them to establish productive careers in the aerospace industry, government, or academia.

### PROGRAM EDUCATIONAL OBJECTIVES

The aerospace engineering program seeks to impart to our students strong technical competence in fundamental engineering principles along with specialized competence in aeronautical and astronautical topics. At the same time the program seeks to nourish a student's creative talents through research opportunities, with the goal to develop a personal high standard of excellence and professionalism. Finally, the program seeks to provide an appreciation of the role of the aerospace engineer in society.

### PROGRAM OUTCOMES

Graduating students should demonstrate that they attain the following:

- an ability to apply knowledge of mathematics, science, and engineering
- an ability to design and conduct experiments, as well as to analyze and interpret data
- an ability to design a system, component, or process to meet desired needs within realistic constraints such as economic, environmental, social, political, ethical, health and safety, manufacturability, and sustainability
- an ability to function on multi-disciplinary teams
- an ability to identify, formulate, and solve engineering problems
- an understanding of professional and ethical responsibility
- an ability to communicate effectively
- the broad education necessary to understand the impact of engineering solutions in a global, economic, environmental, and societal context
- a recognition of the need for, and an ability to engage in life-long learning
- a knowledge of contemporary issues
- an ability to use the techniques, skills, and modern engineering tools necessary for engineering practice
- knowledge covering one of the areas - aeronautical engineering or astronautical engineering - and, in addition, knowledge of some topics from the area not emphasized
- design competence that includes integration of aeronautical or astronautical topics

## Program Distribution Requirements for the Aerospace Engineering Major

The normal period of residency at WPI is 16 terms. In addition to the WPI requirements applicable to all students (see page 9) students wishing to receive a Bachelor degree in "Aerospace Engineering", must satisfy additional distribution requirements. These requirements apply to 10 units of study in the areas of mathematics, basic sciences, aerospace engineering science and design.

REQUIREMENTS	MINIMUM UNITS
1. Mathematical and Basic Sciences (Notes 1, 2 and 3)	4
2. Engineering Science and Design (Includes MQP) (Notes 4, 5, 6, 7, 8)	6

### NOTES:

1. Must include a minimum of 5/3 units of mathematics including differential and integral calculus, and differential equations.
2. Must include a minimum of 3/3 units in physics including introductory electricity and magnetism, and intermediate mechanics.
3. Must include 2/3 units in chemistry including topics in thermodynamics.
4. Must include 6/3 units in fluids and propulsion with topics in heat transfer, incompressible and compressible fluid dynamics, subsonic and supersonic aerodynamics, airbreathing and rocket propulsion.
5. Must include 4/3 units in materials and structures, with topics in materials science, stress analysis, and aerospace structures.
6. Must include 4/3 units in dynamics and control with topics in orbital mechanics, control theory, guidance, navigation, communications, and aircraft or spacecraft dynamics and control.
7. Must include 1/3 units in aerospace systems design that integrates either aeronautical or astronautical engineering topics.
8. Must include 1/3 Unit of Capstone Design Experience.

### MAJOR QUALIFYING PROJECTS

The Aerospace Engineering Program provides opportunities, resources and organization for MQPs in aeronautics or astronautics. MQPs are conducted in the research laboratories of the Aerospace Engineering program, in conjunction with industry or government research centers. MQPs are often conducted in collaboration with graduate students and serve as a vehicle for integration of undergraduate studies with research in state of the art technologies. Students are encouraged and often supported to participate in the AIAA Northeast Student Conference, other professional meetings organized by AIAA as well as national design competitions.

#### Aeronautics

These project opportunities are for students interested in aircraft and/or aircraft systems design. Central activity in these projects is the design, construction, and testing of remotely piloted aircraft and micro aerial vehicles. Other projects may include topics in aerodynamics, controls, wake flows, and gas dynamics.

#### Astronautics

These project opportunities are for students interested in space science and engineering. Topics include electric propulsion, micro-propulsion, and control of space structures.

**AEROSPACE ENGINEERING PROGRAM CHART**

**12/3 UNITS OF GENERAL EDUCATION ACTIVITIES**

6/3 UNITS H&A SUFFICIENCY	See WPI Requirements
3/3 UNIT INTERACTIVE QUALIFYING (IQP) PROJECT	See WPI Requirements
2/3 UNIT SOCIAL SCIENCE	See WPI Requirements
1/3 UNIT PHYSICAL EDUCATION	See WPI Requirements

**3/3 UNITS OF FREE ELECTIVE**

3/3 UNITS FREE ELECTIVE	See Catalog
-------------------------	-------------

**12/3 UNITS OF MATHEMATICS AND BASIC SCIENCE**

MATHEMATICS 5/3 Units Required	PHYSICS 3/3 Units Required	CHEMISTRY 2/3 Units Required	ELECTIVES 2/3 Units Required
MA 1021 Calculus I MA 1022 Calculus II MA 1023 Calculus III MA 1024 Calculus IV MA 2051 Ordinary Differential Equations	PH 1110 or PH 1111 General Physics- Mechanics PH 1120 or PH 1121 General Physics-Electricity & Magnetism PH 2201 Intermediate Mechanics I	CH 1010 Chemistry I or CH 1020 Chemistry II CH 3510 Chemical Thermodynamics	Student Selected Courses from the General Category of Mathematics and Basic Science

**18/3 UNITS OF ENGINEERING SCIENCE AND DESIGN (Note 1)**

15/3 UNITS OF ENGINEERING SCIENCE AND DESIGN			
FLUIDS AND PROPULSION 6/3 Units Required	MATERIALS AND STRUCTURES 4/3 Units Required	DYNAMICS AND CONTROL 4/3 Units Required	SYSTEMS DESIGN 1/3 Units Required
ES 3003 Heat Transfer ES 3004 Fluid Mechanics ME 3602 Incompressible Fluid Dynamics ME 3410 Compressible Fluid Dynamics ME 3711 Aerodynamics ME 4710 Gas Turbines for Propulsion and Power Generation or ME 4719 Rocket Propulsion	ES 2001 Intro to Materials ES 2502 Stress Analysis ME 3712 Aerospace Structures ME 4718 Advanced Materials with Aerospace Applications	ES 3011 Control Engineering I ME 2713 Astronautics ME 4733 Guidance, Navigation and Communications ME 4723 Aircraft Dynamics and Control or ME 4713 Spacecraft Dynamics and Control	ME 4770 Aircraft Design or ME 4771 Spacecraft and Mission Design

The courses above can be replaced by other equivalent courses, with the approval of the AE Program Committee

3/3 UNITS OF ENGINEERING SCIENCE AND DESIGN
MAJOR QUALIFYING PROJECT (MQP)

Note 1: 1/3 unit of an activity must be in Capstone Design (can be satisfied with MQP, ME 4770, ME4771)

## AIR FORCE AEROSPACE STUDIES

### LT COL TERRENCE A. LEARY, HEAD

PROFESSOR: Lt Col T. Leary

ASSISTANT PROFESSORS: Maj. R. Davis, Capt. D. Richards

### MISSION

The mission of AFROTC is to produce leaders for the Air Force and build better citizens for America. Its vision is to be “a highly successful organization, respected throughout the Air Force, the educational community and the nation.”

### EDUCATIONAL OBJECTIVES:

Students who successfully complete the AFROTC program will have:

1. An understanding of the fundamental concepts and principles of Air and Space.
2. A basic understanding of associated professional knowledge.
3. A strong sense of personal integrity, honor, and individual responsibility.
4. An appreciation of the requirements for national security.

### AIR FORCE ROTC PROGRAMS

There are two traditional routes to an Air Force commission through Air Force ROTC. Entering students may enroll in the Air Force Four-Year Program. Students with at least two academic years remaining in college may apply for the Two-Year Program. However, there are opportunities for Freshmen, Sophomores, Juniors, and in some cases Seniors and Graduate Students. Please check with the AFROTC Detachment Staff for these special circumstances.

### FOUR-YEAR PROGRAM

The more popular and preferred program is the traditional Four-Year Program. To enroll, simply register for Air Force Aerospace Studies in the fall term of the freshman year in the same manner as other college courses. There is NO MILITARY OBLIGATION for the first two years of Air Force ROTC unless you have an Air Force ROTC scholarship.

The first two years are known as the General Military Course (GMC). Classes meet one hour per week and are required for freshmen and sophomores.

Individuals who successfully complete the GMC compete nationwide for entry into the Professional Officers Course (POC). POC classes meet three hours per week and are required for all juniors and seniors. Officer Candidates enrolled in the POC and on scholarship receive a nontaxable subsistence allowance of up to \$400 each month.

Qualified Officer candidates will attend the Air Force ROTC field-training program for four weeks between their sophomore and junior years.

### TWO-YEAR PROGRAM

The Two-Year Program is available for college students with two years of undergraduate or graduate study remaining. Applicants must apply for the program no later than the beginning of Term C (spring semester) preceding those two final years. The applicant will take the Air Force Officer Qualifying Test, will be given a physical examination at no expense, and will meet a selection board.

Applicants for the Two-Year Program will attend the Air Force ROTC field training for six weeks instead of four at an Air Force base prior to their entry into the Professional Officer Course (POC). Like their four year counterparts, they are paid while at field training and will receive travel pay to and from the Air Force base hosting field training. Students accepted into the Two-Year Program will complete the Professional Officer Course as described above.

### OTHER ASPECTS OF THE AFROTC PROGRAM

#### Leadership Laboratory:

Air Force ROTC officer candidates participate in a Leadership Laboratory (LLAB) where the leadership skills and management theories acquired in the classroom are put into practice. The LLAB meets once each week for approximately two hours.

This formal military training is largely planned and directed by the officer candidates. The freshmen and sophomores are involved in such initial leadership experiences as problem solving, dynamic leadership, team building, Air Force customs and courtesies, drill movements, Air Force educational benefits, Air Force career opportunities, and preparation for field training. The juniors and seniors are involved in more advanced leadership experiences as they become responsible for the planning and organizing of wing activities, to include conducting the Leadership Laboratory itself.

#### Field Training:

The summer program is designed to develop military leadership, discipline, and to provide Air Force officer orientation and motivation. At the same time, the Air Force can evaluate each student's potential as an officer. Field training includes aircraft and aircrew orientation, Air Force professional development orientation, marksmanship training, officer training, physical fitness, and survival training. Uniforms, lodging, and meals are provided at no cost to the cadet, and travel at Air Force expense is authorized by air or privately owned vehicle to and from the individual's home of record or school. Additionally, after applicable deductions, cadets receive pay of about \$500 for the four-week encampment and about \$750 for the six week summer camp.

#### Base Visits:

Air Force ROTC officer candidates have the opportunity to visit Air Force bases for firsthand observation of the operating Air Force. These trips are frequently made on weekends or scheduled to coincide with school vacation periods. Officer candidates may be flown by military aircraft or travel by bus to an Air Force base where they spend several days before returning to campus.

#### Other Benefits:

The Air Force provides all Air Force ROTC uniforms and textbooks for on-campus programs and field training. All officer candidates who have received an Air Force scholarship or are enrolled in the Professional Officer Course (POC) may travel free on military aircraft on a space available basis.

#### Additional Information:

In addition to formal activities, the Cadet Wing plans and organizes a full schedule of social events throughout the academic year. These include a Dining-In, Military Ball, a Field Day, and intramural sports activities. Professional Development Training Programs, such as the Rising Sophomore Program, Rising Senior Program and Army Airborne training are also available to selected volunteer officer candidates during the summer.

**Arnold Air Society:**

Each officer candidate can elect to be part of a national society dedicated to conducting service related events for the Air Force and local community. These Arnold Air Society members are involved in a myriad of service projects to include charity work, service to the poor, work with local orphanages, and similar activities. Twice a year, members participate in conventions/conclaves held in various cities and attended by members from all the schools in the country sponsoring AFROTC. Membership is by nomination after completion of a one semester, project-oriented pledge program.

**Civil Air Patrol:**

All Air Force ROTC officer candidates at AFROTC Detachment 340 have the opportunity to become members of the Civil Air Patrol and to receive up to 8 flight orientation rides on Civil Air Patrol aircraft at Worcester Regional Airport.

---

## BIOLOGY AND BIOTECHNOLOGY

---

**E. W. OVERSTRÖM, HEAD**

PROFESSORS: D. S. Adams, J. C. Bagshaw, E. W. Overström, P. J. Weathers

ASSOCIATE PROFESSORS: T. C. Crusberg, S. M. Politz, J. Rulfs, E. Ryder

ASSISTANT PROFESSORS: D. G. Gibson III, L. Mathews, R. Prusty Rao

ADJUNCT AFFILIATE PROFESSOR: A. Di Iorio

ADJUNCT ASSISTANT PROFESSORS/LAB INSTRUCTORS: M. Buckholt, J. Whitefleet-Smith

**MISSION STATEMENT**

The Department of Biology and Biotechnology will make scholarly scientific and technological advances that will address the changing needs of society. We will prepare well educated scientists able to approach problems with creativity and flexibility. A key element in this preparation is active participation in the process of scientific inquiry.

**PROGRAM EDUCATIONAL OBJECTIVES**

The educational objectives of the Department of Biology and Biotechnology are to prepare students to function as scientists and educators in a broad array of biological disciplines. We recognize that the well educated scientist needs facility in technology and skill in critical thinking to function effectively in the professional arena as well as in the global community.

**PROGRAM OUTCOMES**

Students graduating with a Bachelor of Science degree from the Department of Biology and Biotechnology:

- have mastered a broad range of basic lab skills applicable to biology and biotechnology.
- have mastered applied research skills at an advanced level in at least one area of biology and biotechnology.
- know and understand a broad range of basic biological concepts, and can apply and analyze these in at least one speciality area.
- are able to generate hypotheses, design approaches to test them, and interpret the data from those tests to reach valid conclusions.

- have developed the ability to place their own work in a broader scientific context.
- have developed oral and written communication skills relevant to professional positions in biology and biotechnology.
- can find, read and critically evaluate the original scientific literature.
- possess skills necessary for life-long professional learning.
- can function effectively as members of a team.
- demonstrate adherence to accepted standards of professional and ethical behavior.

---

## Program Distribution Requirements for the Biology and Biotechnology Major

---

REQUIREMENTS	MINIMUM UNITS
1. Mathematical Sciences, Physics, Computer Science, Engineering (Note 1)	5/3
2. Chemistry	5/3
3. Biology & Biotechnology (Note 2)	10/3
4. Laboratory experience (Note 3)	4/3
5. Related courses (Note 4)	3/3
6. MQP	1

**NOTES:**

1. BB 3040 may count toward this requirement.
2. Biology & Biotechnology coursework must include 2/3 units at the 1000 level, 4/3 units at the 2000 level, and 4/3 units at the 3000/4000 level, of which at least 1/3 unit must be at the 4000 level. BB 1000, BB 1001 and BB 1002 may not count toward the major requirement. At least 2/3 unit of Biology & Biotechnology coursework must be taken from each of three major divisions of biology (below). The 2/3 unit for each division may include courses from any level (1000-4000).
3. Chosen from BB 2000/3000 Laboratories or CH 4150 and 417X Experimental Biochemistry Laboratories. Must include at least 1/2 unit of course work at the 2000 level.
4. Chosen from the Related Courses List or additional BB 3000/4000 level courses.

**THE THREE MAJOR DIVISIONS OF BIOLOGY****1. Cellular and molecular biology**

BB 1035	Introduction to Biotechnology
BB 2920	Genetics
BB 2550	Cell Biology
BB 2002	Microbiology
BB 3055	Microbial Physiology
BB 4008	Cell Culture Theory and Applications
BB 4010	Advanced Molecular Genetics
BB 4065	Virology
BB 4070	Separation of Biological Molecules
BB 4550	Advanced Cell Biology
BB 4910	Advanced Molecular Biology
BB 4955	Recombinant DNA

**2. Biology of the organism**

BB 125X	Human Biology
BB 3101	Anatomy and Physiology I
BB 3102	Anatomy and Physiology II
BB 3080	Neurobiology
BB 3170	Plant Morphology and Development
BB 3120	Plant Physiology and Cell Culture
BB 3620	Developmental Biology I
BB 363X	Developmental Biology II
BB 3920	Immunology

**3. Organisms in their environment**

BB 1045	Introduction to Biodiversity
BB 2030	Plant Diversity
BB 2040	Principles of Ecology
BB 3140	Evolution: Pattern and Process
BB 3160	Behavioral Ecology
BB 4160	Population Genetics & Phylogeography
BB 4170	Molecular Ecology

**RELATED COURSES**

BME 4541	Biological Systems
CE 3059	Environmental Engineering
CH 2330	Organic Chemistry III
CH 3510	Chemical Thermodynamics
CH 4110	Biochemistry I
CH 4120	Biochemistry II
CH 4160	Membrane Biophysics
CH 4190	Regulation of Gene Expression
CHE 3301	Introduction to Biological Engineering

**OTHER LABORATORY EXPERIENCE LIST**

BME 562	Small Animal Surgery
CE 4060	Environmental Engineering Laboratory
CE 4061	Hydrology
CH 4150	Experimental Biochemistry
GE 2341	Geology

**UNDERGRADUATE RESEARCH PROJECTS**

The biology and biotechnology facilities offer an exceptional learning opportunity since research in an active laboratory group is the principal teaching tool. Tools for modern biochemistry, molecular biology, tissue culture, fermentation, ecology, microscopy and computer integration are all available to undergraduates.

In conjunction with the faculty, students who wish to expand their educational opportunities pursue many off-campus projects each year. Investigations may take place at institutions that have traditionally worked with WPI, such as the University of Massachusetts Medical School, the Worcester Biotechnology Research Park, Tufts University School of Veterinary Medicine, and the Woods Hole Marine Biological Laboratories. The department also has established links with several companies that provide opportunities for project work and summer employment in applied biology and biotechnology.

Undergraduate research projects may be proposed by individual students or groups of students, or may be selected from on-going research activities of the faculty. The departmental faculty must be consulted for approval of a project before student work begins.

**BIOMEDICAL ENGINEERING****Y. MENDELSON, INTERIM HEAD**

PROFESSORS: R. A. Peura, C. H. Sotak

ASSOCIATE PROFESSOR: Y. Mendelson, G. D. Pins

ASSISTANT PROFESSORS: K. L. Billiar, G.R. Gaudette, M. Rolle

**MISSION STATEMENT**

The Biomedical Engineering Department prepares students for rewarding careers in the health care industry or professional programs in biomedical research or medicine.

**PROGRAM EDUCATIONAL OBJECTIVES**

The educational objectives of the Biomedical Engineering Department are to prepare professionals who possess fundamental knowledge of engineering and basic science and can apply these principles to solve problems in biology and medicine.

Through a project-oriented curriculum, which closely embraces the WPI educational philosophy, we prepare students to engage in a lifetime of professionalism and learning.

**PROGRAM OUTCOMES**

The Biomedical Engineering Department has established 13 educational outcomes in support of our department objectives. These general and specific program criteria indicated below in parentheses meet the requirements for Biomedical Engineering accreditation by ABET (the Accreditation Board for Engineering and Technology). Accordingly, students graduating from the Biomedical Engineering Department will demonstrate:

1. An ability to apply knowledge of advanced mathematics (including differential equations and statistics), science, and engineering to solve the problems at the interface of engineering and biology (**general criterion 3a and program criteria**).
2. An ability to design and conduct experiments, as well as to analyze and interpret data from living and non-living systems (**general criterion 3b and program criteria**).
3. An ability to design a system, component, or process to meet desired needs (**general criterion 3c**).
4. An ability to function on multi-disciplinary teams (**general criterion 3d**).
5. An ability to identify, formulate, and solve engineering problems (**general criterion 3e**).
6. An understanding of professional and ethical responsibilities (**general criterion 3f**).
7. An ability to communicate effectively (**general criterion 3g**).
8. The broad education necessary to understand the impact of engineering solutions in a global and societal context (**general criterion 3h**).
9. A recognition of the need for, and an ability to engage in life-long learning (**general criterion 3i**).
10. A knowledge of contemporary issues (**general criterion 3j**).



11. An ability to use the techniques, skills, and modern engineering tools necessary for engineering practice (**general criterion 3k**).
12. An understanding of biology and physiology (**program criteria**).
13. An ability to address the problems associated with the interaction between living and non-living materials and systems (**program criteria**).

Biomedical engineering is the application of engineering principles to the solution of problems in biology and medicine for the enhancement of health care. Students choose this field in order:

- to be of service to people;
- to work with living systems; and
- to apply advanced technology to solve complex problems of medicine.

Biomedical engineers may be called upon to design instruments and devices, to integrate knowledge from many sources in order to develop new procedures, or to pursue research in order to acquire knowledge needed to solve problems. The major culminates in a Major Qualifying Project, which requires that each student apply his or her engineering background to a suitable biomedical problem, generally in association with the University of Massachusetts Medical School, Tufts University School of Veterinary Medicine, one of the local hospitals, or a medical device company.

Each student's program will be developed individually with an advisor to follow the Biomedical Engineering program chart. WPI requirements applicable to all students must also be met. See page 9.

Biomedical engineering is characterized by the following types of activity in the field:

1. Uncovering new knowledge in areas of biological science and medical practice by applying engineering methods;
2. Studying and solving medical and biological problems through analytical techniques in engineering;
3. Designing and developing patient-related instrumentation, biosensors, prostheses, biocompatible materials, and diagnostic and therapeutic devices; and bioengineered tissues and organs;
4. Analyzing, designing, and implementing improved health-care delivery systems and apparatus in order to improve patient care and reduce health-care costs in contexts ranging from individual doctors' offices to advanced clinical diagnostic and therapeutic centers.

The modeling of biological systems is an example of applying engineering analytical techniques to better understand the dynamic function of biological systems. The body has a complex feedback control system with multiple subsystems that interact with each other. The application of modeling, computer simulation, and control theory provides insights into the function of these bodily processes.

Recently, there has been increased emphasis on the application of the biomedical engineering principles embodied in the third and fourth areas listed above. Examples of the third area include:

- designing and developing tissues and organs;
- development of implantable biomaterials;
- design of an implantable power source;
- design of transducers to monitor the heart's performance;
- development of electronic circuitry to control the system;
- bench and field testing of devices in animals;
- application of new technology to patients.

The fourth area involves closer contact with the patient and health-care delivery system. This area is commonly referred to as Clinical Engineering. The engineer in the clinical environment normally has responsibility for the medical instrumentation and equipment including:

- writing procurement specifications in consultation with medical and hospital staff;
- inspecting equipment for safe operation and conformance with specifications;
- training medical personnel in proper use of equipment;
- testing within hospital for electrical safety; and
- adaptation of instrumentation to specific applications.

Biomedical engineering projects are available in WPI's Salisbury and Higgins Laboratories, the Life Sciences and Bioengineering Center at Gateway Park as well as at the affiliated institutions previously listed.

### Program Distribution Requirements for the Biomedical Engineering Major

The normal period of residency at WPI is 16 terms. In addition to the WPI requirements applicable to all students (see page 9), a biomedical engineer needs a solid background in mathematics, physical and life sciences. The distribution requirements are satisfied as follows:

BIOMEDICAL ENGINEERING	MINIMUM UNITS
1. Mathematics (See Note 1)	2
2. Basic Science (See Note 2)	2
3. Supplemental Science (See Note 3)	2/3
4. Laboratory experience with living systems (See Note 4)	1/3
5. Biomedical Engineering and Engineering (See Note 5)	4 1/3
6. MQP (See Note 6)	1

**NOTES:**

1. Mathematics must include differential and integral calculus, differential equations and statistics.
2. Two courses from each of the following areas: BB, CH and PH.
3. Two courses from BB, CH or PH.
4. Experimental Physiology (e.g., BB 3511 and BB 3514) or equivalent.
5. Thirteen courses from Biomedical Engineering (BME) or Engineering (CE, CHE, ECE, ES, or ME) as specified in the WPI Catalog "Courses Qualifying for Engineering Department Areas" with the following distribution: (1) seven courses from Biomedical Engineering or Engineering, one of which must be an engineering design course; (2) four courses from Biomedical Engineering or Engineering at the 3000-level or above; (3) two courses in Biomedical Engineering at the 4000-level or above. A minimum of eight of the thirteen courses must be from Biomedical Engineering, not including BME 3110.
6. Must include 1/3 unit Capstone Design Experience.

**BIOMEDICAL ENGINEERING PROGRAM CHART**

	FRESHMAN/SOPHOMORE	JUNIOR	SENIOR
<b>COURSE RECOMMENDATIONS</b>	<p><b>Mathematics (6 courses)</b>                      MA 1021 (Calculus I)      MA 1024 (Calculus IV)                      MA 1022 (Calculus II)      MA 2051 (Differential Equations)                      MA 1023 (Calculus III)      MA 2611 (Statistics)</p> <p><b>Biology (2 courses)</b>                      BB 2550 (Cell Biology)      BB 3102 (Physiology: Transport and Maintenance)</p> <p><b>Chemistry (2 courses)</b>                      CH 1010 (Molecularity)      CH 1020 (Forces and Bonding)</p> <p><b>Physics (2 courses)</b>                      PH 1110 (Physics I)      PH 1120 (Physics II)</p> <p><b>Supplemental Science (2 courses)</b>                      Pick 2 from BB, CH, or PH                      (See suggested courses from specialization areas listed below)</p> <p><b>Biomedical Engineering (select 3 courses)</b>                      BME 1001 (Intro. to Bio. Med. Eng.)                      BME 2204 (Bioelectric Foundations)                      BME 2504 (Foundations in Biomechanics)                      BME 2604 (Foundations in Biol. Transport)</p> <p><b>H&amp;A Sufficiency (2 Units)</b></p> <p><b>Social Science</b></p> <p><b>Physical Education</b></p>	<p><b>IQP</b></p> <p><b>Biomedical Engineering (2 courses)</b>                      BME 3300 (BME Design)</p>	<p><b>MQP</b></p>
	<p><b>Social Science</b></p> <p><b>Free Electives</b></p> <p><b>Physical Education</b></p> <p>From the biomedical engineering specialization areas listed below, select nine (9) courses from BME or other engineering disciplines (four of these courses must be at the 3000-level or above, and must include two BME courses at the 4000-level or above).</p>		
<b>Note: The total minimum number of BME courses is eight (8)</b>			
<b>DEGREE REQUIREMENTS</b>	H&A Sufficiency (2 units)		
		IQP (1 unit)	
	Math/Science (4 units)		
	Supplemental Science (2/3 Unit)		
			MQP (1 unit)
		Biomedical and other Engineering Topics (13/3 Units)	
		Living Systems Lab (1/3 Unit)	
		Social Science (2/3 Units)	
		Free Electives (2/3 Unit)	
	Physical Education (1/3 Units)		

## BIOMEDICAL ENGINEERING SPECIALIZATIONS

Because BME is such a broad and diverse discipline, it is convenient to subdivide it into a number of different specializations, or tracks. At the undergraduate level, these specializations help to bring focus to course and project planning. At the graduate-level, these specializations are aligned with the research interests of our faculty. Here at WPI, five specializations have been defined: Biomaterials, Biomechanics, Biomedical Imaging, Biomedical Sensors and Instrumentation, and Tissue Engineering. If students are interested in developing an undergraduate program of study in one of these specializations, they should consult the Program of Study in BME sections of the catalog, within their chosen areas of specialization. See the department web site for more details.

### BIOMATERIALS

Biomaterials is a specialization within biomedical engineering that integrates engineering fundamentals in materials science with principles of cell biology, chemistry and physiology to aid in the design and development of materials used in the production of medical devices. When most people first think of biomaterials, implants such as surgical sutures, artificial hips or pacemakers generally comes to mind, but many other aspects are included in this diverse field of study:

- Biomaterials Design – Identify the physiological and engineering criteria that an implantable biomaterial must meet. Select the proper chemical composition to insure that the biomaterial imparts the desired mechanical properties and evokes the appropriate tissue response for the specified application.
- Mechanics of Biomaterials – Characterize the magnitude and nature of the mechanical properties of biomaterials. Predict and measure how the physical/structural properties of a biomaterial determine its mechanical properties.
- Biomaterials-Tissue Interactions – Examine the molecular, cellular and tissue responses to implanted medical devices. Design biomaterials with properties that induce the desired wound healing and tissue remodeling responses from the body.

Biomaterials research and development has improved our health care in many ways including:

- Design and manufacturing of replacements parts for damaged or diseased tissues and organs (e.g., artificial hip joints, kidney dialysis machines)
- Improved wound healing (e.g., sutures, wound dressings)
- Enhanced performance of medical devices (e.g., contact lenses, pacemakers)
- Correct functional abnormalities (e.g., spinal rods)
- Correct cosmetic problems (e.g., reconstructive mammo-plasty, chin augmentation)
- Aid in clinical diagnostics (e.g., probes and catheters)
- Aid in clinical treatments (e.g., cardiac stents, drains and catheters)
- Design biodegradable scaffolds for tissue engineering (e.g., dermal analogs)

### Suggested Course Table and Sequence

#### Supplemental Science (Select two courses)

Select two from the following science courses below:

BB 2901 - Molecular Biology, Microbiology, and Genetics  
 BB 2902 - Enzymes, Proteins, and Purification  
 BB 2903 - Anatomy and Physiology  
 BB 3101 - Human Physiology: Movement and Communication  
 BB 4008 - Cell Culture Theory and Application  
 CH 2310 - Organic Chemistry I  
 CH 4110 - Biochemistry I  
 CH 4550 - Polymer Chemistry (cat. II)

#### Engineering (Select nine courses)

Select three fundamental engineering courses, preferred choices include:

ES 2001 - Introduction to Materials Science  
 ES 2501 - Introduction to Static Systems  
 ES 2502 - Stress Analysis  
 ME 2820 - Materials Processing

Select two 3000-level (or higher) engineering courses, preferred choices include:

ES 3001 - Introduction to Thermodynamics  
 ES 3004 - Fluid Mechanics  
 ME 3023 - Mechanical Behavior and Modeling properties of Engineering Materials  
 ME 3501 - Continuum Mechanics  
 ME 3502 - Advanced Mechanics of Materials  
 ME 4821 - Chemistry, Properties and Processing of Plastics (cat. II)

Select four 3000- and 4000-level BME courses, preferred choices include:  
 [Note #1]

BME/ME 4504 - Biomechanics (cat. II)  
 BME/ME 4606 - Biofluids (cat. II)  
 BME/ME 4814 - Biomaterials  
 BME 4828 - Biomaterials-Tissue Interactions  
 BME/ME 550 - Tissue Engineering (cat. II)  
 BME 595B - Biomaterials in the Design of Medical Devices

Note #1: At least 2 of the BME courses must be at the 4000-level or above. Graduate level courses can substitute for 4000-level courses.

### BIOMECHANICS

Biomechanics is a specialization within biomedical engineering that involves the application of engineering mechanics to the study of biological tissues and physiological systems. When most people first think of biomechanics the way we move or the strength of bones generally comes to mind but many other aspects are included in this diverse field of study including:

- Dynamics – analysis of human movement including walking, running, and throwing.
- Statics – determination of the magnitude and nature of forces in joints, bones, muscles and implanted prostheses, and characterization of the mechanical properties of the tissues in our bodies.
- Fluid mechanics – analysis flow of blood through arteries and air through the lung.

Biomechanics research has improved our understanding of, among other things:

- Design and manufacturing of medical instruments, devices for disabled persons, artificial replacements, and implants.
- Human performance in the workplace and in athletic competition.
- Normal and pathological human and animal locomotion.

- The mechanical properties of hard and soft tissues.
- Neuromuscular control.
- The connection between blood flow and arteriosclerosis.
- Air flow and lung pathology.
- The effects of mechanical loads on cellular mechanics and physiology.
- Morphogenesis, growth, and healing.
- The mechanics of biomaterials.
- Engineering of living replacement tissue (tissue engineering).

### Suggested Course Table and Sequence

#### Supplemental Science (Select two courses)

Select two from the following science courses below:

BB 2901 - Molecular Biology, Microbiology, and Genetics

BB 2902 - Enzymes, Proteins, and Purification

BB 2903 - Anatomy and Physiology

BB 3101 - Human Anatomy & Physiology: Movement and Communication

BB 3102 - Human Anatomy & Physiology: Transport and Maintenance

CH 2310 - Organic Chemistry I

CH 4110 - Biochemistry I

CH 4550 - Polymer Chemistry (Cat. II)

#### Engineering (Select nine courses)

Select three fundamental engineering courses, preferred choices include:

ES 2001 - Introduction to Materials Science [Note #2]

ES 2501 - Introduction to Static Systems

ES 2502 - Stress Analysis [Note #2]

ES 2503 - Introduction to Dynamic Systems

Select two 3000-level (or higher) engineering courses, preferred choices include:

ES 3001 - Introduction to Thermodynamics

ES 3003 - Heat Transfer

ES 3004 - Fluid Mechanics [Note #3]

ES 3011 - Control Systems

ES 3323 - Advanced Computer Aided Design

ME 3023 - Mechanical Behavior and Modeling properties of Engineering Materials

ME 3310 - Kinematics of Mechanisms

ME 3321 - Dynamic Modeling

ME 3501 - Continuum Mechanics (Cat. II) [Note #4]

ME 3502 - Advanced Mechanics of Materials

ME 3506 - Rehabilitation Engineering

ME 4512 - Introduction to Finite Element Method

Select four 3000- and 4000-level BME courses, preferred choices include: [Note #1]

BME/ME 3504 - Experimental Biomechanics

BME/ME 4504 - Biomechanics (Cat. II)

BME/ME 4606 - Biofluids

BME/ME 4814 - Biomaterials

BME/ME 552 - Tissue Mechanics (Cat. II)

BME/ME 550 - Tissue Engineering (Cat. II)

BME/ME 554 - Composites with Biomedical and Materials Applications

Note #1: At least 2 of the BME courses must be at the 4000-level or above. Graduate level courses can substitute for 4000-level courses.

Note #2: These courses should be completed before taking BME 4814.

Note #3: This course should be completed before taking BME 4606.

Note #4: This course should be completed before taking BME 4504 or BME 552.

## BIOMEDICAL IMAGING

Biomedical imaging is a broad specialization within biomedical engineering that involves the application of quantitative science and engineering to detect and visualize biological processes. An important sub-area in biomedical imaging is the application of these tools and knowledge to the study of diseases with an ultimate goal of aiding medical intervention. While x-ray imaging is an obvious and familiar example with tremendous diagnostic utility, it represents only a small aspect of this important field. Biomedical imaging:

- Includes the numerous and diverse imaging technologies that nearly cover the electromagnetic spectrum. Examples include x-ray imaging, visible light (optical) imaging, near-infrared imaging, magnetic resonance imaging, and ultrasound imaging. The detected radiation can be either naturally emitted by the body (such as infrared radiation) or re-emitted radiation (as in magnetic resonance imaging). It also includes technologies that produce images following the introduction of a chemical agent into the body, such as nuclear medicine imaging and luminescence-based imaging.
- Involves the development of sophisticated instrumentation to acquire and process images from the body, most often in a non-invasive or minimally-invasive manner. A biomedical engineer is not simply a user of an imaging technology, but an active participant in the development of new technologies.
- Requires an understanding of how energy interacts with biological tissue and how this interaction is used to produce images of diagnostic utility. This understanding is rooted in the disciplines of physics, chemistry, and biology. A biomedical engineer, therefore, must have a strong background in the physical sciences.
- Involves both image acquisition and image processing. Rarely are the signals acquired by the instrumentation immediately interpretable. For example, image processing is used to create two- and three-dimensional images from the acquired “raw” signals and to extract important image features. An example is computed tomography, which converts a series of through-body x-ray images into a cross-sectional image that reveals internal tissue structures. Image processing is grounded in the disciplines of mathematics and computer science.
- Is capable of generating much more than simple anatomic images. For example, newer biomedical imaging technologies are being used to image and quantify blood flow and metabolic activity in normal and diseased tissue. The development of these “functional” imaging technologies has tremendous potential to substantially advance our understanding of biological and disease processes. Because it is often completely non-invasive, biomedical imaging is already revolutionizing the study of brain function in humans.
- Involves all size scales, from sub-cellular to whole body.
- Is an important component of many other disciplines and specializations, including biology and tissue engineering. Without the technical advances in biomedical imaging, we would often be at the mercy of time-consuming and tedious chemical or histological analyses to probe cellular function and microscopic structures. Non-invasive methods also allow biological processes to be studied over time on the same sample.

## Suggested Course Table and Sequence

### Supplemental Science (Select two courses)

CH 1040 - Chemistry IV (Dynamics)  
 CH 4110 - Biochemistry  
 PH 1140 - Oscillations and Waves  
 PH 2501 - Photonics  
 PH 2601 - Photonics Laboratory

### Engineering (Select nine courses)

*Select three fundamental engineering courses; preferred choices include:*

ECE 2011 - Introduction to Electrical and Computer Engineering  
 ECE 2111 - Physical Principles of ECE Applications  
 ECE 2112 - Electromagnetic Fields  
 ECE 2311 - Continuous-Time Signal and System Analysis  
 ECE 2312 - Discrete-Time Signal and System Analysis

*Select two 3000-level (or higher) engineering courses; preferred choices include:*

ECE 3113 - Introduction to RF Circuit Design  
 ECE 3204 - Microelectronic Circuits II  
 ME 4922 - Theory and Practice of Laser Instrumentation

*Select four 3000- and/or 4000-level BME courses; preferred choices include [Note #1]:*

BME 3011 - Bioinstrumentation and Biosensors  
 BME 4011 - Biomedical Signal Analysis  
 BME 4201 - Biomedical Imaging  
 BME 4541 - Biological Systems  
 BME 581 - Medical Imaging Systems  
 BME 582 - Principles of In Vivo Nuclear Magnetic Resonance Imaging

Note #1: At least 2 of the BME courses must be at the 4000-level or above. Graduate level courses can substitute for 4000-level courses.

## BIOSENSORS AND BIOINSTRUMENTATION

Modern health care relies heavily on a large array of sophisticated medical instrumentation to diagnose health problems, to monitor patient condition and administer therapeutic treatments, most often in a non-invasive or minimally-invasive manner. During the past decade, computers have become an essential part of modern bioinstrumentation, from the micro-processor in a single-purpose instrument used to do a variety of small tasks to the desk-top microcomputer needed to process the large amount of clinical information acquired from patients.

A biomedical engineer is not simply a user of measurement technology, but an active participant in the development of new diagnostic and therapeutic modalities. Hence, the Biosensors and Bioinstrumentation track of our program focuses on training students to design, test, and use sensors and biomedical instrumentation in humans and animals to further enhance the quality of health care. Emphasis is placed both on understanding the physiological systems involved in the generation of the measured variable or affected by therapeutic equipment as well as the engineering principles of new sensors and advanced measurement devices. This track provides an excellent training experience that prepares students for careers in industry, higher education as well as medical school.

Examples of common biomedical sensors, devices, and instrumentation developed by biomedical engineers and used routinely in medicine include:

- Blood chemistry sensors (e.g. electrolytes, O<sub>2</sub>, CO<sub>2</sub>, pH, glucose)
- Specialized instrumentation for genetic testing
- Physical sensors (e.g. pressure, temperature, flow)

- Electrical sensors (electrodes)
- Electrocardiographs (a device that measures the electrical activity of the heart)
- Electroencephalograph (a device that measures the electrical activities of the brain)
- Electromyography (a device that measures the electrical activities of muscles)
- Mechanical respirator
- Cardiac pacemaker
- Defibrillators
- Artificial heart
- Pulse oximeters
- Ultrasonic equipment
- Imaging scanners (nuclear cameras, CAT, MRI)
- Drug infusion and insulin pumps
- Electrosurgical equipment
- Heart-lung machine
- Anesthesia machine
- Kidney dialysis machine
- Specialized equipment used by disabled people (e.g. hearing aids)
- Laser systems for eye surgery

## Suggested Course Table and Sequence

### Supplemental Science (Select two courses)

*Preferred choices include:*

BB 2901 - Molecular Biology, Microbiology, and Genetics  
 BB 2902 - Enzymes, Proteins, and Purification  
 BB 2903 - Anatomy and Physiology  
 BB 3101 - Human Physiology: Movement and Communication  
 PH 1130 - Introduction to 20th Century Physics  
 PH 1140 - Oscillations and Waves  
 PH 2501 - Photonics

### Engineering (Select nine courses)

*Select three fundamental ECE courses; preferred choices include:*

ECE 2011 - Introduction to Electrical and Computer Engineering  
 ECE 2022 - Introduction to Digital Circuits & Computer Engineering

ECE 2111 - Physical Principles of ECE Applications  
 ECE 2201 - Microelectronic Circuits I  
 ECE 2311 - Continuous-Time Signal and System Analysis  
 ECE 2312 - Discrete-Time Signal and System Analysis  
 ECE 2799 - Electrical & Computer Engineering Design

*Select two 3000-level (or higher) engineering courses; preferred choices include:*

ES 3011 - Control Engineering  
 ECE 3204 - Microelectronic Circuits II  
 ECE 3801 - Advanced Logic Design  
 ECE 4703 - Real-Time Digital Signal Processing

*Select four 3000- and/or 4000-level BE courses; preferred choices include [Note #1]:*

BME 3011 - Bioinstrumentation and Biosensors  
 BME 4011 - Biomedical Signal Analysis  
 BME 4023 - Biomedical Instrumentation I  
 BME 4025 - Biomedical Instrumentation II  
 BME 4541 - Biological Systems

Note #1: At least 2 of the BE courses must be at the 4000-level or above. Graduate level courses can substitute for 4000-level courses.

## TISSUE ENGINEERING

Tissue engineering integrates the principles and methods of engineering with the fundamentals of life sciences towards the development of biological substitutes to restore, maintain or improve tissue/organ function. When most people first think of tissue engineering, artificial skin and cartilage generally comes to mind, but many other aspects are included in this diverse field of study:

- Scaffold/Biomaterial Design – Identify the physiological and engineering criteria that a biodegradable scaffold must meet. Select the proper biochemical composition to insure that the cells perform in a physiologic manner on the surface of the scaffold.
- Functional/Biomechanical Tissue Engineering – Characterize the roles of biomechanical stimuli on the growth and development of bioengineered cells, tissues and organs. Measure the biomechanical properties of bioengineered tissues and organs.
- Bioreactor Design – Design reactors that control the rates at which nutrients and growth factors are supplied to bioengineered tissues and organs during growth and development in a laboratory environment.

### Suggested Course Table and Sequence

#### Supplemental Science (Select two courses)

Select two from the following science courses below:

BB 2901 - Molecular Biology, Microbiology, and Genetics  
 BB 2902 - Enzymes, Proteins, and Purification  
 BB 2903 - Anatomy and Physiology  
 BB 3101 - Human Physiology: Movement and Communication  
 BB 4008 - Cell Culture Theory and Application  
 CH 2310 - Organic Chemistry I  
 CH 4110 - Biochemistry I  
 CH 4550 - Polymer Chemistry (cat. II)

#### Engineering (Select nine courses)

Select three fundamental engineering courses, preferred choices include:

ES 2001 - Introduction to Materials Science  
 ES 2501 - Introduction to Static Systems  
 ES 2502 - Stress Analysis  
 ES 2503 - Introduction to Dynamic Systems

Select two 3000-level (or higher) engineering courses, preferred choices include:

ES 3001 - Introduction to Thermodynamics  
 ES 3002 - Mass Transfer  
 ES 3003 - Heat Transfer  
 ES 3004 - Fluid Mechanics  
 ME 3023 - Mechanical Behavior and Modeling properties of Engineering Materials

ME 3502 - Advanced Mechanics of Materials  
 ME 4821 - Chemistry, Properties and Processing of Plastics (cat. II)

Select four 3000- and 4000-level BME courses, preferred choices include:  
 [Note #1]

BME/ME 4606 - Biofluids (cat. II)  
 BME/ME 4814 - Biomaterials  
 BME 4828 - Biomaterials-Tissue Interactions  
 BME/ME 550 - Tissue Engineering (cat. II)  
 BME 595B - Biomaterials in the Design of Medical Devices

Note #1: At least 2 of the BME courses must be at the 4000-level or above. Graduate level courses can substitute for 4000-level courses.

## CHEMICAL ENGINEERING

### D. DIBIASIO, HEAD

PROFESSORS: R. Datta, A. G. Dixon, Y. H. Ma, R. W. Thompson

ASSOCIATE PROFESSORS: T. A. Camesano, W. M. Clark, D. DiBiasio, N. K. Kazantzis

ASSISTANT PROFESSOR: H. Zhou

RESEARCH ASSOCIATE PROFESSOR: I. Fishtik

RESEARCH ASSISTANT PROFESSOR: I. Mardilovich

ADJUNCT ASSISTANT PROFESSORS: H. W. Nowick, T. Starr, S. Kmiotek

### MISSION STATEMENT

The Department of Chemical Engineering at WPI is dedicated to providing excellent education to undergraduate and graduate students in chemical engineering, and to vigorously pursuing discovery, creation, and dissemination of knowledge at the frontiers of chemical engineering. Chemical engineers are uniquely positioned to continue to contribute to the betterment of society through advancements in new materials, biomedicine, alternative energy, transportation, environmental pollution abatement, resource conservation, and sustainable development. The Department aspires to contribute to this vision by achieving national distinction in selected areas of scholarly inquiry and by educating men and women to become leaders in industrial practice, civil service, education, and research. The Department strives to produce technically competent and socially aware chemical engineers through project-based, innovative, and rigorous educational programs that promote global and societal awareness, innovative thinking, and life-long learning skills.

### PROGRAM EDUCATIONAL OBJECTIVES

The Chemical Engineering Department has established the following objectives of the undergraduate program in support of our mission and that of the Institute.

1. To educate students in the fundamental principles of chemical engineering.
2. To help students develop the ability to use chemical engineering principles to solve problems of practical importance to society.
3. To help prepare students, through broad education, for a lifetime of success as productive and informed members of society as well as of their professional community.
4. To help students become effective communicators.

### PROGRAM OUTCOMES

The Chemical Engineering Department has established fifteen educational outcomes in support of our objectives. The outcomes are grouped under the objectives that they support.

#### Objective 1

- 1.1 Chemical engineering graduates will possess a working knowledge of the fundamentals of chemistry, physics, and mathematics, including knowledge of advanced elective science subjects such as organic and inorganic chemistry, material science, and biochemistry, etc.

- 1.2 Chemical engineering graduates will possess a working knowledge of conservation principles and their applications, physical and chemical equilibria, transport and rate processes, separation processes, chemical process control, and reaction engineering.

### Objective 2

- 2.1 Chemical engineering graduates will be able to formulate, analyze, and solve practical chemical engineering problems.
- 2.2 Chemical engineering graduates will be able to design experiments, safely gather and analyze data, and apply the results to address practical chemical engineering problems.
- 2.3 Chemical engineering graduates will be able to use appropriate mathematical concepts and methods to solve chemical engineering problems.
- 2.4 Chemical engineering graduates will be able to design a chemical system, process, or component with consideration of realistic constraints including practical, economic, environmental, safety, ethical, social, and political implications.
- 2.5 Chemical engineering graduates will be able to use computers effectively for solving chemical engineering problems.

### Objective 3

- 3.1 Chemical engineering graduates will be able to function and work effectively alone and in a team environment, including multidisciplinary teams.
- 3.2 Chemical engineering graduates will possess an appreciation of professional, ethical, and contemporary issues, and the societal and global impact of chemical engineering processes.
- 3.3 Chemical engineering graduates will possess self-learning skills to ensure life-long learning.
- 3.4 Chemical engineering graduates will possess an appreciation for the humanities and social sciences.
- 3.5 Chemical engineering graduates will be able to use their chemical engineering education to serve the chemical engineering profession or a related profession or pursue advanced studies.
- 3.6 Chemical engineering graduates will have selected technical elective courses, concentrations, projects, and minors that satisfy their professional interest or career goals.

### Objective 4

- 4.1 Chemical engineering graduates will be able to write coherent, concise, and accurate technical reports.
- 4.2 Chemical engineering graduates will be able to make concise and effective oral presentations.

## Program Distribution Requirements for the Chemical Engineering Major

The normal period of residency at WPI is 16 terms. In addition to the WPI requirements applicable to all students (see page 9), students wishing to receive the ABET-accredited degree designated "Chemical Engineering" must satisfy the distribution requirements shown below.

REQUIREMENTS	MINIMUM UNITS
1. Mathematics and Base Science (Notes 1 and 2)	4
2. Engineering Science and Design (Notes 3 and 4)	6
3. Advanced Chemistry and Natural Science (Note 5)	5/3

### NOTES:

- Must include differential and integral calculus and differential equations.
- Must include 3 courses in chemistry, 2 courses in physics and 1 course in biology or biochemistry.
- Must include 1 unit of MQP, 1/3 unit of capstone design experience (e.g. CHE 4404), and at least 1/3 unit of engineering study outside the major. Courses used to satisfy this requirement must be at the 2000 level or above, with the exception of CHE 1011.
- Must include at least 4 units from the following list of core chemical engineering courses: CHE 2011, CHE 2011, CHE 2013, CHE 2014, ES 3004, ES 3003, ES 3002, CHE 3201, CHE 3501, CHE 4401, CHE 4402, CHE 4403, CHE 4404, CHE 4405.
- Advanced chemistry and natural science courses are defined as any 2000 level and above BB, CH, PH, or GE course and CH 1040. Must include 3 advanced CH courses at 2000 level or above. Up to 2/3 unit of advanced chemistry and natural science may be double counted under requirements 1 and 3.

## CONCENTRATIONS FOR CHEMICAL ENGINEERING MAJORS

Chemical engineering majors may choose to focus their studies by obtaining one of the following Concentrations: Biochemical, Biomedical, Environmental, or Materials.

### CHEMICAL ENGINEERING WITH BIOCHEMICAL CONCENTRATION

#### Basic Science:

Any BB course. No more than one 1000 level course may be counted, however. Recommended courses include:

BB 2002	Microbiology
BB 3055	Microbial Physiology
BB 4008	Cell Culture Theory and Applications
BB 4070	Separation of Biological Molecules
BB 560	Separation of Biological Molecules

#### Engineering Science and Design:

BB 509	Scale-Up of Bioprocessing
CHE 3301	Introduction to Biological Engineering
CHE 521	Biochemical Engineering
BME 1001	Introduction to Biomedical Engineering

#### Advanced Chemistry:

CH 4110	Biochemistry I
CH 4120	Biochemistry II
CH 4130	Biochemistry III
BB 4910	Advanced Molecular Biology

**CHEMICAL ENGINEERING WITH BIOMEDICAL CONCENTRATION**

No more than one 1000-level course may be counted. Recommended courses include:

**Basic Science:**

- (at most, one of these three) {
- BB 1035 Introduction to Biotechnology
  - BB 2550 Cell Biology
  - BB 125X Human Biology
  - BB 3102 Human Anatomy & Physiology: Transport and Maintenance
  - BB 4065 Virology

**Engineering Science and Design:**

- BME 1001 Introduction to Biomedical Engineering
- BME 2604 Foundations in Biological Transport Phenomena
- BME/ME 4504 Biomechanics
- BME/ME 4606 Biofluids
- BME/ME 4814 Biomaterials
- CHE 3301 Introduction to Biological Engineering

**CHEMICAL ENGINEERING WITH ENVIRONMENTAL CONCENTRATION**

**Basic Science:**

- GE 2341 Geology
- BB 2040 Principles of Ecology

**Engineering Science and Design:**

- (at most, one of these three) {
- CHE 3301 Introduction to Biological Engineering
  - CHE 3910 Chemical and Environmental Technology
  - CHE 3920 Air Quality Management
  - CE 3059 Environmental Engineering
  - CE 3070 Introduction to Urban and Environmental Planning
  - CE 3074 Environmental Analysis
  - CE 3060 Water Treatment
  - CE 3061 Wastewater Treatment
  - CE 4060 Environmental Engineering Lab
  - CE 4061 Hydrology

**CHEMICAL ENGINEERING SUGGESTED COURSE SEQUENCE**

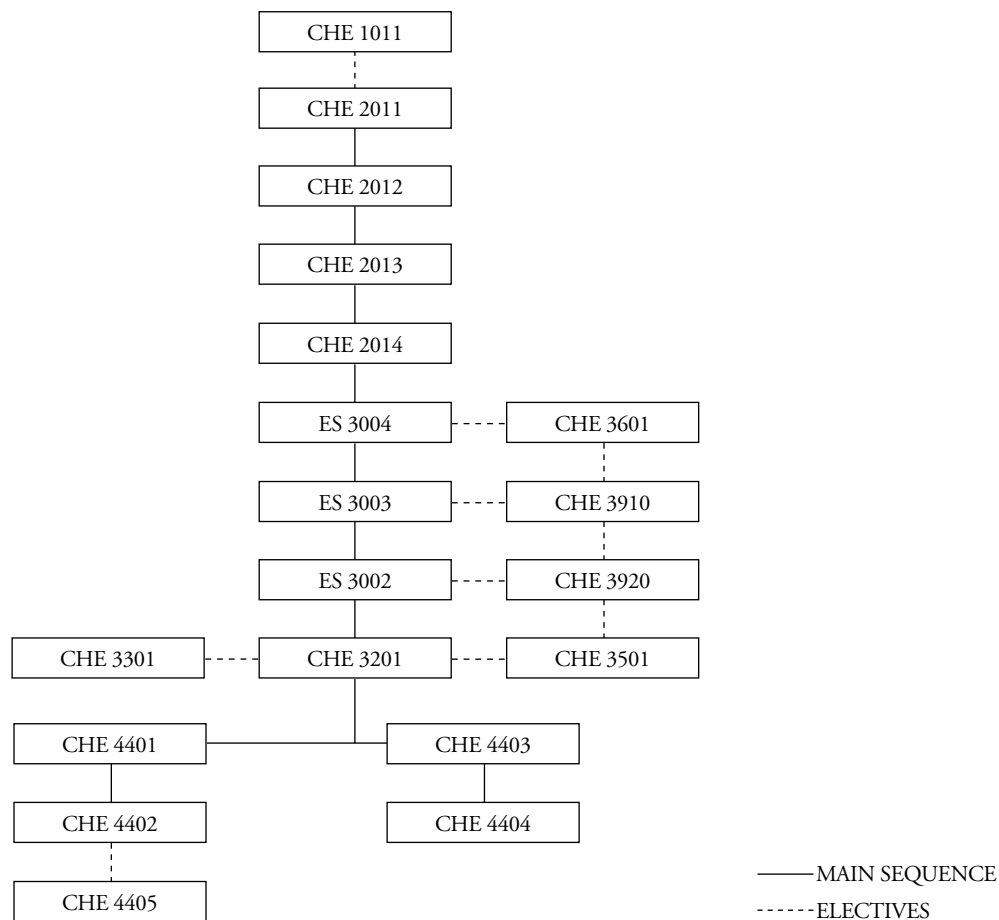



## CHEMICAL ENGINEERING WITH MATERIALS CONCENTRATION

### Engineering Science and Design:

CHE 3601	Chemical Materials Engineering
ES 2001	Introduction to Material Science
CHE 508	Catalysis and Surface Science of Materials
ME 2820	Materials Processing
ME 3801	Experimental Methods in Material Science and Engineering
ME 4813	Ceramics
ME 4814	Biomaterials
ME 4821	Chemistry, Properties, and Processing of Plastics
ME 4840	Physical Metallurgy
ME 48xx	(Materials courses as approved)

### Advanced Chemistry:

CH 4550	Polymer Chemistry
---------	-------------------

## PROJECT OPPORTUNITIES

Projects available to the chemical engineering student are of the widest possible variety. Projects may be of the research type (as would be encountered in graduate school) or of a more developmental, industrial nature. Nonexperimental design projects or theoretical projects are also available. They are available on campus, sometimes with graduate students working on sponsored research; in off-campus governmental laboratories; or in industry, as well as overseas.

Areas of specialization in the department currently are:

Adsorption	Kinetics
Biochemical Engineering	Mass Transfer
Biofilms	Materials Synthesis
Biominiaturization	Microfluidics
Bioremediation	Molecular Modeling
Biosensors	Process Dynamics, Supervision and Control
Biotechnology	Reaction Engineering
Catalysis	Scientific Computing
Diffusion	Separation Processes
Drug Delivery	Thermodynamics
Fuel Cells	Water Remediation
Hydrogen Technology	Zeolites
Inorganic Membranes	

## CHEMISTRY AND BIOCHEMISTRY

### K. N. WOBBE, INTERIM HEAD

PROFESSORS: J.M. Arguello, R.E. Connors, J.P. Dittami, W.G. McGimpsey, A.A. Scala, C. Sotak

ASSOCIATE PROFESSORS: J.C. MacDonald, K.N. Wobbe

ASSISTANT PROFESSORS: V. Thalladi, W. Yu

### MISSION STATEMENT

Through dynamic and innovative classroom instruction and exciting cutting edge research programs, the Department of Chemistry and Biochemistry strives to provide students with both a broad understanding of the fundamentals of the chemical sciences and an opportunity to create new chemical and biochemical knowledge through original research. We aspire to produce graduates who will enter their scientific careers with the confidence and competence to lead the advance of chemistry and biochemistry in the 21st century.

## PROGRAM EDUCATIONAL OBJECTIVES

The Department of Chemistry and Biochemistry will graduate outstanding professionals possessing fundamental knowledge of the chemical sciences. Graduates will be able to apply this knowledge to the solution of problems in chemistry and biochemistry for the advancement of knowledge in these fields and the improvement of the standard of living of all humanity.

## PROGRAM OUTCOMES

Students graduating with a major in Chemistry or Biochemistry will be able to demonstrate an ability to

- perform accurate and precise quantitative measurements
- use and understand modern instruments, particularly NMR, IR, and UV-vis spectrometers, chromatographs, electrochemical instruments, and lab computers
- keep legible and complete experimental records
- analyze data statistically and assess reliability of results
- anticipate, recognize, and respond properly to hazards of chemical manipulations
- interpret experimental results and draw reasonable conclusions
- plan and execute experiments through use of the literature
- design experiments
- communicate effectively through oral and written reports
- critically assess their work for reasonableness and self-consistency
- adhere to high ethical standards
- learn independently

## BIOCHEMISTRY

### Program Distribution Requirements for the Biochemistry Major

In addition to the WPI requirements applicable to all students (see page 9), students wishing to graduate with a degree in biochemistry must meet the distribution requirements detailed below.

REQUIREMENTS	MINIMUM UNITS
1. Mathematics and Physics (Note 1).	2
2. Chemistry and Biochemistry (Note 2).	4
3. Biology (Note 3).	1 2/3
4. Chemistry and Biochemistry/ Biology Laboratory (Note 4).	1
5. Other Natural or Computer Science (Note 5).	1/3
6. MQP	1

### NOTES:

1. The mathematics in MA 1021-MA 1024 or the equivalent is recommended. The physics in PH 1110-PH 1120 or equivalent is recommended.
2. These four units must include one unit of organic, one unit of biochemistry, and 1/3 unit each of physical (3000 level or higher) and inorganic chemistry (3000 level or higher).
3. These 1 2/3 units must include 1/3 unit of cell biology, 1/3 unit of genetics, and 2/3 unit of advanced work (3000 level or higher).
4. This unit must include a minimum of 1/3 unit in Chemistry and Biochemistry, and a minimum of 1/3 unit in Biology.
5. Any course in the natural sciences (not used to satisfy another requirement) or in computer science may be used to satisfy this requirement.

**RECOMMENDATIONS FOR STUDENTS**

A typical Biochemistry curriculum is given below.

Premedical students should take three terms of Physics, as well as one of the Organic Chemistry Laboratories (CH 2360 or CH 2660), by the end of their third year.

BB 1035 is recommended as the initial course for students who need to strengthen their background in biology. Note that a total of one unit designated Elective in the table must be in Biology.

Students should take 1/3 unit of advanced Biology laboratory (BB 3512, 3518, 3519, 3520 are recommended) at their discretion as to the term; however, this should preferably be done before the MQP is commenced.

**Recommended Biochemistry Program**

Year	Term A	Term B	Term C	Term D
<b>First</b>	CH 1010 BB 2550 MA	CH 1020 HU MA	CH 1030 BB 2920 MA	CH 1040 HU MA
<b>Second</b>	CH 3510 CH 2640 HU	CH 2310 SS HU	CH 2320 HU PH	CH 2330 HU PH
<b>Third</b>	CH 4110 BB Lab SS	CH 4120 CH 4150 IQP	CH 4130 CH 3410 IQP	CH 4170 Elective IQP
<b>Fourth</b>	Elective MQP Elective	Elective MQP Elective	CH 4160 MQP Elective	CH 4190 MQP Elective

**ASSOCIATED BIOCHEMISTRY FACULTY**

D. S. Adams (BB), J. Duffy (BB), G. D. J. Phillis (PH),  
S. M. Politz (BB), R. Prusty- Rao (BB), J. Rulfs (BB), E. Ryder (BB),  
P. J. Weathers (BB)

**CHEMISTRY****Program Distribution Requirements for the Chemistry Major**

In addition to the WPI requirements applicable to all students (see page 9), students wishing to graduate with a degree in chemistry must meet the distribution requirements detailed below.

REQUIREMENTS	MINIMUM UNITS
1. Mathematics and Physics (Note 1).	2 1/3
2. Chemistry (Note 2).	4
3. Additional Science/Engineering (Note 3).	3 2/3

**NOTES:**

- Must include differential and integral calculus and at least 2/3 units of physics.
- Must be above the level of general chemistry (2000 level or higher). These 4 units must include courses in experimental chemistry (either 4/3 unit or 3/3 unit), inorganic chemistry (1/3 unit), organic chemistry (3/3 unit), physical chemistry (3/3 unit), and biochemistry (either 1/3 unit or 2/3 unit, depending on the number of experimental chemistry courses taken). At least 2/3 units must be at or higher than the 4000 level.
- Distributed among the MQP, the natural and physical sciences, computer science, mathematics, and engineering (and including general chemistry, CH 1010-1040).

**RECOMMENDATIONS FOR STUDENTS**

Chemistry utilizes many of the concepts of physics and the tools of mathematics. Thus students should acquire a background in these subjects early in their programs. The material addressed in MA 1021 through MA 1024 is recommended for all chemistry majors. Students will also benefit from knowledge of differential equations, as discussed in MA 2051. Physics background should include mechanics, and electricity and magnetism. Either the PH 1110-1120 or the PH 1111-1121 sequence is recommended. Students seeking more depth in physics are advised to pursue PH 1130 and PH 1140.

Students seeking ACS certification (see below) should plan to study calculus through introductory multivariable calculus (MA 1021-1024), differential equations (MA 2051) and linear algebra (MA 2071), and should take a minimum of two courses in physics (for example, PH 1111 and PH 1121).

**AMERICAN CHEMICAL SOCIETY APPROVAL AND CERTIFICATION**

The Department of Chemistry and Biochemistry has an American Chemical Society (ACS) approved program. Thus graduates who complete programs satisfying the ACS recommendations have their degrees certified to the society by the department. Accordingly, students can earn an "ACS-Certified Degree in Chemistry" or an "ACS-Certified Degree in Chemistry with a Biochemistry Option."

ACS-Certified graduates are eligible for immediate membership in the ACS and thus are able to secure the benefits of membership, which include helpful services such as finding employment.

**ACS-CERTIFIED DEGREE IN CHEMISTRY**

The following sequence of courses, recommended to provide fundamental background in chemistry, will result in an ACS-certified degree in chemistry. Specialization in particular areas of interest is best accomplished via additional courses and projects, generally taken in the third and fourth years.

**Recommended CBC Courses for an ACS-Certified Degree in Chemistry**

Year	Term A	Term B	Term C	Term D
<b>First</b>	CH 1010	CH 1020	CH 1030	CH 1040
<b>Second</b>	CH 2640 (lab) CH 3510 (phys)	CH 2650 (lab) CH 2310 (org)	CH 2660 (lab) CH 2320 (org)	CH 2670 (lab) CH 2330 (org)
<b>Third</b>		CH 3550 (phys)	CH 3410 (inorg) CH 3530 (phys)	
<b>Fourth</b>	CH 4110 (bioch)			CH 4420 (inorg)

**ACS-CERTIFIED DEGREE IN CHEMISTRY WITH A BIOCHEMISTRY OPTION**

Students seeking the ACS-Certified Degree with Biochemistry Option must complete the following work in addition to those requirements noted above for an ACS-Certified Degree in Chemistry.

- 1/3 unit of biology which contains cell biology, microbiology or genetics.
- 2/3 unit of biochemistry that has organic chemistry as a prerequisite.
- 1/3 unit of a laboratory in biochemical methods.
- Research in biochemistry culminating in a comprehensive written report is highly recommended.

**CONCENTRATION IN MEDICINAL CHEMISTRY**

Medicinal Chemistry is the application of principles of biology and chemistry to the rational design and synthesis of new drugs for treatment of disease. A medicinal chemist applies knowledge of chemistry, biochemistry and physiology to generate solutions to health-related problems.

A concentration in medicinal chemistry is excellent preparation for students interested in entering health related professions, such as the pharmaceutical industry, upon graduation. Possible employment positions are numerous and expected to increase in the future.

**COURSE REQUIREMENTS**

In order to be eligible to receive the Medicinal Chemistry designation on their transcripts, chemistry majors need to satisfy the following course requirements:

Three biomedically oriented courses selected from the following list must be included in the distribution requirements:

- CH 4110 Biochemistry I
- CH 4120 Biochemistry II
- CH 4130 Biochemistry III
- BB 4910 Advanced Molecular Biology
- BB 4955 Recombinant DNA Principles and Applications

Three courses oriented toward structure, synthesis, or mechanisms selected from the following list must be included in the distribution requirements. (All graduate courses in chemistry are open to undergraduates.)

- CH 4330 Organic Synthesis
- CH 516 Chemical Spectroscopy
- CH 533 Physical Organic Chemistry
- CH 538 Medicinal Chemistry
- CH 554 Molecular Modeling

In addition to the above course requirements, chemistry majors must complete an MQP in the medicinal chemistry area, approved by the Program Coordinator. Examples of available projects are:

- Synthesis of huperzine analogs. New acetylcholinesterase inhibitors for treatment of Alzheimer's.
- Synthesis of opiate analogs.
- Synthesis and testing of compounds that influence transport properties of biological membranes.

**PROJECT ACTIVITY**

A student undertaking a Major Qualifying Project in chemistry and biochemistry chooses a faculty advisor in the department with whom to work. This choice is normally made because the student is interested in the research program directed by the faculty member, and wants to become a part of this activity. The student is given a research problem to work on for a minimum of 20 hours a week for 3 terms. Although most MQP projects in chemistry and biochemistry are individual student efforts, team projects involving up to 3 students are occasionally available, depending on the faculty member concerned. The project culminates in a formal written MQP report and a poster session presentation to the department faculty and students. MQP projects in chemistry and biochemistry require a substantial effort from the student in both the laboratory and writing phases. Many projects result in professional publications and/or presentations at professional meetings. The department offers a

variety of areas of specialization (see AREAS OF SPECIALIZATION IN CHEMISTRY AND BIOCHEMISTRY below) in which Major Qualifying Projects may be carried out.

Some students, particularly those in biochemistry, choose to do their MQPs at off-campus laboratories. Biochemistry projects have recently been completed at the University of Massachusetts Medical Center and Tufts University School of Veterinary Medicine.

**AREAS OF SPECIALIZATION IN CHEMISTRY AND BIOCHEMISTRY**

Computational Chemistry and Molecular Modeling  
Gene Regulation  
Ion Transport  
Materials  
Medicinal Chemistry  
Membrane Proteins  
Molecular Spectroscopy  
Nanoscale Design  
Natural Products Synthesis  
Plant-Virus Biochemistry  
Photochemistry  
Photophysics  
Sensors  
Supramolecular Chemistry

---

**CIVIL AND ENVIRONMENTAL ENGINEERING**

---

**T. EL-KORCHI, INTERIM HEAD**

PROFESSORS: T. El-Korchi, F. L. Hart, J. C. O'Shaughnessy

ASSOCIATE PROFESSORS: L. D. Albano, J. Bergendahl, P. Jayachandran, R. Mallick, P. P. Mathisen, R. Pietroforte, J. Plummer, M. Ray, G. F. Salazar

ASSISTANT PROFESSOR: M. Tao

ADJUNCT FACULTY: J. Hall, L. Malloy

EMERITUS PROFESSORS: F. DeFalco, R. Fitzgerald

**MISSION STATEMENT**

The Civil Engineering program at WPI prepares graduates for careers in civil engineering, emphasizing professional practice, civic contributions, and leadership, sustained by active life-long learning. The curriculum combines project based learning environment with a broad background in the fundamental principles of civil engineering. Students have the flexibility to explore various civil engineering disciplines and career opportunities.

**PROGRAM EDUCATIONAL OBJECTIVES**

1. A graduate should be able to apply the fundamental principles of mathematics, science, and civil engineering to analyze and design a component, process or system.
2. A graduate should have the interpersonal and communication skills, an understanding of ethical responsibility, and a professional attitude necessary for a successful engineering career.
3. A graduate should have the ability to engage in life-long learning.
4. A graduate should have an appreciation for the interrelationships among basic knowledge, technology, and society.

**PROGRAM OUTCOMES**

1. Preparation for engineering practice, including the technical, professional, and ethical components.
2. Preparation for the future changes in civil engineering.
3. A solid understanding of the basic principles of civil engineering
4. An understanding of appropriate scientific concepts, and an ability to apply them to civil engineering.
5. An understanding of the engineering design process and an ability to perform engineering design, which includes the multidisciplinary aspects of the engineering design process, the need for collaboration and communications skills, plus the importance of cost and time management.
6. Demonstration of an ability to set up experiments, gather and analyze data, and apply the data to practical engineering problems.
7. Demonstration of in-depth understanding of at least one specialty within civil engineering.
8. Understanding of options for careers and further education, and the educational preparation necessary to pursue those options.
9. An ability to learn independently.
10. The broad education envisioned by the WPI Plan, and described by the Goal and Mission of WPI.
11. An understanding of civil engineering profession in a societal and global context.

**Program Distribution Requirements for the Civil Engineering Major**

The normal period of undergraduate residency at WPI is 16 terms. In addition to the WPI requirements applicable to all students (see page 9), students wishing to receive the ABET-accredited degree designated "Civil Engineering" must satisfy certain distribution units of study in the areas of mathematics, basic science, and engineering science and design as follows:

REQUIREMENTS	MINIMUM UNITS
1. Mathematics and Basic Science (Notes 1,2).	4
2. Engineering Science and Design (including the MQP) (Note 3,4,5,6).*	6

**NOTES:**

1. Mathematics must include differential and integral calculus, differential equations, and probability and statistics.
2. Must include both chemistry and physics with a minimum of one course in physics and two courses in chemistry.
3. A minimum of 4 units of work must be within the Civil Engineering area. All CE courses including the MQP, ES 2503, and ES 3004 are acceptable within the Civil Engineering area.
4. The curriculum must include at least one engineering science course outside the major discipline area. Courses acceptable to satisfy the requirement of outside-of-discipline course are those taught in other engineering departments. The course must be 2000-level or above and cannot include ES 2501, ES 2502, ES 2503, and ES 3004.
5. All students are required to include an appropriate laboratory experience as part of their overall program. This experience can be met by the completion of two undergraduate CE lab courses, selected from among the following: CE 2020, CE 3024, CE 3026, CE 4046, CE 4054, and CE 4060. Alternately, an appropriate laboratory experience could also be accomplished by a student through careful planning of course, project and laboratory work and approval by petition through the Department Program Review Committee.
6. Must include 1/3 unit of Capstone Design Experience.

**SUBAREAS OF CIVIL ENGINEERING****STRUCTURAL AND GEOTECHNICAL ENGINEERING**

The practice of structural engineering involves the analysis and design of buildings, bridges and other structures which are generally a part of all civil engineering systems. Geotechnical engineering encompasses a broad spectrum of interests including the design, analysis and construction of foundations for buildings and other structures, highway embankments, dams and waste containment facilities. It also considers tunnels, ground water development and engineering in the ocean environment.

An educational program leading to preparation for a career in structural and geotechnical engineering must necessarily include in-depth studies in the basic sciences, mechanics of materials, structural analysis, and design, computer applications, and engineering properties of construction materials. The important courses in this area are CE 2002, CE 3006, CE 3008, CE 3010, CE 3026, CE 3044, CE 4007 and CE 4046. Structures generally are a part of large engineering projects and systems. A valuable component of an engineering education involves the interface with other engineering areas. Knowledge of subject matter contained in CE 3020, CE 3050, CE 3059 and CE 3070 is useful for the structural or geotechnical engineer. Major Qualifying Projects in this field often focus primarily on either structural or geotechnical aspects, although many projects integrate the two areas, in addition to construction project management. Representative recent MQP topics include comparative building design and integration of design and construction.

**ENVIRONMENTAL ENGINEERING**

Environmental engineering is that branch of civil engineering involved with environmental quality control. The practicing environmental engineer is concerned with planning, design, construction, operation and regulation of water quality control systems related to water supply and treatment, and waste water collection and treatment. The environmental engineer is also concerned with solid waste management, public health, radiological health, and air pollution control. The Civil Engineering Department at WPI emphasizes water quality aspects of environmental engineering. Key courses of this subarea are CE 3004, CE 3059, CE 3060, CE 3061, CE 3062, and CE 3074. Further depth in this field can be obtained by taking CE 4060, CE 4061 and other appropriate courses in chemistry, biology and biotechnology, chemical engineering, and fluid mechanics. The student should attempt to obtain some social science background, particularly in economics and possibly in law. Other engineering areas will enhance the environmental component of large projects. Courses such as CE 3010, CE 3020, CE 3050 and CE 3070 will be helpful. Recent MQP topics have focused on multimedia contaminant transport, pollution prevention, water quality issues, biosolids, and environmental impact.

**TRANSPORTATION ENGINEERING**

Transportation engineering is concerned with finding solutions to transportation problems such as designing and constructing safe, stable and durable pavement to carry large volumes of traffic vehicles that will be used in the 21st century. The highway infrastructure system in the US plays an important role

**CIVIL ENGINEERING PROGRAM CHART**

STUDENTS EARNING AN ABET ACCREDITED DEGREE IN CIVIL ENGINEERING MUST COMPLETE A MINIMUM OF 15 UNITS OF STUDY ARRANGED IN ACCORDANCE WITH THE DISTRIBUTION REQUIREMENTS. THIS CHART SUMMARIZES COURSE RECOMMENDATIONS—SEE YOUR ADVISOR TO DEVELOP YOUR PROGRAM SCHEDULE.

MATHEMATICS	SCIENCE †
<b>4 Units Required</b>	
MA1020/1021*	CH 1010
MA 1022*	CH 1020
MA 1023*	CH 1030
MA 1024	PH 1110
MA 2051*	PH 1120
MA 2071	PH 1130
MA 2210	BB 1001
MA 2611*	GE 2341

**NOTES**

Basic math and science courses should be completed early in the curriculum, prior to taking many CE courses. Students may select from other math and science courses in addition to those listed here.

\* Mathematics requirements include differential and integral calculus, differential equations, and probability and statistics.

† Science: Must include both chemistry and physics with a minimum of one course in physics and two courses in chemistry.

<b>ENGINEERING SCIENCE AND DESIGN</b>						
<b>6 Units Minimum Required</b>						
<b>(Minimum 4 Units in the Civil Engineering area as noted in Distribution Requirements)</b>						
Fundamental Courses	CE 1030 (1), CE 2000 (1), CE 2001 (1), CE 2020 (3), ES 3004 (1), CE 3041					
Background Courses	CE 3030, ES 2503 (1), ES 3001 (1,2), ECE 3601 (1,2)					
Area (4,5)	Structural	Geotechnical	Environmental and Hydraulics	Urban and Environmental Planning	Transportation	Construction and Management
Breadth	CE 3010	CE 3041	CE 3059	CE 3070	CE 3050	CE 3020 (1)
Depth	CE 2002 CE 3006 CE 3008 CE 3026 (3) CE 4007 CE 4017	CE 3044 CE 4046 (3) CE 4048	CE 3060 CE 3061 CE 3062 CE 4060 (3) CE 4061	CE 3074 CE 4071	CE 3051 CE 4054 (3)	CE 3021 CE 3022 (1) CE 3023 CE 3024 (3)
MQP	1 Unit Emphasizing Design (in area of choice) Should be completed in senior year and meet capstone design requirement.					

**NOTES**

1. Includes material covered on Fundamentals of Engineering General Exam.
2. Meets the requirement for at least one engineering science course outside of Civil Engineering.
3. Meets the requirement for appropriate laboratory experience (two laboratory courses required).
4. To demonstrate breadth, students must select courses from a minimum of four areas. Courses should also be selected to demonstrate depth in at least one area.
5. Many areas are interrelated. See your advisor for information on depth courses that are related to your area of interest.

**ADDITIONAL DEGREE REQUIREMENTS**  
**4 UNITS REQUIRED**

Social Science	2/3 Units
Humanities and Arts	2 Units (includes Sufficiency)
IQP	1 Unit
Physical Education	1/3 Unit

in the commerce, economic development and security of the nation. These systems are deteriorating at a fast pace because of age, heavy increase in use and loading and deferred maintenance. While the highway infrastructure systems needs to be enhanced and maintained in order to provide the mobility needs of the nation, improvements must also be safe, efficient and environmentally benign.

A comprehensive set of courses is offered for providing both basic and in-depth knowledge in transportation engineering. The principal emphasis of transportation engineering at WPI is on traffic engineering, highway design, highway and roadside safety, principles of drainage and construction materials and pavement management. Students can gain basic understanding from breadth courses and in-depth knowledge about specific topics by taking depth courses. Breadth courses in this area are CE 3050 and CE 3026. Depth courses are CE 3051, and CE 4054.

The transportation engineering sub-area offers a wide range of MQP topics, which involve practical application of design principles in solving real-world problems. Recent MQP topics include structural design of airport pavements, use of non destructive testing in pavement design and evaluation, design of durable asphalt pavement mixtures, a study of parking needs and options on the WPI campus, an analysis of traffic accidents in Worcester, an economic study of the pros and cons of having trees in highway medians and ride quality study.

#### URBAN AND ENVIRONMENTAL PLANNING

The principal emphasis of urban design at WPI is the spatial arrangement of sites, neighborhoods, communities and regions, expressed through comprehensive site and development plans. These show the recommended uses of land such as residential, business, industrial, and recreational. The preservation of open space is also a major concern.

Key courses of this subarea are CE 3070, CE 3074, and CE 4071. Further depth in this field can be obtained by taking CE 4046 and selected graduate courses. An understanding of the other engineering areas will enhance the urban design area. Courses such as CE 3010, CE 3059, CE 2020, and CE 3026 will be helpful. Recent MQP topics include highway route selection, highway environmental impact, design of residential area and design of new towns, and GIS applications to planning.

#### CONSTRUCTION ENGINEERING AND PROJECT MANAGEMENT

The civil engineering program in construction engineering and project management is directed to students whose interests lie in the design engineering process but who are also concerned with the problems in social science, management, business, labor and legal relations, and the interaction of governmental and private interests as they relate to major construction projects.

Because of the multidisciplinary nature of the program, students are encouraged to complete courses in management. Information and control systems are important to construction management, and competence in utilizing computers in these areas is expected. Students are encouraged to work with the profession through projects and other activities. Key courses in the area are CE 3006, CE 3008, CE 3020, CE 3021, CE 3022, CE 3023, CE 3024, and CE 3030. An understanding of other engineering areas will enhance a construction engineering and management program. Courses such as CE 3044, CE 3050, CE 4071, and CE 3059 will be helpful. Typical project topics

include computers in construction, prefabricated buildings, rehabilitative construction strategies, scheduling of construction projects, cost evaluation of construction, and integration of design and construction.

---

### ENVIRONMENTAL CONCENTRATION

---

COORDINATORS: Profs. Bergendahl, Hart, Mathisen, O'Shaughnessy, and Plummer

Civil Engineering majors may choose to focus their studies by obtaining an Environmental concentration. An Environmental concentration in the CEE Department focuses on the planning, design, construction, operation and regulation of water quality control systems related to water supply and waste treatment. Additional areas of focus include hydrology, hydraulics, solid and hazardous waste management, waste minimization, public health and air pollution control.

Students electing to pursue the Environmental concentration follow a general curriculum in Civil Engineering, with emphasis on the environmental engineering sub-area. Such preparation leads to a degree recognized by the professional accrediting organization, ABET (Accreditation Board of Engineering and Technology), and is an excellent start for entry-level professional placement or graduate study in environmental engineering.

The Environmental concentration is earned by completing six courses from the following list (or alternate courses through petition) plus an MQP in the environmental area. Typical MQPs include the analysis and design of innovative wastewater, water and solid waste treatment systems, disinfection processes, water quality monitoring and control system designs, water resources systems and groundwater studies.

CE 3059	Environmental Engineering
CE 3060	Water Treatment
CE 3061	Wastewater Treatment
CE 3062	Hydraulics
CE 3070	Urban and Environmental Planning
CE 3074	Environmental Analysis
CE 4060	Environmental Engineering Laboratory
CE 4061	Hydrology
CE 4071	Land Use Development & Controls
CHE 3201	Kinetics and Reactor Design
CHE 3920	Air Quality Management

---

### MASTER BUILDER PROGRAM

---

The Master Builder program has been designed to educate engineers with technical competency and management proficiency, able to effectively participate and play a leadership role in multi-disciplinary teams within the increasingly complex and demanding architectural/engineering/construction industry. These professionals are prepared to effectively integrate the planning, design construction and management of constructed facilities. They should be able to work for clients such as private developers and public agencies, traditional design, construction and facilities management firms as well as with integrated design-build firms.

#### COMBINED-DEGREE PROGRAM FIVE-YEAR PROGRAM

High school seniors can be admitted to the combined-degree Master Builder Program as freshman, allowing them to complete both a bachelors of science and master of engineering degree in civil and environmental in five years.

**GRADUATE INTERNSHIPS AND CO-OP PROGRAM**

A unique graduate internship program is available, allowing students to gain important clinical experiences in a practical engineering and research environments. Students are able to earn income, alternating work and on-campus classroom and laboratory activities.

**PROJECTS**

A great variety of projects are available to civil and environmental engineering students. Students should select project topics which are related to their subarea of emphasis. Project work is an extremely important part of civil engineering education, and the WPI Plan provides an excellent opportunity to strengthen this aspect of undergraduate education. Project activities are a combination of design, sponsored research, laboratory investigations, field work, and internship activities with governmental agencies and private industry. Students may become involved in project work at an early stage of the education program, and should have some Major Qualifying Project activity either under way or well in mind by the end of the junior year. The objectives of such work should include the development of the student's ability to analyze comprehensive situations, consider alternative solutions, define key problems, pick out major variables, and estimate orders of magnitude for reaching decisions. A major objective is the development of sound judgment and skill, incorporating engineering economics and social factors into problem solving.

Each civil engineering student must complete a capstone design experience which draws on past course work, involves significant engineering design, and relates to the practice of civil engineering. Normally, this will be accomplished as part of the MQP. At the time of registration for the MQP, the project advisor will indicate whether this project will meet the capstone requirement. If not, the advisor will provide an additional 1/3 unit of capstone design (not MQP) work to meet the requirement. Alternatively, another MQP which meets the requirement could be selected.

**CIVIL ENGINEERING AREA CONSULTANTS**

**Structural and Geotechnical Engineering**

- L. Albano
- T. El-Korchi
- P. Jayachandran
- M. Tao

**Environmental Engineering**

- J. Bergendahl
- F. Hart
- P. Mathisen
- J. O'Shaughnessy
- J. Plummer

**Transportation and Urban Planning**

- T. El-Korchi
- R. Mallick
- M. Ray

**Construction Engineering and Management**

- L. Albano
- R. Pietroforte
- G. Salazar

The civil engineering part of the program has requirements, although no unique courses are specifically required to complete the program. Nevertheless, certain courses normally are considered a part of a civil engineering education, unless a strong basis for deviation exists. Consultation with an advisor will help an individual to construct a program that both meets WPI and ABET requirements and also provides a breadth and professional training in areas of interest. To provide guidance in structuring a program, the following courses normally should be considered as a basic expectation for all civil engineering programs:

Course		Category
CE 1030	Fundamentals of Computers and Civil Engineering	I
CE 2000	Analytical Mechanics I	I
CE 2001	Analytical Mechanics II	I
ES 3004	Fluid Mechanics	I
CE 2020	Surveying	I
CE 3041	Soil Mechanics	I

The following courses should be considered as fundamental to most civil engineering programs:

Course		Category
CE 2002	Introduction to Analysis and Design	I
CE 3026	Materials of Construction	I
CE 3030	Fundamentals of Civil Engineering AutoCAD	I

The courses listed below are designed to develop a professional base for more advanced work in the specialty areas, as well as to provide a terminal knowledge for students who wish to select areas of concentration in other disciplines. Student programs should include as many of these courses as possible to provide a breadth of understanding across the major civil engineering disciplines.

Course		Category
CE 3010	Structural Engineering	I
CE 3020	Project Management	I
CE 3059	Environmental Engineering	I
CE 3070	Urban and Environmental Planning	I

A cohesive program should include a selection of courses in the professional areas noted below. The student should incorporate courses in as many areas as practicable to develop a program that has both substance and breadth. Many of the courses have interactive applications in two or more engineering disciplines.

Course		Category
<b>Construction Engineering and Management</b>		
CE 3021	Cost Estimating, Scheduling, and Cost Control	II
CE 3022	Legal Aspects in Design and Construction	II
CE 3023	Architectural Engineering Systems	I
CE 3024	Control Surveying	II
<b>Environmental Engineering</b>		
CE 3060	Water Treatment	I
CE 3061	Waste Water Treatment	I
CE 3062	Hydraulics	I
CE 4060	Environmental Engineering Lab	I
CE 4061	Hydrology	II
<b>Geotechnical Engineering</b>		
CE 3044	Foundation Engineering	II
CE 4046	Experimental Soil Mechanics	II
<b>Structural Engineering</b>		
CE 3006	Design of Steel Structures	I
CE 3008	Design of Reinforced Concrete Structures	I
CE 4007	Matrix Analysis of Structures	I
CE 4017	Prestressed Concrete Design	I

**Transportation and Planning**

CE 3050	Introduction to Transportation Engineering	I
CE 3051	Introduction to Pavement Materials Design and Management	I
CE 3070	Urban and Environmental Planning	I
CE 3074	Environmental Analysis	II
CE 4054	Soil and Bituminous Materials Laboratory	I
CE 4071	Land Use Development and Controls	I

---

## COMPUTER SCIENCE

---

**M. A. GENNERT, HEAD;****D. FINKEL, ASSOCIATE HEAD**

PROFESSORS: D. C. Brown, D. Dougherty, D. Finkel, M. Hofri, R. E. Kinicki, C. Rich, E. A. Rundensteiner, S. M. Selkow, M. O. Ward

ASSOCIATE PROFESSORS: M. Claypool, K. Fisler, M. A. Gennert, G. T. Heineman, K. A. Lemone, C. Ruiz, C. E. Wills

ASSISTANT PROFESSORS: E. Agu, N. Heffernan, R. Lindeman, M. Mani

PROFESSOR OF PRACTICE: M. Ciaraldi, G. F. Pollice

AFFILIATED ASSOCIATE PROFESSOR: G. N. Sarkozy

INSTRUCTOR: G. Hamel

**MISSION STATEMENT**

The mission of the Computer Science Department at WPI is to provide outstanding education to its undergraduate and graduate students in accordance with the principles of the WPI mission, to advance scholarship in key domains of the computing sciences, and to engage in activities that improve the welfare of society and enhance the reputation of WPI. The Department aims to maintain an environment that promotes innovative thinking; values mutual respect and diversity; encourages and supports scholarship; instills ethical behavior; and engenders life-long learning.

**PROGRAM EDUCATIONAL OBJECTIVES**

The objectives established by the WPI Computer Science Program in support of its goals and mission are to graduate students with a Computer Science major who:

1. Are prepared technically for computer science and software engineering practice.
2. Understand the basic principles of computer science and software engineering.
3. Understand appropriate mathematical concepts and are able to apply them to computational problems.
4. Have knowledge of computer hardware and architecture.
5. Understand and follow the software engineering process.
6. Are prepared to design and implement software systems.
7. Are prepared to analyze and evaluate software systems.
8. Understand fundamental scientific principles and the scientific method.
9. Can function effectively in diverse teams and situations.
10. Can communicate effectively in speech and in writing.
11. Are able to learn independently and find relevant resources.

12. Are prepared for future changes in computer science and software engineering.
13. Are prepared to uphold professional and ethical standards.
14. Understand and appreciate the role of computer science and software engineering in a societal context.
15. Are aware of career and further educational opportunities.
16. Have a mature understanding of themselves and others.

**PROGRAM OUTCOMES**

Based on the above objectives, the specific outcomes to be achieved for the WPI Computer Science major are that:

1. All students will demonstrate an understanding of programming language concepts.
2. All students will demonstrate knowledge of computer organization.
3. All students will demonstrate an ability to analyze the behavior of computational systems.
4. All students will demonstrate knowledge of computer operating systems.
5. All students will demonstrate an understanding of the foundations of computer science.
6. Almost all students will demonstrate an understanding of software engineering principles and the ability to apply them to software design.
7. A majority of students will demonstrate an understanding of human-computer interaction.
8. All students will complete a large-scale software project.
9. All students will demonstrate advanced knowledge of computer science topics.
10. All students will demonstrate an understanding of the mathematical foundations of computer science.
11. All students will demonstrate knowledge of probability or statistics.
12. All students will demonstrate an understanding of scientific principles.
13. A majority of students will demonstrate the ability to design experiments and interpret experimental data.
14. All students will demonstrate independent learning.
15. All students will demonstrate the ability to locate and use technical information from multiple sources.
16. All students will demonstrate an understanding of professional ethics.
17. All students will demonstrate an understanding of the links between technology and society.
18. A majority of students will belong to at least one professional organization, including IEEE, ACM, and UPE.
19. All students will participate in a class or project team.
20. Almost all students will demonstrate the ability to communicate effectively in speech.
21. All students will demonstrate the ability to communicate effectively in writing.



## Program Distribution Requirements for the Computer Science Major

The normal period of residency at WPI is 16 terms. In addition to the WPI requirements applicable to all students (see page 9) mathematics, basic science, and related fields as follows

COMPUTER SCIENCE	MINIMUM UNITS
1. Computer Science (including the MQP) (Notes 1, 2).	6
2. Mathematics (Notes 2, 3, 5).	7/3
3. Basic Science and/or Engineering Science (Notes 2, 4).	5/3

### NOTES:

1. a. Only CS 1101, CS 1102 and computer science courses at the 2000-level or higher will count towards the computer science requirement. CS 2118 will not count towards the computer science requirement.
- b. Must include at least 1/3 unit from each of the following areas: Systems (CS 3013, CS 4513, CS 4514, CS 4515), Theory and Languages (CS 3133, CS 4120, CS 4123, CS 4533, CS 4536), Design (CS 3041, CS 3431, CS 3733, CS 4233), and Social Implications of Computing (CS 3043, STS 2208, GOV/ID 2314). (If STS 2208 or GOV/ID 2314 is used to satisfy this requirement, it does not count as part of the 6 units of CS.)

- c. At least 5/3 units of the Computer Science requirement must consist of 4000-level courses. These units can also be met by WPI graduate CS courses, with the exception of CS 501 and CS 507.
- d. Only one of CS 1101 and CS 1102 may count towards the computer science requirement. Only one of CS 2301 and CS 2303 may count towards the computer science requirement.
2. A cross-listed course may be counted toward only one of areas 1, 2, 3, above.
3. Must include at least 1/3 unit from each of the following areas: Probability (MA 2621, MA 2631) and Statistics (MA 2611, MA 2612).
4. Courses satisfying the science requirement must come from the BB, BME, CE, CH, CHE, ECE, ES, GE, ME, PH disciplines. At least three courses must come from BB, CH, GE, PH, where at least two courses are from one of these disciplines.
5. At most four 1000-level Mathematics courses may be counted towards this requirement.

The Computer Science Department offers a second program not accredited by the Computing Accreditation Commission of ABET and not bearing the title "Computer Science." The distribution requirements for that program are:

## COMPUTER SCIENCE PROGRAM CHART

<b>COMPUTER SCIENCE</b> Minimum 18/3 <table border="1" style="margin: 5px auto; width: 80%;"> <thead> <tr> <th style="text-align: center;">CORE COURSES</th> </tr> </thead> <tbody> <tr> <td style="text-align: center;">CS 1101 or CS 1102, CS 2011, CS 2022, CS 2102, CS 2223, CS 2303, CS 3013, CS 3041, CS 3043, CS 3133, CS 3733</td> </tr> <tr> <th style="text-align: center;">SYSTEMS—Minimum 1/3</th> </tr> <tr> <td style="text-align: center;">CS 3013, CS 4513, CS 4514, CS 4515</td> </tr> <tr> <th style="text-align: center;">THEORY AND LANGUAGE—Minimum 1/3</th> </tr> <tr> <td style="text-align: center;">CS 3133, CS 4120, CS 4123, CS 4533, CS 4536</td> </tr> <tr> <th style="text-align: center;">DESIGN—Minimum 1/3</th> </tr> <tr> <td style="text-align: center;">CS 3041, CS 3431, CS 3733, CS 4233</td> </tr> <tr> <th style="text-align: center;">SOCIAL IMPLICATIONS—Minimum 1/3</th> </tr> <tr> <td style="text-align: center;">CS 3043, STS 2208, GOV/ID 2314 STS 2208, GOV/ID 2314 do not count toward the 18/3 CS units</td> </tr> <tr> <th style="text-align: center;">ADVANCED LEVEL COURSES—Minimum 5/3</th> </tr> <tr> <td style="text-align: center;"><b>COMPUTER SCIENCE MQP—Minimum 3/3</b></td> </tr> </tbody> </table>	CORE COURSES	CS 1101 or CS 1102, CS 2011, CS 2022, CS 2102, CS 2223, CS 2303, CS 3013, CS 3041, CS 3043, CS 3133, CS 3733	SYSTEMS—Minimum 1/3	CS 3013, CS 4513, CS 4514, CS 4515	THEORY AND LANGUAGE—Minimum 1/3	CS 3133, CS 4120, CS 4123, CS 4533, CS 4536	DESIGN—Minimum 1/3	CS 3041, CS 3431, CS 3733, CS 4233	SOCIAL IMPLICATIONS—Minimum 1/3	CS 3043, STS 2208, GOV/ID 2314 STS 2208, GOV/ID 2314 do not count toward the 18/3 CS units	ADVANCED LEVEL COURSES—Minimum 5/3	<b>COMPUTER SCIENCE MQP—Minimum 3/3</b>
CORE COURSES												
CS 1101 or CS 1102, CS 2011, CS 2022, CS 2102, CS 2223, CS 2303, CS 3013, CS 3041, CS 3043, CS 3133, CS 3733												
SYSTEMS—Minimum 1/3												
CS 3013, CS 4513, CS 4514, CS 4515												
THEORY AND LANGUAGE—Minimum 1/3												
CS 3133, CS 4120, CS 4123, CS 4533, CS 4536												
DESIGN—Minimum 1/3												
CS 3041, CS 3431, CS 3733, CS 4233												
SOCIAL IMPLICATIONS—Minimum 1/3												
CS 3043, STS 2208, GOV/ID 2314 STS 2208, GOV/ID 2314 do not count toward the 18/3 CS units												
ADVANCED LEVEL COURSES—Minimum 5/3												
<b>COMPUTER SCIENCE MQP—Minimum 3/3</b>												
<b>SCIENCE</b> Minimum 5/3 Any BB, BME, CE, CH, CHE, ECE, ES, GE, ME, PH courses. At least three courses must come from BB, CH, GE, PH, where at least two courses are from one of these disciplines.												
<b>MATHEMATICS</b> Minimum 7/3 At most four 1000-level Mathematics courses. May include CS 2022, CS 4032 or CS 4033 if not used to satisfy the CS requirements. <table border="1" style="margin: 5px auto; width: 80%;"> <tbody> <tr> <th style="text-align: center;">STATISTICS—Minimum 1/3</th> </tr> <tr> <td style="text-align: center;">MA 2611, MA 2612</td> </tr> <tr> <th style="text-align: center;">PROBABILITY—Minimum 1/3</th> </tr> <tr> <td style="text-align: center;">MA 2621, MA 2631</td> </tr> </tbody> </table>	STATISTICS—Minimum 1/3	MA 2611, MA 2612	PROBABILITY—Minimum 1/3	MA 2621, MA 2631								
STATISTICS—Minimum 1/3												
MA 2611, MA 2612												
PROBABILITY—Minimum 1/3												
MA 2621, MA 2631												

COMPUTER SCIENCE COURSE FLOW CHART

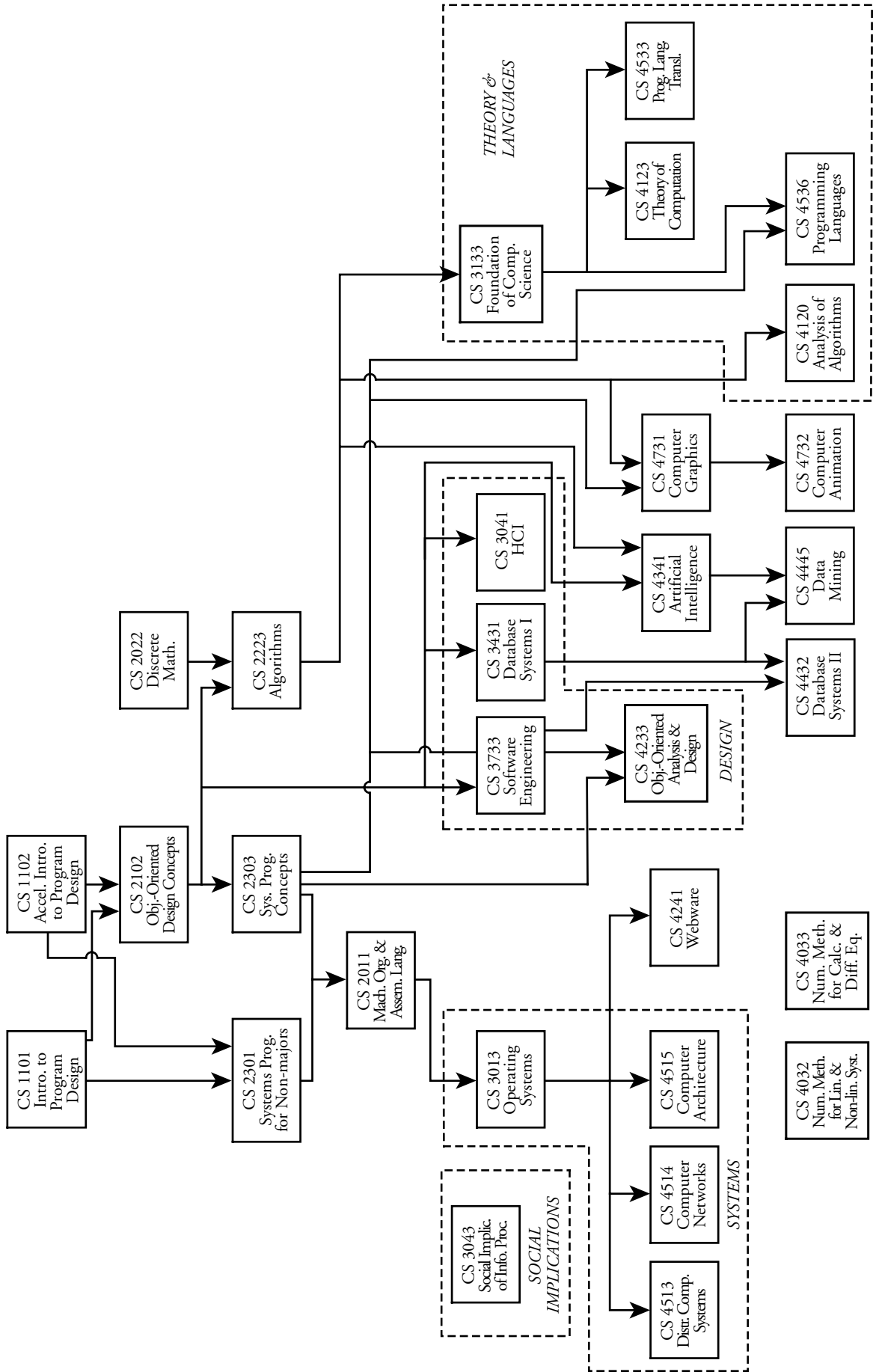

## Program Distribution Requirements for the Computers with Applications Major

COMPUTERS WITH APPLICATIONS	MINIMUM UNITS
1. Computer Science (including the MQP) (Notes 1, 2).	16/3
2. Mathematics (Note 2).	7/3
3. Basic Science (Notes 2, 3).	2/3
4. Application Area (Notes 2, 4).	5/3

### NOTES:

1. a. Only CS 1101, CS 1102 and computer science courses at the 2000-level or higher will count towards the computer science requirement. CS 2118 will not count towards the computer science requirement.
- b. Must include at least 1/3 unit from each of the following areas: Systems (CS 3013, CS 4513, CS 4514, CS 4515), Theory and Languages (CS 3133, CS 4120, CS 4123, CS 4533, CS 4536), Design (CS 3041, CS 3431, CS 3733, CS 4233), and Social Implications of Computing (CS 3043, STS 2208, GOV/ID 2314). (If STS 2208 or GIV/ID 2314 is used to satisfy this requirement, it does not count as part of the 16/3 units of CS.)
- c. At least 5/3 units of the Computer Science requirement must consist of 4000-level courses. These units can also be met by WPI graduate CS courses, with the exception of CS 501 and CS 507.
- d. The MQP must involve the application of computer science concepts to the Application Area specified in Requirement 4.
- e. Only one of CS 1101 and CS 1102 may count towards the computer science requirement. Only one of CS 2301 and CS 2303 may count towards the computer science requirement.
2. A cross-listed course may be counted toward only one of areas 1, 2, 3, 4 above.
3. The two courses satisfying the science requirement must both come from one of the following disciplines: BB, CH, GE, PH.
4. This requirement is satisfied by a cohesive set of work from disciplines other than Computer Science. Work used for any other degree requirements cannot be used for the Application Area. At least 3/3 units must be course work at the 3000 level or higher. Independent Study/Project (ISP) work, if any, must be conducted under the supervision of a member of the faculty in that discipline.

### ADDITIONAL ADVICE

For additional advice about course selections, students should consult with their academic advisor or the Computer Science Department Web site (<http://www.cs.wpi.edu/Undergraduate/>)

### INDEPENDENT STUDY

Independent study and project work provide the opportunity for students, working under the direction of faculty members, to study or conduct research in an area not covered in courses, or in which the students require a greater depth of knowledge. The background required of a student for independent study work depends on the particular area of study or research.

### PROJECT OPPORTUNITIES

Off-campus major qualifying projects are available at the Budapest Project Center, The Lincoln Laboratory Project Center, the Silicon Valley Project Center, the Sun Microsystems Project Center, , and the Wall Street Project Center.

Projects are also available on campus, both to support the ongoing research activities of the faculty, and to expand and improve the applications of computers for service, education, and administration.

Additionally, the department supports IQPs in a number of areas including assistance with, and development of, computer science education at neighboring area schools.

## COMPUTER SCIENCE MINOR

The Minor in Computer Science will consist of 2 units from Computer Science, with no more than one course at the 1000-level. The 2 units must conclude with one of the following, each of which provides an integrating capstone experience:

CS 3013	Operating Systems
CS 3041	Human-Computer Interaction
CS 3133	Foundations of Computer Science
CS 3431	Database Systems I
CS 3733	Software Engineering
CS 4120	Analysis of Algorithms
CS 4123	Theory of Computation
CS 4233	Object-Oriented Analysis and Design
CS 4241	Webware: Computational Technology for Network Systems
CS 4341	Introduction to Artificial Intelligence
CS 4432	Database Systems II
CS 4445	Data Mining
CS 4513	Distributed Computing Systems
CS 4514	Computer Networks: Architecture and Implementation
CS 4515	Computer Architecture
CS 4533	Techniques of Programming Language Translation
CS 4536	Programming Languages
CS 4731	Computer Graphics
CS 4732	Computer Animation

- any graduate-level CS course, except for CS501, CS505, CS507, CS552, or CS590
- 1/3 unit of another activity, for example an ISP, which is validated by a CS faculty member as a capstone.

Students interested in initiating work on a minor in CS are encouraged to ask the Computer Science Department to identify a faculty member to assist the student in structuring a minor. Prior to the initiation of a capstone experience students must inform the offering professor of their intent to use the experience as a capstone.

Majors in Computer Science and Computers with Applications do not qualify for a Minor in Computer Science.

ECE majors and Management Information Science majors should review the Operational Rules of the Minor at WPI to avoid problems with double counting CS courses. For general policy on the Minor, see the description on page 12.

# ELECTRICAL AND COMPUTER ENGINEERING

## F. J. LOOFT, HEAD; H. HAKIM, ASSOCIATE HEAD

PROFESSORS: D. Cyganski, A. E. Emanuel, F. J. Looft, R. Ludwig, J. A. Orr, K. Pahlavan, P. C. Pedersen

ASSOCIATE PROFESSORS: D. R. Brown, E. A. Clancy, R. J. Duckworth, H. Hakim, S. Makarov, J. A. McNeill, W. R. Michalson, B. Sunar, R. F. Vaz

ASSISTANT PROFESSORS: X. Huang, A. Klein, W. Lou, A. Wyglinski

PROFESSOR OF PRACTICE: R. Labonte

AFFILIATE PROFESSOR: R. H. Campbell

INSTRUCTORS: S. J. Bitar, S. M. Jarvis, J. Matthews

EMERITUS PROFESSORS: K. A. Clements, J. S. Demetry, W. H. Eggimann, W. R. Grogan, O. W. Kennedy, H. P. D. Lanyon, A. K. McCurdy, G. H. Owyang, G. E. Stannard

## MISSION STATEMENT

To be prepared for employment as a contributing engineer and/or for graduate-level education, students within the ECE Department receive instruction that is balanced between theory and practice. In fact, much of our curriculum integrates theory and practice within each course. It is common to study new devices and techniques, and then immediately work with these devices/techniques in a laboratory setting. In response to the breadth of ECE, all students work with their academic advisor to develop a broad-based program of study. As with most engineering curricula, ECE study includes a solid foundation of mathematics and science. Discipline-specific study in ECE usually begins early in a student's career — during the second half of the freshman year — with courses providing a broad overview of the entire field. During the sophomore and junior years, students learn the core analysis, design and laboratory skills necessary to a broad range of ECE sub-disciplines. When desired, specialization within ECE occurs during the junior and senior years. In addition, all students complete a major qualifying project (MQP). This project, typically completed in teams during the senior year, is an individualized design or research project that draws from much of the prior instruction. Utilizing the benefit of individualized instruction from one or more faculty members, students develop, implement and document the solution to a real engineering problem. Many of these projects are sponsored by industry, or are associated with ongoing faculty research. These projects form a unique bridge to the engineering profession.

## PROGRAM EDUCATIONAL OBJECTIVES

The department educates future leaders of the electrical and computer engineering profession, with a program characterized by curricular flexibility, student project work, and active involvement of students in their learning. Through a balanced, integrated curriculum we provide an education which is strong both in the fundamentals and in state-of-the-art knowledge, appropriate for immediate professional practice as well as graduate study and lifelong learning. Such an education also prepares students broadly for their professional and personal lives, providing the basis for effective leadership and informed citizenship. The curriculum embraces WPI's philosophy of

education, and takes advantage of key components such as the Interactive Qualifying Project to develop technical professionals who possess the ability to communicate, work in teams, and understand the broad implications of their work.

## PROGRAM OUTCOMES

Based on the department's educational objectives, students will achieve the following specific educational outcomes within a challenging and supportive environment:

1. Preparation for engineering practice, including the technical, professional, and ethical components
2. Preparation for future changes in electrical and computer engineering
3. A solid understanding of the basic principles of electrical engineering, computer engineering, and the relationship between hardware and software
4. An understanding of appropriate mathematical concepts, and an ability to apply them to ECE
5. An understanding of the engineering design process, and ability to perform engineering design, including the needed teamwork and communications skills.
6. Demonstration of in-depth understanding of at least one specialty within ECE
7. An ability to communicate effectively in written and oral form
8. An understanding of options for careers and further education, and the necessary educational preparation to pursue those options
9. An ability to learn independently
10. The broad education envisioned by the WPI Plan, and described by the Goal and Mission of WPI
11. An understanding of engineering and technology in a societal and global context.

## Program Distribution Requirements for the Electrical and Computer Engineering Major

The normal period of residency at WPI is 16 terms. In addition to WPI requirements applicable to all students, students wishing to receive the major designated "Electrical and Computer Engineering" must satisfy certain distribution requirements. These requirements apply to 10 units of study in the areas of mathematics, basic science, and engineering science and design as follows:

REQUIREMENTS	MINIMUM UNITS
1. Mathematics and Basic Science (Notes 1a-1d)	4
2. Engineering Science and Design (ES/D) (including the MQP) (Notes 2a-2g)	6

### NOTES:

1. Mathematics and Basic Science:
  - a. Must include at least 7/3 units of math (prefix MA). Mathematics must include differential and integral calculus, differential equations, discrete mathematics, and probability and/or statistics.
  - b. Must include at least 2/3 units of physics (prefix PH).
  - c. Must include at least 1/3 units of chemistry (prefix CH) or 1/3 units biology (prefix BB).
  - d. Must include an additional 2/3 units of math or basic science (prefixes MA, PH, CH, BB, or GE).

2. Engineering Science and Design (including the MQP):
- Must include at least 5 units within the Electrical and Computer Engineering area (including the MQP). All courses with prefix ECE (except ECE 3601) and ES 3011 are applicable to these 5 units.
  - The 5 units within the Electrical and Computer Engineering area must include at least 1 unit of courses from these approved Electrical Engineering courses: ECE 2112, 2201, 2204, 2312, 3011, 3113, 3204, 3305, 3308, 3311, 3501, 3503, 4011, 4023, 4201, 4304, 4703, 4902, 4904, and ES 3011.
  - The 5 units within the Electrical and Computer Engineering area must include at least 2/3 unit of courses from these approved Computer Engineering courses: ECE 2801, 3801, 3803, 3810 and 4801.
  - The 5 units within the Electrical and Computer Engineering area must include 1/3 unit of Capstone Design Experience. (This requirement is typically fulfilled by the MQP)
  - Must include at least 1/3 unit of computer science (prefix CS), at the 2000 level or above (other than CS 2011, CS 2022, CS 3043 which cannot be applied to this requirement).
  - Must include at least 1/3 unit of engineering science (prefix ES) at the 2000 level or above. ES 3011 cannot be applied to this requirement.
  - Must include an additional 1/3 unit of engineering science and design at the 2000 level or above, selected from courses having the prefix BME, CE, CHE, CS (other than CS 2011, CS 2022, CS 3043), ECE (other than ECE 3601), ES, FP, ME, or RBE.

### SUBDISCIPLINES WITHIN ECE

Given a solid foundation, the MQP will allow you to demonstrate an in-depth understanding of one or more of the subdisciplines that compose the field of electrical and computer engineering. As a guide to the areas of study that can be investigated in an MQP, the ECE Course Flowchart identifies eight subdisciplines as possible areas for in-depth study leading to an MQP. Note that students should not feel constrained by these area designations — this is only one of many possible ways to organize the diverse field of electrical and computer engineering. Many if not most MQPs will incorporate subject matter from several different subdisciplines. The purpose of this list is to guide students interested in a particular area to coursework within a subdiscipline (Area Courses), relevant courses to choose from outside the subdiscipline (Related Courses), and faculty whose research and MQP advising interests fall within the subdiscipline (Area Consultants).

#### Robotics

Area Consultants: Cyganski, Duckworth, Looft, Michalson

##### Area Courses

ECE 2022	Introduction to Digital Circuits and Computers
ECE 2801	Foundations of Embedded Computer Systems
ES 3011	Control Engineering I
ECE 3803	Microprocessor System Design

##### Related Courses

ECE 2201	Microelectronics I
ECE 3305	Aerospace Avionics Systems
ECE 3503	Power Electronics
CS 4341	Artificial Intelligence
RBE 1001	Introduction to Robotics
RBE 2001	Unified Robotics I
RBE 2002	Unified Robotics II
RBE 3001	Unified Robotics III
RBE 3002	Unified Robotics IV

#### Power Systems Engineering

Area Consultants: Emanuel, Hakim

##### Area Courses

ECE 3501	Electrical Energy Conversion
ECE 3503	Power Electronics

##### Related Courses

ES 3001	Introduction to Thermodynamics
ES 3011	Control Engineering I
OIE 2850	Engineering Economics
ME 1800	Materials Selection and Manufacturing Processes

#### RF Circuits and Microwaves

Area Consultants: Ludwig, Makarov

##### Area Courses

ECE 2112	Electromagnetic Fields
ECE 3113	RF Circuit Design

##### Related Courses

MA 4451	Boundary Value Problems
PH 3301	Electromagnetic Theory
PH 3401	Quantum Mechanics I
PH 3504	Optics

#### Aerospace

Area Consultants: Labonte, Michalson

##### Area Courses

ECE 3305	Aerospace Avionics Systems
ES 3011	Control Engineering I

##### Related Courses

ECE 2312	Discrete-Time Signal and System Analysis
ECE 3204	Microelectronics II
ECE 3311	Principles of Communication Systems
ECE 3503	Power Electronics
ECE 3801	Advanced Logic Design
ECE 3803	Microprocessor System Design
ECE 4304	Digital Communication Systems

#### Communications and Signal Analysis

Area Consultants: Brown, Clancy, Cyganski, Hakim, Klein, Makarov, Pahlavan, Pedersen, Wyglinski

##### Area Courses

ECE 2312	Discrete-Time Signal and System Analysis
ECE 3308	Introduction to Wireless Networks
ECE 3311	Principles of Communication Systems
ECE 4304	Digital Communication Systems
ECE 4703	Real-Time Digital Signal Processing

##### Related Courses

ES 3011	Control Engineering I
MA 2071	Matrices and Linear Algebra I
MA 2621	Probability for Applications
MA 4291	Applicable Complex Variables

#### Biomedical Engineering

Area Consultants: Clancy, Pedersen

##### Area Courses

ECE/BME 2204	Bioelectric Foundations
ECE/BME 3011	Bioinstrumentation and Biosensors
ECE/BME 4011	Biomedical Signal Analysis
ECE/BME 4023	Biomedical Instrumentation Design I
ECE/BME 4201	Biomedical Imaging

##### Related Courses

ECE 2312	Discrete-Time Signal and System Analysis
----------	--

**ELECTRICAL AND COMPUTER ENGINEERING COURSE FLOW CHART**

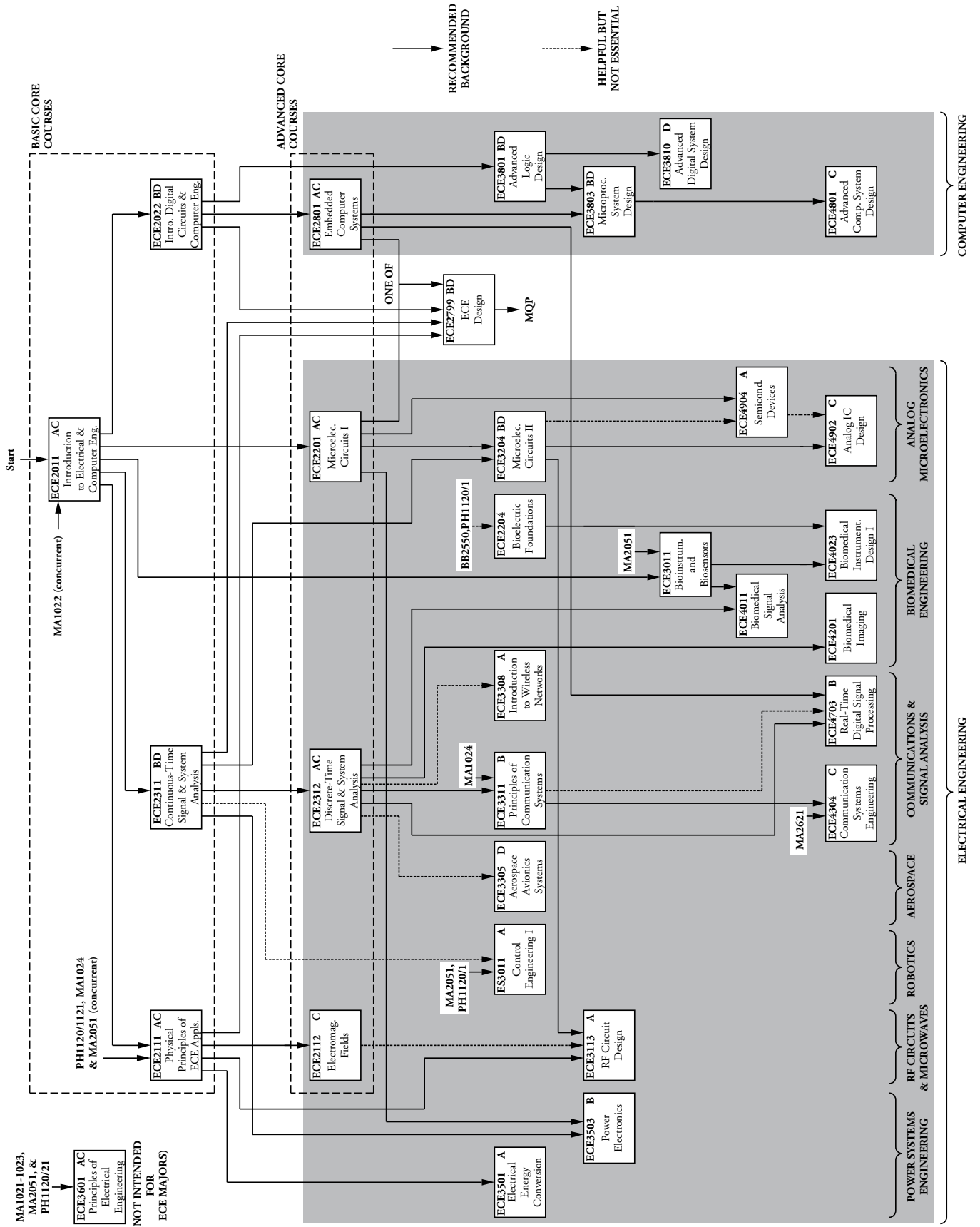

**Analog Microelectronics**

Area Consultants: Bitar, Labonte, McNeill

**Area Courses**

ECE 2201	Microelectronics I
ECE 3204	Microelectronics II
ECE 4902	Analog Integrated Circuit Design
ECE 4904	Semiconductor Devices

**Related Courses**

ES 3011	Control Engineering I
ECE 3801	Advanced Logic Design

**Computer Engineering**

Area Consultants: Clancy, Cyganski, Duckworth, Hakim, Huang, Jarvis, Looft, Lou, Michalson

**Area Courses**

ECE 2801	Foundations of Embedded Computer Systems
ECE 3801	Advanced Logic Design
ECE 3803	Microprocessor System Design
ECE 3810	Advanced Digital System Design
ECE 4801	Advanced Computer System Design

**Related Courses**

ECE 2201	Microelectronics I
CS 2223	Algorithms
CS 3013	Operating Systems
CS 3733	Software Engineering
CS 4515	Computer Architecture
CS 4536	Programming Languages

---

## OVERVIEW OF OTHER PROGRAM COMPONENTS

---

**ENGINEERING SCIENCE AND DESIGN**

Because modern engineering practice is increasingly interdisciplinary, all students achieve some breadth of study outside of the ECE department by taking a minimum of one Computer Science and one Engineering Science course. Both courses must be at the 2000-level or higher, and certain courses with limited technical content are not credited towards this requirement. (See the formal requirements listed previously in the distribution requirements.) In the Computer Science area, most students will need to complete a CS course at the 1000-level before attempting requirements at the 2000-level or above. Many students find it advantageous to take more than the minimum CS course requirement.

The Engineering Science courses represent cross-disciplinary areas that are applicable to many engineering and science departments.

**MATHEMATICS AND SCIENCE**

To succeed in the study of electrical and computer engineering, the necessary foundation far exceeds what can be taught in a few introductory courses. In fact, if you even want to begin to understand what your ECE professors are talking about in lecture, you must begin with a firm basis in mathematics and the natural sciences. Moreover, whether applied to ECE or not, proficiency in mathematics and the sciences is a necessary quality for any educated engineer. Consequently, the ECE major requires a total of 4 units (12 courses) as the “Mathematics and Basic Science” distribution requirement.

The first part of this requirement is sufficient education in mathematics. At least 7 of the 12 required courses must be in this area, including coursework in differential calculus, integral calculus, differential equations, discrete mathematics, and probability and/or statistics. To see which specific courses fulfill these math requirements, please consult the mathematics course descriptions, the Planning a Program in ECE section, and your academic advisor.

The other part of the requirement is coursework in the sciences. A solid understanding of physics is essential to any ECE student, being ultimately necessary for describing the behavior of electricity and magnetism as well as other physical phenomena. Knowledge of chemistry is useful as well, encompassing such topics as atomic and molecular behavior and the chemical properties of materials (such as silicon, which is quite useful in ECE). In recent years, knowledge of biology has also become important to electrical and computer engineers, particularly as biomedical-electrical technologies such as medical imaging continue to advance.

The ECE major requires at least 3 courses in the sciences, 2 of these courses must be in physics, and the remaining course may be in chemistry or biology depending on preference.

Finally, note that the total prescribed mathematics and science courses add up to 3 1/3 units (10 courses). To meet the distribution requirement, you then must take at least 2 more courses in any area of mathematics or science (that is, any other course with the prefix “MA”, “PH”, “CH”, “BB”, or “GE”).

---

## MINOR IN COMPUTER ENGINEERING

---

This interdisciplinary minor requires students to develop competence in areas of computer engineering, including both hardware and software aspects of computer systems. This minor is not available to students majoring in Electrical and Computer Engineering.

Selected Rules for a Minor include the following:

1. Two or more units of thematically related activity.
2. Concluding 1/3 unit of the Minor must be a capstone experience.
3. A Minor may include any portion of the academic program, excluding the MQP.
4. At least one-unit of the Minor, including the capstone activity, must be free electives.
5. The Program Review Committee for a Minor area will consist of faculty members designated by the sponsoring faculty members.

In order to be eligible to receive the Computer Engineering Minor designation, at least six computer engineering related ECE and CS courses must be included in the distribution requirements, listed below. Other appropriate courses may be substituted with the approval of the Computer Engineering Minor Program Review Committee.

**A. At least three of the following ECE courses must be included.**

ECE 2801*	Foundations of Embedded Computer Systems *(cannot be counted if CS 2011 is also selected)
ECE 3801	Advanced Logic design
ECE 3803	Microprocessor System Design
ECE 3810*	Advanced Digital System Design *(cannot be counted if either ECE 3815 or ECE 3902 is also selected)
ECE 4801	Advanced Computer System Design
ECE 505	Computer Architecture

**B. At least three of the following CS courses must be included.**

CS 2011*	Introduction to Machine Organization and Assembly Language *(cannot be counted if ECE 2801 is also selected)
CS 3013	Operating Systems
CS 3733	Software Engineering
CS 4513	Distributed Computing Systems
CS 4514	Computer Networks
CS 4515*	Computer Architecture *(cannot be counted if ECE 505 is also selected)

**C. Capstone Courses**

The following courses may be used to satisfy the Computer Engineering minor capstone requirement: ECE 3803, ECE 3810, ECE 4801, CS 4513, CS 4514, CS 4515.

The Program Review Committee for the Computer Engineering Minor will be composed of Prof. W. R. Michalson (ECE) and Prof. M. J. Ciaraldi (CS). To apply for the Computer Engineering Minor designation, **fill out the application form and return the form to the Computer Engineering Minor Coordinator (W.R. Michalson, ECE Department).**

---

## ENGINEERING SCIENCE COURSES

---

In the formation of a program of study for any engineering or science student, it is important to emphasize a significant number of interdisciplinary courses which form the fundamental building blocks of so many scientific and engineering activities.

In addition to those courses in science and mathematics which are an important part of every engineer's background at WPI, there are a number of courses containing subject matter common to a variety of disciplinary interests. These courses are known as the "engineering science group" and are often taught jointly by members of more than one department.

Every engineer, for example, needs to have some knowledge of graphics, the communications tool of engineering; of thermodynamics, the consideration of an important aspect of energy and its laws; of mechanics, solid and fluid, static and dynamic, the treatment of forces and their effects on producing motion. These and certain other courses of either basic knowledge or broad application are grouped in the engineering science series to provide special focus on them for all students interested in applied science or engineering. In developing programs to meet engineering science distribution requirements, students and advisors should give careful attention to these engineering science courses.

---

## ENGINEERING PHYSICS

---

ADVISOR: G. S. Iannacchione

Programs of study in Engineering Physics are listed under the Physics Department. These programs include specialization in such areas as computational techniques, optics, electromagnetism, materials science and engineering, nuclear science and engineering, and thermal physics.

---

## ENVIRONMENTAL PROGRAMS

---

Our relationship to the environment poses many and often complex problems. Solving these problems may require knowledge of science, technology, engineering, law, social policy, philosophy, history, literature, and the arts. In addition to enabling students to become effective scientists and engineers, programs offered at WPI can prepare students to pursue interests and careers in environmental journalism, environmental law, the EPA or other government programs, international contexts of development and conservation, environmental education, and professional environmental activism.

Students should review these programs as listed below, and talk with their academic advisors and the respective program coordinators, to help make a good choice of environmental major at WPI. In every program, the WPI project requirements, both in the major field and the IQP, will provide unusually strong support for defining specific career directions. Students are also urged to make use of the "Global Perspective Program" to carry out one project abroad, and thus attain a sense of environmental studies at a global, cross-cultural level.

For information, please contact Prof. Lance Schachterle, les@wpi.edu or 508-831-5514.



# ENVIRONMENTAL ENGINEERING

DIRECTOR: J. Plummer (CEE)

ASSOCIATED FACULTY: J. Bergendahl (CEE), T. Camesano (CHE), W. Clark (CHE), D. DePaor (PH), D. DiBiasio (CHE), F. Hart (CEE), N. Kazantzis (CHE), P. Mathisen (CEE), J. O'Shaughnessy (CEE), B. Savilonis (ME), J. Sullivan (ME), R. Thompson (CHE)

## MISSION STATEMENT

Environmental engineers are challenged not only with mastering technical and scientific principles, but also understanding the broader context within which environmental solutions are implemented. The environmental engineering program encourages coursework in the humanistic and social aspects of engineering decisions, public health management, and environmental preservation. The projects program at WPI offers environmental engineering students a unique opportunity to explore the complex humanistic, economic, legal, and political issues surrounding environmental engineering problems.

The Environmental Engineering degree program prepares students for careers in both the private and public sectors, consulting, industry, and advanced graduate study.

## PROGRAM EDUCATIONAL OBJECTIVES

The educational objectives for the Bachelor degree in Environmental Engineering are that all graduates:

1. Are able to apply fundamental principles of mathematics, science, and engineering to solve water, air, and land environmental problems.
2. Have the interpersonal and communication skills, an understanding of ethical responsibility, and a professional attitude necessary for a successful engineering career.
3. Have the ability to engage in lifelong learning.
4. Have an appreciation for the interrelationships between basic scientific knowledge, technology, and societal issues.

## PROGRAM OUTCOMES

The educational outcomes for the Bachelor degree in Environmental Engineering are that all graduates will:

1. Be prepared for engineering practice, including technical, professional, and ethical components.
2. Be prepared for future changes in environmental engineering.
3. Have a solid understanding of the basic principles of environmental engineering.
4. Demonstrate knowledge in the areas of water, land, and air systems, and environmental health.
5. Understand appropriate scientific concepts, and have an ability to apply them to environmental engineering.
6. Understand the engineering design process and have an ability to perform engineering design, which includes the multidisciplinary aspects of the engineering design process, the need for collaboration and communication skills, plus the importance of cost and time management.

7. Have the ability to collect, analyze and interpret experimental data.
8. Understand options for careers and further education, and the educational preparation necessary to pursue those options.
9. Have an ability to learn independently.
10. Have the broad education envisioned by the WPI Plan, and described by the Goal and Mission of WPI.
11. Have an understanding of the environmental engineering profession in a societal and global context.

## Program Distribution Requirements for the Environmental Engineering Major

The normal period of residency at WPI is 16 terms. In addition to WPI requirements applicable to all students, students wishing to receive a degree designated "Environmental Engineering" must satisfy certain distribution requirements as follows:

REQUIREMENTS	MINIMUM UNITS
1. Mathematics and Basic Science (Note 1)	4
2. Advanced Science (Note 2)	1
3. Engineering Science and Design (Includes MQP) (Note 3)	6

### NOTES:

1. Mathematics and Basic Science
  - a. Must include 6/3 units of mathematics, including differential and integral calculus, differential equations, and statistics.
  - b. Must include 6/3 units of basic science, including 1/3 unit of biology (BB), 3/3 units of chemistry (CH), 1/3 unit of earth science (GE 2341 recommended) and 1/3 unit of PH (calculus based).
2. Advanced Science: Must include 3/3 units of science at the 2000-level or higher. Minimum of 1/3 unit in biology (BB) and 1/3 unit in chemistry (CH). Courses may not be double counted toward the basic science requirement.
3. Engineering Science and Design
  - a. Must include 2/3 units in thermofluids, including 1/3 unit in fluid mechanics (ES 3004 recommended) and 1/3 unit in thermodynamics (ES 3001, CH 3501 or CHE 2013).
  - b. Must include 2/3 units in mechanics and materials (CE 2000 or ES 2501, CE 2001 or ES 2502, ES 2001, ES 2503).
  - c. Must include 3/3 units of Core Environmental Engineering (CHE 2011, CE 3059, CE 3062, CHE 3201).
  - d. Must include 6/3 units in Environmental Engineering Electives, arranged as follows: 3/3 units in water quality and resources, 2/3 units in air and land environmental systems, and 1/3 unit in environmental management.
  - e. Must include 1/3 unit of environmental health issues (CE 3059, CE 3060, CE 3061, or appropriate experience through IQP, independent study, or appropriate consortium courses).
  - f. Must include 2/3 units with laboratory experimentation. Must include either CE 4060 or CHE 4401. The remaining 1/3 unit may be CE 4060, CHE 4401, laboratory courses in CH (CH 2640 or CH 2650, which would satisfy Advanced Science course requirements), CE 3026, or CE 2020.
  - g. Must include 1/3 unit major design experience through the MQP, or other approved design experience in a course such as CHE 4403 or ME 4429.

For more information, please consult the web site for this major at <http://wpi.edu/Academics/Majors/EVE/>.

---

**ENVIRONMENTAL ENGINEERING PROGRAM CHART**

---

STUDENTS EARNING A BACHELOR DEGREE IN ENVIRONMENTAL ENGINEERING MUST COMPLETE A MINIMUM OF 15 UNITS OF STUDY, DISTRIBUTED AS FOLLOWS:

---

**MATHEMATICS AND BASIC SCIENCE (4 Units Required)**

Differential and integral calculus; differential equations	5/3 units
Statistics (MA 2611 recommended)	1/3 unit
Biology (BB)	1/3 unit
Chemistry (CH)	3/3 units
Earth science (GE 2341 recommended)	1/3 unit
Physics (PH, calculus-based)	1/3 unit

---

**ADVANCED SCIENCE (1 Unit Required)**

2000-level or higher courses. Minimum of 1/3 units in biology (BB) and 1/3 units in chemistry (CH). Courses may not be double counted toward the basic science requirement.

---

**ENGINEERING SCIENCE AND DESIGN (6 Units Required;**

**5 1/3 units as arranged below plus 2/3 units free electives in ES&D at the 2000-level or above).**

Please consult the program distribution requirements for detailed information on course requirements and selection.

**Engineering Science**

<b>Thermofluids</b>	<b>minimum 2/3 units</b>
ES 3001 Introduction to Thermodynamics (or CHE 2013 or CH 3510)	
ES 3002 Mass Transfer	
ES 3004 Fluid Mechanics	
CHE 3501 Applied Mathematics in Chemical Engineering	

<b>Mechanics and Materials</b>	<b>minimum 2/3 units</b>
CE 2000 Analytical Mechanics I (or ES 2501)	
CE 2001 Analytical Mechanics II (or ES 2502)	
ES 2001 Introduction to Material Science	
ES 2503 Introduction to Dynamic Systems	

**Core Environmental Engineering** **minimum 3/3 units**

CHE 2011 Chemical Engineering Fundamentals
CE 3059 Environmental Engineering
CE 3062 Hydraulics in Civil Engineering
CHE 3201 Kinetics and Reactor Design

**Environmental Engineering Electives**

<b>Water Quality and Resources</b>	<b>minimum 3/3 units</b>
CE 3060 Water Treatment	
CE 3061 Wastewater Treatment	
CE 4060 Environmental Engineering Laboratory	
CE 4061 Hydrology	

<b>Air and Land Environmental Systems</b>	<b>minimum 2/3 units</b>
CE 3041 Soil Mechanics	
CE 3074 Environmental Analysis	
CHE 3920 Air Quality Management	
CHE 4401 Unit Operations of Chemical Engineering I	

<b>Environmental Management</b>	<b>minimum 1/3 unit</b>
CE 3020 Project Management	
CE 3070 Urban and Environmental Planning	
CE 4071 Land Use Development and Controls	

---

**Major Qualifying Project** **3/3 units**

---

**ADDITIONAL DEGREE REQUIREMENTS (4 units Required)**

Humanities and Arts	6/3 units
Social Science‡	2/3 units
IQP	3/3 units
Physical Education	1/3 unit

‡ Many SS courses compliment topics in environmental engineering.  
 Courses in policy, regulations, law and environmental problems are recommended.

---

## ENVIRONMENTAL INTERESTS

---

### Civil Engineering with Environmental Concentration

---

Coordinators: Profs. Bergendahl, Hart, Mathisen, O'Shaughnessy, and Plummer, Civil and Environmental Engineering

Civil Engineering majors may choose to focus their studies by obtaining an Environmental concentration. An Environmental concentration in the CEE Department focuses on the planning, design, construction, operation and regulation of water quality control systems related to water supply and waste treatment. Additional areas of focus include hydrology, hydraulics, solid and hazardous waste management, waste minimization, public health and air pollution control.

Students electing to pursue the Environmental concentration follow a general curriculum in Civil Engineering, with emphasis on the environmental engineering sub-area. Such preparation leads to a degree recognized by the professional accrediting organization, ABET (Accreditation Board of Engineering and Technology), and is an excellent start for entry-level professional placement or graduate study in environmental engineering.

The Environmental concentration is earned by completing six courses from a prescribed list (or alternate courses through petition) plus an MQP in the environmental area. Typical MQPs include the analysis and design of innovative wastewater, water and solid waste treatment systems, disinfection processes, water quality monitoring and control system designs, water resources systems and groundwater studies.

For further information on the Environmental Concentration within Civil Engineering, please consult the Civil Engineering program description.

---

### Chemical Engineering with Environmental Concentration

---

Coordinators: Profs. Camesano, Thompson, Ma, Dixon, DiBiasio, Kazantzis, or Clark, Chemical Engineering

The Department of Chemical Engineering at WPI provides a general curriculum leading to an ABET-accredited degree in chemical engineering. Undergraduates can become involved in a specialty area of environmental engineering through their MQP or other independent projects, and are encouraged to work with faculty in their own areas of research in these fields. Today's chemical engineers are challenged to help maintain industrial competitiveness while ensuring a healthy environment. Chemical engineers with environmental emphasis design and develop environmentally benign chemical processes aimed at preventing pollution at its source by recycling or eliminating all hazardous components. Additionally, they are involved in developing environmentally friendly products like biodegradable packaging materials. Chemical engineers' understanding of the physical and chemical properties of pollutants makes them uniquely qualified to develop technical solutions to current environmental problems of soil, water, and air pollution.

Students majoring in this program would follow a general curriculum in Chemical Engineering, with elective coursework in environmental engineering and environmental related project

work. Such preparation leads to a degree recognized by the professional accrediting organization, ABET (Accreditation Board for Engineering Technology), and is an excellent start for entry-level professional placement or graduate study in environmental engineering.

For information, please contact Prof. Robert Thompson, [rwt@wpi.edu](mailto:rwt@wpi.edu) or 508-831-5525.

---

### Semester In Environmental Science

---

Coordinator: Prof. D. Gibson, Biology & Biotechnology  
Course work in marine ecology is available off campus through a cooperative arrangement with the Marine Biological Laboratory in Woods Hole. Each fall the Marine Biological Laboratory in Woods Hole and a consortium of colleges and universities sponsor a semester of study in environmental sciences, explored through the perspective of ecosystems ecology. Students participating in the SES will be housed and study at the Marine Biological Laboratory for 15 weeks. Study will include core courses in terrestrial and aquatic ecosystems, seminar series in science and science writing, and elective courses in specific areas of ecology and ecosystems. Each student will also complete an independent research project. Entrance into the program is competitive. Prospective applicants will be prescreened by a selection committee at WPI. Final applications are reviewed by a committee appointed by the director of MBL which makes the final selection.

For more information, please contact Prof. Daniel Gibson, [dgibson@wpi.edu](mailto:dgibson@wpi.edu) or 508-831-5144.

---

### Environmental Policy and Development

---

Coordinators: Profs. Saeed or Rissmiller, Social Science and Policy Studies

The Department of Social Science and Policy Studies offers a degree program in Environmental Policy and Development that emphasizes sustainability. The program takes a multidisciplinary approach to environmental issues and includes coursework in economics, public policy, law, and psychology. Students can also pursue degrees in Economic Science, Society, Technology, and Policy, and System Dynamics with an environmental emphasis.

Students majoring in one of these SSPS programs will be prepared for entry-level professional work, or for graduate study either for the MBA or a master's or doctoral research program.

For information, please contact Prof. Khalid Saeed, [saeed@wpi.edu](mailto:saeed@wpi.edu) or 508-831-5563.

---

### Humanities and Arts with Environmental Studies Concentration

---

Coordinator: Prof. R. Gottlieb, Humanities & Arts

The Humanities Department at WPI offers a general curriculum leading to degrees with concentrations in literature, philosophy and religion, and history. Students interested in humanistically-oriented environmental studies could major in the humanities, and take a specifically designed program involving one or more of these areas. Career possibilities upon graduation would include law, business, government service, environmental activism, journalism, or graduate study in the humanities.

For information, please contact Prof. Roger Gottlieb, [gottlieb@wpi.edu](mailto:gottlieb@wpi.edu) or 508-831-5439.

## Interdisciplinary Environmental Studies

Coordinator: Prof. R. Vaz, Interdisciplinary and Global Studies Division

Students wishing to design their own unique program in any field of environmental studies at WPI can do so through the Interdisciplinary and Global Studies Division (IGSD). Such a program might, for example, involve roughly equal areas of study in biology and biotechnology, chemical engineering, and social science and policy studies. Many other possible combinations also exist, with differing levels of study in both scientific and technological disciplines, and in social sciences, policy studies or humanities (ethics). Examples of areas for major study include (but are not limited to):

- identification and production of micro-organisms to remove heavy metals from the water supply, and
- technical writing for environmental organizations.

Interdisciplinary programs are coordinated through the IGSD, and advised by a panel of three faculty from different disciplines. Many students also explore the course offerings at Clark University and the College of the Holy Cross, which are available at no cost through the Worcester Consortium. Students with interdisciplinary programs will be prepared for entry-level professional employment or graduate study.

For information, please contact Prof. Rick Vaz, vaz@wpi.edu or 508-831-5547.

## FIRE PROTECTION ENGINEERING

### KATHY A. NOTARIANNI, HEAD

PROFESSOR: B. J. Sivilonis

ASSOCIATE PROFESSORS: N. A. Dembsey, B. Meacham, L. Albano, F. Noonan, K. A. Notarianni

ASSISTANT PROFESSOR: A. Rangwala

AFFILIATE PROFESSORS: W. K. Kim, E. S. Yoon

EMERITUS PROFESSORS: R. W. Fitzgerald, R. E. Zalosh

DIRECTOR EMERITUS: D. A. Lucht

ADJUNCT ASSISTANT PROFESSORS: R. F. Fleming, M. Hurley, M. Puchovsky, D. Sheppard, J. Averill, J. Ierardi

### MISSION STATEMENT

To deliver a high quality fire protection engineering education program for both full-time students and practicing professionals, supported by fire research in selected areas of strength.

### PROGRAM EDUCATIONAL OBJECTIVES

- To deliver a comprehensive fire protection engineering degree/certificate program that is consistent with changes in technology and the environment.
- To maximize the use of educational technology to deliver for-credit courses to both part time and full time students, on and off campus worldwide.

### COMBINED BS/MS DEGREE PROGRAM

A combined-degree program is available for those undergraduate students having a strong interest in fire protection. This program provides students with the opportunity to accelerate their graduate work by careful development of their undergraduate plan of study leading to a Bachelor degree in a field of engineering and a master's degree in fire protection engineering. The combined-degree approach saves time and money since up

to 40 percent of course credits counted towards the Master's degree can also be counted toward the Bachelor degree. Holders of a Bachelor degree in traditional engineering or science disciplines and the Master's degree in fire protection engineering enjoy extremely good versatility in the job market.

## FIRE PROTECTION ENGINEERING FIVE-YEAR PROGRAM

High school seniors can be admitted to the combined-degree program as freshmen, allowing them to complete both a bachelor's degree in a selected field of engineering and the master's degree in fire protection engineering in five years.

## HUMANITIES AND ARTS

### J. P. HANLAN, INTERIM HEAD; P. H. HANSEN, ASSOCIATE HEAD

PROFESSORS: F. Bianchi, J. J. Brattin, S. C. Bullock, D. B. Dollenmayer, R. S. Gottlieb, J. P. Hanlan, K. P. Ljungquist, W. T. Mott, L. E. Schachterle, S. Vick

ASSOCIATE PROFESSORS: W. A. B. Addison, Jr., M. Ephraim, P. H. Hansen, L. D. Higgins, E. M. Parkinson, A. A. Rivera, J. Rudolph, M. D. Samson, R. L. Smith

ASSISTANT PROFESSORS: C. Clark, B. Eddy, J. Farbrook, T. Robertson, J. Rosenstock, J. Sanbonmatsu, E. Shim

ADJUNCT FACULTY: A. Ameal-Pérez, W. A. Baller, U. Brisson, J. Delorey, J. Dempsey, R. G. Falco, J. L. Forgeng, D. E. Gray, M. Halpine, I. E. Matos-Nin, B. L. McCarthy, S. Nikitina, R. J. Njoroge, D. O'Donnell, Y. Payusova, J. R. Policelli, D. A. Rawson, S. Runstrom, J. T. Sands, D. J. Spanagel, J. E. Watters, D. G. Weeks, J. Zinn

PROFESSORS EMERITUS: L. Curran, E. Hayes, C. Heventhal, J. Manfra, D. McKay, L. Menides, T. Shannon, M. Sokal, J. Zeugner

### MISSION STATEMENT

We are committed to helping students develop both a knowledge of, and an ability to think critically about, the humanities and arts. We also seek to foster the skills and habits of inquiry necessary for such learning: analytical thought, clear communication, and creative expression. Such an education, we believe, provides a crucial foundation for responsible and effective participation in a complex world.

## Program Distribution Requirements for the Humanities and Arts Major

REQUIREMENTS	MINIMUM UNITS
1. Humanities and Arts (including MQP) (Note 1)	6
2. Mathematics and Science (Note 2)	2
3. Electives (Note 3)	2

### NOTES:

1. Humanities and Arts majors may choose to complete 2 units of work and an MQP in one of the following areas of concentration: History, Literature, Music, Philosophy/Religion, Drama/Theatre, Writing and Rhetoric, Art or Art History, German Studies, Hispanic Studies, American Studies, Environmental Studies, or Humanities Studies of Science and Technology. The remaining 3 units of work may be from any area within the Humanities and Arts except that no less than 1 unit should be from an area of Humanities and Arts outside of the area of the student's main concentration.
2. Must include 2/3 units in mathematics and 2/3 units in basic science. The remaining 2/3 unit may be from mathematics, basic science or computer science.
3. May be from any area except Air Force Aerospace Studies, Military Science, or Physical Education. Courses used to satisfy other degree requirements (i.e. the IQP) may not be used to fulfill this requirement.

## CONCENTRATIONS FOR HUMANITIES AND ARTS MAJORS

Humanities and Arts majors may focus their studies by choosing a Concentration within a specific area of the Humanities and Arts, or within an interdisciplinary area closely related to the Humanities and Arts. Concentrations within the Humanities and Arts Department comply with WPI's requirements for Concentrations. Students must complete an MQP and two units of integrated study in the area of their Concentration. Concentrations within the Humanities and Arts (History, Literature, Music, Philosophy, Religion, Drama/Theatre, Writing and Rhetoric, Art History, German Studies, Hispanic Studies) require two units of work in an area designated by specific disciplinary course prefixes, as described below. For example, a Concentration in History requires two units of HI courses at the 2000 level or higher and an MQP in history. Concentrations that are interdisciplinary in nature (American Studies, Environmental Studies, and Humanities Studies of Science and Technology) each require that courses be selected from specific lists of designated courses.

All of these Concentrations are excellent preparation for a variety of careers. Graduates of the Humanities and Arts major have gone to law, business, and medical schools, as well as to graduate programs in the discipline of their Humanities and Arts concentration. Some graduates have pursued careers as writers, teachers, engineers, or scientists. Other students have found work in the theatre as actors, technicians, or playwrights, or in music as composers or performers. The advantages our graduates find in their pursuit of further study and careers are the advantages of a rigorous study of the liberal arts: a good foundation in our cultural traditions and the cultural diversity of the world, and strong skills in research, analysis, writing, or performance.

In addition, since each Humanities and Arts major completes some technical work, either via the Distribution Requirements or a double major in a technical field, our graduates receive unique preparation as technological humanists. This educational experience gives them a distinct advantage in many fields in which a solid knowledge of engineering or science is increasingly valuable, such as environmental studies, drama/theatre, or business. The Humanities and Arts major equips students with vital general professional skills and with broad cultural and technical perspectives. Our many courses devoted to international issues or to foreign languages and the active involvement of Humanities and Arts faculty in the university's global programs provides superb training for technological humanists interested in international issues. Whatever their specific area of concentration, majors in the Humanities and Arts gain an intellectual curiosity and openness to the diversity of human cultural achievements that will enrich their lives and enhance their careers.

### REQUIREMENTS

#### Humanities and Arts with History Concentration

2 units of HI (2000 level or higher) and MQP in History

#### Humanities and Arts with Literature Concentration

2 units of EN, TH, or RH (2000 level or higher) and MQP in Literature

#### Humanities and Arts with Music Concentration

2 units of MU (2000 level or higher) and MQP in Music

#### Humanities and Arts with Philosophy Concentration

2 units of PY (2000 level or higher) and MQP in Philosophy

#### Humanities and Arts with Religion Concentration

2 units of RE (2000 level or higher) and MQP in Religion

#### Humanities and Arts with Drama/Theatre Concentration

2 units of TH, EN, or RH (2000 level or higher) and MQP in Drama/Theatre

#### Humanities and Arts with Writing and Rhetoric Concentration

2 units of RH, EN/WR, or TH (2000 level or higher) and MQP in Writing and Rhetoric

#### Humanities and Arts with Art History Concentration

2 units of AR or HU and MQP in Art History

#### Humanities and Arts with German Studies Concentration

2 units of GN (2000 level or higher) and MQP in German Studies

#### Humanities and Arts with Hispanic Studies Concentration

2 units in SP (2000 level or higher) and MQP in Spanish

## HUMANITIES AND ARTS WITH AMERICAN STUDIES CONCENTRATION

This interdisciplinary concentration examines American culture from the multiple perspectives of American history, literature, and politics. American Studies at WPI takes advantage of the unparalleled resources at the American Antiquarian Society.

- 1/3 units: one of the following courses: HU 1411 Introduction to American Studies, EN 1231 Introduction to American Literature, EN 1257 Introduction to African American Literature and Culture, HI 1311 Introduction to American Urban History, HI 1312 Introduction to American Social History, or HI 1314 Introduction to Early American History.
- 2/3 units from List 1 ("American History")
- 2/3 units from List 2 ("American Literature")
- 1/3 units from List 3 ("American Politics, Law, and Policy"). This may not include courses taken to fulfill the Social Science Requirement.
- MQP in American Studies

#### List 1. American History:

HI 2311	American Colonial History
HI 2313	American History, 1789-1877
HI 2314	American History, 1877-1920
HI 2315	The Shaping of Post-1920 America
HI 2316	American Foreign Policy from Woodrow Wilson to the Present
HI 2317	Law and Society in America, 1865-1910
HI 2331	American Science and Technology to 1859
HI 2332	American Science and Technology from 1859
HI 3311	American Labor History
HI 3312	Topics in American Social History
HI 3314	The American Revolution
HI 3333	Topics in American Technological Development

#### List 2. American Literature:

EN 2221	American Drama
EN 2231	American Literature: The Raven, the Whale, and the Woodchuck
EN 2232	American Literature: Twain to the Twentieth Century
EN 2233	American Literature: Twentieth Century
EN 2234	Modern American Novel
EN 2235	The American Dream: Myth in Literature and the Popular Imagination

EN 2237	American Literature and the Environment
EN 2238	American Realism
EN 3221	New England Supernaturalism
EN 3232	The Concord Writers
EN 3233	Worcester Between the Covers: Local Writers and Their Works
EN 3224	Modern American Poetry
EN 3237	Pursuing Moby-Dick

**List 3. American Politics, Law, and Policy:**

GOV 1301	U.S. Government
GOV 1303	American Public Policy
GOV 1310	Law, Courts, and Politics
STS 1207	Introduction to Psycho-sociology of Science
GOV 2302	Science-Technology Policy
STS 2208	The Society-Technology Debate
GOV 2304	Governmental Decision Making and Administrative Law
GOV 2310	Constitutional Law
GOV 2311	Environmental Policy and Law

## HUMANITIES AND ARTS WITH ENVIRONMENTAL STUDIES CONCENTRATION

This interdisciplinary concentration combines course work from the humanities and arts, social sciences, and other areas to examine environmental issues.

1. 3/3 units from List 1 (“Designated Environmental Courses in Humanities”)
2. 2/3 units from List 2 (“Related Environmental Courses in Social Sciences”). These may not include courses taken to fulfill the Social Science Requirement.
3. 1/3 units from List 3 (“Environmental Courses in Other Areas”)
4. MQP in Environmental Studies

**List 1. Designated Environmental Courses in Humanities:**

AR 2113	Topics in 19th- and 20th-Century Architecture
EN 2237	American Literature and the Environment
HI 1311	Introduction to American Urban History
HI 1341	Introduction to Global History
HI 2334	European Technological Development
HI 3331	Topics in Science, Technology, and Society
HI 3333	American Technological Development
PY 2712	Social and Political Philosophy
PY 2713	Bioethics
PY 2717	Philosophy and the Environment

**List 2. Related Environmental Courses in Social Sciences:**

ECON 2117	Environmental Economics
ECON 2125	Development Economics
GOV 2311	Environmental Policy and Law
GOV 2312	International Environmental Policy
PSY 2405	Environmental Problems and Human Cognition

**List 3. Environmental Courses in Other Areas:**

BB 2040	Principles of Ecology
CHE 3910	Chemical and Environmental Technology
CHE 3920	Air Quality Management
CE 3059	Environmental Engineering
CE 3070	Urban and Environmental Planning
CE 3074	Environmental Analysis
ME 3422	Environmental Issues and Analysis

## HUMANITIES AND ARTS WITH HUMANITIES STUDIES OF SCIENCE AND TECHNOLOGY CONCENTRATION

This interdisciplinary concentration enables students to apply to the methods of the humanities and social sciences to the study of science and technology.

1. 2/3 units from List 1 (“Designated HSST Courses”)
2. 2/3 units from List 1 or List 2 (“Closely Related Courses in Humanities”)
3. 2/3 units from List 3 (“Science-Technology-Studies Courses in Other Areas”). These may not include courses taken to fulfill the Social Science Requirement.
4. MQP in Humanities Studies of Science and Technology

**List 1: Designated HSST Courses**

AR 2113	Topics in 19th- and 20th-Century Architecture
EN 2252	Science and Scientists in Modern Literature
EN 3215	Genres of Science Writing
HI 1331	Introduction to the History of Science
HI 1332	Introduction to the History of Technology
HI 2330	History of American Science and Technology
HI 2333	History of Science from 1700
HI 2334	European Technological Development
HI 2351	History of Ecology
HI 2401	U.S. Environmental History
HI 2402	History of Evolutionary Thought
HI 3317	Topics in Environmental History
HI 3331	Topics in Science, Technology, and Society
PY 2713	Bioethics
PY 2717	Philosophy and the Environment

**List 2: Closely Related Courses in Humanities**

AR 3112	Modernism, Mass Culture, and the Avant-Garde
HI 1311	Introduction to American Urban History
HI 2324	Industry and Empire in British History
HI 3311	American Labor History
HI 3323	Topics in the Western Intellectual Tradition
PY 2711	Philosophical Theories of Knowledge and Reality

**List 3: Science-Technology-Studies Courses in Other Areas.**

AR/ID 3150	Light, Vision and Understanding and the Scientific Community
STS 1207	The Psycho-Sociology of Science
STS 2208	The Science-Technology Debate
GOV 2302	Science-Technology Policy
GOV 2304	Governmental Decision Making and Administrative Law
GOV 2311	Environmental Policy and Law
GOV 2312	International Environmental Policy

## DOUBLE MAJOR IN HUMANITIES AND ARTS

Students may pursue a double major in Humanities and Arts and in an area of science, engineering, or management. To pursue the double major, a student must satisfy all of the degree requirements of the technical discipline including an MQP and Distribution Requirements. In addition, the double major in Humanities and Arts requires 6 units of studies in the Humanities and Arts, including the MQP. Students pursuing a double major, one of which is Humanities and Arts, are not required to

complete the Degree Requirement in Humanities and Arts, nor are they required to complete a second IQP. Students interested in pursuing this option should contact Prof. B. Addison, 39 Dean St., Room 260, for additional information.

The demand for graduates equipped with the background possessed by a WPI student with a double major in the Humanities and Arts is likely to increase. Many fields, including medicine, law, industry, theatre technology, commerce, and public service, will be open to those who have acquired both the skills of humanistic education and technical or managerial knowledge.

---

## HUMANITIES AND ARTS MINORS

---

Minors can be arranged in areas other than the above. See Prof. Addison, 39 Dean Street, for further information about minors in other areas and interdisciplinary minors.

---

## DRAMA/THEATRE MINOR

---

The minor in Drama/Theatre is for students who choose to continue their studies in Drama/Theatre beyond the Humanities and Arts Requirement without majoring in Drama/Theatre. Students who, for personal or career purposes, wish to earn official recognition of their achievements in Drama/Theatre, and who do not have academic time to fulfill the requirements for the major, should consider the Drama/Theatre minor.

Because performance, including design and production, is an integral component of Drama/Theatre, the requirements for this minor contain a performance emphasis. The Drama/Theatre minor consists of 2 units of work distributed as follows:

1. Drama/Theatre Courses: 1 1/3 units chosen from among the following:  
EN 1221, EN 1222, EN 2221, EN 2222, EN 2224, EN 3222, EN 3223, EN 3224, or any IS/P designated TH.
2. Drama/Theatre Performances: 1/3 unit (at least two 1/6 unit TH IS/P, Independent Study/Projects).
3. Drama/Theatre Capstone Experience: 1/3 unit Performance Independent Study/Project (EN or TH). The student, with faculty guidance, will perform, design, direct, produce or in some other way create a Drama/Theatre presentation that demonstrates the student's skill and knowledge.

No more than 1 unit of work for the Humanities and Arts Requirement or Sufficiency Requirement may be applied to the Drama/Theatre minor. The final Inquiry Seminar or Practicum or Sufficiency Project may not be counted toward the minor.

Any student at WPI is eligible to pursue the Minor in Drama/Theatre except for students majoring in Humanities and Arts with a concentration in Drama/Theatre.

---

## MINOR IN FOREIGN LANGUAGE (GERMAN OR SPANISH)

---

The minor in Foreign Language can be completed in either German or Spanish. It allows students who are well prepared to continue their study of the language and its culture well beyond the advanced level. The minor consists of a total of two units of work, distributed in the following way:

1. 1 unit of intermediate and advanced language courses in Spanish or German chosen from the following:
  - SP 2522, SP 3521, SP 3522, or higher or
  - GN 2512, GN 3511, GN 3512, or higher.
 (This unit may be double-counted toward the Humanities and Arts Requirement. No more than one unit may be double-counted in this way.)
2. 2/3 unit of advanced literature and culture courses chosen from the following:
  - SP 3523, SP 3524, SP 3525, SP 3526, or Consortium courses approved by a faculty member in Spanish or
  - GN 3513, GN 3514, or Consortium courses approved by a faculty member in German.
  - Any 3000-level experimental course in GN or SP may also be used.
3. 1/3 unit capstone experience consisting of an IS/P written in the foreign language.

(If, in the future, there are enough German and Spanish minors combined, the capstone independent study will be a team-taught seminar in comparative civilization/literature.) Interested students should see the following professors in the Humanities and Arts Department: Prof. Dollenmayer (for German) or Prof. Rivera and Prof. Manzari (for Spanish).

---

## MUSIC MINOR

---

The minor in Music is for students who choose to continue their studies in Music beyond the Humanities and Arts Requirement without majoring in Music. Students who, for personal or career purposes, wish to achieve official recognition of their achievements in Music, yet do not find the time to fulfill the requirements for the major, should consider the Music minor option. Interested students should speak with one of the music faculty in the Department of Humanities and Arts. Because performance is an integral component of music study with proposed minor will contain performance emphasis and consist of two units of work distributed as follows:

1. 1/3 unit for participation in MU IS/P Ensembles.
2. 1/3 unit Performance IS/P as the capstone experience. Student, with faculty guidance, will present a recital, original composition, or other musical performance that demonstrates the student's skill and knowledge.
3. 1 1/3 units of music courses.
4. If a student completes his/her Humanities and Arts Requirement in music, 1 unit of that work may be applied to the minor except for the final IS/P.
5. A student who is pursuing a major in Humanities and Arts with music as the major field cannot also receive a minor in music.

## WRITING AND RHETORIC MINOR

The minor in Writing and Rhetoric offers students the opportunity to extend their study of writing and rhetoric beyond the Humanities and Arts Requirement without majoring in either the Writing and Rhetoric concentration in Humanities and Arts or the Technical, Scientific, and Professional Communication program. The minor consists of two units of work, distributed in the following way:

1. 2/3 unit. Core courses in writing and rhetoric: RH 3111, RH 3112
2. 1 unit. Electives in writing and rhetoric, chosen from the following: EN/WR 2210, EN/WR 2211, EN/WR 3011, EN/WR 3210, EN/WR 3214, EN/WR 3217 and RH 3211. If there is good reason and with the approval of the Program Review Committee, electives may also include courses in art history, literature (in English or other languages), and philosophy and religion.
3. 1/3 unit. Capstone IS/P.

No more than 1 unit of coursework may be double-counted toward the Humanities and Arts Requirement.

## INDUSTRIAL ENGINEERING

**DIRECTOR: S. A. JOHNSON**

AFFILIATED FACULTY: A. Gerstenfeld, S. A. Johnson, A. Zeng, J. Zhu

### MISSION STATEMENT

The mission of the Industrial Engineering (IE) Program at WPI is to prepare undergraduate students for professional engineering practice, providing the foundation for careers of leadership in challenging global and technological environments. We strive to accomplish this through:

- An innovative, project-based curriculum
- An emphasis on core industrial engineering skills with modern applications
- A flexible curriculum responsive to student interests and changes in the competitive environment
- An environment that encourages faculty/student interaction
- A culture that encourages the active involvement of students in their learning.

## INDUSTRIAL ENGINEERING PROGRAM CHART

Note: This chart summarizes recommendations regarding course selection, sequencing, and timing. Students are encouraged to read the Program Distribution Requirements and Curriculum Guidelines for IE for more complete information. Students are also encouraged to arrange their programs to take advantage of global and cooperative education opportunities.

	FRESHMAN/SOPHOMORE	JUNIOR	SENIOR
COURSE RECOMMENDATIONS	Calculus Sequence MA 1021, MA 1022, MA 1023, MA 1024, MA 2051 Statistics Sequence MA 2611; MA 2612 or MA 2621 H&A Sufficiency Physics/Chemistry Sequence PH 1110, PH 1120, CH 1010; or PH 1110, CH 1010, CH 1020 CS 1101 or CS 1102 Start IE Core: OIE 2500 OIE 3400 CS 2118 Social Science 2 Math/Science Electives	IQP Complete IE Core: OIE 2850 OBC 2300 OIE 3401 OIE 3420 or OIE 3501 OIE 3460 Engineering Basics Outside IE 2 IE Electives: Choices: OIE 3405, OIE 3420, OIE 3450, OIE 3501, MIS 3720, OIE 4410, OIE 4460, MIS 4720, and OR courses in MA 1 Technical Elective Any engineering/science design course (see the IE web site for recommendations)	MQP 1 IE Elective 2 Technical Electives At least 3 Free Electives Complete any remaining degree requirements
DEGREE REQUIREMENTS	<b>H&amp;A Sufficiency (2 units)</b>		
		<b>IQP (1 unit)</b>	
	<b>Math/Science (4 units)</b>		
		<b>Industrial Engineering Topics (5 units)</b>	
			<b>MQP (1 unit)</b>
	<b>Social Science (2/3 units)</b>		
		<b>Free Electives (1 unit)</b>	
	<b>Physical Education (1/3 unit)</b>		



**PROGRAM EDUCATIONAL OBJECTIVES**

Educational objectives describe the expected accomplishments of graduates during the first few years after graduation.

1. **Industrial Engineering Knowledge and Design Skills.**  
Graduates should be able to support operational decision making and design solutions to address the complex and changing industrial engineering problems faced by organizations, using modern concepts and technology.
2. **Communication Skills.** Graduates should be able to communicate effectively, both orally and in writing, using electronic tools and graphical information.
3. **Teamwork and Leadership Skills.** Graduates should be able to serve as change agents in the organizations that employ them, based on strong interpersonal and teamwork skills, an understanding of professional and ethical responsibility and a willingness to take the initiative.

**PROGRAM OUTCOMES**

Program outcomes describe what students are expected to know and are able to do by the time of graduation, and are linked to the educational objectives described above.

1. **Industrial Engineering Knowledge and Design Skills**
  - a. An ability to identify, formulate, and solve industrial engineering problems.
  - b. An ability to design and conduct experiments, as well as to analyze and interpret data.
  - c. An ability to design and improve integrated systems of people, materials, information, facilities and technology.
  - d. An ability to apply core industrial engineering concepts, using the updated techniques, skills and tools necessary for industrial engineering practice.
  - e. The broad education necessary to understand the impact of engineering solutions in a societal context.
  - f. An ability to apply knowledge of mathematics, including statistics as well as integral and differential calculus.
  - g. An understanding of fundamental physical laws.
2. **Communication Skills**
  - h. An ability to communicate effectively.
3. **Teamwork and Leadership Skills**
  - i. An ability to work effectively on multi-disciplinary teams.
  - j. An understanding of professional and ethical responsibility.
  - k. A recognition of the need for and an ability to engage in life-long learning.
  - l. A knowledge of contemporary issues.
  - m. An understanding of global issues.
  - n. An understanding of change management in organizational settings.

**Program Distribution Requirements for Industrial Engineering Major (IE)**

The normal period of residency at WPI is 16 terms. In addition to the WPI requirements applicable to all students (see page 9), students wishing to receive the ABET accredited degree designated “Industrial Engineering” must complete a minimum of 10 units of study in the areas of mathematics, basic science, and engineering topics as follows:

REQUIREMENTS	MINIMUM UNITS
1. Mathematics and Basic Science (Notes 1, 2)	4
2. Industrial Engineering Topics (including the MQP) (Notes 3,4)	6

**NOTES:**

1. Mathematics must include differential and integral calculus, ordinary differential equations, and 2/3 units in probability and statistics.
2. Basic Science must include both chemistry and physics, with a minimum of two courses in either.
3. Must include 1/3 unit of Capstone Design Experience.
4. Industrial Engineering Topics must include courses in the following three topic areas.
  - a. 3 units of industrial engineering core courses, including 1/3 unit in each of the following 9 areas: engineering basics outside industrial engineering, deterministic operations research methods, process design, production planning and control, simulation, stochastic methods in operations research, information systems design, financial modeling and organizational science.
  - b. 1 unit in Industrial Engineering electives. 3000/4000 level OIE courses, MIS 3720, MIS 4720, and Operations Research courses in Mathematics qualify. Courses in financial modeling and organizational science do not qualify.
  - c. 1 unit in technical electives. Industrial Engineering electives and any other Engineering Science/Design courses qualify.

**INTERACTIVE MEDIA AND GAME DEVELOPMENT**

**DIRECTOR: M. CLAYPOOL (CS)**

**CO-DIRECTOR: D. O'DONNELL (HUA)**

ASSOCIATED FACULTY: E. Agu (CS), F. Bianchi (HUA), M. Claypool (CS), D. Cyganski (ECE), J. Farbrook (HUA), D. Finkel (CS), J. Forgeng (HUA), M. Gennert (CS), N. Heffernan (CS), R. Lindeman (CS), D. O'Donnell (HUA), G. Phillies (PH), C. Rich (CS), J. Rosenstock (HUA), J. Sanbonmatsu (HUA), M. Ward (CS)

**PROGRAM OUTCOMES**

The specific outcomes for the WPI IMGD major are that all graduates will:

1. Understand Artistic and Technical areas related to IMGD.
2. Demonstrate an in-depth understanding of either the Artistic or Technical area related to IMGD.
3. Have a base of technical knowledge in Computer Science, Mathematics and Science.
4. Have a base of artistic knowledge in Art, Music and English.
5. Successfully complete a large-scale IMGD project.
6. Successfully complete a group project with both Technical and Artistic IMGD majors.

7. Be able to creatively express and analyze artistic forms relative to IMGD.
8. Communicate effectively orally, in writing, and in visual media.
9. Be aware of social and philosophical issues pertaining to games and related media.

---

## Program Distribution Requirements for the Interactive Media and Game Development Major

---

REQUIREMENTS	MINIMUM UNITS
Core IMGD (Note 1)	2/3
Math	1/3
Science	1/3
Computer Science (Note 2)	1/3
Social and Philosophical Issues (Note 3)	1/3
Studio Art (Note 4)	1/3
Computer Music (Note 5)	1/3
English (Note 6)	1/3
Advanced IMGD (Note 7)	2/3
Major Qualifying Project	3/3

In addition to the requirements listed above, students must satisfy one of the two area requirements, Technical (Computer Science) or Artistic (Humanities and Arts):

AREA	MINIMUM
Computer Science (Note 8)	10/3
Humanities and Arts (Notes 9, 10, 11)	10/3

Students have electives that can be tailored to meet specific degree requirements and interests:

ELECTIVES	MINIMUM
Total Electives (Notes 12, 13)	6/3

### NOTES:

1. Choose from: Critical Studies of Interactive Media and Games (IMGD 1000), The Game Development Process (IMGD 1001), Storytelling in Interactive Media and Games (IMGD 1002).
2. CS 2022 and CS 3043 may not be used to satisfy this requirement.
3. Choose from Social Issues in Interactive Media Games (IMGD 2000) or Philosophy and Ethics of Computer Games (IMGD 2001).
4. Choose from: Essentials of Art (AR 1100) or Digital Imaging and Computer Art (AR 1101).
5. Choose from: Computer Techniques in Music (MU 3611), Computers and Synthesizers in Music (MU 3612), or Digital Sound Design (MU 3613).
6. Courses with the prefix EN or WR.
7. Taken from 2 technical offerings (IMGD 3000 and IMGD 4000) or 2 artistic offerings (IMGD 3500 and IMGD 4500).
8. At least 4/3 from: Human-Computer Interaction (CS 3041), Software Engineering (CS 3733, CS 4233), Computer Architecture (CS 4515), Computer Networks (CS 4514), Graphics (CS 4731), Animation (CS 4732), or Artificial Intelligence (CS 4341).
9. At least 1/3 from each of the following areas: Art, Music and English.
10. At least 5/3 units at the 2000-level or higher.
11. Students completing the Artistic (Humanities and Arts) Area Requirement must complete a Technical Requirement, described below.
12. Electives must be chosen from the following areas: Computer Science, Humanities and Arts, Interactive Media and Game Development, Mathematics, Science, Social Science, Management, or Engineering.
13. At least 3/3 units must be in a single one of the areas listed in Note 12.

### TECHNICAL REQUIREMENT

Each student choosing the Artistic IMGD area will fulfill a Technical Requirement consisting of six courses as follows:

- A. Courses required for all IMGD majors:
  1. One Mathematics Course
  2. One CS course, not including CS 2022 or 3043
  3. One Science (BB, CH, GE, PH) course
- B. Additional requirements:
  4. A second course in Computer Science, not including CS 2022 or 3043
  5. Two additional courses from among Mathematical Sciences, Computer Science, Science (BB, CH, GE, PH) and Engineering (BME, CE, CHE, ECE, ES, FPE, ME), not including CS 3043.

The courses for the Technical Requirement, part A, are satisfied by the IMGD distribution requirements. The courses in part B may not double-count towards other IMGD requirements, including IMGD elective courses.

---

## INTERDISCIPLINARY PROGRAMS

---

### R. F. VAZ, DEAN

### K. RISSMILLER, ASSOCIATE DEAN

ASSISTANT PROFESSORS: R. Krueger, S. Jiusto,  
 ADJUNCT PROFESSOR: S. Vernon-Gerstenfeld  
 ADJUNCT ASSISTANT PROFESSORS: F. Carrera, D. Golding,  
 C. Peet

The Provost Office, in conjunction with the Interdisciplinary and Global Studies Division (IGSD), operates those academic functions or programs which require an interdisciplinary administrative structure. In addition, the IGSD also provides the support structure for students who construct individually-designed (ID) majors which cannot readily be accommodated in traditional academic departments.

ID majors may be defined in any area of study where WPI's academic strengths can support a program of study, and in which career goals exist. Many combinations of technical and non-technical study are possible. Do not be limited by the example given here; if you have questions about what programs at WPI are possible, please see Prof. R. Vaz in the Project Center to discuss how WPI can assist you in reaching your goals.

---

### Procedure for Establishing an Interdisciplinary (Individually-Designed) Major Program

---

Students who wish to pursue an individually-designed major program should first discuss their ideas with their academic advisor. The student should then consult with the dean of the IGSD, Prof. Richard Vaz, who will determine, with the assistance of other members of the faculty, if the proposed program is feasible, and, if it is, arrange for its evaluation.

The following procedures will be followed for feasible programs:

1. The student must submit to the dean of the IGSD an educational program proposal, including a "definition of scope," and a concise statement of the educational goals of the proposed program. Goals (such as graduate school or employment) should be specified very clearly. The proposal must be detailed in terms of anticipated course and project

work. The proposal must be submitted no later than one calendar year before the student's expected date of graduation, and normally before the student's third year.

2. The Dean of the Interdisciplinary and Global Studies Division will name a three-member faculty committee, representing those disciplines most involved in the goals of the program, to evaluate the proposal. The committee may request clarification or additional information for its evaluation. The proposal, as finally accepted by the committee and the student, will serve as an informal contract to enable the student to pursue the stated educational goals most effectively.
3. Upon acceptance of the proposal, the student will notify the Office of Academic Advising and the Projects and Registrar's Office of the choice of ID (individually-designed) as the designation of major. The IGSD then becomes the student's academic department for purposes of record-keeping.
4. The three-person faculty committee will serve as the student's program advisory committee, and will devise and certify the distribution requirements (up to a limit of 10 units including the MQP) appropriate to the student's program.

The programs below are the established majors administered through IGSD.

## PROFESSIONAL WRITING

### DIRECTOR: C. DEMETRY (ME)

ASSOCIATED FACULTY: M. Elmes (MG), L. Higgins (HUA), K. Lemone (CS), A. Rivera (HUA), R. Smith (HUA)

The goal of the Professional Writing program is to prepare communication professionals who can bridge the gap between the public and scientists, engineers, physicians, managers, policymakers, and other experts by presenting technical information in useful and accessible ways.

Professional Writing is an interdisciplinary major or double major that combines work in written, oral, and visual communication with a strong concentration in a scientific or technical field. Students receive individual attention from academic advisors as they design a plan of study that fulfills the program's distribution requirements and best suits their intellectual interests and career aspirations. If they wish, majors can select courses and projects in one of four areas of concentration:

- Science writing, medical writing, health communication
- Writing in the public interest, writing for nonprofits
- Digital media, visual communication, information design
- Bilingual professional communication, translation

The Professional Writing major provides excellent preparation for students interested in careers in technical and scientific communication, writing and editing, web authoring, information design, public relations, medical writing, translation, and intercultural communication. It also prepares students for graduate work in fields such as writing and rhetoric, technical communication, journalism, education, law, public health and medicine, and the study of culture.

MQP opportunities are available on campus and with local companies, newspapers, public agencies, and private foundations. More information about project and career opportunities for Professional Writing majors can be found on the program web site: [www.wpi.edu/Academics/Majors/PWR](http://www.wpi.edu/Academics/Majors/PWR).

## Program Distribution Requirements for the Professional Writing Major

REQUIREMENTS	MINIMUM UNITS
1. Scientific and/or technical concentration (Note 1)	6
2. Writing and Rhetoric concentration (Note 2)	3
3. MQP	1

### NOTES:

1. The student's scientific and/or technical concentration must be a plan of study, approved by the student's program review committee, with a clear underlying rationale in mathematics, basic science, computer science, engineering, and/or management.
2. The Writing and Rhetoric concentration consists of 1 unit in each of the 3 following categories of courses. Courses taken to fulfill these distribution requirements will not include courses that fulfill other degree requirements, such as the Humanities and Arts requirement and the Social Sciences requirement. Exceptions to this restriction, not to exceed 1 unit, must be approved by the student's program review committee, and will be granted only under unusual circumstances.

#### A. Written communication (1 unit)

Recommended courses:

EN/WR 2210 Introduction to Professional Writing

EN/WR 2211 Elements of Writing

EN/WR 3011 Peer Tutoring in Writing

EN/WR 3210 Technical Writing

EN/WR 3214 Writing About Disease and Public Health or equivalent writing courses or ISPs

#### B. Rhetoric and communication studies (1 unit)

Recommended courses:

RH 3111 The Study of Writing

RH 3112 Rhetorical Theory

RH 3211 Rhetoric of Visual Design

or ISP or any of the courses listed in Category A not used to fulfill that requirement.

#### C. Electives (1 unit)

The 1 unit of electives must be coherently defined and approved by the student's program review committee.

Students may draw on:

Courses in science, technology, and culture studies (such as AR/ID 3150, CS 3041, CS 3043, EN 2252, HI 2330, HI 2334, HI 2402, HI 3331, HI 3333, HI 3334, HI 3342, IMGD 2000, IMGD 2001, STS 2208, GOV 2302, PSY 2406);

Philosophy and ethics courses (such as PY 2711, PY 2713, PY 2714, PY 2716, PY 2717, PY/RE 2731, PY/RE 3731);

Foreign language courses;

Management courses.

## TEACHER LICENSING

WPI students wishing to receive the Initial License as middle or high school teachers in Massachusetts or states with reciprocating agreements with MA in the areas of Biology, Chemistry, Mathematics or Physics can do so by passing the Massachusetts MTEL test, taking a Teaching Methods course (ID 3100), performing observation and practice teaching and developing an IQP based on this experience, and taking Psychology of Education (PSY 2401) and Cross-Cultural Psychology (PSY 2406). Also required are courses in the appropriate subject matter meeting State guidelines as defined in Massachusetts regulations (603 CMR 7.00). Students wishing to discuss or pursue this should see Professor John Goulet (MA) and/or see [http://users.wpi.edu/~goulet/teacher\\_prep/teacher\\_prep.htm](http://users.wpi.edu/~goulet/teacher_prep/teacher_prep.htm).

# INTERNATIONAL STUDIES

## P.H. HANSEN, DIRECTOR

ASSOCIATED FACULTY: W.A.B. Addison (HU), U Brisson (HU), F. Carrera (IGSD), D.B. Dollenmayer (HU), A. Gerstenfeld (MG), D. Golding (IGSD), P.H. Hansen (HU), R. Hersh (IGSD), S. Jiusto (IGSD), R. Krueger (IGSD), I. Matos-Nin (HU), C. Peet (IGSD), M.J. Radzicki (SSPS), K.J. Rissmiller (SSPS), A. Rivera (HU), T. Robertson (HU), J. Rudolph (HU), K. Saeed (SSPS), S. Tuler (IGSD), R. Vaz (IGSD; ECE), S. Vernon-Gerstenfeld (IGSD)

International Studies prepares men and women for future leadership roles in business and industry, government and public affairs. International Studies integrates WPI's international courses in the humanities and social sciences with its global projects and exchange programs. International Studies courses on-campus prepare students to go abroad. After an experience overseas, students integrate their experiences and explore their career options in a capstone seminar. International Studies at WPI offers a range of options including a minor, major, or double major in International Studies.

## Program Requirements for the International Studies Minor

INTERNATIONAL STUDIES IQP OPTION	MINIMUM UNITS
International Core (Note 1)	1
International Electives (Note 2)	1
International IQP (Note 3)	1
International Experience (Note 4)	0
Total	3

INTERNATIONAL STUDIES EXCHANGE PROGRAM OPTION	MINIMUM UNITS
International Core (Note 1)	1
International Electives (Note 2)	2
International Experience (Note 4)	0
Total	3

### NOTES:

- International Core. Both options require the same one unit core of international courses. One course must be selected from each of these categories:
  - An introductory course in international history, such as HI 1341, HI 1321, HI 1322, HI 1323, or HI 1313.
  - A course in understanding cross-cultural differences, such as one of the following: HU 3411 Pro-Seminar in Global Perspectives; PSY 2406 Cross-Cultural Psychology; SOC 1202 Introduction to Sociology and Cultural Diversity; PY 2716 Philosophy of Difference.
  - HU 4411 Senior Seminar in International Studies.

Courses in the core may not double-count towards other degree requirements such as the Humanities and Arts Sufficiency requirement or the two course requirement in the Social Sciences. If a student has already counted a course from a) or b) for another requirement, they will be required to take additional courses in International Studies so that at least one unit of their minor does not double-count. The capstone seminar should be the final element of a student's minor.
- International Electives may be selected from among international courses in the Humanities and Social Sciences. They may include any course in European or global history; any course at the intermediate level or above in German or Spanish; any international course in the social sciences; and international courses approved by the Program Review Committee in art history, literature, philosophy and religion. If approved by the Program

Review Committee, PQPs for overseas projects may count towards the total. Students may count courses taken to fulfill other degree requirements towards these electives. These electives may not include the MQP or the final 1/3 unit Type 5 IS/P of the Sufficiency Program.

- International IQP: Students who choose the IQP Option must complete an International IQP. All IQPs completed outside of the United States meet this requirement. If approved by the Program Review Committee, IQPs completed on-campus or at Project Centers in the United States may meet this requirement if the IQP is devoted to an international subject and the student also completes a study abroad experience as described in note 4.
- International Experience: All International Studies minors are required to have a study abroad experience. Students who choose the Exchange Option must complete an international project, exchange, or internship approved by the Program Review Committee. The study abroad experience should be educational in nature and equivalent in length to at least one WPI term.

For general policy on the minor, see description on page 12.

## Distribution Requirements for the International Studies Major

REQUIREMENTS UNITS	MINIMUM
International Core (Note 1)	1
International Fields (Note 2)	4
International Experience (Note 3)	0
Science, Technology, Mathematics (Note 4)	2
Electives (Note 5)	2
MQP	1
Total	10

### NOTES:

- International Core: One course must be selected from each of these categories:
  - An introductory course in international history, such as HI 1341 or HI 1313, HI 1321, HI 1322, HI 1323.
  - A course in understanding cross-cultural differences, such as one of the following: HU 3411 Pro-Seminar in Global Perspectives, or SOC 1202 Introduction to Sociology and Cultural Diversity, or PSY 2406 Cross-Cultural Psychology; or PY 2716 Philosophy of Difference.
  - HU 4411 Senior Seminar in International Studies.
- International Fields: Majors complete at least one unit of work in each of the following areas. They must also complete at least one additional unit of work in one of these areas, which will be considered their primary field.
  - Historical Analysis. These include any courses in European history, world history, or American foreign policy.
  - Language, Literature, and Culture. These include any course in foreign languages, civilization, and literature offered at WPI or in the Consortium with the prior approval of the Program Review Committee; also courses approved by the Program Review Committee in Art History (e.g. AR 1111, AR 2111), English Literature (e.g. EN 2243, EN 3222), Music History (e.g. MU 2615), or Philosophy and Religion (e.g. RE 2721, RE 2724). Majors who designate Language, Literature, and Culture (LLC) as their primary field may not take courses in a second foreign language unless they have achieved 3000-level proficiency in the first. LLC designees should take most of their courses in a single discipline or in a coherent program approved by the Program Review Committee.
  - Social Sciences. These include international courses in the social sciences (e.g. GOV 1320, ECON 2125, GOV 2312, PSY 2406). Students may count courses taken for the two-course requirement in Social Sciences.

3. International Studies majors are required to have a study-abroad experience. (In very unusual cases exceptions may be made to this requirement but only with prior approval of the Director and Program Review Committee). This abroad experience may take the form of a project, exchange, or internship approved by the Program Review Committee. The study-abroad experience should be educational in nature and equivalent in length to at least one WPI term.
4. Must include a minimum of 1/3 unit in science, 1/3 unit in mathematics, 1/3 unit in computer science or engineering science. The remaining 1 unit may be from science, mathematics, computer science or engineering. Double-majors may count courses taken for their other major.
5. Electives may be from any area except Air Force Aerospace Studies, Military Science or Physical Education. Double-majors may count courses taken for their other major.

### DOUBLE MAJOR IN INTERNATIONAL STUDIES

Students may pursue a double major in International Studies and any area of study at WPI except a major in Humanities and Arts. To pursue the double major, a student must satisfy all of the degree requirements for both disciplines, including an MQP and Distribution Requirements. In addition, the double major in International Studies requires the same distribution of courses in the International Core and International Fields as the major in International Studies and a second MQP in International Studies. Double majors are also required to have an International Experience. Students pursuing the double major in International Studies are not required, however, to complete a Humanities and Arts Sufficiency program.

### INTERNATIONAL EXPERIENCES

An International Experience may take the form of an international IQP or exchange program. Students often plan their international experience in their Sophomore year. All students are advised to consult the list of projects offered at WPI's Global Project Centers. Each fall, the projects and exchange programs for the following year are widely advertised on campus. For information about student exchange programs, see page 183.

Award-winning projects at WPI are frequently on international topics. Recent examples include studies of a workshop for the blind in London, chemical accidents in Bangkok, the social impact of the building code in New Zealand, and the use of biogas in Botswana. International Studies offers the opportunity not only to complete some of the highest quality projects at WPI, but also to offer solutions to some of the most challenging problems in the world.

Students interested in International Studies may ask any member of the Associated Faculty for more information, or they may consult our page on the World Wide Web: <http://www.wpi.edu/+IN/>.

## LAW AND TECHNOLOGY MINOR

As science and technology evolve, there are growing needs for professionals who both understand science and technology and who work within the institutions of the American legal system. At all levels, from federal courts to state regulatory agencies and local planning commissions, policy makers decide issues in an environment of legal rules and principles. Yet to be effective, they must also understand how science and technology can aid their decisions, the methods and conclusions of scientific research, and the social impact of decisions. Without science, environmental regulators cannot decide on measures for hazardous waste disposal, public health officials cannot evaluate

new drug therapies, utility regulators cannot authorize new sources of electric power, judges cannot construe the meaning of medical testimony, and attorneys cannot cross examine an expert witness in a product failure case. Decision makers, and those who attempt to influence them, find that they need to understand science and technology.

The Law and Technology Program is an interdisciplinary minor that can be used to supplement a major, introduce students in science and engineering disciplines to legal studies and prepare students to enter law school upon graduation. Students in the program begin their studies with a foundation in legal institutions and analysis and continue with advanced courses that integrate law and technology. A course in professional communication is also required. Students complete their studies with a capstone research activity either in the sixth course or as a separate independent study.

To attain a Minor in Law and Technology, students must complete two units of study (6 courses) as follows:

1. Two of the following courses in legal fundamentals:
 

HI 2317	Law and Society in America, 1865-1910
GOV 1310	Law, Courts and Politics
GOV 2310	Constitutional Law: Foundations
GOV 2320	Constitutional Law: Civil Rights and Liberties
BUS 2950	Business Law and Ethics
  2. Two of the following courses which integrate law and technology:
 

CE 3022	Legal Aspects in Design and Construction
CE 4071	Land Use Development and Controls
GOV 2302	Science-Technology Policy
GOV 2311	Environmental Policy and Law
GOV 2313	Intellectual Property Law
GOV/ID 2314	Cyberlaw and Policy

 Independent study or experimental courses with the approval of the pre-law advisor
  3. One of the following courses in professional communication:
 

EN/WR 2210	Introduction to Professional Writing
EN/WR 2211	Elements of Writing
EN/WR 3214	Writing About Disease and Public Health
RH 3112	Rhetorical Theory
  4. One of the following courses undertaken as a capstone experience:
 

GOV 2304	Governmental Decision Making and Administrative Law
GOV 2312	International Environmental Policy

 If a student takes both GOV 2304 and GOV 2313, the first one taken will count among courses that integrate law and technology, point 2., above. Minors enrolled in either course for their capstone experience will be required to complete the usual course requirements and an additional research paper. In the paper, the student will summarize existing law in an area of student interest, identify problems with the law, evaluate proposals for change and recommend legislative changes.
- As an alternative, students may complete the capstone requirement as an independent study (IS/P) course with the approval and participation of one of the associated faculty.

Students should review their program of study with the associated faculty and/or pre-law advisor. Students are also encouraged to seek IQP opportunities in Division 52, Law and Technology. See page 18. Note: only one of the two units may be counted toward other college requirements.

For general policy on the Minor, see description on page 12.

## LIBERAL ARTS AND ENGINEERING (BACHELOR OF ARTS DEGREE)

### DIRECTORS: JOHN ORR (ECE), LANCE SCHACHTERLE (HU)

#### ASSOCIATED FACULTY and PROGRAM COMMITTEE:

David DiBiasio (ChE), James Doyle (SSPS), Peter Hansen (HU), Rob Krueger (IGSD), Kent Rissmiller (IGSD and SSPS), D. Samson (HU), Gretar Tryggvason (ME), Richard Vaz (IGSD and ECE)

### MISSION STATEMENT

The goal of the Liberal Arts and Engineering Bachelor of Arts (BA) degree is to provide an opportunity for students who want a broad background in engineering and other disciplines, as preparation for further studies in engineering or in other fields such as medicine, law, public policy, international studies, business, or wherever a solid technical background would give them a unique edge. The program is also designed to allow students to transfer to an engineering BS program with minimum loss of time.

For more information, see the Admissions web site at <http://www.wpi.edu/Academics/Majors/LAE/index.html>.

### PROGRAM EDUCATIONAL OBJECTIVES

The Liberal Arts and Engineering degree recognizes that societal and technological issues are becoming more and more interdependent. Leaders of government, non-profit and for-profit organizations are typically educated in non-engineering disciplines yet increasingly would benefit from a more technological grounding. The Liberal Arts and Engineering major, with its emphasis on problem solving, will prepare students not only for engineering but also for many other high-level careers, such as:

- Law
- Medicine and health care
- Energy policy
- Environmental policy
- Technology policy
- Finance
- Technology management
- International relations
- Public affairs and political service
- Performing arts, especially music and theatre
- Consulting

### PROGRAM OUTCOMES

Graduates of the BA in Liberal Arts and Engineering major will have:

- a) an ability to formulate and solve problems requiring knowledge of both technological and societal/humanistic needs and constraints
- b) an ability to apply, as needed, the relevant fundamentals of mathematics, science, engineering, social sciences, and the humanities to solve such problems
- c) an ability to use the techniques, skills, and modern tools necessary for professional practice
- d) an ability to function on multi-disciplinary teams
- e) an understanding of professional and ethical responsibility

- f) an ability to communicate effectively in oral, written and visual modes
- g) a recognition of the need for, and ability to engage in, life-long learning, in response to the ever-increasing pace of change affecting societal needs and opportunities
- h) the broad education necessary to understand the impact of professional solutions in a societal context, both locally and globally.

## Minimum Distribution Requirements

REQUIREMENTS	MINIMUM UNITS
1. Mathematics and Basic Sciences (Notes 1, 2)	3
2. Engineering Science and Design (Notes 3, 4, 5)	3
3. Humanities and Arts, Social Science, and Management Topics (Notes 6, 7)	3
4. MQP (Note 8)	1

### NOTES:

1. Mathematics must include differential and integral calculus and either probability or statistics.
2. All courses with prefixes BB, CH, PH, or GE count toward this requirement. Must include at least 1/3 Unit each of BB, CH, and PH.
3. Courses with prefixes BME, CE, CHE, CS, ECE, ES, and ME are eligible to count toward this requirement. These courses should be thematically related; students must gain approval of their program of study in this area from the Liberal Arts and Engineering Program Committee.
4. Must include either CS 1101 or CS 1102.
5. Must include at least one course in engineering design (such as ECE 2799 or ME 2300), plus at least two other courses with a significant laboratory component (a list of such courses will be maintained by the Liberal Arts and Engineering Program Committee).
6. Must include 2 Units of Humanities and Arts and Social Science. Courses with prefixes AR, HI, PY, RH, WR, IMGD, ECON, GOV, PSY, STS, and SD may be eligible to count toward this requirement. Courses must be selected from areas that strongly complement the practice of engineering, such as the history of technology, ethics, writing and visual rhetoric, economics, society-technology studies, and environmental studies. A list of such courses will be maintained by the Liberal Arts and Engineering Program Committee.
7. May include up to 1 Unit of Management. All courses with prefixes ACC, BUS, ETR, FIN, MKT, MIS, OIE, and OBC are eligible to count toward this requirement.
8. The MQP provides a capstone experience that builds on both the technical (Engineering Science and Design) and nontechnical (Humanities and Arts, Social Science, and Management Topics) components of the student's particular program. At least one advisor to the MQP must be a member of the Liberal Arts and Engineering Associated Faculty.

### PROGRAMS OF STUDY AND RELEVANT COURSES

The Liberal Arts and Engineering program will offer considerable curricular flexibility to accommodate a wide range of student interests, but at the same time will require students to be intentional about developing a coherent program of study consistent with the program's objectives. Academic advising will play an important role in helping students plan their programs.

For more information and advice about the program, contact Prof. Lance Schachterle at [les@wpi.edu](mailto:les@wpi.edu).

The Engineering Science and Design component of the major (Distribution Requirement 2) must be approved by the Liberal Arts and Engineering Program Committee to ensure that it provides students with a focus in some area of engineering. Guidance and examples will be provided so that students know in advance what types of programs will be approved. The intent is to accommodate creative programs while avoiding programs that lack a coherent theme.

**Table 1: BA in Liberal Arts and Engineering**

15 Units	ECE Design	Energy and Environment	Engineering and Pre-Law
<b>WPI General Education Institutional Requirements (5 Units)</b>			
1 H&A	HU&A of student's choice	HI 1332	HI 2317
2 H&A	HU&A	HI 2324	EN/WR 2211
3 H&A	HU&A	HI 2331	EN/WR 3214
4 H&A	HU&A	HI 2334	EN/WR 3216
5 H&A	HU&A	HI 3331	RH 3112
6 H&A	Sufficiency	Sufficiency	Sufficiency
7 SS	SS	PSY 1402	SOC 1202
8 SS	SS	SS/ID 2050	GOV 1301
9 PE	PE	PE	PE
10 Free Elective	Free Elective	Free Elective	Free Elective
11 Free Elective	Free Elective	Free Elective	Free Elective
12 Free Elective	Free Elective	Free Elective	Free Elective
13 IQP	IQP	IQP	IQP
14 IQP	IQP	IQP	IQP
15 IQP	IQP	IQP	IQP
<b>Mathematics and Science (3 Units)</b>			
16 Math & Science	MA 1021	MA 1021	MA 1021
17 Math & Science	MA 1022	MA 1022	MA 1022
18 Math & Science	MA 1024	MA 1024	MA 1024
19 Math & Science	MA 2051	MA 2051	MA 2051
20 Math & Science	MA 2611	MA 2611	MA 2611
21 Math & Science	CH 1010	CH 1010	CH 1010
22 Math & Science	PH 1110	CH 1020	BB 1035
23 Math & Science	PH 1120	BB 1002	PH 1110
24 Math & Science	BB 1001	PH 1110	PH 1120
<b>Engineering Studies Cornerstone (3 Units)</b>			
<b>Theme</b>	<b>ECE</b>	<b>Energy</b>	<b>Eng Science and Design</b>
25 Engineering Sci/Des	ECE 2011	ES 3001	ES 1020
26 Engineering Sci/Des	ECE 2022	ES 3003	ES 1310
27 Engineering Sci/Des	ECE 2111	ES 3004	ES 2001
28 Engineering Sci/Des	ECE 2311	ES 2501	ES 2501
29 Engineering Sci/Des	ECE 2201	ECE 2011	ES 2502
30 Engineering Sci/Des	ECE 2801	ECE 2111	ES 2503
31 Engineering Sci/Des	ECE 2112	ECE 3501	ES 3003
32 Engineering Sci/Des	ECE 2799 (design)	ME 2300 (design)	ME 2300 (design)
33 Engineering Sci/Des	CS 1101	CS 1101	CS 1101
<b>Liberal Arts Cornerstone (3 Units)</b>			
<b>Theme</b>	<b>Social, Humanistic, Business Factors of Design</b>	<b>Environment and Policy</b>	<b>Pre Law</b>
34 Liberal Studies	PY 2714 Ethics in the Professions	PY 2717 Phil.&Environ.	GOV 1303 American Pub. Policy
35 Liberal Studies	HI 1332 History of Technology	GOV 2311 Ev. Policy & Law	GOV 1310 Law, Courts, Politics
36 Liberal Studies	HI 3331 Topics in Society/Technology Studies	PSY 2405 EV Problems & Human Cognition	GOV 2313 Intellectual Property Law
37 Liberal Studies	STS 2208 Society-Technology Debate	GOV 2312 International EV Policy	GOV 2314 Cyberlaw and Policy
38 Liberal Studies	GOV 2302 Science and Technology Policy	HI 3333 American Tech. Development	GOV 2304 Govt, Decision making and Admin Law
39 Liberal Studies	STS 2209 Conflict and Cooperation in R&D Settings	GOV 2302 Science and Technology Policy	STS 2209 Conflict and Cooperation in R&D Settings
40 Liberal Studies	OIE 2850 Engineering Economics	OIE 2850 Engineering Economics	BUS 2950 Bus Law & Ethics
41 Liberal Studies	BUS 2950 Business Law and Ethics	BUS 2950 Business Law & Ethics	OIE 2850 Eng'g Economics
42 Liberal Studies	ETR 3910 Recognizing and Evaluating New Venture Opportunities	MIS 3720 Bus. Data Mgt	FIN 2250 Financial System of the US
<b>MQP – aimed at confluence of engineering and liberal arts cornerstones (1 Unit)</b>			
43 MQP	MQP	MQP	MQP
44 MQP	MQP	MQP	MQP
45 MQP	MQP	MQP	MQP

The Social and Humanistic Factors component (see Distribution Requirement 3 and Note 6) should consist of courses that complement engineering and technology to support the educational objectives of the program. The Program Committee will maintain and make available to students and advisors lists of current courses that are acceptable for credit toward this requirement.

## MANAGEMENT

**M. C. BANKS, HEAD**

**D. M. STRONG, DIRECTOR MIS PROGRAM**

PROFESSORS: M. C. Banks, M. B. Elmes, A. Gerstenfeld, J. T. O'Connor, H. G. Vassallo

ASSOCIATE PROFESSORS: E. Danneels, H. N. Higgins, S. A. Johnson, C. J. Kasouf, E. Loiacano, D. M. Strong, A. Zeng, J. Zhu

ASSISTANT PROFESSORS: S. Djamasbi, F. Miller, K. Mukherjee, S. Taylor, B. Tulu, W. Zhao

VISITING FACULTY: J. Schaufeld

### MISSION STATEMENT

The Department of Management at WPI is committed to providing education, research, and outreach that focus on:

- leading and managing technology-based organizations;
- integrating technology into the workplace; and
- creating new processes, products, services, and organizations based on technology.

We emphasize:

- innovative and project-based education that integrates the theory and the practice of management, and prepares students to assume positions of leadership in an increasingly global business environment;
- basic scholarship, while also valuing the scholarship of application and the scholarship of instruction; and
- interaction with the business community focused primarily on technological entrepreneurship.

### COURSE AREAS

The Department of Management has recently changed its course prefixes from either MG or MG/IE to prefixes that more accurately reflect the course area. They are:

<b>ACC</b>	Accounting
<b>BUS</b>	Business
<b>ETR</b>	Entrepreneurship
<b>FIN</b>	Finance
<b>MIS</b>	Management Information Systems
<b>MKT</b>	Marketing
<b>OIE</b>	Operations & Industrial Engineering
<b>OBC</b>	Organizational Behavior and Change

## MANAGEMENT (MG)

### PROGRAM EDUCATIONAL OBJECTIVES

Objectives of the Management Major are:

To prepare students for management roles in technology based organizations.

Through a flexible curriculum, to provide a solid, broad base of business knowledge and the written communication, oral presentation, decision-making, and leadership skills necessary to succeed in a technology based environment.

To develop student abilities necessary for continued career growth including:

- the ability to integrate theory and practice;
- the ability to integrate technology and change into existing organizations;
- the ability to think critically and analytically, to define and solve business problems, work in teams, and think globally; and
- the ability to learn new skills in response to changing professional requirements.

### Program Distribution Requirements for the Management Major

REQUIREMENTS (NOTE 1)	MINIMUM UNITS
1. Management Foundation (Note 2)	11/3
2. Mathematics (Note 3)	4/3
3. Basic Science	2/3
4. Management Major (Note 4)	6/3
5. Breadth Electives (Note 5)	3/3
6. Computer Science (Note 6)	1/3
7. MG MQP	3/3

#### NOTES:

1. Courses may not be counted more than once in meeting these distribution requirements. The total number of units taken in the Department of Management may not exceed 50% of the total number of units earned for the degree.
2. The Management Foundation must cover the foundation knowledge in the management functional areas, including at least 1/3 unit of financial accounting, managerial accounting, financial management, organizational science, deterministic management science, operations management, marketing management, information systems management, and business law and ethics. Microeconomics and Macroeconomics are required and also fulfill the WPI Social Science requirement.
3. Mathematics must include 2/3 units of calculus and 2/3 units of statistics.
4. Students selecting the Management Major must complete six courses from at most three (3) course clusters as specified on the department's website (<http://www.mgt.wpi.edu/Undergraduate/mgtcur.html>) or work with their academic advisor to create a custom MG Program that includes courses in the specified clusters and/or other areas of Humanities & Arts and Social Sciences & Policy Studies. Such custom programs must be approved by the advisor and the Department of Management's Undergraduate Policy & Curriculum Committee.
5. Breadth Electives must include at least 1/3 unit from among the 3000- and 4000-level courses in the Department. The remaining 2/3 units specified in the requirement may be satisfied with courses from Mathematics, Basic Science, Computer Science, Social Science, or courses with any of the following prefixes: ACC, BUS, ETR, FIN, MIS, MKT, OBC, or OIE, but excluding courses FIN 1250 and OIE 2850.
6. A minimum of 1/3 unit of Computer Science (except CS 2022 and CS 3043). Either CS 1101 or CS 1102 is recommended.



## MANAGEMENT ENGINEERING (MGE)

### EDUCATIONAL PROGRAM OBJECTIVES

Objectives of the Management Engineering Major are:

To prepare students for management challenges in key areas that increasingly require proficiency in the technical aspects of business such as production and service operations.

To provide the knowledge and skills necessary to succeed professionally, including literacy in a technical field, a broad understanding of management issues, written communication, oral presentation, decision-making, and leadership skills required to create new and improved products, processes and control systems.

To develop student abilities necessary for continued career growth including:

- the ability to integrate theory and practice and to apply knowledge of technical issues with the foundations of management;
- the ability to integrate technology and change into existing organizations;
- the ability to think critically and analytically, to define and solve business problems, work in teams, and think globally; and
- the ability to learn new skills in response to changing professional requirements.

### Program Distribution Requirements for the Management Engineering Major

REQUIREMENTS (NOTE 1)	MINIMUM UNITS
1. Management Foundation (Note 2)	11/3
2. Mathematics (Note 3)	4/3
3. Basic Science	2/3
4. Management Engineering Major (Note 4)	6/3
5. Breadth Electives (Note 5)	3/3
6. Computer Science (Note 6)	1/3
7. MGE MQP	3/3

#### NOTES:

1. Courses may not be counted more than once in meeting these distribution requirements. The total number of units taken in the Department of Management may not exceed 50% of the total number of units earned for the degree.
2. The Management Foundation must cover the foundation knowledge in the management functional areas, including at least 1/3 unit of financial accounting, managerial accounting, financial management, organizational science, deterministic management science, operations management, marketing management, information systems management, and business law and ethics. Microeconomics and Macroeconomics are required and also fulfill the WPI Social Science requirement.
3. Mathematics must include 2/3 units of calculus and 2/3 units of statistics.
4. Students selecting the Management Engineering Major must complete six courses from one of the concentrations as specified on the Department's website (<http://www.mgt.wpi.edu/Undergraduate/mgtcur.html>) or work with their academic advisor to create a custom MGE Program. Such custom programs must be approved by the advisor and the Department of Management's Undergraduate Policy & Curriculum Committee.
5. Breadth Electives must include at least 1/3 unit from among the 3000- and 4000-level courses in the Department. The remaining 2/3 units specified in the requirement may be satisfied with courses from Mathematics, Basic Science, Computer Science, Social Science, or courses with any of the following prefixes: ACC, BUS, ETR, FIN, MIS, MKT, OBC, or OIE, but excluding courses FIN 1250 and OIE 2850.
6. A minimum of 1/3 unit of Computer Science (except CS 2022 and CS 3043). Either CS 1101 or CS 1102 is recommended.

## MANAGEMENT INFORMATION SYSTEMS (MIS)

### EDUCATIONAL PROGRAM OBJECTIVES

The objectives of the Management Information Systems Major are:

To prepare students for positions involving the design and deployment of business applications using a wide variety of advanced information technologies, especially in high technology business, consulting, and service firms, in either start-up or established environments, and to prepare students for rapid advancement to project management and other management positions.

To provide the knowledge and skills consistent with the professionally accepted IS curriculum guidelines. Specifically, this includes providing knowledge and skills related to:

- business application development tools;
- database, web-based and networked applications;
- integrating IT into existing organizations through managing and leading systems analysis and design projects;
- communicating effectively via written and oral presentations.

To develop student abilities necessary for continued career growth including:

- the ability to integrate theory and practice and to apply knowledge of information technology issues with the foundations of management;
- the ability to integrate technology and change into existing organizations;
- the ability to think critically and analytically, to define and solve business problems, work in teams, and think globally; and
- the ability to learn new skills in response to changing professional requirements.

### Program Distribution Requirements for the Management Information Systems Major

REQUIREMENTS (NOTE 1)	MINIMUM UNITS
1. Management Foundation (Note 2)	11/3
2. Mathematics (Note 3)	4/3
3. Basic Science	2/3
4. Management Information Systems Major (Note 4)	6/3
5. Breadth Electives (Note 5)	3/3
6. Computer Science (Note 6)	1/3
7. MIS MQP	3/3

#### NOTES:

1. Courses may not be counted more than once in meeting these distribution requirements. The total number of units taken in the Department of Management may not exceed 50% of the total number of units earned for the degree.
2. The Management Foundation must cover the foundation knowledge in the management functional areas, including at least 1/3 unit of financial accounting, managerial accounting, financial management, organizational science, deterministic management science, operations management, marketing management, information systems management, and business law and ethics. Microeconomics and Macroeconomics are required and also fulfill the WPI Social Science requirement.
3. Mathematics must include 2/3 units of calculus and 2/3 units of statistics.

4. Students selecting the Management Information Systems Major must complete six courses as specified on the Department's website (<http://www.mgt.wpi.edu/Undergraduate/mgtcur.html>) or work with their academic advisor to create a custom MIS Program. Such custom programs must be approved by the advisor and the Department of Management's Undergraduate Policy & Curriculum Committee.
5. Breadth Electives must include at least 1/3 unit from among the 3000- and 4000-level courses in the Department. The remaining 2/3 units specified in the requirement may be satisfied with courses from Mathematics, Basic Science, Computer Science, Social Science, or courses with any of the following prefixes: ACC, BUS, ETR, FIN, MIS, MKT, OBC, or OIE, but excluding courses FIN 1250 and OIE 2850.
6. A minimum of 1/3 unit of Computer Science (except CS 2022 and CS 3043). Either CS 1101 or CS 1102 is recommended.

## ENTREPRENEURSHIP MINOR

All around the world people are starting their own new business ventures. With its strong heritage of invention and entrepreneurship among students and faculty members, WPI is committed to encouraging its students to consider that career path. Our dream is that our students will earn a minor in Entrepreneurship, which will provide them with some basic business skills and an understanding of what it takes to start a business, then they will create a new and exciting technology as their MQP that they will then turn into a business upon graduation. Related opportunities include the Robert H. Grant Invention Awards, the Henry Strage Innovation Awards, the CEI @ WPI ALL-OUT Business Plan Competition, the WPI Dinner with Entrepreneurs Series, the WPI chapter of CEO (Collegiate Entrepreneurs Organization), several conferences, many workshops, the monthly WPI Venture Forum meetings, a variety of speakers and other events related to entrepreneurship, and access to a wide network of entrepreneurs from around the U.S. and abroad.

The Minor in Entrepreneurship is available to all students except those majoring in MG, MGE, or MIS, who may take the courses as part of their major or as Breadth or Free Electives.

The minor requires the completion of two units of coursework as noted below.

1. Complete the following course:  
OIE 2850 Engineering Economics
2. Complete two (2) from the following list:  
ACC 1100 Financial Accounting OR  
ACC 2101 Management Accounting  
BUS 2950 Business Law & Ethics  
OIE 3400 Production System Design  
MKT 3600 Marketing Management  
MIS 3700 Information Systems Management
3. Complete the following three courses, preferably in order:  
ETR 3910 Identifying & Evaluating New Venture Opportunities  
ETR 3920 Planning & Launching New Ventures  
ETR 4930 Growing and Managing New Ventures

As noted above, students majoring in MG, MGE, or MIS may not minor in Entrepreneurship.

For general policy on the Minor, see the description on page 12.

## MANAGEMENT MINOR

Everyone needs management skills. If engineers, scientists, and others hope to advance in their careers, they must learn how to lead projects and manage groups. The Management Minor offers students (other than MG, MGE, or MIS majors, who may take the courses as part of their major or as Breadth or Free Electives, as appropriate) the opportunity to learn some of the theory and practice of managing in organizations with material on management concepts and practices commonly encountered in the business world. This program will help students make a transition to the business world and will provide basic skills for operating effectively in business organizations.

To complete the Management Minor, a student must complete two units of work in the Management Area, typically through course work with the following distribution:

1. One course from the Social Science Economics area.  
Any course with course designation ECON#1## will qualify.
2. ACC 1100, Financial Accounting
3. OBC 2300, Organizational Science I
4. Either MKT 3600, Marketing Management, or MKT 3651, Industrial Marketing
5. Select one (1) from the following group:
  - a. ACC 2101, Managerial Accounting
  - b. FIN 2200, Financial Management
  - c. OBC 3351, Organizational Science – Management of Change
  - d. OIE 3400, Production System Design
  - e. MKT 3640, Management of Process and Product Innovation
  - f. MIS 3700, Information Systems Management
  - g. OBC 4365, Leadership in Groups and Organizations
6. Capstone Experience ETR 4930, Growing and Managing New Ventures

As noted above, students majoring in MG, MGE, or MIS may not minor in Management.

For general policy on the Minor, see the description on page 12.

## MIS MINOR

Information technology has been the driving force behind the new way of doing business. It has enabled companies to make tremendous strides in productivity, it has opened new markets and new channels, and it has created new product and service opportunities. While one part of the information revolution has been advances in hardware, and another has been advances in software, a third major advance has been in the systems-side of information, or how information is organized and used to make effective decisions. That is Management Information Systems (MIS). The Minor in MIS offers students (other than MG, MGE, or MIS majors, who may take the courses as part of their major or as Breadth or Free Electives, as appropriate) the opportunity to broaden their disciplinary program with material and skills widely useful in the business world. This program will help students to broaden their exposure to information technology and its use in business and industry.

To complete the Management Information Systems Minor, a student must complete two units of work with the following distribution:

1. One course from the group of courses:
  - BUS 1900 Introduction to Business in an International Environment OR
  - ACC 1100 Financial Accounting OR
  - ACC 2101 Management Accounting OR
  - OBC 2300 Organizational Science
2. Two courses, or their equivalents, from the following list:
  - CS 1101 Introduction to Program Design OR
  - CS 1102 Accelerated Introduction to Program Design
  - CS 2118 Object-Oriented Design Concepts for Business Applications
  - CS 2301 Systems Programming for Non-Majors OR
  - CS 2303 Systems Programming Concepts
3. Two courses from the group of courses:
  - MIS 3700 Information Systems Management
  - MIS 3720 Management of Data
  - MIS 3740 Organizational Application of Telecommunications
4. Capstone Experience
  - MIS 4720: Systems Analysis and Design

Course MIS 4720 is a project-oriented course designed to prepare MIS students and minors for actual information systems design work in business and industry. The course builds and uses MIS concepts for the sound and efficient design of information systems.

Students majoring in MG, MGE, or MIS may not take the MIS Minor.

For general policy of the Minor, see the description on page 12.

## ORGANIZATIONAL LEADERSHIP MINOR

One of the critical elements for any person who hopes to succeed in a formal organization is leadership. While some people come by their organizational leadership abilities instinctively or by learning from others at an early age, many others come late to their leadership talents and still others never realize their leadership abilities. It is the purpose of the Department of Management's Organizational Leadership minor to provide students with the theoretical underpinnings of leadership and, in keeping with a WPI education, the knowledge of how that theory applies to practice. Thus, through this minor students will be able to understand and apply leadership theories to their lives and, in the process, make themselves more marketable upon graduation.

The minor in Organizational Leadership consists of three primary components. These components are a choice of Management courses, a choice among three Social Science & Policy Studies courses, and a capstone course in Leadership.

1. Select four of the following:
  - BUS 1900 Introduction to Business in an International Environment
  - OBC 2300 Organizational Science - Foundation
  - BUS 2950 Business Law & Ethics
  - OBC 3351 Organizational Science - Management of Change
  - OBC 4364 Human Resource Management
2. Select one of the following:
  - PSY 1401 Cognitive Psychology
  - PSY 1402 Social Psychology
  - PSY 2406 Cross-Cultural Psychology: Human Behavior in Global Perspective

3. Required Capstone Experience
  - OBC 4365 Leadership in Groups and Organizations

Note: The minor in Organizational Leadership may not be taken by students majoring in MG, MGE, or MIS. These students may take the courses as part of their major or as Breadth or Free Electives, as appropriate.

For general policy on the Minor, see the description on page 12.

## MANUFACTURING ENGINEERING

**DIRECTOR: R. D. SISSON**

**ASSOCIATE DIRECTOR: Y. RONG**

**PROFESSORS:** D. Apelian, I. Bar-On, C. A. Brown, Y. Rong, R. D. Sisson, J. M. Sullivan, Jr., M. M. Makhoul

**ASSOCIATE PROFESSORS:** M. Fofana, S. Johnson, F. Noonan, A. Zeng

**RESEARCH PROFESSOR:** R. Katz

**LECTURERS:** P. D. Cotoir, K. Stafford

### MISSION STATEMENT

The mission of WPI's Manufacturing Engineering Program:

Provide an outstanding Manufacturing Engineering education that realizes students' visions, fulfills industry needs, and produces future leaders.

### PROGRAM EDUCATIONAL OBJECTIVES

- Graduates should have the knowledge and skills to design and enact solutions for complex, dynamic manufacturing engineering problems faced by industry and society, using current concepts and technology
- Graduates should be able to communicate effectively, both orally and in writing, using electronic tools and graphical representations
- Graduates should be able to serve and lead the organizations that employ them, with good interpersonal and teamwork skills and with an understanding of professional ethical responsibility, and national and global contemporary issues

### Program Distribution Requirements for the Manufacturing Engineering Major

The normal period of residency at WPI is 16 terms. In addition to WPI requirements applicable to all students, students wishing to receive the degree designated "Manufacturing Engineering" must satisfy certain distribution requirements:

REQUIREMENTS	MINIMUM UNITS
1. Mathematics and Basic Science (Notes 1,2)	4
2. Engineering Science and Design (including the MQP) (Note 3,4)	6

#### NOTES:

1. Mathematics must include differential and integral calculus and differential equations.
2. Science must include both chemistry and physics with a minimum of two courses in either.
3. At least one unit from each of the following areas is required:
  - A. Materials and Processes
  - B. Product Engineering
  - C. Computer Control and Manufacturing Systems
  - D. Production Systems Engineering
4. Must include 1/3 unit of Capstone Design Experience.

**MANUFACTURING ENGINEERING PROGRAM CHART**

BACKGROUND

4 Units

MATHEMATICS	**SCIENCE
*MA 1021	CH 1010
*MA 1022	CH 1020
*MA 1023	PH 1110
*MA 1024	PH 1120
*MA 2051	PH 1130
MA 2071	PH 1140
MA 2611	BB 1001
MA 2612	BB 1002
MA 2621	
MA 3831	
MA 3832	
MA 4631	

\*\* Mathematics requirements include differential and integral calculus and ordinary differential equations. Additional work is strongly encouraged in one or more of the subjects of probability and statistics, linear algebra, and numerical analysis.

\*\* Science requirements include chemistry and physics with at least a two course sequence in either.

2/3 Units

<b>SOCIAL SCIENCE</b>
see page 159

2 Units

<b>HUMANITIES &amp; ARTS</b>
see page 128

1 Unit

<b>INTERACTIVE QUALIFYING PROJECT (IQP)</b>
see page 17

1 Unit

<b>FREE ELECTIVE</b>
Refer to catalog

1/3 Unit

<b>PHYSICAL EDUCATION</b>
see page 155

6 Units (Divided approximately 2:1 between Engineering Science: Design)

MANUFACTURING ENGINEERING

One unit per area required

Electives

1 Unit	1 Unit	1 Unit	1 Unit
<b>MATERIALS &amp; PROCESSES</b>	<b>PRODUCT ENGINEERING AND TOOL DESIGN</b>	<b>COMPUTER CONTROL &amp; MANUFACTURING SYSTEMS</b>	<b>PRODUCTION SYSTEMS ENGINEERING</b>
ES 2001 ME 1800 ME 2820 ME 4821  ME 3023 ME 3811 ME 4813 ME/BME 4814 ME 4816 ME 4822 MFE 520	ES 2501 ES 2502 ES 2503 ME 3320  ES 1310 ES 3323 ME 3310 ME 3311 ME 3321 ME 4320 MFE 540	ECE 3601 ES 3011 ME 3820 ME 4815  ECE 2011 CS 2301 CS 3013 CS 3431 CS 4032/MA 3257 CS 4033/MA 3457 MFE 510 MFE 530	OIE 2850 OIE 3400 OIE 3401 OIE 3420  OIE 2500 OIE 3405 OIE 3450 OIE 3460 OIE 3501 OIE 4460
<b>1 Unit Emphasizing Design</b>			
<b>MAJOR QUALIFYING PROJECT (MQP)</b>			

## MANUFACTURING ENGINEERING MINOR

A minor in Manufacturing Engineering gives students from a variety of majors the opportunity to strengthen their academic preparation and attractiveness to industry, while better preparing them to solve many of the problems that will challenge them in their careers. Most engineers are involved directly or indirectly with manufacturing or manufacturing principles. Manufacturing expertise is essential to all industrialized, developing and even post industrialized societies. The objective of the minor in manufacturing will be to give the students a solid understanding of the principles of production, processing, manufacturability, and quality that can be applied to a wide variety of products, including non-traditional products, such as software, service and information.

The minor requires the completion of 2 units of work as follows.

- I. 1 unit of required course work selected from the following list:
 

ME 1800	Material Selection and Manufacturing Processes
ME 2820	Materials Processing
ME 3820	Computer-Aided Manufacturing
ES 3011	Control Engineering I
- II. 2/3 unit of electives, selected from the following list of courses:
 

_____	any of the courses above, in I., can count if the other three are completed.
CS 4032/MA 3257	Numerical Methods for Linear and Nonlinear Systems
CS 4341	Introduction to Artificial Intelligence
ES 3323	Advanced Computer Aided Design
ME 3310	Kinematics of Mechanisms
ME 4530	Computational Methods in Mechanical Engineering
ME/RBE 4815	Industrial Robotics
ME 4821	Chemistry, Properties and Processing of Plastic
OIE 3400	Production System Design
OIE 3420	Quality Planning, Design and Control
MFE 510	Control and Monitoring of Manufacturing Processes
MFE 511	Application of Industrial Robotics
MFE 520	Design and Analysis of Manufacturing Processes
MFE 530	Computer Integrated Manufacturing
MFE 540	Design for Manufacturability
- III. 1/3 unit of capstone experience:
 

ME 4815	Industrial Robotics
MFE 598	Independent Study Project (this must be approved by the MFE minor program committee)
MFE 510	Control and Monitoring of Manufacturing Processes
MFE 511	Application of Industrial Robotics
MFE 520	Design and Analysis of Manufacturing processes
MFE 530	Computer Integrated Manufacturing
MFE 540	Design for Manufacturability

## MATERIALS ENGINEERING

Courses and programs of study in materials engineering are included in the Mechanical Engineering Department (page 88). For advisory information, consult that section of the Undergraduate Catalog or members of the materials section of Mechanical Engineering.

## MINOR IN MATERIALS

Material properties, material processing issues, or material costs are the limiting factor in the design or performance of almost all systems around us. Engineers, scientists, and managers in all technological sectors often must make material selection decisions based on a variety of considerations, including properties, performance, environmental impact, and cost. A Minor in Materials, feasible within a 15 unit program of study, will benefit students who wish to enhance their disciplinary major with an additional degree designation in the area of materials.

### REQUIREMENTS FOR THE MATERIALS MINOR:

The minor requires the completion of 2 units of work as described below:

1. ES 2001 Introduction to Material Science (1/3 unit)
2. 1-1/3 units of electives, selected from the following list of courses <sup>b,c</sup>:
 

CE 3026	Materials of Construction
CH 3410	Principles of Inorganic Chemistry
CH 2310	Organic Chemistry I
CH 2320	Organic Chemistry II
CH 2330	Organic Chemistry III
CH 4330	Organic Synthesis
CH 4550	Polymer Chemistry
CHE 3601	Chemical Materials Engineering
ECE 3901	Semiconductor Devices
ME 2820	Materials Processing
ME 3801	Experimental Methods in Materials Science & Engineering
ME 4718	Advanced Materials with Aerospace Applications
ME 4810	Automotive Materials and Process Design
ME 4813	Ceramics and Glasses for Engineering Applications
ME/BME 4814	Biomaterials
ME 4821	Plastics
ME 4832	Corrosion and Corrosion Control
ME 4840	Physical Metallurgy
ME 4860	Food Engineering
ME 4875	Introduction to Nanomaterials and Nanotechnology
PH 3502	Solid State Physics

Students who are able to design their undergraduate program of study such that they have sufficient preparation may also use the following graduate courses toward a Materials Minor: all MTE graduate courses; CHE 508, Catalysis and Surface Science of Materials; CHE 510, Particulate Systems.

## 3. Capstone Experience (1/3 unit)

The capstone experience requirement for the Minor in Materials must be satisfied by an upper level course or IS/P activity that integrates and synthesizes material processing, structure, and property relationships as they affect performance.

- i) Courses that satisfy the capstone experience requirement currently include ME 4810, ME 4813, ME 4814, and ME 4821. Other courses must be approved in advance by the Program Committee for the Minor in Materials.
- ii) Students may satisfy the capstone experience requirement by completing a 1/3 unit IS/P that receives prior approval from the Program Committee for the Minor in Materials. The IS/P may, for example, take the form of a laboratory experience or may augment the MQP or IQP, considering in depth the materials issues associated with the project topic (see Note d). An IS/P related to the MQP must be distinct from the core 1 unit of the MQP and in most cases would be advised by a faculty member other than the MQP advisor.

**NOTES:**

- a. In accordance with the Institute-wide policy on Minors, academic activities used in satisfying the regular degree requirements may be double-counted toward meeting all but one unit of the Minor requirements (see page 12).
- b. Physics IS/P courses in Superconductors, Photonics, and Lasers may also be counted toward the Materials Minor. In addition, other new or experimental course offerings in the materials area may be approved by the Materials Minor Program Review Committee.
- c. Examples: An ECE major designing an integrated circuit for her MQP might conduct a separate analysis of the materials issues related to heat management in the device as the capstone experience for the Minor in Materials; a ME major specifying a gear in a design MQP might conduct a separate analysis of the material processing, structure, and property issues affecting fatigue life of the gear.
- d. In accordance with the Institute-wide policy on Minors, the Major Qualifying Project (MQP) cannot be counted toward activity for a Minor. Therefore, a ME, CHE, or any other major whose MQP is judged to be predominantly in the materials area by the Program Review Committee may not count an extra 1/3 unit augmentation of their MQP as their capstone experience in the Minor.
- e. The following faculty serve as the Program Review Committee for the Minor in Materials and will serve as Minor Advisors: Richard Sisson (ME), Chrys Demetry (ME), Tahar El-Korchi (CEE).

---

## MATHEMATICAL SCIENCES

---

**B. VERNESCU, HEAD; S. WEEKES, ASSOCIATE HEAD**

PROFESSORS: P. Christopher, P. Davis, A. Heinricher, M. Humi, R. Lui, K. Lurie, U. Mosco, B. Nandram, J. Petruccelli, B. Servatius, D. Tang, B. Vernescu, H. Walker

ASSOCIATE PROFESSORS: W. Farr, J. Fehribach, C. Larsen, T. Luo, W. Martin, M. Sarkis, D. Vermes, S. Weekes

ASSISTANT PROFESSORS: R. Kim, H. Sayit, D. Volkov, J. Wilbur

VISITING FACULTY: M. Blais, C. Burgos, V. Hryniv, C. Lee, J. Masamune, V. Yakovlev

ACADEMIC STAFF: J. Abraham, J. Goulet

**MISSION STATEMENT**

Recognizing the vital role of the mathematical sciences in today's society, the Mathematical Sciences Department provides leading-edge programs in education, research, and professional training in applied and computational mathematics and statistics. These programs are enhanced and distinguished by project-oriented education and collaborative involvement with industry, national research centers, and the international academic community.

**PROGRAM EDUCATIONAL OBJECTIVES**

The department's major programs provide students with preparation for effective and successful professional careers in the mathematical sciences, whether in traditional academic pursuits or in the many new career areas available in today's technologically sophisticated, globally interdependent society. Through course work, students acquire a firm grounding in fundamental mathematics and selected areas of emphasis. Projects, which often involve interdisciplinary and industrial applications, offer further opportunities to gain mathematical depth and to develop skills in problem-solving, communication, teamwork, and self-directed learning, together with an understanding of the role of the mathematical sciences in the contemporary world.

**PROGRAM OUTCOMES**

We expect graduates to:

1. have a solid knowledge of a broad range of mathematical principles and techniques and the ability to apply them.
2. be able to read, write, and communicate mathematics inside and outside the discipline.
3. have the ability to formulate mathematical statements and prove or disprove them.
4. be able to formulate and investigate mathematical questions and conjectures.
5. understand fundamental axiom systems and essential definitions and theorems.
6. be able to formulate and analyze mathematical or statistical models.
7. have the ability to apply appropriate computational technology to analyze and solve mathematical problems.
8. be able to learn independently and as part of a team, and to demonstrate a depth of knowledge in at least one area of the mathematical sciences.

The Department of Mathematical Sciences at WPI offers:

- i) the Bachelor of Science degree in Mathematical Sciences;
- ii) the Bachelor of Science degree in Actuarial Mathematics;
- iii) a Minor in Mathematics;
- iv) a Minor in Statistics;
- v) a combined B.S./M.S. degree in Applied Mathematics, Applied Statistics, Industrial Mathematics, or Financial Mathematics.

### Program Distribution Requirements for the Mathematical Sciences Major

The normal period of residency at WPI is 16 terms. In addition to the WPI requirements applicable to all students, completion of a minimum of 10 units of study is required as follows:

REQUIREMENTS	MINIMUM UNITS
1. Mathematics including MQP (See notes 1-4).	7
2. Courses from other departments that are related to the student's mathematical program. At least 2/3 unit in computer science must be included; the remaining courses are to be selected from science, engineering, computer science or management (except MG 1250) (see Note 5).	2
3. Additional courses or independent studies (except MS, PE courses, and other degree requirements) from any area.	1

**NOTES:**

- 1. Must include MA 3831-3832, or their equivalents, at least one of MA 3257, MA 3457, or equivalent, and at least one of MA 3823, MA 3825, or equivalent.
- 2. Must include at least three of the following: MA 2073, MA 2271, MA 2273, MA 2431, MA 2631, or their equivalents.
- 3. At least 7/3 units must consist of MA courses at the 3000 level or above.
- 4. May not include both MA 2631 and MA 2621.
- 5. May not include both CS 3043 and CS 2022.

### PROGRAM IN MATHEMATICAL SCIENCES

**PROJECTS**

Some of the most active career directions in the mathematical sciences are reflected in the MQP areas around which the department's offerings are organized: Algebraic and Discrete Mathematics, Computational and Applied Analysis, Operations Research, and Probability and Statistics. As early as practical, and certainly no later than the sophomore year, the mathematical sciences major should begin exploring these different areas. The transition courses, MA 2073, 2271, 2273, 2431, and 2631, are specifically designed to introduce the four MQP areas while preparing the student for advanced courses and the MQP. Students should talk to faculty in the student's area of interest to develop and select an MQP and MQP advisor.

While most students choose MQPs in one of the four areas mentioned above, it is possible to design an MQP that does not fit into any one area. In such cases, students will want to take special care to plan their programs carefully with their advisors so that sufficient background is obtained before beginning to do research. Independent studies are a good way for students to learn topics that are not taught in regularly-scheduled courses. Interested students should approach faculty with requests for independent studies.

Through the Center for Industrial Mathematics and Statistics (CIMS), students can use their mathematics and statistics training to work on real-world problems that come from sponsors in industry and finance. More information about industrial MQPs and projects can be found at <http://www.wpi.edu/+CIMS>.

In what follows, you will find for each MQP area:

- A brief description of the area including the kinds of challenges likely to be encountered by MQP students and mathematical scientists working there.
- Courses of interest.

**ALGEBRAIC AND DISCRETE MATHEMATICS**

Algebraic and discrete mathematics is recognized as an increasingly important and vital area of mathematics. Many of the fundamental ideas of discrete mathematics play an important role in formulating and solving problems in a variety of fields ranging from ecology to computer science. For instance, graph theory has been used to study competition of species in ecosystems, to schedule traffic lights at an intersection, and to synchronize parallel processors in a computer. Coding theory has been applied to problems from the private and public sectors where encoding and decoding information securely is the goal. In turn, the problems to which discrete mathematics is applied often yield new and interesting mathematical questions. The goal of a project in discrete mathematics would be to experience this interaction between theory and application. To begin, a typical project team would assess the current state of a problem and the theory that is relevant. Once this is done, the project team's objective would be to make a contribution to solving the problem by developing new mathematical results.

In working in discrete mathematics, one may be writing algorithms, using the computer as a modeling tool, and using the computer to test conjectures. It is important that a student interested in this area have some computer proficiency. Depending on the project, an understanding of algorithm analysis and computational complexity may be helpful.

**Courses of Interest**

MA 2271	Graph Theory
MA 2273	Combinatorics
MA 3231	Linear Programming
MA 3233	Discrete Optimization
MA 3823	Group Theory
MA 3825	Rings and Fields
MA 4891	Topics in Mathematics (when appropriate)
CS 2301	Systems Programming for Non-Majors
CS 4120	Analysis of Algorithms
CS 4123	Theory of Computation

**COMPUTATIONAL AND APPLIED ANALYSIS**

This area of mathematics concerns the modeling and analysis of continuous physical or biological processes that occur frequently in science and engineering. Students interested in this area should have a solid background in analysis which includes the ability to analyze ordinary and partial differential equations through both analytical and computational means.

In most circumstances, an applied mathematician does not work alone but is part of a team consisting of scientists and engineers. The mathematician's responsibility is to formulate a mathematical model from the problem, analyze the model, and then interpret the results in light of the experimental evidence.

## 84 MATHEMATICAL SCIENCES

It is, therefore, important for students to have some experience in mathematical modeling and secure a background in one branch of science or engineering through a carefully planned sequence of courses outside of the department.

With the increase in computational power, many models previously too complicated to be solvable, can now be solved numerically. It is, therefore, recommended that students acquire enough computer proficiency to take advantage of this. Computational skill is growing in importance and should be a part of every applied mathematician's training. Students may learn these skills through various numerical analysis courses offered by the department. An MQP in this area will generally involve the modeling of a real-life problem, analyzing it, and solving it numerically.

### Courses of Interest

MA 2251	Vector and Tensor Calculus
MA 2431	Mathematical Modeling with Ordinary Differential Equations
MA 3231	Linear Programming

MA 3257	Numerical Methods for Linear and Nonlinear Systems
MA 3457	Numerical Methods for Calculus and Differential Equations
MA 3471	Advanced Ordinary Differential Equations
MA 3475	Calculus of Variations
MA 4235	Mathematical Optimization
MA 4291	Applicable Complex Variables
MA 4411	Numerical Analysis of Differential Equations
MA 4451	Boundary Value Problems
MA 4473	Partial Differential Equations

### OPERATIONS RESEARCH

Operations research is an area of mathematics which seeks to solve complex problems that arise in conducting and coordinating the operations of modern industry and government. Typically, operations research looks for the best or optimal solutions to a given problem. Problems within the scope of operations research methods are as diverse as finding the lowest cost school bus routing that still satisfies racial guidelines, deciding whether to build a small plant or a large plant when

## MATHEMATICAL SCIENCES MAJOR PROGRAM CHART

UNIVERSITY REQUIREMENTS	
Minimum Academic Credit	15 Units
Residency	8 Units
Humanities and Arts	2 Units
Interactive Qualifying Project	1 Unit
Major Qualifying Project	1 Unit
Social Science	2/3 Unit
Physical Education	1/3 Unit

### FOUNDATION COURSES

INTRODUCTORY COURSES	TRANSITION COURSES (1 Unit Required)	CORE COURSES (4/3 Unit Required)
MA 1021-1024 or MA 1031-1034 MA 2051 MA 2071 MA 2201 MA 2251 MA 2611	MA 2073 MA 2271* MA 2273* MA 2431 MA 2631	Both MA 3831 and MA 3832 One of MA 3257 or MA 3457 One of MA 3823* or MA 3825*

### OTHER MA COURSES TO ATTAIN TOTAL OF 6 UNITS:

ACTUARIAL MATH	ANALYSIS	ALGEBRA	DISCRETE MATH	COMPUTATIONAL MATH	OPERATIONS RESEARCH	STATISTICS/PROBABILITY
MA 3211 MA 3212 MA 4213* MA 4214*	MA 2431 MA 3471* MA 3475* MA 4291 MA 4451 MA 4473*	MA 2073 MA 3823* MA 3825*	MA 2271* MA 2273* MA 3233*	MA 3257 MA 3457 MA 4411*	MA 3231 MA 3233* MA 4235* MA 4237*	MA 2612 MA 2621 MA 2631 MA 3627* MA 3631 MA 4214* MA 4631 MA 4632 MA 4658

OTHER REQUIREMENTS	
Computer Science Courses	2/3 Unit

\* Category II courses, offered in alternating years.



demand is uncertain, or determining how best to allocate timesharing access in a computer network.

Typically, these problems are solved by creating and then analyzing a mathematical model to determine an optimal strategy for the organization to follow. Often the problem requires a statistical model, and nearly always the analysis - whether optimizing through a set of equations or simulating the behavior of a process - involves the use of a computer. Finally, operations researchers must be able to interpret and apply the results of their analyses in an appropriate manner.

In addition to a solid background in calculus, probability and statistics, and the various operations research areas, prospective operations researchers should be familiar with computer programming and managerial techniques.

**Courses of Interest**

- MA 2271 Graph Theory
- MA 2273 Combinatorics
- MA 3231 Linear Programming
- MA 3233 Discrete Optimization
- MA 3627 Applied Statistics III
- MA 3631 Mathematical Statistics
- MA 4235 Mathematical Optimization
- MA 4237 Probabilistic Methods in Operations Research
- MA 4631 Probability and Mathematical Statistics I
- MA 4632 Probability and Mathematical Statistics II
- OIE 2500 Management Science I: Deterministic Decision Models
- OIE 3460 Simulation Modeling and Analysis
- OIE 3501 Management Science II: Risk Analysis

**PROBABILITY AND STATISTICS**

In many areas of endeavor, decisions must be made using information which is known only partially or has a degree of uncertainty attached to it. One of the major tasks of the statistician is to provide effective strategies for obtaining the relevant information and for making decisions based on it. Probabilists and statisticians are also deeply involved in stochastic modeling - the development and application of mathematical models of random phenomena. Applications to such areas as medicine, engineering, and finance abound.

Students interested in becoming probabilists or mathematical statisticians should consider additional study in graduate school. While graduate study is an option for students whose goals are to be applied statisticians, there are also career opportunities in business, industry, and government for holders of a Bachelor's degree. More information about careers in statistics can be found at the American Statistical Association's web site <http://www.amstat.org/careers>.

Students planning on graduate studies in this area would be well advised to consider, in addition to the courses of interest listed below, additional independent study or PQP work in probability and statistics, or some of the department's statistics graduate offerings.

**Courses of Interest**

- MA 2611 Applied Statistics I
- MA 2612 Applied Statistics II
- MA 2631 Probability
- MA 3627 Applied Statistics III
- MA 3631 Mathematical Statistics
- MA 4237 Probabilistic Methods in Operations Research
- MA 4631 Probability and Mathematical Statistics I
- MA 4632 Probability and Mathematical Statistics II

**PROGRAM IN ACTUARIAL MATHEMATICS**

Actuaries provide financial evaluations of risk that help professionals in the insurance and finance industries, and many in large corporations and government agencies make strategic management decisions. Fellowship in the Society of Actuaries or the Casualty Actuarial Society - achieved by passing a series of examinations - is the most widely accepted standard of professional qualification to practice as an actuary.

WPI's program enables students to take the first steps toward preparing for these exams and introduces these majors to the fundamentals of business and economics.

**PROJECTS**

Off-campus qualifying projects are regularly done in collaboration with insurance companies, and have in the past been sponsored by Aetna, Allmerica Financial, Blue Cross Blue Shield of Massachusetts, John Hancock Mutual Insurance, Premier Insurance, and Travelers Property Casualty. Visit <http://www.wpi.edu/+CIMS>. These projects give real-world experience of the actuarial field by having students involved in solving problems faced by professional actuaries. Instead of choosing a project already posed by a company/advisor team, students may instead seek out industry-sponsored projects on their own (often through internship connections) and propose them to a potential faculty advisor. Alternatively, students may choose to complete any other project in mathematics.

**Program Distribution Requirements for the Actuarial Mathematics Major**

The normal period of residency at WPI is 16 terms. In addition to the WPI requirements applicable to all students, completion of a minimum of 10 units of study is required as follows:

REQUIREMENTS	MINIMUM UNITS
1. Mathematics (including MQP) (See notes 1-6).	7
2. Management (See note 7).	4/3
3. Additional courses or independent studies (except MS, PE courses, and other degree requirements) from any area (See note 8).	5/3

**NOTES:**

1. Must include MA 3831 and MA 3832, or their equivalents, at least one of MA 3257, MA 3457, or equivalent, and at least one of MA 3631, MA 4632, or equivalent.
2. Must include two of the following: MA 2073, MA 2271, MA 2273, MA 2431, MA 2631, or their equivalents.
3. Must include three of the following: MA 3211, MA 3212, MA 4213, MA 4214, or their equivalents.
4. May not include independent studies directed toward Society of Actuaries exams.
5. May not include either MA 2201 or MA 2210.
6. May not include both MA 2631 and MA 2621.
7. Must include ACC 2101 and FIN 2200 or their equivalents.
8. Must include 2/3 units of computer science.

Students interested in pursuing a degree in Actuarial Mathematics should contact Professor Abraham, the Coordinator of the Actuarial Mathematics Program, as soon as possible.

## ACTUARIAL MATHEMATICS MAJOR PROGRAM CHART

UNIVERSITY REQUIREMENTS	
Minimum Academic Credit	15 Units
Residency	8 Units
Humanities and Arts	2 Units
Interactive Qualifying Project	1 Unit
Major Qualifying Project	1 Unit
Social Science	2/3 Unit
Physical Education	1/3 Unit

### FOUNDATION COURSES

INTRODUCTORY COURSES	TRANSITION COURSES (2/3 Unit Required)	CORE COURSES (4/3 Unit Required)	ACTUARIAL COURSES (1 Unit Required)
MA 1021-1024 or MA 1031-1034 MA 2051 MA 2071 MA 2251 MA 2611	MA 2073 MA 2271* MA 2273* MA 2431 MA 2631	Both MA 3831 and MA 3832 One of MA 3257 or MA 3457 One of MA 3631 or MA 4632	MA 3211 MA 3212 MA 4213* MA 4214*

### OTHER MA COURSES TO ATTAIN TOTAL OF 6 UNITS:

ACTUARIAL MATH	ANALYSIS	ALGEBRA	DISCRETE MATH	COMPUTATIONAL MATH	OPERATIONS RESEARCH	STATISTICS/ PROBABILITY
MA 3211 MA 3212 MA 4213* MA 4214*	MA 2431 MA 3471* MA 3475* MA 4291 MA 4451 MA 4473*	MA 2073 MA 3823* MA 3825*	MA 2271* MA 2273* MA 3233*	MA 3257 MA 3457 MA 4411*	MA 3231 MA 3233* MA 4235* MA 4237*	MA 2612 MA 2621 MA 2631 MA 3627* MA 3631 MA 4214* MA 4631 MA 4632 MA 4658

### OTHER REQUIREMENTS

Computer Science (2/3 Unit Required)	Management (4/3 Unit Required)	
	Required ACC 2101 FIN 2200	Suggested ACC 1100 FIN 2250* FIN 2260 OBC 2300 OIE 2500 OIE 3460 OIE 3501

\* Category II courses, offered in alternating years.

## STATISTICS MINOR

Statistical methods are widely used in science, engineering, business, and industry. The Statistics Minor is appropriate for all WPI students with interests in experimental design, data analysis, or statistical modeling. The minor is designed to enable a student to properly design studies and analyze the resulting data, and to evaluate statistical methods used in their field of study. Students should discuss course selections for the minor in advance with a statistics faculty member, who serves as the Minor Advisor. The student must complete the Statistics Minor Program Planning and Approval Form, and have it signed by the Minor Advisor. Students are encouraged to do this as early as possible, but it must be done prior to starting the Capstone. The statistics minor consists of completion of at least 2 units of work, which must consist of:

1. At least 5/3 units of coursework, which must be drawn from the following lists of Foundation and Upper-Level Courses, and which must include successful completion of at least 2/3 units from each list:

### Courses for Statistics Minor (5/3 Unit Required)

#### Foundation Courses (2/3 Unit Required)

MA 2073	Matrices and Linear Algebra II
MA 2611	Applied Statistics I
MA 2612	Applied Statistics II
MA 2631	Probability, or
MA 2621	Probability for Applications

#### Upper-Level Courses (2/3 Unit Required)

MA 3627	Applied Statistics III
MA 3631	Mathematical Statistics
MA 4213	Risk Theory
MA 4214	Survival Models
MA 4237	Probabilistic Methods in Operations Research
MA 4631	Probability and Mathematical Statistics I
MA 4632	Probability and Mathematical Statistics II
Any statistics graduate course:	
MA 509 or any course numbered MA 540 through MA 559	

2. The final 1/3 unit Capstone Experience: The capstone experience may be satisfied by certain 3000-level, 4000-level or graduate courses offered by the department or by a suitable independent study with one of the department's statistics faculty. The Capstone must be approved in advance by the instructor. This is done by having the Capstone instructor sign the Statistics Minor Program Approval Form. After completion of the Capstone Experience, the Statistics Minor Program Planning and Approval Form is submitted to the Mathematical Sciences Program Review Chair for final approval.

For information about the Statistics Minor, see any of the statistics faculty: Professors Joseph D. Petrucci, Balgobin Nandram, or Jayson D. Wilbur.

## MATHEMATICS MINOR

The Minor in Mathematics consists of successful completion of at least 2 units of academic activities in mathematical sciences.

Students should discuss course selections for the minor in advance with a member of the mathematical sciences faculty who will serve as the Minor Advisor. The student must complete the Mathematics Minor Program Planning and Approval Form and have it signed by the Minor Advisor. Students are encouraged to do this as early as possible, but it must be done prior to starting the Capstone. The following requirements must be satisfied.

1. At least 5/3 units must be coursework in the Mathematical Sciences Department at the 2000 level or above, of which at least 2/3 units must be upper-level courses, i.e. 3000-level, 4000-level, or graduate mathematics courses. Courses selected at the 2000 level, if any, must include at least one of the following courses:

MA 2073	Matrices and Linear Algebra II
MA 2251	Vector and Tensor Calculus
MA 2271	Graph Theory
MA 2273	Combinatorics
MA 2431	Mathematical Modeling with Ordinary Differential Equations
MA 2631	Probability

2. The final 1/3 unit Capstone Experience: The experience may be satisfied by certain 3000-level, 4000-level or graduate courses offered by the department or by a suitable independent study with a Mathematical Sciences faculty member. The Capstone must be approved in advance by the instructor. This is done by having the Capstone instructor sign the Mathematics Minor Planning and Approval Form. After completion of the Capstone Experience, the Mathematics Minor Program Planning and Approval Form is submitted to the Mathematical Sciences Program Review Chair for final approval.

Here are some examples of 5/3 units of coursework for four thematically-related minors. Other options are available.

Applied Analysis	Computational Analysis	Differential Equations	Discrete Mathematics	Operations Research
MA 2051	MA 2051	MA 2051	MA 2201	MA 2071
MA 2071	MA 2071	MA 2251	MA 2271	MA 2073
MA 2431	MA 2073	MA 3471	MA 2273	MA 3231
MA 3831	MA 3257	MA 4411	MA 3233	MA 3233
MA 3832	MA 3457	MA 4473	MA 533	MA 4235 or MA 4237

For more information about the Mathematics minor, see Professor Farr, who is the coordinator for Mathematics minors.

# MECHANICAL ENGINEERING

## G. TRYGGVASON, HEAD

PROFESSORS: D. Apelian, I. Bar-On, C. A. Brown, M. Dimentberg, N. A. Gatsonis, A. H. Hoffman, Z. Hou, M. M. Makhlof, R. L. Norton, R. J. Pryputniewicz, Y. Rong, B. J. Savelonis, S. Shivkumar, R. D. Sisson, Jr., J. M. Sullivan, Jr., G. Tryggvason

ASSOCIATE PROFESSORS: H. K. Ault, J. Blandino, M. Demetriou, C. Demetry, M. Fofana, D. J. Olinger, M. W. Richman

ASSISTANT PROFESSORS: C. Furlong, I. Hussein, D. Lados, J. Liang, J. Van de Ven

VISITING ASSISTANT PROFESSOR: E. C. Cobb

EMERITUS PROFESSORS: R. Biederman, J. M. Boyd, H. T. Grandin, R. Hagglund, W. A. Kistler, J. A. Mayer, Jr., K. E. Scott, D. N. Zwiep

## MISSION STATEMENT

The Mechanical Engineering program at WPI aims to graduate students who have the broad expertise required to confront real world technological issues that arise our society. Students in the program are educated to apply scientific principles and engineering methods to analyze and design systems, processes, and products that, when engineered properly, improve the quality of our lives. The Mechanical Engineering program is consistent with the WPI philosophy of education, in which each student develops the tools required for self-learning, and the sensibility to consider the impact of technology on society in the decisions they will make as engineering professionals.

## PROGRAM EDUCATIONAL OBJECTIVES

The Mechanical Engineering Program seeks to have alumni who:

- are successful professionals because of their mastery of the fundamental engineering sciences, and mechanical engineering and their understanding of the design process.
- are leaders in business and society due to a broad preparation in technology, communication, teamwork, globalization, ethics, business acumen and entrepreneurship.
- will use their understanding of the impact of technology on society for the betterment of humankind.

## PROGRAM OUTCOMES

Graduating students should demonstrate that they attain the following :

- an ability to apply knowledge of mathematics, science, and engineering
- an ability to design and conduct experiments, as well as to analyze and interpret data
- an ability to design a system, component, or process to meet desired needs within realistic constraints such as economic, environmental, social, political, ethical, health and safety, manufacturability, and sustainability
- an ability to function on multi-disciplinary teams
- an ability to identify, formulate, and solve engineering problems

- an understanding of professional and ethical responsibility
- an ability to communicate effectively
- the broad education necessary to understand the impact of engineering solutions in a global, economic, environmental, and societal context
- a recognition of the need for, and an ability to engage in life-long learning
- a knowledge of contemporary issues
- an ability to use the techniques, skills, and modern engineering tools necessary for engineering practice
- an ability to apply principles of engineering, basic science, and mathematics (including multivariate calculus and differential equations) to model, analyze, design, and realize physical systems, components or processes
- an ability to work professionally in both thermal and mechanical systems areas

## Program Distribution Requirements for the Mechanical Engineering Major

The normal period of residency at WPI is 16 terms. In addition to WPI requirements applicable to all students (see page 9), students wishing to receive the ABET-accredited degree designated “Mechanical Engineering” must satisfy certain additional distribution requirements. These requirements apply to 10 units of study in the areas of mathematics, basic science, and engineering science and design as follows:

REQUIREMENTS	MINIMUM UNITS
1. Mathematics and Basic Science (Notes 1, 2, 3).	4
2. Engineering Science and Design (includes MQP) (Notes 3, 4, 5, 6, 7, 8, 9).	6

### NOTES:

1. Must include a minimum of 5/3 units of mathematics, including differential and integral calculus and differential equations.
  2. Must include a minimum of 1/3 unit in chemistry and 2/3 unit in physics, or 1/3 unit in physics and 2/3 unit in chemistry.
  3. Must include an activity that involves basic matrix algebra and the solution of systems of linear equations, and an activity that involves data analysis and applied statistical methods.
  4. Must include 1/3 unit in each of the following: electrical engineering, materials science, and mechanical engineering experimentation.
  5. Must include at least one unit of ME courses at the 4000-level.
  6. May include 1000 level courses only if designated ES or ME.
  7. Must include two stems of coherent course and/or project offerings as noted below in a and b.
    - a. A minimum of one unit of work in thermo-fluid systems that includes the topics of thermodynamics, fluid mechanics and heat transfer, plus an activity that integrates thermo-fluid design.
    - b. A minimum of one unit of work in mechanical systems that includes the topics of statics, dynamics, and stress analysis, plus an activity that integrates mechanical design.
  8. Must include an activity which realizes (constructs) a device or system.
  9. Must include 1/3 unit of Capstone Design Experience.
- Items 3, 5, 7a integration, 7b integration, 8, 9 may all be “multiple-counted.”

**MECHANICAL ENGINEERING PROGRAM CHART**

STUDENTS EARNING A B.S. DEGREE IN MECHANICAL ENGINEERING MUST COMPLETE 15 UNITS OF STUDY, DISTRIBUTED AS FOLLOWS:

4 UNITS OF NON-TECHNICAL ACTIVITIES

2 UNITS H&A SUFFICIENCY	See WPI Requirements
1 UNIT INTERACTIVE QUALIFYING (IQP) PROJECT	See WPI Requirements
2/3 UNIT SOCIAL SCIENCE	See WPI Requirements
1/3 UNIT PHYSICAL EDUCATION	See WPI Requirements

1 UNIT FREE ELECTIVE

1 UNIT FREE ELECTIVE	See Catalog
----------------------	-------------

4 UNITS OF MATHEMATICS AND BASIC SCIENCE

5/3 Units  
Differential & Integral Calculus and Ordinary Differential Equations

MATHEMATICS	
MA 1021	MA 1023
MA 1022	MA 1024
MA 2051	

4/3 Units  
Student Selected Courses from the General Category of Mathematics and/or Basic Science

3/3 Units  
One Chemistry and Two Physics, OR  
One Physics and Two Chemistry

SCIENCE	
CH 1010	CH 1020
PH 1110	PH 1120

6 UNITS OF MECHANICAL ENGINEERING (Notes 1 & 2)

1 unit required	1 unit required	1 unit required	1 unit required	2 units required
MECHANICAL SYSTEMS	THERMOFLUID SYSTEMS	OTHER COURSES	MAJOR QUALIFYING PROJECT (MQP)	ELECTIVES
ES 2501 ES 2502 ES 2503	ES 3001 ES 3003 ES 3004	ES 2001 ECE 3601 ME 3901		At least one unit must be chosen as ES or ME courses at the 4000-level or higher.

The courses listed above can be replaced by other equivalent courses, with approval by the ME Program Committee.

**Note 1:** A complete program must include an activity in each of the following six categories. Courses used to satisfy these activities can be multiple-counted. They can be used to simultaneously satisfy the mechanical engineering, mathematics and basic science, and free elective requirements.

OTHER ACTIVITIES					
Linear Algebra	Statistics	Mechanical System Design	Thermofluid System Design	Realization	Capstone Design
MA 2071 ME 3501 MA 2073 ME 4505 MA 4411 ME 4512 ME 3311 ME 3321	MA 2611 MA 2612 MA 2621 ME 3901	ME 3310 ME 4320 ME 3311 ME 4430 ME 3320 ME 4770 ME 3506 ME 4771 MQP (depending on topic)	ME 4429 ME 4430 ME 4770 ME 4771 MQP (depending on topic)	ES 3323 ME 1800 ME 2300 ME 3506 MQP (depending on topic)	ME 4320 ME 4429 ME 4430 ME 4770 ME 4810 MQP (depending on topic)

**Note 2:** Elective courses from other engineering disciplines may also be selected at the 2000, 3000 or 4000 levels.

Each Mechanical Engineering student must complete a Capstone Design experience requirement. This capstone design experience is partially or fully accomplished by completing a Major Qualifying Project which integrates the past course work and involves significant engineering design. At the time of registration for the MQP, the project advisor will determine whether the MQP will meet the Capstone Design requirement or not. If not, the advisor will identify an additional 1/3 unit of course work in the area of design (ME 4320, ME 4429, ME 4430, ME 4770, or ME 4810) to be taken in order to meet the ABET Capstone Design requirement.

## MECHANICAL ENGINEERING DEPARTMENT CONCENTRATIONS

### AERONAUTICS (GATSONIS)

Students are provided with ample opportunity to develop technical competence in low- and high-speed aerodynamics, aircraft propulsion systems, structures, and aircraft design. Experimental and computational facilities are available for course and projects. Typical MQPs include: the design, construction, and testing of remotely piloted aircraft and micro aerial vehicles; experimental and computational aerodynamics; flow and structural control; parachute aerodynamics.

#### Aeronautics

2 Courses Required

- ME 3410 Compressible Fluid Dynamics
- ME 3711 Aerodynamics

4 Courses Selected

- ME 3712 Aerospace Structures
- ME 4710 Gas Turbines for Propulsion and Power Generation
- ME 4718 Materials with Aerospace Applications
- ME 4723 Aircraft Dynamics and Controls
- ME 4733 Guidance, Navigation and Communication
- ME 4770 Aircraft Design

*\*Plus Aeronautics related MQP*

### ASTRONAUTICS (GATSONIS)

Students are provided with ample opportunity to develop technical competence in spacecraft dynamics, rocket propulsion, guidance and controls, space structures, and space systems design. Experimental and computational facilities are available for course and projects. Typical MQPs include: design and testing of recoverable rockets; experiments in electric propulsion and micro-propulsion; experiments in formation flying and spacecraft control.

#### Astronautics

2 Courses Required

- ME 2713 Astronautics
- ME 4713 Spacecraft Dynamics and Controls

4 Courses Selected

- ME 3410 Compressible Fluid Dynamics
- ME 3712 Aerospace Structures
- ME 4718 Materials with Aerospace Applications
- ME 4719 Rocket Propulsion
- ME 4733 Guidance, Navigation and Communication
- ME 4771 Spacecraft and Mission Design

*\*Plus Astronautics related MQP*

### BIOMECHANICAL (HOFFMAN)

Students blend biology and biotechnology coursework with continuum mechanics, biomechanics, biofluids, and biomedical materials to support their individual interest. MQPs are usually developed jointly with off-campus medical facilities, including the University of Massachusetts Medical Center.

Typically MQP topics include: soft tissue mechanics, flow in constricted blood vessels, joint kinematics, prosthetic devices, sports biomechanics, biomaterials, tissue engineering and rehabilitation.

#### Biomechanical

Two (2) Biology and Biotechnology (BB) Courses

Select 4

- ME 3501 Elementary Continuum Mechanics
- ME 3506 Rehabilitation Engineering
- ME 4504 Biomechanics
- ME 4606 Biofluids
- ME 4814 Biomedical Materials
- Any BME course at the 3000-level or higher

*\* Plus Biomechanical-related MQP*

### ENGINEERING MECHANICS (HOU)

Students select courses to develop the ability to construct models to analyze, predict, and test the performance of solid structures, fluids, and composite materials under various situations.

Typical MQP topics include: mechanical vibrations, stress and strain analysis, computer methods in engineering mechanics, finite element analysis, and vibration isolation. Departmental testing facilities and computer and software support are available.

#### Engineering Mechanics

Select 6

- ME 3023 Mech. Behavior & Modeling Properties of Engineering Materials
- ME 3501 Elementary Continuum Mechanics
- ME 3506 Rehabilitation Engineering
- ME 3602 Incompressible Fluid Dynamics
- ME/BME 4504 Biomechanics
- ME 4505 Advanced Dynamics
- ME 4506 Mechanical Vibrations
- ME 4512 Introduction to the Finite Element Method

*\*Plus Engineering Mechanics MQP*

### MANUFACTURING (RONG)

Courses are available to support student interest in manufacturing engineering, computer-aided design, computer-aided manufacturing, robotics, vision systems, and a variety of manufacturing processes. Typical MQPs include: robotics, composite materials, factory automation, materials processing, computercontrolled machining, surface metrology, fixturing, machine dynamics, grinding, precision engineering, prototype manufacturing.

See also the Manufacturing Engineering degree program.

#### Manufacturing

Select 2

- ME 1800 Materials Selection and Manufacturing Processes
- ME 2820 Materials Processing
- ME 3023 Mechanical Behavior and Modeling Properties of Engineering Materials
- ME 4810 Automotive Materials and Process Design
- ME 4821 Plastics

Select 2

- ES 3011 Control Engineering I
- ME 3820 Computer-Aided Manufacturing
- ME/RBE 4815 Industrial Robotics

Select 2

- OIE 2850 Engineering Economics
- OIE 3400 Production System Design
- OIE 3401 Production Planning and Control

*\* Plus Manufacturing MQP*

**MATERIALS SCIENCE AND ENGINEERING (SISSON)**

Students interested in a strong materials science and engineering component can elect course and project activities in metals, ceramics, polymers, and composite materials with laboratory and project experience using facilities in Stoddard Laboratories.

Typical MQP topics include: X-ray diffraction, electron microscopy, computer modeling, mechanical testing and deformation mapping, plastic deformation, ceramic processing, friction, wear, corrosion, and materials processing.

Another option in the materials program is a Minor in Materials, which is described under Materials Engineering in this catalog.

**Materials Science and Engineering**

Select 2

- ME 2820 Materials Processing
- ME 4810 Automotive Materials and Process Design

Select 2

- ME 4813 Ceramics and Glasses for Engineering
- ME 4814 Biomedical Materials
- ME 4821 Plastics
- ME 4832 Corrosion and Corrosion Control
- ME 4875 Introduction to Nanomaterials and Nanotechnology

Select 2

- ME 3801 Experimental Methods in Materials Science and Engineering
- ME 4840 Physical Metallurgy
- Any 500-level MTE course

\* Plus Materials Science MQP

**MECHANICAL DESIGN (NORTON)**

Courses are available to support development of student interest in the design, analysis, and optimization of an assembly of components which produce a machine. Computer-based techniques are widely used in support of these activities.

Typical MQP topics are: optimum design of mechanical elements, stress analysis of machine components, evaluation and design of industrial machine components and systems, robotics, and computer-aided design and synthesis.

**Mechanical Design**

2 Required

- ME 3310 Kinematics of Mechanisms
- ME 3320 Design of Machine Elements

Select 4

- ES 1310 Engineering Design Graphics
- ES 3323 Introduction to CAD
- ME 2300 Introduction to Engineering Design
- ME 3311 Dynamics of Mechanisms and Machines
- ME 3321 Dynamic Modeling
- ME 3506 Rehabilitation Engineering
- ME 4320 Advanced Engineering Design
- ME/RBE 4322 Modeling and Analysis of Mechatronic Systems
- ME 4810 Automotive Materials and Process Design
- ME/RBE 4815 Industrial Robotics

\* Plus Mechanical Design MQP

**ROBOTICS (RONG)**

Students select courses to give them a solid foundation in the various aspects of robotics, including kinematics and actuators, sensors, and control and computing. In addition to relevant mechanical engineering courses, students can select courses from electrical engineering and computer science.

Typical MQP topics include designing of robots and robotic components, including mobile ground robots, aerial robots and underwater robots, automatic assembly and industrial robotics applications, and development of software and control algorithms for individual robots and robotic swarms.

**Robotics**

3 Required

- RBE 1001 Introduction to Robotics
- ES 3011 Control Engineering I or ME 3310 Kinematics of Mechanisms
- ME/RBE 4322 Modeling and Analysis of Mechatronic Systems or ME/RBE 4815 Industrial Robotics

Select 3

- ES 3011 Control Engineering I (If not selected above)
- ES 3323 Advanced Computer-aided Design
- ME 3310 Kinematics of Mechanisms (If not selected above)
- ME/RBE 4815 Industrial Robotics (If not selected above)
- ECE 2311 Continuous-Time Signal and System Analysis
- ECE 2312 Discrete-Time Signal and System Analysis
- ECE 2801 Foundations of Embedded Computer Systems
- ECE 4703 Real Time Digital Signal Processing
- CS 2102 Object-Oriented Design Concepts
- CS 2301 Systems Programming for Non-Majors or CS 2303 Systems Programming Concepts
- CS 3733 Software Engineering or CS 3133 Foundations of Computer Science
- CS 4341 Introduction to Artificial Intelligence
- CS 4731 Computer Graphics or 4732 Computer Animation
- CS 4120 Analysis of Algorithms

\* Plus Robotics MQP

\* Others courses with approval from the ME Undergraduate Committee.

**THERMAL-FLUID ENGINEERING (OLINGER)**

Students study the theoretical and empirical bases of thermodynamics, heat transfer, mass transfer, and fluid flow, as well as the application of these fundamental engineering sciences to energy conversion, environmental control, and vehicular systems.

Typical MQPs include: biological fluid mechanics, laminar/turbulent separation, lifting bodies, heat pipes, electronic component cooling, power cycles, fluid component analysis and design, and energy storage.

**Thermal-Fluid Engineering**

3 Required

- ME 3602 Incompressible Fluid Dynamics
- ME 3410 Compressible Fluid Dynamics
- ME 4429 Thermodynamic Applications or
- ME 4710 Gas Turbines for Propulsion and Power Generation

Select 3

- ES 3002 Mass Transfer
- ME 3501 Continuum Mechanics
- ME 3711 Aerodynamics
- ME 4429 Thermodynamic Applications
- ME 4606 Biofluids
- ME 4710 Gas Turbines for Propulsion and Power Generation
- ME 4719 Rocket Propulsion

\* Plus Thermal-Fluids related MQP

**NOTES:**

1. A Concentration area requires a 1 unit of MQP in that area.
2. After consultation with their academic advisor, students may petition the M.E. Dept. Curriculum Committee for approval of a Concentration plan at any time, preferably prior to the middle of their Junior Year.

**ENHANCED PROGRAMS**

**BACHELOR/MASTER’S PROGRAM IN MECHANICAL ENGINEERING**

Outstanding students are encouraged to combine a master’s degree with their undergraduate WPI studies. Details are found in the WPI GRADUATE PROGRAM section of this catalog, and interested students should initiate discussions with their advisor early in their junior year.

**COOPERATIVE EDUCATION PROGRAM**

The WPI Cooperative Education Program provides an opportunity to integrate “real-world” experience into an educational program. Details are found in the COOPERATIVE EDUCATION PROGRAM section on page 185.

**MECHANICAL ENGINEERING MINOR (FOR NON-MAJORS)**

Non- ME majors interested in developing a ME minor in conjunction with their major should consult with the Department Head or the lead faculty member in the specific ME sub-

area of interest to define a program leading to recognition of the minor. Each individual student minor must then be approved by the Committee on Academic Operations.

**MILITARY SCIENCE**

**LTC N. A. GAUTHIER, HEAD**

PROFESSOR: LTC N. A. Gauthier

ASSISTANT PROFESSORS: MAJ F. Pagaduan, CPT D. Hudson, CPT T. Painter, MSG S. Cascalheira, SFC P.B. Riddick

**MISSION STATEMENT**

The Military Science and Leadership Program (Army ROTC) is a premiere leadership and management program offered by WPI. Open to all students within the Worcester Consortium, the program is designed to teach valuable leadership skills and managerial traits that will prepare students for careers in the private and public sectors. Students partake in this hands-on experience that integrates traditional coursework with innovative challenging training. They develop strong decision-making

**MILITARY SCIENCE COURSE FLOW CHART**

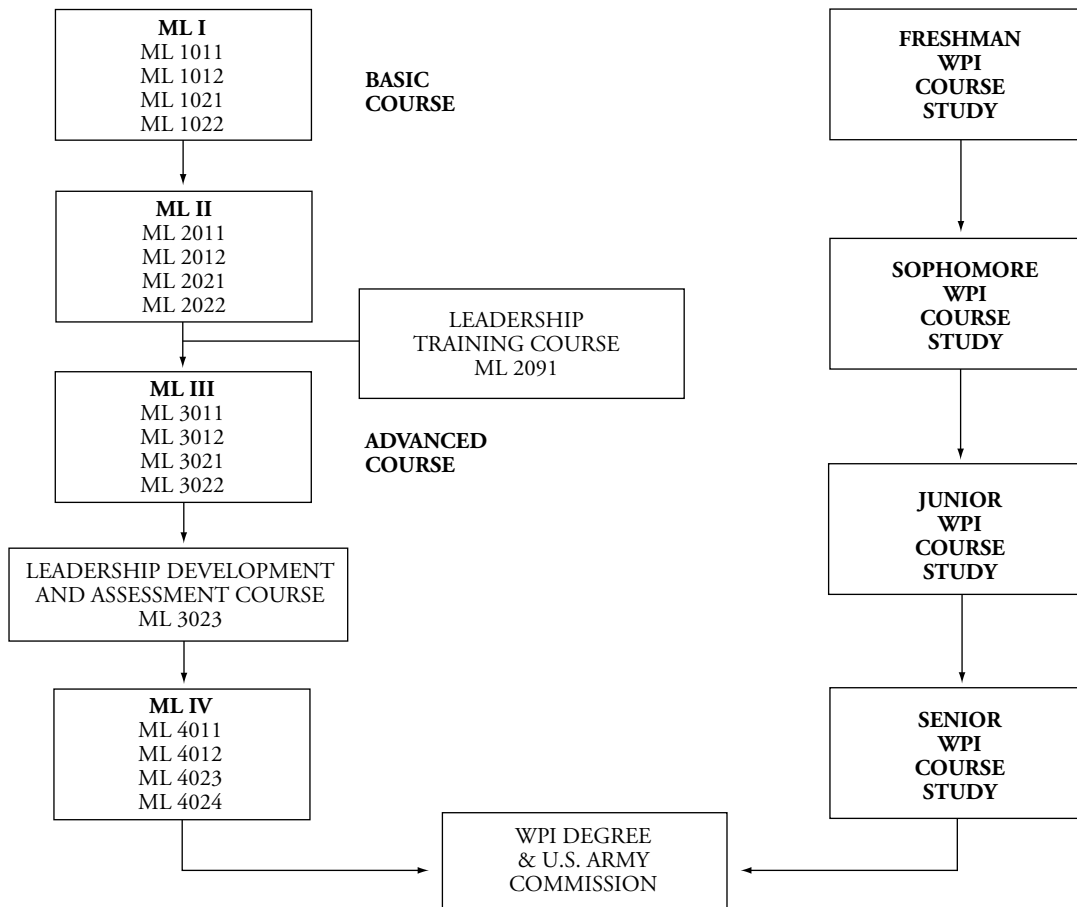

- (1) Required for 2 year ROTC program students.
- (2) Additional requirements: Professional Military Education.  
Five Undergraduate Courses.  
Leadership Laboratories, weekly.  
Physical Training, weekly.  
Weekend Field Training Exercise (2 each year).  
Social Events.
- (3) Required attendance for all Juniors and Seniors.



and organizational management skills, team-building and interpersonal skills, as well as learn time and stress management techniques.

### OBJECTIVES AND OUTCOMES

Students that participate in Army ROTC while pursuing their undergraduate and graduate studies are extremely marketable and highly sought after for their distinctive leadership capabilities. As technology transforms organizations, the desire for multi-faceted leaders has increased; the WPI Army ROTC prepares adaptable leaders for the future.

### PROGRAM DESCRIPTION(S)

The Military Science and Leadership program is intended to be a four-year program that encourages personal growth and development.

### BASIC COURSE

The first two years make up the Basic Course, which serves as the foundation to the program. During the Basic Course, the curriculum focuses on aspects of leadership, team-building, and communication skills. Students participate in adventure training, such as orienteering, rappelling, and paintball that puts their classroom learning to practice.

Students may participate in the first two years of the program commitment-free. Students awarded full-tuition scholarships or participate in the Advanced Course do incur a service obligation and may serve in the Army either full-time or part-time.

### ADVANCED COURSE

The Advanced Course is a more intensive leadership program that is taken during the Junior and Senior years or during two years of graduate studies. The curriculum continues to concentrate on problem-solving and building teams, but also introduces military tactics and ethics.

Students interested in earning a commission as an Army Officer are required to enroll in the Advanced Course and attend the Leadership Development and Assessment Course (LDAC). LDAC is a five-week course that students are paid to attend during the summer and is the culmination of the training that the students receive while on campus. If students decide later in their academic career that they would like to pursue Army ROTC, there are alternate entry options to prepare them for the Advanced Course.

Students attending on Army ROTC Scholarships or that are enrolled in the Advanced Course receive a monthly stipend and \$900 per year for books. Freshman receive \$300 per month, Sophomores receive \$350 per month, Juniors receive \$450 per month, and Seniors receive \$500 per month. Students interested in pursuing scholarships or enrolling in the Advanced course are required to meet eligibility requirements.

---

## PHYSICAL EDUCATION, RECREATION, AND ATHLETICS

---

### D. L. HARMON, HEAD

ASSOCIATE PROFESSOR: P. J. Grebinar

INSTRUCTORS: C. Bartley, P. Bennett, S. Carver, M. DeSavage, J. DiCarlo, C. Galasso, P. Hickey, G. Lefort, E. Lorion, L. Noble, C. Robertson, G. Snoddy, J. Steele, E. Zaloom

### REQUIREMENTS

Qualification in physical education shall be established by completing 1/3 unit of course work. Students are urged to complete this requirement in their first two years of residency at WPI. In addition to general PE course offerings, students may satisfy their PE requirement in the PE 1100-series courses noted below:

1. WPI approved varsity athletic team participation. Student must be registered in advance of participation.
2. Club Sports. Students must be members of a PE approved club prior to becoming eligible for physical education credit. Students must be registered in advance of participation.
3. Approved courses not offered at WPI; advance approval by the Physical Education Department is necessary.
4. Individualized program at WPI; advance approval by the Physical Education Department is necessary.

Students who wish to obtain PE credit by the above means must be enrolled in a course in the PE 1100 series.

Participation in certain ROTC programs may entitle students to a receive PE credit.

---

## ATHLETIC PROGRAMS

---

### THE INTERCOLLEGIATE PROGRAM

The intercollegiate athletics program offers competition in 20 varsity sports.

All full-time members of the physical education faculty and staff are involved in coaching, with assistance from other faculty members and part-time coaches from the community who have special skills in athletics.

WPI has excellent facilities and provides the best in protective equipment but, if an injury should occur, a team physician and full-time trainers are available, offering the latest treatment methods and facilities.

Practices are normally held daily, after 4 pm. Midweek contests involving travel are held to a minimum to avoid missing classes. Every effort is made to avoid conflicts with academic activities, and competitions are generally scheduled with schools with similar standards and objectives.

In recent years, teams and individuals have been sent to regional and national tournaments to allow them to compete at the highest possible level. All-America recognition has been attained recently in football, men's soccer, track and field, and wrestling.

The athletic program forms an important point of contact with other universities and colleges in the East and is an opportunity for our students to compete against conference and independent institutions.

**Varsity Sports**

Baseball	Soccer (men)
Basketball (men)	Soccer (women)
Basketball (women)	Softball
Crew (men)	Swimming & Diving (men)
Crew (women)	Swimming & Diving (women)
Cross Country (men)	Track (men) - Indoor/Outdoor
Cross Country (women)	Track (women) - Indoor/Outdoor
Field Hockey	Volleyball (women)
Football	Wrestling

**THE CLUB SPORTS PROGRAM**

The Club Sports Program offers a variety of competitive activities for student participation. Some of the current Club Sports include:

**Club Sports**

Alpine Skiing	Martial Arts (SOMA)
Cheerleaders	Rugby
Soccer	Sailing
Fencing	Scuba
Free Style Wrestling	Tennis
Golf	Ultimate Frisbee
Ice Hockey	Volleyball (men)
Lacrosse	Water Polo

Club Sports, Class II, are administered through the Department of Physical Education, Recreation, and Athletics and details regarding the activities listed above are available through the Coordinator of Club Sports in Alumni Gymnasium.

**THE INTRAMURAL PROGRAM**

The Intramural Program is designed as an opportunity for students to enjoy the benefits of recreation and athletic competition even though they may not have the time, talent or desire to compete on the higher intercollegiate level.

Entries are welcome not only from fraternities, sororities and other residential units but also from a variety of independent student groups and individuals, including faculty and staff. Approximately 50% of the student body participate in intramurals.

The program includes flag football, floor hockey, racquetball, volleyball, basketball, soccer, softball, and bowling. The program is ever-expanding, and activities are added as needs arise and time and facilities permit.

The program is administered by the Department of Physical Education and Athletics, and all details regarding scheduling and eligibility are available on the department website.

**PHYSICS****G. S. IANNACCHIONE, HEAD**

PROFESSORS: P. K. Aravind, S. N. Jaspersen, T. H. Keil, G. D. J. Phillies, L. R. Ram-Mohan, A. A. Zozulya

ASSOCIATE PROFESSORS: N. A. Burnham, G. S. Iannacchione, R. S. Quimby

ASSISTANT PROFESSORS: R. Garcia, C. A. Koleci

RESEARCH PROFESSOR: D. F. Nelson

**MISSION STATEMENT**

The Physics Department provides education in physics to both undergraduate and graduate students and contributes to the growth of human knowledge through scholarly work.

**PROGRAM EDUCATIONAL OBJECTIVES**

The physics department educates students with a program characterized by curricular flexibility, student project work, and active involvement of students in their learning. Through a balanced, integrated curriculum stressing the widely applicable skills and knowledge of physics, we provide an education that is strong both in fundamentals and in applied knowledge, appropriate for immediate use in a variety of fields as well as graduate study and lifelong learning.

**PROGRAM OUTCOMES**

We expect that physics graduates:

1. Know, understand, and use a broad range of basic physical principles.
2. Have an understanding of appropriate mathematical methods, and an ability to apply them to physics.
3. Have demonstrated oral and written communications skills.
4. Understand options for careers and further education, and have the necessary educational preparation to pursue those options.
5. Have an ability to learn independently.
6. Have acquired the broad education envisioned by the WPI Plan.
7. Are prepared for entry level careers in a variety of fields, and are aware of the technical, professional, and ethical components.
8. Are prepared for graduate study in physics and/or other fields.
9. Can find, read, and critically evaluate selected original scientific literature.

**Program Distribution Requirements for the Physics and Engineering Physics Majors**

The normal period of residency at WPI is 16 terms. In addition to the WPI requirements applicable to all students (see page 9), completion of a minimum of 10 units of study is required in the areas of mathematics, physics, and related fields as follows:

**PHYSICS**

REQUIREMENTS	MINIMUM UNITS
1. Mathematics (Note 1).	3
2. Physics (including the MQP) (Notes 2, 3).	5
3. Other subjects to be selected from mathematics, science, engineering, computer science, and management (Note 3).	2

**NOTES:**

1. Mathematics must include at least 2/3 unit of mathematics at the level of MA 3000 or higher.
2. ES 3001 and CH 3510 count as physics courses.
3. Either item 2 or 3 must include at least 1/3 unit from each of the five principal areas of physics: mechanics, experimental physics, electromagnetism, quantum mechanics, and thermal and statistical physics. This core distribution requirement is satisfied by successfully completing at least one course from each of the following five sets of courses: PH 2201 or 2202 (mechanics); PH 2651 or 2601 (experimental physics); PH 2301 or 3301 (electromagnetism); PH 3401 or 3402 (quantum mechanics); ES 3001, CH 3510, or PH 4206 (thermal and statistical physics); or other courses approved by the department Program Review Committee following petition by the student.

**ENGINEERING PHYSICS**

1. Same requirements as PHYSICS, with the addition that the 10 units must include 2 units of coordinated engineering and other technical/scientific activities. The 2-unit program must be formulated prior to final year of study by the student in consultation with the academic advisor, and must be certified prior to the final year by the departmental Program Review Committee.

**PHYSICS AND ENGINEERING-PHYSICS PROGRAMS**

For a student entering the study of physics, there is a natural progression of subjects which provide a foundation for advanced work within physics and engineering-physics programs. This constitutes a core sequence which embodies the following indispensable basic areas of study: classical mechanics, electromagnetism, a survey of modern physics, statistical and quantum physics, and laboratory experimental methods. Because the language of the exact sciences is mathematics, there is a parallel core sequence of mathematics courses normally taken either as preparation for or concurrently with the physics courses with which they are paired in the list presented below. In the following table  $\longrightarrow$  indicates that the mathematics course is strongly recommended;  $\longleftrightarrow$  indicates that concurrent study is acceptable.

MA 1021 Calculus I	$\longleftrightarrow$	PH 1110 Mechanics	
MA 1022 Calculus II	$\longleftrightarrow$	PH 1120 Electricity and Magnetism	
MA 1023 Calculus III	$\longleftrightarrow$	PH 1111 Mechanics	
MA 1024 Calculus IV	$\longleftrightarrow$	PH 1121 Electricity and Magnetism	
MA 1023 Calculus III	$\longleftrightarrow$	PH 1130 Introduction to 20th Century Physics	
MA 1024 Calculus IV	$\longleftrightarrow$	PH 1140 Oscillations and Waves	
MA 2051 Differential Equations	$\longleftrightarrow$	PH 2202 Intermediate Mechanics II	
MA 2071 Linear Algebra	$\longrightarrow$	PH 2651 Physics Laboratory	
MA 2251 Vector/Tensor Calculus	$\longrightarrow$	PH 2301 Electromagnetic Fields I	
MA 4451 Boundary Value Problems	$\longleftrightarrow$	PH 3301 Electromagnetic Theory	
(PH 1110, PH 1120)	}	$\longrightarrow$	PH 3401 Quantum Mechanics I
			PH 4206 Statistical Physics
Students needing a somewhat more gradual introduction and an opportunity to gain mathematical skills concurrently are advised to substitute these courses for PH 1111 and PH 1121.			

Physics and engineering-physics students should also reserve part of their undergraduate experience for developing perspective in a range of other science and engineering disciplines. A few of the many possibilities are illustrated by the following examples.

- Chemistry (CH 1010, 1030); Material Science (ES 2001). Choosing appropriate materials is often crucial in the development of new experimental techniques that can further our knowledge of physical phenomena. Conversely, the studies of physicists have had profound effects on the development of new materials.
- Electronics, both analog (ECE 2201 and 3204, and digital (ECE 2022). Electronics pervades the modern laboratory. It is valuable to learn electronic principles and designs as they are applied in modern “on-line” experimental data collection and data reduction systems.

- Computer science (CS 1101 or CS 1102 and CS 2301). Physics students will need to make skillful use of computers in present and future experimental data processing, theoretical analyses, and the storing, retrieving and displaying of scientific information.
- Engineering courses related to science. Some basic knowledge in areas such as heat transfer, control systems, fluid mechanics, stress analysis and similar topics will prove to be of great benefit to the physicist called upon to apply professional knowledge to practical engineering problems.

Building on this core and topical subject coverage, physics students are in a position to turn in any number of directions within the range of physics studies, depending on individual interests and career objectives. Six illustrative examples are outlined below. In each case the outline includes a list of recommended and related courses followed by a sampling of project opportunities in the respective areas. Selection of specific courses and projects should be determined by students’ interests and the guidance of their academic advisors and the engineering-physics coordinator. For courses outside of the physics department, students are advised to discuss the prerequisites with the instructor.

**1. Physics****Recommended Courses**

PH 3402	Quantum Mechanics II
PH 4201	Advanced Classical Mechanics
PH (IS/P)	Selected Readings in Physics

**Related Courses**

ECE 2311	Continuous-Time Signal and System Analysis
ECE 2312	Discrete-Time Signal and System Analysis
ECE 3801	Advanced Logic Design
ECE 3901	Semiconductor Devices
ES 3011	Control Engineering I
PH 2510	Atomic Force Microscopy
PH 3501	Relativity
PH 3502	Solid State Physics
PH 3503	Nuclear Physics
PH 3504	Optics
PH (IS/P)	Modern Optics
PH 501 (Graduate)	Mathematical Methods of Physics I
PH 511 (Graduate)	Classical Mechanics
MA 4291	Applicable Complex Variables

**2. Computational Physics.****Recommended Courses**

MA 3257	Numerical Methods for Linear and Non-Linear Systems
MA 4411	Numerical Solutions of Differential Equations
PH (IS/P)	Numerical Techniques in Physics

**Related Courses**

PH 3402	Quantum Mechanics II
PH 3502	Solid State Physics
PH 501/2	(Graduate) Mathematical Physics
MA 3457/CS4033	Numerical Methods for Calculus and Differential Equations
MA 4291	Applicable Complex Variables
CS 1101	Introduction to Program Design
CS 2011	Introduction to Computer Organization and Assembly Language
CS 2301	Systems Programming for Non-Majors
CS 4731	Computer Graphics
ECE 2311	Continuous-Time Signal and System Analysis
ECE 2312	Discrete-Time Signal and System Analysis
ECE 3801	Advanced Logic Design
ES 3011	Control Engineering I

**3. Optics****Recommended Courses**

PH 3504	Optics
PH 2501	Photonics
PH 2502	Lasers

**Related Courses**

PH 3402	Quantum Mechanics II
PH 3502	Solid State Physics
PH 542/3	(Graduate) Modern Optics I and II
MA 4291	Applicable Complex Variables
AR/ID 3150	Light, Vision, and Understanding
ECE 2311	Continuous-Time Signal and System Analysis
ECE 2312	Discrete-Time Signal and System Analysis
ES 3011	Control Engineering I

**4. Electromagnetism****Recommended Courses**

PH (IS/P)	Modern Optics
PH (IS/P)	Selected Readings in Electromagnetism

**Related Courses**

PH 3402	Quantum Mechanics II
PH 3502	Solid State Physics
PH 3503	Nuclear Physics
PH 3504	Optics
PH 533	(Graduate) Electromagnetic Theory
PH 514/5	(Graduate) Quantum Mechanics
MA 4291	Applicable Complex Variables
ECE 2311	Continuous-Time Signal and System Analysis
ECE 2312	Discrete-Time Signal and System Analysis
ES 3011	Control Engineering I

**5. Nuclear Science And Engineering****Recommended Courses**

ES 2011	Introduction to Nuclear Technology
PH 3503	Nuclear Physics

**Related Courses**

PH 3402	Quantum Mechanics II
PH 3501	Relativity
PH 553	(Graduate) Nuclear Physics
ME 4832	Corrosion and Corrosion Control
ECE 3801	Advanced Logic Design
ES 3011	Control Engineering I

**6. Thermal Physics****Recommended Courses**

ES 3001	The Statistical Development of Classical Thermodynamics
ES 3004	Fluid Mechanics
PH (IS/P)	Selected Readings in Thermal Physics

**Related Courses**

ES 3003	Heat Transfer
ES 3011	Control Engineering I
ME 3410	Compressible Flow
PH 3502	Solid State Physics
PH 3504	Optics
ME 4429	Thermodynamic Applications and Design
ME 4602	Intermediate Fluid Dynamics
PH 501/2	(Graduate) Mathematical Physics

**PHYSICS MINOR**

The Physics Minor offers non-Physics majors the opportunity to broaden their understanding of both the principles of physics and the application of those principles to modern day engineering problems. In these times of rapid technological change, knowledge of fundamental principles is a key to adaptability in a changing workforce.

Two units of coordinated physics activity are required for the Physics Minor, as follows (note that, in accordance with Institute policy, no more than 3/3 of these units may be double-counted toward other degree requirements):

1. Any or all of the following four introductory courses:
  - PH 1110 or PH 1111
  - PH 1120 or PH 1121
  - PH 1130
  - PH 1140
2. At least 2/3 unit of upper level physics courses (2000 level or higher), which may include IS/P courses or independent studies approved by the program review committee. Examples of courses of this type which might be selected are (but are not limited to):
  - PH 2201 Intermediate Mechanics I
  - PH 2301 Electromagnetic Fields
  - PH 2651 Physics Laboratory
  - PH 3401 Quantum Mechanics I
  - PH 3504 Optics
  - PH 2501 Photonics
  - IS/P Quantum Engineering

Students who have taken the four course introductory sequence should have an adequate physics background for these courses; see, however, the individual course descriptions for the expected mathematical background. Other physics courses may be selected for the physics minor, but the recommended background for such courses often includes one or more of the courses listed above.

## 3. Capstone Experience

The capstone experience for the physics minor can be satisfied either by an independent study arranged for this purpose, or by one of the upper level courses. IF the second option is chosen, the student must discuss this with the instructor prior to the start of the course. In either case, documentation of the capstone experience will consist of a paper, prepared in consultation with the instructor or independent study advisor, which incorporates and ties together concepts learned in the physics courses selected.

For more information, or assistance in selecting a minor advisor or an independent study advisor, see the Head of the Physics Department in Olin Hall 119.

Majors in Physics or Engineering Physics do not qualify for a Minor in Physics.

## PRE-LAW PROGRAMS

### ADVISORS: G. HEATON, K. RISSMILLER

Law schools do not require that undergraduates complete any particular course of study. Thus, students who complete degrees in engineering and science may wish to consider careers in law. Undergraduates interested in attending law school are encouraged to choose from among the many courses offered which explore legal topics. For those with greater interest, WPI offers a Minor in Law and Technology described on page 73. Courses with substantial legal content are listed among those courses fulfilling the requirements of the minor.

Enrolling in these courses will introduce students to the fundamentals of legal process and legal analysis. Students will study statutes, regulations and case law. These courses will, therefore, offer the student valuable exposure to the kind of material commonly studied in law schools and they may help demonstrate a student's interest to law school admission committees. IQPs in Division 52, Law and Technology, or other projects that involve library research and extensive writing may also be helpful.

A pre-law advising program in the Social Science Department maintains information on careers in law, law schools, and the law school admission test (LSAT), which is universally required. Students may examine this material independently or make an appointment. Students with an interest in law are also encouraged to join the Pre-Law Society. To do so, contact Professor Rissmiller.

## PRE-MBA PROGRAM (DUAL DEGREE)

### ADVISOR: N. WILKINSON

#### FIVE-YEAR DUAL DEGREE BACHELOR/MBA PROGRAM

The combination of a technical undergraduate degree and a graduate degree in business has been cited by many experts as the ideal educational preparation for a career in private industry. For that reason, the Department of Management offers the opportunity for obtaining dual degrees (i.e., the Bachelor degree in engineering or science and the Master of Business Administration, MBA). The dual-degree program can be completed within five years, however, the program is demanding, and curriculum planning with the student's advisor and the Department of Management should start by the beginning of the student's third year at WPI at the very latest.

Only registered WPI undergraduates majoring in an engineering (excluding Management Engineering) or science area may enter the Dual-Degree Bachelor/MBA Program. A separate and complete application to the MBA program must be submitted. Admission to the Dual-Degree Bachelor/MBA Program is determined by the faculty of the Department of Management. The student should begin the curriculum planning process as early as possible in his/her undergraduate program, but no later than the beginning of the third year, to ensure that all of the required undergraduate courses are completed within the student's four years of undergraduate study. It is recommended that the MBA application be submit-

ted during the student's Third Year of under-graduate study. A student in the Dual-Degree Bachelor/MBA Program continues to be registered as an undergraduate until the bachelor's degree is awarded.

Students wishing to do a combined Bachelor/MBA must complete the following courses while an undergraduate:

ACC 1100	Financial Accounting
FIN 2200	Financial Management
OBC 2300	Organizational Science
MA 2611	Applied Statistics I
MA 2612	Applied Statistics II
OIE 3400	Production System Design
MKT 3600	Marketing Management
MIS 3700	Information Systems Management
ECON 1110	Introductory Microeconomics
ECON 1120	Introductory Macroeconomics

To obtain a bachelor's degree via the Dual-Degree Bachelor/MBA Program, the student must satisfy all requirements for the bachelor's degree, including distribution and project requirements.

To obtain an MBA via the Dual-Degree Bachelor/MBA Program, the student must satisfy all MBA degree requirements. In addition to the prerequisite undergraduate courses listed above, the student must complete the following graduate courses:

OBC 511	Interpersonal and Leadership Skills for Technological Managers
MKT 512	Creating and Implementing Strategy for Technological Organizations
OIE 513	Creating Processes in Technological Organizations
ACC 514	Business Analysis for Technological Managers
BUS 515	Legal and Ethical Context of Technological Organizations
BUS 516	Graduate Qualifying Project (GQP)
12 Elective Credits	

A student in the Dual-Degree Bachelor/MBA Program may, with prior approval, apply the equivalent of a maximum of 12 graduate credits from the same courses toward both the bachelor's and MBA degrees. Students in the Dual-Degree Bachelor/MBA Program may not take graduate-level management courses prior to their Fourth Year of undergraduate study, and then only provided the corresponding prerequisites have been satisfied.

The Department of Management may make other requirements as it deems appropriate in any individual case. These requirements take the form of a written agreement between the student and the Department of Management, and must be filed with the registrar before the student may be matriculated in the Dual-Degree Bachelor/MBA Program.

The Dual-Degree Bachelor/MBA Program is a full-time program of study. Once admitted to the Dual-Degree Bachelor/MBA Program, a student must register every fall and spring semester until the MBA is completed. A student in the Dual-Degree Bachelor/MBA Program who has no registered activities during a given fall or spring semester is automatically terminated from the Dual-Degree Bachelor/MBA Program, and may only be readmitted to the Dual-Degree Bachelor/MBA Program by the Department of Management's Graduate Policy and Curriculum Committee and the Committee for Graduate Studies and Research via petition showing extenuating circumstances. Termination from the Dual-Degree Bachelor/MBA Program does not affect a student's ability to continue toward the bachelor's degree.

## PRE-MEDICAL, PRE-DENTAL AND PRE-VETERINARY PROGRAMS

### ADVISOR: J. RULFS

Students at WPI who wish to pursue careers in the medical professions should, in consultation with their academic advisors, plan their academic programs to include courses in biology, general and organic chemistry, and physics including laboratory experiences. Entry into medical or other health professions schools may be accomplished through any major program of study offered at WPI, although students majoring in some programs may have to use all of their electives to fulfill the required courses for medical school admission or may have to take some courses during summer sessions. It is important for students to work closely with their academic advisors as well as the pre-health advisor at WPI, to formulate an academic plan of study that will include the courses required for health professions schools. While each school may have specific and individual admissions requirements, typically these will include:

General chemistry*	3 courses
Organic chemistry*	3 courses
Biology*	3 courses
Physics*	3 courses
Calculus	2 courses
English composition**	2 courses

\* These courses must include laboratory components.

\*\* Check with the pre-health advisor for the use of course and project work to fulfill this requirement.

Students should consult catalogs of the individual health professions schools for specific requirements.

The WPI projects system offers a tremendous advantage to pre-health professions students. Medical, dental and veterinary schools value teamwork, as well as cross cultural, research, and medically related experience, all of which can be demonstrated through project work. Opportunities for such projects can be found on campus or at one of the project center sites at the University of Massachusetts Medical Center or Tufts University School of Veterinary Medicine or through WPI's global projects program. These projects provide students with valuable and unique experiences that can strengthen their commitment to a health profession and their application for admission to health professions schools.

Because students will leave WPI with a degree in an academic discipline, they will have other career opportunities should they decide not to pursue a career in a health profession or should they choose to work for some time after graduation before continuing on to a health professions school. Students or alumni applying to health professions school should plan to meet with the pre-health advisor to discuss the application process as well as to plan for a letter of recommendation from the pre-health office to support their application. These meetings should happen no later than the spring of the junior year or as soon as the decision is made to pursue admission to a health profession school.

## PROJECT-BASED LEARNING COMMUNITY OPTION (PLC)

See page 178 for detailed description.

## ROBOTICS ENGINEERING

### DIRECTOR: M. A. GENNERT

ASSOCIATED FACULTY: H. K. Ault (ME), D. C. Brown (CS), M. J. Ciaraldi (CS), D. Cyganski (ECE), M. A. Demetriou (ME), R. J. Duckworth (ECE), A. E. Emanuel (ECE), M. S. Fofana (ME), C. Furlong-Vazquez (ME), M. A. Gennert (CS), A. H. Hoffman (ME), X. Huang (ECE), I. Hussein (ME), S. Jarvis (ECE), R. W. Lindeman (CS), F. J. Looft (ECE), W. R. Michalson (ECE), R. L. Norton (ME), G. F. Pollice (CS), C. Rich (CS), Y. Rong (ME), L. E. Schachterle (Provost's Office), K. A. Stafford (ME), G. Tryggvason (ME), J. Van de Ven (ME)

### MISSION STATEMENT

Robotics—the combination of sensing, computation and actuation in the real world—is on the verge of rapid growth, driven by both supply and demand. The supply side is driven by decreasing cost and increasing availability of sensors, computing devices, and actuators. The demand side is driven by national needs for defense and security, elder care, automation of household tasks, customized manufacturing, and interactive entertainment. Engineers working in the robotics industry are mostly trained in one of Computer Engineering, Computer Science, Electrical Engineering, Mechanical Engineering, and Software Engineering. No single discipline provides the breadth demanded by robotics in the future.

### PROGRAM EDUCATIONAL OBJECTIVES

The Robotics Engineering Program strives to educate men and women to

- Have a basic understanding of the fundamentals of Computer Science, Electrical and Computer Engineering, Mechanical Engineering, and Systems Engineering.
- Apply these abstract concepts and practical skills to design and construct robots and robotic systems for diverse applications.
- Have the imagination to see how robotics can be used to improve society and the entrepreneurial background and spirit to make their ideas become reality.
- Demonstrate the ethical behavior and standards expected of responsible professionals functioning in a diverse society.

### PROGRAM OUTCOMES

Graduating students will have

- an ability to apply broad knowledge of mathematics, science, and engineering,
- an ability to design and conduct experiments, as well as to analyze and interpret data,
- an ability to design a robotic system, component, or process to meet desired needs within realistic constraints such as economic, environmental, social, political, ethical, health and safety, manufacturability, and sustainability,

- an ability to function on multi-disciplinary teams,
- an ability to identify, formulate, and solve engineering problems,
- an understanding of professional and ethical responsibility,
- an ability to communicate effectively,
- the broad education necessary to understand the impact of engineering solutions in a global, economic, environmental, and societal context,
- a recognition of the need for, and an ability to engage in life-long learning,
- a knowledge of contemporary issues, and
- an ability to use the techniques, skills, and modern engineering tools necessary for engineering practice.

## Program Distribution Requirements for the Robotics Engineering Major

REQUIREMENTS	MINIMUM UNITS
1. Mathematics (Note 1)	7/3
2. Basic Science (Note 2)	4/3
3. Entrepreneurship	1/3
4. Engineering Science and Design, including the MQP (Notes 3, 4, 5, 6, 7, 8, 9)	6 *

### NOTES:

1. Must include Differential and Integral Calculus, Differential Equations, Discrete Mathematics, and Probability or Statistics.
  2. Must include at least 2/3 units in Physics.
  3. Must include at least 5/3 units in Robotics Engineering.
  4. Must include at least 1 unit in Computer Science, including Algorithms and Software Engineering.
  5. Must include at least 2/3 units in Electrical and Computer Engineering, including Embedded Systems.
  6. Must include at least 1/3 unit in Statics and 1/3 unit in Controls.
  7. Must include at least 1/3 unit of Social Implications of Technology (CS 3043, GOV 2302, GOV/ID 2314, IMGD 2000, STS 2208)..
  8. Must include at least 1 unit from a list of Robotics Electives, of which at least 1/3 unit must be in Advanced Systems (CS 4341, ECE 3308, ME 3310).
  9. The MQP must be a Capstone Design Experience in Robotics Engineering.
- \* 6 units if GOV 2302, GOV/ID 2314, or STS 2208 are double-counted as meeting the Social Science Requirement and Engineering Science and Design Requirement.

### OTHER ROBOTICS PROGRAMS

WPI students can also pursue specializations involving Robotics in several departments and programs. The department of Electrical and Computer Engineering and the department of Computer Science both encourage a focus on robotics, as detailed in their departmental descriptions. The department of Mechanical Engineering is developing a similar focus. All three of these departments have sponsored final capstone design projects involving the application of their disciplines to robotics.

Robotics activities are coordinated by Ken Stafford, Manager of Academic Initiatives and head of the WPI FIRST competitive program. He oversees an active lab where students design various robotics devices in the lower level of Higgins Laboratories. You may contact him for information at (508) 831-6122 or [stafford@wpi.edu](mailto:stafford@wpi.edu).

## SOCIAL SCIENCE AND POLICY STUDIES

### J. K. DOYLE, HEAD

PROFESSORS: J. T. O'Connor, K. Saeed

ASSOCIATE PROFESSORS: J. K. Doyle, M. J. Radzicki, K. J. Rissmiller, J. M. Wilkes

ASSISTANT PROFESSORS: O. Pavlov, J. Skorinko

PROFESSOR OF PRACTICE: J. Lyneis

ADJUNCT FACULTY: W. Baller, R. Eberlein, A. Ford, J. Gobert, G. Heaton, J. Hines, B. Karanian, M. Miller, K. Warren

RESEARCH ASSOCIATE PROFESSOR: J. Gobert

### MISSION STATEMENT

SSPS programs are concerned with the substance and the process of social and economic problem solving especially as related to technological development, the environment, and public policy. Most social and economic problems go beyond the boundaries of the traditional social science disciplines. Hence, the courses offered by the Department of Social Science and Policy Studies attempt to integrate knowledge and research techniques from multiple disciplines. Our curriculum covers economics, sociology, psychology, system dynamics, law and political science. The department encourages students to view social and economic problems, and the relationship of technology to society, from a variety of perspectives and to become acquainted with different methods of gathering and analyzing social data.

The SSPS department offers undergraduate majors in several policy related disciplines. In addition, the department administers WPI's two-course requirement in the Social Sciences.

Complete descriptions of the department's major and minor requirements, and recommendations for completing the social science requirement are available on the SSPS Department web site at [www.wpi.edu/Academics/Depts/SSPS](http://www.wpi.edu/Academics/Depts/SSPS).

### PROGRAM OUTCOMES

Graduates of a social science major must have demonstrated through coursework and projects:

1. An ability to recognize patterns in real world data, qualitative and quantitative, in order to be able to define problems.
2. An ability to formulate hypotheses and models representing problems and understand their logic.
3. An ability to experiment with hypotheses to establish their validity.
4. An ability to carry out appropriate analyses to arrive at effective solutions to addressing the defined problems.
5. Literacy in the technical aspects of a problem in the student's area of concentration.
6. An ability to effectively communicate the results of an analysis.
7. An ability to work in groups.
8. Computer literacy.

## Program Distribution Requirements for the Economic Science, Environmental Policy and Development, Psychological Science, Society Technology and Policy, and System Dynamics Majors

The normal period of residency at WPI is 16 terms. In addition to the WPI requirements applicable to all students, completion of a minimum of 10 units of study is required in social science, basic science, and mathematics as follows:

### ECONOMIC SCIENCE

REQUIREMENTS	MINIMUM UNITS
1. Economics (Note 1).	3
2. Economics and/or Management (Note 2)	2/3
3. Other Social Science	1
4. Modeling Techniques	2/3
5. Mathematics (Note 3)	2
6. Basic Science	1
7. Electives	2/3
8. MQP	1

#### NOTES:

1. Must include courses in both micro and macro economic theory at the intermediate level and in econometrics and international trade (available through the Consortium or independent study).
2. Must include financial accounting, ACC1100. May include other relevant management courses as approved by the Departmental Program Review Committee.
3. Must include differential equations, integral calculus, and statistics.

### ENVIRONMENTAL POLICY AND DEVELOPMENT

REQUIREMENTS	MINIMUM UNITS (NOTE 1)
1. Social Science and Policy Studies (Note 2).	4
2. Mathematics (Note 3).	5/3
3. Basic Science (Note 4).	2/3
4. Technical Concentration (Note 5).	2
5. Department Electives (Note 6).	2/3
6. MQP.	1

#### NOTES:

1. 1/3 unit = 1 course. 15 units are required for graduation.
2. Students must complete 5/3 units (5 courses) in one of three social science areas: (a) economics, (b) psychology/sociology, (c) political science (includes SS & PS courses in law and policy analysis) and 2/3 unit (2 courses) in each of the other two social science areas. The particular courses chosen must include six out of the following nine courses: Environmental Problems and Human Cognition, American Public Policy, Development Economics, Environmental Economics, International Environmental Policy, Introduction to System Dynamics Modeling, Environmental Policy and Law, Governmental Decision Making and Administrative Law, and the Society-Technology Debate. Students must also complete three other social science courses (1 unit) of their choosing.
3. Must include both calculus and statistics.
4. Basic science courses must be selected from the disciplines of Physics, Chemistry, or Biology.
5. The technical concentration must include at least six thematically related courses in science, engineering or management that have been approved by the Department's Program Review Committee.
6. Departmental electives must be selected from the areas of mathematics, basic science, social science, or the technical concentration.

### PSYCHOLOGICAL SCIENCE

REQUIREMENTS	MINIMUM UNITS
1. Psychological Science (Note 1)	3
2. Psychological Science and/or Related Courses (Note 2)	1
3. Other Social Science (Note 3)	1
4. Basic Science, Computer Science, and/or Engineering (Note 4)	5/3
5. Mathematics (Note 5)	4/3
6. Electives (Note 6)	1
7. MQP	1

#### NOTES:

1. Must include introductory psychology, social psychology, cognitive psychology, and research methods.
2. Related courses must be chosen from a list of psychology-related courses from other departments maintained by the Psychology Program Review Committee.
3. May include no more than two courses at the 1000-level.
4. Must include 1/3 unit of biology. Must include 1/3 unit of computer science (except CS 2022 and CS 3043).
5. Must include 2/3 units of calculus and 2/3 unit of statistics.
6. The 1 unit of electives must be coherently defined and approved by the Psychology Program Review Committee.

### SOCIETY, TECHNOLOGY AND POLICY

REQUIREMENTS	MINIMUM UNITS
1. Social Science (Notes 1, 2).	4
2. Minimum Basic Science background.	2/3
3. Minimum Mathematics background (Note 3).	1
4. Technical concentration (Note 4).	5/3
5. Electives (Note 5).	5/3
6. MQP	1

#### NOTES:

1. Students must obtain approval of their proposed program from the Departmental Program Review Committee. Course distribution will focus on a disciplinary specialty and either policy analysis or a society-technology specialization such as Social Impact Analysis or Technology Assessment.
2. Relevant Humanities or Management courses approved by the Departmental Review Committee may be counted for a maximum of 2/3 of a unit in fulfilling the 4-unit requirement.
3. One course in calculus-based statistics is required.
4. A series of courses in one field of science, engineering, or management or a combination of courses approved by the departmental review committee which focus on issues to be developed in the MQP.
5. These courses are to be approved by the Departmental Review Committee and are meant to broaden the technical concentration and tie it to social concerns.

### SYSTEM DYNAMICS

REQUIREMENTS	MINIMUM UNITS
1. System Dynamics (Note 1)	5/3
2. Other Social Science (Note 2)	5/3
3. Management (Note 3)	2/3
4. Mathematics/basic sciences/engineering (Note 4)	8/3
5. Computer Science (Note 5)	2/3
6. Application Area (Note 6)	5/3
7. MQP	1



**NOTES:**

1. Only social science courses with a "5" in the second digit of the course number count toward the system dynamics requirement.
2. Must include microeconomics or macroeconomics, cognitive or social psychology, and public policy.
3. Must include organizational science.
4. Must include differential and integral calculus, differential equations, and numerical or statistical analysis.
5. Courses on computer programming and programming languages are recommended.
6. This requirement is satisfied by a cohesive set of work from the fields of social science, management, science, mathematics, computer science, or engineering as specified in the curriculum the guidelines for system dynamics major.

## DESCRIPTIONS OF CONCENTRATION AREAS AVAILABLE IN ECONOMIC SCIENCE

Economic Science majors may focus their studies by choosing a Concentration within one of the following two specific areas of Economics: Sustainable Economic Development and Computational Economics. These concentration areas reflect the growing importance of environmental issues and computational tools within the discipline of economics and are areas of strength in teaching and research in economic science at WPI. Concentrations within the Economics Science major comply with WPI's requirements for concentrations. Students must complete an MQP and two units of integrated study in the area of their Concentration.

**Sustainable Economic Development.** The term sustainable economic development means choosing policies that balance environmental preservation and economic development so as to meet the needs of the present generation without seriously compromising the needs of future generations. The sustainable development concentration examines the economic, psychological, social, political, legal, and technical issues surrounding the creation of policies aimed at establishing sustainable economic systems at the local, national, and international levels.

1. 1 unit from the following list of courses in economic development:
 

ECON 2125	Development Economics
ECON 2117	Environmental Economics
CE 3070	Urban Environmental Planning
CE 3074	Environmental Analysis
HI 3333	Topics in American Technological Development
2. 1 unit from the following list of environmental courses in other social science disciplines, humanities, and biology, or additional courses from list 1:
 

BB 1002	Environmental Biology
BB 4140	Ecological Management
GOV 2311	Legal Regulation of the Environment
GOV 2312	International Environmental Policy
PSY 2405	Environmental Problems and Human Cognition
PY 2717	Philosophy and the Environment

**Computational Economics.** Students in the computational economics concentration supplement their knowledge of traditional tools of economic analysis by studying modern computational techniques. Student projects may address problems of complex macroeconomic modeling, chaos, computational finance, design of automated Internet markets, and many more. This concentration draws on the expertise and talent of the faculty in various departments throughout the university.

1. 1 unit from the following list of courses in system dynamics:
 

SD 1510	Introduction to System Dynamics Modeling
SD 1520	System Dynamics Modeling
SD 2530	Advanced Topics in System Dynamics Modeling
SD 3550	System Dynamics Seminar
2. 1 unit from the following list of courses offered in other departments:
 

BB 4250	Ecological Simulation Modeling
CS 2022/MA2201	Discrete Mathematics
CS 4032/MA3257	Numerical Methods for Linear and Nonlinear Systems
CS 4033/MA3457	Numerical Methods for Calculus and Differential Equations
CS 4341	Introduction to Artificial Intelligence
ES 3011	Control Engineering I
OIE 3460	Simulation Modeling and Analysis
OIE 3501	Management Science II: Risk Analysis
MA 2210	Mathematical Methods in Decision Making
MA 2431	Mathematical Modeling with Ordinary Differential Equations
MA 3471	Advanced Ordinary Differential Equations
MA 4235	Mathematical Optimization
MA 4411	Numerical Analysis of Differential Equations

## DOUBLE MAJOR IN SOCIAL SCIENCE AND POLICY STUDIES

Any of the department majors programs outlined above may be taken as part of a double major in which the student majors in an area of science, engineering or management as well as social science. To obtain a double major, the student must satisfy all of the degree requirements of the technical discipline including an MQP and Distribution requirements. In addition, the double major in Social Science and Policy Studies requires four units of study in social science (inclusive of the normal two-course social science requirement) and the completion of a second qualifying project which combines the IQP and social science MQP into a single one-unit project. Unlike other double majors, the double major in Social Science and Policy Studies does not require three qualifying projects: two MQP's and an IQP. However, the combined social science MQP and IQP must meet the goals of both. It must be interactive in nature involving an aspect of technology as well as in application of social science knowledge and analytical techniques. The decision to pursue the social science double major should be made fairly early in the student's academic career, certainly early enough to ensure the selection of an appropriate IQP/MQP.

## SOCIAL SCIENCE MINORS

A Social Science Minor is available in any of the following disciplines:

- Economics
- Sociology
- Political Science and Law
- Psychology
- System Dynamics
- Social Science

A minor in the Social Sciences consists of 2 units of academic activity satisfying the following conditions:

### 1. Foundations

Introductory level courses in any one or two social science disciplines taught at WPI: economics (ECON), sociology (SOC), political science (and law) (GOV), psychology (PSY), and system dynamics (SD). Introductory courses are identified by the first digit of the course number, which must be a 1. The second digit of the course number indicates the discipline (1–economics, 2–sociology, 3–political science and law, 4–psychology, and 5–system dynamics).

### 2. Applied Courses (At least 1 unit)

Three or more higher level courses in the same social science discipline as the foundation courses, which involve applications or extensions of the material covered in the introductory courses and list the introductory courses as recommended background. High level courses have either a 2, 3, or 4 as the first digit of the course number. The capstone experience will consist of a paper in the last applied course taken. The paper must draw upon and integrate material covered in the previous courses. An IQP may provide the capstone experience and substitute for the last applied course provided that the IQP was advised or co-advised by a member of the Social Science & Policy Studies department, and contains appropriate social science analysis.

3. If five or more of the six 1/3 units required for the minor are in a single social science discipline, the title of the minor will be “Minor” in that discipline.\* Otherwise the title of the minor will be “Minor in Social Science.” Examples of minor programs in economics, sociology, political science (and law), psychology, system dynamics and interdisciplinary social science are available at the SS & PS department office. The course selected for an interdisciplinary social science minor should follow an identifiable theme, such as the relationship between technology and society or social, political, economic or environmental policies.

Students taking minors in the social sciences are expected to designate a member of the SS & PS department as their SS minor advisor, who will assist them in preparing a program that meets the requirements of the minor. Students can obtain assistance at the SS & PS departmental office in designating an advisor.

Students completing any major in the Social Science and Policy Studies Department may not also complete a minor in social sciences.

\* In designating sociology the minor, the course PSY 1402, Social Psychology, can be counted as one of the five courses required in Sociology. In designating the economics minor, at least 3 of the 5 required courses must be chosen from among the following four theory courses:  
 ECON 1110 Introductory Microeconomics;  
 ECON 1120 Introductory Macroeconomics;  
 ECON 2210 Intermediate Microeconomics; and  
 ECON 2120 Intermediate Macroeconomics.

# COURSE DESCRIPTIONS

## SECTION 3

Air Force Aerospace Studies . . . . .	105
Basic Sciences (Geology) . . . . .	106
Biology and Biotechnology . . . . .	106
Biomedical Engineering . . . . .	110
Chemical Engineering . . . . .	112
Chemistry and Biochemistry . . . . .	114
Civil and Environmental Engineering . . . . .	117
Computer Science . . . . .	119
Electrical and Computer Engineering . . . . .	122
Engineering Science Interdisciplinary . . . . .	126
Fire Protection Engineering . . . . .	127
Humanities and Arts . . . . .	128
Interactive Media and Game Development . . . . .	140
Interdisciplinary . . . . .	141
Management . . . . .	142
Mathematical Sciences . . . . .	146
Mechanical Engineering . . . . .	149
Military Science . . . . .	154
Physical Education . . . . .	155
Physics . . . . .	156
Robotics Engineering . . . . .	158
Social Science and Policy Studies . . . . .	159

# COURSES QUALIFYING FOR ENGINEERING DISTRIBUTION AREAS

## Mathematics

All Courses designated "MA."

Advanced placement established by AP exam or through passing WPI advanced courses (see page 196) also qualify.

## Basic Science

All courses designated "PH," "CH," "BB," and GE 2341.

## Engineering Science/Design

The following courses may be applied to the "Engineering Science and Design" distribution requirement for each respective engineering major:

**BME:** All courses designated "BME" (except BME 3110) and CE, CHE, ECE, and ME courses at the 2000-level or above.

**CE:** All courses designated "CE". Also ES 2503 and ES 3004.

**CHE:** All courses designated "CHE." Also ES 3002, ES 3003, ES 3004, and other courses approved by the Chemical Engineering Department. See the department web site, and consult with your academic advisor for details.

**ECE:** All courses designated "ECE" (except ECE 3601) and ES 3011 may be included in the six-unit ECE area distribution requirement.

**ME:** All courses designated "ME" except ME 3601.

**IE:** OIE courses including OIE 2500, OIE 3401, OIE 3405, OIE 3420, OIE 3450, OIE 3460, OIE 3501, OIE 4410, and OIE 4460.

In addition, engineering majors selecting "Engineering Science/Design" courses from outside their major may choose appropriate activities from any of the following:

All courses designated ES, ECE, CHE, ME.

All OIE courses listed above (for ME majors only).

All courses designated as CE except CE 3022.

All courses designated as CS except CS 1101, CS 1102, and CS 3043.

(Electrical and Computer Engineering majors are restricted to these courses at the 2000-level or higher.)

All ABET engineering programs require six units of Engineering Science and Design.

All graduate-level courses may be counted in the appropriate categories.

## COURSE DESCRIPTIONS

### COURSE CATEGORIES

For purposes of planning programs of study, courses at WPI are divided into two categories.

#### *Category I (Cat. I)*

These courses cover core material of interest to large numbers of students. Category I courses are offered at least once a year.

#### *Category II (Cat. II)*

Category II courses are usually offered every other year.

### BACKGROUND

#### *Recommended*

The course will build on material in the recommended course. Instructors can assume that the student is knowledgeable of the material from the recommended course or from other experiences.

#### *Suggested*

The material from this course would be helpful to the student, but it is not assumed background.

### CATALOG AND SCHEDULE ON THE WWW

The catalog and course schedule can be found on the world wide web at [www.wpi.edu/+ugradcat](http://www.wpi.edu/+ugradcat) and [www.wpi.edu/+schedules](http://www.wpi.edu/+schedules).

### COURSE NUMBERING

Each course at WPI is designated by a two-letter prefix identifying the subject area followed by a four digit number. The first digit is coded as follows:

- 1 — Courses for which first-year students will receive priority in registration. Upper class students may register on a space-available basis.
- 2 — Basic level courses.
- 3 — Advanced level undergraduate courses for which no graduate credit is given. (This restriction may be waived at the discretion of the degree department.)
- 4 — Advanced level undergraduate courses for which graduate credit may also be given.
- 5 — Graduate courses.

The last three digits may be used by the departments to indicate subject areas. Many graduate courses are also available to undergraduates.

### COURSE CREDIT

Unless otherwise indicated, WPI courses usually carry credit of 1/3 unit. This level of activity suggests at least 17 hours of work per week, including class and laboratory time. The usual workload per term is 1 unit.

## AIR FORCE AEROSPACE STUDIES

### AS 1001. THE FOUNDATIONS OF THE UNITED STATES AIR FORCE I.

*Cat. I (1/9 unit)*

The AS 1000 sequence of courses are designed to introduce students to the United State Air Force and Air Force Reserve Officer Training Corps. Featured topics include mission and organization of the Air Force, officership and professionalism, Air Force officer opportunities, military customs and courtesies, and an introduction to communication skills.

The first course focuses on the foundation of officership and customs and courtesies.

The course includes one hour of class work and two hours of mandatory leadership laboratory per week. The AS 1001 Leadership Laboratory includes a study of Air Force customs and courtesies, drill and ceremonies, and military commands.

### AS 1002. THE FOUNDATIONS OF THE UNITED STATES AIR FORCE II.

*Cat. I (1/9 unit)*

The AS 1000 sequence of courses are designed to introduced students to the United State Air Force and Air Force Reserve Officer Training Corps.

A continuation of AS 1001, the second course in this series emphasizes those communication skills needed in today's Air Force. It describes the communication systems, discusses common barriers and enhancements to effective communications. The course includes numerous speaking and written exercises using current Air Force topics.

The course includes one hour of class work and two hours of mandatory leadership laboratory per week. The AS 1002 Leadership Laboratory includes a study of Air Force customs and courtesies, drill and ceremonies, and military commands.

### AS 1003. THE FOUNDATIONS OF THE UNITED STATES AIR FORCE III.

*Cat. I (1/9 unit)*

The AS 1000 sequence of courses are designed to introduce students to the United State Air Force and Air Force Reserve Officer Training Corps.

A continuation of AS 1002, the course outlines the origin of the Air Force and the organizational structure of the Air Force with a focus on the missions of select military organizations. The basic history of the United States military is studied in order to appreciate how military history impacts the Air Force today. Written and oral communication skills are practiced.

The course includes one hour of class work and two hours of mandatory leadership laboratory per week. The AS 1003 Leadership Laboratory includes a study of Air Force customs and courtesies, drill and ceremonies, and military commands.

### AS 1004. THE FOUNDATIONS OF THE UNITED STATES AIR FORCE IV.

*Cat. I (1/9 unit)*

The AS 1000 sequence of courses are designed to introduced students to the United State Air Force and Air Force Reserve Officer Training Corps. The final course in the AS 1000 sequence, it introduces students to the Air Force installation and her sister services. Written and oral communication skills are practiced.

The course includes one hour of class work and two hours of mandatory leadership laboratory per week. The AS 1004 Leadership Laboratory includes a study of Air Force customs and courtesies, drill and ceremonies, and military commands.

### AS 2001. THE EVOLUTION OF USAF AIR AND SPACE POWER I.

*Cat. I (1/9 unit)*

The AS 2000 sequence of courses are designed to examine general aspects of air and space power through a historical perspective. Utilizing this perspective, the course covers a time period from the first balloons and dirigibles to the space-age global positioning systems of the Persian Gulf War. Historical examples are provided to extrapolate the development of Air Force capabilities (competencies), and missions (functions) to demonstrate the evolution of what has become today's USAF air and space power. As a whole, the AS 2000 sequence of courses provides the student with a knowledge level understanding for the general element and employment of air and space power.

The first course covers the factors leading to the early development of air power through the use of air power during World War II. The development of oral and written communication skills is continued from the AS 1000 classes.

The course includes one hour of class work and two hours of mandatory leadership laboratory per week. The AS 2001 Leadership Laboratory continues a study of Air Force customs and courtesies, drill and ceremonies, military commands, and preparation for Field Training.

### AS 2002. THE EVOLUTION OF USAF AIR AND SPACE POWER II.

*Cat. I (1/9 unit)*

The AS 2000 sequence of courses are designed to examine general aspects of air and space power through a historical perspective. The second course in the series continues with the development of air power from World War II through the development of the Intercontinental Ballistic Missile.

The course includes one hour of class work and two hours of mandatory leadership laboratory per week. The AS 2002 Leadership Laboratory continues a study of Air Force customs and courtesies, drill and ceremonies, military commands, and preparation for field training.

### AS 2003. THE EVOLUTION OF USAF AIR AND SPACE POWER III.

*Cat. I (1/9 unit)*

The AS 2000 sequence of courses are designed to examine general aspects of air and space power through a historical perspective. The third course in the series begins with a study of air power in the Vietnam war through the Gulf war. Oral and written communications skills will be practiced.

The course includes one hour of class work and two hours of mandatory leadership laboratory per week. The AS 2003 Leadership Laboratory continues a study of Air Force customs and courtesies, drill and ceremonies, military commands, and preparation for field training.

### AS 2004. THE EVOLUTION OF USAF AIR AND SPACE POWER IV.

*Cat. I (1/9 unit)*

The AS 2000 sequence of courses are designed to examine general aspects of air and space power through a historical perspective. The course examines several fundamental truths associated with war in the third dimension: e.g. Principles of War and Tenets of Air and Space Power. As a whole, this course provides the students with a knowledge level understanding for the general element and employment of air and space power, from an institutional doctrinal and historical perspective. In addition, the students will continue to discuss the importance of the Air Force Core Values with the use of operational examples and historical Air Force leaders and will continue to develop their communication skills. The final course in the series explores the future of the Air Force through 2025.

The course includes one hour of class work and two hours of mandatory leadership laboratory per week. The AS 2004 Leadership Laboratory continues a study of Air Force customs and courtesies, drill and ceremonies, military commands, and preparation for field training.

### AS 3001. AIR FORCE LEADERSHIP STUDIES I.

*Cat. I (1/6 unit)*

The AS 3000 sequence of courses is a study of leadership, management fundamentals, professional knowledge, Air Force personnel and evaluation systems, leadership ethics, and communication skills required of an Air Force junior officer. Throughout the courses, case studies are used to examine Air Force leadership and management situations as a means of demonstrating and exercising practical application of concepts being studied.

The first course explores different styles of leadership, followership, and management functions.

The course includes three hours of class work and three hours of mandatory leadership laboratory per week. The AS 3001 Leadership Laboratory complements the classroom work by providing advanced leadership experiences in officer-type activities and giving students the opportunity to apply leadership and management principles.

### AS 3002. AIR FORCE LEADERSHIP STUDIES II.

*Cat. I (1/6 unit)*

The AS 3000 sequence of courses is a study of leadership, management fundamentals, professional knowledge, Air Force personnel and evaluation systems, leadership ethics, and communication skills required of an Air Force junior officer. The second course studies various aspects of leadership, conflict management, counseling, and supervision.

The course includes three hours of class work and three hours of mandatory leadership laboratory per week. The AS 3002 Leadership Laboratory complements the classroom work by providing advanced leadership experiences in officer-type activities and giving students the opportunity to apply leadership and management principles.

### AS 3003. AIR FORCE LEADERSHIP STUDIES III.

*Cat. I (1/6 unit)*

The AS 3000 sequence of courses is a study of leadership, management fundamentals, professional knowledge, Air Force personnel and evaluation systems, leadership ethics, and communication skills required of an Air Force junior officer. The third course emphasizes teambuilding, improvement process, and military ethics.

The course includes three hours of class work and three hours of mandatory leadership laboratory per week. The AS 3003 Leadership Laboratory complements the classroom work by providing advanced leadership experiences in officer-type activities and giving students the opportunity to apply leadership and management principles.

#### AS 3004. AIR FORCE LEADERSHIP STUDIES IV.

*Cat. I (1/6 unit)*

The AS 3000 sequence of courses is a study of leadership, management fundamentals, professional knowledge, Air Force personnel and evaluation systems, leadership ethics, and communication skills required of an Air Force junior officer. The final course explores officer professional development, and personnel and evaluation systems including practical exercises.

The course includes three hours of class work and three hours of mandatory leadership laboratory per week. The AS 3004 Leadership Laboratory complements the classroom work by providing advanced leadership experiences in officer-type activities and giving students the opportunity to apply leadership and management principles.

#### AS 4101. NATIONAL SECURITY AFFAIRS I.

*Cat. I (1/6 unit)*

The AS 4000 sequence of courses examines the national security process, regional studies, advanced leadership ethics, and Air Force doctrine. Special topics of interest focus the military as a profession, officership, military justice, civilian control of the military, preparation for active duty and current issues affecting military professionalism. Throughout the AS 4000 sequence of courses, briefing and writing exercises will be accomplished with emphasis on refining communication skills.

The first course examines in depth the national security process, principles of war and the Air Force major commands.

The course includes three hours of class work and three hours of mandatory leadership laboratory each week. The AS 4101 Leadership Laboratory complements the classroom work by providing advanced leadership experiences in officer-like activities and giving the students the opportunity to apply leadership and management principles.

#### AS 4102. NATIONAL SECURITY AFFAIRS II.

*Cat. I (1/6 unit)*

The AS 4000 sequence of courses examines the national security process, regional studies, advanced leadership ethics, and Air Force doctrine. The second course provides a detailed examination of Air Force doctrine including a study of the joint doctrine and the roles of the other military services.

The course includes three hours of class work and three hours of mandatory leadership laboratory each week. The AS 4102 Leadership Laboratory complements the classroom work by providing advanced leadership experiences in officer-like activities and giving the students the opportunity to apply leadership and management principles.

#### AS 4103. NATIONAL SECURITY AFFAIRS III.

*Cat. I (1/6 unit)*

The AS 4000 sequence of courses examines the national security process, regional studies, advanced leadership ethics, and Air Force doctrine. The third course provides an extensive study of alliances and regional security issues, including international peacekeeping and terrorism. Continued attention is given to developing the research and communications skills required by junior officers.

The course includes three hours of class work and three hours of mandatory leadership laboratory each week. The AS 4103 Leadership Laboratory complements the classroom work by providing advanced leadership experiences in officer-like activities and giving the students the opportunity to apply leadership and management principles.

#### AS 4104. PREPARATION FOR ACTIVE DUTY.

*Cat. I (1/6 unit)*

The AS 4000 sequence of courses examines the national security process, regional studies, advanced leadership ethics, and Air Force doctrine. The final course in the series examines officership, the military justice system, social responsibilities, current issues affecting the military profession, and various factors that will facilitate a smooth transition from civilian to military life.

The course includes three hours of class work and three hours of mandatory leadership laboratory each week. The AS 4104 Leadership Laboratory complements the classroom work by providing advanced leadership experiences in officer-like activities and giving the students the opportunity to apply leadership and management principles.

## BASIC SCIENCES

### GEOSCIENCES (GE)

#### GE 2341. GEOLOGY.

*Cat. I*

Students of this course will examine the fundamental principles of physical geology including the materials, structures, and surface features of the earth and the processes which produced them. Emphasis will be placed on the interrelationship of people and environment and applications to various fields of technology. The course includes field trips and a significant laboratory component.

## BIOLOGY AND BIOTECHNOLOGY

#### BB 1001. INTRODUCTION TO BIOLOGY.

*Cat. I*

This course consists of an overview of the major concepts of Biology, including: cell theory, bioenergetics, molecular biology, reproduction, nutrition, growth, development, homeostatic controls, and ecological issues. This course is intended for students seeking a broad overview of contemporary Biology with emphasis on human issues and current topics.

Recommended background: high school or introductory college level chemistry.

#### BB 1002. ENVIRONMENTAL BIOLOGY.

*Cat. I*

This course provides an introduction to natural ecosystems, population growth, and the interaction between human populations and our environment. Major areas of discussion include Ecosystems, Populations, Biodiversity, Pollution, and Environmental Economics. This course is designed for students seeking a broad overview of ecological systems and the effect of humans on the ecosystems.

Recommended background: High School biology.

#### BB 1035 INTRODUCTION TO BIOTECHNOLOGY.

*Cat. I*

Current topics and issues in Biotechnology will be investigated. Some examples of topics which may be investigated in detail include: cloning, DNA fingerprinting and molecular forensics, transgenic organisms, "green" engineering and bioremediation, bioprocess and metabolite engineering, bioinformatics, and mathematical modeling of biological systems.

Recommended background: high school biology and chemistry.

#### BB 1045 BIODIVERSITY.

*Cat. I*

This course is an integrated survey of the five kingdoms which stresses general concepts and economically important species. Particular attention will be paid to special structures and mechanisms evolved by selected representatives of major phyla of plants and animals for solving problems of life in various environments.

Recommended background: high school biology or equivalent.

#### BB 2002. MICROBIOLOGY.

*Cat. I*

This course will focus on unicellular organisms with special reference to those of the domain Bacteria, and describe their taxonomy, morphology, and physiology. Special attention will be given to those organisms that are of ecological concern or serve a useful industrial purpose. The importance of microbes and viruses in public health will be presented. This course is designed for all biology majors and other students who seek a good general education in modern biology.

Recommended background: A basic understanding of cell biology and elementary biochemical processes is desired.

#### BB 2030. PLANT DIVERSITY.

*Cat. I*

An introductory course stressing general concepts related to the vast array of plant species, taxonomic links, and uses of major plant phyla in both society and industry. Some emphasis will be given to economically important species chosen from agronomic and non-agronomic situations.

Recommended background: BB 1045.

Students may not receive credit for both BB 2030 and BB 1040.



**BB 2040. PRINCIPLES OF ECOLOGY.***Cat. I*

This course is designed to give the student a basis for understanding the abundance and distribution of plants and animals from the level of the individual to that of the ecosystem. Topics may include population ecology, competition, community ecology, patterns of species diversity, and energy flow.

Recommended background: BB 1045, and MA 1021-1022.

**BB 2550. CELL BIOLOGY.***Cat. I*

This entry level course, recommended for all BIO, BC, and pre-professional majors, presents the fundamental aspects of cell structure and function, and is the foundation of all fields of modern biology.

Topics include: cell complexity and organizational hierarchy, evolution of the cell, cell surface, plasma membrane, single and double cytoplasmic membrane systems, nuclear fusion and hybridomas, cytoskeleton, cell growth, and differentiation.

Recommended background: BB 1001, BB 1035, or equivalent.

**BB 2920. GENETICS.***Cat. I*

This course presents the principles and experimental evidence leading to our understanding of the gene concept and the role of DNA as genetic material. Patterns of inheritance, the relationship between genotype and phenotype, and transmission, coding, and expression of genetic information are considered in a variety of organisms. A quantitative, problem-solving approach and the use of genetic analysis as a tool to study biological phenomena are emphasized throughout the course. The course is designed for all biology and pre-professional majors.

Recommended background: BB 1035.

**BB 3040. EXPERIMENTAL DESIGN AND DATA ANALYSIS.***Cat. II*

This applied course introduces students to the design of experiments and analysis of data. We will cover a number of experimental situations occurring frequently in biology, including testing the fit of data to theoretical distributions, comparisons of groups, and regression analysis. Emphasis will be placed on formulating the hypothesis of interest, designing experiments so that the subsequent analysis will have enough power to test the hypothesis, and choosing the appropriate analysis to perform. We will discuss the importance of pilot studies, and some of the most common errors made in choosing and performing statistical tests. Both parametric and non-parametric tests will be discussed. Students will use computer packages to analyze data from the literature and/or their own experimental data.

Recommended background: MA 2611, and any 3000 or 4000 level BB course.

Offered in 2008-09 and in alternating years thereafter.

**Note:** Students who have credit for BB 4040 may not receive credit for BB 3040.

**BB 3055. MICROBIAL PHYSIOLOGY.***Cat. I*

This course will focus on the metabolic (enzymatic) pathways by which microorganisms obtain, process, and store substances and energy used for synthesis; and on the synthetic pathways by which these substances and energy are utilized. The occurrence of biological reactions in the light of the particular organism and its environment will be emphasized, as will those organisms and metabolic schemes of current or potential usefulness in bioprocess technology.

Recommended background: BB 2002, BB 2550.

Students who have taken BB 4050 for credit will not receive credit for BB 3055.

**BB 3080. NEUROBIOLOGY.***Cat. I*

An introduction to neurobiology, with emphasis on the cellular and molecular basis of neural development and function. Topics will range from electrical and biochemical signaling between neurons, to higher order functions of the nervous system, such as sensation, movement, and memory. Human neurological diseases and disorders will be discussed. Some guided reading of the primary literature will be included.

Recommended background: BB 2550, BB 2920, and BB 3101.

Students may not receive credit for both BB 4080 and BB 3080.

**BB 3101. HUMAN ANATOMY & PHYSIOLOGY: MOVEMENT AND COMMUNICATION.***Cat. I*

The form and function of the systems that are responsible for the support, movement, internal communication, and interaction of the human body with its environment will be presented and discussed: Integumentary, Skeletal, Muscular, Nervous (including the senses), and Endocrine.

Recommended background: BB 2550 Cell Biology or BB 1001, Introduction to Biology. Suggested background: Concurrent Laboratory Module: BB 3511 (Nerve and Muscle Physiology). Students who have received credit for BB2130 (Human Anatomy) may not take BB3101 for credit.

**BB 3102. HUMAN ANATOMY & PHYSIOLOGY: TRANSPORT AND MAINTENANCE.***Cat. I*

The form and function of the systems of the human body that provide for the intake, distribution, and processing of nutrients, water, and oxygen, and the systems that safeguard health by elimination of wastes, regulation of metabolism, and surveillance against disease will be presented and discussed. Digestive, Respiratory, Circulatory, Lymphatic, Endocrine, Urinary, and Reproductive.

Recommended Background: BB 2550 (Cell Biology); either BB 1001 (Introduction to Biology) or BB 1035 (Introduction to Biotechnology); CH 1010 and CH 1020 (General Chemistry). Suggested background: Concurrent Laboratory Module: BB 3514 (Circulatory and Respiratory Physiology). Students who have received credit for BB3110 (Animal Physiology) may not take BB 3102 for credit.

**BB 3120. PLANT PHYSIOLOGY AND CELL CULTURE.***Cat. I*

The relationship of structure and function of multicellular plants will be examined at the biochemical level. Topics include (but are not limited to): water relations, mineral nutrition, intra- and inter-cellular transport, hormones, photosynthesis, in vitro culture of plant cells/tissues/organs, and environmental responses.

Recommended background: BB 1045, BB 2550, CH 1020.

**BB 3140. EVOLUTION: PATTERN AND PROCESS.***Cat. II*

We will explore several theoretical constructs of evolutionary processes. Topics will range from microevolutionary patterns to global extinctions and speciation. We will examine the causes of evolutionary trends from the molecular to the group level. Readings from current research into the units and levels of selection will be included.

Recommended background: BB 2550, BB 2920, at least one of (BB 1045, BB 2040).

This course will be offered in 2009-10 and in alternating years thereafter.

**BB 3160. BEHAVIORAL ECOLOGY.***Cat. I*

This course will deal with the interface among the fields of animal behavior, ecology, and evolution. Adaptive advantage (or disadvantage) conferred by behaviors at the individual and social level will be studied. Topics will include individual decision-making in response to the environment, cooperation and conflict among individuals, kin selection, parental investment theory, sexual and natural selection and the evolution of social behavior, and sensory systems and the design of signals.

Recommended background: BB 1045, BB 2040, BB 3140.

**BB 3170. PLANT MORPHOLOGY AND DEVELOPMENT.***Cat. II*

This course will focus on the form and function of developing plant structures. Beginning with the unique aspects of plant cells, the course will progress to include tissue and organ anatomy and will cover the phenomena responsible for defining the gross morphology of the organism. Coverage of these topics will culminate in an understanding of the integrated development of the whole plant. Some guided reading of the primary literature will be included.

Recommended background: BB 2030 and BB 2550.

This course will be offered in 2008-09 and in alternating years thereafter.

**BB 3620. DEVELOPMENTAL BIOLOGY.***Cat. II*

This advanced level course provides a detailed survey of the processes of animal development, including fertilization, cleavage, gastrulation, and organogenesis. These processes are examined in the context of concepts such as differentiation, determination, induction, intercellular signaling, morphogenesis, and pattern formation. Emphasis is placed on current techniques for studying development, such as genetic analysis of mutations, recombinant DNA technology, molecular probing of gene expression, and gene transfer. The experimental focus is on model organisms such as nematodes, fruit flies, frogs, and mice.

Offered in 2009-10 and in alternating years thereafter.

Recommended background: BB 2002, BB 2550, BB 2920.

**BB 3920. IMMUNOLOGY.***Cat. I*

This is a survey course in immunology which assumes a background in cell biology, genetics and biochemistry. Topics to be covered will include cells of the immune system, antigen/antibody immunochemistry, immunogenetics and immune responses. Readings from research literature will be assigned.

Recommended background: BB 2550, BB 2920, CH 4110, and CH 4120.

**BB 4008. CELL CULTURE THEORY AND APPLICATIONS.***Cat. I*

The use of cultured animal cell systems for research and production will be explored. Concepts, including media design, the effects of extracellular matrices, scaling up of cell cultures, and biochemical and morphologic assessment of cell function, will be discussed as a basis for readings from the literature.

Recommended background: BB 2550, BB 2920, CH 4110, and CH 4120.

Students who have received credit for BB 4007 may not take BB 4008 for credit.

**BB 4010. ADVANCED MOLECULAR GENETICS.***Cat. I*

Topics in molecular genetics are presented using microbial systems as models. The structure, function and synthesis of DNA and the results of mutation, recombination and repair are emphasized. Simple bacteria and their plasmids, transposable elements and phages are discussed as experimental models.

Recommended background: BB 2002, BB 2550, BB 2920, BB 4910.

**BB 4065. VIROLOGY.***Cat. I*

This advanced-level course uses a seminar format based on research articles to discuss current topics related to the molecular/cell biology of viral structure, function, and evolution. Particular emphasis is placed on pathological mechanisms of various human disorders, especially emerging diseases, and the use of viruses in research.

Recommended background: BB 2550.

**BB 4070. SEPARATION OF BIOLOGICAL MOLECULES.***Cat. I*

This course provides a detailed survey of state-of-the-art methods employed by the biotechnology industry for the purification of products, proteins in particular, from fermentation processes. Focus is on methods which offer the best potential for scale-up. Included are the theory of the design as well as the operation of these methods at the laboratory scale. It is intended for biology/biotechnology majors, chemical engineering and biochemistry students.

Recommended background: knowledge of the topics in CH 4110 and CH 4120.

Students who have received credit for BB 4060 may not take BB 4070 for credit.

**BB 4160. POPULATION GENETICS AND PHYLOGEOGRAPHY.***Cat. II*

In this course we will explore how evolutionary and geographic processes contribute to the diversity of organisms. Topics will include gene flow and population structure, empirical measures of genetic variation, the roles of genetic drift and natural selection in population genetics, theoretical modes of speciation, species concepts and definitions, and molecular phylogenetics. The course will be presented in a combination of lecture and seminar format, with readings from texts and the primary literature.

Recommended background: BB 2040, BB 2920, BB 3140, and MA 1021-1022.

This course will be offered in 2008-09 and in alternating years thereafter.

**BB 4170. MOLECULAR ECOLOGY.***Cat. II*

This course will emphasize the application of molecular genetic techniques to basic and applied research in ecology. The format for this course will be primarily reading- and writing-intensive seminar, with student-led study and discussion of cutting-edge primary literature. A strong background in both molecular genetics and ecology is recommended. Topics may include the use of genetic markers for studies of social evolution, molecular population genetics and phylogeography, conservation genetics, and the ecological impacts of biotechnology.

Recommended background: BB 2040, BB 2920, BB 4010 and BB 4060.

This course will be offered in 2009-10 and in alternating years thereafter.

**BB 4550. ADVANCED CELL BIOLOGY.***Cat. I*

This advanced-level course uses a seminar format based on research articles to discuss current topics related to the molecular biology of cellular function. Particular emphasis is placed on biological mechanisms of autoimmune disorders, Alzheimers disease, DNA vaccines, stem cells, animal cloning, neurotropic factors, and gene therapy.

Recommended background: BB 2550.

**BB 4910. ADVANCED MOLECULAR BIOLOGY.***Cat. I*

This advanced level course explores the molecular mechanisms by which cells use genetic information to produce RNAs and proteins. Mechanisms and regulation of transcription in both prokaryotes and eukaryotes will be studied with an emphasis on protein-protein and protein-DNA interactions. The structure, organization, evolution and expression of the eukaryotic genome will be emphasized. This course is intended for students who seek an in-depth understanding of gene function.

Recommended background: BB 2550, BB 2920, BB 4955, CH 4110, 4120 and 4130.

**BB 4955. RECOMBINANT DNA PRINCIPLES AND APPLICATIONS.***Cat. I*

This course surveys both theory and applications in recombinant DNA methodology. Topics covered include enzymology of DNA manipulation; construction and isolation of recombinants; plasmid and bacteriophage vectors; structural analysis of cloned DNA.

Recommended background: prior knowledge of BB 2002, BB 2550, BB 2920, BB 4010, and basic molecular biology will be assumed.

**IS4 BB. SPECIAL TOPICS.***Cat. I*

Experimental courses, special conferences and seminars are offered by advance arrangement only.

---

**BIOLOGY AND BIOTECHNOLOGY LAB COURSES**

---

**BB 2901. MOLECULAR BIOLOGY, MICROBIOLOGY, AND GENETICS.***Cat. I (1/6 unit)*

The lab exercises in this course are designed to provide foundation skills needed for the study of living organisms and systems at the both the organismal and molecular scales. Students will gain experience with procedures, equipment, techniques and skills common to all areas of biology. In particular this course will focus on:

- The use and identification of bacteria in the laboratory
- Handling- Restriction digestion- and visualization- of DNA
- Plasmid purification and cloning
- Examples of classic genetics

Recommended background: One or more 1000/2000 BB courses

**BB 2902. ENZYMES, PROTEINS, AND PURIFICATION.***Cat. I (1/6 unit)*

The lab exercises in this course are designed to provide foundation skills needed for the study of living organisms and systems at the both the organismal and molecular scales. Students will gain experience with procedures, equipment, techniques and skills common to all areas of biology. In particular this course will focus on:

- The action and optima of enzyme action
- Quantification and detection techniques for proteins
- Extraction and purification of protein from biological material

Recommended background: One or more 1000/2000 BB courses

**BB 2903. ANATOMY AND PHYSIOLOGY.***Cat. I (1/6 unit)*

The lab exercises in this course are designed to provide foundation skills needed for the study of living organisms and systems at the both the organismal and molecular scales. Students will gain experience with procedures, equipment, techniques and skills common to all areas of biology. In particular this course will focus on:

- Comparative and general anatomy of several organisms
- Physiology and function of body systems , processes and organs.

Recommended background: One or more 1000/2000 BB courses

**BB 2904. ECOLOGY, ENVIRONMENT, AND ANIMAL BEHAVIOR.***Cat. I (1/6 unit)*

The lab exercises in this course are designed to provide foundation skills needed for the study of living organisms and systems at the both the organismal and molecular scales. Students will gain experience with procedures, equipment,



techniques and skills common to all areas of biology. In particular this course will focus on:

- Observing, recording, understanding, and analyzing animal behaviors
- Environmental and Ecological assessment and sampling
- Observations of population dynamics

Recommended background: One or more 1000/2000 BB courses

#### **BB 3511. NERVE AND MUSCLE PHYSIOLOGY.**

*Cat. I (1/6 unit)*

Computer and laboratory studies of nerve and muscle function.

Recommended background: BB 2940, or BB 2903.

Concurrent or prior registration in BB 3101 is recommended.

#### **BB 3512. MOLECULAR GENETICS LAB.**

*Cat. I (1/6 unit)*

The topic of gene therapy will be used to familiarize the student with computer cloning and manipulations of biological sequence information.

Recommended background: BB 2920, BB 2550 and BB 4910/CH 4130.

#### **BB 3513. CELL CULTURE TECHNIQUES FOR ANIMAL CELLS.**

*Cat. I (1/6 unit)*

Basic laboratory skills in mammalian cell culture to include cell counting, freezing and thawing cell lines, culture of suspension and attached cells.

Recommended background: BB 2940 or BB 2901, BB 2550 and knowledge of aseptic techniques.

Concurrent or prior registration in BB 4008 is recommended.

#### **BB 3514. CIRCULATORY AND RESPIRATORY PHYSIOLOGY.**

*Cat. I (1/6 unit)*

Computer and laboratory studies of circulatory and respiratory physiology.

Recommended background: BB 2940, or BB 2903.

Concurrent or prior registration in BB 3102 is recommended.

#### **BB 3516. SEPARATION TECHNIQUES IN BIOTECHNOLOGY.**

*Cat. I (1/6 unit)*

A laboratory course in chromatographic and electrophoretic separation of proteins; plasmid isolation, restriction digestion and electrophoretic separation of DNA.

Recommended background: BB 2940, or BB 2902.

Concurrent or prior registration in Biochemistry (CH 4110) and BB 4910 is recommended.

#### **BB 3517. FERMENTATION.**

*Cat. I (1/6 unit)*

An introductory laboratory course in basic fermentation techniques.

Recommended background: BB 2940 or BB 2901, BB 2002, or knowledge of aseptic techniques.

Concurrent or prior registration in BB 3055 is suggested.

#### **BB 3518. MOLECULAR BIOLOGY.**

*Cat. I (1/6 unit)*

Laboratory investigations of select molecular characteristics of proteins and DNA.

Recommended background: BB 2940 or BB 2901, BB 2550, and CH 4110.

Concurrent, or prior registration in BB 4910 or CH 4130 is recommended.

#### **BB 3519. PROTEIN PURIFICATION.**

*Cat. I (1/6 unit)*

A laboratory course in protein purification techniques.

Recommended background: BB 2940 or BB 2902, CH 4110.

Concurrent or prior registration in BB 4070 is recommended.

#### **BB 3520. RECOMBINANT DNA TECHNOLOGY.**

*Cat. I (1/6 unit)*

A laboratory course in the construction, isolation and mapping of recombinants, and use of the polymerase chain reaction.

Recommended background: BB 2940 or BB 2901, BB 2550, CH 4110 and BB 4910.

Concurrent or prior registration in BB 4955 is recommended.

#### **BB 3521. MICROSCOPY.**

*Cat. I (1/6 unit)*

A laboratory course in the theory and operation of light and electron microscopes, including specimen preparation, operation of equipment, and microphotography.

Recommended background: BB 2940 or BB 2901, and BB 2550.

#### **BB 3522. TRANSMISSION ELECTRON MICROSCOPY.**

*Cat. I (1/6 unit)*

This laboratory module will provide the student with the basic theory and practice of transmission electron microscopy. The course will include sample handling and preparation methods, use of the TEM, and photographic recording of observations made with the instrument.

Recommended background: BB 1001 or BB 2550, and BB 2940 or BB 2950 or BB 2901 or BB 2903.

#### **BB 3524. BIOINFORMATICS LAB.**

*Cat. I (1/6 unit)*

Laboratory course investigating some of the basic tools currently available for sequence data mining, comparison of nucleotide and/or protein sequences, and the analysis of nucleotide and protein sequences. Course will be computer based.

Recommended background: BB2920, BB2901, and CH4110.

Concurrent or prior registration in BB4910 or CH4130 is recommended.

Students who have received credit for BB324X may not receive credit for BB3524.

#### **BB 3525. PLANT PHYSIOLOGY.**

*Cat. I (1/6 unit)*

Basic studies in the biochemical and physical systems plants use to sustain life; includes an introduction to plant cell culture techniques.

Recommended background: BB1045 and BB2903.

Concurrent or prior registration in BB3120 is recommended. Students who have received credit for BB 325X may not receive credit for BB3525.

## **Graduate Biology and Biotechnology Courses of Interest to Undergraduates**

The following courses are open to advanced undergraduates with special written permission of the course instructor and department head.

#### **BB 501. SEMINAR.**

#### **BB 509. SCALE-UP OF BIOPROCESSING.**

Strategies for optimization of bioprocesses for scale-up applications. In addition to the theory of scaling up unit operations in bioprocessing, students will scale-up a bench scale bioprocess (5 liters) including fermentation and downstream processing to 55 liters. Specific topics include the effects of scaling-up on: mass transfer and bioreactor design, harvesting techniques including tangential flow filtration and centrifugation, and chromatography (open column and HPLC).

Recommended courses include BB 3055 Microbial Physiology and BB 4070/560 Separations of Biological Molecules, as a working knowledge of the bench scale processes will be assumed. Otherwise, instructor permission is required.

#### **BB 542. ECOLOGICAL SIMULATION MODELING.**

This course will cover computer simulation modeling of populations, bioenergetics, behavior of individuals, and ecosystem dynamics. Modeling techniques covered will range from simple linear models of populations and interactions between ecosystem components to individual-based models of populations in complex environments. Students successfully completing the course should be capable of understanding models used in today's study of populations and ecosystems and of developing original models. Knowledge of a programming language is assumed.

#### **BB 560. SEPARATION OF BIOLOGICAL MOLECULES.**

This course provides a detailed hands-on survey of state-of-the-art methods employed by the biotechnology industry for the purification of products, proteins in particular, from fermentation processes. Focus is on methods which offer the best potential for scale-up. Included are the theory of the design as well as the operation of these methods both at the laboratory scale as well as scaled up. It is intended for biology, biotechnology, chemical engineering, and biochemistry students. A knowledge of basic biochemistry is assumed.

#### **BB 565. VIROLOGY.**

This advanced-level course uses a seminar format based on research articles to discuss current topics related to the molecular/cell biology of viral structure, function, and evolution. Particular emphasis is placed on pathological mechanisms of various human disorders, especially emerging diseases, and the use of viruses in research.

#### **BB 570. SPECIAL TOPICS.**

Specialty subjects are offered using the research expertise of the department faculty. Content and format varies to suit the interest and needs of the faculty and students. This course may be repeated for different topics covered.

**BB575 ADVANCED GENETICS & CELL BIOLOGY.**

Topics in this course focus on the basic building blocks of life; molecules, genes and cells. The course will address areas of the organization, structure, function and analysis, of the genome and of cells. Required Background: Students in the course should be familiar with the fundamentals of recombinant DNA and molecular biological techniques as well as cell biology.

**BB576 ADVANCED INTEGRATIVE BIOSCIENCE.**

This course concentrates on the organization of cells into biological systems and into individual organisms. Discussion will center on the development and function of specific model systems such as the nervous and immune systems. Required background: Students in the course should be familiar with the fundamentals of developmental biology, genetics and cell biology.

**BB577 ADVANCED ECOLOGICAL & EVOLUTIONARY BIOSCIENCE.**

This course will explore the organization of individuals into communities, and the evolution of individual traits and behaviors. Problems discussed will range from those of population harvesting and the effect humans have on the environment to the evolution of disadvantageous traits. Required background: Students should be familiar with fundamentals of population interactions, evolution and animal behavior.

**BB578 ADVANCED APPLIED BIOTECHNOLOGY.**

This course examines the use of biotechnological advances towards solving real world problems. Students will discuss problem-solving strategies from the current literature in the areas of medicine, agriculture, environmental protection/restoration and industrial biotechnology. Required background: Students should be familiar with biochemistry, microbiology, and plant and animal physiology.

---

## BIOMEDICAL ENGINEERING

---

The second digit for Biomedical Engineering course numbers is coded as follows:

- 0 — Bioinstrumentation, Biosignals, Introduction
- 1 — Physiology
- 2 — Bioelectric, Bioimaging
- 3 — Design
- 5 — Biomechanics, Biological Systems
- 6 — Biofluids
- 8 — Biomaterials

NOTE: Courses listed in previous catalogs with "BE" as the prefix and the same course number as below are considered to be the SAME COURSE.

**BME 1001. INTRODUCTION TO BIOMEDICAL ENGINEERING.***Cat. I*

Lectures, demonstrations, hands-on experimentation, and scientific literature readings in the major branches of biomedical engineering. A series of laboratory demonstration/experiments are utilized to complement key concepts covered in various lectures.

**BME/ECE 2204. BIOELECTRIC FOUNDATIONS.***Cat. I*

An introduction to the origins and characteristics of the electric and electromagnetic signals that arise in biological tissues. Topics include the behavior of excitable cells and tissues, the intrinsic electrical and magnetic properties of biological tissues, and the response of excitable cells to electric and magnetic field stimulation. Laboratory projects include the measurement of bioelectric signals (EMG, EKG, EEG, EOG, and evoked response) and the fundamentals of data acquisition, analysis, and statistics. The principles of writing and maintaining a laboratory notebook are also developed and used.

Recommended background: BB 2550 or equivalent, PH 1120 or PH 1121.

Students who have received credit for BME 4101 may not receive credit for BME 2204.

**BME 2504. FOUNDATIONS IN BIOMECHANICS.***Cat. I*

This course is an introduction to the analysis of the musculoskeletal systems using principles of engineering mechanics. Basic principles of mechanics, stress, strain and deformation in beams are presented and used to characterize the material properties of tissues such as skin, tendon, ligament, bone and cartilage. Principles of biomechanics are also applied to the design of medical devices and bioengineered tissues. Topics include forces, moments of forces, free body diagrams, principal stresses, transverse shear stresses and beam loading.

Recommended background: BB 2550 or equivalent, MA 2051, PH 1110 or PH 1111.

Students who have previously received credit for BME 4504 may not receive credit for BME 2504.

**BME 2604. FOUNDATIONS IN BIOLOGICAL TRANSPORT PHENOMENA.***Cat. I*

This course is an introduction to the analysis of complex biological systems using principles of transport phenomena. Basic theories of momentum transport, mass transport and energy transport are presented and applied to cellular and mammalian physiology. Principles of transport phenomena are also applied to the design of medical devices and bioengineered tissues. Topics include differential and integral balances, rheology of Newtonian and non-Newtonian fluids, diffusion in reacting systems and homogeneous vs. heterogeneous reaction systems.

Recommended background: BB 2550 or equivalent, MA 2051, PH 1110 or PH 1111.

Students who have received credit for BME 3101 may not receive credit for BME 2604.

**BME/ECE 3011. BIOINSTRUMENTATION AND BIOSENSORS.***Cat. I*

A study of the basic principles of biomedical electronics and measurement with emphasis on the operational performance and selection of transducers, instruments and systems for biomedical data acquisition and processing. Biopotential electrodes. Analysis and selection of physical, optical, electrical, mechanical, thermal transduction mechanisms which form the basis of the sensor design. Clinical laboratory instrumentation. Electrical safety problems in the clinical environment.

Recommended background: MA 2051, ECE 3601, or equivalent.

**BME 3300. BIOMEDICAL ENGINEERING DESIGN.***Cat. I*

Students are guided through the open-ended, real-world, design process starting with the project definition, specification development, management, team interactions and communication, failure and safety criteria, progress reporting, marketing concepts, documentation and technical presentation of the final project outcome. The course will include a significant writing component, will make use of computers, and hands-on design explorations.

Students who have previously received credit for BME 2300 may not receive credit for BME 3300.

**BME 3504. EXPERIMENTAL BIOMECHANICS.***Cat. I*

This laboratory-driven biomechanics course provides hands-on experience in characterizing the mechanical properties of hard and soft biological tissues. Students gain an in-depth understanding of the course material from personal observations and measurements on actual soft and hard tissues using industry-standard testing equipment. Challenge-based laboratory projects will be assigned which will require the students to determine and execute effective test methods in teams at their own pace. Tissues tested may include blood vessels, cartilage, bone, tendons, skin, and muscle.

Recommended background: A solid knowledge of mechanics of materials (BE 2504 or ES2502), and material science (ES 2001).

**BME/ECE 4011. BIOMEDICAL SIGNAL ANALYSIS.***Cat. II*

Introduction to biomedical signal processing and analysis. Fundamental techniques to analyze and process signals that originate from biological sources: ECGs, EMGs, EEGs, blood pressure signals, etc. Course integrates physiological knowledge with the information useful for physiologic investigation and medical diagnosis and processing. Biomedical signal characterization, time domain analysis techniques (transfer functions, convolution, auto- and cross-correlation), frequency domain (Fourier analysis), continuous and discrete signals, deterministic and stochastic signal analysis methods. Analog and digital filtering.

Recommended background: ECE 2311, ECE 2312, BME 3011, or equivalent.

This course will be offered in 2008-09, and in alternating years thereafter.

**BME/ECE 4023. BIOMEDICAL INSTRUMENTATION DESIGN I.***Cat. II*

This course builds on the fundamental knowledge of bioinstrumentation and biosensors presented in BME 3011. Lectures and hands-on laboratory experiments cover the principles of designing, building and testing analog instruments to measure biological events. Design laboratories will include biopotential amplifiers and biosensor/bioinstrumentation systems for the measurement of physiological parameters.

Recommended background: BME 2204, and BME 3011.

This course will be offered in the 2008-09 academic year and in alternating years thereafter.

**BME 4025. BIOMEDICAL INSTRUMENTATION DESIGN II.***Cat. II*

This course builds on the fundamental knowledge of bioinstrumentation and biosensors presented in BME3011. Lectures and hands-on laboratory experiments cover the principles of biosensor interfacing, low-level measurements, analog-to-digital and digital-to-analog signal conversion, microprocessor and microcontroller based biomedical instrumentation, and programming.

Recommended background: BME 2204, and BME 3011.

This course will be offered in the 2009-10 academic year and in alternating years thereafter.

**BME/ECE 4201. BIOMEDICAL IMAGING.***Cat. II*

This course is a practical introduction to biomedical image processing using examples from various branches of medical imaging. Topics include: point operations, filtering in the image and Fourier domains, image reconstruction in computed tomography and magnetic resonance imaging, and data analysis using image segmentation. Review of linear-systems theory and the relevant principles of physics. Course work uses examples from microscopy, computed tomography, X-ray radiography, and magnetic resonance imaging. A working knowledge of undergraduate signal analysis and linear algebra is desirable. Facility with a high-level programming language is recommended.

The course will be offered in 2008-09, and in alternating years thereafter.

**BME/ME 4504. BIOMECHANICS.***Cat. II*

This course emphasizes the applications of mechanics to describe the material properties of living tissues. It is concerned with the description and measurements of these properties as related to their physiological functions. Emphasis on the interrelationship between biomechanics and physiology in medicine, surgery, body injury and prostheses.

Topics covered include: Review of basic mechanics, stress, strain, constitutive equations and the field equations, viscoelastic behavior, and models of material behavior. The measurement and characterization of properties of tendons, skin, muscles and bone. Biomechanics as related to body injury and the design of prosthetic devices.

Recommended background: Mechanics (ES 2501, ES 2502, ME 3501), Mathematics (MA 2051).

This course will be offered in 2009-10, and in alternating years thereafter.

**BME 4541. BIOLOGICAL SYSTEMS.***Cat. II*

Review of control theory with applications to biological control systems. Analysis and modeling of physiological systems. Physiological systems identification. Formulation of mathematical models of biological systems and the application of computer techniques in the simulation of these systems. Recommended background: Laplace transforms, transient response, frequency response and system stability analysis.

This course will be offered in 2009-10, and in alternating years thereafter.

**BME/ME 4606. BIOFLUIDS.***Cat. II*

This course emphasizes the applications of fluid mechanics to biological problems. The course concentrates primarily on the human circulatory and respiratory systems. Topics covered include: blood flow in the heart, arteries, veins and microcirculation and air flow in the lungs and airways. Mass transfer across the walls of these systems is also presented.

Recommended background: ME 3501 and fluid mechanics equivalent to ES 3004.

This course will be offered in 2008-09, and in alternating years thereafter.

**BME/ME 4814. BIOMATERIALS.***Cat. I*

A course discusses various aspects pertaining to the selection, processing, testing (in vitro and in vivo) and performance of biomedical materials. The biocompatibility and surgical applicability of metallic, polymeric and ceramic implants and prosthetic devices are discussed. The physico-chemical interactions between the implant material and the physiological environment will be described. The use of biomaterials in maxillofacial, orthopedic, dental, ophthalmic and neuromuscular applications is presented.

Recommended background: BB 3130 or equivalent introduction to Human Anatomy, ES 2001 or equivalent introduction to Materials Science and Engineering.

**BME 4828. BIOMATERIALS-TISSUE INTERACTIONS.***Cat. I<sup>o</sup>*

This course examines the principles of materials science and cell biology underlying the design of medical devices, artificial organs and scaffolds for tissue engineering. Molecular and cellular interactions with biomaterials are analyzed in terms of cellular processes such as matrix synthesis, degradation and

contraction. Principles of wound healing and tissue remodeling are used to study biological responses to implanted materials and devices. Case studies will be analyzed to compare tissue responses to intact, bioresorbable and bioerodible biomaterials. Additionally, this course will examine criteria for restoring physiological function of tissue and organs and investigate strategies to design implants and prostheses based on control of biomaterial-tissue interactions.

Recommended background: BME 2604, BB 2550 or equivalent, ES 2001 or equivalent, PH 1110 or PH 1111.

---

## Graduate Biomedical Engineering Courses of Interest to Undergraduates

---

**BME 523. BIOMEDICAL INSTRUMENTATION.**

Origins and characteristics of bioelectric signals, recording electrodes, amplifiers, chemical pressure and flow transducers, noninvasive monitoring techniques, and electrical safety. (Prerequisite: Circuits and electronics, control engineering or equivalent.)

**BME 525. MICROPROCESSOR-BASED BIOMEDICAL INSTRUMENTATION.**

This course provides hands-on laboratory experience with common biomedical transducers and instrumentation used in physiological and clinical evaluation. Lectures and laboratory experiments cover electronic circuit design and construction, analog/digital signal acquisition and processing, and microprocessor-based biomedical instrumentation. The basic principles of hardware and software designs for interfacing biomedical sensors to a general purpose IBM-PC are emphasized. (Prerequisite: Analog and digital electronics.)

**BME 541. BIOLOGICAL SYSTEMS.**

Review of control theory with applications to biological control systems. Development of mathematical models of selected biological control systems and the application of computer techniques in the simulation of these systems.

**BME/ME 550. TISSUE ENGINEERING.**

This biomaterials course focuses on the selection, processing, testing and performance of materials used in biomedical applications with special emphasis upon tissue engineering. Topics include: material selection and processing, mechanisms and kinetics of material degradation, cell-material interactions and interfaces; effect of construct architecture on tissue growth; and transport through engineered tissues. Examples of engineering tissues for replacing cartilage, bone, tendons, ligaments, skin and liver will be presented. (Recommended preparation: A first course in biomaterials equivalent to BME/ME 4814 and a basic understanding of physiology and cell biology.)

**BME 551. BIOLOGICAL SIGNAL PROCESSING.**

Basic principles of digital processing of biological signals, and its application on PC-compatible computers. The theoretical fundamentals and practical examples of signal processing. The major emphasis is on linking the theoretical knowledge with easy to comprehend practical examples. (Prerequisites: Basic signal analysis.)

**BME/ME 552. TISSUE MECHANICS.**

This biomechanical course focuses on advanced techniques for the characterization of the structure and function of hard and soft tissues and their relationship to physiologic processes. Applications include: tissue injury, wound healing, the effect of pathological conditions upon tissue properties and design of medical devices and prostheses. (Recommended preparation: A first course in biomechanics equivalent to BME/ME 4504.)

**BME/ME 554. COMPOSITES WITH BIOMEDICAL AND MATERIALS APPLICATIONS.**

Introduction to fiber/particulate reinforced, engineered and biologic materials. This course focuses on the elastic description and application of materials that are made up of a combination of submaterials, i.e., composites. Emphasis will be placed on the development of constitutive equations that define the mechanical behavior of a number of applications, including: biomaterial, tissue, and materials science. (Prerequisites: understanding of stress analysis and basic continuum mechanics.)

**BME/ME 558. BIOFLUIDS AND BIOTRANSPORT.**

The emphasis of this course is on modeling fluid flow within the cardiovascular and pulmonary systems and the transport processes that take place in these systems. Applications include artificial heart valves, atherosclerosis, arterial impedance matching, clinical diagnosis, respiration, aerosol and particle deposition. Depending upon class interest, additional topics may include: reproductive fluids, animal propulsion in air and water and viscoelastic testing. (Recommended preparation: A first course in biofluids equivalent to BME/ME 4606.)



**BME 560. PHYSIOLOGY FOR ENGINEERS.**

An introduction to fundamental principles in cell biology and physiology designed to provide the necessary background for advanced work in biomedical engineering. Quantitative methods of engineering and the physical sciences are stressed. Topics include cell biology, DNA technology, and the physiology of major organ systems.

NOTE: This course can be used to satisfy a life science requirement in the biomedical engineering graduate program. It cannot be used to satisfy a biomedical engineering course requirement.

**BME 562. LABORATORY ANIMAL SURGERY.**

A study of anesthesia, surgical techniques, and postoperative care in small laboratory animals. Anatomy and physiology of species used included as needed. Class limited to 15 students. Approximately 15 surgical exercises are performed by each student.

NOTE: This course can be used to satisfy a life science requirement in the biomedical engineering graduate program. It cannot be used to satisfy a biomedical engineering course requirement.

**BME 570. ENGINEERING IN THE CLINICAL ENVIRONMENT.**

Examines the responsibilities and functions of the biomedical engineer in the health care complex in the solution of the technical and engineering problems associated with patient care. Topics include equipment management, monitoring systems, electrical safety, prosthetics, technical education for medical personnel, hospital systems engineering, and administrative functions.

**BME 581. MEDICAL IMAGING SYSTEMS.**

Overview of the physics of medical image analysis. Topics covered include X-Ray tubes, fluoroscopic screens, image intensifiers; nuclear medicine; ultrasound; computer tomography; nuclear magnetic resonance imaging. Image quality of each modality is described mathematically, using linear systems theory (Fourier transforms, convolutions). (Prerequisite: Signal analysis course ECE 2312 or equivalent.)

**BME 582. PRINCIPLES OF IN VIVO NUCLEAR MAGNETIC RESONANCE IMAGING.**

This course emphasizes the applications of Fourier transform nuclear magnetic resonance (FTNMR) imaging and spectroscopy in medicine and biology. Course topics include: review of the basic physical concepts of NMR (including the Bloch equations), theoretical and experimental aspects of FTNMR, theory of relaxation and relaxation mechanisms in FTNMR, instrumentation for FTNMR, NMR imaging techniques (point, line, plane, and volume methods), and in vivo NMR spectroscopy (including volume localization techniques). (Prerequisites: Differential and integral calculus, ordinary differential equations; organic chemistry recommended.)

**BME 585. PRINCIPLES OF IN VIVO NUCLEAR MAGNETIC RESONANCE SPECTROSCOPY.**

This course emphasizes the applications of Fourier transform nuclear magnetic resonance (FTNMR) spectroscopy in medicine and biology. Course topics include: Review of the basic physical concepts of NMR, review of covalent chemical binding and its relationship to the NMR chemical shift, factors in biological systems that influence the NMR chemical shift, data acquisition and processing techniques in vivo NMR spectroscopy, and the application of NMR spectroscopy to clinical studies. (Prerequisites: BME 582, organic chemistry and biochemistry are strongly recommended.)

**BME 595. SPECIAL TOPICS IN BIOMEDICAL ENGINEERING.**

Topics in Biomedical Engineering. Presentations and discussions of the current literature in one or more of the following areas: medical imaging, neurosensory systems, bio-statics.

**BME 595B. BIOMATERIALS IN THE DESIGN OF MEDICAL DEVICES.**

Biomaterials are an integral part of medical devices, implants, controlled drug delivery systems, and tissue engineered constructs. Extensive research efforts have been expended on understanding how biologic systems interact with biomaterials. Meanwhile, controversy has revolved around biomaterials and their availability as a result of the backlash to the huge liability resulting from controversies related to material and processing shortcomings of medical devices. This course specifically addresses the unique role of biomaterials in medical device design and the use of emerging biomaterials technology in medical devices. The need to understand design requirements of medical devices based on safety and efficacy will be addressed. Unexpected device failure can occur if testing fails to account for synergistic interactions from chronic loading, aqueous environments, and biologic interactions. Testing methodologies are readily available to assess accelerated effects of loading in physiologic-like environments. This combined with subchronic effects of animal implants is a potential tool in assessing durability. It is difficult to predict the chronic effects of the total biologic environment. The ultimate determination of safety comes not only

from following the details of regulations, but with an understanding of potential failure modes and designs that lowers the risk of these failures. This course will evaluate biomaterials and their properties as related to the design and reliability of medical devices.

**BME 595M. MEDICAL DEVICE REGULATION.**

This course provides an overview of regulations that guide the Medical Devices industry. Primary focus is on the Food, Drug and Cosmetic Act and its associated regulations. The course covers the FD&C Act, including definitions, prohibited acts, penalties and general authority. The course also covers regulations, including establishment registration, premarket approval (PMA), and current good manufacturing practices. Requirements of other federal agencies (NRC, FCC, EPA) will also be discussed.

## CHEMICAL ENGINEERING

NOTE: Courses listed in previous catalogs with "CM" as the prefix and the same course number as below are considered to be the SAME COURSE.

**CHE 1011. INTRODUCTION TO CHEMICAL ENGINEERING.**

*Cat. I*

This course provides an introduction to the broad and vital discipline of chemical engineering including conventional and developing chemical technologies. An introduction is provided to the first principles of chemical engineering, as well as environmental, health, safety and ethical issues in chemical engineering practice. An overview is provided of the chemical engineering profession, career choices, the course of study, and a survey of the chemical industry, e.g., polymer, pharmaceutical, food processing, microelectronic, electrochemical, biotechnology, process control, energy, and petroleum refining. Course activities include guest speakers and plant trips.

Recommended for first-year students with a basic knowledge of chemistry.

**CHE 2011. CHEMICAL ENGINEERING FUNDAMENTALS.**

*Cat. I*

This first course in chemical engineering is designed to give students the ability to use techniques and solve problems of interest to chemical engineers. Students will learn fundamental material by completing analysis, design, and/or laboratory projects. Topics covered include: material balances and stoichiometry, pressure, volume, and temperature behavior of pure fluids, 1<sup>st</sup> law of thermodynamics, vapor-liquid equilibria with ideal thermodynamics, and staged separation processes.

Recommended background: Elementary college chemistry and calculus.

Students may not receive credit towards CHE distribution requirements for both CHE 2011 and CM 2001.

**CHE 2012. ELEMENTARY CHEMICAL PROCESSES.**

*Cat. I*

This course aims to build a strong foundation in analysis of chemical processes via a project-based approach. Topics covered include analysis and design of stagewise separation processes such as distillation, 1<sup>st</sup> and 2<sup>nd</sup> law (of thermodynamics) analysis of power and refrigeration cycles, and application of material and energy balances in industrial chemical processes, including those with recycle and non-ideal systems.

Recommended background: Elementary college chemistry and calculus and some familiarity with the topics listed in CHE 2011.

Students may not receive credit towards CHE distribution requirements for both CHE 2012 and ES 3000.

**CHE 2013. APPLIED CHEMICAL ENGINEERING THERMODYNAMICS.**

*Cat. I*

This course uses a project-based approach to build confidence and competence in the use of chemical engineering thermodynamics for the analysis and design of chemical processes. Topics covered include extractive separation systems, solution thermodynamics and nonreacting multicomponent mixtures, phase equilibria and property changes on mixing.

Recommended background: Elementary college chemistry and calculus and some familiarity with the topics listed in CHE 2011 and CHE 2012.

Students may not receive credit towards CHE distribution requirements for both CHE 2013 and CM 2102.

**CHE 2014. ADVANCED CHEMICAL PROCESSES.**

*Cat. I*

This course builds on prior work in material and energy balances, chemical engineering thermodynamics, and stagewise separation processes to facilitate student mastery and design of more complex processes. Topics covered include chemical reaction equilibria, material and energy balances for non-steady state systems, combined material and energy balances, humidification, and batch distillation.

Recommended background: Elementary college chemistry and calculus and some familiarity with the topics listed in CHE 2011, CHE 2012, and CHE 2013.

Students may not receive credit towards CHE distribution requirements for both CHE 2014 and CM 2002.

### CHE 3201. KINETICS AND REACTOR DESIGN.

*Cat. I*

Techniques for experimentally determining rate laws for simple and complex chemical reactions, the mechanisms and theories of chemical reactions, the function of catalysts, and the design of isothermal, adiabatic, batch and flow reactors. The course is intended to provide chemists and chemical engineers with the conceptual base needed to study reactions and perform in the design and analysis of reactors.

Recommended background: differential equations, thermodynamics and some organic chemistry.

### CHE 3301. INTRODUCTION TO BIOLOGICAL ENGINEERING.

*Cat. II*

This course is an introduction to the chemical engineering principles involved in modern applications of biological engineering. Topics may include: an introduction to biology, biochemistry, physiology, and genomics; biological process engineering including fermentation, mammalian cell culture, biocatalysis, and downstream bioseparations; drug discovery, development, and delivery; environmental biotechnology; and chemical engineering aspects of biomedical devices.

Recommended background: material and energy balances, thermodynamics, organic chemistry, and differential equations.

This course will be offered in 2009-10, and in alternating years thereafter.

### CHE 3501. APPLIED MATHEMATICS IN CHEMICAL ENGINEERING.

*Cat. I*

The consolidation of the methods of mathematics into a form that can be used for setting up and solving chemical engineering problems. Mathematical formulation of problems corresponding to specific physical situations such as momentum, energy and mass transfer, and chemical reactions. Analytical and numerical techniques for handling the resulting ordinary and partial differential equations and finite difference equations.

Recommended background: ordinary differential equations, partial derivatives and vectors, momentum heat and mass transfer.

### CHE 3601. CHEMICAL MATERIALS ENGINEERING.

*Cat. II*

This course is designed to provide a working knowledge in the solving of materials problems encountered by chemical engineers and in the engineering of new and improved materials used in chemical processes. The approach used is the correlation of engineering properties with atomic and microstructures, utilizing the diagnostic techniques of X-ray diffraction and spectrometry, microscopy, and phase relationships.

Topics include surface active materials such as catalysts, sorbents, filtering and separation agents, corrosion resistant materials, metals, refractories and polymers used in construction materials, particularly for pollution control.

Recommended background: basic knowledge of chemistry.

This course will be offered in 2008-09, and in alternating years thereafter.

### CHE 3910. CHEMICAL AND ENVIRONMENTAL TECHNOLOGY.

*Cat. II*

Day trips to industrial plants provide an insight into the real world of the chemical industry. Advanced technologies for commercially producing major organic chemicals and the monomers and polymers derived from them are described. Petroleum refining, catalytic and thermal petrochemical processes, soaps and detergents, specialty chemicals, and antibiotic production processes are presented at the industrial level. Large scale unit operations and processes are seen on the plant trips. Students see how plant layout is integrated with process and product control and environmental protection at each facility.

Particular attention is paid to plant scale processes and equipment for control of chemical spills, hazards, and environmental pollution, for safety and accident prevention, and for compliance with local and national laws.

Recommended background: general understanding of Organic Chemistry and Material Balances is assumed.

This course will be offered in 2009-10, and in alternating years thereafter.

### CHE 3920. AIR QUALITY MANAGEMENT.

*Cat. II*

This course discusses the sources, sinks, ambient concentrations and effects of major gaseous and particulate air pollutants. The course is problem oriented and applied engineering methods to develop strategies for managing air quality on a

local, regional and global scale. Topics include: indoor air quality, regional air shed modelling, global atmospheric change and design and efficiencies of air pollution control devices.

Recommended background: knowledge of chemistry, mathematics and engineering principles.

This course will be offered in 2008-09, and in alternating years thereafter.

### CHE 4401. UNIT OPERATIONS OF CHEMICAL ENGINEERING I.

*Cat. I*

Laboratory-application of fundamental theories to practical chemical engineering operations. Emphasis is on building the student's understanding and ability to approach the problems of design and operations of large scale chemical processing equipment.

The course is a combination of lectures and laboratory projects in the area of unit operations. Laboratory projects include experiments in fluid-flow phenomena through various media such as: friction in conduits, filtration, pressure drop in packed towers, fluidization of solids, and spray drying.

Students are expected to carry out the planning and execution of experimental work as well as the analysis and reporting of experimental results in both written and oral format.

Recommended background: knowledge of chemistry, mathematics and engineering principles.

### CHE 4402. UNIT OPERATIONS OF CHEMICAL ENGINEERING II.

*Cat. I*

Overall format and procedure are essentially the same as in Unit Operations of Chemical Engineering I.

Laboratory projects include experiments in heat and mass transfer such as: heat transfer in two heaters and a cooler, climbing film evaporation, multiple effect evaporation, absorption, extraction, distillation and rotary drying of solids.

Recommended background: familiarity with techniques and procedures emphasized in CHE 4401.

### CHE 4403. CHEMICAL ENGINEERING DESIGN.

*Cat. I*

Design of equipment, systems and plants; discussion of factors important in chemical plant design such as: economics, cost estimation, profitability, process selection, materials of construction, process control, plant location and safety. Introduction to optimization and computer-aided design. Principles are illustrated with short industrial-type problems.

Recommended background: thermodynamics; heat, mass and momentum transfer; inorganic and organic chemistry; chemical kinetics and reactor design.

### CHE 4404. CHEMICAL PLANT DESIGN PROJECT.

*Cat. I*

Application of Chemical Engineering design principles to the design of a major chemical plant. Students work in groups to produce a preliminary practical process flowsheet, equipment and plant design, and economic analysis.

Recommended background: familiarity with techniques and procedures emphasized in CHE 4403.

### CHE 4405. CHEMICAL PROCESS DYNAMICS AND CONTROL LABORATORY.

*Cat. I*

This course is intended to provide laboratory application of fundamental principles of chemical process dynamics and feedback control. This includes open-loop dynamics of typical chemical engineering processes such as distillation, fluid flow, chemical reactors and heated stirred tanks. Closed-loop experiments will involve control loop design, controller tuning, multivariable, and computer control.

Students will be required to design and execute their own experiments based on supplied objectives. Analysis and presentation of the results will be done through oral and written reports.

Recommended background: knowledge of fluid flow and heat transfer, mathematics and chemical engineering principles.

---

## Graduate Chemical Engineering Courses of Interest to Undergraduates

---

### CHE 504. MATHEMATICS ANALYSIS IN CHEMICAL ENGINEERING.

Methods of mathematical analysis selected from such topics as vector analysis, matrices, complex variables, Eigenvalue problems, Fourier analysis, Fourier transforms, Laplace transformation, solution of ordinary and partial differential equations, integral equations, calculus of variations, perturbation and asymptotic methods and numerical analysis. Emphasis on application to the solution of chemical engineering problems.

**CHE 506. KINETICS AND CATALYSIS.**

Theories of reaction kinetics and heterogeneous catalysis are developed for both simple and complex reactions. The kinetics and mechanisms of both catalyzed and uncatalyzed reactions are explored, as well as the effects of bulk and pore diffusion. Techniques for experimentation, reaction data treatment, and catalyst preparation and characterization are related to developing a sound approach to studying a chemical reaction.

**CHE 507. CHEMICAL REACTOR DESIGN.**

A review of the design of ideal reactors. Main course topics include: deviations from ideal reactor behavior; transport effects in reacting systems; steady state multiplicity and stability analysis; optimization of reactors; analysis of heterogeneous reactors.

**CHE 508. CATALYSIS AND SURFACE SCIENCE OF MATERIALS.**

The major factors which distinguished catalytic processes for chemicals and fuels from one another are the structure and composition of the materials used as catalysts.

This course examines the detailed structures and reactivities of solid catalysts like zeolites, solid state inorganics, supported metals and metal-support interactions, carbon catalysts, anchored catalysts and others. Several important spectroscopic techniques used in surface science such as X-ray photoelectron spectroscopy (ESCA), electron microprobe, AUGER, scanning electron microscopy, EXAFS, Mossbauer, Fourier-transform infrared, enhanced laser Raman spectroscopy and photoacoustics spectroscopy will be described for characterization of the catalytic surfaces.

The relationship between the structures and reactivities of important catalysts used in hydrocarbon oxidation and functionalization and syngas reactions will be examined to rationalize how they accomplish specific catalytic transformations.

**CHE 510. DYNAMICS OF PARTICULATE SYSTEMS.**

Systems of discrete particles which grow in size or some other characteristic variable (e.g., age, molecular weight, etc.) are analyzed. Both reaction engineering and population balance analyses are introduced for batch and continuous systems. Steady state and transient system dynamics are explored.

Depending on class interest, specific topics may include: crystallization, latex synthesis, polymer molecular weight distribution, fermentation/ecological systems and gas-solid systems.

**CHE 521. BIOCHEMICAL ENGINEERING.**

The course emphasizes the basic concepts of biological systems which are relevant to study by chemical engineers. Topics covered include ligand binding and membrane transport processes; growth kinetics of microorganisms; kinetics of interacting multiple populations; biological reactor design and analysis; soluble and immobilized enzyme kinetics; optimization and control of fermentation; and biological product recovery and separation.

**CHE 531. FUEL CELL TECHNOLOGY.**

The course provides an overview of the various types of fuel cells followed by a detailed discussion of the proton-exchange membrane (PEM) fuel cell fundamentals: thermodynamics relations including cell equilibrium, standard potentials, and Nernst equation; transport and adsorption in proton-exchange membranes and supported liquid electrolytes; transport in gas-diffusion electrodes; kinetics and catalysis of electrocatalytic reactions including kinetics of elementary reactions, the Butler-Volmer equation, reaction routes and mechanisms; kinetics of overall anode and cathode reactions for hydrogen and direct methanol fuel cells; and overall design and performance characteristics of PEM fuel cells.

**CHE 554/CH 554. MOLECULAR MODELING.**

This course trains students in the area of molecular modeling using a variety of quantum mechanical and force field methods. The approach will be toward practical applications, for researchers who want to answer specific questions about molecular geometry, transition states, reaction paths and photoexcited states. No experience in programming is necessary; however, a background at the introductory level in quantum mechanics is highly desirable. Methods to be explored include density functional theory, ab initio methods, semiempirical molecular orbital theory, and visualization software for the graphical display of molecules.

**CHE 561. ADVANCED THERMODYNAMICS.**

An examination of the fundamental concepts of classical thermodynamics and presentation of existence theorems for the thermodynamic properties with study of relations among them. The inequality of Clausius as a criterion for equilibrium in both chemical and physical systems. Examination of thermodynamic equilibrium for a variety of restraining conditions. Applications to fluid mechanics, process systems and chemical systems. Computation of complex equilibria.

**CHE 571. INTERMEDIATE TRANSPORT PHENOMENA.**

Mass, momentum and energy transport; analytic and approximate solutions of the equations of change. Special flow problems such as creeping, potential and laminar boundary-layer flows. Heat and mass transfer in multi-component systems. Estimation of heat and mass transfer rates. Transport with chemical reaction.

**CHE 573. SEPARATION PROCESSES.**

Thermodynamics of equilibrium separation processes such as distillation, absorption, adsorption and extraction. Multi-staged separations. Principles and processes of some of the less common separations.

**CHE 574. FLUID MECHANICS.**

Advanced treatment of fluid kinematics and dynamics. Stress and strain rate analysis using vectors and tensors as tools. Incompressible and compressible, one-dimensional flows in channels, ducts and nozzles. Nonviscous and viscous flow fields. Boundary layers and turbulence. Flow through porous media such as fixed and fluidized beds. Two-phase flows with drops, bubbles and/or boiling. Introduction to non-Newtonian flows.

**CHE 580. SPECIAL TOPICS.**

This course will focus on various topics of current interest related to faculty research experience.

---

## CHEMISTRY AND BIOCHEMISTRY

---



---

### GENERAL CHEMISTRY SEQUENCE

---

The general chemistry sequence, CH 1010—1040, is a unified sequence of courses in which areas of major importance in chemistry are discussed in depth from both the empirical and theoretical viewpoints. Each of the four courses develops a theme, or core idea, of chemistry. The sequence is designed for biology, science and engineering majors.

The format of each course includes four 1-hour classroom meetings and one 3-hour laboratory meeting per week. For reasons of safety, contact lenses may not be worn in the chemical laboratories. Prescription glasses meeting the ANSI standard Z87.1 will be accepted as affording adequate eye protection in the laboratory. Otherwise, goggles meeting these standards must be worn at all times.

**CH 1010. MOLECULARITY.***Cat. I*

The theme of CH 1010 is that all matter in the universe is composed of atoms bonded together in a limited number of ways. Molecularity is one of a small number of fundamental themes of chemistry (and of all science); it is important for us to address it immediately because it permeates all of chemistry.

Specific concepts that we will discuss are:

- Introduction to the Molecular View
- Types of Compounds: The Periodic Table
- Chemical Calculations
- Types of Reactions
- The Quantum Structure of the Atom

**CH 1020. FORCES AND BONDING.***Cat. I*

We will examine the origin and strength of electrical forces within molecules (covalent bonds), between positive and negative ions in a lattice (ionic bonds), and between atoms or molecules of a pure substance (intermolecular forces). Energy changes accompanying the rupture or formation of such bonds will be discussed.

Specific concepts that we will discuss are:

- Molecular Structure and Shape
- Gases
- Solids
- Intra- and Intermolecular Forces
- Liquids
- Energy (First Law of Thermodynamics)

**CH 1030. EQUILIBRIUM.***Cat. I*

We will examine the nature of dynamic equilibrium at the molecular level, and will develop an understanding of the mathematical aspects of equilibrium. Phase equilibrium, further aspects of thermodynamics (entropy, free energy), equilibrium of chemical reactions in the gas phase, and equilibrium of chemical reactions in solution will be discussed.

Specific concepts that we will discuss are:

- Phase Equilibrium
- Chemical Equilibrium of Gas Phase Reactions



Solutions  
Chemical Equilibrium of Reactions in Solution  
Entropy and Free Energy

**CH 1040. DYNAMICS.***Cat. I*

We will examine the nature of molecular motions and their interaction with light, which provides us with all of our structural information about molecules. Various types of molecular spectroscopy will be discussed. Then we will turn to the dynamics of interactions between molecules, examining the rates of chemical reactions, and discussing the detailed molecular pathways by which they occur.

Specific concepts that we will discuss are:

- NMR Spectroscopy
- Vibrational Spectroscopy
- Electronic Spectroscopy
- Dynamics of Physical Processes (Diffusion, phase changes, phase distribution)
- Dynamics of Chemical Processes

**ORGANIC CHEMISTRY COURSES****CH 2310. ORGANIC CHEMISTRY I.***Cat. I*

A systematic survey of the major reaction types and functional groups in organic chemistry. The course will provide a representative collection of characteristic reactions and transformations of a variety of types of organic molecules. Most of the examples will be drawn from aliphatic chemistry. Some theoretical models will be introduced with a view toward establishing a general overview of the material.

The course is intended for chemists, chemical engineers, pre-medical students and all those interested in the biosciences. A familiarity with the material presented in the general chemistry courses is assumed.

**CH 2320. ORGANIC CHEMISTRY II.***Cat. I*

Modern theories of aromaticity, including a general assessment of delocalized bonding. The chemistry of some significant functional groups not surveyed in Organic Chemistry I, and the meaning of acidity and basicity in organic chemistry, will be more fully explored. The course will provide an introduction to the systematic synthesis of polyfunctional organic compounds.

Recommended background: CH 2310. The course is intended for chemists, chemical engineers and bio-science majors.

**CH 2330. ORGANIC CHEMISTRY III.***Cat. I*

This course fully explores three most important analytical methods in organic chemistry: infrared spectroscopy, mass spectrometry, and nuclear magnetic resonance spectroscopy. It will continue the coverage of aromatic chemistry. New topics to be introduced include structures, properties, and reactivities of aldehydes and ketones, carboxylic acids and their derivatives, amines, and the interaction among polyfunctional compounds. It reinforces the retrosynthetic analysis and multistep synthesis of organic compounds and revisits reaction mechanisms and stereochemistry of all the new functional groups studied.

Recommended background: CH2310 and CH2320. The course is intended for biochemists, chemists, chemical engineers and bioscience majors.

**CH 2360. ORGANIC LABORATORY.***Cat. I*

Laboratory experience in the preparation, purification, and characterization of organic substances. The course will also contain sufficient training in laboratory technique and data handling so that no previous laboratory experience beyond that of general chemistry will be assumed. (To be taken concurrently or following studies in organic chemistry.) Recommended for chemical engineers, pre-medical students, BB majors, and other nonchemists desiring chemical laboratory experience. One lecture and three three-hour labs.

**CH 3310. ADVANCED ORGANIC CHEMISTRY.***Cat. II*

This course will review and further develop concepts introduced in CH2310, CH2320, and CH2330. These concepts will include oxidation states of organic compounds, acidity and basicity, and stereochemistry and conformational analysis. Chemical reactivity will be emphasized and will include functional group interconversion and ionic and free radical carbon-carbon bond formation.

Recommended background: CH2310, CH2320, and CH2330. This course is intended for students planning to take advanced courses in organic and/or medicinal chemistry and for chemists, biochemists, chemical engineers, and bio-science majors who desire a stronger background in organic chemistry.

Offered in 2008-09 and in alternating years thereafter.

**EXPERIMENTAL CHEMISTRY SEQUENCE**

The following four courses provide a full-year laboratory program. The purpose of this sequence is to train students in the most essential laboratory techniques, procedures and instrumentation of experimental chemistry. It aims to develop the skills needed for effective work on future chemical laboratory projects such as the Major Qualifying Project. The work of the year develops sequentially.

**CH 2640. EXPERIMENTAL CHEMISTRY I: INSTRUMENTAL ANALYSIS.***Cat. I*

This laboratory course focuses on the application of modern instrumental methods of analysis to chemical, biochemical and environmental problems. Practical experience is gained in quantitative electrochemistry, ultraviolet-visible spectrophotometry, fluorometry and bioluminescence, high performance liquid chromatography, and capillary electrophoresis. Principles of experimental design and execution are developed as student teams select a chemical, biochemical or environmental problem, formulate an approach, conduct the analysis, and present findings to the class. Methods of data analysis and common statistical approaches are emphasized throughout the course.

Recommended background: CH 1010, CH1020, CH1030, CH 1040.

**CH 2650. EXPERIMENTAL CHEMISTRY II.***Cat. I*

The experiments to be performed this term have been chosen to illustrate important principles and experimental techniques of physical chemistry. Students will gain experience with many of the instruments that they are likely to use in any chemical laboratory setting. These include optical spectrometers, vacuum lines, molecular modeling workstations and calorimeters.

Recommended background: CH 2640 and CH 3510.

**CH 2660. EXPERIMENTAL CHEMISTRY III.***Cat. I*

The emphasis in CH 2660 is on basic techniques essential for the synthesis, isolation, and characterization of organic compounds. These include isolation and purification by solvent extraction, crystallization, distillation, and chromatographic techniques, followed by the determination of physical properties and characterization by infrared and nuclear magnetic resonance spectroscopy. Micro-synthetic procedures are introduced. Mastery of the techniques and manipulations emphasized in CH 2640 and CH 2650 would be advantageous.

**CH 2670. EXPERIMENTAL CHEMISTRY IV.***Cat. I*

The synthesis, isolation, and characterization of inorganic compounds are emphasized. Syntheses of main group compounds, classical transition metal complexes, and organotransition metal compounds are included. In addition to reinforcing and building on standard techniques of synthesis and characterization, several new techniques are introduced: synthesis under inert atmosphere, measurement of magnetic susceptibility by NMR, and cyclic voltammetry. Some exposure to <sup>13</sup>C NMR is also provided. The final experiment of the course requires the student to design a synthesis for a compound selected from a list provided, based on strategies learned in the course.

**INORGANIC AND PHYSICAL CHEMISTRY COURSES****CH 3410. PRINCIPLES OF INORGANIC CHEMISTRY.***Cat. I*

This course provides the fundamental understanding of atomic, molecular and solid state structures and properties. Orbital structures of atoms, symmetry of molecules and point groups are used to understand chemical bonding and reactions. Various acid-base concepts are explored to analyze the acidity of cations and basicity of anions, solubility and precipitations of inorganic compounds, and metal-ligand binding affinities. Redox properties are discussed using Pourbaix diagrams. Thermodynamic stabilities of inorganic species are discussed using acid-base and redox concepts and thermochemical analyses are used to analyze chemical reactivity at atomic, molecular, and solid state level.

**CH 3510. CHEMICAL THERMODYNAMICS.***Cat. I*

The content of this course will be the development of the principles of classical thermodynamics. The laws of thermodynamics will be developed by using a series of increasingly complex model systems and a universal equation of state is formulated which incorporates the relationships illustrated by these model systems. Using this equation it will be possible to appreciate that thermodynamic laws are applicable to all systems of matter, regardless of their complexity.

Finally, the principles developed are applied to problems of a chemical nature, focusing on predicting the spontaneity of chemical reactions.

The material in this course will be of greatest interest to those students enrolled in the basic sciences including biology, chemistry, and physics, and in applied fields such as chemical engineering, materials science and biotechnology.

Recommended background: Students should be familiar with the material covered in the general chemistry sequence CH 1010-1040, and calculus including multi variables.

#### CH 3530. QUANTUM CHEMISTRY.

##### *Cat. I*

An introduction to quantum mechanics with applications to atomic and molecular species. The course will be developed systematically beginning with the postulates of quantum mechanics. The Schrodinger equation will be applied to systems such as the particle in a box, the rigid rotor, the harmonic oscillator and the hydrogen atom. Emphasis will be given to a quantum mechanical description of multielectron atoms, molecular bonding and spectroscopy.

Recommended background: a solid foundation in elementary physics and calculus.

This course is normally for students in their third year.

#### CH 3550. CHEMICAL DYNAMICS.

##### *Cat. I*

This course deals in a general way with the interactions between energy and molecules, and considers how energetic and structural considerations affect the outcome of molecular interactions. The manipulation of kinetic data and results is stressed. Selected topics from both organic and inorganic chemistry are analyzed in terms of reaction thermodynamics, rates and mechanisms.

Students are expected to be familiar with thermodynamics, equilibria, reaction rates and the Periodic Table of the elements.

The following three courses, CH 4110, CH 4120, and CH 4130, are a three-term sequence intended to provide a strong emphasis in biochemistry. As background for this sequence, CH 1010, CH 1020, CH 1030, CH 1040, CH 2310, CH 2320, and CH 2330, or their equivalents, are recommended.

## BIOCHEMISTRY COURSES

#### CH 4110. BIOCHEMISTRY I.

##### *Cat. I*

The principles of protein structure are presented. Mechanisms of enzymatic catalysis, including those requiring coenzymes, are outlined in detail. The structures and biochemical properties of carbohydrates are reviewed. Bioenergetics, the role of ATP, and its production through glycolysis and the TCA cycle are fully considered.

Recommended background: CH 2310, CH 2320.

Suggested background: CH 2330.

#### CH 4120. BIOCHEMISTRY II.

##### *Cat. I*

Oriented around biological membranes, this course begins with a discussion of electron transport and the aerobic production of ATP followed by a study of photosynthesis. The study of the biosynthesis of lipids and steroids leads to a discussion of the structure and function of biological membranes. Finally the membrane processes in neurotransmission are discussed.

Recommended background: CH 4110.

#### CH 4130. BIOCHEMISTRY III.

##### *Cat. I*

This course presents a thorough analysis of the biosynthesis of DNA (replication), RNA (transcription), and proteins (translation). Proteins and RNAs have distinct lifetimes within the living cell; thus the destruction of these molecules is an important biochemical process that is also discussed. In addition to mechanistic studies, regulation of these processes is covered.

Students who have received credit for CH 4130 or BB 4910 prior to Term A 2000 may not receive credit for the other course.

#### CH 4150. EXPERIMENTAL BIOCHEMISTRY.

##### *Cat. I*

The experiments in this laboratory course have been designed to acquaint the students with the basic skills necessary to perform biochemical studies. The course will cover, for instance, protein purification, subcellular fractionation, enzyme kinetics (Km, Vmax, specific activity, effector-protein interaction, etc.), exclusion and ion exchange chromatography, and electrophoresis.

Recommended background: CH 4120.

#### CH 4160. MEMBRANE BIOPHYSICS.

##### *Cat. II*

This course will focus on different areas of biophysics with special emphasis on membrane phenomena. The biomedical-biological importance of biophysical phenomena will be stressed. The course will begin with the introduction of the molecular forces relevant in biological media and subsequently develop the following topics: Membrane Structure and Function; Channels, Carriers and Pumps; Nerve Excitation and related topics; and Molecular Biophysics of Motility.

Recommended background: prior knowledge of Biochemistry (CH 4110, CH 4120), Mechanics (PH 1110) and Electricity (PH 1120).

This course will be offered in 2009-10 and in alternating years thereafter.

#### CH 4190. REGULATION OF GENE EXPRESSION.

##### *Cat. I*

This course will cover the biochemical mechanisms involved in regulation of gene expression, modifications of DNA structures that influence transcription rates, transcriptional regulation by protein binding, post-transcriptional modifications of RNA including splicing and editing, regulation of translation including ribosome binding and initiation of translation, and factors that control the half-lives of both mRNA and protein. During the course, common experimental methods will be explored, including a discussion of the information available from each method.

Recommended background CH 4110, CH 4120, CH 4130, BB 4010

## ADVANCED CHEMISTRY COURSES

#### CH 4330. ORGANIC SYNTHESIS.

##### *Cat. II*

A discussion of selected modern synthetic methods including additions, condensations and cyclizations. Emphasis is placed on the logic and strategy of organic synthesis. This course is intended to follow CH 2330.

Recommended background: CH 2310, CH 2320, and CH 2330.

This course will be offered in 2008-09 and in alternating years thereafter.

#### CH 4420. INORGANIC CHEMISTRY II.

##### *Cat. II*

Complexes of the transition metals are discussed. Covered are the electronic structures of transition metal atoms and ions, and the topological and electronic structures of their complexes. Symmetry concepts are developed early in the course and used throughout to simplify treatments of electronic structure. The molecular orbital approach to bonding is emphasized. The pivotal area of organotransition metal chemistry is introduced, with focus on complexes of carbon monoxide, metal-metal interactions in clusters, and catalysis by metal complexes.

Recommended background: CH 1010 - CH 1040, CH 2640 - CH 2670, CH 3410, CH 3530, and CH 3550.

This course will be offered in 2009-10 and in alternating years thereafter.

#### CH 4520. CHEMICAL STATISTICAL MECHANICS.

##### *Cat. II*

This course deals with how the electronic, translational, rotational and vibrational energy levels of individual molecules, or of macromolecular systems, are statistically related to the energy, entropy, and free energy of macroscopic systems, taking into account the quantum mechanical properties of the component particles. Ensembles, partition functions, and Boltzmann, Fermi-Dirac, and Bose-Einstein statistics are used. A wealth of physical chemical phenomena, including material related to solids, liquids, gases, spectroscopy and chemical reactions are made understandable by the concepts learned in this course.

Recommended background: CH 3510 and CH 3530, or equivalent, and mathematics through differential and integral calculus.

This course will be offered in 2009-10 and in alternating years thereafter.

#### CH 4550. POLYMER CHEMISTRY.

##### *Cat. II*

Fundamentals of polymer science and technology based on organic polymers. The principal mechanisms of polymerization including radical, ionic and condensation, are covered in detail. Characterization of polymers by physical means. Mechanical behavior including bulk and solution properties of polymers. Polymer syntheses and modifications including block and graft copolymerization.

Structure, property and end use applications of plastic materials. Plastics processing, testing and technology. Survey of commodity plastics as well as engineering resins including their applications and economic considerations. Presentation of trade and technical literature in the field.

Recommended background: CH 2310 and CH 2320 or equivalent.

This course will be offered in 2009-10 and in alternating years thereafter.



## GRADUATE CHEMISTRY COURSES OF INTEREST TO UNDERGRADUATES

### CH 516. CHEMICAL SPECTROSCOPY.

Advanced topics in identification of organic species and determination of molecular structure by spectroscopic methods.

Methods covered include  $^1\text{H}$ - and  $^{13}\text{C}$ -NMR, mass spectrometry and infrared and UV-visible spectroscopy. This course is concerned only with interpretation of spectra and does not cover techniques obtaining them; there is no laboratory.

### CH 533. PHYSICAL ORGANIC CHEMISTRY.

Mechanics of representative organic reactions, and the methods used for their evaluation. Structural, electronic, and stereochemical influences on reaction mechanisms are explored. Emphasis is on the various techniques used to obtain insights into mechanisms, and on the interplay of data and interpretation.

### CH 536. THEORY AND APPLICATIONS OF NMR SPECTROSCOPY.

This course emphasizes the fundamental aspects of 1D and 2D nuclear magnetic resonance spectroscopy (NMR). The theory of pulsed Fourier transform NMR is presented through the use of vector diagrams. A conceptual nonmathematical approach is employed in discussion of NMR theory. The course is geared toward an audience which seeks an understanding of NMR theory and an appreciation of the practical applications of NMR in chemical analysis. Students are exposed to hands-on NMR operation. Detailed instructions are provided and each student is expected to carry out his or her own NMR experiments on a Bruker AVANCE 400 MHz NMR spectrometer.

### CH 538. MEDICINAL CHEMISTRY.

This course will focus on the medicinal chemistry aspects of drug discovery from an industrial pharmaceutical Research and Development perspective. Topics will include Chemotherapeutic Agents (such as antibacterial, antiviral and antitumor agents) and Pharmacodynamic Agents (such as antihypertensive, antiallergic, antiulcer and CNS agents).

Recommended background: CH 2310, CH 2320, and CH 2330.

### CH 554. MOLECULAR MODELING.

This course trains students in the area of molecular modeling using a variety of quantum mechanical and force field methods. The approach will be toward practical applications, for researchers who want to answer specific questions about molecular geometry, transition states, reaction paths and photoexcited states. No experience in programming is necessary; however, a background at the introductory level in quantum mechanics is highly desirable. Methods to be explored include density functional theory, ab initio methods, semiempirical molecular orbital theory, and visualization software for the graphical display of molecules.

### CH 555. ADVANCED TOPICS.

A course of advanced study in selected areas whose content and format to suit the interest and needs of faculty and students.

## CIVIL AND ENVIRONMENTAL ENGINEERING

### CE 1030. CIVIL ENGINEERING AND COMPUTER FUNDAMENTALS.

*Cat. I*

This course introduces students to basic fundamentals of civil engineering, group dynamics, oral presentation skills, engineering report writing techniques, and uses of the computer. Basics of structural engineering, geotechnical engineering, environmental engineering, surveying, materials, and construction engineering and management are presented in this course through a collaborative group teaching approach. Background is provided to gain competence in operating systems, editors, and spreadsheets. Student groups complete weekly computer laboratory projects and develop oral presentations and written reports.

No previous computer use skills are required or assumed. This course is recommended for freshman or sophomore students.

### CE 2000. ANALYTICAL MECHANICS I.

*Cat. I*

This fundamental civil engineering course provides an introduction to the analysis of structures in static equilibrium. The focus of this course is a classical analysis of concurrent and non-concurrent equilibrium. A variety of engineering problems including trusses, machines, beams, rigid frames, and hydraulic structures involving concentrated and distributed loading systems are analyzed for external reactions and internal forces.

### CE 2001. ANALYTICAL MECHANICS II.

*Cat. I*

This course provides an introduction to the relationship between analysis, design, and the behavior of materials under load. Theory and applications are developed that utilize simple and combined stress-strain behavior of members subjected to axial, torsional, and flexural loadings, with applications to beams, trusses, rigid frames, shafts, and tension and compression structures.

Recommended background: CE 2000.

### CE 2002. INTRODUCTION TO ANALYSIS AND DESIGN.

*Cat. I*

This course develops an understanding of classical and modern structural analysis. Topics include loading systems, and the analysis of statically determinate and statically indeterminate beams, frames, trusses, structural floor systems for buildings, bridges, and other structural assemblies.

Recommended background: CE 2000 and CE 2001.

Suggested background: CE 1030.

### CE 2020. SURVEYING.

*Cat. I*

This course develops fundamental skills in the theoretical and practical aspects of plane surveying through the use and care of modern instruments and the associated computations. Topics include the classification of errors incurred in observed field data and necessary correction applications, the use and care of surveying equipment, traversing, differential leveling, stadia and mapping, and electronic data transfer. Computer applications are used where appropriate.

### CE 3006. DESIGN OF STEEL STRUCTURES.

*Cat. I*

This course covers the theory and practice of structural steel design. The structural design process for beams, columns, trusses, frames, and connections is based on Load and Resistance Factor Design (LRFD) specifications of the American Institute of Steel Construction.

Recommended background: CE 2002 and CE 3010.

Suggested background: CE 1030.

### CE 3008. DESIGN OF REINFORCED CONCRETE STRUCTURES.

*Cat. I*

This course covers the theory and practice of reinforced concrete design. The structural design process for beams, columns, slabs, frames, flat slabs, footings, and retaining walls uses the ultimate strength design codes of the American Concrete Institute.

Recommended background: CE 2002 and CE 3010.

Suggested background: CE 1030.

### CE 3010. STRUCTURAL ENGINEERING.

*Cat. I*

This course provides an understanding of the practice of structural engineering. It builds upon the fundamental skills developed in CE 2000, CE 2001, and CE 2002 to present the principles of structures and their elements. The course provides a perspective for dealing with the issues of strength, stiffness, and stability. Although wood is the principle material used to develop the study of the interrelationship between analysis and design of structural systems, structural steel and reinforced concrete systems are also discussed. It also introduces students to the use of building codes for design criteria. The role of the structural engineer in the design process and cost factors are also discussed.

Recommended background: CE 2000, CE 2001, and CE 2002.

Suggested background: CE 1030.

### CE 3020. PROJECT MANAGEMENT.

*Cat. I*

This course presents the fundamental concepts and process of project management applied to public and private works. The principle focus of the course is the management of civil engineering projects including planning, scheduling, organization and control, as well as management concepts of leadership, motivation, trust, project team development, division of work, and conflict resolution. Ancillary engineering and construction practices involving financial practices, construction documents, contract negotiation and administration, quality and safety control, insurance and bonding are covered.

Recommended background: CE 1030.

### CE 3021. COST ESTIMATING, SCHEDULING AND PROJECT CONTROL.

*Cat. II*

This course presents the fundamental concepts and processes by which the cost and time of execution of civil engineering projects are established. It emphasizes the importance of decisions made at the early stages of design on final project cost. The relationship between time and cost is examined in detail. Topics include: construction methods, quantity surveying, resource pricing, activity planning, resource allocation, financial analysis, bidding, job cost accounting and cost

control with extensions to operating and maintenance costs. Commercial software for project scheduling, cost estimating, and cost control is used in this course.

Recommended background: CE 1030 and CE 3020.

Offered in 2008-09 and in alternating years thereafter.

#### **CE 3022. LEGAL ASPECTS IN DESIGN AND CONSTRUCTION.**

*Cat. II*

This course addresses legal aspects that underpin the planning, design and construction of a project. The principle focus is the contracts, laws, specifications, and design documents needed to conduct civil engineering practice in the United States. Labor, safety, and environmental laws are reviewed, as well as the role of ethics and professional relationships with the client, other professional organizations and groups, the public, and the regulatory system.

Recommended background: CE 3020.

Offered in 2009-10 and in alternating years thereafter.

#### **CE 3023. ARCHITECTURAL ENGINEERING SYSTEMS.**

*Cat. I*

This course introduces the fundamental concepts associated with the design and construction of a building. Major building components, such as foundations, structures, envelopes and environmental systems are presented as subsystems to be integrated. The systems approach is utilized to describe the functional interdependence of building components and the interdisciplinary nature of the design of contemporary buildings. Building components are analyzed in terms of design details and constructability implications. Graphic representation and building design exercises as well as case studies are used to illustrate the topic.

#### **CE 3024. CONTROL SURVEYING.**

*Cat. II*

This course presents the principles and field procedures required in the design of vertical and horizontal control networks for large building and construction projects.

Recommended background: CE 2020.

Offered in 2008-09 and in alternating years thereafter.

#### **CE 3026. MATERIALS OF CONSTRUCTION.**

*Cat. I*

This course provides an understanding of the use and acquisition of engineering properties of construction materials. Topics include relationships between the structure of materials, their engineering properties, and the selection of suitable materials for applications involving strength, durability, and serviceability. Experimental laboratory procedures including design of experiments, data collection, analysis, and representation, and report writing are an integral part of the work.

Recommended background: CE 1030 and CE 2001.

#### **CE 3030. FUNDAMENTALS OF CIVIL ENGINEERING AUTOCAD.**

*Cat. I*

This course introduces Civil Engineering students to fundamental uses of the AutoCAD software package. Basic two dimensional drawing techniques are covered. Advanced topics that may be covered include three dimensional drawing, rendering and animation. Students are required to become familiar with AutoCAD.

Knowledge of the subject matter in at least two civil engineering design courses is expected background for this course.

#### **CE 3041. SOIL MECHANICS.**

*Cat. I*

This is an introductory course dealing with the science and technology of earth materials with an emphasis on fundamental concepts of particulate mechanics. The topics which are discussed include fluid flow through porous media, deformation and shear characteristics of soil, consolidation, lateral earth pressure, and slope stability.

Recommended background: CE 2000 and CE 2001.

Suggested background: GE 2341.

#### **CE 3044. FOUNDATION ENGINEERING.**

*Cat. II*

Foundation engineering is a study of the applications of the principles of soil mechanics and structural theory to the analysis, design and construction of foundations for engineering works with the emphasis on the soil engineering aspects of soil structure interaction. Subsurface exploration techniques, design of rigid and flexible retaining structures, and design of, shallow and deep foundations are considered. Although the course deals mainly with aspects of the

design of buildings and bridges, certain parts of the course (design of temporary trench bracing, for example) are very relevant to construction engineering.

Recommended background: CE 3041.

Suggested background: CE 3008.

Offered in 2008-09 and in alternating years thereafter.

#### **CE 3050. INTRODUCTION TO TRANSPORTATION ENGINEERING.**

*Cat. I*

This course provides an introduction to the field of transportation engineering with particular emphasis on traffic engineering and highway design. Topics covered include a description of the transportation industry and transportation modes; characteristics of drivers, pedestrians, vehicles and the roadway; traffic engineering studies, highway safety, principles of traffic flow, intersection design and control, capacity analysis, level of service analysis; geometric design of highways; paving materials and pavement design.

Suggested background: CE 2020.

#### **CE 3051. INTRODUCTION TO PAVEMENT MATERIALS, DESIGN AND MANAGEMENT.**

*Cat. I*

This course provides an introduction to concepts required for design construction and management of pavements. Topics include Highway Drainage, Soil Engineering for Highway Design, Bituminous Materials, Design of Flexible and Rigid Pavements and Pavement Management. Knowledge of the subject matter in CE 3050 is helpful but not required.

#### **CE 3059. ENVIRONMENTAL ENGINEERING.**

*Cat. I*

This is an introductory course in the area of environmental engineering. The course should also be of interest to students who require an overall understanding of environmental engineering problems. Topics covered include: environmental impact of population growth and energy demand, water resources, water chemistry, water quality standards, environmental microbiology, wastewater characteristics, receiving water quality and dissolved oxygen budgets, water pollution abatement, sludge management, solids and hazardous waste management, and an introduction of air and noise pollution.

Recommended background: CH 1010 and CH 1020 or equivalent.

#### **CE 3060. WATER TREATMENT.**

*Cat. I*

This course provides in-depth coverage of processes used in water treatment. Topics include: review of water chemistry and drinking water standards, impurities in natural waters, aeration, water softening coagulation, flocculation, sedimentation, filtration, disinfection, taste and odor control, corrosion control, and iron and manganese removal.

Recommended background: CE 3059 and ES 3004.

#### **CE 3061. WASTE WATER TREATMENT.**

*Cat. I*

This course provides in-depth coverage of processes used in wastewater treatment. Topics include: review of water quality standards, wastewater characteristics, application of biochemical oxygen demand, sources and effects of pollution, physical, chemical, and biological wastewater treatment processes, and waste sludge management.

Recommended background: CE 3059 and ES 3004.

#### **CE 3062. HYDRAULICS.**

*Cat. I*

This course provides a background for applying the principles of fluid mechanics to analyze and design hydraulic and fluid flow systems for projects related to water resources and civil and environmental engineering. Topics include hydraulics in pipes and closed systems, open channels and rivers, water supply systems and water distribution networks, pump systems and turbines, wastewater collection and treatment systems, and coastal and other natural environmental systems. Course content includes water quality and energy considerations, as well as the development and application of hydraulic models.

Recommended background: ES 3004.

#### **CE 3070. URBAN AND ENVIRONMENTAL PLANNING.**

*Cat. I*

This course introduces to the student the social, economic, political, and environmental factors that affect the population growth and distribution patterns, and the impact of such patterns to the natural environment. By using the principles and procedures of planning, the optimal growth pattern may be examined, and the infrastructure (roads, water supply systems, waste-water treatment systems, shopping malls, etc.) necessary to support present and future growth patterns may be determined.

The information necessary in planning, which involves conscious procedures of analysis, formulation of alternative solutions, rational assessment and deliberate choice in accordance with evaluation criteria, is obtained through extensive reading. As such the course introduces a variety of topics of concern to engineers and environmentalists. The course is intended not only for civil engineering majors, but also for students preparing for an IQP in areas of urban or environmental concerns.

#### **CE 3074. ENVIRONMENTAL ANALYSIS.**

##### *Cat. II*

This course provides a background in the principles and techniques of assessing areas of natural environment and the application of this assessment to evaluate the inherent suitability for urban and resource based uses and facilities. The techniques developed in this course will be useful for land use planning, site design, and the impact of engineering projects on the environment.

Suggested background: CE 3070.

This course will be offered in 2009-10 and in alternating years thereafter.

#### **CE 4007. MATRIX ANALYSIS OF STRUCTURES.**

##### *Cat. II*

This course presents the principles of matrix analysis of structural elements and systems; fundamentals of matrix algebra, solution of simultaneous equations, matrix inversion; analysis of plane trusses, method of joints; displacement method, principle of virtual work, analysis of continuous beams, analysis of plane frames, plane trusses, analysis of building frames and bridges; computer aided structural analysis and principles of software development.

Recommended background: CE 2002.

Offered in 2008-09 and in alternating years thereafter.

#### **CE 4017. PRESTRESSED CONCRETE DESIGN.**

##### *Cat. II*

This course covers analysis and design aspects of prestressed concrete structural elements and systems: principles of prestressing, materials for prestressing, high strength steel, flexural analysis and design methods; allowable stress and strength design methods; design of beams, load balancing, partial prestressing and cracking moment; design for shear, partial loss of prestress; deflections of prestressed concrete and precast construction; connections.

Recommended background: CE 2002 and CE 3026.

Suggested background: CE 3008.

Offered in 2009-10 and in alternating years thereafter.

#### **CE 4046. EXPERIMENTAL SOIL MECHANICS.**

##### *Cat. II*

The standard laboratory soil testing procedures generally encountered in civil engineering are introduced in this course. It further includes a limited discussion of soil behavior primarily based on the effect of soil's physical and chemical properties on laboratory test results. The tests which are performed include: grain size analysis, Atterberg limits, specific gravity, permeability, compaction, compression and consolidation, and direct and triaxial shear. The student's results of the various tests are integrated within an engineering problem.

Recommended background: CE 3041.

Offered in 2009-10 and in alternating years thereafter.

#### **CE 4054. SOIL AND BITUMINOUS MATERIALS LABORATORY.**

##### *Cat. I*

This laboratory-based course introduces standard laboratory soil and asphalt materials testing procedures, and effect of physical properties on performance of soils and asphalt pavements. The tests which are performed include: grain size analysis, Atterberg limits, specific gravity, permeability, compaction, compression and consolidation, and triaxial shear for soils, and penetration, consensus and source properties of aggregate, compaction, resilient modulus, indirect tensile strength and nondestructive testing of soils and hot mix asphalt.. Instruction is provided through lecture, laboratory work and field trip.

Recommended background: CE 3041 and CE 3052.

#### **CE 4060. ENVIRONMENTAL ENGINEERING LABORATORY.**

##### *Cat. I*

This course familiarizes students with the laboratory studies used to obtain the design parameters for water and wastewater treatment systems. The topics include laboratory experiments dealing with physical, chemical, and biological treatment systems.

Recommended background: CE 3060 and CE 3061.

#### **CE 4061. HYDROLOGY.**

##### *Cat. II*

This course provides a quantitative description of the rainfall and runoff process for use in design of water resource related projects. Topics include: the review of the hydrologic cycle, precipitation, evaporation, transpiration, infiltration, stream flow measurements, flow routing, runoff analysis, show hydrology and development of drainage estimates for development plans. The course involves a stream measurement laboratory and application of model for hydrological and hydraulic engineering applications.

Recommended background: ES 3004.

This course will be offered in 2008-09 and in alternating years thereafter.

#### **CE 4071. LAND USE DEVELOPMENT AND CONTROLS.**

##### *Cat. I*

The purpose of this course is to provide an understanding of how land use controls may be used to effectively shape our physical, social, and economic development. The quality of our environment depends upon the development which is permitted to take place and the controls which direct that development. Through this course, the student will learn the principles, methods, and techniques which a planner may use to plan the uses and development of land. In particular, the use and limits of zoning, special permits, hammerhead lots, subdivision control, comprehensive permits, and other tools with which a developer of planner board member should be familiar will be examined in detail.

---

## COMPUTER SCIENCE

---

#### **CS 1101. INTRODUCTION TO PROGRAM DESIGN.**

##### *Cat. I*

This course introduces principles of computation and programming with an emphasis on program design. Topics include design and implementation of programs that use a variety of data structures (such as records, lists, and trees), functions, conditionals, and recursion. Students will be expected to design, implement, and debug programs in a functional programming language.

Intended audience: students desiring an introduction to programming and program design.

Recommended background: none. Either CS 1101 or CS 1102 provide sufficient background for further courses in the CS department. Undergraduate credit may not be earned for both this course and CS 1102.

Undergraduate credit may not be earned both for this course and for CS 2135.

#### **CS 1102. ACCELERATED INTRODUCTION TO PROGRAM DESIGN.**

##### *Cat. I*

This course provides an accelerated introduction to design and implementation of functional programs. The course presents the material from CS 1101 at a fast pace (so students can migrate their programming experience to functional languages), then covers several advanced topics in functional programming (potential topics include macros, lazy programming with streams, and programming with higher-order functions). Students will be expected to design, implement, and debug programs in a functional programming language.

Intended audience: students starting with substantial previous programming background.

Recommended background: prior programming background covering lists, trees, functions, and recursion.

Undergraduate credit may not be earned for both this course and CS 1101.

Undergraduate credit may not be earned both for this course and for CS 2135.

#### **CS 2011. INTRODUCTION TO MACHINE ORGANIZATION AND ASSEMBLY LANGUAGE.**

##### *Cat. I*

This course introduces students to the structure and behavior of digital computers at several levels of abstraction. Using a bottom-up approach, the course starts by examining logic gates and digital circuits. The student is then introduced to virtual machines at successively higher levels of abstraction, beginning with the Von Neumann model of execution, and progressing through machine language, assembly language, and high-level languages. Topics include the functional organization of computer hardware, the functions of assemblers, linkers, and loaders, representations of numbers in computers, basic assembly language instruction sets, addressing modes, stacks and procedures, low-level I/O, concepts and examples of microprogramming, and logic circuits.

Students will be expected to design, implement, and debug programs in an assembly language.

Intended audience: computer science students, and those desiring a deeper understanding of the low-level functionality of a computer.

Recommended background: CS 2303 or CS 2301.

**CS 2022/MA 2201. DISCRETE MATHEMATICS.***Cat. I*

This course serves as an introduction to some of the more important concepts, techniques, and structures of discrete mathematics, providing a bridge between computer science and mathematics.

Topics include functions and relations, sets, countability, groups, graphs, propositional and predicate calculus, and permutations and combinations.

Students will be expected to develop simple proofs for problems drawn primarily from computer science and applied mathematics.

Intended audience: computer science and mathematical sciences majors.

Undergraduate credit may not be earned both for this course and for CS 501.

Recommended background: none.

**CS 2102. OBJECT-ORIENTED DESIGN CONCEPTS.***Cat. I*

This course introduces students to an object-oriented model of programming. Building from the design methodology covered in CS 1101/CS 1102, this course shows how programs can be decomposed into classes and objects. By emphasizing design, this course shows how to implement small defect-free programs and evaluate design decisions to select an optimal design under specific assumptions. Topics include inheritance, exceptions, interface, design by contract, basic design patterns, and reuse. Students will be expected to design, implement, and debug object-oriented programs composed of multiple classes and over a variety of data structures.

Intended audience: students with prior program design experience who desire to learn object-oriented design.

Recommended background: CS 1101 or CS 1102.

Undergraduate credit may not be earned both for this course and for CS 2136.

**CS 2118. OBJECT-ORIENTED DESIGN CONCEPTS FOR BUSINESS APPLICATIONS.***Cat. I*

This course introduces students to an object-oriented model of programming, with an emphasis on the programming approaches useful in creating business applications. Building from the design methodology covered in CS 1101/CS 1102, this course shows how programs can be decomposed into classes and objects.

Students will be expected to design, implement, and debug object-oriented programs in Visual Basic.

Topics include inheritance, building user interfaces, and database access.

Intended audience: non-CS majors with an interest in building business applications who have prior program design experience.

Recommended background: CS 1101 or CS 1102.

Students may receive credit for only one of the following: MG 2720, MIS 2720, or CS 2118.

**CS 2223. ALGORITHMS.***Cat. I*

Building on a fundamental knowledge of data structures, data abstraction techniques, and mathematical tools, a number of examples of algorithm design and analysis, worst case and average case, will be developed.

Topics include greedy algorithms, divide-and-conquer, dynamic programming, heuristics, and probabilistic algorithms. Problems will be drawn from areas such as sorting, graph theory, and string processing. The influence of the computational model on algorithm design will be discussed.

Students will be expected to perform analysis on a variety of algorithms.

Intended audience: computer science and computer engineering students, and those desiring a deeper understanding of algorithm design and analysis.

Undergraduate credit may not be earned both for this course and for CS 507.

Recommended background: CS 2102 and CS 2022.

**CS 2301. SYSTEMS PROGRAMMING FOR NON-MAJORS.***Cat. I*

This course helps students with prior program design experience migrate their skills to a model of programming where the programming language exposes details of how the hardware stores and executes software. Building from the design concepts covered in CS 1101/CS 1102, this course covers manual memory management, pointers, the machine stack, and input/output mechanisms. Students will be expected to design, implement, and debug programs in C.

Intended audience: non-computer science majors who wish to take upper-level courses in the systems area of the computer science curriculum.

Recommended background: CS 1101 or CS 1102. CS majors and other students wishing to prepare for upper-level CS courses in both systems and software engineering should take CS 2303 instead of CS 2301. Students who have credit for CS 2303 may not receive subsequent credit for CS 2301.

Undergraduate credit may not be earned both for this course and for CS 2005.

**CS 2303. SYSTEMS PROGRAMMING CONCEPTS.***Cat. I*

This course introduces students to a model of programming where the programming language exposes details of how the hardware stores and executes software. Building from the design concepts covered in CS 2102, this course covers manual memory management, pointers, the machine stack, and input/output mechanisms. The course will involve large-scale programming exercises and will be designed to help students confront issues of safe programming with system-level constructs. The course will cover several tools that assist programmers in these tasks. Students will be expected to design, implement, and debug programs in C++ and C.

Intended audience: computer science and computer engineering students with substantial prior object-oriented programming experience.

Recommended background: CS 2102.

**CS 3013. OPERATING SYSTEMS.***Cat. I*

This course provides the student with an understanding of the basic components of a general-purpose operating system.

Topics include processes, process management, synchronization, input/output devices and their programming, interrupts, memory management, resource allocation, and an introduction to file systems.

Students will be expected to design and implement a large piece of system software.

Intended audience: computer science majors and others interested in studying the software and hardware components of computer systems.

Undergraduate credit may not be earned both for this course and for CS 502.

Recommended background: CS 2303 or CS 2301, and CS 2011.

**CS 3041. HUMAN-COMPUTER INTERACTION.***Cat. I*

This course develops in the student an understanding of the nature and importance of problems concerning the efficiency and effectiveness of human interaction with computer-based systems.

Topics include the design and evaluation of interactive computer systems, basic psychological considerations of interaction, interactive language design, interactive hardware design, and special input/output techniques.

Students will be expected to complete two projects. A project might be a software evaluation, interface development, or an experiment.

Intended audience: computer science majors, especially juniors.

Recommended background: CS 2102 or CS 2118.

**CS 3043. SOCIAL IMPLICATIONS OF INFORMATION PROCESSING.***Cat. I*

This course makes the student aware of the social, moral, ethical, and philosophical impact of computers and computer-based systems on society, both now and in the future.

Topics include major computer-based applications and their impact, human-machine relationships, and the major problems of controlling the use of computers.

Students will be expected to contribute to classroom discussions and to complete a number of writing assignments.

Intended audience: students interested in the impact of a computer-oriented technology on his or her future way of life and well-being. This course is highly recommended for juniors.

Undergraduate credit may not be earned both for this course and for CS 505.

Recommended background: a general knowledge of computers and computer systems.

**CS 3133. FOUNDATIONS OF COMPUTER SCIENCE.***Cat. I*

This course introduces the theoretical foundations of computer science. These form the basis for a more complete understanding of the proficiency in computer science.

Topics include computational models, formal languages, and an introduction to compatibility and complexity theory, including NP-completeness.

Students will be expected to complete a variety of exercises and proofs.

Intended audience: computer science majors and others desiring an understanding of the theoretical foundations of computer science.

Undergraduate credit may not be earned both for this course and for CS 503.

Recommended Background: CS 2022 and CS 2223.

Students who have credit for CS 4121 cannot receive credit for CS 3133.

Students graduating under the pre-1996 distribution requirements may satisfy the Theory area requirement by taking this course, although it does not count as a 4000-level course.



**CS 3431. DATABASE SYSTEMS I.***Cat. I*

This course introduces the student to the design, use, and application of database management systems.

Topics include the relational data model, relational query languages, design theory, and conceptual data design and modeling for relational database design. Techniques that provide for data independence, and minimal redundancy will be discussed.

Outcome: Students will be expected to design and implement database system applications.

Intended audience: computer science majors and others interested in studying the development of software applications with large data management requirements.

Undergraduate credit may not be earned both for this course and for CS 4431 or CS 542.

Recommended background: CS 2022 and either CS 2102 or CS 2118.

**CS 3733. SOFTWARE ENGINEERING.***Cat. I*

This course introduces the fundamental principles of software engineering. Modern software development techniques and life cycles are emphasized.

Topics include requirements analysis and specification, analysis and design, architecture, implementation, testing and quality, configuration management, and project management.

Students will be expected to complete a project that employs techniques from the topics studied.

Intended audience: computer science majors and others who expect to design software systems. This course should be taken before any course requiring a large programming project.

Undergraduate credit may not be earned both for this course and for CS 509.

Recommended background: CS 2102.

**CS 4032/MA 3257. NUMERICAL METHODS FOR LINEAR AND NONLINEAR SYSTEMS.***Cat. I*

This course provides an introduction to modern computational methods for linear and nonlinear equations and systems and their applications.

Topics covered include: solution of nonlinear scalar equations, direct and iterative algorithms for the solution of systems of linear equations, solution of nonlinear systems, the eigenvalue problem for matrices. Error analysis will be emphasized throughout.

Recommended background: MA 2071. An ability to write computer programs in a scientific language is assumed.

**CS 4033/MA 3457. NUMERICAL METHODS FOR CALCULUS AND DIFFERENTIAL EQUATIONS.***Cat. I*

This course provides an introduction to modern computational methods for differential and integral calculus and differential equations.

Topics covered include: interpolation and polynomial approximation, approximation theory, numerical differentiation and integration, numerical solutions of ordinary differential equations. Error analysis will be emphasized throughout.

Recommended background: MA 2051. An ability to write computer programs in a scientific language is assumed. Undergraduate credit may not be earned for both this course and for MA 3255/CS 4031.

**CS 4120. ANALYSIS OF ALGORITHMS.***Cat. II*

This course develops the skill of analyzing the behavior of algorithms.

Topics include the analysis, with respect to average and worst case behavior and correctness, of algorithms for internal sorting, pattern matching on strings, graph algorithms, and methods such as recursion elimination, dynamic programming, and program profiling.

Students will be expected to write and analyze programs.

Intended audience: computer science majors.

Undergraduate credit may not be earned both for this course and for CS 504.

Recommended background: CS 2223 and some knowledge of probability.

This course will be offered in 2008-09 and in alternating years thereafter.

**CS 4123. THEORY OF COMPUTATION.***Cat. II*

Building on the theoretical foundations from CS 3133, this course addresses the fundamental question of what it means to be "computable," including different characterizations of computable sets and functions.

Topics include the halting program, the Church-Turing thesis, primitive recursive functions, recursive sets, recursively enumerable sets, NP-completeness, and reducibilities.

Students will be expected to complete a variety of exercises and proofs.

Intended audience: computer science majors and others desiring an understanding of the nature of computation.

Undergraduate credit may not be earned both for this course and for CS 553.

Recommended Background: CS 3133.

This course will be offered in 2009-10 and in alternating years thereafter.

**CS 4233. OBJECT-ORIENTED ANALYSIS AND DESIGN.***Cat. II*

This Software Engineering course will focus on the process of Object-Oriented Analysis and Design. Students will be expected to complete a large number of exercises in Domain Modeling, Use Case Analysis, and Object-Oriented Design. In addition, the course will investigate Design Patterns, which are elements of reusable object-oriented software designs. This course will survey a set of design patterns and consider how these patterns are described and used to solve design problems.

Recommended Background: CS 2303 and CS 3733.

This course will be offered in 2008-09 and in alternating years thereafter.

**CS 4241. WEBWARE: COMPUTATIONAL TECHNOLOGY FOR NETWORK INFORMATION SYSTEMS.***Cat. I*

This course explores the computational aspects of network information systems as embodied by the World Wide Web (WWW). Topics include: languages for document design, programming languages for executable content, scripting languages, design of WWW based human/computer interfaces, client/server network architecture models, high level network protocols (e.g., http), WWW network resource discovery and network security issues.

Students in this course will be expected to complete a substantial software project (e.g., Java based user interface, HTML/CGI based information system, WWW search mechanisms, etc.).

Recommended background: CS 2102 and CS 3013.

**CS 4341. INTRODUCTION TO ARTIFICIAL INTELLIGENCE.***Cat. I*

This course studies the problem of making computers act in ways which we call "intelligent".

Topics include major theories, tools and applications of artificial intelligence, aspects of knowledge representation, searching and planning, and natural language understanding.

Students will be expected to complete projects which express problems that require search in state spaces, and to propose appropriate methods for solving the problems.

Intended audience: computer science majors.

Undergraduate credit may not be earned both for this course and for CS 534.

Recommended background: CS 2102 and CS 2223.

Suggested background: CS 3133.

**CS 4432. DATABASE SYSTEMS II.***Cat. II*

This course concentrates on the study of the internals of database management systems.

Topics include: principles and theories of physical storage management, advanced query languages, query processing and optimization, index structures for relational databases, transaction processing, concurrency control, distributed databases, and database recovery, security, client server and transaction processing systems.

Outcome: Students may be expected to design and implement software components that make up modern database systems.

Intended audience: computer science and computer engineering majors.

Undergraduate credit may not be earned both for this course and CS 542.

Recommended background: CS 3431 and CS 3733.

This course will be offered in 2009-10 and in alternating years thereafter.

**CS 4445. DATA MINING AND KNOWLEDGE DISCOVERY IN DATABASES.***Cat. II*

This course provides an introduction to Knowledge Discovery in Databases (KDD) and Data Mining. KDD deals with data integration techniques and with the discovery, interpretation and visualization of patterns in large collections of data. Topics covered in this course include data warehousing and mediation techniques; data mining methods such as rule-based learning, decision trees, association rules and sequence mining; and data visualization. The work discussed originates in the fields of artificial intelligence, machine learning, statistical data analysis, data visualization, databases, and information retrieval. Several scientific and industrial applications of KDD will be studied.

Recommended background: CS 4341 Introduction to Artificial Intelligence, MA 2611 Applied Statistics I, and CS 3431 Database Systems I.

This course will be offered in 2008-09 and in alternating years thereafter.

#### CS 4513. DISTRIBUTED COMPUTING SYSTEMS.

##### *Cat. I*

This course extends the study of the design and implementation of operating systems begun in CS 3013 to distributed and advanced computer systems.

Topics include principles and theories of resource allocation, file systems, protection schemes, and performance evaluation as they relate to distributed and advanced computer systems.

Students may be expected to design and implement programs that emphasize the concepts of file systems and distributed computing systems using current tools and languages.

Intended audience: computer science and computer engineering majors.

Undergraduate credit may not be earned both for this course and for CS 502.

Recommended background: CS 3013 and a knowledge of probability, such as provided by MA 2621.

#### CS 4514. COMPUTER NETWORKS: ARCHITECTURE AND IMPLEMENTATION.

##### *Cat. I*

This course introduces principles and current trends in computer networks. The ISO Reference Model will be used as the framework with the course progressing through the physical, data link, network, transport, session, and presentation layers with specific examples and standards cited throughout for point-to-point, satellite, packet-radio, and local area networks.

Topics include motivation and objectives of computer networks, overview of network architectures, layered architectures, performance analysis, virtual circuits, datagrams, routing flow control, local area networks, internetworking, end-to-end communication, virtual terminal, file transfer protocols, and client-server programming.

Students will be expected to design and implement projects such as simulation of the network/transport layer functions, routing, congestion control, an Ethernet controller, applications using TCP/IP or remote procedure calls.

Intended audience: computer science and computer engineering majors.

Undergraduate credit may not be earned both for this course and for CS 513.

Recommended background: CS 3013 and some knowledge of probability.

#### CS 4515. COMPUTER ARCHITECTURE.

##### *Cat. II*

This course explores modern computer architectures in terms of instruction sets and the organization of processors, controllers, memories, devices, and communication links.

Topics include an overview of computer systems, theoretical foundations, modern computer system components, pipelining of instruction sets, multifunction pipelines, parallel computer organization.

Students will be expected to design and implement programs which simulate significant components of modern computer architectures.

Intended audience: computer science and computer engineering majors.

Recommended background: CS 2011 or ECE 2801, and CS 3013.

This course will be offered in 2008-09 and in alternating years thereafter.

#### CS 4533. TECHNIQUES OF PROGRAMMING LANGUAGE TRANSLATION.

##### *Cat. II*

This course studies the compiling process for high-level languages.

Topics include lexical analysis, syntax analysis, semantic analysis, symbol tables, intermediate languages, optimization, code generation and run-time systems.

Students will be expected to use compiler tools to implement the front end, and to write a program to implement the back end, of a compiler for a recursive programming language.

Intended Audience: computer science and computer engineering majors.

Undergraduate credit may not be earned for both this course and for CS 544.

Recommended Background: CS 2102 and CS 3133.

This course will be offered in 2008-09 and in alternating years thereafter.

#### CS 4536. PROGRAMMING LANGUAGES.

##### *Cat. II*

This course covers the design and implementation of programming languages.

Topics include data structures for representing programming languages, implementing control structures (such as functions, recursion, and exceptions), garbage collection, and type systems. Students will be expected to implement several small languages using a functional programming language.

Intended audience: CS majors and minors interested in understanding how programming languages work and how to implement their own small languages.

Recommended background: CS 2303, CS 3133, and experience programming in a functional language (as provided by CS 1101 or CS 1102).

Undergraduate credit may not be earned for both this course and CS 536.

This course will be offered in 2009-10 and in alternating years thereafter.

#### CS 4731. COMPUTER GRAPHICS.

##### *Cat. I*

This course studies the use of the computer to model and graphically render two- and three-dimensional structures.

Topics include graphics devices and languages, 2- and 3-D object representations, and various aspects of rendering realistic images.

Students will be expected to implement programs which span all stages of the 3-D graphics pipeline, including clipping, projection, arbitrary viewing, hidden surface removal and shading.

Intended audience: computer science majors.

Undergraduate credit may not be earned both for this course and for CS 543.

Recommended background: CS 2223, CS 2303 and MA 2071.

#### CS 4732. COMPUTER ANIMATION.

##### *Cat. II*

This course provides an in-depth examination of the algorithms, data structures, and techniques used in modeling and rendering dynamic scenes. Topics include animation hardware and software, parametric blending techniques, modeling physical and articulated objects, forward and inverse kinematics, key-frame, procedural, and behavioral animation, and free-form deformation.

Students will be expected to develop programs to implement low-level animation algorithms as well as use commercial animation tools to design and produce small to moderate sized animations.

Intended audience: computer science majors.

Recommended background: CS 4731.

This course will be offered in 2008-09 and in alternating years thereafter.

## ELECTRICAL AND COMPUTER ENGINEERING

The second digit in electrical engineering course numbers is coded as follows:

- 0 — Circuits
- 1 — Fields
- 2 — Electronic Circuits and Systems
- 3 — Signals and Communication Systems
- 4 — Available for Future Use
- 5 — Machines, Power Systems
- 6 — Professional and Miscellaneous
- 7 — Projects, Laboratory, Independent Study
- 8 — Computers
- 9 — Electronic Devices

NOTE: Courses listed in previous catalogs with "EE" as the prefix and the same course number as below are considered to be the SAME COURSE.

#### ECE 2011. INTRODUCTION TO ELECTRICAL AND COMPUTER ENGINEERING.

##### *Cat. I*

The objective of this course is to expose new electrical engineering students (including first year students) to the broad field of electrical engineering, introducing basic concepts of circuits and systems and their applications. Experiments based on practical devices are used to reinforce basic concepts and develop laboratory skills, as well as to provide system-level understanding. The use of circuit simulation tools for analysis and design is introduced.

Topics: Basic concepts of electrical circuits, linear circuit analysis, op-amp circuits, simple transients, phasor analysis, amplifiers, frequency response, filters.

Recommended background: high school physics, and MA 1022 (concurrent).

#### ECE 2022. INTRODUCTION TO DIGITAL CIRCUITS AND COMPUTER ENGINEERING.

##### *Cat. I*

The objective of this course is to expose students (including first year students) to basic electrical and mathematical concepts that underlie computer engineering while continuing an introduction to basic concepts of circuits and systems in a hands-on environment. Experiments representing practical devices introduce basic electrical engineering concepts and skills which typify the study and practice of electrical and computer engineering. In the laboratory, the students construct, troubleshoot, and test analog and digital circuits that they have designed. They will also be introduced to the nature of the interface between hardware and software in a typical microprocessor based computer.

Topics: Sets, functions, Boolean algebra, digital switching logic, the transistor as switch, circuit design of logic gates, design of combinational logic circuits,

software and hardware interfacing including analog/digital and digital/analog conversion.

Recommended background: ECE 2011 and MA 1022.

#### **ECE 2111. PHYSICAL PRINCIPLES OF ECE APPLICATIONS.**

*Cat. I*

In this course students will learn the practical aspects of electromagnetics and their relation to basic DC and AC circuit theory.

The meaning of the electric and magnetic field concepts is explained and placed in context with capacitive and inductive circuits. Exploiting those concepts leads to a host of practical devices such as transformers, motors, and generators. In addition, measures to minimize the influence of stray electric and magnetic fields are analyzed as part of various shielding and grounding strategies.

The electric and magnetic circuit aspects are then presented as linear first order systems in the time and frequency domains. Issues such as time constants, impedance, and superposition are explained in detail. Building upon these basic concepts, second order systems consisting of mixed capacitive and inductive systems are analyzed in terms of their resonance effects. The second order system description will then be applied to develop the basic transmission line theory as required in high-speed digital design.

Recommended background: ECE 2011, introductory physics courses such as PH 1120 or PH 1121, MA 1024, MA 2051 (concurrent).

#### **ECE 2112. ELECTROMAGNETIC FIELDS.**

*Cat. I*

The object of this course is a comprehensive treatment of electromagnetic engineering principles covering the entire application spectrum from static to dynamic field phenomena.

The starting point will be the basic electric and magnetic field definitions of Coulomb and Biot-Savart leading to Gauss's and Ampere's laws. They form the foundation of electro- and magnetostatics fields. Students will examine capacitive and inductive systems and relate them to lumped element circuit models. By introducing temporal and spatial magnetic flux variations, Faraday's law is established. The engineering implications of this law are investigated in terms of transformer and motor actions. Incorporation of the displacement current density into Ampere's law and combining it with Faraday's law will then culminate in the complete set of Maxwell's field equations. As a result of these equations, students will develop the concept of wave propagation in the time and frequency domain with practical applications such as wireless communication, radar, Global Positioning Systems, and microwave circuits.

Recommended background: ECE 2111.

#### **ECE 2201. MICROELECTRONIC CIRCUITS I.**

*Cat. I*

This course is the first of a two-course sequence in electronic circuit design. It begins with a substantive treatment of the fundamental behavior of semiconductor materials and moves on to the semiconductor diode, the bipolar transistor, and the field-effect transistor. Laboratory exercises are provided to reinforce the theory of operation of these devices. Numerous circuit applications are considered, including: power supplies, transistor amplifiers, and FET switches.

Topics include: the pn junction, diode operation, transducers, rectification, voltage regulation, limiting and clamping circuits, transistor operation, biasing, small-signal and large-signal models, transistors amplifiers, and switching applications.

Recommended background: ECE2011.

#### **ECE/BME 2204. BIOELECTRIC FOUNDATIONS.**

*Cat. I*

An introduction to the origins and characteristics of the electric and electromagnetic signals that arise in biological tissues. Topics include the behavior of excitable cells and tissues, the intrinsic electrical and magnetic properties of biological tissues, and the response of excitable cells to electric and magnetic field stimulation. Laboratory projects include the measurement of bioelectric signals (EMG, EKG, EEG, EOG, and evoked response) and the fundamentals of data acquisition, analysis, and statistics. The principles of writing and maintaining a laboratory notebook are also developed and used.

Recommended background: BB 2550 or equivalent, PH 1120 or PH 1121.

Students who have received credit for BME 4101 may not receive credit for BME 2204.

#### **ECE 2311. CONTINUOUS-TIME SIGNAL AND SYSTEM ANALYSIS.**

*Cat. I*

This course provides an introduction to time and frequency domain analysis of continuous time signals and linear systems. Topics include signal characterization and operations; singularity functions; impulse response and convolution; Fourier series; the Fourier transform and its applications; frequency-domain characterization of linear, time-invariant systems such as filters; and the Laplace transform and its applications.

Recommended background: ECE 2011, MA 1022.

Suggested background: MA 2051.

#### **ECE 2312. DISCRETE-TIME SIGNAL AND SYSTEM ANALYSIS.**

*Cat. I*

This course provides an introduction to the time and frequency domain analysis of discrete-time signals and linear systems. Topics include sampling and quantization, characterization of discrete-time sequences, the discrete-time Fourier transform, the discrete Fourier transform and its applications, the Z transform and its applications, linear and circular convolution, characterization of FIR and IIR discrete-time systems, and the analysis and design of discrete-time filters. Projects include topics such as sampling and quantization; application of the DFT to signal and system analysis and design; and digital filter design and simulation.

Recommended background: ECE 2311.

#### **ECE 2799. ELECTRICAL AND COMPUTER ENGINEERING DESIGN.**

*Cat. I*

The goal of this course is to provide experience with the design of a system, component, or process. Basic sciences, mathematics, and engineering sciences are applied to convert resources to meet a stated objective. Fundamental steps of the design process are practiced, including the establishment of objectives and criteria, synthesis, analysis, manufacturability, testing, and evaluation. Student work in small teams and are encouraged to use creativity to solve specific but open-ended problems, and then present their results.

ECE 2799 is strongly recommended for all students as a preparation for the design element of the MQP. It is anticipated that ECE 2799 will be of most benefit to students when taken well in advance of the MQP (late sophomore year or early junior year).

Recommended background: ECE 2022, ECE 2111, and ECE 2311; and either ECE 2201 or ECE 2801.

#### **ECE 2801. FOUNDATIONS OF EMBEDDED COMPUTER SYSTEMS.**

*Cat. I*

This course introduces the C and assembly language programming concepts that are needed to develop microprocessor and microcontroller-based computer systems. Beginning with the fundamentals of computer architecture and organization, students learn assembly language and how C and assembly language programs running on microprocessors are used to solve problems that require interactions between a computer and the physical world. Students in this course will also learn about the hardware and software structure of a modern computer system and how hardware, software, and the passage of time must be managed in an embedded system design. Other issues that will be addressed as appropriate include overall embedded system development, software maintenance, programming for reliability, and product safety.

Topics: Number systems, software flow diagrams, models for system state and state transitions, microprocessor and microcontroller architecture, mixed C and assembly language programming, program development and test tools, operating system interfaces, hardware/software dependencies, and time and resource management.

Lab exercises: Introductory C and assembly language exercises and more advanced problems which explore topics such as logic flow, real time programming, maintainability and software maintenance cycles. Exercises will be performed on microcontroller and/or microprocessor based embedded systems using cross platform development tools appropriate to the target platform.

Recommended background: ECE 2022 (for ECE students) or CS 2011, and C language programming (CS 2301 or similar).

#### **ECE/BME 3011. BIOINSTRUMENTATION AND BIOSENSORS.**

*Cat. I*

A study of the basic principles of biomedical electronics and measurement with emphasis on the operational performance and selection of transducers, instruments and systems for biomedical data acquisition and processing. Biopotential electrodes. Analysis and selection of physical, optical, electrical, mechanical, thermal transduction mechanisms which form the basis of the sensor design. Clinical laboratory instrumentation. Electrical safety problems in the clinical environment.

Recommended background: MA 2051, ECE 3601, or equivalent.

#### **ECE 3113. INTRODUCTION TO RF CIRCUIT DESIGN.**

*Cat. I*

This course is designed to provide students with the basic principles of radio frequency (RF) circuit design. It concentrates on topics such as designing tuning and matching networks for analog and digital communication, satellite navigation, and radar systems.

After reviewing equivalent circuit representations for RF diodes, transistors, FETs, and their input/output impedance behavior, the course examines the difference between lumped and distributed parameter systems. Characteristics impedance, standing waves, reflection coefficients, insertion loss, and group delay of RF circuits will be explained.



Within the context of Maxwell's theory the course will then focus on the graphical display of the reflection coefficient (Smith Chart) and its importance in designing matching circuits. Students will learn the difference between SPICE and monolithic and microwave integrated circuit analysis, and design (MMICAD) modeling. Biasing and matching networks for single and multistage amplifiers in the 900 to 2,000 MHz range are analyzed and optimized in terms of input/output impedance matching, insertion loss, and groups delays.

Recommended background: ECE 2111, ECE 3204.

Suggested background: ECE 2112.

#### **ECE 3204. MICROELECTRONIC CIRCUITS II.**

*Cat. I*

This course is the second of a two-course sequence in electronic circuit design. More complex circuits are analyzed and the effects of frequency and feedback are considered in detail. The course provides a comprehensive treatment of operational amplifier operation and limitations. The use of Bode plots to describe the amplitude and phase performance of circuits as a function of operating frequency is also presented. In addition, the concepts of analog signal sampling, analog-to-digital conversion and digital-to-analog conversion are presented along with techniques for interfacing analog and digital circuitry. Laboratory exercises are provided to reinforce student facility with the application of these concepts to the design of practical circuits.

Topics include: transducers; differential amplifiers, inverting/non-inverting amplifiers, summers, differentiators, integrators, passive and active filters, the Schmitt trigger, monostable and a-stable oscillators, timers, sample-and-hold circuits, A/D converters, and D/A converters.

Recommended background: Introductory electronic-circuit design and analog-signal analysis as found in ECE 2201 and ECE 2311.

#### **ECE 3305. AEROSPACE AVIONICS SYSTEMS.**

*Cat. I*

This course is intended for students interested in obtaining a systems-level perspective of modern aerospace communications, navigation, and radar systems. The fundamental theory of operation of these systems is presented along with current-day applications of them.

Topics: The functional operating principles and techniques of communications, navigation (including GPS) and radar systems; performance expectations for antenna, transmitter, receiver, and transmission-line components; error sources and their effect in combination on both individual component and aggregated system performance; earth-shape approximations and their influence on system design and operation; tropospheric and ionospheric effects of radio-wave propagation; and achievable overall system accuracies.

Recommended background: MA 1022 and PH 1120 or equivalent. With extra work, this course can be successfully completed by non-ECE students. The basic concepts of electromagnetic-wave propagation and antennas will be introduced as needed.

Suggested background: ECE 2312

#### **ECE 3308. INTRODUCTION TO WIRELESS NETWORKS.**

*Cat. I*

This course is intended for students interested in obtaining a systems-level perspective of modern wireless networks. It starts with an overall understanding of telecommunication and computer communication networks. Then the fundamental theory of operation of wireless networks as well detailed description of example networks will be covered. Topics included in the course are an overview of computer networks, an overview of wireless network standards and products, radio channel modeling and medium access control, deployment of wireless infrastructures, and examples of voice- and data-oriented wireless networks using TDMA, CDMA, and CSMA access methods. Recommended background: MA 1022 and PH 1120; suggested background: ECE 2312. With extra work, this course can be successfully completed by non-ECE students; basic concepts of radio propagation, transmission, and medium access control will be introduced as needed.

#### **ECE 3311. PRINCIPLES OF COMMUNICATION SYSTEMS.**

*Cat. I*

This course provides an introduction to analog and digital communications systems. The bandpass transmission of analog data is motivated and typical systems are analyzed with respect to bandwidth considerations and implementation techniques. Baseband and passband digital transmission systems are introduced and investigated. Pulse shaping and intersymbol interference criteria are developed in relation to the pulse rate transmission limits of bandlimited channels. Finally, digital carrier systems and line coding are introduced in conjunction with applications to modern modem transmission schemes.

Recommended background: MA 1024, ECE 2311 and ECE 2312.

#### **ECE 3501. ELECTRICAL ENERGY CONVERSION.**

*Cat. I*

This course is designed to provide a cohesive presentation of the principles of electric energy conversion for industrial applications and design. The generation, transmission and conversion of electric energy, as well as basic instrumentation and equipment associated with electric energy flow and conversion are analyzed.

Topics: Review of poly-phase circuits. Transducers and instrumentation for power and energy measurements. Rotating machines. Electromechanical transients and stability. Switchgear equipment. Selected laboratory experiments.

Recommended background: ECE 2111.

#### **ECE 3503. POWER ELECTRONICS.**

*Cat. I*

This course is an introduction to analysis and design of power semiconductor circuits used in electric motor drives, control systems, robotics and power supply.

Topics: characteristics of thyristors and power transistors. Steady-state performance and operating characteristics, device rating and protection, commutation, gating circuits, ac voltage controllers, controlled rectifiers, dc/dc converters and dc/ac inverters. Laboratory exercises.

Recommended background: ECE 2201, ECE 2311 or equivalent.

#### **ECE 3601. PRINCIPLES OF ELECTRICAL ENGINEERING.**

*Cat. I*

Intended for students other than electrical engineers, this course is oriented towards developing competence in electrical engineering concepts on the level that the technology interfaces directly with their own discipline. The course is designed specifically to help students meet that challenge through the development of a broad systems perspective and an understanding of the principal elements of electrical engineering technology. The expectation is that students completing the course will be able to handle adequately the electrical aspects of a broad range of application topics. In addition, and most important, they will be prepared to work effectively with electrical engineers on the joint solution of complex problems.

Topics covered during the course include: direct current (DC) circuit analysis and design, alternating current (AC) circuit analysis and design, circuit design using operational amplifiers, and electric machines and power systems. Selected laboratory projects are included to emphasize the direct application of the information presented in lectures.

Recommended background: MA 1021-1023, MA 2051, PH 1120/1121 or equivalent.

#### **ECE 3801. ADVANCED LOGIC DESIGN.**

*Cat. I*

This course introduces students to the design of the complex logic systems underlying or supporting the operation of computer systems and interfaces. Students learn how to use advanced computer-aided design tools to develop and simulate logic systems consisting of MSI components such as adders, multiplexers, latches, and counters. The concept of synchronous logic is introduced through the design and implementation of Mealy and Moore machines. Hardware description languages are introduced and used to describe and implement combinational circuits. Students will also learn how to use programmable logic devices to implement customized designs.

Topics: Review of logic gates and design and simplification of combinational circuits. Arithmetic circuits, MSI devices, analysis and design of sequential circuits, synchronous state machines and programmable logic. Introduction to hardware description languages.

Lab exercises: Design, analysis and construction of combinational and sequential circuits, use of computer-aided engineering software for schematic entry and digital analysis, introduction to hardware description languages and programmable logic devices.

Recommended background: ECE 2022 (for ECE students) or CS 2011.

Suggested background: MA 2201/CS 2022.

#### **ECE 3803. MICROPROCESSOR SYSTEM DESIGN.**

*Cat. I*

This course builds on the computer system material presented in ECE 2801. It covers the architecture, organization and instruction set of microprocessors. The interface to memory (RAM and EPROM) and I/O peripherals is described with reference to bus cycles, bus timing, and address decoding. Emphasis is placed on the design, programming and implementation of interfaces to microprocessor systems using a mixture of C and assembly language.

Topics: bus timing analysis, memory devices and systems, IO and control signaling, bi-directional bus interfaces, instruction execution cycles, interrupts and polling, addressing, programmable peripheral devices, interface design issues including analog/digital and digital/analog conversion. Mixed language (C and Assembler) programming.



Laboratory exercises: Use of standard buses for advanced IO design and programming, mixed language programming, standard bus timing, and interface design and implementation. Development of a complete standalone embedded computer system.

Recommended background: ECE 2801 and ECE 3801 or an equivalent background in advanced logic design, and microprocessor architecture. CS 2301 or CS 2303 or an equivalent background in C programming.

#### **ECE 3810. ADVANCED DIGITAL SYSTEM DESIGN.**

##### *Cat. I*

This is an introductory course addressing the systematic design of advanced digital logic systems. The emphasis is on top-down design starting with high level models using VHDL as a tool for the design, synthesis, modeling, and testing of VLSI devices. The emphasis will be on understanding functional design, layout, floor planning, designing for speed and power objectives, and testing. Finally, the integration of tools and design methodologies will be addressed through a discussion of system on a chip (SOC) integration, methodologies for performance, design for test/testing.

Topics: 1. hardware description languages, VHDL, system modeling, synthesis, simulation and testing of digital circuits; 2. VLSI design tools, transistor level design and behavior, layout, routing, clocking and testing. 3. design integration to achieve specific SOC goals including architecture, planning and integration, and testing.

Laboratory exercises: VHDL models of combinational and sequential circuits, synthesizing these models to programmable logic devices, simulating the design, test-benches, transistor level IC design, IC design methodologies, circuit extraction and modeling, and high level SOC design methodologies.

Recommended background: ECE 3801 and experience with programming in a high-level language such as C or Pascal. Suggested background: ECE 3803.

Students may not receive credit for ECE 3810 if they have received credit for either ECE 3815 or ECE 3902.

#### **ECE/BME 4011. BIOMEDICAL SIGNAL ANALYSIS.**

##### *Cat. II*

Introduction to biomedical signal processing and analysis. Fundamental techniques to analyze and process signals that originate from biological sources: ECGs, EMGs, EEGs, blood pressure signals, etc. Course integrates physiological knowledge with the information useful for physiologic investigation and medical diagnosis and processing. Biomedical signal characterization, time domain analysis techniques (transfer functions, convolution, auto- and cross-correlation), frequency domain (Fourier analysis), continuous and discrete signals, deterministic and stochastic signal analysis methods. Analog and digital filtering.

Recommended background: ECE 2311, ECE 2312, BME 3011, or equivalent.

This course will be offered in 2008-09, and in alternating years thereafter.

#### **ECE/BME 4023. BIOMEDICAL INSTRUMENTATION DESIGN I.**

##### *Cat. II*

This course builds on the fundamental knowledge of bioinstrumentation and biosensors presented in BME 3011. Lectures and hands-on laboratory experiments cover the principles of designing, building and testing analog instruments to measure biological events. Design laboratories will include biopotential amplifiers and biosensor/bioinstrumentation systems for the measurement of physiological parameters.

Recommended background: BME 2204, and BME 3011.

This course will be offered in the 2008-09 academic year and in alternating years thereafter.

#### **ECE/BME 4201. BIOMEDICAL IMAGING.**

##### *Cat. II*

This course is a practical introduction to biomedical image processing using examples from various branches of medical imaging. Topics include: point operations, filtering in the image and Fourier domains, image reconstruction in computed tomography and magnetic resonance imaging, and data analysis using image segmentation. Review of linear-systems theory and the relevant principles of physics. Course work uses examples from microscopy, computed tomography, X-ray radiography, and magnetic resonance imaging. A working knowledge of undergraduate signal analysis and linear algebra is desirable. Facility with a high-level programming language is recommended.

This course will be offered in 2008-09, and in alternating years thereafter.

#### **ECE 4304. DIGITAL COMMUNICATION SYSTEMS.**

##### *Cat. I*

This course introduces the principles of digital communication systems including digital modulation, demodulation, and optimal receiver design. The mathematical treatment of noise as a random process is developed in the context of baseband and passband transmission systems. Analytical and simulation-based techniques are developed for evaluating the performance of digital communication systems with noisy channels. Tradeoffs between modulation formats, including bandwidth-efficiency and energy-efficiency, are exposed. Practical receiver design issues including synchronization and timing recovery are also discussed.

Recommended background: ECE 3311, familiarity with Matlab, and familiarity with basic probability.

#### **ECE 4703. REAL-TIME DIGITAL SIGNAL PROCESSING.**

##### *Cat. I*

This course provides an introduction to the principles of real-time digital signal processing (DSP). The focus of this course is hands-on development of real-time signal processing algorithms using audio-based DSP kits in a laboratory environment. Basic concepts of DSP systems including sampling and quantization of continuous time signals are discussed. Tradeoffs between fixed-point and floating-point processing are exposed. Real-time considerations are discussed and efficient programming techniques leveraging the pipelined and parallel processing architecture of modern DSPs are developed. Using the audio-based DSP kits, students will implement real-time algorithms for various filtering structures and compare experimental results to theoretical predictions.

Recommended background: ECE 2312, ECE 2801, some prior experience in C programming.

#### **ECE 4801. ADVANCED COMPUTER SYSTEM DESIGN.**

##### *Cat. I*

This course continues the development of advanced computer systems and focuses on the architectural design of standalone embedded and high-performance microprocessor systems.

Topics: advanced microprocessor architecture, embedded systems, RISC and CISC, interrupts, pipelining, DMA, cache and memory system design, high-performance system issues.

Recommended background: ECE 3803 or equivalent.

#### **ECE 4902. ANALOG INTEGRATED CIRCUIT DESIGN.**

##### *Cat. I*

This course introduces students to the design and analysis of analog integrated circuits such as operational amplifiers, phase-locked loops, and analog multipliers.

Topics: integrated circuit building blocks: current mirrors and sources, differential amplifiers, voltage references and multipliers, output circuits. Computer-aided simulation of circuits. Layout of integrated circuits. Design and analysis of such circuits as operational amplifiers, phase-locked loops, FM detectors, and analog multipliers. Laboratory exercises.

Recommended background: familiarity with the analysis of linear circuits and with the theory of bipolar and MOSFET transistors. Such skills are typically acquired in ECE 3204.

Suggested background: ECE 4904.

#### **ECE 4904. SEMICONDUCTOR DEVICES.**

##### *Cat. II*

The purpose of this course is to introduce students to the physics of semiconductor devices and to show how semiconductor devices operate in typical linear and nonlinear circuit applications. This material complements the electronics sequence of courses and will draw illustrative examples of electronic circuit applications from other courses. Topics: carrier transport processes in semiconductor materials. Carrier lifetime. Theory of p-n junctions. Bipolar transistors internal theory, dc characteristics, charge control, Ebers-Moll relations; high frequency and switching characteristics, hybrid- $\pi$  model; n- and p-channel MOSFETS, CMOS.

Recommended background: ECE 2201. Suggested background: ECE 3204 (helpful but not necessary).

Students may not receive credit for ECE 4904 if they have received credit for ECE 3901.

This course will be offered in 2008-09, and in alternating years thereafter.

## ENGINEERING SCIENCE INTERDISCIPLINARY

### ES 1020. INTRODUCTION TO ENGINEERING.

#### *Cat. I*

This course is for first year students with an interest in engineering. The course focuses on the design process. Students are introduced to engineering through case studies and reverse engineering activities. Students will learn the steps in the design process and how engineers use this process to create new devices. Teams of students are then assigned a design project that culminates in building and evaluating a prototype in their design. Results of the design project are presented in both oral and written reports. This course does not require any prior engineering background.

Note: This course can be used towards the Engineering Science and Design distribution requirement in IE, ME, and MFE.

### ES 1310. INTRODUCTION TO COMPUTER AIDED DESIGN.

#### *Cat. I*

This basic course in engineering graphical communications provides a background for all engineering disciplines. The ability to create and interpret standard, well-integrated detail and assembly drawings is a necessity for engineers to communicate ideas. Computer Aided Design software will be used as a tool for creating these engineering design drawings. Multiview and pictorial graphics techniques are integrated with standards for dimensioning, sectioning, and generating detailed engineering drawings. Emphasis is placed on relating drawings to the required manufacturing processes. The design process and aids to creativity are combined with graphics procedures to incorporate functional design requirements in the geometric model.

No prior engineering graphics or software knowledge is assumed.

### ES 2001. INTRODUCTION TO MATERIAL SCIENCE.

#### *Cat. I*

A beginning course in understanding the structures and properties of metals, ceramics and plastics, in the selection and in the working and heat treating of materials. A course of interest to any engineer, scientist or person involved with materials.

The underlying fundamental theme of materials science is structure-property relationship. Structures covered range from the subatomic, or nuclear level, through the microscopic world to the macroscopic, or gross point of view. Properties investigated may be chemical, mechanical, thermal, nuclear, electrical or optical. The selection, working and thermal treatments of materials are also related to structural changes and thus property alterations.

No formal laboratory, but ample opportunity exists for the student to experiment with the fundamentals presented on a voluntary basis.

Recommended background: prior knowledge of college-level chemistry.

### ES 2501. INTRODUCTION TO STATIC SYSTEMS.

#### *Cat. I*

This is an introductory course in the engineering mechanics sequence that serves as a foundation for other courses in mechanical engineering. In this course, students will learn to solve for forces and couples in systems that are not accelerating and which are statically determinate. They will also learn to draw shear and bending moment diagrams for beams and how to calculate the centroid and the moment of inertia for areas.

This course qualifies as one of the three courses that mechanical engineering students must complete in the mechanical systems stem.

Topics normally covered include: forces, moments of forces and couples; free body diagrams; equilibrium; friction; distributed loadings; pin trusses; beams and beam loading; suspended cables; first and second moment of area. Force analysis of submerged bodies is addressed in this course.

Recommended background: Differential and Integral Calculus (MA 1022) and elementary vector algebra.

### ES 2502. STRESS ANALYSIS.

#### *Cat. I*

The first course in engineering mechanics that addresses stress analysis of mechanical and structural elements.

Topics covered include: stresses, strains and deformations in bars, beams, and torsional elements; principal stresses, transverse shear stresses, buckling.

Recommended background: Statics (ES 2501) and elementary vector algebra.

### ES 2503. INTRODUCTION TO DYNAMIC SYSTEMS.

#### *Cat. I*

Engineers should be able to formulate and solve problems that involve forces that act on bodies which are moving. This course deals with the kinematics and dynamics of particles and rigid bodies which move in a plane.

Topics covered will include: kinematics of particles and rigid bodies, equations of motion, work-energy methods, and impulse and momentum. In this course a basic introduction to mechanical vibration is also discussed. Basic equations will be developed with respect to translating and rotating coordinate systems.

Recommended background: Statics (ES 2501 or CE 2000).

### ES 3001. INTRODUCTION TO THERMODYNAMICS.

#### *Cat. I*

This course emphasizes system and control volume modeling using the First and Second Laws of Thermodynamics.

Topics include: properties of simple substances, an introduction to availability, cycle analysis.

### ES 3002. MASS TRANSFER.

#### *Cat. I*

This course introduces the student to the phenomena of diffusion and mass transfer. These occur in processes during which a change in chemical composition of one or more phases occurs. Diffusion and mass transfer can take place in living systems, in the environment, and in chemical processes. This course will show how to handle quantitative calculations involving diffusion and/or mass transfer, including design of process equipment.

Topics may include: fundamentals of diffusional transport, diffusion in thin films; unsteady diffusion; diffusion in solids; convective mass transfer; dispersion; transport in membranes; diffusion with chemical reaction; simultaneous heat and mass transfer; selected mass transfer operations such as absorption, drying, humidification, extraction, crystallization, adsorption, etc.

Recommended background: fundamentals of chemical thermodynamics, fluid flow and heat transfer; ordinary differential equations (MA 2051 or equivalent).

### ES 3003. HEAT TRANSFER.

#### *Cat. I*

To provide an understanding of fundamental concepts of heat fluxes, to develop understanding of the coupling of fluid mechanics and thermodynamics, and to provide experience in modeling engineering systems and predicting their behavior.

Topics covered include: steady-state and transient conduction exemplified by heat transfer to and from buried pipes, heat losses through furnace walls, response of thermocouple devices, and the effect of adding fins to increase heat transfer rates. Contact resistance. Natural and forced convection. Heat exchanger analysis and design. Convection accompanied by boiling and condensation. Blackbody radiation. Thermal radiation within an enclosure including diffuse and gray surfaces. Radiation accompanied by conduction and with motion.

Recommended background: Ordinary Differential Equations (MA 2051).

### ES 3004. FLUID MECHANICS.

#### *Cat. I*

A study of the fundamental laws of statics, kinematics and dynamics applied to fluid mechanics. The course will include fluid properties, conservation of mass, momentum and energy as applied to real and ideal fluids. Laminar and turbulent flows, fluid resistance and basic boundary layer theory will also be considered.

Recommended background: basic physics, basic differential equations and vectors; third year students.

### ES 3011. CONTROL ENGINEERING I.

#### *Cat. I*

Characteristics of control systems. Mathematical representation of control components and systems. Laplace transforms, transfer functions, block and signal flow diagrams. Transient response analysis. Introduction to the root-locus method and stability analysis. Frequency response techniques including Bode, polar, and Nichols plots.

This sequence of courses in the field of control engineering (ES 3011) is generally available to all juniors and seniors regardless of department. A good background in mathematics is required; familiarity with Laplace transforms, complex variables and matrices is desirable but not mandatory. All students taking Control Engineering I should have an understanding of ordinary differential equations (MA 2051 or equivalent) and basic physics through electricity and magnetism (PH 1120/1121). Control Engineering I may be considered a terminal course, or it may be the first course for those students wishing to do extensive work in this field. Students taking the sequence of two courses will be prepared for graduate work in the field.

Recommended background: Ordinary Differential Equations (MA 2051) and Electricity and Magnetism (PH 1120, PH 1121).

**ES 3323. ADVANCED COMPUTER AIDED DESIGN.***Cat. I*

This course exposes the student to computer aided engineering design and geometric modeling using Unix based graphic workstations. The use of geometric models for applications in computer aided mechanical design, engineering analysis and manufacturing is emphasized. Topics may include mechanical design, solid and feature based modeling, variational and parametric design, physical properties, assembly modeling, numerical control, mechanisms, and other analytical methods in engineering design.

Recommended background: familiarity with drafting standards (ES 1310), mechanical systems (ES 2501 or CE 2000, ES 2503) and kinematics (ME 3310) is assumed. Additional background in strength of materials (ES 2502 or CE 2001), machine design (ME 2300, ME 3320), machining and manufacturing methods (ME 1800) and higher level programming capability (CS 1101 or CS 1102) is helpful.

---

## FIRE PROTECTION ENGINEERING

---

**FP 3070. FUNDAMENTALS OF FIRESAFETY ANALYSIS.***Cat. I*

This course introduces students of different technical disciplines to analytical methods and techniques to address problems of fire, explosions, or hazardous incidents. Emphasis will be placed on understanding the physical concepts of the problem and their interactions. Quantification will adapt existing procedures to appropriate levels of theoretical and empirical methods in the field of fire science and engineering. Computer applications will be incorporated.

Recommended background: mathematics through differential equations; engineering science; fluid mechanics.

---

## Graduate Fire Protection Engineering Courses of Interest to Undergraduates

---

**FPE 520. FIRE MODELING.**

(Prerequisite: FPE 521 or special permission of the instructor.) Advanced topics in fire dynamics, combustion and compartment fire behavior will be discussed within a framework of modeling fire and its effects. Topics include computer modeling of pre-flashover and post-flashover compartment fires, burning characteristics of polymers and other fuels, the effect of fire retardants, products of combustion generation, flame spread models, plume and ceiling jet models and overall toxicity assessment. Some familiarity with computer programming is recommended.

**FPE 521. FIRE DYNAMICS I.**

(Prerequisites: Undergraduate chemistry, thermodynamics [or physical chemistry], fluid mechanics and heat transfer.) This course introduces students to fundamentals of fire and combustion and is intended to serve as the first exposure to fire dynamics phenomena. The course includes fundamental topics in fire and combustion such as thermodynamics of combustion, fire chemistry, premixed and diffusion flames, solid and liquid burning, ignition, plumes and ceiling jets. These topics are then used to develop the basic for introducing compartment fire behavior, pre and post-flashover conditions and smoke movement.

**FPE 553. FIRE PROTECTION SYSTEMS.**

(Prerequisites: Undergraduate courses in chemistry, fluid mechanics and either thermodynamics or physical chemistry.) This course provides an introduction to automatically activated fire suppression and detection systems. A general overview is presented of relevant physical and chemical phenomena and commonly used hardware in automatic sprinkler, gaseous agent, foam and dry chemical systems. Typical contemporary installations and current installation and approval standards are reviewed.

**FPE 554. ADVANCED FIRE SUPPRESSION.**

(Prerequisite: FPE 553 or special permission of instructor.) Advanced topics in suppression systems analysis and design are discussed with an aim toward developing a performance based understanding of suppression technology. Automatic sprinkler systems are covered from the standpoint of predicting actuation times, reviewing numerical methods for hydraulic analyses of pipe flow networks and understanding the phenomenology involved in water spray suppression. Special suppression systems are covered from the standpoint of two phase and non-Newtonian pipe flow and simulations of suppression agent discharge and mixing in an enclosure.

**FPE 555. DETECTION, ALARM AND SMOKE CONTROL.**

(Prerequisites: FPE 553. Also FPE 521 and FPE 571 which can be taken concurrently.)

Principles of fire detection and using flame, heat and smoke detector technology are described. Fire alarm technology and the electrical interface with fire/smoke detectors are reviewed in the context of contemporary equipment and installation standards. Smoke control systems based on buoyancy and HVAC principles are studied in the context of building smoke control for survivability and safe egress.

**FPE 563 (OIE 541). OPERATIONS RISK MANAGEMENT.**

Risk Management is highly interdisciplinary drawing upon systems engineering and managerial decision making and finance. The basics of risk management including hazard analysis, risk assessment, risk control and risk financing are covered. The course is self-contained and includes material from engineering economy, risk assessment and decision analysis. Group projects can draw from fire protection engineering, hazardous waste management and product liability. The projects serve to emphasize important techniques for quantifying risk and the challenge of integrating risk assessment with managerial decision making.

**FPE 565. FIRESAFETY ENGINEERING EVALUATION.**

(Prerequisites: FPE 521, FPE 553 and FPE 570.) This course develops techniques to evaluate the firesafety performance of a variety of facilities of the built environment and to produce management plans for decision making. The framework for this course is a firesafety engineering method which decomposes the firesafety system into discrete elements that can be used for quantitative evaluation using a variety of fire protection engineering and fire science materials.

**FPE 570. BUILDING FIRESAFETY I.**

This course focuses on the presentation of qualitative and quantitative means for firesafety analysis in buildings. Fire test methods, fire and building codes and standards of practice are reviewed in the context of a systematic review of firesafety in proposed and existing structures.

**FPE 571. PERFORMANCE-BASED DESIGN.**

(Prerequisites: FPE 553, FPE 521 and FPE 570 or special permission of instructor.) This course covers practical applications of fire protection engineering principles to the design of buildings. Both compartmented and non-compartmented buildings will be designed for criteria of life safety, property protection, continuity of operations, operational management and cost. Modern analytical tools as well as traditional codes and standards are utilized. Interaction with architects, code officials and an awareness of other factors in the building design process are incorporated through exercises and a design studio.

**FPE 572. FAILURE ANALYSIS.**

(Prerequisites: FPE 570, FPE 521 and FPE 553 or special permission of the instructor.) Development of fire investigation and reconstruction as a basis for evaluating, and improving firesafety design. Accident investigation theory and failure analysis techniques such as fault trees and event sequences are presented. Fire dynamics and computer modeling are applied to assess possible fire scenarios and the effectiveness of fire protection measures. The products liability aspects of failure analysis are presented. Topics include products liability law, use of standard test methods, warnings and safe product design. Application of course materials is developed through projects involving actual case studies.

**FPE 573. INDUSTRIAL FIRE PROTECTION.**

(Prerequisites: FPE 553, FPE 521 or special permission of instructor.) Principles of fire dynamics, heat transfer and thermodynamics are combined with a general knowledge of automatic detection and suppression systems to analyze fire protection requirements for generic industrial hazards. Topics covered include safe separation distances, plant layout, hazard isolation, smoke control, warehouse storage and flammable liquid processing and storage. Historical industrial fires influencing current practice on these topics are also discussed.

**FPE 574 (CHE 594). PROCESS SAFETY MANAGEMENT.**

(Prerequisite: An undergraduate engineering or physical science background.) This course provides basic skills in state-of-the-art process safety management and hazard analysis techniques including Hazard and Operability Studies (HAZOP), Logic Trees, Failure Modes and Effects Analysis (FMEA) and Consequence Analysis. Both qualitative and quantitative evaluation methods will be utilized. Following a case study format, these techniques along with current regulatory requirements will be applied through class projects addressing environmental health, industrial hygiene, hazardous materials, fire or explosion hazard scenarios.

**FPE 575. EXPLOSION PROTECTION.**

Principles of combustion explosions are taught along with explosion hazard and protection applications. Topics include a review of flammability limit concentrations for flammable gases and dusts; thermochemical equilibrium calculations of adiabatic closed vessel deflagration pressures and detonation pressures and velocities; pressures development as a function of time for closed vessels and vented enclosures; the current status of explosion suppression technology; and vapor cloud explosion hazards.

**FPE 580. SPECIAL PROBLEMS.**

Individual or group studies on any topic relating to fire protection may be selected by the student and approved by the faculty member who supervises the work.

**FPE 581. SEMINAR.**

Reports on current advances in the various branches of fire protection.

**FPE 587. FIRE SCIENCE LABORATORY.**

(Prerequisite: FPE 521.) This course provides overall instruction and hands-on experience with fire science related experimental measurement techniques. The objective is to expose students to laboratory-scale fire experiments, standard fire tests and state-of-the-art measurement techniques. The Lateral Ignition and Flame Transport (LIFT) apparatus, state-of-the-art smoke detection systems, closed-up flashpoint tests and gas analyzers are among the existing laboratory apparatus. Fire related measurement techniques for temperature, pressure, flow and velocity, gas species and heat fluxes, infrared thermometry, Laser Doppler Velocimetry (LVD) and Laser Induced Fluorescence (LIF) will be reviewed.

**FPE 590. M. S. THESIS.****FPE 690. PH.D. DISSERTATION.**

---

## HUMANITIES AND ARTS

---



---

### ART HISTORY/ARCHITECTURE (AR)

---

**AR 1100. ESSENTIALS OF ART.***Cat. I*

This course provides an introduction to the basic principles of two and three-dimensional visual organization. The course focuses on graphic expression, idea development, and visual literacy. Students will be expected to master basic rendering skills, perspective drawing, concept art, and storyboarding through traditional and/or computer-based tools.

**AR 1101. DIGITAL IMAGING AND COMPUTER ART.***Cat. I*

This course focuses on the methods, procedures and techniques of creating and manipulating images through electronic and digital means. Students will develop an understanding of image alteration. Topics may include color theory, displays, modeling, shading, and visual perception.

Recommended background: AR 1100.

**AR 1111. INTRODUCTION TO ART HISTORY.***Cat. I*

How do we understand a work of art? Through readings and the study of objects at the Worcester Art Museum, the student will survey the major developments in world art and be introduced to various critical perspectives in art history. Students will learn how art historians work with primary materials and formulate arguments. No previous knowledge of art is required. (Formerly HU 1014.)

**AR 2111. MODERN ART.***Cat. I*

The successive phases of modern art, especially painting, are examined in light of the late-19th-century break with the 600-year old tradition of representation.

Topics covered include: non-objective art and abstraction—theory and practice, primitivism in modern art, surrealism and the irrational, the impact of photography on modern painting, cubism and collage, regionalism and abstract expressionism as American art forms, Pop art and popular culture, and the problem of concept versus representation in art. (Formerly AR 2300.)

**AR 2114. MODERN ARCHITECTURE IN THE AMERICAN ERA, 1750-2001 AND BEYOND.***Cat. I*

This course studies, in a non-technical way, America's buildings and places, in the context of world architecture in modern times. The history of American architecture was shaped by the forces that shaped America, from its political emergence in the eighteenth century to the post-9/11 era. These forces include dreams of social and spiritual perfection; a tight and conflicted relation with nature; and the rise and spread of industrial capitalism. The same forces created the Modern Movement in architecture. How are modernism and American architecture interrelated? Illustrated lectures, films, and tours of Worcester architecture explore the question, while training students in the methods of architectural history and criticism.

Students who have taken AR 2113, Topics in 19th- and 20th-Century Architecture, since the 2000-2001 academic year MAY NOT take AR 2114 for credit.

**AR 3000. THE ART OF ANIMATION.***Cat. I*

This course examines the fundamentals of computer generated 2D and 3D modeling and animation as they apply to creating believable characters and environments. Students will learn skeletal animation and traditional polygonal animation, giving weight and personality to characters through movement, environmental lighting, and changing mood and emotion. Students will be expected to master the tools of 3D modeling and skinning, and scripting of behaviors.

Recommended background: AR 1101.

**AR 3112. MODERNISM, MASS CULTURE, AND THE AVANT-GARDE.***Cat. I*

What is the role of art to be in the modern world? Can art be a vehicle for social change, or should art be a self-critical discipline that pursues primarily aesthetic ends? What is the relationship between art and mass culture? Using primary sources, this course focuses on some of the theorists and artistic trends since the mid-nineteenth century that have sought to resolve this dilemma. These include: Ruskin, Morris and the Arts and Crafts Movement; Art For Art's Sake; the German Werkbund and the Bauhaus; American industrial design.

**AR/ID 3150. LIGHT, VISION AND UNDERSTANDING.***Cat. II*

By using material from the sciences and the humanities, this course examines the ways in which ideas of knowledge and of human nature have been fashioned. The specific topics include physical theories about light, biological and psychological theories of visual perception, and artistic theories and practices concerned with representation. The mixing of material from different academic disciplines is deliberate, and meant to counter the notion that human pursuits are "naturally" arranged in the neat packages found in the modern university. The course draws upon the physical and social sciences, and the humanities, to examine how those fields relate to one another, and how they produce knowledge and self-knowledge. Cultural as well as disciplinary factors are assessed in this process.

Light, Vision and Understanding is conducted as a seminar. The diverse collection of reading materials includes a number of primary texts in different fields. In addition, the students keep a journal in which they record the results of numerous individual observations and experiments concerning light and visual perception. The course can fit into several Sufficiency areas as well as serve as a starting point for an IQP. There are no specific requirements for this course, although some knowledge of college-level physics, as well as an acquaintance with the visual arts, is helpful.

This course will be offered in 2008-09 and in alternating years thereafter.



**ENGLISH (EN)****EN 1221. INTRODUCTION TO DRAMA: THEATRE ON THE PAGE AND ON THE STAGE.***Cat. I*

The plays studied will give the student an understanding of the forms of drama, the styles of theatre performance and production, and the emergence of new forms and styles. Types of drama studied could include Greek Tragedy and Comedy, Roman Comedy, Cycles and Pageants of the Middle Ages, Shakespeare, Restoration, Romanticism, Neo-Classicism, French Comedy, Realism, Naturalism, and the eclectic forms in the Twentieth Century. Discussions, research and writing projects, and performance activities will offer the student experience in the theory and practice studied in the course.

**EN 1222. SHAKESPEARE IN THE AGE OF ELIZABETH.***Cat. I*

This course is an introduction to Shakespeare, his theatre, and some important concepts of his world. Students will have the opportunity to sample representative Shakespearean tragedies, comedies, and histories. In addition to class discussions and scene work, students will be able to enhance their readings by analyzing video recordings of the plays.

**EN 1231. AMERICAN LITERATURE: BEGINNINGS THROUGH HAWTHORNE.***Cat. I*

This survey course covers American literature from its beginnings in the colonial period through the works of Nathaniel Hawthorne in the early nineteenth century. Students will read literary works in a variety of genres (narratives, poems, sermons, plays, stories, and novels) that reflect the emerging nation's struggle for cultural self-definition. Topics will include the literature of travel and discovery, the faith of the colonial founders, the quest for a distinctive national literature, and the rise of early American fiction.

**EN 1242. INTRODUCTION TO ENGLISH POETRY.***Cat. I*

This course surveys the poems of our language. From the Anglo-Saxon poems to the popular verse of Tennyson, the songs and the poets are legion: Chaucer, Raleigh, Spenser, Marlowe, Shakespeare, Jonson, Donne, Herrick, Milton, Blake, Wordsworth, Coleridge, Byron, Keats, Tennyson, Browning, and Hopkins. The England that nourished these writers will be viewed through their ballads, lyrics, sonnets, epigrams, and epics. "Not marble nor the gilded monuments of princes shall outlive this powerful rhyme."

**EN 1251. INTRODUCTION TO LITERATURE.***Cat. I*

This course introduces the student to a variety of critical perspectives necessary to an understanding and appreciation of the major forms, or genres, of literary expression (e.g., novel, short story, poetry, drama, and essay). Writing and class discussion will be integral parts of this course.

**EN 1257. INTRODUCTION TO AFRICAN AMERICAN LITERATURE AND CULTURE.***Cat. II*

This course examines the formation and history of the African American literary tradition from slave narratives to contemporary forms in black popular culture. The course will explore some genres of African American writing and their relation to American literature and to black cultural expression.

This course will be offered in 2008-09 and in alternating years thereafter.

**EN/WR 2210. INTRODUCTION TO PROFESSIONAL WRITING.***Cat. I*

This course will serve as a gateway into the Professional Writing major but will also be open—and useful—to any student interested in learning about the standard written genres of professional, workplace communication. Students will analyze the history, purposes, conventions, and social consequences of a variety of professional communication, focusing on digital and print correspondence, reports, and proposals directed to internal and external audiences. Students will learn about the culture of a professional environment and the role of writing in structuring identity and relationships within that context. Classes will be conducted as interactive writing workshops in which students assess and respond to rhetorical scenarios and sample texts from a variety of professional worksites. Students will create portfolios, producing professional writing samples they may use on the job market.

**EN/WR 2211. ELEMENTS OF WRITING.***Cat. I*

This course is designed for students who wish to work intensively on their writing. The course will emphasize the processes of composing and revising, the rhetorical strategies of expository prose, and the interaction between writer and audience. In a workshop setting, students will write a sequence of short papers and complete one longer writing project, learn to read critically and respond helpfully to each other's writing, and make oral presentations from written texts.

**EN/WR 2213. INTRODUCTION TO JOURNALISM.***Cat. I*

The course is for students who may wish to make careers in journalism or communications and for those who wish to understand the history, function, production and contemporary challenges of print journalism. Students will analyze articles from newspapers, magazines and Web sites. They will learn and practice the skills of the journalist: finding the story, researching, interviewing, writing on deadline, copy-editing and proof-reading. Classes will also cover matters such as objectivity, fairness, ethics and libel, as well as wider issues of mass communication such as agenda setting, citizen journalism and the implications of converging media. To give students a more keen sense of audience, work will be read and discussed in class. Students will be urged to write for the college newspaper. Publication beyond the campus will be strongly encouraged.

**EN 2221. AMERICAN DRAMA.***Cat. I*

An investigation into the development of American drama from its beginnings to the present. The history of the emergence of the legitimate theatre in this country will be followed by reading important plays, including the works of O'Neill, Williams, Mamet, Norman, Henley, and others. Discussion of the growth of regional theatres and their importance to the continuation of theatre as a serious and non-profit art form will be included in the course. The student will investigate the importance of theatre practice in the evolution of the dramatic literature of the country.

**EN 2222. THEATRE WORKSHOP.***Cat. I*

A workshop course which offers the student the opportunity to explore theatre through creative involvement with playwriting, design, performance, production, and criticism. Students will work in a laboratory situation functioning as a micro-professional theatre which could develop a production that would be staffed and dramaturged from the group.

**EN 2224. SHAKESPEARE: NOTHING BUT LOVE.***Cat. II*

The course focuses on conflicts between personal desire and societal responsibility in such plays as *As You Like It*, *Antony and Cleopatra*, and *The Winter's Tale*. Through written work and in-class performances, students will examine how Shakespeare both maintains and subverts traditional ideas about marriage and sexual practice. These analyses will take into account contemporary views on gender roles and identity including the early modern cultural "ideal" of the "chaste, silent, and obedient" woman. Students will study Shakespeare's work as literature and also through performance and film adaptations. The WPI library of video recordings will be available for such work.

This course will be offered in 2008-09 and in alternate years thereafter.

**EN 2225. THE LITERATURE OF SIN.***Cat. II*

This course begins with selections from John Milton's provocative version of Adam and Eve's original sin in *Paradise Lost*. Focusing on Milton, John Donne and others, we will examine the theme of sin—political, religious, and sexual—in early modern literature. The events of the English Reformation profoundly influenced these writers, and their personal struggles against societal institutions have greatly influenced subsequent literary expressions of rage and rebellion. Students will also be reading texts by contemporary writers such as David Mamet which address the theme of sin in the modern city.

This course will be offered in 2009-10 and in alternate years thereafter.

**EN 2231. AMERICAN LITERATURE: THE RAVEN, THE WHALE, AND THE WOODCHUCK.***Cat. I*

Emerson challenged the young nation in "The American Scholar" (1837): If our writers were "free and brave," with words "loaded with life," they would usher in a "new age." The incredibly rich literature that soon followed created an "American Renaissance." This was the Age of Reform (1836-65) in more than literature. Writers were caught up in such burning issues as abolitionism, Union vs. secession, and women's rights. Authors studied may include Emerson, Thoreau, Poe, Fuller, Douglass, Melville, Whitman, and Dickinson.

**EN 2232. AMERICAN LITERATURE: TWAIN TO WORLD WAR I.***Cat. I*

This survey course covers developments in American literature, particularly the movement towards Realism, during the period of turbulent change between the end of the Civil War and the early years of the twentieth century. Topics will include the rebellion against post bellum sentimentalism, the rise of regional writing, the emerging literature of social protest, and literary responses to advances in science, industry, and urban life. Attention will be given to the works of Mark Twain, a prime exponent of turn-of-the-century literary trends, as well as to other pioneer realists (Wharton and Crane).

**EN 2233. AMERICAN LITERATURE: MODERNISM TO THE PRESENT.***Cat. I*

This final survey course in American literature covers the modern and contemporary periods, from World War I to the present. The wide-ranging material represents the literary response to the broad intellectual, social, and cultural changes that mark the history of those years of ferment in the United States. The course includes selected works of fiction, drama, poetry, and essays by such writers as William Faulkner, Toni Morrison, Thornton Wilder, Sylvia Plath, Allen Ginsberg, Joy Harjo, and Michael Harper.

**EN 2234. MODERN AMERICAN NOVEL.***Cat. II*

Selected works of fiction which appeared after World War I will be the focus of this course. F. Scott Fitzgerald, Ernest Hemingway, William Faulkner, or other authors of the early modern period will be studied, but significant attention will also be given to contemporary novelists, such as Alice Walker and Kurt Vonnegut. The cultural context and philosophical assumptions of the novels will be studied as well as their form and technique.

This course will be offered in 2009-10 and in alternating years thereafter.

**EN 2235. THE AMERICAN DREAM: MYTH IN LITERATURE AND THE POPULAR IMAGINATION.***Cat. I*

American writers from our beginnings have been preoccupied with "The American Dream" as a benchmark for measuring the attainment of our highest ideals as a people. The course examines the political, economic, religious, and rhetorical roots of the concept, assesses its popular and commercial manifestations, and explores the ironies, paradoxes, and continuities that have shaped this national self-image for almost 400 years. Readings include works by Puritan and Revolutionary writers, Native American leaders, Horatio Alger, Jr., William Dean Howells, F. Scott Fitzgerald, Martin Luther King, Jr., Adrienne Rich, Studs Terkel, and Archibald MacLeish.

**EN 2237. AMERICAN LITERATURE AND THE ENVIRONMENT.***Cat. II*

This course will examine the many ways in which American essayists, novelists, dramatists, and poets have responded to the natural world, and especially to ecological concerns voiced in contemporary times. Among the topics to be discussed in class and in papers are the changing attitudes towards the wilderness, the effects of technology on the environment, and the presence of the spiritual in nature. Readings may include works by such authors as Ernest Hemingway, Wendell Berry, Mary Oliver, Loren Eiseley, and Gary Snyder.

This course will be offered in 2008-09 and in alternating years thereafter.

**EN 2238. AMERICAN REALISM.***Cat. I*

By examining authors who reacted against the so-called "genteel tradition," this course attempts to show how various subjects (death, sex, war, slum life and racial prejudice) were treated more honestly in short stories and novels after the Civil War. Authors may include Mark Twain, Stephen Crane, W. D. Howells, Edith Wharton, Kate Chopin, Theodore Dreiser, and twentieth century realists.

(Formerly EN 3236. Students who have received credit for this course may not receive credit for EN 2238.)

**EN 2241. ENGLISH LITERATURE AFTER SHAKESPEARE.***Cat. II*

Participants in this course will examine outstanding works of eighteenth- and nineteenth-century English literature as these works raise the question: Who is man, and what is his relationship to God, nature, and to his fellow creatures? Writers covered may include Swift, Pope, Keats, Browning, and Dickens.

This course will be offered in 2008-09 and in alternating years thereafter.

**EN 2242. POPULAR FICTION: READING IN INSTALLMENTS.***Cat. I*

Students in this course will have the opportunity to read two major masterpieces of English fiction the way they should be read: slowly, carefully, and with relish. Victorian novels are long and the term is short, but by reading novels in the way in which they were read by their original readers—serially—we can experience masterworks by Charles Dickens and George Eliot at comparative leisure, examining one serial installment per class session.

**EN 2243. MODERN BRITISH LITERATURE.***Cat. II*

A survey of major modern British authors. The works of many of these writers reflect the political, religious, and social issues of the twentieth century. New psychological insights run parallel with experiments in the use of myth, stream of consciousness, and symbolism. Authors studied may include Hardy, Conrad, Owen, Joyce, Lawrence, Woolf, Eliot, Yeats, and Orwell.

This course will be offered in 2009-10 and in alternating years thereafter.

**EN 2251. MORAL ISSUES IN THE MODERN NOVEL.***Cat. I*

This course focuses on the problem of how to live in the modern world. Emphasis will be placed on the way moral issues evolve within the complications of individual lives, as depicted in fiction. Such authors as Conrad, Kesey, Camus and Ellison show characters struggling with the questions of moral responsibility raised by love, religion, death, money, conformity.

**EN 2252. SCIENCE AND SCIENTISTS IN MODERN LITERATURE.***Cat. I*

This course surveys the ways in which modern literature has represented science and scientists. Beginning with Mary Shelley's *Frankenstein*, the origin of what Isaac Asimov calls the "damned Frankenstein complex" is examined. More complex presentations of science and scientists occur in twentieth-century works like Brecht's *Galileo*, Huxley's *Brave New World*, and Pirsig's *Zen and the Art of Motorcycle Maintenance*.

The course covers major modern works of fiction and drama, including such literary forms as the play, the novel of ideas, and the utopian novel. Attention is focused on the themes (ideas) in, and the structure of, these works.

**EN/WR 3011. PEER TUTORING IN WRITING.***Cat. I*

Peer Tutoring in Writing introduced students to the theory and practice of composition. In this course, students research, read, and write about their own and others' literacy practices. Through reading and writing assignments, peer reviews, interviews, presentations, and a tutoring internship in the CCAC, students hone their communication skills while increasing their ability to examine critically the role of communication in the production of knowledge.

**EN/WR 3210. TECHNICAL WRITING.***Cat. I*

Technical writing combines technical knowledge with writing skills to communicate technology to the world. This course introduces the fundamental principles of technical communication, and the tools commonly used in the technical writing profession. Topics include user and task analysis, information design, instructional writing, and usability testing. Students learn to use the technical writing process to create user-centered documents that combine text, graphics, and visual formatting to meet specific information needs. Students create a portfolio of both hardcopy and online documentation, using professional tools such as FrameMaker, Acrobat, and RoboHelp.

Recommended background: EN/WR 2210, or equivalent writing course.

**EN/WR 3214. WRITING ABOUT DISEASE AND PUBLIC HEALTH.***Cat. I*

This writing workshop focuses on the purposes and genres of writing about disease and public health. We will consider how biomedical writers communicate technical information about disease and public health to general audiences; how writers capture the human experience of disease and health care; how writers treat the public policy implications of disease; and how writers design publicity to promote public health. We will examine such genres as the experimental article, news reports, medical advice, profiles, commentary, and public health messages.

Recommended background: EN 2211 or equivalent writing courses.

Students who have taken EN 3215 may not receive credit also for EN/WR 3214.

**EN/WR 3217. CREATIVE WRITING.***Cat. I*

The purpose of this course is to help students develop or improve the skills of written expression. Small groups are formed in which participants present and discuss their original work in either fiction or poetry.

**EN 3222. FORMS IN WORLD DRAMA.***Cat. II*

The study of the major forms of world drama beginning with the Greeks and ending with contemporary forms. The student will develop the skills to analyze form and structure through dramatic content. The course may include the works of Sophocles, Euripides, Aristophanes, the Renaissance, the Restoration, Moliere, Ibsen, Strindberg, Shaw, Pirandello, and others.

This course will be offered in 2009-10 and in alternating years thereafter.

**EN 3223. FORMS IN MODERN DRAMA.***Cat. II*

The study of the forms in modern drama and their development from the forms of world drama. Contemporary playwrights studied could include Brecht, Bond, Schaeffer, Handke, and others, and the course will devote some concentration to theatre movements of the twentieth century that have operated with textual revision, minimal text, or no texts. Thus, theatre companies studied might include the work of the Living Theatre, the Open Theatre, and the theatre of Grotowski and Brook.

This course will be offered in 2008-09 and in alternating years thereafter.

**EN 3224. SHAKESPEARE SEMINAR.***Cat. II*

This course would allow for the study of various Shakespearean topics in different years. Some representative subjects could include: "Shakespeare and the Arts," "Shakespeare's Contemporaries," "Shakespeare and Science," "Shakespearean Tragedy," "Shakespeare's Roman Plays," "Shakespeare's Histories," "Shakespeare on Film." The topics will be announced before the seminar meets.

This course will be offered in 2009-10 and in alternating years thereafter.

**EN 3231. NEW ENGLAND SUPERNATURALISM.***Cat. II*

From the colonial period to the 20th century, New England writers have endowed the region's people and its settings (fields, forests, buildings, factories, cities) with shapes of fear. This course will explore New England's fascination with the supernatural from Puritan writings to the contemporary tale of terror. A primary focus of the course will be the genre of New England Gothicism and its literary conventions. Authors studied may include Hawthorne, Longfellow, Whittier, Freeman, Wharton, Jackson, Lovecraft, and King.

This course will be offered in 2009-10 and in alternating years thereafter.

**EN 3232. THE CONCORD WRITERS.***Cat. II*

Rural, mid-19th-century Concord, Massachusetts, witnessed an unprecedented flowering of important and influential American literature. Why Concord? We sample writings of Ralph Waldo Emerson, Henry D. Thoreau, Nathaniel Hawthorne, Bronson Alcott, and Louisa May Alcott to explore matters of cultural background, biography, contemporary events, uses of the past, literary vocation, and sense of place. Emphasis is on these writers' friendships and their creative responses to intellectual and social forces of the day—factors that made Concord a community of highly individualistic writers.

This course will be offered in 2009-10 and in alternating years thereafter.

Students who have received credit for EN 2236 (New England Writers: Concord) may not receive credit for EN 3232.

**EN 3233. WORCESTER BETWEEN THE COVERS: LOCAL WRITERS AND THEIR WORKS.***Cat. II*

Worcester has had a rich and varied literary history from Isaiah Thomas's founding of the American Antiquarian Society in the early 1800s to the works of S. N. Behrman, Robert Benchley, Elizabeth Bishop, Esther Forbes, Stanley Kunitz, and Charles Olson in the 20th century. This course will examine selections from Worcester area writers in a number of genres (e.g., fiction, drama, poetry, essay, nonfiction memoir). Attention will be given to the local contexts of these writings as well as to each writer's contributions to the larger continuum of American Literature.

This course will be offered in 2008-09 and in alternating years thereafter.

Students who have received credit for EN 2236 (New England Writers: Worcester) may not receive credit for EN 3233.

**EN 3234. MODERN AMERICAN POETRY.***Cat. II*

This course is a study of selected American poets and their reactions to the ferment of the modern period. A thematic approach to poetry will be emphasized. Included in the course are modern poets such as Robert Frost, T. S. Eliot, E. E. Cummings, and Marianne Moore, as well as contemporary poets such as Rita Dove, Li-Young Lee, and Robert Pinsky.

This course will be offered in 2008-09 and in alternating years thereafter.

**EN 3237. PURSUING *MOBY-DICK*.***Cat. II*

Since 1851, readers of Herman Melville's masterpiece have joined in the chase for the "meaning" of the White Whale. After briefly examining the philosophical context of Emersonian idealism and the literary example of Hawthorne, the course is devoted solely to a close reading of *Moby-Dick*—one of the most innovative and mysterious novels in the English language. "Whose" book is it, anyway? Captain Ahab's? Ishmael's? The Whale's? The reader's? We conclude by surveying major critical approaches to the novel.

This course will be offered in 2008-09 and in alternating years thereafter.

**EN 3248. THE ENGLISH NOVEL.***Cat. I*

Participants in this seminar will examine the English novel from its origins in the eighteenth century to its twentieth-century forms, exploring the rich variety of ways a writer may communicate a personal and social vision. The novels treat love, travel, humor, work, adventure, madness, and self-discovery; the novelists may include Fielding, Austen, Dickens, Eliot, Wodehouse, and Woolf.

**EN ----. DRAMA/THEATRE PERFORMANCES.***TH: IS/P*

One-sixth unit of credit will be awarded at the conclusion of two successive terms of participation. Performance activities currently receiving credit are:

- TH 1225 Theatre Production Practicum
- TH 2225 Acting
- TH 2227 Advanced Acting
- TH 2229 Advanced Theatre Production Practicum
- TH 3225 Directing
- TH 3227 Advanced Directing
- TH 3229 Dramaturgy
- TH 4225 Theatre Technology Design
- TH 4227 Advanced Theatre Technology Design
- TH 4229 Advanced Dramaturgy

Credit would be given on the condition that the performance takes place in a WPI performance directed or advised by a part- or full-time WPI instructor.

Note: A maximum of two one-sixth credits, or a total of one-third unit, may be applied toward the five courses, or five one-third units, taken prior to the final sufficiency term.

**ISE 1811. WRITING FOR NON-NATIVE SPEAKERS OF ENGLISH.***Cat. I*

This course offers, through conferences, tutorial sessions and extensive writing practice, a review of English composition principles for international students.

The following topics are included: the motivation of the writer; basic grammar; organization of the paragraph, sentence, and overall essay or report; vocabulary and word choice; spelling hints; and style. Much emphasis is given to the development of effective revising techniques. This is a course for those electing the "Basic Sufficiency for International Students."

**ISE 1812. SPEECH FOR NON-NATIVE SPEAKERS OF ENGLISH.***Cat. I*

This course focuses on developing international students' ability to speak effectively, organize ideas logically, improve voice and diction, and use visual aids. Television and audiotapes are used to record competence and poise. This is a course for those electing the "Basic Sufficiency for International Students."

---

**GERMAN (GN)**

---

**GN 1511. ELEMENTARY GERMAN I.***Cat. I*

An intensive language course designed to teach concise expression of ideas in writing and speaking. Basic grammar and significant cultural aspects are introduced through the aid of readings, audio-recordings, video, and oral group interaction. (Formerly GN 2616.)

**GN 1512. ELEMENTARY GERMAN II.***Cat. I*

A continuation of Elementary German I.  
Recommended background: GN 1511.

**GN 2511. INTERMEDIATE GERMAN I.***Cat. I*

A continuation of Elementary German II, with increased emphasis on oral and written expression. Basic textbook is supplemented by a collection of simple literary texts by the Grimm brothers, Brecht, and Bichsel.

Recommended background: Elementary German II.

**GN 2512. INTERMEDIATE GERMAN II.***Cat. I*

A continuation of Intermediate German I.

Recommended background: GN 2511.

**GN 3511. ADVANCED GERMAN I.***Cat. I*

Reading and in-class discussion of a wide variety of contemporary nonfictional and fictional texts. Some video viewing. Weekly brief writing assignments and continued expansion of vocabulary. Weekly vocabulary quiz. Review of grammar and introduction to advanced stylistic problems.

Recommended background: Intermediate German II.

**GN 3512. ADVANCED GERMAN II.***Cat. I*

A continuation of Advanced German I.

Recommended background: GN 3511.

**GN 3513. SURVEY OF GERMAN CIVILIZATION AND CULTURE FROM 1871 TO THE PRESENT.***Cat. II*

Conducted entirely in German, the course presents an overview of the development of modern Germany and its culture since the founding of the Second Empire. Background readings in German and English provide the basis for in-class discussion of selected authentic German texts of various kinds: literary works, official documents, political manifestos, letters, and diaries. At least one film will be shown. A number of recurring themes in German culture will inform the content of the course: authoritarianism versus liberalism, idealism versus practicality, private versus public life.

This course will be offered in 2008-09 and in alternating years thereafter.

Recommended background: GN 3511 (Advanced German I) and GN 3512 (Advanced German II) or equivalent.

**GN 3514. SEMINAR ON SELECTED TOPICS IN GERMAN LITERATURE.***Cat. II*

The content of the seminar will change from time to time. The course will focus either on an author (e.g., Goethe, Heine, Kafka, Gunter Grass, Christa Wolf), a genre (e.g., lyric poetry, drama, narrative prose), a literary movement (e.g., Romanticism, expressionism), or a particular literary problem (e.g., literature and technology, writing and the Holocaust, writing and the city). The seminar will be conducted entirely in German.

The course will be offered in 2009-10 and in alternating years thereafter.

Recommended background: GN 3511 (Advanced German I) and GN 3512 (Advanced German II) or equivalent.

**GN/ID 3515. TECHNICAL TOPICS IN GERMAN.***Cat. II*

Technical topics are addressed and discussed entirely in German. German-speaking faculty from several WPI science and engineering departments, as well as lecturers from outside the university, present a range of topics at an introductory level. The focus of the course is on the use and development of German language skills in a technical context, which will include lectures, presentations, discussions, problem solving, and writing on technical topics. The course can be counted towards a Sufficiency or a minor in German. As the course is to be conducted entirely in German, knowledge of German sufficient for advanced conversations and detailed writing (such as students acquire in GN 3512, Advanced German II, or equivalent) is strongly recommended.

This course will be offered in 2008-09, and in alternating years thereafter.

**HISTORY (HI)****HI 1311. INTRODUCTION TO AMERICAN URBAN HISTORY.***Cat. I*

An introduction to the history of the American city as an important phenomenon in itself and as a reflection of national history. The course will take an interdisciplinary approach to study the political, economic, social, and technological patterns that have shaped the growth of urbanization. In addition to reading historical approaches to the study of American urban history, students may also examine appropriate works by sociologists, economists, political scientists and city planners who provide historical perspective.

**HI 1312. INTRODUCTION TO AMERICAN SOCIAL HISTORY.***Cat. I*

An introduction to the historical study of American society. It addresses two questions: What is social history? And how do social historians work?

**HI 1313. INTRODUCTION TO THE STUDY OF FOREIGN POLICY AND DIPLOMATIC HISTORY.***Cat. I*

An introduction to the various components of U.S. foreign policy decision-making and the basic techniques of diplomatic history. The course will focus on one or two topics in the history of American foreign relations, using a variety of primary documents and secondary sources.

**HI 1314. INTRODUCTION TO EARLY AMERICAN HISTORY.***Cat. I*

An introduction to historical analysis through selected periods or themes in the history of America before the Civil War. A variety of readings will reflect the various ways that historians have attempted to understand the development of America.

**HI 1321. INTRODUCTION TO EUROPEAN SOCIAL HISTORY.***Cat. I*

An introduction to the study of modern European social history since the Industrial Revolution. Topics will include industrialization in Britain and Europe, class formation, gender and the condition of women, technology and economy, culture and society. Students will learn to work with historical sources, to formulate arguments, to read critically, and to write clearly.

No prior knowledge of European history is required.

**HI 1322. INTRODUCTION TO EUROPEAN CULTURAL HISTORY.***Cat. I*

In this course students think through some of the major intellectual currents that have defined modern Western Civilization. Topics include the philosophical impact of science on modern thought, the development of liberalism and socialism, the crisis of culture in the twentieth century. Students read selections from major thinkers in the Western tradition and develop their skills at critical thinking, analysis, oral and written argument.

No prior knowledge of European history is required.

**HI 1331. INTRODUCTION TO THE HISTORY OF SCIENCE.***Cat. I*

An introduction to the methods and source material historians use to study science. Topics covered will range from early Greek science to Newton and the Scientific Revolution in the 17th-century.

Suggested background: elementary knowledge of science.

**HI 1332. INTRODUCTION TO THE HISTORY OF TECHNOLOGY.***Cat. I*

An introduction to concepts of historical analysis — i.e., the nature and methodology of scholarly inquiry about the past — through the concentrated examination of selected case studies in the history of technology. Possible topics include: the influence of slavery on the development of technology in the ancient world and the middle ages; the power revolution of the middle ages; the causes of the Industrial Revolution in 18th-century Britain; and the emergence of science-based technology in 19th-century America.

**HI 1341. INTRODUCTION TO GLOBAL HISTORY.***Cat. I*

An introduction to the study of global history since 1500. Topics include global expansion, the Columbian exchange, and the slave trade; Renaissance, Reformation, and revolution in Europe; global industrialization, imperialism, and nation building; the world wars and revolutionary movements; decolonization and the Cold War. The course will also discuss case studies of developing nations of interest to students. Especially appropriate as background for students interested in International Studies or any of WPI's global Project Centers.

**HI 2311. AMERICAN COLONIAL HISTORY.***Cat. I*

This course surveys early American history up to the ratification of the Constitution. It considers the tragic interactions among Europeans, Indians, and Africans on the North American continent, the growth and development of English colonies, and the revolt against the Empire that culminated in the creation of the United States of America.

**HI 2313. AMERICAN HISTORY, 1789-1877.***Cat. I*

This course surveys American history from the Presidency of George Washington to the Civil War and its aftermath. Topics include the rise of American democracy, the emergence of middle-class culture, and the forces that pulled apart the Union and struggled to put it back together.



**HI 2314. AMERICAN HISTORY, 1877-1920.***Cat. I*

This course surveys the transformation of the United States into an urban and industrial nation. Topics will include changes in the organization of business and labor, immigration and the development of cities, the peripheral role of the South and West in the industrial economy, politics and government in the age of "laissez-faire," and the diverse sources and nature of late 19th- and early 20th-century reform movements.

**HI 2315. THE SHAPING OF POST-1920 AMERICA.***Cat. II*

This course surveys the major political, social, and economic changes of American history from 1920 to the present. Emphasis will be placed on the Great Depression, the New Deal, suburbanization, McCarthyism, the persistence of poverty, the domestic effects of the Vietnam war, and recent demographic trends.

**HI 2316. AMERICAN FOREIGN POLICY FROM WOODROW WILSON TO THE PRESENT.***Cat. I*

This survey of American diplomatic history begins with the legacy of Woodrow Wilson, continues through our apparent isolation in the 1920's, American neutrality in the 1930's, World War II, the early and later Cold War periods, and concludes with an overview of the current global involvement of the United States.

**HI 2317. LAW AND SOCIETY IN AMERICA.***Cat. I*

This survey course explores the dramatic expansion of government's role in American life between the Civil War and World War I. It does so by examining the response of constitutional, common, and statutory law to the social, economic, and political change associated with this pivotal period in the nation's history.

**HI 2321. EUROPE FROM THE OLD REGIME TO WORLD WAR I.***Cat. I*

A survey of the major socio-economic, political, and cultural developments in European history from the Old Regime to World War I. The course will focus upon those factors and events that led to the formation of modern European society: Nation-State building, The French Revolution, industrialization; liberalism, democracy, and socialism; national unification of Italy and Germany; the coming of World War I.

No prior knowledge of European history is required.

**HI 2322. EUROPE SINCE WORLD WAR I.***Cat. I*

A survey of the major political, socio-economic, and cultural developments in European history since World War I. The course will focus upon those factors and events that have led to the current world situation: the World Wars, fascism and communism, the Holocaust, the Cold War, the welfare state, decolonization, post-industrial society, popular culture, the collapse of communism, contemporary Europe.

No prior knowledge of European history is required.

**HI 2324. INDUSTRY AND EMPIRE IN BRITISH HISTORY.***Cat. I*

A survey of modern Britain from the 18th century to the present. Topics include the British state and national identity, the industrial revolution, political and social reform, the status of women, sport and society, Ireland, the British Empire, the World Wars, the welfare state, economic decline. Especially appropriate as background for students planning IQP's or Sufficiency Projects in London.

No prior knowledge of British history is required.

**HI 2325. MODERN FRANCE.***Cat. II*

This course examines the historical origins of modern France and the distinguishing features of French society and culture. Some of the topics covered include: Bourbon absolutism; the cause and effects of the French Revolution; the struggle for democratic liberalism in the 19th century; class and ideological conflict in the Third Republic; Vichy fascism, and present-day politics in the Fifth Republic.

No prior knowledge of French history is required.

This course will be offered in 2008-09 and in alternating years thereafter.

**HI 2328. HISTORY OF REVOLUTIONS IN THE TWENTIETH CENTURY.***Cat. II*

A survey of some of the most important revolutionary movements of the twentieth century. We may consider topics such as racial, nationalist, feminist

and non-violent revolutionary ideologies, communist revolution, the "green" revolution and cultural revolution. No prior knowledge of the history of revolutions is expected.

This course will be offered in 2007-08 and in alternate years thereafter.

**HI 2330. HISTORY OF AMERICAN SCIENCE AND TECHNOLOGY.***Cat. I*

This course surveys American science and technology from the colonial period to the present. Topics will include: the influence of the Scientific Revolution in the United States; the American Industrial Revolution; the rise of science as a profession; Darwinism and Social Darwinism; scientific education; positivism and the growth of the physical sciences; the new biology and medicine; conservation; the gospel of efficiency and progressivism; science, World War I and the 1920s; the intellectual migration and its influence; science, technology and World War II; Big Science, the Cold War, and responses to Big Science; and cultural responses to science and controversies about science.

**HI 2334. EUROPEAN TECHNOLOGICAL DEVELOPMENT.***Cat. I*

A survey of the development of technology in Europe from the late medieval period to World War I. Emphasis will be placed on understanding the evolution of technology within its cultural, social, and political contexts. Topics may include the military, mechanical, maritime, and building technologies of the medieval and Renaissance periods; the commonly misunderstood figure of Leonardo da Vinci; the causes and nature of the Industrial Revolution; the effects of the British Industrial Revolution in France and Germany in the 19th century; the transition from craft-based industries to those that are science based such as the dyestuffs and electrical power industries; World War I as a technological conflict.

**HI 2343. EAST ASIA: CHINA AT THE CENTER.***Cat. II*

This course will explore two thousand years of Asian participation in an international system, in Asia and with the rest of the world. Whether ruled by Chinese, Turks, Mongols or Manchus, China has been the political and cultural center of East Asia. Understanding the role of this superpower is critical to Asian and world history. The course will focus on themes such as the cosmopolitan experience, the early development and application of 'modern' ideas such as bureaucracy, market economy, and paper currency, and the centrality of religious ideology as a tool in statecraft. No prior knowledge of Asian history is required.

This course will be offered in 2008-09, and in alternate years thereafter.

**HI 2351. HISTORY OF ECOLOGY.***Cat. II*

A survey of ecological thought from origins in ancient ideas about nature and the human place in nature, through the environmental thought of the Romantic Movement and responses to industrialization in the United States, and of the rise of ecology as a scientific discipline, this course will examine both the development of ecological sciences themselves and the relationship of the science of ecology to historically evolving schools of environmental thought.

This course will be offered in 2008-09 and in alternate years thereafter.

**HI 2401. U.S. ENVIRONMENTAL HISTORY.***Cat. II*

This course surveys the environmental history of North America from the time of Columbus until the present, exploring how the environment has shaped human culture, and how human activity and human ideas have shaped nature. We will examine changes during three periods: a "contact" period focusing on the ecological, economic and cultural ramifications of Old World-New World interconnection; a "development" period focusing on the rise of a market-based, urban-industrial society during the nineteenth century; and a final period characterized by the growth of reform movements to protect nature and the increasing global movement of goods and ideas in the twentieth century. In each period, we will trace changes in production, labor, and consumption patterns; transportation and other technologies; science, knowledge, and planning; disease, health and medicine; and cultural understandings, political debates, and place-making strategies.

This course will be offered in 2009-10 and in alternating years thereafter.

**HI 2402. HISTORY OF EVOLUTIONARY THOUGHT.***Cat. II*

This course will trace the history of evolutionary thought, including the growth of the geological sciences and expanding concepts of geological time, increased global travel suggesting new perspectives on biogeography, discoveries of fossils of now-extinct animals, and developments in comparative embryology and anatomy, culminating in the synthesis effected in 1859 by Charles Darwin, and in the Modern Synthesis of the 1940s. It will include emphases on the relationships of evolutionary and religious thought, and on depictions of

evolutionary themes in the larger culture, including the arts, film, literature and popular culture, and will examine controversies, including current controversies, over evolution and the teaching of evolution in public schools in the United States.

This course will be offered in 2009-10 and in alternate years thereafter.

#### HI 3311. AMERICAN LABOR HISTORY.

*Cat. I*

This seminar course will deal with the history of organized labor in America as well as with the historic contributions of working people, whether unionized or not, to the growth and development of American ideas, politics, culture, and society.

Among the topics to be covered will be: the origins, growth, and expansion of trade and industrial unionism; the roots and development of working class consciousness; the underlying causes and eventual resolution of labor disturbances; the philosophical and ideological perspectives of the labor movement. Students will explore topics raised by common readings via written papers, seminar presentations, and work with primary source materials.

Suggested background: HI 2314, American History, 1877-1920; or HI 2315, The Shaping of Post-1920 America.

#### HI 3312. TOPICS IN AMERICAN SOCIAL HISTORY.

*Cat. I*

A seminar course on analysis of selected aspects of social organization in American history, with emphasis on the composition and changing societal character of various groups over time, and their relationship to larger social, economic, and political developments. Typical topics include: communities, families, minorities, and women.

Suggested background: Some college-level American history.

#### HI 3314. THE AMERICAN REVOLUTION.

*Cat. I*

This seminar course considers the social, political, and intellectual history of the years surrounding American independence, paying particular attention to the changes in society and ideas that shaped the revolt against Great Britain, the winning of independence, and the creation of new political structures that led to the Constitution.

#### HI 3316. TOPICS IN TWENTIETH-CENTURY U.S. HISTORY.

*Cat. II*

In this advanced seminar course, students will explore one aspect of twentieth-century U.S. history in more depth. Topics vary each year but may include political movements such as the New Deal or the Civil Rights Movement, an aspect of American foreign policy such as the Cold War, a short time period such as the 1960s, a cultural phenomenon such as consumption, or a geographical focus such as cities or New England. The course will require substantial reading and writing. Suggested background: HI 2314 (American History, 1877-1920), HI 2315 (The Shaping of Post-1920 America), or other American history courses.

This course will be offered in 2009-10, and in alternating years thereafter.

#### HI 3317. TOPICS IN ENVIRONMENTAL HISTORY.

*Cat. II*

In this seminar course, students will explore one aspect of U.S. or global environmental history in more depth. Topics vary each year but may include environmental thought, environmental reform movements, comparative environmental movements, natural disasters, the history of ecology, built environments, environmental justice, New England environmental history, or the environmental history of South Asia or another region of the world. The course will require substantial reading and writing. Suggested background: HI 2401 U.S. Environmental History.

This course will be offered in 2008-09, and in alternating years thereafter.

#### HI 3321. TOPICS IN MODERN EUROPEAN HISTORY.

*Cat. II*

This seminar course examines topics in the cultural, socio-economic and political history of modern Europe, with a focus on Great Britain. Topics may vary each year among the following: nationalism, class and gender, political economy, environmental history, sport and society, film and history. Readings will include primary and secondary sources.

This course will be offered in 2009-10 and in alternating years thereafter.

#### HI 3323. TOPICS IN THE WESTERN INTELLECTUAL TRADITION.

*Cat. II*

This seminar course in the history of ideas focuses each year on a different theme within the intellectual-cultural traditions of Western Civilization. Some topics are the following: The Impact of the New Physics on 20th Century

Philosophy; The Social History of Ideas; The Enlightenment and the French Revolution; Sexuality, Psycho-analysis, and Revolution. The course is structured around classroom discussion of major texts on the topic under study and a related research paper.

This course will be offered in 2009-10 and in alternating years thereafter.

#### HI 3331. TOPICS IN SCIENCE, TECHNOLOGY, AND SOCIETY.

*Cat. I*

A seminar course on the relationships among science, technology, and society in Europe through a series of case studies. Topics from which the case studies might be drawn include: the harnessing of science for industrial purposes; the role of the chemical industry in war; the function of the science advisor in government; the military-industrial complex in Nazi Germany; the political views and activities of major scientists such as Einstein.

Suggested background: Courses in European history and the history of science and technology.

#### HI 3333. TOPICS IN AMERICAN TECHNOLOGICAL DEVELOPMENT.

*Cat. I*

A seminar course examining selected examples of technological change in the United States. Topics from which these case studies might be chosen include: colonial technology; mechanization of ante-bellum industry; the impact of science on Gilded-Age technology; 20th-century behavioral technologies; the evolution of the military-industrial complex; the Manhattan Project; the exploitation of space; computers and post-World-War-II technology; and the emergence of biotechnology. In addressing these cases, this seminar will employ and seek to evaluate one or more significant historical theses about the nature of technological change.

Suggested background: Some familiarity with the basic outlines and concerns of both American history and the history of American technology.

#### HI 3334. TOPICS IN THE HISTORY OF AMERICAN SCIENCE AND TECHNOLOGY.

*Cat. I*

This seminar will examine a particular issue or theme in the history of American science and technology. Topics will vary from year to year, but may include: technology and the built environment; science, technology and the arts; communications of science and scientific issues with the larger public; technology and scientific illustration; science in popular culture; science and the law; or close examination of episodes in the history of American science and technology such as the American Industrial Revolution; science and technology in the years between the world wars; the Manhattan Project; science and the culture of the Cold War; or science, technology and war in American history. This course will require significant reading and writing.

Suggested background: Some familiarity with history of science or history of technology, and with United States history.

#### HI 3341. TOPICS IN IMPERIAL AND POSTCOLONIAL HISTORY.

*Cat. II*

This seminar course examines topics in the history of European imperialism, colonialism, and the postcolonial aftermath. Topics vary each year among the following: culture and imperialism, the expansion of Europe, the economics of empire, travel and exploration narratives, imperialism in literature and anthropology, decolonization in Asia and Africa, postcolonial studies. Readings will include primary and secondary sources.

This course will be offered in 2008-09 and in alternating years thereafter.

#### HI 3342. TOPICS IN COMPARATIVE CIVILIZATIONS.

*Cat. II*

This seminar course compares and contrasts major religious, philosophical, social, and political themes in different civilizations. Comparisons will vary each year but may be drawn from Asia, the Indian subcontinent, the Middle East, Africa, and indigenous cultures of the Americas. It examines the historical foundations of these civilizational differences and draws comparisons with common features of Western civilization. One important goal of the course is to enhance student appreciation of non-Western values and traditions.

This course will be offered in 2008-09 and in alternating years thereafter.

#### HI 3343. TOPICS IN ASIAN HISTORY.

*Cat. I*

This seminar course examines topics in the cultural, socio-economic, religious and political history of East Asia. Topics vary each year and may include the following: nationalism and the writing of history, travel and exploration narratives, cross-cultural contact, the role of religion and ideology in political history, development and the environment in Asia, film and history, and the place of minorities and women in Asian societies. Suggested background: previous courses on Asia such as HU 1412, HI 2328, HI 2343, or RE 2724.

**ISE 1813. AMERICAN HISTORY FOR INTERNATIONAL STUDENTS.***Cat. I*

An introduction to American history designed to provide international students with a basic understanding of the history and culture of the United States.

Written and oral assignments will also help these students gain a more effective command of the English language.

**HUMANITIES (HU)**

The courses listed below are general humanities courses and are intended to provide conceptual introductions to the major disciplines within the humanities. Students will encounter the basic methods of critical analysis and discussion required for the future investigation of the specific area they choose for their humanities and arts Sufficiencies. These courses emphasize patterns of thought, methods of inquiry, appropriate vocabulary, and critical attitudes needed to appreciate most fully various areas in the humanities; they are not intended as surveys or historical overviews. Consequently, in each course the subject matter used to develop and illustrate key concepts and approaches will change regularly. Practice in analytic thinking and writing will be a significant part of each course. The skills generated by these courses will greatly aid students in developing their themes and will be essential for the completion of the Sufficiency in the final IS/P seminar.

**HU 1401. INTRODUCTION TO HUMANITIES & ARTS, I.***Cat. I*

This course is open to students enrolled in the Project-based Learning Community. The course focuses on developing basic skills of humanistic inquiry: careful analysis of complex arguments and evidence; accurate description and assessment of texts; and appreciation of the diversity of opinions and interpretations of materials. Students examine core readings in history, literature, or philosophy, and participate in team-oriented projects concerning real-world problems that cross the boundaries of the humanities, sciences, mathematics and technology. Projects vary and may include areas such as the history of science, contemporary affairs, international relations, and quantitative analysis of social issues.

**HU 1402. INTRODUCTION TO HUMANITIES & ARTS, II.***Cat. I*

This course is open to students enrolled in the Project-based Learning Community and is a continuation of HU 1401. Students continue to read, analyze and write about core readings in history, literature, and philosophy, and complete team-oriented projects that examine real-world problems at the intersection of the humanities, sciences, mathematics, and technology.

Recommended Background: HU1401, Introduction to Humanities and Arts I.

**HU 1411. INTRODUCTION TO AMERICAN STUDIES.***Cat. II*

This interdisciplinary course introduces students to three or four basic American Studies methodologies. Emphasis will vary according to the instructor, but usually the course will cover the following: the particular historical, cultural context (at the community and/or national level) of a few literary texts; the relationship of American art to literature in a specific time period; analysis of popular culture entertainments in market-and-message terms of production and reception. This course provides a beginning for a Sufficiency in American Studies. For a description of the American Studies sequence and offerings, see the Sufficiency section of the Undergraduate Catalog.

Suggested background: an interest in American history and American expression.

This course will be offered in 2009-10 and in alternating years thereafter.

**HU 1412. INTRODUCTION TO ASIA.***Cat. I*

This course will explore Asia through an interdisciplinary approach. We will examine tradition and modernity in some or all of four cultural regions—South Asia (India), East Asia (China), Southeast Asia (Vietnam or Thailand), Inner Asia (Tibet)—and globalization in Japan and/or Hong Kong. We will explore the cultural traditions of these various regions, paying special attention to history, religion, society. We will also consider modern developments in these same regions. The impact of colonialism, nationalism, revolution, industrialization and urbanization on the lives of Asian peoples will be illustrated through films and readings. No prior knowledge of Asian history or culture is expected.

**HU 2441. AFRICAN HISTORY AND CULTURE.***Cat. II*

This survey course uses an interdisciplinary approach to examine fundamental issues in African political, social, and cultural history. The course may include various topics, such as ancient African kingdoms, the influence of Islam, the Atlantic slave trade, imperialism and decolonization, contemporary democratization, or African literature and art.

Suggested background: HI 1341 Introduction to Global History.

This course will be offered in 2009-10 and in alternating years thereafter.

**HU 3411. PRO-SEMINAR IN GLOBAL PERSPECTIVES.***Cat. II*

This course examines the fundamentals of intercultural communication to prepare students to live and work with people from other cultures. It explores how different patterns of thinking and behavior, assumptions and values, have arisen from different cultural traditions and divergent histories in the world. Racism, prejudice, and bigotry—often the result of cultural, social, and technological differences in human experience—are among the concerns of the class. This course cannot teach students how to behave and think in all parts of the world, but it raises questions about ethnocentric assumptions often taken for granted by those working or studying in another culture. It is excellent preparation for an international IQP or educational exchange.

Suggested background: Previous courses in Humanities.

This course will be offered in 2009-10 and in alternating years thereafter.

**HU 3900. INQUIRY SEMINAR IN HUMANITIES AND ARTS.***Cat. I*

This seminar serves as the culmination for a student's Humanities and Arts requirement. The seminar provides opportunities for sustained critical inquiry into a focused thematic area. The seminar seeks to help students learn to communicate effectively, to think critically, and to appreciate diverse perspectives in a spirit of openness and cooperation through research, creativity, and investigation. The specific theme of each seminar will vary and will be defined by the instructor. Prior to enrolling in the seminar, a student must have completed five courses in Humanities and Arts, at least two of which must be thematically related and at least one of which must be at the 2000-level or above.

**HU 3910. PRACTICUM IN HUMANITIES AND ARTS.***Cat. I*

The practicum serves as the culmination for a student's Humanities and Arts requirement. The practicum provides opportunities for sustained critical inquiry into a focused thematic area. The practicum seeks to help students learn to communicate effectively, to think critically, and to appreciate diverse perspectives in a spirit of openness and cooperation through research, creativity, and investigation. The specific theme of each practicum will vary and will be defined by the instructor. Prior to enrolling in the practicum, a student must have completed five courses in Humanities and Arts, at least two of which must be thematically related and at least one of which must be at the 2000-level or above. Consent of the instructor is required for enrollment.

**HU 4411. SENIOR SEMINAR IN INTERNATIONAL STUDIES.***Cat. I*

This course is designed to integrate each student's international courses, projects, and experiences in a capstone seminar in International Studies. Students will reflect on what they have learned in their previous courses and international experiences. They will assess what happened to them overseas, why it happened, and how it might be understood. They will also prepare a paper with an instructor in their area of international studies that integrates their previous academic courses. Students will also explore how they might translate their courses and experiences into future personal and professional opportunities.

Recommended background: previous courses in international studies, such as HI 1341 and HU 3411, and completion of an international IQP or an international educational exchange.

**HU—AAS-50. AMERICAN ANTIQUARIAN SEMINAR.***ISP*

Each fall the American Antiquarian Society and five Worcester colleges sponsor a research seminar at the Antiquarian Society library. The seminar is conducted by a scholar familiar with the Society's holdings in early American history, and the seminar topic is related to his or her field of research.

Selection is highly competitive. The ten participating students are chosen by a screening committee made up of representatives of the five participating colleges: Assumption College, Clark University, College of the Holy Cross, WPI, and Worcester State College.

The seminar topic and research methods combine several disciplines, and students from a wide variety of majors have participated successfully in this unique undergraduate opportunity.



**MUSIC (MU)****MU 1611. FUNDAMENTALS OF MUSIC I.***Cat. I*

This course concentrates on basic music theory of the common practice period. If time permits, instruction includes ear training, sight singing, and work on scales and intervals.

Recommended background: basic knowledge of reading music.

**MU 2611. FUNDAMENTALS OF MUSIC II.***Cat. I*

Fundamentals II is a course on music theory at the advanced level beginning with secondary dominants and modulations and working through 19th-century chromatic harmony.

**MU 2719. JAZZ HISTORY.***Cat. II*

Through an introduction to the musical contributions of Louis Armstrong, Duke Ellington, Charlie Parker, Miles Davis and others, students are exposed to the chronological development of the language of jazz. Each jazz era is examined in detail including the musical and social contexts which helped define it. Participants are expected to build aural skills with the goal of identifying specific historical periods through the recognition of particular musical characteristics. Students examine in depth one artist of their choice.

This course will be offered in 2008-09 and alternating years thereafter.

[This replaces MU 4623. Credit is not allowed for both MU 4623 and MU 2719.]

**MU 2720. MUSIC HISTORY I: MEDIEVAL THROUGH THE BAROQUE.***Cat. II*

This course provides a historical survey of Western music from Medieval through Baroque periods with an emphasis on understanding stylistic traits and theoretical concepts of the eras. Topics include Gregorian chant and secular monophony; evolution of musical notation; development of polyphonic music; and vocal and instrumental genres such as mass, motet, madrigal, opera, cantata, sonata, and concerto, among others.

No prior background in music is necessary.

This course will be offered in 2008-09 and alternating years thereafter.

**MU 2721. MUSIC HISTORY II: CLASSICAL TO THE PRESENT.***Cat. I*

This course provides a historical survey of Western music from the Classical period to the present with an emphasis on understanding stylistic traits and theoretical concepts of the eras. Topics include the development of genres such as sonata, string quartet, concerto, symphony, symphonic poem, character piece, Lied, and opera; and 20<sup>th</sup> century trends of impressionism, primitivism, atonality, serialism, minimalism, aleatory music, and electronic music.

No prior background in music is necessary.

**MU 2722. HISTORY OF AMERICAN POPULAR MUSIC.***Cat. I*

This course will explore the uniqueness of America's popular music and its origins in the music of Africa and the folk music of Europe. Particular emphasis will be given to the origins and history of rock 'n' roll examining its roots in blues and early American popular music. [This replaces MU 4625. Credit is not allowed for both MU 4625 and MU 2722.]

**MU 2730. JAZZ THEORY.***Cat. I*

This course examines harmonic and melodic relationships as applied to jazz and popular music composition. Students are introduced to a wide range of jazz improvisational performance practices. Topics include compositional forms, harmonic structures, major and minor keys, blues, modal jazz, and re-harmonization techniques. Students are expected to have a basic knowledge of reading music. [This replaces MU 4624. Credit is not allowed for both MU 4624 and MU 2730.]

**MU 3001. WORLD MUSIC.***Cat. II*

This course introduces students to selected musical cultures of the world, e.g., Africa, Asia, the Middle East, and Latin America, from the ethnomusicological perspective by examining their musical styles as well as cultural and social contexts. Students will be expected to read materials in interdisciplinary areas, including musical ethnographies.

No prior background in music is necessary.

This course will be offered in 2009-10 and alternating years thereafter.

**MU 3002. ARRANGING AND ORCHESTRATION.***Cat. I*

Students will study specific characteristics of instruments and the voice to enable them to successfully arrange vocal and instrumental music. Students will need to possess a basic knowledge of music theory. Suggested background for this course is MU 1611 (Fundamentals of Music I) or its equivalent.

**MU 3611. COMPUTER TECHNIQUES IN MUSIC.***Cat. I*

This course concentrates on both the technical and artistic aspects of computer music. Topics covered include the MIDI protocol and specification, sequencer design, voice editing, synthesizer architecture, and literature.

**MU 3612. COMPUTERS AND SYNTHESIZERS IN MUSIC.***Cat. I*

This course focuses on technical and aesthetic problem solving in computer music. Using programming languages, students propose and design creative solutions to contemporary problems which currently have no commercial solutions. Students work with sequencers, signal processors, synthesizers, MIDI controllers, editors, and programming languages.

**MU 3613. DIGITAL SOUND DESIGN.***Cat. I*

This course introduces the student to the theory and practice of digital sound design. It focuses on creative problem-solving in applications where digital audio production is a key component. Topics include digital sound recording and editing, creation and synchronization of digital sound tracks for video, theatrical sound design, and multimedia production.

**MU 4621. INDEPENDENT INSTRUCTION (LESSONS) IN MUSIC.***IS/P*

Students electing to take their humanities and arts Sufficiency in music may, for one of their five courses, undertake 1/3 unit (normally at 1/12 unit per term) of private vocal or instrumental instruction. (Supplemental ensemble work is also strongly recommended.) The student must receive prior approval by a member of the WPI music faculty, and the instruction must be beyond the elementary level. Lessons involve a separate fee. Note that the maximum of 1/3 unit credit for lessons may be earned in addition to 1/3 unit credit for performance (see condition A or B below). Additional work, either in performance or lessons, may be acknowledged on the WPI transcript but will carry no WPI credit. Private lessons: voice, piano, organ, winds, brass, strings, and percussion.

**MU 4628. PERFORMANCE SUFFICIENCY.***IS/P*

A final (sixth term) Sufficiency in music may be fulfilled by a recital performance in addition to a related paper, provided the music faculty determines that the student's capabilities be of a high order. During this term, the student usually is under private instruction, the cost of which is borne by the student.

NOTE: Two 1/3 units credit remain the maximum allowed for all lessons and performance credit.

**MUSIC ENSEMBLES (MU)**

Students who sing or play a traditional band or orchestra instrument at the intermediate level or better may enroll for any of the ensembles listed below. Students will register at the beginning of A term and receive 1/6 unit at the end of B term for participation in both terms. Students may also register at the beginning of C term and receive 1/6 unit at the end of D term for participation in both terms. Students may apply up to 1/3 unit of performing ensembles to the Humanities and Arts Sufficiency course requirement.

**MU 2631. MEN'S GLEE CLUB.***Cat. I*

The Glee Club is the men's choral ensemble and the oldest student organization on campus. Glee Club performs many styles and periods of the vast repertoire of music for men's ensembles. Several times each year the Glee Club and Alden Voices (Women's Chorale) join forces as the WPI Festival Chorus to perform major works of the repertoire. The Glee Club tours Europe and also performs on tour. Rehearsals are held weekly. Prior singing or music experience is encouraged but not required. Open to all men.

**MU 2632. ALDEN VOICES.***Cat. I*

Alden Voices is the women's choral ensemble. Alden Voices performs many styles and periods of the vast repertoire of music for women's ensembles. Several times each year Alden Voices and the Men's Glee Club join forces as the WPI Festival Chorus to perform major works of the repertoire. Alden Voices performs on tour as well as performing on campus. Rehearsals are held weekly. Prior singing or music experience is encouraged but not required. Open to all women.

**MU 2633. BRASS ENSEMBLE.***Cat. I*

The Brass Ensemble performs frequently on campus and on tour and is open to students who perform on trumpet, trombone, euphonium, French horn, tuba, or tympani. Renaissance antiphonal music is included in the repertoire. Rehearsals are held weekly. Students are expected to perform with the ensemble and to know how to read music. Permission of the instructor is necessary to register.

**MU 2634. JAZZ ENSEMBLE.***Cat. I*

The Jazz Ensemble performs frequently on campus and on tour and plays jazz arrangements written for a small ensemble with major emphasis on improvisation. Rehearsals are held weekly. Students are expected to perform with the ensemble and to know how to read music. Permission of the instructor is necessary to register.

**MU 2635. STAGE BAND.***Cat. I*

The Stage Band performs traditional and contemporary big band literature with an emphasis on stylistically appropriate interpretation and performance practice. The ensemble performs frequently on campus and on tour. Rehearsals are held weekly. Students are expected to perform with the ensemble and to know how to read music. Permission of the instructor is necessary to register.

**MU 2636. CONCERT BAND.***Cat. I*

The Concert Band is a large ensemble that performs several concerts a year as well as on tour. Membership is open to those who play traditional wind, brass or percussion instruments. Rehearsals are held weekly. Students are expected to perform with the ensemble and to know how to read music.

**MU 2637. STRING ENSEMBLE.***Cat. I*

The String Ensemble performs music for string orchestra both on campus and on tour. Members of the string ensemble also comprise the string section for the full orchestra. Rehearsals are held weekly. Students are expected to perform with the ensemble and to know how to read music.

**MU 2638. VOCAL PERFORMANCE LAB.***Cat. I*

The Vocal Performance Lab is a performance practice oriented chamber vocal ensemble. This ensemble explores specific stylistic techniques as pertains to the music of the Renaissance, Baroque, twentieth century, jazz, and extended vocal techniques (electronic, digital and experimental). The ensemble meets weekly. Students are expected to be of the highest vocal caliber and should possess advanced sight-reading techniques. Open to both men and women. Permission of the instructor is necessary to register.

**PHILOSOPHY (PY)****PY/RE 1731. INTRODUCTION TO PHILOSOPHY AND RELIGION.***Cat. I*

This course provides an overview of key concepts, methods and authors in both fields. These introduce the student to the types of reasoning required for the pursuit of in-depth analysis in each discipline.

Emphasis on topics and authors varies with the particular instructor.

**PY 2711. PHILOSOPHICAL THEORIES OF KNOWLEDGE AND REALITY.***Cat. I*

This course introduces students to methods of philosophical analysis relating to the classification and conceptualization of entities and the nature of knowledge. The course will focus on a related set of problems or on the elaboration of a philosophical issue of knowledge or reality in the history of philosophy. Among themes and problems considered might be: How has the being of nature and knowledge of nature been represented in Western philosophy and science? What kind of a phenomenon is mind or thought and can entities in addition to human beings, such as computers, be said to have this attribute? What are reliable methods of arriving at and evaluating scientific knowledge, and are these methods identical for the natural and human sciences? Readings might include excerpts from the works of Plato, Aristotle, Bacon, Descartes, Kant, James, Dewey and Heidegger, as well as numerous contemporary philosophers.

Suggested background: familiarity with basic philosophical concepts and terms (as in PY/RE 1731).

**PY 2712. SOCIAL AND POLITICAL PHILOSOPHY.***Cat. II*

This course examines metaphysical and moral questions that philosophers have raised about social and political life. Among questions treated might be: What

are the grounds, if any, of the obligation of a citizen to obey a sovereign? Are there basic principles of justice by which societies, institutions and practices are rightly evaluated? What is democracy, and how can we tell if an institution or practice is democratic? To what degree do economic institutions put limits on the realization of freedom, democracy and self-determination? Readings might include excerpts from the works of Plato, Hobbes, Locke, Rousseau and Marx, as well as numerous contemporary philosophers.

Suggested background: familiarity with basic concepts in philosophy (as in PY/RE 1731).

This course will be offered in 2009-10 and in alternative years thereafter.

**PY 2713. BIOETHICS.***Cat. II*

The purpose of this course is to evaluate the social impact of technology in the areas of biology/biotechnology, biomedical engineering and chemistry. The focus of the course will be on the human values in these areas and how they are affected by new technological developments. The course will deal with problems such as human experimentation, behavior control, death, genetic engineering and counseling, abortion, and the allocation of scarce medical resources. These problems will be examined through lectures, discussions and papers.

Suggested background: knowledge of key terms and concepts as given in PY/RE 1731 and PY/RE 2731.

This course will be offered in 2009-10 and in alternating years thereafter.

**PY 2714. ETHICS AND THE PROFESSIONS: PERSONAL, PROFESSIONAL, AND SOCIAL DILEMMAS.***Cat. II*

This course will present a framework by which various ethical dilemmas that arise in the professions, especially the science-related professions, can be identified, examined, and evaluated on the level of personal morality, professional codes of ethics, and social values. The goal is to study the solutions of these dilemmas in each of the three levels to determine what relation there may be between them, and whether or not resolutions of a dilemma on one level are appropriate for another level. Ethical concepts, professional codes of ethics, and policy positions will be used to analyze and evaluate these issues in a case study format. Representatives of appropriate professions will be invited to address specific issues pertaining to ethical dilemmas in their field.

This course will be offered in 2008-09 and in alternating years thereafter.

**PY 2715. PHILOSOPHICAL THEORIES OF THE SELF.***Cat. II*

This course will focus on philosophical questions concerning the nature of human identity. It will examine arguments from various philosophical traditions on topics such as the nature of personhood, self-deception, the importance or unimportance of everyday concerns, the comparative role of individual decisions and social norms, and the differences between secular and religious, Western and Eastern, political and apolitical approaches to all these issues. Authors may include some of the following: Thoreau, Kierkegaard, Hegel, Camus, Buddha, Plato, Marx, Freud and de Beauvoir.

Suggested background: familiarity with basic ethical concepts and terms (as in PY/RE 1731) and PY/RE 2731 or PY 2712.

This course will be offered in 2009-10 and in alternating years thereafter.

**PY 2716. PHILOSOPHY OF DIFFERENCE.***Cat. II*

This course examines philosophical presuppositions and questions of value underlying and expressed in the construction of masculinity and femininity in modern society. The course may also examine social identities rooted in race, ethnicity, sexual preference, and ability/disability. Possible topics include: changing conceptions of love, sex, marriage, and parenting; how our conceptions of masculinity and femininity are influenced by and influence (for example) religion, science, politics, work, and art; and the relations between feminist theory and other critical social theories.

This course will be offered in 2008-09 and in alternating years thereafter.

**PY 2717. PHILOSOPHY AND THE ENVIRONMENT.***Cat. I*

This course will focus on the following questions:

What is the scope of the current environmental crisis? What does this crisis reveal about the philosophical presuppositions and dominant values of our intellectual worldviews and social institutions? How can existing social theories help explain the environmental crisis? What implications does the crisis have for our sense of personal identity? What moral and spiritual resources can help us respond to it?

Readings will be taken from contemporary and historical philosophers and naturalists.

Suggested background: familiarity with basic concepts in philosophy (as in PY/RE 1731).

**PY/RE 2731. INTRODUCTORY ETHICS.***Cat. I*

This course will review at an introductory level theories of ethics, individual figures in the history of ethics, and selected problems in ethics. The emphasis will be on philosophical or religious ethics depending on the instructor.

**PY 3711. TOPICS IN PHILOSOPHY.***Cat. I*

The purpose of this course is to expose students to somewhat more advanced and specialized study in philosophy. Its focus will vary, but will typically be one of the following types: a particular philosopher (e.g., Plato, Kant, Mill); a particular philosophical tradition (e.g., Pragmatism, Ordinary Language philosophy, Empiricism); a particular philosophical problem (free will, knowledge of other minds, historical explanation); or a particular philosophical classic (Hegel's *Phenomenology of Mind*, Aristotle's *Ethics*).

Suggested background: three other philosophy courses.

**PY 3712. PHILOSOPHY OF RELIGION.***Cat. II*

This course will focus on philosophical questions concerning the following topics: the existence and nature of God; the compatibility of God and evil; the nature of religious faith and the relationship between religion, science and ethics; interpretations of the nature of religious language; the philosophically interesting differences between Western and Eastern religions; philosophical critiques of the role of religion in social life. Authors may include: Hume, Kant, Kierkegaard, Buber, Tillich, Daly, Nietzsche and Buddha.

Suggested background: familiarity with basic religious concepts and terms (as in PY/RE 1731).

This course will be offered in 2008-09 and in alternating years thereafter.

**PY/RE 3731. PROBLEMS IN ETHICS AND SOCIAL PHILOSOPHY.***Cat. I*

This course will examine in depth selected problems in ethical theory and social philosophy. The specific content or emphasis will be determined by the instructor.

Suggested background: knowledge of either PY/RE 2731 or PY 2712.

**RELIGION (RE)****RE/PY 1731. INTRODUCTION TO PHILOSOPHY AND RELIGION.***Cat. I*

This course provides an overview of key concepts, methods and authors in both fields. These introduce the student to the types of reasoning required for the pursuit of in-depth analysis in each discipline.

Emphasis on topics and authors varies with the particular instructor.

**RE 2721. RELIGION AND CULTURE.***Cat. I*

The purpose of this course is to examine how the two institutions of religion and culture interact and mutually influence one another. To do this a variety of definitions of religion and culture will be presented as well as an analysis of how religion interacts with such cultural phenomena as economics, politics, the state, war and the basic problem of social change. The purpose of this is to obtain a variety of perspectives on both religion and culture so that one can begin to articulate more clearly the different influences that occur in the development of one's own personal history and the culture in which one lives.

Suggested background: knowledge of key terms and concepts as given in PY/RE 1731.

**RE 2722. THE PROBLEM OF EVIL.***Cat. I*

Notions of good and evil shape many of our day to day religious and philosophical claims and arguments. This course concerns questions and approaches to what is often called "evil," through a study of classical and contemporary texts and problems. The focus of the course will vary, but will include metaphysical, moral, and political ideas about kinds and relations of goods and evils from different religious and philosophical perspectives. This study takes into account notions of error, ignorance, wrong-doing, freedom and responsibility evident in contemporary religious and philosophical debate.

**RE 2723. RELIGIONS OF THE WEST.***Cat. II*

The purpose of this course is to examine, from an historical, doctrinal, scriptural and philosophical perspective, major Western religions. The course will focus primarily on Judaism, Christianity and Islam. Other religions will be examined. The course will attend to the social context in which these religions developed and will examine their continuing influence on Western society.

Suggested background: RE/PY 1731 and RE 2721.

This course will be offered in 2008-09 and in alternating years thereafter.

**RE 2724. RELIGIONS OF THE EAST.***Cat. II*

The purpose of this course is to examine, from the perspectives of history text, practice, and philosophy, some or all of the following religions: Hinduism, Buddhism, Taoism, Confucianism, and Shinto. The course will attend to the social context in which these religions began, their relations with their culture, their rituals and their continuing influences in the East and West.

Suggested background: PY/RE 1731 and RE 2721.

This course will be offered in 2009-10 and in alternating years thereafter.

**RE/PY 2731. INTRODUCTORY ETHICS.***Cat. I*

This course will review at an introductory level theories of ethics, individual figures in the history of ethics, and selected problems in ethics. The emphasis will be on philosophical or religious ethics depending on the instructor.

**RE 3721. TOPICS IN RELIGION.***Cat. I*

The purpose of this course is to expose students to somewhat more advanced or specialized study in religion. The focus will vary, but the material will be drawn from a particular religious thinker, a particular religious tradition or a particular historical or contemporary problem.

Suggested background: three other courses in religion.

**RE/PY 3731. PROBLEMS IN ETHICS AND SOCIAL PHILOSOPHY.***Cat. I*

This course will examine in depth selected problems in ethical theory and social philosophy. The specific content or emphasis will be determined by the instructor.

Suggested background: knowledge of either RE/PY 2731 or PY 2712.

**RHETORIC (RH) AND WRITING (WR)****RH 3111. THE STUDY OF WRITING.***Cat. I*

This course introduces students to issues in the study of writing such as the history and uses of literacy, the relationship of thought to language, the role of writing in producing knowledge, and research on composing. The focus of the course will be on professional and academic writing. The course will be organized around a series of interrelated research questions: How do writers in professional and academic settings know when they have something to write about? How do they define a problem to investigate? How do they define or construct an audience to address? How do they locate their work in relation to others' work? How do they know which forms of writing to use? Why do they write in the first place? What functions does writing perform?

**RH 3112. RHETORICAL THEORY.***Cat. I*

Rhetoric concerns both the art of mastering the available means of persuasion and the study of how oral, written, and visual communication projects the intentions of individuals and groups, makes meanings, and affects audiences. The purpose of this course therefore is two-fold. It is intended to help students become more effective communicators by learning about the rhetorical situation and various rhetorical techniques. And it is designed to help them understand how various forms of communication work by learning some of the strategies of rhetorical analysis.

**RH 3211. RHETORIC OF VISUAL DESIGN.***Cat. I*

This course explores how visual design is used for purposes of identification, information, and persuasion. It looks at many modes of visual communication, such as icons, logos, trademarks, signs, product packaging, infographics, posters, billboards, ads, exhibits, graffiti, page layout, films, television, videogames, and web sites. The course provides an overview of the history of graphic design movements, as well as analytical tools to understand how visual design encodes messages and the role visual communication plays in contemporary culture.

**EN/WR 2210. INTRODUCTION TO PROFESSIONAL WRITING.***Cat. I*

This course will serve as a gateway into the Professional Writing major but will also be open—and useful—to any student interested in learning about the standard written genres of professional, workplace communication. Students will analyze the history, purposes, conventions, and social consequences of a variety of professional communication, focusing on digital and print correspondence, reports, and proposals directed to internal and external audiences. Students will learn about the culture of a professional environment and the role of writing in

structuring identity and relationships within that context. Classes will be conducted as interactive writing workshops in which students assess and respond to rhetorical scenarios and sample texts from a variety of professional worksites. Students will create portfolios, producing professional writing samples they may use on the job market.

#### **WR/EN 2211. ELEMENTS OF WRITING.**

##### *Cat. I*

This course is designed for students who wish to work intensively on their writing. The course will emphasize the processes of composing and revising, the rhetorical strategies of expository prose, and the interaction between writer and audience. In a workshop setting, students will write a sequence of short papers and complete one longer writing project, learn to read critically and respond helpfully to each other's writing, and make oral presentations from written texts.

#### **EN/WR 2213. INTRODUCTION TO JOURNALISM.**

The course is for students who may wish to make careers in journalism or communications and for those who wish to understand the history, function, production and contemporary challenges of print journalism. Students will analyze articles from newspapers, magazines and Web sites. They will learn and practice the skills of the journalist: finding the story, researching, interviewing, writing on deadline, copy-editing and proof-reading. Classes will also cover matters such as objectivity, fairness, ethics and libel, as well as wider issues of mass communication such as agenda setting, citizen journalism and the implications of converging media. To give students a more keen sense of audience, work will be read and discussed in class. Students will be urged to write for the college newspaper. Publication beyond the campus will be strongly encouraged.

#### **WR/EN 3011. PEER TUTORING IN WRITING.**

##### *Cat. I*

Peer Tutoring in Writing introduced students to the theory and practice of composition. In this course, students research, read, and write about their own and others' literacy practices. Through reading and writing assignments, peer reviews, interviews, presentations, and a tutoring internship in the CCAC, students hone their communication skills while increasing their ability to examine critically the role of communication in the production of knowledge.

#### **EN/WR 3210. TECHNICAL WRITING.**

##### *Cat. I*

Technical writing combines technical knowledge with writing skills to communicate technology to the world. This course introduces the fundamental principles of technical communication, and the tools commonly used in the technical writing profession. Topics include user and task analysis, information design, instructional writing, and usability testing. Students learn to use the technical writing process to create user-centered documents that combine text, graphics, and visual formatting to meet specific information needs. Students create a portfolio of both hardcopy and online documentation, using professional tools such as FrameMaker, Acrobat, and RoboHelp.

Recommended background: EN/WR 2210, or equivalent writing course.

#### **WR/EN 3214. WRITING ABOUT DISEASE AND PUBLIC HEALTH.**

##### *Cat. I*

This writing workshop focuses on the purposed and genres of writing about disease and public health. We will consider how biomedical writers communicate technical information about disease and public health to general audiences; how writers capture the human experience of disease and health care; how writers treat the public policy implications of disease; and how writers design publicity to promote public health. We will examine such genres as the experimental article, news reports, medical advice, profiles, commentary, and public health messages.

Recommended background: EN 2211 or equivalent writing courses.

Students who have taken EN 3215 may not receive credit also for WR/EN 3214.

#### **WR/EN 3217. CREATIVE WRITING.**

##### *Cat. I*

The purpose of this course is to help students develop or improve the skills of written expression. Small groups are formed in which participants present and discuss their original work in either fiction or poetry.SPANISH (SP)

## **SPANISH (SP)**

#### **SP 1523. ELEMENTARY SPANISH I.**

##### *Cat. I*

A very intensive course that will introduce the student to the basic grammar of Spanish, emphasizing the four language skills: listening, speaking, reading and writing. It will also introduce the student to different aspects of Hispanic cultures in the U.S. and in Spanish-speaking countries. Students who have taken Spanish in high school are urged to take a placement exam before enrolling in either level of Elementary Spanish. See the instructor.

#### **SP 1524. ELEMENTARY SPANISH II.**

##### *Cat. I*

A continuation of Elementary Spanish I.  
Recommended background: SP 1523.

#### **SP 2521. INTERMEDIATE SPANISH I.**

##### *Cat. I*

A course designed to allow students to improve their written and oral skills, expand their vocabulary and review some important grammatical structures. Students will also read short stories and poems by some of the most representative Spanish American and Spanish authors, such as Horacio Quiroga, Jorge Luis Borges, Gabriela Mistral and Ana María Matute.

Recommended background: Elementary Spanish II.

#### **SP 2522. INTERMEDIATE SPANISH II.**

##### *Cat. I*

A continuation of Intermediate Spanish I.  
Recommended background: SP 2521.

#### **SP 3521. ADVANCED SPANISH I.**

##### *Cat. I*

A course that continues to improve student's language skills while deepening their understanding of Hispanic cultures. Some of the topics studied are: the origins of Hispanic cultures in Spain and Spanish America; family; men and women in Hispanic societies; education; religion.

Recommended background: Intermediate Spanish II.

#### **SP 3522. ADVANCED SPANISH II.**

##### *Cat. I*

A continuation of Advanced Spanish I.  
Recommended background: SP 3521.

#### **SP 3523. TOPICS IN LATIN AMERICAN CULTURE.**

##### *Cat. II*

An introduction to various aspects of life in Latin American countries from early times to the present. Focusing on the social and political development of Latin America, the course will reveal the unity and diversity that characterize contemporary Latin American culture. Typical topics for study include: the precolumbian civilizations and their cultural legacy; the conquistadores and the colonial period; the independence movements; the search for and the definition of an American identity; the twentieth-century dictatorships; and the move toward democracy.

Recommended background: SP 3521 (Advanced Spanish I) and SP 3522 (Advanced Spanish II) or equivalent.

This course will be offered in 2008-09 and in alternating years thereafter.

#### **SP 3524. SPANISH-AMERICAN LITERATURE IN THE TWENTIETH CENTURY.**

##### *Cat. II*

This course, taught in the Spanish language, focuses on the major literary movements in Spanish America, from the "Modernista" movement at the turn of the century to the Latin American "Boom" of the 1960s to the political literature of the '70s and '80s. The work of representative authors, such as Rubén Darío, Julio Cortázar, Rosario Castellanos, Elena Poniatowska, will be discussed.

Recommended background: SP 3521 (Advanced Spanish I) and SP 3522 (Advanced Spanish II) or equivalent.

This course will be offered in 2009-10 and in alternating years thereafter.

#### **SP/ID 3525. SPANISH AMERICAN FILM/MEDIA: CULTURAL ISSUES.**

##### *Cat. II*

Through Latin American and Caribbean films, and other media sources, this course studies images, topics, and cultural and historical issues related to modern Latin American and the Caribbean. Within the context and influence of the New Latin American Cinema and/or within the context of the World Wide Web, radio, newspapers, and television the course teaches students to recognize cinematographic or media strategies of persuasion, and to understand the images and symbols utilized in the development of a national/regional identity. Among



the topics to be studied are: immigration, gender issues, national identity, political issues, and cultural hegemonies.

Taught in advanced level Spanish. May be used toward foreign language Sufficiency, Minor, or Major.

Recommended Background: SP 2521 and SP 2522, and SP 3523.

This course will be offered in 2009-10 and in alternating years thereafter.

#### SP/ID 3526. COMPARATIVE BUSINESS ENVIRONMENTS.

*Cat. II*

The basis of this course is a comparative study and analysis of specific Latin American and Caribbean business practices and environments, and the customs informing those practices. SP/ID 3526 focuses on countries such as Mexico, Argentina, Chile, Puerto Rico, and Costa Rica. The course's main objective is to study communication strategies, business protocol, and negotiation practices in the countries mentioned above. Through oral presentations and written essays, students will have the opportunity to explore other countries in Latin America and the Caribbean.

Taught in advanced level Spanish. May be used toward foreign language Sufficiency, Minor, or Major.

Recommended Background: SP 2521 and SP 2522.

This course will be offered in 2008-09 and in alternating years thereafter.

#### SP/ID 3527. TECHNICAL AND BUSINESS SPANISH.

*Cat. II*

The course focuses on the linguistic concepts, terminology, and grammar involved in business and technical Spanish. Students will be required to produce and edit business documents such as letters, job applications, formal oral and written reports, etc. The objective of this course is to help students develop the basic written and oral communication skills to function in a business environment in Latin America and the Caribbean.

Recommended background: SP 2521 and SP 2522.

This course will be offered in 2009-10 and in alternating years thereafter.

#### SP 3528. SPANISH CULTURE AND CIVILIZATION.

*Cat. II*

This course is an introduction to various aspects of life in Spain, from early times to the present. The main focus is on Spain's social, political, and cultural development and its experience of diversity within its European context. Typical topics for study include: The Reconquista and the Arab influence in Spanish culture, the Spanish monarchy, its evolution into a democracy, the development of modern politics, the importance of the Spanish Civil war, and the influence of writers (such as Federico García Lorca), painters (such as Pablo Picasso), and art in general in modern Spanish culture. This course is taught in Spanish.

Recommended background: SP3521 (Advanced Spanish I) and SP 3522 (Advanced Spanish II) or equivalent.

This course will be offered in 2009-10 and in alternating years thereafter.

#### SP/ID 3529. CARIBBEANNESS: VOICES OF THE SPANISH CARIBBEAN.

*Cat. II*

A survey of Caribbean literature and arts that takes a multimedia approach to examining the different voices that resonate from the Spanish Caribbean and what appears to be a constant search for identity. By studying the works of major authors, films, music and the plastic arts, we will examine the socio-cultural context and traditions of this region in constant search for self-definition. Special attention will be given to the influential role ethnicity, colonialism, gender and socio-economic development play in the interpretation of works from Puerto Rico, Cuba, the Dominican Republic, Colombia and Venezuela as well as those of the Caribbean diaspora. This course is taught in Spanish.

Recommended background: SP3521 (Advanced Spanish I) and SP 3522 (Advanced Spanish II) or equivalent.

This course will be offered in 2008-09 and in alternating years thereafter.

#### SP/ID 3530. SPANISH FILM/MEDIA: CULTURAL ISSUES.

*Cat. II*

Through Spanish films, and other media sources, this course studies images, topics, and cultural and historical issues that have had an impact in the creation of a modern Spanish nation. This course focuses on current political and ideological issues (after 1936), the importance of Spanish Civil war, gender identity, and class, cultural and power relationships. This course is taught in Spanish.

This course will be offered in 2008-09 and in alternating years thereafter.

#### SP/ID 3531. CONTEMPORARY US LATINO LITERATURE & CULTURE.

*Cat. II*

This course introduces students to the field of Latino studies, paying particular attention to the cultural productions of U.S. Latinos in film, theater, music, fiction writing and cultural criticism. At the same time that this course reflects upon a transnational framework for understanding the continuum between U.S. Latinos and Latin American/Caribbean communities, we closely examine more U.S. based arguments supporting and contesting the use of Latino as an ethnic-

racial term uniting all U.S. Latino communities. We examine the ways in which U.S. Latinos have manufactured identities within dominant as well as counter cultural registers. In this course, special attention is given to the aesthetics of autobiography and to how Latino writers experiment with this genre in order to address changing constructions of immigration, language, exile, and identity. This course is taught in English.

This course will be taught in 2008-09 and in alternating years thereafter.

## INTERACTIVE MEDIA AND GAME DEVELOPMENT

#### IMGD 1000. CRITICAL STUDIES OF INTERACTIVE MEDIA AND GAMES.

*Cat. I*

This course introduces non-technical studies of computer-based interactive media and games. The course develops a vocabulary for discussing games and other interactive media, and tools for analyzing them. Students are expected to provide written critiques using the critical approaches presented in the course. The games and other interactive media critiqued may be commercially available or under development.

#### IMGD 1001. THE GAME DEVELOPMENT PROCESS.

*Cat. I*

This course discusses the process of game development. It examines the roles of different participants in the development process and how the technical development and the artistic development proceed in tandem. Group work is emphasized, especially the importance of collaboration between technical and artistic efforts. Students are expected to participate in game development using appropriate game development tools.

#### IMGD 1002. STORYTELLING IN INTERACTIVE MEDIA AND GAMES.

*Cat. I*

This course explores different types of story within gaming and other interactive media. It delineates between linear, branching, and emergent storytelling, identifies hybrids, and finds new modes of making compelling narrative. A variety of games are discussed, including early text-based adventures, role-playing games, shooters, and strategy games. Students will construct characters, situations, and narratives through game play and scripted cut scenes. Students will explore and use visual storytelling techniques.

#### IMGD 2000. SOCIAL ISSUES IN INTERACTIVE MEDIA AND GAMES.

*Cat. II*

This course provides students with a realistic assessment of the potential and problems related to interactive media and games, especially computer games, and their effects on society. Topics include individual and group behavior, diversity, human responsibility, ethical and legal issues, and intellectual property. The course examines the issues from various points of view, and discover the political, social, and economic agendas of the people or groups championing those points of view. Students will write papers, participate in discussions, and research related topics.

Recommended background: IMGD 1000.

Offered in 2008-09 and in alternating years thereafter.

#### IMGD 2001. PHILOSOPHY AND ETHICS OF COMPUTER GAMES.

*Cat. II*

This course introduces students to some of the political and ethical dimensions of the new entertainment modalities. Students will explore such issues as representation and power (e.g., gaming and disability, and race stereotyping in games), the phenomenology of virtual reality, capitalism and the commodification of leisure, gender and sexual violence, and cyberspace and democracy. Students will also develop critical tools for evaluating the ethical and social content of their own and others' games. In addition to writing several analytical papers on the critical theory of technology, students will be encouraged to work on game designs exploring philosophical or social themes.

Recommended background: IMGD 1000.

Offered in 2009-10 and in alternating years thereafter.

#### IMGD 2005. MACHINIMA (FILM MAKING IN VIRTUAL ENVIRONMENTS).

*Cat. I*

This course will address the cinematographic and narrative techniques involved with film making using video-game technology. Creation and development of characters, environments, and narrative structures will be explored. Using commercial game engines and audio/video editors, students will write, design, and produce complete animated movies. Industrial and artistic applications of this film making technique are discussed as well as how Machinima is contextualized in the history of film animation and visualization.

Recommended background: IMGD 1002.



**IMGD 3000. TECHNICAL GAME DEVELOPMENT I.***Cat. I*

This course teaches technical Computer Science aspects of game development, with the focus of the course on low-level programming of a computer games. Topics include 2D and 3D game engines, simulation-type games, analog and digital controllers and other forms of tertiary input. Students will implement games or parts of games, including exploration of graphics, sound, and music as it affects game implementation.

Recommended background: CS 2303.

**IMGD 3500. ARTISTIC GAME DEVELOPMENT I.***Cat. I*

This course focuses on the unique problems presented to the artist when working in game development. Students learn to work with 2D sprite-based art, including tiling and simple animation. They then explore 3D architecture, level design, texturing, and environmental animation. Students will use art to create compelling game experiences through environments by designing their own levels in both 2D and 3D games.

Recommended background: AR 3000.

**IMGD 4000. TECHNICAL GAME DEVELOPMENT II.***Cat. I*

This course focuses on the application of advanced Computer Science topics as they impact game development. Networking and distributed systems issues are addressed, including scalability and latency compensation techniques, for designing games for a online multi-player environments. AI, graphics and physics techniques specific to game development are discussed. Students will implement games or parts of games that apply advanced Computer Science topics.

Recommended background: IMGD 3000.

**IMGD 4500. ARTISTIC GAME DEVELOPMENT II.***Cat. I*

This course focuses on the integration and organization of the various artistic elements used in game development. The course examines user interaction, interface design, and existing paradigms in current games. Students will combine elements of level design, animation, music, sound, and writing to create an aesthetically appealing game.

Recommended background: IMGD 1002, IMGD 3500, MU 1611.

---

## INTERDISCIPLINARY

---

**ID/SS 2050. SOCIAL SCIENCE RESEARCH FOR THE IQP.***Cat. I*

This course is open to students accepted to off-campus IQP centers and programs. The course introduces students to research design, methods for social science research, and analysis. It also provides practice in specific research and field skills using the project topics students have selected in conjunction with sponsoring agencies. Students learn to develop social science hypotheses based upon literature reviews in their topic areas and apply concepts drawn from social psychology, anthropology, sociology, economics and other areas as appropriate. Students make presentations, write an organized project proposal, and develop a communication model for reporting their project findings.

**ID 3100. TEACHING METHODS IN MATHEMATICS AND SCIENCE.***Cat. II*

Within the context of contemporary secondary education in mathematics and science (biology, chemistry, physics), ID 3100 introduces and demonstrates effective teaching methods as they relate to curriculum goals and current methods of assessment. These methods take into account diverse learning styles as well as various technological resources. Topics to be covered include: a brief history of education; curriculum and course guidelines (Massachusetts Education Reform and regulations 603 CMR 7.00, state curricular frameworks, national standards); legal issues; developing a course syllabus; and the issue of breadth versus depth in course planning and delivery. The course also covers practical questions of organizing, delivering and assessing a course. This course is intended primarily for students interested in completing the Massachusetts requirements for teacher licensing. (See [www.wpi.edu/~goulet/teacher\\_prep](http://www.wpi.edu/~goulet/teacher_prep)). This program is aimed primarily at majors in mathematics, physics, chemistry and biology wishing to be licensed to teach in middle or high school in one of those disciplines. A portion of the course requires the observation of master teachers at the Massachusetts Academy of Mathematics and Science, who will work with all students in the course to assist them in beginning to acquire the appropriate skills to conduct their own classes in mathematics or science at the secondary school level.

Recommended background: SS 2401, Psychology of Education.

This course will be offered in 2008-09 and in alternating years thereafter.

**ID/AR 3150. LIGHT, VISION AND UNDERSTANDING.***Cat. II*

By using material from the sciences and the humanities this course examines the ways in which ideas of knowledge and of human nature have been fashioned. The specific topics include physical theories about light, biological and psychological theories of visual perception, and artistic theories and practices concerned with representation. The mixing of material from different academic disciplines is deliberate, and meant to counter the notion that human pursuits are "naturally" arranged in the neat packages found in the modern university. The course draws upon the physical and social sciences, and the humanities, to examine how those fields relate to one another, and how they produce knowledge and self-knowledge. Cultural as well as disciplinary factors are assessed in this process.

Light, Vision and Understanding is conducted as a seminar. The diverse collection of reading materials includes a number of primary texts in different fields. In addition, the students keep a journal in which they record the results of numerous individual observations and experiments concerning light and visual perception. The course can fit into several Sufficiency areas as well as serve as a starting point for an IQP. There are no specific requirements for this course, although some knowledge of college-level physics, as well an acquaintance with the visual arts, is helpful.

This course will be offered in 2008-09 and in alternating years thereafter.

**ID/GN 3515. TECHNICAL TOPICS IN GERMAN.***Cat. II*

Technical topics are addressed and discussed entirely in German. German-speaking faculty from several WPI science and engineering departments, as well as lecturers from outside the university, present a range of topics at an introductory level. The focus of the course is on the use and development of German language skills in a technical context, which will include lectures, presentations, discussions, problem solving, and writing on technical topics. The course can be counted towards a Sufficiency or a minor in German. As the course is to be conducted entirely in German, knowledge of German sufficient for advanced conversations and detailed writing (such as students acquire in GN 3512, Advanced German II, or equivalent) is strongly recommended.

This course will be offered in 2008-09 and in alternating years thereafter.

**ID/SP 3525. SPANISH AMERICAN FILM/MEDIA: CULTURAL ISSUES.***Cat. II*

Through Latin American and Caribbean films, and other media sources, this course studies images, topics, and cultural and historical issues related to modern Latin American and the Caribbean. Within the context and influence of the New Latin American Cinema and/or within the context of the World Wide Web, radio, newspapers, and television the course teaches students to recognize cinematographic or media strategies of persuasion, and to understand the images and symbols utilized in the development of a national/regional identity. Among the topics to be studied are: immigration, gender issues, national identity, political issues, and cultural hegemonies.

Taught in advanced level Spanish. May be used toward foreign language Sufficiency, Minor, or Major.

Recommended Background: SP 2521 and SP 2522, and SP 3523.

This course will be offered in 2009-10 and in alternating years thereafter.

**ID/SP 3526. COMPARATIVE BUSINESS ENVIRONMENTS.***Cat. II*

The basis of this course is a comparative study and analysis of specific Latin American and Caribbean business practices and environments, and the customs informing those practices. ID/SP 3526 focuses on countries such as Mexico, Argentina, Chile, Puerto Rico, and Costa Rica. The course's main objective is to study communication strategies, business protocol, and negotiation practices in the countries mentioned above. Through oral presentations and written essays, students will have the opportunity to explore other countries in Latin America and the Caribbean.

Taught in advanced level Spanish. May be used toward foreign language Sufficiency, Minor, or Major.

Recommended Background: SP 2521 and SP 2522.

This course will be offered in 2008-09 and in alternating years thereafter.

**ID/SP 3527. TECHNICAL AND BUSINESS SPANISH.***Cat. II*

The course focuses on the linguistic concepts, terminology, and grammar involved in business and technical Spanish. Students will be required to produce and edit business documents such as letters, job applications, formal oral and written reports, etc. The objective of this course is to help students develop the basic written and oral communication skills to function in a business environment in Latin America and the Caribbean.

Recommended background: SP 2521 and SP 2522.

This course will be offered in 2008-09 and in alternating years thereafter.

**ID/SP 3529. CARIBBEANNESS: VOICES OF THE SPANISH CARIBBEAN.***Cat II*

A survey of Caribbean literature and arts that takes a multimedia approach to examining the different voices that resonate from the Spanish Caribbean and what appears to be a constant search for identity. By studying the works of major authors, films, music and the plastic arts, we will examine the socio-cultural context and traditions of this region in constant search for self-definition. Special attention will be given to the influential role ethnicity, colonialism, gender and socio-economic development play in the interpretation of works from Puerto Rico, Cuba, the Dominican Republic, Colombia and Venezuela as well as those of the Caribbean diaspora. This course is taught in Spanish.

Recommended background: SP3521 (Advanced Spanish I) and SP 3522 (Advanced Spanish II) or equivalent.

This course will be offered in 2008-09 and in alternating years thereafter.

**ID/SP 3530. SPANISH FILM/MEDIA: CULTURAL ISSUES.***Cat II*

Through Spanish films, and other media sources, this course studies images, topics, and cultural and historical issues that have had an impact in the creation of a modern Spanish nation. This course focuses on current political and ideological issues (after 1936), the importance of Spanish Civil war, gender identity, and class, cultural and power relationships. This course is taught in Spanish.

This course will be offered in 2008-09 and in alternating years thereafter.

**ID/SP 3531. CONTEMPORARY US LATINO LITERATURE & CULTURE.***Cat II*

This course introduces students to the field of Latino studies, paying particular attention to the cultural productions of U.S. Latinos in film, theater, music, fiction writing and cultural criticism. At the same time that this course reflects upon a transnational framework for understanding the continuum between U.S. Latinos and Latin American/Caribbean communities, we closely examine more U.S. based arguments supporting and contesting the use of Latino as an ethnic-racial term uniting all U.S. Latino communities. We examine the ways in which U.S. Latinos have manufactured identities within dominant as well as counter cultural registers. In this course, special attention is given to the aesthetics of autobiography and to how Latino writers experiment with this genre in order to address changing constructions of immigration, language, exile, and identity. This course is taught in English.

This course will be taught in 2008-09 and in alternating years thereafter.

## MANAGEMENT

### ACCOUNTING (ACC)

**ACC 1100. FINANCIAL ACCOUNTING.***(formerly MG 1100)**Cat. I*

This course provides a tool for business communication, as accounting is an important language of business. Students are introduced to the accounting process, its underlying concepts, and the techniques of preparing and analyzing financial statements. Students are also introduced to issues in accounting for assets, liabilities, and stockholders' equity. The course demonstrates the employment of accounting data by users outside the firm, and the application of accounting numbers in financial analyses and market decisions.

Students may not receive credit for both MG 1100 and ACC 1100.

**ACC 2101. MANAGEMENT ACCOUNTING.***(formerly MG 2101)**Cat. I*

This course is intended to familiarize the student with the wide variety of ways in which accounting data are used by management as a tool for the attainment of predetermined organizational objectives. The emphasis of the course is on the application of accounting data, rather than on its preparation, and particular attention is given to the use of financial data both in controlling day-to-day activities and planning future operations. Principal topics include: master budgets, cost analysis and classification systems, cost-volume-profit analysis, standard cost accounting and an introduction to capital budgeting.

Recommended background: ACC 1100.

Students may not receive credit for both MG 2101 and ACC 2101

**ACC 4151. COST ACCOUNTING.***(formerly MG 4151)**Cat. II*

This course is designed to give basic understanding and skill in the area of cost accumulation to anyone concerned with recording the expenses associated with a given activity or project. Cost accounting provides data for three major purposes: 1) planning and controlling routine operations, 2) making non-routine decisions, and 3) inventory valuation and income determination. All three are important, but the course stresses the first two as they relate to project activity. The goal of the course is to put cost accounting in focus as a highly useful technique in any decision-making situation where expense levels are important. While some attention is directed toward accounting systems and procedures for data accumulation, stress is given to the theme that cost accounting is a vital and dynamic tool for problem-solving.

Recommended background: ACC 1100.

Students may not receive credit for both MG 4151 and ACC 4151.

This course will be offered in 2009-10 and in alternating years thereafter.

## BUSINESS (BUS)

**BUS 1900. INTRODUCTION TO BUSINESS IN AN INTERNATIONAL ENVIRONMENT.***(formerly MG 1900)**Cat. I*

This course focuses on the operation of a company conducting business in an international environment. It addresses cultural differences and their importance in international trade and in such business functions as operations, human resources, marketing and accounting. BUS 1900 is an appropriate course for all WPI students regardless of a major.

Students may receive credit for only one of the following: MG 1050, MG 1900 and BUS 1900.

**BUS 2950. BUSINESS LAW AND ETHICS.***(formerly MG 2950)**Cat. I*

Imparts an understanding of how law, ethics, and public policy affect modern business. Approximately two thirds of the term is devoted to coverage of fundamental substantive areas of business law (torts, contracts, property, business organizations), public policies (regulatory and promotional), and approaches to ethical analysis for decision-making. Particular attention is paid to technology-based enterprises (e.g. intellectual property, environmental regulation). The concluding portion of the course involves all students in examination of current cases in which law, ethics and human, societal and global concerns intersect with business decision-making today.

Students may not receive credit for both MG 2950 and BUS 2950.

## ENTREPRENEURSHIP (ETR)

**ETR 3633. ENTREPRENEURIAL SELLING.***Cat. I*

Selling is a major part of business life, but it is especially important for those who are launching a new venture. They need to sell their business plan to potential investors. Later they need to sell their product or service to a customer. Ultimately they need to create an organization that is focused on meeting customer and other stakeholder needs through effective selling disciplines. This course will examine the elements of the sales cycle in terms of preparation, market research, prospecting, objection handling, closing, techniques for motivating the sales professional and formulation of strategy for the successful selling transaction. As part of the course students will be required to prepare individual sales presentations, one to secure investment for a new venture and one to sell a product or service to a customer. Guest speakers may be used on topics such as sales coaching, inside sales management, and to deliver sales effectiveness training.

Credit may not be earned for both ETR 363X and ETR 3633.

**ETR 3910. RECOGNIZING AND EVALUATING NEW VENTURE OPPORTUNITIES.***(formerly MG 3910)**Cat. I*

This course focuses on identifying ideas for new businesses and learning how to evaluate those ideas to determine if they are feasible. Using various opportunity recognition models, students will be expected to come up with a business idea and conduct an analysis of the feasibility of the venture and its fit with the founder.

Recommended background for this course consists of OIE 2850 and two of the following: ACC 1100, BUS 2950, OIE 3400, MKT 3600, or MIS 3700.

Students may receive credit for only one of the following: MG 391X, MG 3910 or ETR 3910.

**ETR 3920. PLANNING AND LAUNCHING NEW VENTURES.**  
(formerly MG 3920)

*Cat. I*

This course focuses on business plan development, especially the financial aspects of the plan. The intent is that students will use a feasibility analysis, such as the one completed in ETR 3910, and turn that into a complete business plan. Additionally, students will learn about seed capital, venture, and other means of financing new ventures.

Recommended background for this course consists of ETR 3910, OIE 2850 and two of the following: ACC 1100, BUS 2950, OIE 3400, MKT 3600, or MIS 3700.

Students may receive credit for only one of the following: ID 1050, MG 3920, or ETR 3920.

**ETR 4930. GROWING AND MANAGING NEW VENTURES.**  
(formerly MG 4930)

*Cat. I*

One of the most troublesome aspects of entrepreneurship is running the business once it is started. This course focuses on techniques to grow the new venture and how to manage both the growth and operations. Considerable emphasis will be placed on expanding existing markets, finding new markets, anticipating the next generation of products, and managing cash flow. This course is the capstone course for both the Entrepreneurship Minor and the Management Minor.

Recommended background for this course consists of five of the following: ACC 1100, ACC 2101, BUS 1900, BUS 2950, ETR 3910, ETR 3920, MIS 3700, MKT 3600, OBC 2300, OIE 2850, OIE 3400.

Students may receive credit for only one of the following: MG 3960, MG 4930, or ETR 4930.

---

## FINANCE (FIN)

**FIN 1250. PERSONAL FINANCE.**  
(formerly MG 1250)

*Cat. I*

This course is designed to help the student make well-informed judgments when faced with personal financial decisions. Such decisions are growing in number and complexity, and both individuals and families need a considerable degree of financial expertise in order to utilize optimally their limited incomes. Principal topics include: insurance (medical, life, automobile and disability), consumer credit, estate planning, taxation, personal investments (real estate, securities, etc.), social security legislation and personal financial planning.

Students may not receive credit for both MG 1250 and FIN 1250.

Students majoring in MG, MGE, or MIS may not receive credit for both FIN 1250 and FIN 2200.

**FIN 2200. FINANCIAL MANAGEMENT.**  
(formerly MG 2200)

*Cat. I*

The financial and competitive status of a company at any given point in time can usually be attributed to prior management decisions. In this course, the student will learn how to use several financial models that together, serve as a sound theoretical framework for analyzing the three types of financial decisions faced by the financial manager. These are 1. investing decisions, 2. financing decisions, and 3. working capital management decisions. The impact of managerial decisions on the financial statements is emphasized. In addition, ethical conduct and global issues relating to the core concepts in the course are explored.

Recommended background: ACC 1100 and MA 2611.

Students may receive credit for only one of the following: MG/IE 2200, MG 2200, or FIN 2200. Students majoring in MG, MGE, or MIS may not receive credit for both FIN 1250 and FIN 2200.

**FIN 2250. FINANCIAL SYSTEM OF THE UNITED STATES.**  
(formerly MG 2250)

*Cat. I*

An analysis of how the financial system of the United States has developed and contributes to the achievement of broad national economic goals as high national income, satisfactory economic growth, stable prices, and equilibrium in balance of payments with other countries. Emphasis is placed on the theory of the supply and demand for short-term money and long-term capital, and the resultant effect on interest rates. Primary concentration on the sources and uses

of funds of the major non-bank financial institutions, such as insurance companies, pension funds, mutual funds, finance companies, savings and loan banks and mutual savings banks. A discussion of the reforms of financial institutions, and of money and capital markets to more efficiently allocate the scarce resources of the country. This course is intended to serve the business major and other students interested in understanding the role of financial intermediaries in the United States economy.

Suggested background: some knowledge of accounting and economics will be helpful in taking this course.

Students may not receive credit for both MG 2250 and FIN 2250.

**FIN 2260. INVESTMENT AND SECURITY ANALYSIS.**  
(formerly MG 2260)

*Cat. I*

This course is designed to provide an introduction to the language and methodology of security analysis. It is intended to serve two different groups of students: those interested in the subject from the viewpoint of intelligent management of their own portfolios, and those students who have a possible career interest in some facet of the securities industry. Principal topics include: institutional structure and language of the securities market; investment research; alternative investment opportunities; financial statement analysis; fundamental evaluation of common stocks, preferred stocks and bonds; technical analysis; and business cycle analysis.

Recommended background: ACC 1100 and SS 1120.

Students may not receive credit for both MG 2260 and FIN 2260.

---

## MANAGEMENT INFORMATION SYSTEMS (MIS)

**MIS 3700. INFORMATION SYSTEMS MANAGEMENT.**  
(formerly MG 3700)

*Cat. I*

This course introduces students to the management of information technology within complex organizations. It covers the range of information technologies employed by business organizations and the manner in which they are deployed. The course places special emphasis on the management of information resources from a user and manager point of view and will help students understand how particular technological arrangements can facilitate achievement of organizational goals. The impact of information technology on management control, organizational structure, individual workers, relationships between organizations, and business transformational will be discussed.

Recommended background: ACC 2101 and OBC 2300 or equivalent business background.

Students may receive credit for only one of the following: MG 2700, MG 3700, or MIS 3700.

**MIS 3720. BUSINESS DATA MANAGEMENT.**  
(formerly MG/IE 3720)

*Cat. I*

This course introduces students to the theory and practice of database management and the application of database software to implement business information systems that support managerial and operational decision making. Special topics covered include relational data models, query languages, normalization, locking, concurrency control and recovery. The course covers data administration and the design of data tables for computerized databases. Students will use a commercial database package to design and implement a small business database application.

Recommended background: CS 2118 or equivalent knowledge.

Students may receive credit for only one of the following: MG 4700, MG 3720, or MIS 3720.

**MIS 3740. ORGANIZATIONAL APPLICATIONS OF TELECOMMUNICATIONS.**  
(formerly MG 3740)

*Cat. I*

Students taking this course will develop an understanding of how organizations can effectively use telecommunications technology to enhance business functionality. Students will analyze the development of organizational communications infrastructures and their use for the development of "virtual" organizational structures and to support globally-distributed organizations. The course will begin with a survey of the concepts and technologies which form the basis of a business telecommunications system and which allow the merging of voice, data and video in an integrated multimedia communications structures.

Recommended background: MIS 3700.

Students may receive credit for only one of the following: MG 4701, MG 3740, MG/IE 3740, or MIS 3740.



**MIS 4720. SYSTEMS ANALYSIS AND DESIGN.***(formerly MG/IE 4720)**Cat. I*

This course integrates students' background in MIS in a one-term project focusing on development of creative solutions to open-ended business and manufacturing problems. The project will utilize systems analysis and design tools such as systems development life cycle, feasibility study, cost-benefit analysis, structured analysis and design. Students will acquire the skills necessary to analyze, develop, implement, and document real-life information systems. Students must be able to organize themselves and the project to complete their work within a seven week term. It is recommended that MIS majors take this course in preparation for their MQP.

Recommended background: MIS 3720.

Students may receive credit for only one of the following: MG 3750, MG 4720, or MIS 4720.

**MIS 4740. E-BUSINESS STRATEGY, ARCHITECTURE AND DESIGN.***(formerly MG/IE 4740)**Cat. II*

The course focuses on the linkage between organizational strategy and networked information techniques to implement a rich variety of business models in the national and global contexts connecting individuals, businesses, governments, and other organizations to each other. It provides an introduction to e-business strategy and the development and architecture of e-business solutions and their technical components. The course will cover how businesses and consumers use the Internet to exchange information and initiate transactions. Both theoretical concepts and practical skills with appropriate development tools will be addressed within the scope of the class. Students will develop a business plan and put that plan into action through development of an e-business website using commercially available development tools.

Recommended background: CS 1101, CS 1102 or CS 2118 or ability to program in a higher level programming language.

This course will be offered 2008-09 and in alternating years thereafter.

**MIS 4781. INFORMATION SYSTEMS AND TECHNOLOGY POLICY AND STRATEGY.***Cat. II*

A successful MIS manager must keep up with the fast-paced changes in technology, apply technology when appropriate, and understand the implications technology has on employees and an organization as a whole. S/he must understand both the internal (e.g., political and organizational culture) and external (e.g., laws, global concerns, and cultural issues) environments. The core MIS capabilities of business and information technology (IT) vision, design of IT architecture, and IT service delivery also need to be understood by effective MIS managers.

Recommended Background: MIS3700, MIS3720, MIS4720

This course will be offered in 2009-10, and in alternating years thereafter.

**MARKETING (MKT)****MKT 3600. MARKETING MANAGEMENT.***(formerly MG/IE 3600)**Cat. I*

This class is designed to give students a broad overview of diverse topics in marketing management. After this class, students should have a solid understanding of the main concepts and principles of marketing, and be able to apply them to actual business situations. The course demonstrates the application of various social science concepts and methodologies in the marketing context. Topics include: The Marketing Environment, International Marketing, Market Research, Consumer Behavior, Business-to-Business Marketing, Services Marketing, Market Segmentation, New Product Development, Channels, Marketing Communications, Personal Selling, and Pricing.

Students may not receive credit for both MG 3600 and MKT 3600.

**MKT 3640. MANAGEMENT OF PROCESS AND PRODUCT INNOVATION.***(formerly MG/IE 3640)**Cat. I*

This course is based on the hypothesis that high performance firms depend on a sustainable pattern of new and innovative processes and products. Successful companies are examined in regard to their strategies for innovation and technology transfer. Technology alliances among industry, universities, and government are considered in order to increase the leverage of the individual firm. Benchmarking and commercialization from research to actualization is discussed through cases and examples.

Recommended background: FIN 2200 or OIE 2850.

Students may receive credit for only one of the following: MG 3440, MG 3640, or MKT 3640.

**MKT 3651. INDUSTRIAL MARKETING.***(formerly MG/IE 3651)**Cat. II*

Provides an understanding of the industrial marketing process and practices. It presents the latest concepts, tools and techniques for marketing complex products and services to industrial and institutional users. Topics include: product innovation strategies; purchasing management and buyer behavior; major intelligence; pricing strategies and tactics; developing markets for new industrial products; bid proposals; industrial distribution; managing the industrial sales force; marketing controls.

Students may not receive credit for both MG 3651 and MKT 3651.

This course will be offered in 2008-09 and in alternating years thereafter.

**OPERATIONS AND INDUSTRIAL ENGINEERING (OIE)****OIE 2500. MANAGEMENT SCIENCE I: DETERMINISTIC DECISION MODELS.***(formerly MG/IE 2500)**Cat. I*

This course is designed to provide an introduction to a variety of tools and techniques found useful by modern industrial engineers, operations researchers and managers. These tools are oriented toward the creation and use of mathematical models to assist in managerial decision making in business and other organizations. The models discussed in this course deal with deterministic decision-making problems where there are constraints on available actions. Discussion centers on "classical" methods of optimization and basic methods of linear programming. It is expected that the student will develop an ability to recognize situations in which a given technique is appropriate.

Recommended background: knowledge of calculus.

Students may receive credit for only one of the following: MG 2500, IE 2500, or OIE 2500.

**OIE 2850. ENGINEERING ECONOMICS.***(formerly MG/IE 2850)**Cat. I*

To aid all engineering students in understanding economics and business constraints on engineering decision making. Topics include evaluation of alternative; the six time-value-of-money factors; present worth, annual cash flow and rate-of-return analysis; incremental analysis; depreciation and income taxes; replacement analysis; inflation; handling probabilistic events; public economy; break-even and minimum cost points; and foreign exchange.

Students may receive credit for only one of the following: MG 2850, IE 2850, or OIE 2850. Students may not receive credit for both OIE 2850 and FIN 2200.

**OIE 3400. PRODUCTION SYSTEM DESIGN.***(formerly MG/IE 3400)**Cat. I*

This course is an introduction to the planning, analysis and design of production systems. It is designed for students in engineering or management who may wish to assume responsibilities in the production of goods or services. Topics to be covered will include: operations strategy, project management, quality management, process analysis, capacity management, and just-in-time and lean systems.

Recommended background: Differential and integral calculus.

Students may receive credit for only one of the following: MG 3400, IE 3400, or OIE 3400.

**OIE 3401. PRODUCTION PLANNING AND CONTROL.***(formerly MG/IE 3401)**Cat. I*

This course is an introduction to the planning and control of production systems. Topics include: forecasting, scheduling, material management, and statistical process control.

Recommended background: OIE 3400, MA 2611, and differential and integral calculus.

Students may receive credit for only one of the following: MG 3401, IE 3401, or OIE 3401.

**OIE 3405. WORK SYSTEMS AND FACILITIES PLANNING.***(formerly MG/IE 3405)**Cat. I*

This course covers the fundamentals of developing efficient layouts for production and service facilities. Methods analysis, work measurement, material handling and material flow analysis are also covered. Mathematical models and computer tools are used to assist decision-making.

Recommended background: OIE 2500 and OIE 3400.

**OIE 3420. QUALITY PLANNING, DESIGN AND CONTROL.***(formerly MG/IE 3420)**Cat. I*

This course focuses on the quality aspects of product design and manufacturing. Topics include: the quality/cost relationship, statistical process control, process capability studies, and design of experiments.

Recommended background: OIE 3400 and MA 2612 or consent of the instructor.

Students may receive credit for only one of the following: MG 3420, IE 3420, or OIE 3420.

**OIE 3450. HUMAN FACTORS ENGINEERING.***(formerly MG/IE 3450)**Cat. I*

This course examines the human-machine interface in the workplace, concentrating on how workplace design can influence effectiveness and enhance health, safety, and satisfaction. Human sensory, motor, and decision systems are studied, as well as principles for designing visual and auditory displays, control devices and tools, and work spaces. Problems with repetitive and high physical effort tasks, illumination, noise, and atmospheric conditions, along with relevant governmental regulations, are also considered.

Students may receive credit for only one of the following: MG 3450, IE 3450, or OIE 3450.

**OIE 3460. SIMULATION MODELING AND ANALYSIS.***(formerly MG/IE 3460)**Cat. I*

This course covers the application of simulation to a variety of managerial problems with examples from operations management, industrial engineering and manufacturing engineering. It introduces the student to the concepts of computer simulation, with an emphasis on the design of a simulation experiment and statistical interpretation of its results. It will discuss simulation of queueing models, inventory and industrial dynamics, and gaming situations. The role and use of computers for the execution of simulations will also be highlighted. A commercial simulation language such as SIMAN will be used to solve problems from the manufacturing and service industries.

Recommended background: CS 1101, or CS 1102, and MA 2612.

Students may receive credit for only one of the following: MG 3460, IE 3460, MG 3760, or OIE 3460.

**OIE 3501. MANAGEMENT SCIENCE II: RISK ANALYSIS.***(formerly MG/IE 3501)**Cat. I*

This course provides coverage in decision analysis. Decision analysis is a technology that assists decision makers in quantifying consideration of complexity and uncertainty in problems of choice. The course applies decision analysis to problems in risk assessment and risk evaluation. Decision making in risk analysis is examined across a wide set of management engineering problems including case studies in environmental risk, product liability, facilities design, and R and D management. The course is intended to be highly integrative with respect to risk analysis including issues such as business ethics and risk communication.

Suggested background: knowledge of calculus and introductory probability and statistics.

Students may receive credit for only one of the following: MG 3501, IE 3501, or OIE 3501.

**OIE 4410. CASE STUDIES IN INDUSTRIAL ENGINEERING.***(formerly MG/IE 4410)**Cat. I*

A number of in-depth case studies in operations and industrial engineering are analyzed. The cases will cover both manufacturing and service systems ranging from production system design to operations planning and control.

Recommended background: OIE 3400, OIE 3401, OIE 2500 and OIE 3501.

Students may receive credit for only one of the following: MG 3410, IE 3410, MG 4410, IE 4410, or OIE 4410.

**OIE 4460. GLOBAL PLANNING AND LOGISTICS.***(formerly MG/IE 4460)**Cat. II*

This case-based course will examine methods and strategies for managing and controlling material movement, with particular emphasis on international operations, from the purchase of production materials to the control of work in process to the distribution of the finished product. Strategies that will be discussed include the design of international distribution networks, the use of third-party logistics providers, and the creation of links between logistic systems

and marketing to create competitive advantage. The course will also explore tactical issues that must be managed to pursue a logistics strategy successfully, including choices regarding means of transportation, packaging, and inventory policies. Underlying themes of the course will be the use of information technologies (such as electronic data interchange and bar coding) and mathematical models to support logistics decision-making.

Recommended background: OIE 3400 and either FIN 2200 or OIE 2850 or consent of professor.

Students may receive credit for only one of the following: MG 4460, IE 4460, or OIE 4460.

This course will be offered 2009-10 and in alternating years thereafter.

**ORGANIZATIONAL BEHAVIOR AND CHANGE (OBC)****OBC 2300. ORGANIZATIONAL SCIENCE—FOUNDATION.***(formerly MG/IE 2300)**Cat. I*

This first course in organizational science provides the foundation for an understanding of organization and management. It is a survey of the social science of work, describing the basic knowledge and processes required of managers, including: motivation, communication, supervision, leadership, the group processes of decision making, conflict, work and organizational design, and reconciliation of the goals of individuals and organizations. Lecture, video presentation, group discussion and group mini-projects will be employed to introduce and illustrate the basic elements of management.

Students may receive credit for only one of the following: MG 2300, IE 2300, or OBC 2300.

**OBC 3351. ORGANIZATIONAL SCIENCE—MANAGEMENT OF CHANGE.***(formerly MG/IE 3351)**Cat. I*

This second course in organizational science provides experience in applying theories of organization and management to the analysis and implementation of organizational change. The course utilizes readings, experiential activities, and case studies of change management in technology-based organizations to provide a conceptual understanding as well as practical knowledge of the change management process. The course is designed as a seminar and workshop. Recommended background: OBC 2300 or consent of the professor. Students may receive credit for only one of the following: MG 3351, IE 3351, or OBC 3351.

**OBC 4300. SENIOR SEMINAR.***Cat. I*

This course is designed for the senior student who wishes to acquire or strengthen important skills needed for organizational success. Among the subjects covered is power in organizations, what it is, and how to acquire and appropriately use it. Additionally, this course emphasizes presentation skills, organizational etiquette, cross-cultural communication, and the knowledge of current events. The student will be expected to be familiar with and use all forms of media information for both individual and group projects. The course may be counted as a 4000-level elective for MG, MGE, or MIS, or as a Free Elective for any student at WPI.

Recommended Background: Senior standing.

Credit may not be earned for both OBC 430X and OBC 4300.

**OBC 4365. LEADERSHIP IN GROUPS AND ORGANIZATIONS.***(formerly MG 4365)**Cat. I*

This course considers the essence of leadership in groups and organizations. Specifically, it examines the personal, interpersonal, group, and contextual factors which affect formal and emergent leadership in groups and organizations. It also examines the effectiveness of various leadership approaches and styles under various conditions. Using case studies, simulations, group projects, and selected readings on leadership in groups and organizations, this course will give students an opportunity to assess and develop their own leadership talents.

Recommended background: OBC 2300 or consent of the professor.

Students may not receive credit for both MG 4365 and OBC 4365.

**IS4-MANAGEMENT SEMINAR\*:**

Current developments in management seminars will be organized periodically and announced in the *Undergraduate Catalog* web site. No more than 1/3 unit credit will be available for this type #4 IS/P.

\*Initials of instructors in charge will appear in *Undergraduate Catalog* web site in addition to a description of seminar to be offered.

## MATHEMATICAL SCIENCES

The second digit in mathematical sciences course numbers is coded as follows:

- 0 — Basic
- 2 — Applied mathematics (general)
- 4 — Applied mathematics (differential equations)
- 6 — Statistics and probability
- 8 — Mathematics (general)

### MA 1020. CALCULUS I WITH PRELIMINARY TOPICS.

*Cat. I (14-week course)*

This course includes the topics of MA 1021 and also presents selected topics from algebra, trigonometry, and analytic geometry.

This course, which extends for 14 weeks and offers 1/3 unit of credit, is designed for students whose precalculus mathematics is not adequate for MA 1021.

Although the course will make use of computers, no programming experience is assumed.

Students may not receive credit for both MA 1020 and MA 1021.

### MA 1021. CALCULUS I.

*Cat. I*

This course provides an introduction to differentiation and its applications.

Topics covered include: functions and their graphs, limits, continuity, differentiation, linear approximation, chain rule, min/max problems, and applications of derivatives.

Recommended background: Algebra, trigonometry and analytic geometry.

Although the course will make use of computers, no programming experience is assumed.

Students may not receive credit for both MA 1021 and MA 1020.

### MA 1022. CALCULUS II.

*Cat. I*

This course provides an introduction to integration and its applications.

Topics covered include: inverse trigonometric functions, Riemann sums, fundamental theorem of calculus, basic techniques of integration, volumes of revolution, arc length, exponential and logarithmic functions, and applications.

Recommended background: MA 1021. Although the course will make use of computers, no programming experience is assumed.

### MA 1023. CALCULUS III.

*Cat. I*

This course provides an introduction to series, parametric curves and vector algebra.

Topics covered include: numerical methods, indeterminate forms, improper integrals, sequences, Taylor's theorem with remainder, convergence of series and power series, polar coordinates, parametric curves and vector algebra.

Recommended background: MA 1022. Although the course will make use of computers, no programming experience is assumed.

### MA 1024. CALCULUS IV.

*Cat. I*

This course provides an introduction to multivariable calculus.

Topics covered include: vector functions, partial derivatives and gradient, multivariable optimization, double and triple integrals, polar coordinates, other coordinate systems and applications.

Recommended background: MA 1023. Although the course will make use of computers, no programming experience is assumed.

### MA 1031. INTRODUCTION TO ANALYSIS I.

*Cat. I*

This course provides the fundamentals of mathematical thinking and writing for mathematical proof in analysis. Topics covered include mathematical logic, set theory, functions, cardinality, topology of the real line, limits of sequences.

### MA 1032. INTRODUCTION TO ANALYSIS II.

*Cat. I*

This course uses the tools developed in MA 1031 to explore the theory of differentiability and introduces the Riemann integral. Topics covered include limits and continuity of functions, the intermediate value theorem, differentiation, mean value theorems, l'Hopital's rule, antiderivatives, the Riemann integral, Riemann integrability.

Recommended background: MA 1031

### MA 1033. INTRODUCTION TO ANALYSIS III.

*Cat. I*

This course develops the theory of integration and provides an introduction to series of numbers and series of functions. Topics covered include the Fundamental Theorem of Calculus, integration by parts, change of variable, series, convergence tests, rearrangements

of series, sequences and series of functions, power series, Taylor series.

Recommended background: MA 1032

### MA 1034. INTRODUCTION TO ANALYSIS IV.

*Cat. I*

The course provides a rigorous introduction to multivariable analysis. Topics covered include vector algebra, functions of several variables, partial derivatives, gradient, multiple integrals, Green's theorem, Stokes' theorem, divergence theorem. Recommended background: MA 1033

### MA 2051. ORDINARY DIFFERENTIAL EQUATIONS.

*Cat. I*

This course develops techniques for solving ordinary differential equations. Topics covered include: introduction to modeling using first-order differential equations, solution methods for linear higher-order equations, qualitative behavior of nonlinear first-order equations, oscillatory phenomena including spring-mass system and RLC-circuits and Laplace transform. Additional topics may be chosen from power series method, methods for solving systems of equations and numerical methods for solving ordinary differential equations.

Recommended background: MA 1024.

### MA 2071. MATRICES AND LINEAR ALGEBRA I.

*Cat. I*

This course provides a study of computational techniques of matrix algebra and an introduction to vector spaces.

Topics covered include: matrix algebra, systems of linear equations, eigenvalues and eigenvectors, least squares, vector spaces, inner products, and introduction to numerical techniques, and applications of linear algebra.

Recommended background: None.

### MA 2073. MATRICES AND LINEAR ALGEBRA II.

*Cat. I*

This course provides a deeper understanding of topics introduced in MA 2071 and also continues the development of those topics. Topics covered include: abstract vector spaces, linear transformations, matrix representations of a linear transformation, characteristics and minimal polynomials, diagonalization, eigenvalues and eigenvectors, inner product spaces.

This course is design primarily for Mathematical Science majors and those interested in the deeper mathematical issues underlying linear algebra.

Undergraduate credit may not be earned both for this course and for MA 3071.

Recommended background: MA 2071.

### MA 2201/CS 2022. DISCRETE MATHEMATICS.

*Cat. I*

This course serves as an introduction to some of the more important concepts, techniques, and structures of discrete mathematics providing a bridge between computer science and mathematics.

Topics include functions and relations, sets, countability, groups, graphs, propositional and predicate calculus, and permutations and combinations.

Students will be expected to develop simple proofs for problems drawn primarily from computer science and applied mathematics.

Intended audience: computer science and mathematical sciences majors.

Recommended background: None.

### MA 2210. MATHEMATICAL METHODS IN DECISION MAKING.

*Cat. I*

This course introduces students to the principles of decision theory as applied to the planning, design and management of complex projects. It will be useful to students in all areas of engineering, actuarial mathematics as well as those in such interdisciplinary areas as environmental studies. It emphasizes quantitative, analytic approaches to decision making using the tools of applied mathematics, operations research, probability and computations. Topics covered include: the systems approach, mathematical modeling, optimization and decision analyses. Case studies from various areas of engineering or actuarial mathematics are used to illustrate applications of the materials covered in this course.

Recommended background: MA 1024. Suggested background: Familiarity with vectors and matrices. Although the course makes use of computers, no programming experience is assumed. Students who have received credit for CE 2010 may not receive credit for MA 2210.

**MA 2251. VECTOR AND TENSOR CALCULUS.***Cat. I*

This course provides an introduction to tensor and vector calculus, an essential tool for applied mathematicians, scientists, and engineers.

Topics covered include: scalar and vector functions and fields, tensors, basic differential operations for vectors and tensors, line and surface integrals, change of variable theorem in integration, integral theorems of vector and tensor calculus. The theory will be illustrated by applications to areas such as electrostatics, theory of heat, electromagnetics, elasticity and fluid mechanics.

Recommended background: MA 1024.

**MA 2271. GRAPH THEORY.***Cat. II*

This course introduces the concepts and techniques of graph theory—a part of mathematics finding increasing application to diverse areas such as management, computer science and electrical engineering. Topics covered include: graphs and digraphs, paths and circuits, graph and digraph algorithms, trees, cliques, planarity, duality and colorability.

This course is designed primarily for Mathematical Science majors and those interested in the deeper mathematical issues underlying graph theory.

Undergraduate credit may not be earned both for this course and for MA 3271.

Recommended background: MA 2071.

This course will be offered in 2008-09 and in alternating years thereafter.

**MA 2273. COMBINATORICS.***Cat. II*

This course introduces the concepts and techniques of combinatorics—a part of mathematics with applications in computer science and in the social, biological, and physical sciences. Emphasis will be given to problem solving. Topics will be selected from: basic counting methods, inclusion-exclusion principle, generating functions, recurrence relations, systems of distinct representatives, combinatorial designs, combinatorial algorithms and applications of combinatorics.

This course is designed primarily for Mathematical Sciences majors and those interested in the deeper mathematical issues underlying combinatorics.

Undergraduate credit may not be earned both for this course and for MA 3273.

Recommended background: MA 2071.

This course will be offered in 2009-10 and in alternating years thereafter.

**MA 2431. MATHEMATICAL MODELING WITH ORDINARY DIFFERENTIAL EQUATIONS.***Cat. I*

This course focuses on the theoretical foundations of ordinary equations while building models for physical and biological systems. Mathematical topics may include methods for solving systems of ordinary differential equations, existence and uniqueness theory, stability theory, phase-plane analysis and limit cycles. Examples will be chosen from electrical and mechanical oscillations, control theory, ecological models and reaction kinetics. Students will learn how to turn a real-life physical or biological problem into a mathematical one and to interpret the mathematical results.

This course is designed primarily for Mathematical Sciences majors and those interested in the deeper mathematical issues underlying mathematical modeling.

Undergraduate credit may not be earned both for this course and for MA 3431.

Recommended background: MA 1024, MA 2051 and MA 2071.

**MA 2610. APPLIED STATISTICS FOR THE LIFE SCIENCES.***Cat. I*

This course is designed to introduce the student to statistical methods and concepts commonly used in the life sciences. Emphasis will be on the practical aspects of statistical design and analysis with examples drawn exclusively from the life sciences, and students will collect and analyze data. Topics covered include analytic and graphical and numerical summary measures, probability models for sampling distributions, the central limit theorem, and one and two sample point and interval estimation, parametric and non-parametric hypothesis testing, principles of experimental design, comparisons of paired samples and categorical data analysis. Undergraduate credit may not be earned for both this course and for MA 2611. Recommended background: MA 1022.

**MA 2611. APPLIED STATISTICS I.***Cat. I*

This course is designed to introduce the student to data analytic and applied statistical methods commonly used in industrial and scientific applications as well as in course and project work at WPI. Emphasis will be on the practical aspects of statistics with students analyzing real data sets on an interactive computer package.

Topics covered include analytic and graphical representation of data, exploratory data analysis, basic issues in the design and conduct of experimental and observational studies, discrete and continuous probability models, the central limit theorem, and one and two sample point and interval estimation.

Recommended background: MA 1022.

**MA 2612. APPLIED STATISTICS II.***Cat. I*

This course is a continuation of MA 2611.

Topics covered include tests of hypotheses, simple and multiple regression, one and two-way tables for categorical data, and design and analysis of one factor experiments.

Recommended background: MA 2611.

**MA 2621. PROBABILITY FOR APPLICATIONS.***Cat. I*

This course is designed to introduce the student to probability.

Topics to be covered are: basic probability theory including Bayes theorem; discrete and continuous random variables; special distributions including the Bernoulli, Binomial, Geometric, Poisson, Uniform, Normal, Exponential, Chi-square, Gamma, Weibull, and Beta distributions; multivariate distributions; conditional and marginal distributions; independence; expectation; transformations of univariate random variables.

Recommended background: MA 1024.

**MA 2631. PROBABILITY.***Cat. I*

The purpose of this course is twofold:

- To introduce the student to probability. Topics to be covered will be chosen from: axiomatic development of probability; independence; Bayes theorem; discrete and continuous random variables; expectation; special distributions including the binomial and normal; moment generating functions; multivariate distributions; conditional and marginal distributions; independence of random variables; transformations of random variables; limit theorems.
- To introduce fundamental ideas and methods of mathematics using the study of probability as the vehicle. These ideas and methods may include systematic theorem-proof development starting with basic axioms; mathematical induction; set theory; applications of univariate and multivariate calculus.

This course is designed primarily for Mathematical Sciences majors and those interested in the deeper mathematical issues underlying probability theory.

Recommended background: MA 1024.

Undergraduate credit may not be earned both for this course and for MA 2621.

**MA 3211. THEORY OF INTEREST.***Cat. I*

An introduction to actuarial mathematics is provided for those who may be interested in the actuarial profession.

Topics usually included are: measurement of interest, including accumulated and present value factors; annuities certain; amortization schedules and sinking funds; and bonds.

Recommended background: MA 1024 and the ability to write computer programs.

**MA 3212. LIFE CONTINGENCIES.***Cat. I*

A continuation of a study of actuarial mathematics with emphasis on the theory and application of contingency mathematics in the areas of life insurance and annuities.

Topics usually included are: survival functions and life tables; life insurance; life annuities; net premiums; and premium reserves.

Recommended background: MA 3211 and either MA 2621 or MA 2631.

**MA 3231. LINEAR PROGRAMMING.***Cat. I*

This course considers the formulation of real-world optimization problems as linear programs, the most important algorithms for their solution, and techniques for their analysis.

Topics covered include: the primal and dual simplex algorithms, duality theory, parametric analysis, network flow models and, as time permits, bounded variable linear programs or interior methods.

Recommended background: MA 2071.



**MA 3233. DISCRETE OPTIMIZATION.***Cat. II*

Discrete optimization is a lively field of applied mathematics in which techniques from combinatorics, linear programming, and the theory of algorithms are used to solve optimization problems over discrete structures, such as networks or graphs.

The course will emphasize algorithmic solutions to general problems, their complexity, and their application to real-world problems drawn from such areas as VLSI design, telecommunications, airline crew scheduling, and product distribution.

Topics will be selected from: Network flow, optimal matching, integrality of polyhedra, matroids, and NP-completeness.

Undergraduate credit may not be earned both for this course and for MA 4233.

Recommended background: At least one of MA 2271, MA 2273 or MA 3231.

This course will be offered in 2008-09 and in alternating years thereafter.

**MA 3257/CS 4032. NUMERICAL METHODS FOR LINEAR AND NONLINEAR SYSTEMS.***Cat. I*

This course provides an introduction to modern computational methods for linear and nonlinear equations and systems and their applications.

Topics covered include: solution of nonlinear scalar equations, direct and iterative algorithms for the solution of systems of linear equations, solution of nonlinear systems, the eigenvalue problem for matrices. Error analysis will be emphasized throughout.

Recommended background: MA 2071. An ability to write computer programs in a scientific language is assumed.

**MA 3457/CS 4033. NUMERICAL METHODS FOR CALCULUS AND DIFFERENTIAL EQUATIONS.***Cat. I*

This course provides an introduction to modern computational methods for differential and integral calculus and differential equations.

Topics covered include: interpolation and polynomial approximation, approximation theory, numerical differentiation and integration, numerical solutions of ordinary differential equations. Error analysis will be emphasized throughout.

Recommended background: MA 2051. An ability to write computer programs in a scientific language is assumed. Undergraduate credit may not be earned for both this course and for MA 3255/CS 4031.

**MA 3471. ADVANCED ORDINARY DIFFERENTIAL EQUATIONS.***Cat. II*

The first part of the course will cover existence and uniqueness of solutions, continuous dependence of solutions on parameters and initial conditions, maximal interval of existence of solutions, Gronwall's inequality, linear systems and the variation of constants formula, Floquet theory, stability of linear and perturbed linear systems. The second part of the course will cover material selected by the instructor. Possible topics include: Introduction to dynamical systems, stability by Lyapunov's direct method, study of periodic solutions, singular perturbation theory and nonlinear oscillation theory.

Recommended background: MA 2431 and MA 3832.

This course will be offered in 2009-10 and in alternating years thereafter.

**MA 3475. CALCULUS OF VARIATIONS.***Cat. II*

This course covers the calculus of variations and select topics from optimal control theory. The purpose of the course is to expose students to mathematical concepts and techniques needed to handle various problems of design encountered in many fields, e. g. electrical engineering, structural mechanics and manufacturing.

Topics covered will include: derivation of the necessary conditions of a minimum for simple variational problems and problems with constraints, variational principles of mechanics and physics, direct methods of minimization of functions, Pontryagin's maximum principle in the theory of optimal control and elements of dynamic programming.

Recommended background: MA 2051.

This course will be offered in 2008-09 and in alternating years thereafter.

**MA 3627. APPLIED STATISTICS III.***Cat. II*

This course continues the exploration of statistics for scientific and industrial applications, begun in MA 2611 and MA 2612. Topics will be chosen from distribution-free methods, the design and analysis of general factorial experi-

ments, two-level factorial and fractional factorial experiments, Taguchi methods, response surface analysis, and statistical quality control.

Recommended background: MA 2612.

This course will be offered in 2009-10, and in alternating years thereafter.

**MA 3631. MATHEMATICAL STATISTICS.***Cat. I*

This course introduces students to the mathematical principles of statistics. Topics will be chosen from: Sampling distributions, limit theorems, point and interval estimation, sufficiency, completeness, efficiency, consistency; the Rao-Blackwell theorem and the Cramer-Rao bound; minimum variance unbiased estimators and maximum likelihood estimators; tests of hypotheses including the Neyman-Pearson lemma, uniformly most powerful and likelihood ratio tests.

Recommended background: MA 2631.

**MA 3823. GROUP THEORY.***Cat. II*

This course provides an introduction to one of the major areas of modern algebra. Topics covered include: groups, subgroups, permutation groups, normal subgroups, factor groups, homomorphisms, isomorphisms and the fundamental homomorphism theorem. Recommended background: MA 2073.

This course will be offered in 2008-09 and in alternating years thereafter.

**MA 3825. RINGS AND FIELDS.***Cat. II*

This course provides an introduction to one of the major areas of modern algebra. Topics covered include: rings, integral domains, ideals, quotient rings, ring homomorphisms, polynomial rings, polynomial factorization, extension fields and properties of finite fields. Recommended background: MA 2073.

This course will be offered in 2009-10 and in alternating years thereafter.

Undergraduate credit may not be earned both for this course and for MA 3821.

**MA 3831. ADVANCED CALCULUS I.***Cat. I*

Advanced Calculus is a two-part course giving a rigorous presentation of the important concepts of classical real analysis.

Topics covered in the two-course sequence include: basic set theory, elementary topology of Euclidean spaces, limits and continuity, differentiation Riemann-Stieltjes integration, infinite series, sequences of functions, and topics in multivariate calculus.

Recommended background: MA 2051 and MA 2071.

**MA 3832. ADVANCED CALCULUS II.***Cat. I*

MA 3832 is a continuation of MA 3831.

For the contents of this course, see the description given for MA 3831.

Recommended background: MA 3831.

**MA 4213. RISK THEORY.***Cat. II*

This course covers topics in risk theory as it is applied, under specified assumptions, to insurance.

Topics covered include: economics of insurance, short term individual risk models, single period and extended period collective risk models, and applications.

Recommended background: MA 2631.

This course will be offered in 2009-10 and in alternating years thereafter.

**MA 4214. SURVIVAL MODELS.***Cat. II*

Survival models are statistical models of times to occurrence of some event. They are widely used in areas such as the life sciences and actuarial science (where they model such events as time to death, or to the development or recurrence of a disease), and engineering (where they model the reliability or useful life of products or processes). This course introduces the nature and properties of survival models, and considers techniques for estimation and testing of such models using realistic data.

Topics covered will be chosen from: parametric and nonparametric survival models, censoring and truncation, nonparametric estimation (including confidence intervals and hypothesis testing) using right-, left-, and otherwise censored or truncated data.

Recommended background: MA 3631.

This course will be offered in 2008-09, and in alternating years thereafter.

**MA 4235. MATHEMATICAL OPTIMIZATION.***Cat. II*

This course explores theoretical conditions for the existence of solutions and effective computational procedures to find these solutions for optimization problems involving nonlinear functions.

Topics covered include: classical optimization techniques, Lagrange multipliers and Kuhn-Tucker theory, duality in nonlinear programming, and algorithms for constrained and unconstrained problems.

Recommended background: Vector calculus at the level of MA 2251.

This course will be offered in 2009-10 and in alternating years thereafter.

**MA 4237. PROBABILISTIC METHODS IN OPERATIONS RESEARCH.***Cat. II*

This course develops probabilistic methods useful to planners and decision makers in such areas as strategic planning, service facilities design, and failure of complex systems.

Topics covered include: decisions theory, inventory theory, queuing theory, reliability theory, and simulation.

Recommended background: Probability theory at the level of MA 2621 or MA 2631.

This course will be offered in 2009-10 and in alternating years thereafter.

**MA 4291. APPLICABLE COMPLEX VARIABLES.***Cat. I*

This course provides an introduction to the ideas and techniques of complex analysis that are frequently used by scientists and engineers. The presentation will follow a middle ground between rigor and intuition.

Topics covered include: complex numbers, analytic functions, Taylor and Laurent expansions, Cauchy integral theorem, residue theory, and conformal mappings.

Recommended background: MA 1024 and MA 2051.

**MA 4411. NUMERICAL ANALYSIS OF DIFFERENTIAL EQUATIONS.***Cat. II*

This course is concerned with the development and analysis of numerical methods for differential equations.

Topics covered include: well-posedness of initial value problems, analysis of Euler's method, local and global truncation error, Runge-Kutta methods, higher order equations and systems of equations, convergence and stability analysis of one-step methods, multistep methods, methods for stiff differential equations and absolute stability, introduction to methods for partial differential equations.

Recommended background: MA 2071 and MA 3457/CS 4033. An ability to write computer programs in a scientific language is assumed.

This course will be offered in 2008-09, and in alternating years thereafter.

**MA 4451. BOUNDARY VALUE PROBLEMS.***Cat. I*

Science and engineering majors often encounter partial differential equations in the study of heat flow, vibrations, electric circuits and similar areas. Solution techniques for these types of problems will be emphasized in this course.

Topics covered include: derivation of partial differential equations as models of prototype problems in the areas mentioned above, Fourier Series, solution of linear partial differential equations by separation of variables, Fourier integrals and a study of Bessel functions.

Recommended background: MA 1024 or and MA 2051.

**MA 4473. PARTIAL DIFFERENTIAL EQUATIONS.***Cat. II*

The first part of the course will cover the following topics: classification of partial differential equations, solving single first order equations by the method of characteristics, solutions of Laplace's and Poisson's equations including the construction of Green's function, solutions of the heat equation including the construction of the fundamental solution, maximum principles for elliptic and parabolic equations. For the second part of the course, the instructor may choose to expand on any one of the above topics.

Recommended background: MA 2251 and MA 3832.

This course will be offered in 2008-09 and in alternating years thereafter.

**MA 4631. PROBABILITY AND MATHEMATICAL STATISTICS I.***Cat. I (14 week course)*

Intended for advanced undergraduates and beginning graduate students in the mathematical sciences and for others intending to pursue the mathematical study of probability and statistics, this course begins by covering the material of MA 3613 at a more advanced level. Additional topics covered are: one-to-one and many-to-one transformations of random variables; sampling distributions; order statistics, limit theorems.

Recommended background: MA 2631 or MA 3613, MA 3831 - MA 3832.

**MA 4632. PROBABILITY AND MATHEMATICAL STATISTICS II.***Cat. I (14 week course)*

This course is designed to complement MA 4631 and provide background in principles of statistics.

Topics covered include: point and interval estimation; sufficiency, completeness, efficiency, consistency; the Rao-Blackwell theorem and the Cramer-Rao bound; minimum variance unbiased estimators, maximum likelihood estimators and Bayes estimators; tests of hypothesis including uniformly most powerful, likelihood ratio, minimax and bayesian tests.

Recommended background: MA 3631 or MA 4631.

**MA 4891. TOPICS IN MATHEMATICS.***Cat. I*

## MECHANICAL ENGINEERING

The second digit in mechanical engineering course numbers is coded as follows:

0 — General mechanical engineering

1 —

2 —

3 — Design

4 — Thermal—fluids

5 — Engineering mechanics

6 — Fluid mechanics—hydraulics

7 — Aerospace

8 — Materials

9 — Engineering experimentation

**ME 1520. THE TECHNOLOGY OF ALPINE SKIING.***Cat. II*

This course explores science and engineering issues associated with equipment and technique for alpine skiing, particularly racing. A diverse group of technical subjects related to engineering mechanics are discussed: tribology, beams, rigid body motion, material science, machining and biomechanics. Specifically we will examine: ski-snow interactions, technique for gliding, turning and stepping, selection of line in racing; equipment design, testing and performance; and ski injuries. We will also address issues in the epidemiology of skiing injuries, the calculation of the cost of ski injuries to society, the impact of ski equipment technology on litigation and the impact of litigation on equipment and trail design.

This course will be offered in 2008-09 and in alternating years thereafter.

**ME 1800. MANUFACTURING SCIENCE, PROTOTYPING, AND COMPUTER-CONTROLLED MACHINING.***Cat. I*

This course introduces students to manufacturing science and engineering and prototype part production. It emphasizes CNC (computer-controlled) machining. Students will learn how to go from a solid (CAD, computer-aided design) model to a machined part, using CAM software (computer-aided manufacturing) and CNC machining. They will also be exposed to associated issues in manufacturing process analysis, engineering design, material science, and in dimensional and surface metrology. Using machining as an example, the science of manufacturing processes is developed in a combination of class work and laboratory experience. The laboratory experience includes an experimental component that relates process variables in machining with performance and machined part quality. Students whose project work will necessitate fabrication of parts and those who want a background in manufacturing process science and engineering should take this course.

**ME 2300. INTRODUCTION TO ENGINEERING DESIGN.***Cat. I*

Real world engineering design problems usually have more than one correct solution. This course utilizes a realistic design process to introduce students to the methods and techniques for solving engineering problems. Lectures will support the design projects and may cover engineering economics, fluid dynamics, heat transfer, mechanics, statistics, and basic circuits. No prior knowledge of fluids, heat transfer, economics, statistics or electrical circuits is required. Laboratory sessions will be used to build, test and demonstrate various designs.

This course is designed for sophomores and juniors to provide a broad overview of engineering design.

The course includes a significant writing component and makes extensive use of PCs for word processing, spread sheet calculations and programming.

Recommended background: Ordinary Differential Equations (MA 2051), mechanics (PH 1110), statics (ES 2501), any programming language.

**ME 2713. ASTRONAUTICS.***Cat. I*

Topics studied: Orbital mechanics including spacecraft maneuvering and station keeping, transfer orbits, and interplanetary transfers; space environment including characteristics of low earth highly elliptical and geosynchronous orbits; ascent and reentry trajectories.

Recommended background: Dynamics (ES 2503).

**ME 2820. MATERIALS PROCESSING.***Cat. I*

An introduction to material processing in manufacturing. This course provides important background for anyone interested in manufacturing, design engineering design, sales, or management.

Processing of polymers, ceramics, metals and composites is discussed. Processes covered include: rolling, injection molding, forging, powder metallurgy, joining and machining. The relationships between materials, processes, processing parameters and the properties of manufactured parts are developed. During the course the students should develop the ability to choose materials, processes, and processing parameters for designing manufacturing procedures to take a prototype part to production.

Recommended background: ME 1800 Materials Selection and Manufacturing Processes, and ES 2001 Introduction to Materials Science.

**ME 3023. MECHANICAL BEHAVIOR AND MODELING PROPERTIES OF ENGINEERING MATERIALS.***Cat. II*

This course is concerned with different types of material response to mechanical loads. The course studies the constitutive equations that are used to model the properties of engineering materials. The behavior of elastic, plastic, composite and visco-elastic materials is considered. Experiments describing materials behaviors will be conducted and the behavior will be modeled.

Topics include: descriptions of material behavior, methods of determining the material parameters from experimental tests, behavior of different types of materials under simple states of loading and deformation such as tensile stress-strain response (elastic and plastic), and time-dependent behavior at room and elevated temperature (viscoelasticity and creep) are studied. Theories of failure and failure modes under monotonic and cyclic loading, fracture and fracture mechanics, and methods of modifying material behavior are discussed. These topics will be integrated in several material selection projects.

Recommended background: statics (ES 2501), stress analysis (ES 2502), continuum mechanics (ES 3501), materials (ES 2001).

This course will be offered in 2009-10 and in alternating years thereafter.

**ME 3310. KINEMATICS OF MECHANISMS.***Cat. I*

An introduction to the synthesis and analysis of linkages, cams and gear trains is presented. The design process is introduced and used to solve unstructured design problems in linkage and cam design. Algebraic and graphical techniques to analyze the displacement, velocity and acceleration of linkages and cams are developed. Computer programs for the design and analysis of linkages are used by students. Results of student design projects are presented in professional engineering reports.

Recommended background: Ordinary Differential Equations (MA 2051), statics (ES 2501), dynamics (ES 2503).

**ME 3311. DYNAMICS OF MECHANISMS AND MACHINES.***Cat. I*

This course provides an in-depth study of forces in dynamic systems. Dynamic force analysis is developed using matrix methods. Computer programs are used to solve the sets of simultaneous equations derived by students for realistic, unstructured design problems. Inertial and shaking forces, elementary mechanical vibrations, torque-time functions, rotational and reciprocating balance and cam dynamics are covered using the internal combustion engine as a design example. Students execute unstructured design projects and prepare professional engineering reports on the results. Computers are used extensively to solve the dynamic equations.

Recommended background: Ordinary Differential Equations (MA 2051), statics (ES 2501), dynamics (ES 2503), kinematics (ME 3310), linear algebra.

This course will be offered in 2008-09 and in alternating years thereafter.

**ME 3320. DESIGN OF MACHINE ELEMENTS.***Cat. I*

This is an introductory course in mechanical design analysis, and it examines stress and fatigue in many machine elements. Common machine elements are studied and methods of selection and design are related to the associated hardware.

Topics covered include: combined stresses, fatigue analysis, design of shafts, springs, gears, bearings and miscellaneous machine elements.

Recommended background: mechanics (ES 2501, ES 2502, ES 2503), materials (ME 1800, ME 2820), computer programming (CS 1101 or CS 1102).

**ME 3321. DYNAMIC MODELING.***Cat. II*

This course introduces students to the modeling and analysis of dynamic systems. A unified treatment of mechanical, electrical, fluid and thermal systems is presented using the bond graph modeling language. The creation of dynamic models and the analysis of model response is emphasized.

Lecture topics include energy storage and dissipation elements, transducers, transformers, formulation of equations for a dynamic system and time response of linear systems. Computers are used extensively for both system modeling and analysis.

Recommended background: mathematics (MA 2051, MA 2071), fluids (ES 3004), mechanics (ES 2501, ES 2503).

This course will be offered in 2009-10 and in alternating years thereafter.

**ME 3410. COMPRESSIBLE FLUID DYNAMICS.***Cat. I*

In this course, students are introduced to various compressibility phenomena such as compression (shock) and expansion waves. Conservation laws and thermodynamic principles are applied to the description of flows in which compressibility effects are significant. One-dimensional models are applied to analysis of flow in variable area ducts, normal and oblique shock waves, expansion waves, and flows with friction and heat addition. Numerous applications from engineering are investigated including supersonic inlets, rocket nozzles, supersonic wind tunnels, gas delivery systems, and afterburning jet engines.

Recommended background: thermodynamics (ES 3001 or CH 3510) and fluids (ES 3004) or equivalent.

**ME 3501. ELEMENTARY CONTINUUM MECHANICS.***Cat. II*

In typical mathematics courses, students learn principles and techniques by solving many short and specially prepared problems. They rarely gain experience in formulating and solving mathematical equations that apply to real life engineering problems. This course will give students this type of applied mathematical experience.

The course emphasizes the application of basic laws of nature as they apply to differential elements which lead to differential equations that need to be solved; all of these ideas are used in higher level engineering science courses such as fluid mechanics, heat transfer, elasticity, etc. Emphasis will be placed on understanding the physical concepts in a problem, selecting appropriate differential elements, developing differential equations, and finding ways to solve these equations. Limitations on the mathematical solutions due to assumptions made will be considered.

Recommended background: Ordinary Differential Equations (MA 2051), statics (ES 2501), dynamics (ES 2503).

This course will be offered in 2008-09 and in alternating years thereafter.

**ME 3506. REHABILITATION ENGINEERING.***Cat. I*

The course exposes the students to the use of technology to design devices to ameliorate the handicaps of individuals with disabilities. This course focuses on the design process for assistive devices including defining the problem, setting design criteria, developing preliminary designs, selecting, analyzing and testing a final design. Human factors are integrated into all phases of the design process.

Topics include: ergonomics, physical and cognitive parameters that effect the user interface, safety, economics, reliability and esthetics. Design and analysis of devices used for mobility and in daily activities in residential, educational and vocational settings. Laboratory sessions will be used to develop conceptual designs that solve real problems.

Recommended background: mechanics (ES 2501, ES 2502, ES 2503), kinematics (ME 3310), design (ME 2300), materials (ME 1800, ME 2820), electrical engineering (ECE 3601).

**ME 3601. PRINCIPLES OF MECHANICAL ENGINEERING.***Cat. I*

Intended for students other than mechanical or manufacturing engineering students, this course is oriented towards developing competence in mechanical engineering concepts on the level that the technology interfaces directly with their own discipline. The course is designed specifically to help students meet that challenge through the development of a broad systems perspective and an understanding of the principal elements of mechanical engineering technology. The expectation is that students completing this course will be able to handle



adequately the mechanical aspects of a broad range of application topics. In addition, and most important, they will be prepared to work effectively with mechanical engineers on the joint solution of complex problems.

Topics covered during the course include, but are not limited to, the fundamentals of: statics, dynamics, kinematics, kinetics, materials, heat transfer, fluid dynamics, thermodynamics, stress analysis, vibrations, error and uncertainty analysis, as well as current trends and future directions in solution methodologies, and will be illustrated with representative applications, such as, electro-thermo-mechanical and viscoelastic systems, electronic packaging, and MEMS. Selected projects are included to emphasize the direct application of the information presented in lectures.

Intended for non-Mechanical Engineering or non-Manufacturing Engineering majors.

Recommended background: MA 1021-1024, MA 2051, CH 1010, PH 1110/1111-PH1120/1121, or equivalent. Intended audience, non-mechanical and manufacturing majors.

### ME 3602. INCOMPRESSIBLE FLUID DYNAMICS.

#### Cat. I

This course covers inviscid and viscous incompressible fluid dynamics at an intermediate level. Topics include: fluid kinematics and deformation; integral conservation laws of mass, momentum and energy for finite systems and control volumes; differential conservation laws of mass, momentum and energy; the Navier-Stokes equations and solution methods; the incompressible Euler equations and Bernoulli's equation; the streamfunction and the velocity potential; incompressible, inviscid, irrotational flow theory and solution methodology; elementary potential flows, the superposition principle and its applications to flows over solid bodies; two-dimensional incompressible, viscous boundary layer, Prandtl's theory, the Blasius solution and its application; other analytical solutions for two-dimensional viscous and inviscid incompressible channel flows.

Recommended background: fluids (ES 3004) or equivalent.

### ME 3711. AERODYNAMICS.

#### Cat. I

This course introduces students to the aerodynamics of airfoils, wings, and aircraft in the subsonic and supersonic regimes. Topics covered include: prediction of aerodynamic forces (lift, drag) and moments, dynamic similarity, experimental techniques in aerodynamics, Kutta-Joukowski theorem, circulation, thin airfoil theory, panel methods, finite wing theory, subsonic compressible flow over airfoils, linearized supersonic flow, and viscous flow over airfoils.

Recommended background: Fluid Mechanics (ES 3004), Incompressible Fluid Dynamics (ME 3602) or equivalent.

### ME 3712. AEROSPACE STRUCTURES.

#### Cat. I

This is a course in solid mechanics that covers stress analysis of aerospace structures. It begins with an overview of stress, strain, three-dimensional elasticity theory, and stress-strain relations for anisotropic materials. Advanced topics include general torsion of solid noncircular cross sections, torsion of thinwalled members, bidirectional bending of unsymmetric cross sections, shear flow in and shear center of thin walled multi-celled members, and buckling and stability of columns.

Recommended background: stress (ES 2502) or equivalent.

Students who have already taken and received credit for ME 4715 will not be able to also get credit for ME 3712.

### ME 3801. EXPERIMENTAL METHODS IN MATERIALS SCIENCE AND ENGINEERING.

#### Cat. I

This course is designed to meet the experimental design requirement for ME students.

A course designed to develop analytical and experimental skills in modern engineering measurement methods, based on electronic instrumentation and computer-based data acquisition systems. The lectures are concerned with the engineering analysis and design as well as the principles of instrumentation, whereas the laboratory periods afford the student an opportunity to use modern devices in materials engineering experiments. Lecture topics include: review of materials and mechanical engineering fundamentals, and, among others, discussions of standards, measurement, and sensing devices, experiment planning, data acquisition, analysis of experimental data, and report writing. Laboratory experiments address both mechanical and thermal systems and instrumentation in materials engineering (temperature and pressure measurements in materials processing, measurement of strain and position in mechanical testing of materials).

Recommended background: mathematics (MA 2051), thermo-fluids (ES 3001, ES 3003, ES 3004), mechanics (ES 2501, ES 2502, ES 2503), materials (ES 2001).

### ME 3820. COMPUTER-AIDED MANUFACTURING.

#### Cat. I

This introductory course in modern control systems will give students an understanding of the basic techniques, and the range of equipment used in most computer controlled manufacturing operations. The class work is reinforced by hands-on laboratories in the Robotics/CAM lab. Modeling and analysis of machining processes, and applications of PLC (programmable logic control) are included.

Class topics include: Manufacturing Automation, Microcomputers for Process Monitoring and Control, Computer Numerical Control, Switching Theory and Ladder Logic, Transducers and Signal Conditioning, and Closed Loop Digital Control. The laboratories allow students to program and implement several types of the controllers, and will provide an introduction to the topic of industrial robotics.

Recommended background: manufacturing (ME 1800), materials processing (ME 2820), elementary computer/logic device programming.

### ME 3901. ENGINEERING EXPERIMENTATION.

#### Cat. I

A course designed to develop analytical and experimental skills in modern engineering measurement methods, based on electronic instrumentation and computer-based data acquisition systems. The lectures are concerned with the engineering analysis and design as well as the principles of instrumentation, whereas the laboratory periods afford the student an opportunity to use modern devices in actual experiments.

Lecture topics include: review of engineering fundamentals and, among others, discussions of standards, measurement and sensing devices, experiment planning, data acquisition, analysis of experimental data, and report writing.

Laboratory experiments address both mechanical and thermal systems and instrumentation in either traditional mechanical engineering (heat transfer, flow measurement/visualization, force/torque/strain measurement, motion/vibration measurement) or materials engineering (temperature and pressure measurements in materials processing, measurement of strain and position in mechanical testing of materials). Each year students will be notified which type of experiments will be used in each term offering. Students may also consult with their academic advisor or the Mechanical Engineering department office.

Recommended background: mathematics (MA 2051), thermo-fluids (ES 3001, ES 3003, ES 3004), mechanics (ES 2501, ES 2502, ES 2503), materials (ES 2001).

### ME 4320. ADVANCED ENGINEERING DESIGN.

#### Cat. I

This course integrates students' background in ME in a one-term design project that is usually taken from a local company. Students must organize themselves and the project to successfully realize a product that meets customer needs. Activities include problem definition, design analysis, mathematical modelling, CAD modelling, manufacturing, testing, liaison to vendors, customer relations, marketing, technical management, purchasing, report writing, and oral presentations.

Recommended background: mechanisms (ME 3310, ME 3311), stress analysis (ES 3502), design (ME 3320), thermo-fluids (ES 3001, ES 3003, ES 3004), materials (ES 2001), manufacturing (ME 1800).

### ME/RBE 4322. MODELING AND ANALYSIS OF MECHATRONIC SYSTEMS.

#### Cat. I

This course introduces students to the modeling and analysis of mechatronic systems. Creation of dynamic models and analysis of model response using the bond graph modeling language are emphasized. Lecture topics include energy storage and dissipation elements, transducers, transformers, formulation of equations for dynamic systems, time response of linear systems, and system control through open and closed feedback loops. Computers are used extensively for system modeling, analysis, and control. Hands-on projects will include the reverse engineering and modeling of various physical systems. Physical models may sometimes also be built and tested.

Recommended background: mathematics (MA 2051, MA 2071), fluids (ES 3004), thermodynamics (ES 3001), mechanics (ES 2501, ES 2503)

### ME 4429. THERMOFLUID APPLICATION AND DESIGN.

#### Cat. I

This course integrates thermodynamics, fluid mechanics and heat transfer through the use of design projects involving modern technologies, such as electronic cooling, vapor compression power cycles, and turbines. Activities include problem definition, design creation and analysis, mathematical modeling, cost analysis and optimization.

Recommended background: thermofluids (ES 3001, ES 3003, ES 3004) and an introduction to design.

**ME 4430. INTEGRATED THERMOMECHANICAL DESIGN AND ANALYSIS.***Cat. II*

Current state-of-the-art computer based methodologies used in the design and analysis of thermomechanical systems will be presented and illustrated by selected laboratory demonstrations, and used in projects. Projects will include thermal, mechanical, electronic, and photonic loads of steady state and dynamic nature and will integrate design, analysis, and testing. Students will prepare a technical report and present their results. Topics will include, but not be limited to, thermomechanics of fiber optic telecommunication cables, high-energy beam interactions with materials, shape memory alloys, microelectronics, MEMS and mechatronics.

Recommended background: MA 2051, ES 2001, ES 2502, ES 3003, ECE 3601,

ME 3901, and an introduction to design.

This course will be offered in 2008-09 and in alternating years thereafter.

**ME/BME 4504. BIOMECHANICS.***Cat. II*

This course emphasizes the applications of mechanics to describe the material properties of living tissues. It is concerned with the description and measurements of these properties as related to their physiological functions. Emphasis on the interrelationship between biomechanics and physiology in medicine, surgery, body injury and prostheses.

Topics covered include: review of basic mechanics, stress, strain, constitutive equations and the field equations, viscoelastic behavior, and models of material behavior. The measurement and characterization of properties of tendons, skin, muscles and bone. Biomechanics as related to body injury and the design of prosthetic devices.

Recommended background: mechanics (ES 2501, ES 2502, ES 2503, ME 3501), mathematics (MA 2051).

This course will be offered in 2009-10 and in alternating years thereafter.

**ME 4505. ADVANCED DYNAMICS.***Cat. II*

This course completes a sequence of sophomore, junior and senior courses in Dynamic Systems, i.e., ES 2503, ME 3505, and ME 4505, which are essential in an undergraduate Mechanical Engineering curriculum. An advanced course intended to emphasize the development and applications of dynamics in three-dimensional space. Problem solutions emphasize the use of vector algebra, matrix methods and differential equations with a goal of developing the student's ability to translate physical problems into mathematical models.

Topics covered include: three-dimensional kinematics using rotating and stationary frames of reference, development of force, energy and momentum equations governing general particle and rigid body systems. Applications of equations to rigid, elastic, and fluid problems.

Recommended background: dynamics (ES 2503).

This course will be offered in 2008-09 and in alternating years thereafter.

**ME 4506. MECHANICAL VIBRATIONS.***Cat. I*

This course is an introduction to the fundamental concepts of mechanical vibrations, which are important for design and analysis of mechanical and structural systems subjected to time-varying loads. The objective of the course is to expose the students to mathematical modeling and analysis of such systems

Topics covered include: formulation of the equations of motion using Newton's Laws, D'Alembert's Principle and energy methods; prediction of natural frequency for single-degree-of-freedom systems; modeling stiffness characteristics, damping and other vibrational properties of mechanical systems; basic solution techniques by frequency response analysis and convolution integral methods. Examples may include analysis and design for transient passage through resonance; analysis and design of vibration measurement devices; introductory rotordynamics. The course is mainly focused on analysis of single-degree-of-freedom systems, however a basic introduction into multidegree-of-freedom systems is also presented. Computer-based project may be suggested.

Recommended background: Ordinary Differential Equations (MA 2501), Statics (ES 2501), Dynamics (ES 2503).

**ME 4512. INTRODUCTION TO THE FINITE ELEMENT METHOD.***Cat. I*

This course serves as an introduction to finite element analysis (FEA) for stress analysis problems. Finite element equations are developed for several element types from stiffness and energy approaches and used to solve simple problems. Element types considered include spring, truss, beam, two-dimensional (plane stress/strain and axisymmetric solid), three-dimensional and plates. Stress concentrations, static failures, and fatigue failures are considered for each element type. Emphasis will be placed on knowing the behavior and usage of each element type, being able to select a suitable finite element model for a given

problem, and being able to interpret and evaluate the solution quality. A commercial, general-purpose finite element computer program is used to solve problems that are more complex. Projects are used to introduce the use of FEA in the iterative design process.

Recommended background: Mathematics (MA 2051, MA 2071), Mechanics (ES2501 & ES 2502 or CE2000 & CE2001).

**ME/BME 4606. BIOFLUIDS.***Cat. II*

This course emphasizes the applications of fluid mechanics to biological problems. The course concentrates primarily on the human circulatory and respiratory systems. Topics covered include: blood flow in the heart, arteries, veins and microcirculation and air flow in the lungs and airways. Mass transfer across the walls of these systems is also presented.

Recommended background: continuum mechanics (ME 3501), fluids (ES 3004).

This course will be offered in 2008-09 and in alternating years thereafter.

**ME 4710. GAS TURBINES FOR PROPULSION AND POWER GENERATION.***Cat. II*

This course provides a study of open-cycle and closed-cycle gas turbines. Topics covered include: thermodynamic cycles and fluid dynamics of airbreathing gas turbines (turbojets, turbofans, turboprops), ramjets, and scramjets; thermodynamic cycles and fluid dynamics of closed-cycle gas turbines. Performance of specific engine components such as inlets, combustors, nozzles, as well as axial compressors and turbines will be addressed.

Recommended preparation: Fluid Mechanics (ES 3004), Heat Transfer (ES 3003), Thermodynamics (ES 3001 or CH 3510) or equivalent. This course will be offered in 2009-10 and in alternating years thereafter. Students who have taken and received credit for ME 4711 or ME 4716 will not be able to receive credit for ME 4710.

This course will be offered in 2008-09 and in alternating years thereafter.

**ME 4713. SPACECRAFT DYNAMICS AND CONTROL.***Cat. I*

The course covers broad topics in spacecraft attitude dynamics, stability and control. The course includes a review of particle and two-body dynamics and introduction to rigid body dynamics. Orbital and attitude maneuvers are presented. Attitude control devices and momentum exchange techniques such as spinners, dual spinners, gravity gradient, and geomagnetic torques are presented. Attitude sensors/actuators are presented and the attitude control problem is introduced. Gyroscopic instruments are introduced and demonstrated in the laboratory. Open-loop stability analysis for a variety of equilibrium conditions is discussed. Control using momentum exchange and mass expulsion (thrusters) devices is discussed.

Recommended background: Astronautics (ME 2713). Suggested background includes concepts of control theory as covered in Control Engineering I (ES 3011), and concepts of particle dynamics as covered in Intermediate Mechanics (PH 2201) or Introduction to Dynamic Systems (ES 2503).

**ME 4718. ADVANCED MATERIALS WITH AEROSPACE APPLICATIONS.***Cat. I*

This course covers topics on the design, fabrication and behavior of advanced materials used in structural and propulsion components of aerospace vehicles. The design, fabrication, and properties of polymer, metal and ceramic matrix composites used in aerospace structures are presented. The fabrication and behavior of aluminum and titanium alloys used in propulsion components as well as the processing and performance of Nickel-based superalloys are also presented. The fundamentals of coatings for high temperature oxidation, hot corrosion, and thermal protection are introduced.

Recommended background: Introduction to Materials Science (ES 2001), Stress Analysis (ES 2502) or equivalent.

**ME 4719. ROCKET PROPULSION.***Cat. II*

This course provides a study of rocket propulsion systems for launch vehicles and spacecraft. Dynamics, performance and optimization of rocket-propelled vehicles are presented. Performance and component analysis of chemical and electric propulsion systems are covered. Advanced propulsion and micropropulsion concepts are introduced. Additional topics may include propellant storage, feed systems, propulsion system integration, and environmental impacts of propulsion systems.

Recommended preparation: Astronautics (ME 2713), Fluid Dynamics (ES 3004), Heat Transfer (ES 3003), Thermodynamics (ES 3001 or CH3510) or equivalent. This course will be offered in 2008-09 and in alternating years thereafter. Students who have taken and received credit for ME 4711 or ME 4717 will not be able to receive credit for ME 4719.

This course will be offered in 2009-10 and in alternating years thereafter.

**ME 4723. AIRCRAFT DYNAMICS AND CONTROL.***Cat. I*

The goal of this course is for students to develop, analyze, and utilize models of aircraft dynamics, and to study various aircraft control systems. Topics include: review of linear systems, longitudinal and lateral flight dynamics, simulation methodologies, natural modes of motion, static and dynamic aircraft stability, and aircraft control systems (such as autopilot design, flight path control, and automatic landing). Other topics may include: vertical take-off and landing (VTOL) vehicles and rotorcraft.

Recommended background: Fundamentals in Dynamics (ES2503 or PH 2201), and Control theory (ES3011) or equivalent.

**ME 4733. GUIDANCE, NAVIGATION AND COMMUNICATION.***Cat. I*

This course broadly covers methods and current enabling technologies in the analysis, synthesis and practice of aerospace guidance, navigation, and communication and information systems. Topics covered include: position fixing and celestial navigation with redundant measurements, recursive navigation, and Kalman filtering; inertial navigation systems, global position systems, and Doppler navigation; orbit determination; atmospheric re-entry; communication architectures, data rates, and communication link design; tropospheric and ionospheric effects on radio-wave propagation; pursuit guidance and ballistic flight.

Recommended background: fundamental orbital mechanics (ME2713), electricity and magnetism (PH1120, PH1121) or equivalent.

**ME 4770. AIRCRAFT DESIGN.***Cat. II*

This course introduces students to design of aircraft systems. Students complete a conceptual design of an aircraft in a term-long project. Students must establish design specifications, develop and analyze alternative designs, and justify their design in a written report. The design project incorporates fundamentals of aerodynamics, structures, aircraft performance, aircraft stability, and propulsion into a capstone design experience. The design project culminates in a Conceptual Design Review with oral presentations and a written final report. Design teams, software tools, and technical communication are emphasized.

Recommended background: intermediate fluid mechanics (ME 3602), subsonic aerodynamics (ME 3711), air breathing propulsion (ME 3716), aerospace structures (ME 4715).

This course will be offered in 2009-10 and in alternating years thereafter.

**ME 4771. SPACECRAFT AND MISSION DESIGN.***Cat. II*

This course introduces students to design of spacecraft, spacecraft subsystem and space missions. Topics covered in lectures address mission classification and the space environment, the design of subsystems that include spacecraft power and propulsion, attitude dynamics and control, structural, thermal, and communication. Lectures are in parallel with a term-long conceptual design of a spacecraft, spacecraft subsystem or space mission. The design project culminates in a Conceptual Design Review with oral presentations and a written final report. Design teams, software tools, and technical communication are emphasized.

Recommended background: fluid mechanics (ES 3004), heat transfer (ES 3003), control engineering (ES 3011), astronautics (ME 2713), rocket and spacecraft propulsion (ME 3715), aerospace structures (ME 4715).

This course will be offered in 2008-09 and in alternating years thereafter.

**ME 4810. AUTOMOTIVE MATERIALS AND PROCESS DESIGN.***Cat. II*

This course focuses on materials used in the automotive industry. Students complete a term-long project that integrates design, materials selection and processing considerations. Activities include: problem definition, development of design specifications, development and analysis of alternative designs, conceptual designs and materials and process selection. Students will consider cost, and environmental impact of alternative material choices. Students will present their results in intermediate and final design reviews.

Recommended background: materials science (ES 2001), stress analysis (ES 2502), or equivalent.

This course will be offered in 2008-09 and in alternating years thereafter.

**ME 4813. CERAMICS AND GLASSES FOR ENGINEERING APPLICATIONS.***Cat. II*

This course develops an understanding of the processing, structure, property, performance relationships in crystalline and vitreous ceramics. The topics covered include crystal structure, glassy structure, phase diagrams, microstructures, mechanical properties, optical properties, thermal properties, and

materials selection for ceramic materials. In addition the methods for processing ceramics for a variety of products will be included.

Recommended Background: ES 2001 or equivalent.

This course will be offered in 2008-09 and in alternating years thereafter.

**ME/BME 4814. BIOMATERIALS.***Cat. I*

A course specializing in material selection and special problems associated with biomedical engineering.

Topics covered include: fundamentals of metals, plastics, and ceramics and how they can be applied to biomedical applications. Case histories of successful and unsuccessful material selections. Current literature is the primary source of material.

Recommended background: materials (ES 2001).

**ME/RBE 4815. INDUSTRIAL ROBOTICS.***Cat. I*

This course introduces students to robotics within manufacturing systems.

Topics include: classification of robots, robot kinematics, motion generation and transmission, end effectors, motion accuracy, sensors, robot control and automation. This course is a combination of lecture, laboratory and project work, and utilizes industrial robots. Through the laboratory work, students will become familiar with robotic programming (using a robotic programming language VAL II) and the robotic teaching mode. The experimental component of the laboratory exercise measures the motion and positioning capabilities of robots as a function of several robotic variables and levels, and it includes the use of experimental design techniques and analysis of variance.

Recommended background: manufacturing (ME 1800), kinematics (ME 3310), control (ES 3011), and computer programming.

**ME 4821. PLASTICS.***Cat. II*

This course develops the processing, structure, property, performance relationships in plastic materials. The topics covered include polymerization processes, chain structure and configuration, molecular weights and distributions, amorphous and crystalline states and glass-rubber transition. The principles of various processing techniques including injection molding, extrusion, blow molding, thermoforming and calendaring will be discussed. The physical and mechanical properties of polymers and polymer melts will be described with specific attention to rheology and viscoelasticity. Pertinent issues related to environmental degradation and recyclability will be highlighted.

Recommended Background: ES2001 or equivalent.

This course will be offered in 2009-10 and in alternating years thereafter.

**ME 4832. CORROSION AND CORROSION CONTROL.***Cat. II*

An introductory course designed to acquaint the student with the different forms of corrosion and the fundamentals of oxidation and electro-chemical corrosion.

Topics covered include: corrosion principles, environmental effects, metallurgical aspects, galvanic corrosion, crevice corrosion, pitting, intergranular corrosion, erosion corrosion, stress corrosion, cracking and hydrogen embrittlement, corrosion testing, corrosion prevention, oxidation and other high-temperature metal-gas reactions.

Recommended background: materials (ES 2001).

This course will be offered in 2009-10 and in alternating years thereafter.

**ME 4840. PHYSICAL METALLURGY.***Cat. I*

Fundamental relationships between the structure and properties of engineering materials are studied. Principles of diffusion and phase transformation are applied to the strengthening of commercial alloy systems. Role of crystal lattice defects on material properties and fracture are presented.

Strongly recommended as a senior-graduate level course for students interested in pursuing a graduate program in materials or materials engineering at WPI, or other schools.

Recommended background: materials (ES 2001, ME 2820).

**ME 4860. FOOD ENGINEERING.***Cat. II*

An introductory course on the structure, processing, and properties of food.

Topics covered include: food structure and rheology, plant and animal tissues, texture, glass transition, gels, emulsions, micelles, food additives, food coloring, starches, baked goods, mechanical properties, elasticity, viscoelastic nature of food products, characteristics of food powders, fat eutectics, freezing and cooking of food, manufacturing processes, cereal processing, chocolate manufacture, microbial growth, fermentation, transport phenomena in food processing, kinetics, preserving and packaging of food, testing of food.

Recommended Background: ES2001 or equivalent.

This course will be offered in 2008-09 and in alternating years thereafter.



**ME 4875/MTE575. INTRODUCTION TO NANOMATERIALS AND NANOTECHNOLOGY.***Cat. I*

This course introduces students to current developments in nanoscale science and technology. The current advance of materials and devices constituting of building blocks of metals, semiconductors, ceramics or polymers that are nanometer size (1-100 nm) are reviewed. The profound implications for technology and science of this research field are discussed. The differences of the properties of matter on the nanometer scale from those on the macroscopic scale due to the size confinement, predominance of interfacial phenomena and quantum mechanics are studied. The main issues and techniques relevant to science and technologies on the nanometer scale are considered. New developments in this field and future perspectives are presented. Topics covered include: fabrication of nanoscale structures, characterization at nanoscale, molecular electronics, nanoscale mechanics, new architecture, nano-optics and societal impacts.

Recommended background: ES 2001 Introduction to Materials or equivalent

**ME 4922. THEORY AND PRACTICE OF LASER INSTRUMENTATION.***Cat. II*

This course introduces and analyzes the fundamentals of optical and image processing techniques applicable to engineering measurements. Optical instrumentation is widely used in high precision position, vibration, and inspection applications in the industrial environment. The goal of this course is to provide a rigorous background in the basic principles preparing the student for the more advanced courses on laser instrumentation. The course will include both in-class lectures and laboratories. Topics to be covered include: accelerated review of light, waves, and polarization; basic building blocks including lenses, detectors, optical components, and fiber optics; interferometry and coherence; basic holography and speckle; infrared temperature measurement; stress birefringence; basic video, imaging, and digital image processing.

Recommended background: mathematics (MA 2051), experimentation (ME 3901).

Suggested background: physics (PH 1140).

This course will be offered in 2008-09 and in alternating years thereafter.

**IS/P. SPECIAL TOPICS.***Cat. I*

For students who wish to pursue in depth various mechanical engineering topics.

Topics covered include: theoretical or experimental studies in subjects of interest to mechanical engineers.

Registration as a junior or senior is assumed.

---

## MILITARY SCIENCE

---

The intent of the Military Science program of courses is that they be taken in sequential order. Any student who wishes to depart from this recommendation must consult with the Military Science department head.

ML 1011 and ML 1021 will appear on the WPI transcript as a zero credit course with a grade. Successful completion of ML 1011 *and* ML 1012 earns 1/9 unit in ML 1012. Successful completion of ML 1021 *and* ML 1022 earns 1/9 unit in ML 1022.

**ML 1011. FOUNDATIONS OF OFFICERSHIP I.***Cat. I (0 units w/grade)*

Introduction to issues and competencies that are central to a commissioned officer's responsibilities. Establishes a framework for understanding officership, leadership, and Army values. Additionally, the semester addresses "life skills" including fitness and time management.

Participation in leadership laboratories and participation in off-campus training sessions (field training exercise) is also required.

**ML 1012. FOUNDATIONS OF OFFICERSHIP II.***Cat. I (1/9 unit after completion of 1011 and 1012)*

This course continues the studies begun in ML 1011. Students make oral presentations on the elements of leadership, enhancing effective communication. Students begin to develop leadership potential by instilling self-confidence and fostering teamwork through basic survival techniques (e.g., water survival).

Participation in leadership laboratories and participation in off-campus training sessions (field training exercise) is also required.

**ML 1021. BASIC LEADERSHIP I.***Cat. I (0 units w/grade)*

ML 1021 expands upon the fundamentals introduced in the previous term by focusing on communications, leadership, and problem solving. "Life skills" lessons in this semester include: problem solving, goal setting, interpersonal communication skills, and assertiveness skills.

Participation in leadership laboratories and participation in off-campus training sessions (field training exercise) is also required.

**ML 1022. BASIC LEADERSHIP II.***Cat. I (1/9 unit after completion of 1021 and 1022)*

ML 1022 continues by providing cadets with interesting lessons yielding immediately useful skills. The course also gives accurate information about life in the Army, including the organization of the Army, employment benefits, and work experiences of junior officers.

**ML 2011. INDIVIDUAL LEADERSHIP STUDIES I.***Cat. I (1/12 unit)*

Introduces students to team building techniques. Students build upon the basic leader principals and leadership development methodologies to refine their understanding of leadership. How to build teams, how to influence, how to communicate, how and when to make decision, and creative problem-solving.

Participation in leadership laboratories and participation in off-campus training session (field training exercise) is also required

Recommended background: ML1022

**ML 2012. INDIVIDUAL LEADERSHIP STUDIES II.***Cat. I (1/12 unit)*

The curriculum focuses on building character. Where years one, three and four focus on mastering definitions, concepts, ideas and principles, year two focuses on direct, physical experiences. Year two centers on giving cadets the opportunity to apply, practice and experience leadership principles. Cadets are asked to reflect upon their actions and those of others.

Participation in leadership laboratories and participation in off-campus training session (field training exercise) is also required.

Recommended background: ML 2011

**ML 2021. LEADERSHIP AND TEAMWORK I.***Cat. I (1/12 unit)*

Students continue the study of leader principals and are introduced to formal policies such as equal opportunity, ethics, and values. Military communication skills are trained along with the principles of camouflage. Complex cases of risk management are studied. Students will submit a written information paper.

Participation in leadership laboratories and participation in off-campus training session (field training exercise) is also required.

Recommended background: ML2012

**ML 2022. LEADERSHIP AND TEAMWORK II.***Cat. I (1/12 unit)*

This course covers small unit movement and military tactics. It combines previous study in weapons, movement and communications to teach the combination of firepower and maneuver to the student. This course also teaches the student the elements of how the military trains its personnel. A written decision paper and practical exercise in conducting training is included in this course.

Participation in leadership laboratories and participation in off-campus training session (field training exercise) is also required.

Recommended background: ML 2021

**ML 2091. LEADERSHIP TRAINING COURSE.***Cat. I (1/6 unit)*

LTC puts each cadet through 24 days of pushing themselves to the mental and physical limits, while enhancing leadership, problem solving and teamwork skills. Cadets are put through extensive leadership training, which includes leadership reaction scenarios; Land Navigation exercises, first aid training. Cadets must pass the Army Fitness Test (APFT) in order to graduate.

**ML 3011. LEADERSHIP AND PROBLEM SOLVING I.***Cat. I (1/6 unit)*

This course focuses on development of individual leadership abilities. This course reviews leadership styles, management strategies and training techniques for leaders of small units. Promoting and developing communication skills and teamwork are addressed. Examines leadership of small units conducting conventional combat operations and tactical employment of weapon systems. Development of oral communication skills through military briefings and issuance of operations orders. Special attention is placed on evaluations through practical exercises

Participation in leadership labs and participation in an off-campus training session (field training exercise) is also required.

Recommended background: Students must have completed the basic course or ROTC Leadership Training course and have signed a personal contract with the US Army. Department Head approval is required.

#### **ML 3012. LEADERSHIP AND PROBLEM SOLVING II.**

*Cat. I (1/6 unit)*

Student learns how to conduct crisis planning and management. Discussion of roles and functions of combat arms, combat support, and combat service support branches. Case studies of small-unit operations are studied. Introduction to Army special operations, military operations other than war, and trends in the military. Students write self-evaluations throughout this course. Students are graded on their performance during leadership practical exercises.

Attendance at monthly labs and formal social functions is required. Students write self-evaluations through this course. Students are graded on their performance during leadership practical exercises.

Recommended background: ML 3011

#### **ML 3021. LEADERSHIP AND ETHICS I.**

*Cat. I (1/6 unit)*

ML 3021 is designed to continue the development as leaders by presenting instruction in the three foundational areas of leadership, interpersonal communication, and values and ethics. The leadership module contains an examination of Army leadership doctrine followed by expansion on key leadership concepts and provide feedback for cadet leadership self-development efforts.

#### **ML 3022. LEADERSHIP AND ETHICS II.**

*Cat. I (1/6 unit)*

The main thrust of the communication module is the opportunity for cadets to present an information briefing and receive feedback from both instructor and fellow students. The last module of the term contains lessons that focus on values, ethics, ethical decision-making, consideration of others, and spiritual needs.

Attendance at monthly labs, attendance at formal social functions and an off-campus weekend leadership exercise is required.

Recommended background: ML 3021

#### **ML 3023. LEADERSHIP DEVELOPMENT AND ASSESSMENT COURSE.**

*Cat. I (1/6 unit)*

LDAC puts each cadet through 32 days of intensive individual, squad and platoon-level training to assess his/her leadership potential. Each cadet is measured against 23 leadership dimensions in such subjects as physical stamina, technical competence, delegation, decisiveness, problem analysis and the several Army values, among others. Instruction and evaluation at LDAC is progressive, building skills in individual subjects like the Army Physical Fitness Test, basic military skills and land navigation, followed by such skill-building exercises as Individual Tactical Training.

#### **ML 4011. LEADERSHIP AND MANAGEMENT I.**

*Cat. I (1/6 unit)*

ML 4011 begins with a series of lessons designed to enable the cadets to make informed career decisions as they prepare their accessions documents. Lessons concentrate on Army operations and training management, communications and leadership skills and support the beginning of the final transition from cadet to lieutenant. The course focuses cadets, early in the year, on attaining knowledge and proficiency in several critical areas they will need to operate effectively as Army officers. These areas include: the Army's training management system, coordinating activities with staffs, and counseling skills. While the proficiency attained in each of these areas will initially be at the apprentice level, cadets will continue to sharpen these skills as they perform their roles as cadet officers in the ROTC battalion and as new lieutenants after commissioning. At the end of this semester cadets should possess the fundamental skills, attributes, and abilities to operate as competent leaders in the cadet battalion and confidently shoulder the responsibilities entrusted to them.

#### **ML 4022. LEADERSHIP AND MANAGEMENT II.**

*Cat. I (1/6 unit)*

This Course focuses on completing the transition from cadet to lieutenant. As an expansion of the Ethics instruction in ML 3021, the course starts with an examination of unit ethical climate and the commander's role as the moral anchor of the unit. This is followed by a module addressing military law and leadership. The next module reinforces previous instruction on the organization of the Army and introduces how the Army organizes for operations from the tactical to strategic level. This is followed by instruction on administrative and

logistical management that focuses on the fundamentals of soldier and unit level support. Next is a short module that focuses on preparing cadets for their forthcoming commissioning and military service. At the core of this semester is the Advanced Course's Capstone Exercise. This twelve-lesson exercise directly reinforces all modules from this term, and also incorporates and reinforces many learning objectives from modules throughout the entire curriculum. The Capstone Exercise requires cadets, both individually and collectively, to apply their knowledge to solve problems and confront situations commonly faced by junior officers. Upon completion of this course the cadets will be prepared to shoulder the responsibility of being a commissioned officer in the United States Army.

Three lab exercises and participation in the military staff ride is required.

#### **ML 4023. OFFICERSHIP.**

*Cat. I (1/6 unit)*

This course is a continuation of ML 4022.

#### **ML 4024. TRANSITION TO LIEUTENANT.**

*Cat. I (1/6 unit)*

Cadets organize and lead all the junior cadets. This course covers the military legal system, personnel actions and personal finances. It certifies fundamental competencies in land navigation, tactics, counseling, and interpersonal communications.

This course requires three hours of class work and three hours of physical fitness per week. Three lab exercises and a formal military ball are required.

Recommended background: ML4023

## PHYSICAL EDUCATION

#### **PE 1001. INTRO TO GOLF & TENNIS.**

*Cat. I (1/12 unit)*

Introduction to the sports through skill development and play.

#### **PE 1002. INTRO TO VOLLEYBALL & SQUASH.**

*Cat. I (1/12 unit)*

Introduction to the sports through skill development and play.

#### **PE 1003. INTRO TO BOWLING & BADMINTON.**

*Cat. I (1/12 unit)*

Introduction to the sports through skill development and play.

#### **PE 1004. INTRO TO TABLE TENNIS, GOLF, & TENNIS.**

*Cat. I (1/12 unit)*

Introduction to the sports through skill development and play.

#### **PE 1005. INTRO TO RECREATIONAL SPORTS.**

*Cat. I (1/12 unit)*

This summer course introduces students to various sports through skill development and play. Possible sports taught include badminton, bowling, golf, racquetball, squash, swimming, table tennis, tennis, and volleyball.

#### **PE 1006. WELLNESS.**

*Cat. I (1/12 unit)*

Introductory course designed to acquaint students with knowledge and skills necessary to make choices that foster health and well-being.

#### **PE 1007. BASIC WATER SAFETY.**

*Cat. I (1/12 unit)*

For the beginner and intermediate swimmer. Students will learn about water recreational activities and how to remain safe while participating in them. Opportunity to learn the necessary means for safety in/near water and basic rescue techniques. Fee required.

#### **PE 1011. TOUCH FOOTBALL.**

*Cat. I (1/12 unit)*

Introduction to basic rules and individual/team skill development with practical application through game competition.

#### **PE 1012. BASKETBALL.**

*Cat. I (1/12 unit)*

Introduction to basic rules and individual/team skill development with practical application through game competition.

#### **PE 1013. SOFTBALL.**

*Cat. I (1/12 unit)*

Introduction to basic rules and individual/team skill development with practical application through game competition.

**PE 1014. BEGINNING TENNIS.***Cat. I (1/12 unit)*

Instruction will focus on basic strokes and techniques. Rules, strategy and play will be integrated as students' skills develop.

**PE 1015. BADMINTON & TABLE TENNIS.***Cat. I (1/12 unit)*

Instruction will focus on basic strokes and techniques. Rules, strategy and play will be integrated as students' skills develop.

**PE 1016. SQUASH & RACQUETBALL.***Cat. I (1/12 unit)*

Instruction will focus on basic strokes and techniques. Rules, strategy and play will be integrated as students' skills develop.

**PE 1017. BEGINNING SWIMMING.***Cat. I (1/12 unit)*

For the non-swimmer to intermediate swimmer. Instruction in the basic stroke techniques to learn to swim, improve skills and develop survival skills.

**PE 1018. CO-ED VOLLEYBALL.***Cat. I (1/12 unit)*

Introduction to basic rules and individual/team skill development with practical application through game competition.

**PE 1021. BOWLING.***Cat. I (1/12 unit)*

Introductory course designed to acquaint students with the basic skills, knowledge and practical experience.

**PE 1024. INTERMEDIATE TENNIS.***Cat. I (1/12 unit)*

Designed for the student with basic skills in tennis. In-depth instruction in skill development and strategy with game competition.

**PE 1055. PHYSICAL CONDITIONING.***Cat. I (1/12 unit)*

This course will teach basic strength training principles and techniques. Students will develop and implement an individualized conditioning program.

**PE 1056. LIFEGUARDING I.***Cat. I (1/12 unit)***PE 1057. LIFEGUARDING II.***Cat. I (1/12 unit)*

This class is based on the Red Cross Manual for Lifeguarding. Red Cross fee and books are required. The Lifeguard I course is the first part of a two course requirement (Lifeguarding I and II) for a student to be certified in CPR for the Professional Rescuer, First Aid, AED, Oxygen Administration and Lifeguarding.

Recommended background: PE 1007

**PE 1059. WEIGHT TRAINING PROGRAM FOR WOMEN.***Cat. I (1/12 unit)*

This introductory course is designed to acquaint women with circuit training and free weight programs.

**PE 1070. LEISURE EDUCATION: REDEFINING SOCIAL NORMS.***Cat. I (1/12 unit)*

Introductory course designed to explore various leisure education alternatives.

**PE 1077. SWIMMING FOR FITNESS.***Cat. I (1/12 unit)*

For the intermediate to advanced swimmer. This class is geared toward swimming for fitness purposes. Workouts will be administered each class period with students developing the knowledge to create workouts for themselves.

**PE 1100. SERIES.***Cat. I (1/12 unit)*

Credit for activity in one of five categories: 1) WPI athletic team participation, 2) club sports, 3) approved courses not offered at WPI, 4) individualized program at WPI, 5) Proficiency testing. Approval in advance by the Physical Education Department is necessary.

## PHYSICS

The second digit in physics course numbers is coded as follows.

- 1 — General physics
- 2 — Theoretical mechanics, statistical physics, kinetic theory, etc.
- 3 — Electricity and magnetism, electromagnetic theory
- 4 — Quantum mechanics
- 5 — Particular topics
- 6 — Laboratory

**INTRODUCTORY PHYSICS SEQUENCE**

There are four course topics in the introductory physics sequence. The four topics are Classical Mechanics (PH 1110/PH 1111), Electricity and Magnetism (PH 1120/PH 1121), 20th Century Physics (PH 1130), and Oscillations and Waves (PH 1140). Each course includes a laboratory component.

Students should take either PH 1110 or PH 1111, but not both; similarly, either PH 1120 or PH 1121, but not both. The primary difference between the PH 1110-PH 1120 option and PH 1111-PH 1121 is that the material in PH 1111-PH 1121 is treated somewhat more formally and rigorously than in PH 1110-PH 1120, thus presuming a better-than-average mathematics background. The recommended mathematics background for each course is indicated in the respective course description and should be considered carefully in each case.

Because the topics covered in the two mechanics and in the two electricity and magnetism courses are the same, it is possible to cross over from one sequence to the other. For example, PH 1120 could be taken after PH 1111, or, upon consulting with the course instructor, PH 1121 could be taken after successful completion of PH 1110. Finally, it should be noted that any combination of the first two introductory courses provides adequate preparation for both of the remaining courses in 20th Century Physics (PH 1130), and Oscillations and Waves (PH 1140).

The courses in classical mechanics and electricity and magnetism are regarded as essential preparation for many fundamental engineering courses as well as for further work in physics. PH 1130 gives a first introduction to 20th century physics and is designed to provide a context for the appreciation of present-day advances in physics and high-technology applications. PH 1140 deals in depth with oscillating systems, a topic area of fundamental importance in physics, and whose engineering applications span the range from electromagnetic oscillations to the mechanical vibrations of machinery and structures.

**PH 1110. GENERAL PHYSICS—MECHANICS.***Cat. I*

Introductory course in Newtonian mechanics.

Topics include: kinematics of motion, vectors, Newton's laws, friction, work-energy, impulse-momentum, for both translational and rotational motion.

Recommended background: concurrent study of MA 1021.

Students may not receive credit for both PH 1110 and PH 1111.

**PH 1111. PRINCIPLES OF PHYSICS—MECHANICS.***Cat. I*

An introductory course in Newtonian mechanics that stresses invariance principles and the associated conservation laws.

Topics include: kinematics of motion, vectors and their application to physical problems, dynamics of particles and rigid bodies, energy and momentum conservation, rotational motion.

Recommended background: concurrent study of MA 1023 (or higher).

Students with limited prior college-level calculus preparation are advised to take PH 1110.

Students may not receive credit for both PH 1111 and PH 1110.

**PH 1120. GENERAL PHYSICS—ELECTRICITY AND MAGNETISM.***Cat. I*

An introduction to the theory of electricity and magnetism.

Topics include: Coulomb's law, electric and magnetic fields, capacitance, electrical current and resistance, and electromagnetic induction.

Recommended background: working knowledge of the material presented in PH 1110 or PH 1111 and concurrent study of MA 1022.

Students may not receive credit for both PH 1120 and PH 1121.

**PH 1121. PRINCIPLES OF PHYSICS—ELECTRICITY AND MAGNETISM.***Cat. I*

An introduction to electricity and magnetism, at a somewhat higher mathematical level than PH 1120.

Topics include: Coulomb's Law, electric fields and potentials, capacitance, electric current and resistance, magnetism, and electromagnetic induction.

Recommended background: working knowledge of material covered in PH 1111 and concurrent study of MA 1024 (or higher). Students concurrently taking MA 1022 or MA 1023 are advised to take PH 1120.

Students may not receive credit for both PH 1121 and PH 1120.

### PH 1130. INTRODUCTION TO 20TH CENTURY PHYSICS.

#### *Cat. I*

An introduction to the pivotal ideas and developments of twentieth-century physics.

Topics include: special relativity, photoelectric effect, X-rays, Compton scattering, blackbody radiation, DeBroglie waves, uncertainty principle, Bohr theory of the atom, atomic nuclei, radioactivity, and elementary particles.

Recommended background: familiarity with material covered in PH 1110 and PH 1120 (or PH 1111 and PH 1121) and completion of MA 1021 and MA 1022.

### PH 1140. OSCILLATIONS, AND WAVES.

#### *Cat. I*

An introduction to oscillating systems and waves.

Topics include: free, clamped forced, and coupled oscillations of physical systems, traveling waves and wave packets, reflection, and interference phenomena.

Recommended background: working knowledge of the material covered in PH 1110 and PH 1120 (or PH 1111 and PH 1121) and completion of MA 1021, MA 1022 and MA 1023.

### PH 2201. INTERMEDIATE MECHANICS I.

#### *Cat. I*

This course emphasizes a systematic approach to the mathematical formulation of mechanics problems and to the physical interpretation of the mathematical solutions.

Topics covered include: Newton's laws of motion, kinematics and dynamics of a single particle, vector analysis, motion of particles, rigid body rotation about an axis.

Recommended background: PH 1110, PH 1120, PH 1130, PH 1140, MA 1021, MA 1022, MA 1023, MA 1024 and concurrent registration in or completion of MA 2051.

### PH 2202. INTERMEDIATE MECHANICS II.

#### *Cat. I*

This course is a continuation of the treatment of mechanics started in PH 2201.

Topics covered include: rigid-body dynamics, rotating coordinate systems, Newton's law of gravitation, central-force problem, driven harmonic oscillator, an introduction to generalized coordinates, and the Lagrangian and Hamiltonian formulation of mechanics.

### PH 2301. ELECTROMAGNETIC FIELDS.

#### *Cat. I*

Introduction to the theory and application of electromagnetic fields, appropriate as a basis for further study in electromagnetism, optics, and solid-state physics.

Topics: electric field produced by charge distributions, electrostatic potential, electrostatic energy, magnetic force and field produced by currents and by magnetic dipoles, introduction to Maxwell's equations and electromagnetic waves.

Recommended background: introductory electricity and magnetism, vector algebra, integral theorems of vector calculus as covered in MA 2251.

### PH 2501. PHOTONICS.

#### *Cat. II*

An introduction to the use of optics for transmission and processing of information. The emphasis is on understanding principles underlying practical photonic devices. Topics include lasers, light emitting diodes, optical fiber communications, fiber lasers and fiber amplifiers, planar optical waveguides, light modulators and photodetectors. Recommended background is PH 1110, PH 1120, PH 1130 and PH 1140 (or their equivalents).

This course will be offered in 2008-09 and in alternating years thereafter.

### PH 2502. LASERS.

#### *Cat. II*

An introduction to the physical principles underlying lasers and their applications. Topics will include the coherent nature of laser light, optical cavities, beam optics, atomic radiation, conditions for laser oscillation, optical amplifiers (including fiber amplifiers), pulsed lasers (Q switching and mode locking), laser excitation (optical and electrical), and selected laser applications. Recommended background is PH 1110, PH 1120, PH 1130 and PH 1140 (or their equivalents).

This course will be offered in 2009-10 and in alternating years thereafter.

### PH 2510. ATOMIC FORCE MICROSCOPY.

#### *Cat. II*

Atomic force microscopes (AFMs) are instruments that allow three-dimensional imaging of surfaces with nanometer resolution and are important enabling tools for nanoscience and technology. The student who successfully completes this course will understand the functional principles of AFMs, be able to run one, and interpret the data that are collected.

Recommended background: PH 1110 and 1120. Suggested background: PH 1130 and PH 1140.

This course will be offered in 2009-10 and in alternating years thereafter.

### PH 2520. INTRODUCTION TO ASTROPHYSICS.

#### *Cat. II*

A selective study of components of the universe (the solar system, stars, nebulae, galaxies) and of cosmology, based on astronomical observations analyzed and interpreted through the application of physical principles, and organized with the central purpose of presenting the latest understanding of the nature and evolution of the universe. Some topics to be covered include the Big Bang & Inflation; Stellar Behavior & Evolution; White Dwarfs, Neutron Stars, & Supernovae; Black Holes; Dark Matter & Dark Energy.

Recommended background is PH 1110 (or PH 1111), PH 1120 (or PH 1121), and especially PH 1130.

Suggested background: PH 1140.

This course will be offered in 2009-10 and in alternating years thereafter.

### PH 2601. PHOTONICS LABORATORY.

#### *Cat. II*

This course provides an experimental approach to concepts covered in Photonics (PH 2501), Lasers (PH 2502), and Optics (PH 3504). Through a series of individually tailored experiments, students will reinforce their knowledge in one or more of these areas, while at the same time gaining exposure to modern photonics laboratory equipment. Experiments available include properties of optical fibers, optical fiber diagnostics, optical communications systems, properties of photodetectors, mode structure and threshold behavior of lasers, coherence properties of laser light, characterization of fiber amplifiers, diffraction of light, polarization of light, interferometry.

Recommended background: PH 1110/1111, PH 1120/1121, PH 1130, PH 1140, and one or more of the courses PH 2501, PH 2502, or PH 3504. No prior laboratory background is expected.

This course will be offered in 2008-09 and in alternating years thereafter.

### PH 2651. INTERMEDIATE PHYSICS LABORATORY.

#### *Cat. I*

This course offers experience in experimentation and observation for students of the sciences and others. In a series of subject units, students learn or review the physical principles underlying the phenomena to be observed and the basis for the measurement techniques employed. Principles and uses of laboratory instruments including the cathode-ray oscilloscope, meters for frequency, time, electrical and other quantities are stressed. In addition to systematic measurement procedures and data recording, strong emphasis is placed on processing of the data, preparation and interpretation of graphical presentations, and analysis of precision and accuracy, including determination and interpretation of best value, measures of error and uncertainty, linear best fit to data, and identification of systematic and random errors. Preparation of high-quality experiment reports is also emphasized. Representative experiment subjects are: mechanical motions and vibrations; free and driven electrical oscillations; electric fields and potential; magnetic materials and fields; electron beam dynamics; optics; diffraction-grating spectroscopy; radioactive decay and nuclear energy measurements.

Recommended background: the Introductory Physics course sequence or equivalent. No prior laboratory background beyond that experience is required.

Students who have received credit for PH 2600 or PH 3600 may not receive credit for PH 2651.

### PH 3301. ELECTROMAGNETIC THEORY.

#### *Cat. I*

A continuation of PH 2301, this course deals with more advanced subjects in electromagnetism, as well as study of basic subjects with a more advanced level of mathematical analysis. Fundamentals of electric and magnetic fields, dielectric and magnetic properties of matter, quasi-static time-dependent phenomena, and generation and propagation of electromagnetic waves are investigated from the point of view of the classical Maxwell's equations.

### PH 3401. QUANTUM MECHANICS I.

#### *Cat. I*

This course includes a study of the basic postulates of quantum mechanics, its mathematical language and applications to one-dimensional problems. The course is recommended for physics majors and other students whose future work will involve the application of quantum mechanics.



Topics include wave packets, the uncertainty principle, introduction to operator algebra, application of the Schroedinger equation to the simple harmonic oscillator, barrier penetration and potential wells.

Recommended background: Junior standing, MA 4451, and completion of the introductory physics sequence, including the introduction to the 20th century physics.

Suggested background: knowledge (or concurrent study) of linear algebra, Fourier series, and Fourier transforms.

#### PH 3402. QUANTUM MECHANICS II.

*Cat. I*

This course represents a continuation of PH 3401 and includes a study of three-dimensional systems and the application of quantum mechanics in selected fields.

Topics include: the hydrogen atom, angular momentum, spin, perturbation theory and examples of the application of quantum mechanics in fields such as atomic and molecular physics, solid state physics, optics, and nuclear physics.

Recommended background: PH 3401.

#### PH 3501. RELATIVITY.

*Cat. II*

This course is designed to help the student acquire an understanding of the formalism and concepts of relativity as well as its application to physical problems.

Topics include the Lorentz transformation, 4-vectors and tensors, covariance of the equations of physics, transformation of electromagnetic fields, particle kinematics and dynamics.

Recommended background: knowledge of mechanics and electrostatics at the intermediate level.

This course will be offered in 2008-09 and in alternating years thereafter.

#### PH 3502. SOLID STATE PHYSICS.

*Cat. II*

An introduction to solid state physics.

Topics include: crystallography, lattice vibrations, electron band structure, metals, semiconductors, dielectric and magnetic properties.

Recommended background: prior knowledge of quantum mechanics at an intermediate level.

Suggested background: knowledge of statistical physics is helpful.

This course will be offered in 2008-09 and in alternating years thereafter.

#### PH 3503. NUCLEAR PHYSICS.

*Cat. II*

This course is intended to acquaint the student with the measurable properties of nuclei and the principles necessary to perform these measurements. The major part of the course will be an introduction to the theory of nuclei.

The principal topics will include binding energy, nuclear models and nuclear reactions. The deuteron will be discussed in detail and the nuclear shell model will be treated as well as the nuclear optical model.

Recommended background: some knowledge of the phenomena of modern physics at the level of an introductory physics course and knowledge of intermediate level quantum mechanics.

This course will be offered in 2009-10 and in alternating years thereafter.

#### PH 3504. OPTICS.

*Cat. II*

This course provides an introduction to classical physical optics, in particular interference, diffraction and polarization, and to the elementary theory of lenses. The theory covered will be applied in the analysis of one or more modern optical instruments.

Recommended background: knowledge of introductory electricity and magnetism and of differential equations.

Suggested background: PH 2301.

This course will be offered in 2009-10 and in alternating years thereafter.

#### PH 4201. ADVANCED CLASSICAL MECHANICS.

*Cat. I*

A review of the basic principles and introduction to advanced methods of mechanics, emphasizing the relationship between dynamical symmetries and conserved quantities, as well as classical mechanics as a background to quantum mechanics.

Topics include: Lagrangian mechanics and the variational principle, central force motion, theory of small oscillations, Hamiltonian mechanics, canonical transformations, Hamilton-Jacobi Theory, rigid body motion, and continuous systems.

Recommended background: PH 2201 and PH 2202.

This is a 14-week course.

#### PH 4206. STATISTICAL PHYSICS.

*Cat. I*

An introduction to the basic principles of thermodynamics and statistical physics.

Topics covered include: basic ideas of probability theory, statistical description of systems of particles, thermodynamic laws, entropy, microcanonical and canonical ensembles, ideal and real gases, ensembles of weakly interacting spin 1/2 systems.

Recommended background: knowledge of quantum mechanics at the level of PH 3401-3402 and of thermodynamics at the level of ES 3001.

## Graduate Physics Courses of Interest to Undergraduates

#### PH 511/PH 4201. CLASSICAL MECHANICS.

Lagrangian and Hamiltonian formulations. Central force motion. Rigid body dynamics. Theory of small oscillations. Poisson brackets, Hamilton-Jacobi theory. Continuous systems.

#### PH 514. QUANTUM MECHANICS I.

Schroedinger wave equation. Harmonic oscillator, hydrogen atom, potential wells, approximation methods.

#### PH 515. QUANTUM MECHANICS II.

Perturbation theory. Angular momentum. Spin. Scattering theory. Dirac equation.

#### PH 522. THERMODYNAMICS AND STATISTICAL MECHANICS.

Quantum concepts applied to thermodynamics. Bose-Einstein and Fermi-Dirac statistics.

#### PH 533. ADVANCED ELECTROMAGNETIC THEORY.

Classical electrodynamics and radiation theory.

## ROBOTICS ENGINEERING

#### RBE 1001. INTRODUCTION TO ROBOTICS (FORMERLY ES 2201).

*Cat. I*

Multidisciplinary introduction to robotics, involving concepts from the fields of electrical engineering, mechanical engineering and computer science. Topics covered include sensor performance and integration, electric and pneumatic actuators, power transmission, materials and static force analysis, controls and programmable embedded computer systems, system integration and robotic applications. Laboratory sessions consist of hands-on exercises and team projects where students design and build mobile robots.

Undergraduate credit may not be earned for both this course and for ES 2201.

Recommended background: mechanics (PH 1110/PH 1111). Suggested background: electricity and magnetism (PH 1120/PH 1121), may be taken concurrently.

#### RBE 2001. UNIFIED ROBOTICS I.

*Cat. I*

First of a four-course sequence introducing foundational theory and practice of robotics engineering from the fields of computer science, electrical engineering and mechanical engineering. The focus of this course is the effective conversion of electrical power to mechanical power, and power transmission for purposes of locomotion, and of payload manipulation and delivery. Concepts of energy, power and kinematics will be applied. Concepts from statics such as force, moments and friction will be applied to determine power system requirements and structural requirements. Simple dynamics relating to inertia and the equations of motion of rigid bodies will be considered. Power control and modulation methods will be introduced through software control of existing embedded processors and power electronics. The necessary programming concepts and interaction with simulators and Integrated Development Environments will be introduced. Laboratory sessions consist of hands-on exercises and team projects where students design and build robots and related sub-systems.

Recommended background: ES 2201/RBE 1001, ES 2501 (can be taken concurrently), ECE 2022.

#### RBE 2002. UNIFIED ROBOTICS II.

*Cat. I*

Second of a four-course sequence introducing foundational theory and practice of robotics engineering from the fields of computer science, electrical engineering and mechanical engineering. The focus of this course is interaction with the environment through sensors, feedback and decision processes. Concepts of stress and strain as related to sensing of force, and principles of operation and

interface methods for electronic transducers of strain, light, proximity and angle will be presented. Basic feedback mechanisms for mechanical systems will be implemented via electronic circuits and software mechanisms. The necessary software concepts will be introduced for modular design and implementation of decision algorithms and finite state machines. Laboratory sessions consist of hands-on exercises and team projects where students design and build robots and related sub-systems.

Recommended background: RBE 2001, CS 1101 or CS 1102

### RBE 3001. UNIFIED ROBOTICS III.

#### *Cat. I*

Third of a four-course sequence introducing foundational theory and practice of robotics engineering from the fields of computer science, electrical engineering and mechanical engineering. The focus of this course is actuator design, embedded computing and complex response processes. Concepts of dynamic response as relates to vibration and motion planning will be presented. The principles of operation and interface methods various actuators will be discussed, including pneumatic, magnetic, piezoelectric, linear, stepper, etc. Complex feedback mechanisms will be implemented using software executing in an embedded system. The necessary concepts for real-time processor programming, re-entrant code and interrupt signaling will be introduced. Laboratory sessions will culminate in the construction of a multi-module robotic system that exemplifies methods introduced during this course.

Recommended background: RBE 2002, ECE 2801, CS 2223, MA 2051

This course will be offered starting in 2008-09.

### RBE 3002. UNIFIED ROBOTICS IV.

#### *Cat. I*

Fourth of a four-course sequence introducing foundational theory and practice of robotics engineering from the fields of computer science, electrical engineering and mechanical engineering. The focus of this course is navigation, position estimation and communications. Concepts of dead reckoning, landmark updates, inertial sensors, vision and radio location will be explored. Control systems as applied to navigation will be presented. Communication, remote control and remote sensing for mobile robots and tele-robotic systems will be introduced. Wireless communications including wireless networks and typical local and wide area networking protocols will be discussed. Considerations will be discussed regarding operation in difficult environments such as underwater, aerospace, hazardous, etc. Laboratory sessions will be directed towards the solution of an open-ended problem over the course of the entire term.

Recommended background: RBE 3001. Suggested background: ES 3011

This course will be offered starting in 2008-09.

### RBE/ME 4322. MODELING AND ANALYSIS OF MECHATRONIC SYSTEMS.

#### *Cat. I*

This course introduces students to the modeling and analysis of mechatronic systems. Creation of dynamic models and analysis of model response using the bond graph modeling language are emphasized. Lecture topics include energy storage and dissipation elements, transducers, transformers, formulation of equations for dynamic systems, time response of linear systems, and system control through open and closed feedback loops. Computers are used extensively for system modeling, analysis, and control. Hands-on projects will include the reverse engineering and modeling of various physical systems. Physical models may sometimes also be built and tested.

Recommended background: mathematics (MA 2051, MA 2071), fluids (ES 3004), thermodynamics (ES 3001), mechanics (ES 2501, ES 2503)

### RBE/ME 4815. INDUSTRIAL ROBOTICS.

#### *Cat. I*

This course introduces students to robotics within manufacturing systems. Topics include: classification of robots, robot kinematics, motion generation and transmission, end effectors, motion accuracy, sensors, robot control and automation. This course is a combination of lecture, laboratory and project work, and utilizes industrial robots. Through the laboratory work, students will become familiar with robotic programming (using a robotic programming language VAL II) and the robotic teaching mode. The experimental component of the laboratory exercise measures the motion and positioning capabilities of robots as a function of several robotic variables and levels, and it includes the use of experimental design techniques and analysis of variance.

Recommended background: manufacturing (ME 1800), kinematics (ME 3310), control (ES 3011), and computer programming.

## SOCIAL SCIENCE AND POLICY STUDIES

ECON	Economics
GOV	Political Science, Government and Law
PSY	Psychology
SD	System Dynamics
SOC	Sociology
SS	General Social Science
STS	Society/Technology Studies

### ECONOMICS (ECON)

#### ECON 1110. INTRODUCTORY MICROECONOMICS.

##### *Cat. I*

The course focuses upon the implications of reliance upon markets for the allocation of resources in a society, at the household, firm, and community level. Outcomes of current market systems are examined in terms of the efficient use of natural and other economic resources, as well as their impact upon the environment, fairness, and social welfare. Of special interest in these analyses is the role of prices in the determination of what commodities are produced, their means of production, and distribution among households. In cases where current market outcomes have features subject to widespread criticism, such as the presence of excessive pollution, risk, discrimination, and poverty, the analysis is extended to suggest economic solutions. There are no prerequisites for the course.

#### ECON 1120. INTRODUCTORY MACROECONOMICS.

##### *Cat. I*

This course is designed to acquaint students with the ways in which macroeconomic variables such as national income, employment and the general level of prices are determined in an economic system. It also includes a study of how the techniques of monetary policy and fiscal policy attempt to achieve stability in the general price level and growth in national income and employment. The problems of achieving these national goals (simultaneously) are also analyzed. The course stresses economic issues in public policy and international trade.

#### ECON 1130. INTRODUCTION TO ECONOMETRIC MODELING.

##### *ISP Only*

The purpose of this course is to provide students with an introduction to econometric modeling as it is applied in economics and to illustrate how it can be used in harmony with, or as an alternative to, system dynamics modeling. The first quarter of the course is devoted to discussing the methodological similarities and differences between econometric and system dynamics modeling, acquainting students with both the primary (survey instruments and controlled experiments) and secondary (government agencies and NGOs) sources of economic and social science data, and reviewing the basics of descriptive and inferential statistics. The remaining three quarters of the course are devoted to an examination of the assumptions that underlie the ordinary least squares model, the problems that occur when these assumptions are violated, and the methods that are available for correcting these problems. Throughout this process, the use of socioeconomic data, and the roles of economic theory and econometric software in modeling are emphasized. The course concludes with a presentation of how the econometric modeling can be used to complement system dynamics modeling.

#### ECON 2110. INTERMEDIATE MICROECONOMICS.

##### *Cat. II*

The topics addressed in this course are similar to those covered in ECON 1110 (Introductory Microeconomics) but the treatment proceeds in a more rigorous and theoretical fashion to provide a firm platform for students majoring in Economics or Management, or those having a strong interest in economics. Mathematics at a level comparable to that taught in MA 1021-MA 1024 is frequently applied to lend precision to the analysis. The course rigorously develops the microeconomic foundations of the theory of the firm, the theory of the consumer, the theory of markets, and the conditions required for efficiency in economic systems. Recommended background: ECON 1110.

This course will be offered in 2009-10 and in alternating years thereafter.



**ECON 2117. ENVIRONMENTAL ECONOMICS.***Cat. II*

This course investigates the effect of human activity upon the environment as well as the effect of the environment on human well-being. It pays special attention to the impact of production and consumption of material goods upon the quantity and quality of environmental goods. The analysis focuses on the challenges presented in mixed economies where markets are combined with government intervention to manage pollution and scarcity. The course reviews efforts to measure the costs and benefits of improving environmental conditions and evaluates current and potential policies in terms of the costs of the environmental improvements they may yield. Attention is also paid to the special difficulties which arise when the impacts of pollution spill across traditional political boundaries. Recommended background: ECON 1110.

This course will be offered in 2008-09 and in alternating years thereafter.

**ECON 2120. INTERMEDIATE MACROECONOMICS.***Cat. II*

This course is an advanced treatment of macroeconomic theory well suited for students majoring in Economics or Management, or others with a strong interest in economics. The topics addressed in ECON 2120 are similar to those covered in ECON 1120, however the presentation of the material will proceed in a more rigorous and theoretical fashion.

Recommended background: ECON 1110.

This course will be offered in 2008-09 and in alternating years thereafter.

**ECON 2125. DEVELOPMENT ECONOMICS.***Cat. II*

This course is a general introduction to the field of development economics. The focus is on ways in which a developing country can increase its productive capacity, both agricultural and industrial, in order to achieve sustained economic growth. The course proceeds by first examining how economic growth and economic development are measured and how the various nations of the world compare according to well-known social and economic indicators. Theories of economic growth and theories of economic development are then examined, as are the various social and cultural structures that are thought to influence economic progress. The inputs to economic growth and development (land, labor, capital, entrepreneurial ability, education, technical change), and the possible distributions of income and levels of employment that result from their use, is considered next. Domestic economic problems and policies such as development planning, the choice of sectorial policies, the choice of monetary and fiscal policies, rapid population growth, and urbanization and urban economic development are then examined. The course concludes with a consideration of international problems and policies such as import substitution and export promotion, foreign debt, foreign investment, and the role of international firms. In conjunction with a traditional presentation of the above topics, the course curriculum will include the use of computer simulation models and games. These materials have been formulated with a simulation technique, system dynamics, that has its origins in control engineering and the theory of servomechanisms. As a result, students will find them complementary to their work in engineering and science. In addition, the various development theories and simulation and gaming results will be related, where possible, to specific developing nations where WPI has on-going project activities (e.g., Costa Rica and Thailand). This course is recommended for those students wishing to do an IQP or MQP in a developing nation.

Recommended background: ECON 1120.

This course will be offered in 2009-10 and in alternating years thereafter.

---

**POLITICAL SCIENCE, GOVERNMENT AND LAW  
(GOV)**

---

**GOV 1301. U.S. GOVERNMENT.***Cat. I*

This course is an introduction to the fundamental principles, institutions, and processes of the constitutional democracy of the United States. It examines the formal structure of the Federal system of government, including Congress, the presidency, the judiciary, and the various departments, agencies, and commissions which comprise the executive branch. Emphasis is placed on the relationships among Federal, state and local governments in the formulation and administration of domestic policies, and on the interactions among interest groups, elected officials and the public at large with administrators in the policy process. The various topics covered in the survey are linked by consideration of fiscal and budgetary issues, executive management, legislative oversight, administrative discretion, policy analysis and evaluation and democratic accountability. May be included in certain Humanities and Arts programs. See page 29.

**GOV 1303. AMERICAN PUBLIC POLICY.***Cat. I*

American Public Policy focuses on the outcomes or products of political institutions and political controversy. The course first addresses the dynamics of policy formations and stalemate, the identification of policy goals, success and failure in implementation, and techniques of policy analysis. Students are then encouraged to apply these concepts in the study of a specific policy area of their choosing, such as foreign, social, urban, energy or environmental policy. This course is an important first step for students wishing to complete IQPs in public policy research. Students are encouraged to complete GOV 1303 prior to enrolling in upper level policy courses such as GOV 2303, GOV 2304 or GOV 2311. There is no specific preparation for this course, but a basic understanding of American political institutions is assumed.

**GOV 1310. LAW, COURTS, AND POLITICS.***Cat. II*

This course is an introduction to law and the role courts play in society. The course examines the structure of judicial systems, the nature of civil and criminal law, police practice in the enforcement of criminal law, and the responsibilities of judges, attorneys and prosecutors. Additional topics for discussion include the interpretation of precedent and statute in a common law system and how judicial discretion enables interest groups to use courts for social change. The student is expected to complete the course with an understanding of how courts exercise and thereby control the power of the state. As such, courts function as political actors in a complex system of governance. It is recommended that students complete this course before enrolling in GOV 2310, Constitutional Law.

This course will be offered in 2009-10 and in alternating years thereafter.

**GOV 1320. TOPICS IN INTERNATIONAL POLITICS.***Cat. II*

GOV 1320 is a survey course designed to introduce students to the basic concepts of international relations: power and influence, nations and states, sovereignty and law. These concepts will be explored through the study of issues such as diplomacy and its uses, theories of collective security and conflict, and international order and development. The study of international organizations such as the UN, the European Union or the Organization of American States will also supplement the students' understanding of the basic concepts. The course may also include comparative political analysis of states or regions. It is designed to provide the basic background materials for students who wish to complete IQPs on topics that involve international relations or comparative political systems.

This course will be offered in 2008-09 and in alternating years thereafter.

**GOV 2302. SCIENCE-TECHNOLOGY POLICY.***Cat. II*

This course is an examination of the relationship between science-technology and government. It reviews the history of public policy for science and technology, theories and opinions about the proper role of government and several current issues on the national political agenda. Examples of these issues include genetic engineering, the environment and engineering education. It also examines the formation of science policy, the politics of science and technology, the science bureaucracy, enduring controversies such as public participation in scientific debates, the most effective means for supporting research, and the regulation of technology. Throughout the course we will pay particular attention to the fundamental theme: the tension between government demands for accountability and the scientific community's commitment to autonomy and self-regulation.

Recommended background: GOV 1301 or GOV 1303.

This course will be offered in 2008-09 and in alternating years thereafter.

**GOV 2304. GOVERNMENTAL DECISION MAKING AND ADMINISTRATIVE LAW.***Cat. II*

The course addresses the role of technical expertise in political decision making. Politicians and public administrators rely on the expert knowledge of scientists and engineers to "bring reason" to otherwise political decisions. The course specifically addresses decision making in the administrative context including the value of expert knowledge, circumstances of inadequate information and the need to accommodate the political agenda. The context for the discussion will be the problems of regulated industries (for example, energy or those industries subject to environmental regulation). Legal review of administrative decision making will also be addressed.

Recommended background: GOV 1301 or GOV 1303 or GOV 2310.

This course will be offered in 2008-09 and in alternating years thereafter.

**GOV 2310. CONSTITUTIONAL LAW: FOUNDATIONS OF GOVERNMENT.***Cat. II*

Constitutional Law is the study of Supreme Court decisions interpreting the U. S. Constitution. The Foundations course focuses on the powers of the Congress, the Presidency and the Judicial Branch, especially the Supreme Court's understanding of its own power. These cases reveal, in particular, the evolution of Federal power with the development of a national economy and the shifting balance of power among the three branches of government. Issues of state power in a federal system are also addressed. Lastly, these materials are examined in the context of the great debates regarding how judges interpret the Constitution. How are the words and intent of the Founders applicable to the legal and political conflicts of the twenty-first century?

This course will be offered in 2008-09 and in alternating years thereafter.

**GOV 2311. ENVIRONMENTAL POLICY AND LAW.***Cat. I*

This course deals with environmental law as it relates to people, pollution and land use in our society. A case method approach will be used to illustrate how the courts and legislators have dealt with these social-legal problems. The course is designed to have the student consider: 1) the legal framework within which environmental law operates; 2) the governmental institutions involved in the formulation, interpretation and application of environmental law; 3) the nature of the legal procedures and substantive principles currently being invoked to resolve environmental problems; 4) the types of hazards to the environment presently subject to legal constraints; 5) the impact that the mandates of environmental law have had, and will have, on personal liberties and property rights; 6) the role individuals and groups can play within the context of our legal system to protect and improve man's terrestrial habitat and the earth's atmosphere; and 7) some methods and sources for legal research that they may use on their own.

Recommended background: GOV 1303 or GOV 1310.

**GOV 2312. INTERNATIONAL ENVIRONMENTAL POLICY.***Cat. II*

Environmental issues present some of the major international problems and opportunities facing the world today. Worst-case scenarios envision irrevocable degradation of the earth's natural systems, but virtually every analysis sees the need for major change worldwide to cope with problems such as global warming, deforestation, ozone layer depletion, loss of biodiversity, and population growth, not to mention exponential increases in "conventional" pollutants in newly industrialized countries. The global environment issues represent a "second-generation" of environmental policy in which the focus of concern has moved from national regulations to international law and institutions. In addition, the environment has emerged as a major aspect of international trade, conditioning corporate investment and accounting for some \$200 billion in sales of pollution control equipment in 1991. Exploration of the genesis and implications of these phenomena is the essence of the course. Typically, the material begins with the nature of global environmental problems, drawing on literature from large-scale global modeling as well as particular analyses of the problems mentioned above. Approximately half the course focuses on international laws and institutions, including multilateral treaties (e. g., the Montreal Protocol limiting CFC use, ocean dumping, biodiversity), international institutions (UNEP, the Rio Convention, the OECD) and private initiatives (international standards organizations, ICOLP (Industry Committee for Ozone Layer Protection), etc.) In addition, US policy toward global environmental issues will be compared with that in Japan, Europe and developing countries, from which it differs significantly. Students will design and undertake term projects that address particular issues in detail in an interdisciplinary manner.

Recommended background: GOV 1303.

This course will be offered in 2009-10 and in alternating years thereafter.

**GOV 2313. INTELLECTUAL PROPERTY LAW.***Cat. II*

Intellectual property includes ideas, and the works of inventors, authors, composers and other creative people. Patents, copyrights and trademarks establish legal rights in intellectual property. Alternatively, control over the use of an idea might be maintained by treating it as a trade secret. In these ways, the ideas of inventors and creators are protected and others are prohibited from appropriating the ideas and creative works of others. This course addresses the concept of intellectual property and the public policies that support the law of patent, copyright and trademark. Subjects include the process of obtaining patents, trademarks and copyrights; requirements of originality and, for patents, utility; infringement issues; and the problems posed by international trade and efforts to address them through the World Intellectual Property Organization.

Recommended background: GOV 1310 or GOV 2310.

This course will be offered in 2009-10 and in alternating years thereafter.

**GOV /ID 2314. CYBERLAW AND POLICY.***Cat. II*

Rapidly developing technologies for computing, information management and communications have been quickly adopted in schools, businesses and homes. The growth of the Internet and of e-commerce, in particular, have given rise to an entirely new set of legal issues as the courts, Congress and international bodies struggle to keep pace with changing technology. This course addresses the government's role in the development of these technologies and the legal issues that result including questions regarding privacy rights, speech and defamation, and the application of patent and copyright law. Policy questions such as surveillance of e-mail, regulation of content, mandates on the use of filters, and the responsibilities and liability of internet service providers are also discussed. Additional policies studied include attempts to control Internet content and enforce international judgments (resulting from e-commerce or cyber-crime) by foreign states and/or international organizations. Students are expected to integrate knowledge of technology with law, politics, economics and international affairs.

This course will be offered in 2008-09 and in alternating years thereafter.

**GOV 2320. CONSTITUTIONAL LAW: CIVIL RIGHTS AND LIBERTIES.***Cat. II*

Civil Rights and Liberties examines decisions of the Supreme Court which interpret the Bill of Rights and the Equal Protection Clause of the 14th Amendment. These court decisions elaborate the content and meaning of our rights to speak, publish, practice religion, and be free from state interference in those activities. Privacy rights broadly, the right to be free from unreasonable search and seizure, and due process rights for criminal suspects are also addressed. Finally, rights to be free from discrimination based on race, religion, ethnicity, gender and sexual orientation are examined in the context of equal protection law.

Students completing this course will receive credit toward the Minor in Law and Technology among the courses satisfying the requirement in "legal fundamentals."

This course will be offered in 2009-10 and in alternating years thereafter.

---

**PSYCHOLOGY (PSY)**

---

**PSY 1400. INTRODUCTION TO PSYCHOLOGICAL SCIENCE.***Cat. I*

Psychological science is the experimental study of human thought and behavior. Its goal is to contribute to human welfare by developing an understanding of why people do what they do. Experimental psychologists study the entire range of human experience, from infancy until death, from the most abnormal behavior to the most mundane, from the behavior of neurons to the actions of nations. This course offers a broad introduction to important theories, empirical findings, and applications of research in psychological science. Topics will include: use of the scientific method in psychology, evolutionary psychology, behavioral genetics, the anatomy and function of the brain and nervous system, learning, sensation and perception, memory, consciousness, language, intelligence and thinking, life-span development, social cognition and behavior, motivation and emotion, and the nature and treatment of psychological disorders.

**PSY 1401. COGNITIVE PSYCHOLOGY.***Cat. I*

This course is concerned with understanding and explaining the mental processes and strategies underlying human behavior. The ways in which sensory input is transformed, reduced, elaborated, stored, and recovered will be examined in order to develop a picture of the human mind as an active processor of information. Topics will include perception, memory, problem-solving, judgment and decision making, human-computer interaction, and artificial intelligence. Special attention will be paid to defining the limitations of the human cognitive system. Students will undertake a project which employs one of the experimental techniques of cognitive psychology to collect and analyze data on a topic of their own choosing.

Suggested background: PSY 1400.

**PSY 1402. SOCIAL PSYCHOLOGY.***Cat. I*

Social psychology is concerned with how people think about, feel for, and act toward other people. Social psychologists study how people interact by focusing on the individual (not society as a whole) as the unit of analysis, by emphasizing the effect on the individual of the situation or circumstances in which behavior occurs, and by acquiring knowledge through empirical scientific investigation. This course will examine the cause of human behavior in a variety of domains of social life. Topics will include, but not be limited to, person perception, attitude formation and change, interpersonal attraction, stereotyping and prejudice, and

small group behavior. Special attention will be given to applied topics: How can the research methods of social psychology be used to help solve social problems? Students will work together in small groups to explore in depth topics in social psychology of their own choosing. May be included in certain Humanities and Arts programs. See page 29.

Suggested background: PSY 1400.

#### **PSY 1403. THE PSYCHOLOGY OF WORK.**

##### *Cat. I*

This course enables the undergraduate student to develop a conceptual framework, using cognitive and social psychological principles for understanding technology and workplace environments. Topics covered are designed to demonstrate the relationship among the individual, group and organizational effectiveness, job satisfaction and quality of work life. Emphasis is placed on variables related to the employee (for example, engineer) in the workplace. Issues of leadership, communication, organizational culture, risk-taking, job satisfaction, stress, motivation and group dynamics are discussed in the context of technology, science and workplace environments. Students will have the opportunity to learn by practicing skills through experiential linked exercises such as group discussions, presentations, and role-playing.

Suggested background: PSY 1400.

#### **PSY 1504. STRATEGIES FOR IMPROVING COGNITIVE SKILLS.**

##### *Cat. I*

Life experience provides us with little insight into the basic workings of our own minds. As a result, we tend to approach many of the important problems and decisions of our professional and personal lives with only a dim awareness of the limitations and capabilities of the human cognitive system and how its performance can be improved. The purpose of this course is (1) to provide students with the basic psychological knowledge needed to understand and evaluate such important cognitive skills as memory, problem solving, decision making, and reasoning and (2) to provide students the practical skills and experience necessary to improve and assess their cognitive performance. Topics will include but not be limited to memory improvement, study skills, effective problem solving techniques, creativity, numeracy, making effective choices, risky decision making, dynamic decision making, intelligent criticism of assumptions and arguments, and evaluating claims about the mind.

Suggested background: PSY 1400.

#### **PSY 2401. THE PSYCHOLOGY OF EDUCATION.**

##### *Cat. II*

This course is concerned with the learning of persons in educational settings from pre-school through college. Material in the course will be organized into five units covering a wide range of topics: Unit 1: Understanding Student Characteristics - Cognitive, Personality, Social, and Moral Development; Unit 2: Understanding the Learning Process - Behavioral, Humanistic, and Cognitive Theories of Learning; Unit 3: Understanding Motivation to Learn; Unit 4: Understanding Student Diversity - Cultural, Economic, and Gender Effects upon Learning; Unit 5: Evaluating Student Learning - Standardized Tests, Intelligence, Grades, and other Assessment Issues. Students planning IQPs in educational settings will find this course particularly useful. Instructional methods will include: lecture, discussion, demonstration, and project work. Course will also focus on current issues in technological education and international higher education.

Recommended background: PSY 1400 or PSY 1401.

This course will be offered in 2009-10, and in alternating years thereafter.

#### **PSY 2405. ENVIRONMENTAL PROBLEMS AND HUMAN COGNITION.**

##### *Cat. II*

This course examines how people think about the environment. Any environmental problem, whether local, regional, or global, can ultimately be attributed to the environmental decisions and actions of human beings. These behaviors can in turn be understood as resulting from the nature and limitations of the human mind. Knowledge of the root psychological causes of environmentally harmful behavior is essential for designing effective solutions to environmental problems. The goals of the course are (1) to provide students with the basic psychological knowledge needed to understand and evaluate the behavioral aspects of such important environmental problems as air and water pollution, global warming, ozone depletion, preserving biological diversity, and hazardous waste and (2) to help students identify and improve shortcomings in their personal knowledge and daily life decisions related to the environment. Topics will include, but not be limited to: environmental problems as "tragedies of the commons"; public understanding of global warming and global climate modeling; folk biology; risk perception; intelligent criticism of environmental

claims; making effective personal environmental choices; strategies for promoting pro-environmental behavior; systems thinking; use of computer simulation to learn about environmental issues; and human ability to model and manage the global environmental future.

Recommended background: PSY 1400, PSY 1401 or PSY 1402.

This course will be offered in 2009-10 and in alternate years thereafter.

#### **PSY 2406. CROSS-CULTURAL PSYCHOLOGY: HUMAN BEHAVIOR IN GLOBAL PERSPECTIVE.**

##### *Cat. II*

This course is an introduction to the study of the ways in which social and cultural forces shape human behavior. Cross-Cultural psychology takes a global perspective of human behavior that acknowledges both the uniqueness and interdependence of peoples of the world. Traditional topics of psychology (learning, cognition, personality development) as well as topics central to social psychology, such as intergroup relations and the impact of changing cultural settings, will be explored. Cultural influences on technology development and transfer, as they relate to and impact upon individual behavior, will also be investigated. Students preparing to work at international project centers, International Scholars, and students interested in the global aspects of science and technology will find the material presented in this course especially useful.

Recommended background: PSY 1400 or PSY 1402.

This course will be offered in 2008-09 and in alternating years thereafter.

---

## **SYSTEM DYNAMICS (SD)**

---

#### **SD 1510. INTRODUCTION TO SYSTEM DYNAMICS MODELING.**

##### *Cat. I*

The goal of this course is to provide students with an introduction to the field of system dynamics computer simulation modeling. The course begins with the history of system dynamics and the study of why policy makers can benefit from its use. Next, students systematically examine the various types of dynamic behavior that socioeconomic systems exhibit and learn to identify and model the underlying nonlinear stock-flow-feedback loop structures that cause them. The course concludes with an examination of a set of well-known system dynamics models that have been created to address a variety of socioeconomic problems. Emphasis is placed on how the system dynamics modeling process is used to test proposed policy changes and how the implementation of model-based results can improve the behavior of socioeconomic systems.

#### **SD 1520. SYSTEM DYNAMICS MODELING.**

##### *Cat. I*

The purpose of this course is to prepare students to produce original system dynamics computer simulation models of economic and social systems. Models of this type can be used to examine the possible impacts of policy changes and technological innovations on socioeconomic systems. The curriculum in this course is divided into three distinct parts. First, a detailed examination of the steps of the system dynamics modeling process: problem identification (including data collection), feedback structure conceptualization, model formulation, model testing and analysis, model documentation and presentation, and policy implementation. Second, a survey of the "nuts and bolts" of continuous simulation modeling: information and material delays, time constants, the use of noise and numerical integration techniques, control theory heuristics, and software details (both simulation and model presentation and documentation software). Third, a step-by-step, in-class production of a model, involving the construction, testing, and assembly of subsectors. Students will be required to complete modeling assignments working in groups and take in-class quizzes on modeling issues.

Recommended background: SD1510, or permission of instructor.

#### **SD 2530. ADVANCED TOPICS IN SYSTEM DYNAMICS MODELING.**

##### *ISP Only*

This course will focus on advanced issues and topics in system dynamics computer simulation modeling. A variety of options for dealing with complexity through the development of models of large-scale systems and the partitioning complex problems will be discussed. Topics will include an extended discussion of model analysis, the use of summary statistics and sensitivity measures, the model validation process, and policy design. The application of system Dynamics to theory building and social policy are also reviewed. Complex nonlinear dynamics and the chaotic behavior of systems will be discussed. Students will be assigned group exercises centering on model analysis and policy design.

Recommended background: SD 1520.



**SD 3550. SYSTEM DYNAMICS SEMINAR.***ISP Only*

This special topics course is designed primarily for system dynamics majors and students presently engaged in planning system dynamics projects. The course will be conducted as a research seminar, with many sessions being reserved for student presentations. Classical system dynamics models will be replicated and discussed. Students will read, evaluate, and report on research papers representing the latest developments in the field of system dynamics. They will also complete a term project that addresses a specific problem using the system dynamics method.

Recommended background: SD 1520 and SD 2530.

**SOCIOLOGY (SOC)****SOC 1202. INTRODUCTION TO SOCIOLOGY AND CULTURAL DIVERSITY.***Cat. I*

The Introduction to Sociology and Cultural Diversity is a Macro-Sociology course on modernization that incorporates a systematic comparison of one of the most and one of the least modernized regions of the World; Europe and the Middle East. However, the focus is on concepts used to describe how the social structure, culture and nature of community were affected by this massive social transition, and how to do qualitative comparative research at the level of whole societies. The field of sociology was created in the 19th century to try to understand the social changes and trends (ranging from social differentiation and demographic transition to the emergence of bureaucracy and secularization) that were sweeping Europe as the area industrialized. Trying to understand what new kind of society was being born amidst the ruins of the old order was the task of Sociology, the new science of society.

The course is designed to give students planning to go to Europe to do project work a chance to learn about the country they will be visiting, while giving everyone a chance to learn something about the Middle East..

**GENERAL SOCIAL SCIENCE (SS)****SS/ID 2050. SOCIAL SCIENCE RESEARCH FOR THE IQP.***Cat. I*

This course is open to students accepted to off-campus IQP centers and programs. The course introduces students to research design, methods for social science research, and analysis. It also provides practice in specific research and field skills using the project topics students have selected in conjunction with sponsoring agencies. Students learn to develop social science hypotheses based upon literature reviews in their topic areas and apply concepts drawn from social psychology, anthropology, sociology, economics and other areas as appropriate. Students make presentations, write an organized project proposal, and develop a communication model for reporting their project findings.

**SS 2400. METHODS, MODELING, AND ANALYSIS IN SOCIAL SCIENCE.***Cat. II*

What is the process by which a hypothesis about human behavior gets supported or rejected? This course represents a review of the methodological tools of social and behavioral science. Topics to be covered include experimental design and ethical issues specific to behavioral research with human subjects, the use of statistical and simulation modeling in the interpretation of behavioral phenomena, and methods for statistical inference in compiling evidence for or against a hypothesis.

Recommended background: PSY 1400 and either PSY 1401 or PSY 1402.

This course will be offered in 2009-10 and in alternate years thereafter.

**SOCIETY/TECHNOLOGY STUDIES (STS)****STS 1207. INTRODUCTION TO THE PSYCHO-SOCIOLOGY OF SCIENCE.***Cat. II*

This course will describe how traditional issues addressed in the Sociology of Science dealing with science as an institution, social controversies involving science, priority disputes within science and process of scientific discovery are illuminated by studies using measures borrowed from psychology. Examples will involve measures of cognitive style, personality and openness to innovation. The scientific pipeline that runs through the science programs in the educational system and the experience of women as students and as practicing scientists will be addressed as a science and society equity issue. Problems balancing the roles

of the scientist as expert and concerned citizen in a democratic but technological society will also be addressed. This course works equally well as a second course after PSY 1402, Social Psychology, or a first course in Social Science. It is recommended background for STS 2209, Conflict and Cooperation in Research and Development Settings.

This course will be offered in 2008-09 and in alternating years thereafter.

**STS 2208. THE SOCIETY - TECHNOLOGY DEBATE.***Cat. II*

A course which considers what one means when they say that we live in a technological society, focusing on the characteristics of technology that humanistic critics find problematic or objectionable. In the course of the analysis, the nature of technology, its connection to scientific advance, as well as its relationship to the state, and the social role of scientists and technologists will be considered. Special attention is given to the behavior of experts in scientific and technological controversies, and to the debate about the "technological mentality" said to pervade western societies. Utopian, Dystopian and Marxist interpretations of where technological development is taking us will be examined in an effort to understand the major themes in the larger debate about the social impact of technology. Computer science majors can take this course in place of CS 3043 if they write a term paper on a computer-related topic.

Recommended background: SOC 1202.

This course will be offered in 2008-09 and in alternating years thereafter. May be included in certain Humanities and Arts Sufficiency programs. See page 29.

**STS 2209. CONFLICT AND COOPERATION IN RESEARCH AND DEVELOPMENT SETTINGS.***Cat. II*

This course operates on two levels. It is a study of great innovations teams and R and D organizations in the field of aerospace, and great entrepreneurs who created their own companies around their inventions. China Lake, the Navy lab that invented the Sidewinder heat seeking air to air missile, Lockheed's "Skunkworks" which produced the U2 spy plane and Stealth technology, and Korolev, the great Russian "chief designer" who shaped the Soviet missile and space program are featured. Edwin Land was the inventor-entrepreneur who created Polaroid Corporation and worked for the US government on projects such as camera optics for spy planes and satellites. Aspects of the technological context in which Carnegie, Edison and Bell emerged to prominence and the nature of their contributions will be discussed. On another level, the class is an R and D unit composed of teams in a startup company with two different product lines, trying to get its first contract from an established aerospace conglomerate. The client company, its mission and CEO are described in Michael Flynn's novel, Firestar. The home company has a new information project, ISIS, the Integrated Staff/Student Information System, which it claims can improve the effectiveness of innovation and production teams through the use of psychological instruments. Your unit is to research the great R and D units of the past, show how the client's organization can be reconfigured to approximate them, and assess the case that teams unusually likely to function well in their assigned roles can actually be formed using the ISIS cognitive styles database.

This course will be offered 2009-10 and in alternating years thereafter.

**Graduate System Dynamics Courses of Interest to Undergraduates****SD 550. SYSTEM DYNAMICS FOUNDATION: MANAGING COMPLEXITY.**

Why do some businesses grow while others stagnate or decline? What causes oscillation and amplification - the so called "bullwhip" — in supply chains? Why do large scale projects so commonly over overrun their budgets and schedules? This course explores the counter-intuitive dynamics of complex organizations and how managers can make the difference between success and failure. Students learn how even small changes in organizational structure can produce dramatic changes in organizational behavior. Real cases and computer simulation modeling combine for an in-depth examination of the feedback concept in complex systems. Topics include: Supply chain dynamics, project dynamics, commodity cycles, new product diffusion, and business growth and decline. The emphasis throughout is on the unifying concepts of system dynamics. Pre-requisites: None

**SD 551. MODELING AND EXPERIMENTAL ANALYSIS OF COMPLEX PROBLEMS.**

This course deals with the hands on detail related to analysis of complex problems and design of policy for change through building models and experimenting with them. Topics covered include: slicing complex problems and constructing reference modes; going from a dynamic hypothesis to a formal model and organization of complex models; specification of parameters and graphical functions; experimentations for model understanding, confidence building, policy design and policy implementation. Modeling examples will draw largely from public policy agendas. Pre-requisites: SD 550

**SD 552. SYSTEM DYNAMICS FOR INSIGHT.**

The objective of this course is to help students appreciate and master system dynamics' unique way of using of computer simulation models. The course provides tools and approaches for building and learning from models. The course covers the use of molecules of system dynamics structure to increase model building speed and reliability. In addition, the course covers recently developed eigenvalue-based techniques for analyzing models as well as more traditional approaches. Pre-requisites: SD 550 and SD 551

**SD 553. MODEL ANALYSIS AND EVALUATION TECHNIQUES.**

This course focuses on analysis of models rather than conceptualization and model development. It provides techniques for exercising models, improving their quality and gaining added insights into what models have to say about a problem. Five major topics are covered: Use of subscripts, achieving and testing for robustness, use of numerical data, sensitivity analysis, and optimization/calibration of models. The Subscripts discussion provides techniques for dealing with detail complexity by changing model equations but not adding additional feedback structure. Robust models are achieved by using good individual equation formulations and making sure that they work together well though automated behavioral experiments. Data, especially time series data, are fundamental to finding and fixing shortcomings in model formulations. Sensitivity simulations expose the full range of behavior that a model can exhibit. Finally, the biggest section, dealing with optimization and calibration of models develops techniques for both testing models against data and developing policies to achieve specified goals. Though a number of statistical issues are touched upon during the course, only a basic knowledge of statistics and statistical hypothesis testing is required. Pre-requisites: SD 550 and SD 551, or permission of the instructor

**SD 554. REAL WORLD SYSTEM DYNAMICS.**

In this course students tackle real-world issues working with real managers on their most pressing concerns. Many students choose to work on issues in their own organizations. Other students have select from a number of proposals put forward by managers from a variety of companies seeking a system dynamics approach to important issues. Students experience the joys (and frustrations) of helping people figure out how to better manage their organizations via system dynamics. Accordingly the course covers two important areas: Consulting (i.e. helping managers) and the system dynamics standard method - a sequence of steps leading from a fuzzy "issue area" through increasing clarity and ultimately to solution recommendations. The course provides clear project pacing and lots of support from the instructors and fellow students. It is recommend that students take this course toward the end of their system dynamics coursework as it provides a natural transition from course work to system dynamics practice. Pre-requisites: SD 550 and SD 551

**SD 555. PSYCHOLOGICAL FOUNDATIONS OF SYSTEM DYNAMICS MODELING.**

(3 credits)

This course examines the cognitive and social processes underlying the theory and practice of system dynamics. The errors and biases in dynamic decision making that provide the primary rationale for the use of system dynamics modeling will be traced to their root causes in cognitive limitations on perception, attention, and memory. Group processes that influence the outcome of modeler-client interactions and appropriate psychological techniques for eliciting and using mental data to support model building will also be addressed. Additional topics will include the reliability of alternate data sources for modeling, techniques for quantifying soft variables, design issues in group model building, the relative advantages of qualitative and quantitative modeling, and client attitudes toward modeling.

Pre-requisites: SS 550 System Dynamics Foundation: Managing Complexity or permission of the instructor

**SD 560. STRATEGY DYNAMICS.**

This course provides a rigorous set of frameworks for designing a practical path to improve performance, both in business and non-commercial organisations. The method builds on existing strategy concepts, but moves substantially beyond them, by using the system dynamics method to understand and direct performance through time. Topics covered include: Strategy, performance and resources; Resources and accumulation; The 'Strategic Architecture'; Resource Development; Rivalry and the Dynamics of Competition; Strategy, Policy and Information Feedback; Resource Attributes; Intangible Resources; Strategy, Capabilities and Organization; Industry Dynamics and Scenarios. Case studies and models are assigned to students for analysis. Pre-requisites: SD 550 or permission of the instructor

**SD 561. ENVIRONMENTAL DYNAMICS.**

Environmental Dynamics introduces the system dynamics students to the application in environmental systems. The course materials include the book Modeling the Environment, a supporting website, lectures and the corresponding power point files. Students learn system dynamics with examples implemented with the Stella software. The course includes a variety of small models and case applications to water shed management, salmon restoration, and incentives for electric vehicles to reduce urban air pollution. The students conclude the course with a class project to improve one of the models from the book Modeling the Environment. The improvements may be implemented with either the Stella or the Vensim software. Pre-requisites: SD 550

**SD 562. PROJECT DYNAMICS.**

This course will introduce students to the fundamental dynamics that drive project performance, including the rework cycle, feedback effects, and inter-phase "knock-on" effects. Topics covered include dynamic project problems and their causes: the rework cycle and feedback effects, knock-on effects between project phases; Modeling the dynamics: feedback effects, schedule pressure and staffing, schedule changes, inter-phase dependencies and precedence; Strategic Project management: Project Planning, Project Preparation, Risk management, Project adaptation and execution. Cross project learning; Multi-project issues. A simple project model will be created, and used in assignments to illustrate the principles of "strategic project management." Case examples of different applications will be discussed. Pre-requisites: SD 550

**SD 565. MACROECONOMIC DYNAMICS.**

There are three parts to this course. The first acquaints a student with dynamic macroeconomic data and the stylized facts seen in most macroeconomic systems. Characteristics of the data related to economic growth, economic cycles, and the interactions between economic growth and economic cycles that are seen as particularly important when viewed through the lens of system dynamics, will be emphasized. The second acquaints a student with the basics of macroeconomic growth and business cycle theory. This is accomplished by presenting well-known models of economic growth and instability, from both the orthodox and heterodox perspectives, via system dynamics. The third part attempts to enhance a student's ability to build and critique dynamic macroeconomic models by addressing such topics as the translation of difference and differential equation models into their equivalent system dynamics representation, fitting system dynamics models to macroeconomic data, and evaluating (formally and informally) a model's validity for the purpose of theory selection. Pre-requisites: SD 550

**SS 590. SPECIAL TOPICS IN SYSTEM DYNAMICS.**

(credit as specified)

Individual or group studies on any topic relating to social science and policy studies selected by the student and approved by the faculty member who supervises the work.

# UNIVERSITY POLICIES AND PROCEDURES

## SECTION 4

University Policies and Procedures . . . . .	166
Grades . . . . .	166
Grade Appeal and Grade Change Policy . . . . .	167
Transfer Credit . . . . .	168
Graduation with Honors . . . . .	169
Commencement . . . . .	169
Designation of Major Area of Study . . . . .	169
Double Major . . . . .	170
Designation of Class Year . . . . .	170
Academic Honesty Policy . . . . .	170
Guidelines for the Determination of Satisfactory Academic Progress, Academic Warning, Academic Probation and Academic Suspension. . . . .	171
Administrative Obligations and Holds . . . . .	172
Directory Information and Release of Information . . . . .	172
Office of the Registrar . . . . .	174



## GRADES

### DISTRIBUTION OF GRADES

Academic grades may be released legally to the parents of dependent students. In accordance with affirming legal opinion, effective August 1, 1986, WPI assumes that all undergraduates have dependent status unless they inform the Projects and Registrar's Office in writing that they are independent. Petition forms are available in the Registrar's Office. Such a declaration may be filed by a student at any time. After receipt of such notice, the Registrar will not release grades to parents unless legal evidence of dependency is presented to the contrary. (The listing of a student as a dependent on the parent's IRS 1040 Form is the accepted legal evidence of dependency under the Privacy Act or Buckley Amendment. Information on file with the Financial Aid Office will remain confidential within that office and will not be used in any manner relative to this issue).

### GRADE SYSTEM SELECTION

The PLAN grading system applies only to admitted, degree-seeking undergraduate students. All other students such as Consortium (CO), nondegree-seeking Special Students (SX), and Graduate students will receive traditional A, B, C, D, F, Withdrawal and Pass/Fail grades.

The AD, AC grading system applies to all degree candidates who matriculated prior to May 1, 1986, and who have not exercised the one-time option to change to the A, B, C system.

### PLAN (Current system)

*Projects:* The following term grades are possible: A, B, C, SP (Satisfactory Progress), NAC (Not Acceptable) and NR (No record).

*Courses:* The following grades are possible: A, B, C, NR, and I (Incomplete). An instructor may also assign an "I" in an Independent Study course. AT (attended) is used to denote participation in seminars or college-sponsored programs.

### TRADITIONAL (System before mid-1970's)

*Courses:* The following grades are possible: A, B, C, D, F, Withdrawal, and I (Incomplete).

### GRADES FOR COMPLETION OF DEGREE REQUIREMENTS

The overall evaluation of degree requirements (for the MQP, the IQP and the Sufficiency) will be graded in the student's respective grade system. The transcript will contain an abstract describing the content of the completed project.

### NO RECORD (NR)

The NR (No Record) grade is assigned by a faculty member for course or project work for which credit has not been earned. This grade applies to PLAN students (admitted, degree-seeking) only. The NR grade does not appear on the students' transcripts or grade reports, nor is it used in the calculation of satisfactory academic progress.

### INCOMPLETE (I)

An I grade, when assigned, will be changed to NR after one term unless extended in writing by the instructor to the Registrar's Office. The I grade is not assigned for Qualifying Projects or the Sufficiency.

### SATISFACTORY PROGRESS (SP)

In project work (IQP, MQP only) extending beyond one term for which a grade is not yet assigned, an interim grade of SP (Satisfactory Progress) may be used on grade sheets. In such cases, the SP evaluation will count as units earned toward meeting the 15-unit rule, the distribution requirements, and the minimum standards for satisfactory academic progress. SP grades remain on the transcript until changed to the final grade as submitted on the Completion of Degree Requirement Form or through the grade change form procedure.

### OTHER GRADES

A ? or Q signifies a grade that has not been submitted.

### PROJECT GRADING

The Faculty of WPI have endorsed the following grading guidelines for project activity:

1. Each term a student is registered for a project, the student receives a grade reflecting judgment of accomplishments for that term.
2. Upon completion of the project, students will receive an overall project grade. It is important to note that this grade reflects not only the final products of the project (e.g., results, reports, etc.), but also the process by which they were attained. No amount of last-minute effort should turn a mediocre project effort into an A.
3. The available grades and their interpretations are as follows:
  - **A:** a grade denoting a consistently excellent effort, and attaining the stated project goals.
  - **B:** a grade denoting a consistently good effort, and attaining the stated project goals.
  - **C:** a grade denoting an acceptable effort, and partially attaining the stated project goals.
  - **SP:** a grade denoting an effort sufficient for the granting of the credit for which the student is registered. This grade provides students with no feedback, and its use is discouraged except for circumstances in which the faculty member is unable to judge the quality of the work (yet can still determine that the granting of credit is appropriate).
  - **NAC:** a grade denoting an effort unacceptable for the credit for which the student is registered. Note that this grade is entered into the student's transcript.
  - **NR:** a grade denoting an effort insufficient for the credit for which the student is registered. This grade is appropriate when the project has not proceeded due to circumstances beyond the control of the student, or for project extensions which do not represent the full amount of credit for which the student is registered.
4. The results of a project should be such that an outside reviewer would reasonably deem the project as being worthy of the credit and grade given, based on evidence such as the project report.
5. In light of the above grading criteria, it is strongly suggested that a formal project proposal or contract be developed early in the project activity, so that all participants in the activity have a clear understanding of the project goals, and advisor and student expectations.

## CUMULATIVE POINT AVERAGE

WPI does not maintain a Cumulative Grade Point Average for undergraduate students. A student who needs a cumulative point average for external use may apply to the Registrar and receive a numerical equivalent. This information is usually provided only for students applying to graduate or professional schools when the application process requires a translation. Cumulative point averages will not be printed on student's transcripts nor shall class rankings be developed from them.

When requested by the student, the numerical equivalent of the cumulative point average will be based on a point assignment of A = 4.0, B = 3.0, C = 2.0 while DIST and AC grades will be 4.0 and 2.75 respectively.

## GRADE APPEAL AND GRADE CHANGE POLICY

The purpose of the Grade Appeal Policy is to provide the student with a safeguard against receiving an unfair final grade, while respecting the academic responsibility of the instructor. Thus, this procedure recognizes that,

- Every student has a right to receive a grade assigned upon a fair and unprejudiced evaluation based on a method that is neither arbitrary nor capricious; and,
- Instructors have the right to assign a grade based on any method that is professionally acceptable, submitted in writing to all students, and applied equally.

Instructors have the responsibility to provide careful evaluation and timely assignment of appropriate grades. Course and project grading methods should be explained to students at the beginning of the term. WPI presumes that the judgment of the instructor of record is authoritative, and the final grades assigned are correct.

A grade appeal shall be confined to charges of unfair action toward an individual student and may not involve a challenge of an instructor's grading standard. A student has a right to expect thoughtful and clearly defined approaches to course and project grading, but it must be recognized that varied standards and individual approaches to grading are valid. The grade appeal considers whether a grade was determined in a fair and appropriate manner; it does not attempt to grade or re-grade individual assignments or projects. It is incumbent on the student to substantiate the claim that his or her final grade represents unfair treatment, compared to the standard applied to other students. Only the final grade in a course or project may be appealed. In the absence of compelling reasons, such as clerical error, prejudice, or capriciousness, the grade assigned by the instructor of record is to be considered final.

In a grade appeal, only arbitrariness, prejudice, and/or error will be considered as legitimate grounds for an appeal.

**Arbitrariness:** The grade awarded represents such a substantial departure from accepted academic norms as to demonstrate that the instructor did not actually exercise professional judgment.

**Prejudice:** The grade awarded was motivated by ill will, and is not indicative of the student's academic performance.

**Error:** The instructor made a mistake in fact.

This grade appeal procedure applies only when a student initiates a grade appeal and not when the instructor decides to change a grade on his or her own initiative. This procedure does not cover instances where students have been assigned grades based on academic dishonesty or academic misconduct, which

are included in WPI's Academic Honesty Policy. Also excluded from this procedure are grade appeals alleging discrimination, harassment or retaliation in violation of WPI's Sexual Harassment Policy, which shall be referred to the appropriate office at WPI as required by law and by WPI policy.

The Grade Appeal Procedure strives to resolve a disagreement between student and instructor concerning the assignment of a grade in a collegial manner. The intent is to provide a mechanism for the informal discussion of differences of opinion, and for the formal adjudication by faculty only when necessary. In all instances, students who believe that an appropriate grade has not been assigned must first seek to resolve the matter informally with the instructor of record. If the matter cannot be resolved informally, the student must present his or her case in a timely fashion in the procedure outlined below. Under normal circumstances, the grade appeal process must be started near the beginning of the next regular academic term after the disputed grade is received.

## STUDENT GRADE APPEAL PROCEDURE

1. A student who wishes to question a grade must discuss the matter first with the instructor of record as soon as possible, preferably no later than one week after the start of the next regular academic term after receiving the grade. In most cases, the discussion between the student and the instructor should suffice and the matter will not need to be carried further. The student should be aware that the only valid basis for grade appeal beyond Step One is to establish that an instructor assigned a grade that was arbitrary, prejudiced, or in error.
2. If the student's concerns remain unresolved after the discussion with the instructor, the student may submit a written request to meet with the appropriate Department Head, within one week of speaking with the instructor. For a grade in a course, independent study or Major Qualifying Project (MQP), the appropriate person is the instructor's Department Head. For a grade in an Interactive Qualifying Project (IQP), the appropriate person is the Dean of the Interdisciplinary and Global Studies Division (IGSD). If the instructor of record is a Department Head or the Dean of the IGSD, then the student should request to meet with the Dean of Undergraduate Studies, who will serve as the appropriate Department Head in this step. The appropriate Department Head will meet within one week with the student, and, if he or she believes that the complaint may have merit, with the instructor. After consultation with the Department Head, the instructor may choose to let the grade remain, to change a course grade, or to petition the Committee on Academic Operations to change a grade for a Degree Requirement (MQP, IQP). The Department Head will communicate the result of these discussions to the student.
3. If the matter remains unresolved after Step Two, the student should submit a written request within one week to the Provost's Office to request an *ad hoc* Faculty Committee for Appeal of a Grade. The Dean of Undergraduate Studies will meet with the student, and will ask the Faculty Review Committee to appoint the *ad hoc* Committee for Appeal of a Grade. The FRC, in consultation with the Dean of Undergraduate Studies, will select the members of the *ad hoc* committee. The Chair of the FRC will convene the *ad hoc* committee and serve as its non-voting chair. The *ad hoc* committee for appeal of a grade in a course, independent

study or MQP will be composed of three faculty members chosen in the instructor's department or in closely allied fields. The *ad hoc* committee for appeal of a grade in an IQP will be composed of the instructor of record's Department Head and two faculty members who are experienced advisors of IQPs chosen from any department. Appointees to the *ad hoc* committee must not have any apparent conflicts of interest with the instructor of record (which might include but are not limited to frequent co-advising or research collaboration). The committee would examine available written information on the dispute, would be available for meetings with the student and with the instructor, and would meet with others as it sees fit.

4. Through its inquiries and deliberations, the *ad hoc* committee is charged to determine whether the grade was assigned in a fair and appropriate manner, or whether clear and convincing evidence of unfair treatment such as arbitrariness, prejudice, and/or error might justify changing the grade. The *ad hoc* committee will make its decisions based on a majority vote. If the committee concludes that the grade was assigned in a fair and appropriate manner, the *ad hoc* committee will report its conclusion in writing to the student and instructor and the matter will be considered closed. If the *ad hoc* faculty committee determines that compelling reasons exist for changing the grade, it would request that the instructor make the change, providing the instructor with a written explanation of its reasons. Should the instructor decline, he or she must provide a written explanation for refusing.
5. The *ad hoc* faculty committee, after considering the instructor's explanation and upon again concluding that it would be unjust to allow the original grade to stand, will then determine what grade is to be assigned. The new grade may be higher than, the same as, or lower than the original grade. Having made this determination, the three members of the committee will sign the grade change form and transmit it to the Registrar. The instructor and student will be advised of the new grade. Under no circumstances may persons other than the original faculty member or the review committee change a grade. Should the *ad hoc* faculty committee feel that the instructor's written explanation justifies the original grade, the *ad hoc* committee will report this in writing to the student and instructor and the matter will be closed.

#### **FACULTY GRADE CHANGE PROCEDURE**

The Student Grade Appeal Procedure affirms the principle that grades should be considered final. The principle that grades for courses or projects should be considered final does not excuse an instructor from the responsibility to explain his or her grading standards to students and to assign grades in a fair and appropriate manner. The appeal procedure also provides an instructor with the opportunity to change a grade for a course or project on his or her own initiative. The appeal procedure recognizes that errors can be made and that an instructor who decides that it would be unfair to allow a final grade to stand due to error, prejudice or arbitrariness may request a change of grade for a course or project without the formation of an *ad hoc* committee. An instructor may request a grade change in one of two ways. First, for courses, an instructor may submit a course grade change in writing to the Registrar at any time prior to a student's graduation. Second, for Degree Requirements (MQP, IQP), an instructor must submit a petition to the Committee on Academic Operations (CAO) to change the grade.

## **TRANSFER CREDIT**

### **TRANSFER CREDIT BEFORE MATRICULATION TO WPI**

After a student has been accepted and final transcripts received, the Office of Admissions coordinates the formal evaluation of credit accepted towards a WPI degree. Courses taken at regionally accredited post-secondary institutions that are comparable to courses offered at WPI will be reviewed for course content and level by the WPI department offering the comparable course. Only those courses in which the transfer student received a grade of C or better will be evaluated for possible transfer credit. Please note vocational, correspondence, pre-college or review courses are not transferable. Also, non-credit CEU courses, adult enrichment or refresher courses, and CLEP examinations are not recognized for transfer credit.

### **TRANSFERING CREDIT AFTER MATRICULATION TO WPI**

If you are currently a WPI student who wishes to take courses at a regionally accredited post-secondary institution, you must obtain a WPI Transfer Credit Authorization form from the Registrar's Office. This form and the course description must be taken to the WPI department head and academic advisor for approval before the course is taken. On the form, the department head specifies a minimum grade for transfer. This minimum grade depends on the institution at which the course is taken and how critical the course is to the department. Courses that have not been pre-approved may not receive transfer credit. The completed form must be filed in the Registrar's Office before taking the course. After successful completion of the course, an official transcript should be sent to WPI. Students can check the web for posting of credit. Please note vocational, correspondence, pre-college or review courses are not transferable. Also, noncredit CEU courses, adult enrichment or refresher courses, and CLEP examinations are not recognized for transfer credit.

### **TRANSFERRING CONSORTIUM COURSES**

Courses taken through the consortium do not need to be transferred into WPI. Courses will automatically be part of the WPI transcript. However, if you are taking the course through the consortium to fulfill a WPI distribution requirement, you should check with the Registrar's Office to see if the course has been pre-approved to satisfy the requirement. If not, you will need approval from the relevant department head before taking the course.

To apply for approval of a consortium course to satisfy a specific WPI distribution requirement, a student must obtain a WPI Transfer Credit Authorization form from the Registrar's Office. This form and the course description must be taken to the WPI department head for approval before the course is taken. The WPI department head decides whether the proposed course meets the department distribution requirement. If it does, the department head specifies on the form a minimum grade for satisfying the distribution requirement. This minimum grade depends on the institution at which the course is taken and how critical the course is to the department. Courses that have not been pre-approved may receive WPI elective credit. The complete form must be filed in the Registrar's Office before taking the course.

---

## GRADUATION WITH HONORS

For all degree candidate students graduating from WPI after May 1, 2011, graduation honors will be determined as follows:

### Graduation With High Distinction

An *A* or *DIST* grade on any *four* of the following:

- MQP
- IQP
- Sufficiency
- Eight units of work registered at WPI (exclusive of PE and of the MQP, IQP and the SUFF/Independent Study component of the Sufficiency)

### Graduation With Distinction

A grade of *A* or *DIST* on the following criteria:

- MQP
- IQP
- Sufficiency
- Four units of work registered at WPI (exclusive of PE and of the MQP, IQP and the SUFF/Independent Study component of the Sufficiency).

or

a grade of *A* or *DIST* on the following criteria:

- Two of the three projects: MQP, IQP and the SUFF/Independent Study component of the Sufficiency
- Six units of work registered at WPI (exclusive of PE and of the MQP, IQP and the SUFF/Independent Study component of the Sufficiency).

---

*For all degree candidate students graduating from WPI from May 1, 1986, to June 1, 2010, graduation honors will be determined as follows:*

### Graduation with High Distinction

An *A* or *DIST* grade on any four of the following:

- MQP
- IQP
- Sufficiency
- Six units of work registered at WPI (exclusive of PE and of the MQP, IQP, or the SUFF/Independent Study component of the Sufficiency)

### Graduation with Distinction

An *A* or *DIST* grade on any three of the above.

## HONORS FOR DOUBLE MAJORS

If a student completes two majors, the student is awarded a degree with “Distinction” or “High Distinction” if the student meets the criteria above in either or both majors; if both awards are received, the degree is awarded with “High Distinction.”

---

## COMMENCEMENT

### COMMENCEMENT POLICY

The policy for allowing certain undergraduate students who have not completed all degree requirements to participate in Commencement exercises is:

1. Undergraduate students who have not met all degree requirements will be eligible to participate in Commencement exercises only if *all of the following* are true:
  - a. The student was registered for all remaining requirements for graduation in the D term immediately preceding Commencement Day.
  - b. At the end of D term, the student is within 1/3 unit of meeting all requirements for graduation.
  - c. The student has completed at least 2 of the 3 WPI Project Requirements (Sufficiency, IQP, and MQP).
  - d. The student has registered for any remaining course or project work no later than 10 days before Commencement Day.
2. Undergraduate students who meet these conditions will be permitted to participate in Commencement exercises but will not receive their diploma. The names of such students will not be included in the Commencement program. The actual degree will be conferred only after all degree requirements have been completed.
3. All WPI undergraduate students will be notified of these policies and procedures each B term.
4. Undergraduate students seeking an exception to this policy have the right to petition the Committee on Academic Operations for a waiver for extenuating circumstances. Petitions must be received no later than 10 days before Commencement Day.

### A/C TERM DEGREE COMPLETION

Students completing 100% of WPI graduation requirements by the end of A-term or C-term will be eligible for a 50% refund of tuition for the semester of completion. Eligible students must complete the form available in the Registrar’s Office and submit by the end of B-term (for C-term completion) or D-term (for A-term completion). Students/responsible parties will be billed for the full semester and then will be refunded 50% of the tuition bill once the graduation requirements have been signed off and the student’s withdrawal has been officially processed. Qualified students receiving financial aid from WPI will retain 50% of any WPI scholarship, and their loan eligibility will be reviewed on an individual basis. Students living in WPI housing will still be financially responsible for paying the full semester’s worth of room and board.

---

## DESIGNATION OF MAJOR AREA OF STUDY

Designation of a student’s major area of study on the transcript is determined by his or her completion of published academic activity distribution requirements, as well as by the Major Qualifying Project. The authority and responsibility of certification of the disciplinary or interdisciplinary area will lie with the appropriate departmental or IGSD Program Review Committee (PRC) in consultation with the student and his or her academic advisor.

For examples of major areas of study, please see page 10.

## DOUBLE MAJOR

### DISTRIBUTION REQUIREMENTS

The distribution requirements of each major must be met, but requirements common to both majors may have to be met only once. A minimum of three units of qualifying project work is thus required for fulfillment of the project portion of the double major requirements: one unit in each of the two major areas of study, and one unit of an IQP. See page 13 for details and options.

For students wishing to pursue double majors not involving social science, the program audit for each intended major must be completed and certified by the review committee of each department involved. Academic activities appropriate to both majors may be counted in both majors.

For the policy in the special situation of double majors involving the social sciences, see page 101.

If a student wishes to complete two Interdisciplinary (individually designed) Majors Programs, the double major must be proposed in a single Educational Program Proposal, which must be approved by the student's Program Advisory Committee for each major. The Committees shall ensure that the majors are substantially nonoverlapping.

If a student's double major includes an Interdisciplinary (individually designed) Major Program, the double majors must be described in the Educational Program Proposal for the Interdisciplinary Major.

## DESIGNATION OF CLASS YEAR

Class year will normally be designated as year of matriculation plus four with the additional requirement that the accumulation of 30/3 units is necessary for fourth-year status, 19/3 units for third-year status, and 8/3 units for second-year status. The class year of transfer students will be determined on an individual basis. Class year designations will be reviewed at the end of Term E each year and changed if the credit accumulation does not meet the above specifications. After Term E, students may petition to be redesignated in their original class if they meet the minimum unit requirements.

## ACADEMIC HONESTY POLICY

Academic honesty is a fundamental principle of learning and a necessary foundation for all academic institutions, particularly those dedicated to independent project-based education, such as WPI. Violations of the principle deny the violators an opportunity to obtain confident command of the material they are credited with knowing, cheat their classmates out of deserved rewards and recognition, debase the institution, and demean the degree that it awards. It is, therefore, a matter of great and mutual concern to all members of the WPI community that a concerted effort be made to maintain high standards of integrity, both to protect the value of the educational process in which we are engaged and to maintain the credibility of the institution.

### DEFINITION

Individual integrity is vital to the academic environment because education involves the search for and acquisition of knowledge and understanding, which are, in themselves, intangible. Evaluation of each student's level of knowledge and understanding is a vital part of the teaching process, and requires tangible measures such as reports, examinations, and homework. Any act that interferes with the process of evaluation by misrepresentation of the relation between the work being evaluated (or the resulting evaluation) and the student's actual state of knowledge is an act of academic dishonesty. The following acts are examples of academic dishonesty at WPI:

#### Fabrication

*Examples:*

- Altering grades or other official records
- Changing exam solutions after the fact
- Inventing or changing laboratory data
- Falsifying research
- Inventing sources
- Sabotage of another student's work or academic record

#### Plagiarism

*Examples:*

- Misrepresenting the work of another as one's own
- Inaccurately or inadequately citing sources including those from the Internet

#### Cheating

*Examples:*

- Use of purchased term papers
- Copying on exams, homework, or take-home exams
- Use of unauthorized materials or sources of information such as "cheat sheet," pre-programmed calculator
- Assistance of another person in cases where prohibited

#### Facilitation

*Examples:*

- Sharing test questions or answers from an exam with another student
- Letting another student copy a solution to a homework problem, exam, or lab
- Taking an exam for another student
- Assistance in any act of academic dishonesty of another student

## RESPONSIBILITIES OF FACULTY MEMBERS AND STUDENTS

Faculty members should outline their policies concerning evaluation procedures and their expectations pertaining to academic integrity at the beginning of each course. Faculty must ensure that student performance is judged solely on the basis of academic work in courses and projects. Because of the differences in disciplines and the type of work involved, faculty interpretation regarding what constitutes academic dishonesty may vary across campus. Since project-based education places a strong emphasis on group work, faculty and students should be particularly attentive to the distinction between group work and

individual performance expectations. Faculty and students are responsible for knowing and understanding WPI's policy and procedure for dealing with academic dishonesty. Faculty are encouraged to implement measures designed to minimize or prevent academic dishonesty.

### PROCEDURES

The WPI faculty and administration have developed a set of procedures designed to ensure uniform (and fair) treatment of undergraduate or graduate students suspected of academic dishonesty. Students or others who suspect a faculty member of professional dishonesty should consult the academic department head or the provost.

- Faculty shall report to the department chair any suspected act of academic dishonesty.
- The chair shall review cases referred to him/her to determine if there is reason for believing that academic dishonesty may be involved.
- Faculty shall allow the student to continue in the course without prejudice, pending resolution of the case.
- The chair or instructor shall check with the dean or associate dean of students to determine if the student has any record of prior offenses involving academic dishonesty.
- The chair or instructor shall consult with the student involved. If the act of academic dishonesty is admitted and is the first violation of that nature, the chair or instructor may resolve the complaint within the department, provided the penalty is accepted by the student in writing. The maximum penalty that can be applied at the department level is dismissal from a course or a project without credit. In all cases, a signed, written report on the matter, including the action taken, shall be sent to the Dean of Students Office and to the student's Academic Advisor.
- For the second and subsequent violations, the case shall be submitted to the Campus Hearing Board for resolution.
- The Campus Hearing Board shall hear the allegations, following standard procedures for disciplinary hearings established by WPI. The board may impose normal disciplinary sanctions and may recommend loss of any credit or grade for the course or project. If a student is found not responsible on a complaint of academic dishonesty, he/she may not be failed or penalized by the instructor on the grounds of dishonesty. The instructor shall assign a grade based on his or her assessment of the student's mastery of the material being evaluated.
- Disciplinary records for any act of academic dishonesty shall be retained in the Dean of Students Office for two years from the date of graduation or withdrawal from WPI, except when the sanction includes suspension or expulsion. In cases resulting in suspension or expulsion from WPI, disciplinary records shall be kept in perpetuity. Records for cases that are pending completion of the hearing and/or the sanction shall be kept in perpetuity. Judicial records are kept separate from a student's academic records. A student's judicial record may be shared internally as appropriate to determine if a past record exists. Records shall be available to prospective employers and other authorized individuals, in accordance with federal regulations that require written permission from the student involved.

## GUIDELINES FOR THE DETERMINATION OF SATISFACTORY ACADEMIC PROGRESS, ACADEMIC WARNING, ACADEMIC PROBATION AND ACADEMIC SUSPENSION

### SATISFACTORY ACADEMIC PROGRESS

In order to assist both the student, parents and the academic advisor in determining whether a student is making academic progress, WPI has adopted both of the following guidelines, effective Term A, 1989.

1. The student must complete at least 4/3 units of work in two successive terms, including Military Science, Physical Education and Consortium courses.
2. The student must complete at least 8/3 units of work in four successive terms, including Military Science, Physical Education and Consortium courses.

Note: Term E (Summer School) will be included if the student is registered full time.

### ACADEMIC WARNING

Each student's academic record will be reviewed at the conclusion of terms B and D according to the guidelines above. If a student's performance falls short of either guideline 1 or 2, the student, parent and academic advisor will be notified that the student is not making satisfactory progress. The notification will place the student on *Academic Warning*. At this time, the student is urged, with the help of his/her advisor, to identify the nature of the academic difficulty and to formulate a course of action for overcoming the difficulty.

### ACADEMIC PROBATION

During the next review of academic progress, should the student fail, once again, to maintain satisfactory academic progress, the student, parent and academic advisor will be notified. This notification will place the student on Academic Probation for two terms. *Academic Probation* will prevent the student from receiving financial aid, will result in loss of eligibility for team sports, will prevent the student from obtaining undergraduate employment in the Co-op Program and will prevent participation in the Global Perspective Program.

Students who obtain no academic credit (exclusive of Physical Education or ROTC-related courses) in either Term A or Term C shall be sent a letter by the Director of Academic Advising informing them of the following change of academic status if they earn no academic credit for the next term for which they are registered.

Students who fail to obtain credit for two consecutive terms shall:

- a) be placed on Academic Probation if currently they are classified as making satisfactory progress, or
- b) be placed on Academic Suspension if currently they are on the list of students on Academic Warning or on Academic Probation.

Subsequent academic review shall follow the rules for all students.

This amendment shall be incorporated in the Undergraduate Catalog and shall be implemented as of the Fall semester of 1994. Students affected by this rule retain the right to petition the Committee on Academic Operations for a waiver for extenuating circumstances.



**ACADEMIC SUSPENSION**

Should a student on Academic Probation fail to make satisfactory academic progress during the next review period, the student will be *suspended* from WPI. The notification will prevent the student from enrolling as a full-time student *or* a special student for at least the next two terms. Subsequent readmission is subject to approval (with possible conditions) of a petition through the Registrar to the Committee on Academic Operations (CAO). As a general rule, a student readmitted after suspension will be placed on an Academic Probation status.

New students (first year or transfer) who fail to obtain academic credit for the first two terms shall be placed on Academic Suspension and not allowed to enroll for the following terms. Readmission is subject to approval by the Committee on Academic Operations.

**IMPROVEMENT IN STATUS**

Students on Academic Warning or Academic Probation have the opportunity to improve their status by progressing through the levels in reverse order. If a student on Academic Probation satisfactorily meets the guidelines at the end of the next review period, he or she will be moved to the list of students on Academic Warning. A student on Academic Warning would be moved back to Satisfactory Academic Progress status.

**TERM E REVIEW PERIOD**

An exception to the guidelines stated above can occur when a student registers full time for Term E. At the conclusion of Term E, a review will be conducted which will include the previous five terms. If the student has completed 10/3 units acceptable work, the student's academic progress status will improve. Thus, a student on Warning status after the Term D review will start terms A and B on Satisfactory Academic Progress. A student placed on Academic Probation after the Term D review will be on Warning status for terms A and B. A student on Suspension status after the Term D review will be able to register for terms A and B on Academic Probation.

**SUMMER BRIDGE PROGRAM**

Students who finish the academic year on Academic Warning or Academic Probation status, but who have passed at least 2 units of academic work during the previous four terms, are eligible to participate in the Summer Bridge Program. Students who participate in the program enroll in Term E for two courses and also take a four-week study skills program. Successful completion of the courses and the study skills program will result in the academic status rising one level (Academic Probation to Academic Warning, or Academic Warning to Satisfactory Academic Progress). The Office of Academic Advising coordinates the Summer Bridge Program.

**SPECIAL STUDENTS**

Students pursuing the bachelor's degree as special students will be subject to the same review schedule and standards as full-time students except that, during any review period, the student's academic record from the four most recent terms will be checked to ensure the student has satisfactorily completed at least two-thirds of the academic activities for which he/she has registered.

**PETITIONS**

Students may petition through the Registrar's Office to the Committee on Academic Operations (CAO) for reconsideration of the status of any of the following:

- Academic Warning
- Academic Probation
- Academic Suspension
- Readmission after Suspension
- Other unusual situations

Students who petition for reconsideration of status must accomplish the following:

1. Go to the Registrar's Office and obtain a petition form.
2. Complete form with advisor and obtain advisor's approval and signature.
3. Submit form to the Registrar's Office within three weeks of the issuance of grades for B, D, or E term reviews except for readmission after suspension. For readmission after suspension, petitions must be submitted to the Registrar's Office at least three weeks prior to the start of classes.

**READMISSION AFTER SUSPENSION**

Deadlines for petitions:

July 15 for Term A

November 15 for Term C

---

**ADMINISTRATIVE OBLIGATIONS AND HOLDS**

---

The college reserves the right to hold grades, transcripts, registration and/or diploma for any student who has an outstanding administrative obligation with the college.

---

**DIRECTORY INFORMATION AND RELEASE OF INFORMATION**

---

The items listed below are designated as Directory Information and may be released at the discretion of the institution. Under the provisions of the Family Educational Rights and Privacy Act of 1974, as amended, students have the right to withhold the disclosure of any or all of the categories of Directory Information. Written notification to withhold directory information must be received by the Registrar's Office during the first week of the fall semester. Forms are available in the Registrar's Office. A request to withhold directory information in no way restricts internal use of the material by the college.

Directory information will include the student's campus mailbox, full name, year, major codes, advisor code, e-mail address, home address, local address, local phone, date and place of birth, dates of attendance, degrees and awards received, and most recent or previous educational agency or institution.

Unless a student notifies the Registrar's Office in writing to the contrary, the college considers all undergraduate students to be dependents of their parents. In compliance with the Family Educational Rights and Privacy Act, the college reserves the right to disclose information about the status of dependent students to their parents without the students' written consent. Petition forms for Declaration of Independent Status are available in the Registrar's Office upon request (see information under Distribution of Grades, page 166).

**POLICY ON RELEASING INFORMATION ON DECEASED STUDENTS**

The education records of deceased students may be released or disclosed, at the time of death, upon written request, to a spouse, a parent, the executor of the estate, the eldest surviving child, the eldest surviving sibling, and surviving descendent, or pursuant to a court order or subpoena. Only the Registrar may release the academic records of deceased students. The person requesting the records must provide as much of the following information as possible within the written request:

- Student's name (and maiden name, if applicable).
- Student's Social Security number.
- Student's date of birth.

The dates that the deceased student attended WPI  
Death Certificate (Photo copy is acceptable).

The petitioner must also provide the following personal information within his/her written request:

Name,

Address.

Phone Number.

Evidence that he/she is qualified to receive the records, based on the above criteria or, in the absence of evidence, a statement certifying the same.

Signature.

Date of request.

A calendar is published by the Registrar prior to the enrollment course-change period which specifies the time periods and fees for late changes. Students are responsible for the dates and should contact the Registrar's Office if they need information to avoid late fees. Requests for exceptions to published deadlines must be submitted in writing and approved by the Registrar prior to Enrollment Day, and will be granted based on documented extenuating circumstances, i.e., medical, military obligations.

### REGISTRATION

During the spring, students will receive information regarding course offerings for the following academic year. After consulting with academic advisors, students will make course selections via the online registration system. Students with holds may be prevented from registering until the obligation is met.

Project/Independent study registration for terms A-E will be accepted up to the 15th day of the term, not including weekends, without penalty. A \$100 late registration fee will be charged per project/Independent study after the 15th day.

### ENROLLMENT

At the beginning of terms A and C, students will receive enrollment information. **All students must enroll whether or not course changes are to be made.** A \$100 late enrollment fee will be charged after the fourth day of the semester (fall/spring).

### COURSE CHANGES

Course changes can be made online (<http://registrar.wpi.edu>) until 4 p.m. on the second day of classes for each term.

Course change (Add/Drop) without penalty for terms A-E may occur through the 4th day of the term, not including weekends. On days 5-10 of the term, not including weekends, add and drop is permitted with instructor approval. A \$100 late fee will be charged per class on days 5-10. No add/drops are allowed after day 10.

### APPLICATION FOR DEGREE

Each student must file an application for degree with the Registrar's Office in accordance with the following schedule:

#### To graduate in:

May	Beginning of preceding Term B
October	Beginning of preceding Term D
February	Beginning of preceding Term A

### WAIT LISTS

When a seat in a class becomes available to a student on the wait list, he or she will be notified via e-mail. The e-mail contains instructions on how to claim the available seat.

If a student does not receive an e-mail, it means no seat is available for him/her in the wait-listed class. Wait lists for an upcoming term are abolished on the first day of classes for that term. Students are automatically removed from the list at that time.

### OVERLOADS OF COURSES

**The standard course load for WPI students is one unit per term (exclusive of courses for ROTC, and Physical Education, which do not count towards overloads). Students may register in advance for a maximum of one unit in any term.**

Registration for courses which will result in an overload may take place, on a space-available basis, as of the first day of the term in which that course is offered.

A student may not include any portion of qualifying work (project or Sufficiency) as part of an overload without the approval of both the academic and project advisors. Written approval will be requested before registration can be completed in such cases.

Overload charges will be computed each semester based on the course and project load included in the student's final term registration.

To compute overload charges, see Expenses, page 198.

### WITHDRAWAL FROM COURSES

Students on the WPI Plan who wish to withdraw from a course or project will be assigned a grade of NR (No Record) by the instructor. The student should contact the instructor and indicate that he/she will not be continuing in the class.

### TRANSCRIPT FEES

Transcripts are furnished upon written request to the Registrar's Office. Each student is allowed one free transcript. Each additional transcript is subject to a fee established by the college administration. Official transcripts cannot be faxed.

The college reserves the right to withhold the release of transcript information for students with administrative obligations.

### DEGREE AUDITS

WPI has developed a computerized degree evaluation which lists students' courses as they apply to the respective department distribution requirements. The degree evaluation is available online.

Any course substitutions or exceptions to the degree evaluation must be forwarded to the Registrar **IN WRITING** from the Department Program Review Committee.

### WITHDRAWAL FROM WPI

Students wishing to withdraw from the WPI should initiate that procedure by consulting the Registrar's Office. Withdrawals are appropriate for medical issues, personal or financial hardships. Any reduction in tuition charges is directly dependant on the date the student officially withdraws and formally files his/her paperwork with the Registrar's Office.

---

## PROJECT AND INDEPENDENT STUDY REGISTRATION

---

### PLANNING

During the academic planning period, which starts in February, students who intend to conduct project work during the following year should set aside time to plan their projects, meet with faculty, and form project teams. The faculty will list project opportunities on the Projects Program web page in February. (Some Project Centers and special programs may have an application process before that.) Each academic department typically will hold a projects information meeting for students in their major. Students are also encouraged to meet with faculty individually.

*The most important and difficult part of a project is the planning which precedes the execution.* The planning phase of your project will involve developing a background, talking to people in the field, finding out what has already been done in the area, and determining what your goals are and what you need to do to accomplish them. If any special equipment, financing, or resources will be needed for execution of the

project, it is especially important to make this known early to ensure that it will be available to you. In addition, most faculty members require a project proposal before registration of the project.

### PROJECT REGISTRATION

Students who intend to do project work must complete a project registration form by no later than the beginning of the first term of that project work. The Project Registration Form is available on-line at the Registrar's Office web site, under Forms For Students. Once completed on-line, it must be printed for the signature of the student and the project advisor, and brought to the Registrar's Office. Any student who will travel to an off-campus location, such as a Residential Projects Program site, is required to file a project registration form with the Registrar's Office before traveling to that site.

Project/Independent Study registration for terms A-E will be accepted up to the 15th day of the term (not including weekends) without penalty. A \$100 late registration fee will be charged per project/independent study after the 15th day.

A project involving an off-campus sponsor (MQP mostly, but some IQP) carries the further obligation of compliance with the rules and regulations of the sponsor. Often, these are specified in a formal contract between the sponsor and WPI, and are legally binding. At the time of registration, any affected student will be required to review the legal documents in the Registrar's office, and sign an agreement and release form.

A student may not receive monetary compensation from an off-campus sponsor and receive academic credit for the same work.

**For an MQP, the project advisor or an associate advisor must be a member of the faculty in the discipline which corresponds to the major area of study of the student.**

### CHANGE OF REGISTRATION INFORMATION

For all changes in projects, use the Project Registration Form. Students may change the title, the type or the discipline of the project with the approval of the project advisor but without having to secure the approval of the academic advisor. The student must obtain the project advisor's written approval and the academic advisor's approval before changing the number of units in the current or future terms.

All project changes are to be made only during the course-change period of each term.

### CHANGING PROJECT ADVISOR

To change the project advisor for a degree-required project, students must obtain the authorizing signatures of both the existing and new project advisors and of the academic advisor and submit the form during a course change period.

### PROJECT CONFERENCES

Students should report to their project advisor's office at the beginning of the term to make arrangements for subsequent meetings.

### OVERLOAD WITH PROJECT

If a part of the work in a given term involves qualifying project work, students may not register for an overload without the written approval of both the academic and project advisors on a project overload petition form. This form is available at the Registrar's Office.

### PROJECT COMPLETION

During the final term of registration for the project and sufficiently prior to the deadline for submittal of Completion of Degree Requirement Forms, students must submit their completed project report to the project advisors. Students are also required to submit a copy of the document to the participating off-campus organization sufficiently prior to the end of the term so that proprietary and confidential information in the report can be identified and removed. Most off-campus organizations require 30 days for this review, and the grade and final report cannot be submitted to the Registrar by the project advisor until this review has been done.

The project report must contain a title page similar in format to that specified on the Projects Program web page, in the area entitled, "Finishing Up." A final project report may NOT be submitted as hard copy, or on disk or CD. Directions for submitting the project report electronically are available in Gordon Library or on-line. (See Electronic Project Submission on page 14.)

## REGISTRATION POLICY FOR DEGREE REQUIREMENTS

The completion of a degree requirement (MQP, IQP or Humanities and Arts Requirement) will not be recorded in the Registrar's Office after the second day of classes of a term unless the student is registered for a minimum of 1/6 unit *of the same activity* in that term. The deadline for receipt of the Completion Form (and reports for projects) is no later than the second day of classes for the next term. Any exceptions to this policy must be handled by written petition from the project advisor.

NOTE: Candidates for degrees must meet graduation deadlines if they differ from the above. Deadlines for degree candidates will be strictly enforced!

Only Completion of Degree Requirement (CDR) forms which are complete, correct and consistent with the student's registration records will be accepted by the Registrar's Office. The CDR must be accompanied by the written report or other appropriate documentation. (See PROJECTS section, page 14.)

## SPECIAL STUDENTS

The status of Special Student during the regular academic year is granted only to those who meet one or more of the following qualifications:

1. Persons holding a baccalaureate degree before the start of a semester.
2. Persons wishing to take a specific course and who are not pursuing a degree program at WPI.
3. Persons pursuing a degree program over an extended period of time and who have a planned program which involves a *maximum* of one unit per semester (August through December; January through May) *throughout* the academic year.
4. Students may apply for Special Student status on a semester-basis at the Registrar's Office. Financial aid may be impacted by this change-of-status. Campus housing will not be allowed.

Special students pay tuition on the basis of 1/3 unit at the start of each term. All other undergraduate students will pay full tuition and will be considered regular students with full resident

privileges. (Special students may not engage in varsity/club sports, may not participate in any extracurricular activities, may be required to register for courses on a space-available basis, and *are not eligible for financial aid or any form of on-campus student employment.*)

The following registration procedures apply:

- Students who wish to enroll as special students must apply for such status before Enrollment Day, Term A. Such status will allow a maximum of one unit per each semester of the academic year. Students who enroll as regular students in the fall may not transfer to or from special student status until the following fall or until all degree requirements have been certified with the Projects and Registrar's Office as having been satisfactorily completed.
- Changing between full-time/part-time status is not allowed at midsemester.
- Special students wishing to return as full-time students must be readmitted according to the procedures specified under Readmission in the Admissions section of this catalog, page 196.

For the Guidelines for Determination of Satisfactory Progress for Special Students, see page 172.

## PROJECT REGISTRATION TOPIC CODES

### MQP MAJORS AND COORDINATORS

	<b>Majors</b>	<b>Coordinators</b>
BIO	Biology and Biotechnology	J. Rulfs
BBC	Biology and Biotechnology with Concentration	J. Rulfs
BC	Biochemistry	K. Wobbe
BME	Biomedical Engineering	Y. Mendelson
CA	Computers with Applications	D. Finkel
CE	Civil Engineering	T. El-Korchi
CH	Chemistry	K. Wobbe
CHE	Chemical Engineering	W. Clark
CS	Computer Science	D. Finkel
ECS	Economics/Science	O. Pavlov
ECE	Electrical and Computer Engineering	R. Labonte
EP	Environmental Policy and Development	J. Doyle
EV	Environmental Engineering	J. Plummer
HU	Humanities	M. Parkinson
ID	Interdisciplinary	R. Vaz
IE	Industrial Engineering	S. Johnson
IS	International Studies	P. Hansen
MA	Mathematical Sciences	S. Weekes
MAC	Actuarial Mathematics	J. Abraham
ME	Mechanical Engineering	B. Savilonis
MFE	Manufacturing Engineering	K. Rong
MG	Management	M. Banks
MGE	Management Engineering	M. Banks
MIS	Management Information Systems	M. Banks
PH	Physics	T. Keil
PHE	Engineering Physics	T. Keil
SD	System Dynamics	K. Saeed
STP	Society, Technology & Policy	J. Wilkes
TC	Professional Writing	C. Demetry
PSS	Psychological Science	J. Doyle

### HUMANITIES AND ARTS ADVISORS

<b>Topics</b>	<b>Project Advisor</b>
Topics in American Studies	S. Bullock, J. Hanlan, K. Ljungquist, W. Mott
Topics in Art	M. D. Samson, J. Rosenstock
Topics in Drama/Theatre	J. Sands, S. Vick, J. Zinn
Topics in Foreign Language (German)	D. Dollenmayer
Topics in Foreign Language (Other)	A. Rivera
Topics in Foreign Language (Spanish)	A. Rivera
Topics in Global Studies	W. Addison, P. Hansen
Topics in History (American)	W. Baller, S. Bullock, D. Gray, J. Hanlan, D. Rawson, J. Watters
Topics in History (European)	W. Addison, W. Baller, J. Forgeng, P. Hansen
Topics in History (Science and Technology)	M. Barroll, J. Forgeng, E. Parkinson, D. Spanagel
Topics in International Studies- Humanities (Interrelated)	B. Addison, P. Hansen
Topics in Literature (American)	J. Dempsey, K. Ljungquist, W. Mott, S. Nikitina
Topics in Literature (Contemporary)	
Topics in Literature (English)	J. Brattin, M. Ephraim
Topics in Music	F. Bianchi, J. Delorey, R. Falco, E. Shim, D. Weeks
Topics in Philosophy	R. Gottlieb, J. Sanbonmatsu
Topics in Religion	R. Smith
Topics in Writing, Rhetoric, and Communications	L. Higgins
International Students	J. Forgeng
IMGD	D. O'Donnell, J. Rosenstock

# RESOURCES AND SPECIAL PROGRAMS

## SECTION 5

The Gateway Park . . . . .	178
Special Programs for First Year Students . . . . .	178
Combined Bachelor/Master's Program . . . . .	178
Computer Resources . . . . .	179
Music and Theatre Facilities . . . . .	180
George C. Gordon Library . . . . .	180
Academic Technology Center . . . . .	181
Student Services . . . . .	181
Entrepreneurship . . . . .	183
Student Exchanges . . . . .	183
Worcester Consortium Course Cross-registration . . . . .	185
Cooperative Education Program . . . . .	185
Summer Session (Term E) . . . . .	186
Awards and Prizes . . . . .	186
Societies, Registration and Licensing . . . . .	189



---

## THE GATEWAY PARK

---

Located near the intersection of I-190 and I-290 in Worcester, the Gateway Park is transforming a 12-acre former industrial site into a mixed-use destination for life sciences and biotech companies and the people who work for them. The project will include five life sciences buildings totaling 500,000 square feet of flexible, adaptable lab space designed to meet the needs of research organizations; 241,000 square feet of market rate, loft condominiums; and several planned retail establishments. The first building, the WPI Life Sciences and Bioengineering Center, was completed in spring 2007; additional buildings are in the planning stages.

In fall 2007, the Gateway Park won two major national awards for excellence in designing the re-use of former industrial sites. Undergraduate projects in the life sciences are conducted here as well as in Salisbury Labs and Goddard Hall.

For more information on the Gateway Park, see the website at <http://www.gatewayparkworcester.com/index2.html>.

---

## SPECIAL PROGRAMS FOR FIRST YEAR STUDENTS

---

### INSIGHT PROGRAM

In WPI's *Insight Program*, groups of 25 to 30 first-year students are advised by a faculty mentor who makes a real commitment to working with first-year students. These faculty members represent all the departments and programs at WPI, and in many cases are the senior faculty members and the most experienced advisors. Each faculty advisor works with two advanced undergraduates, the Community Advisor and the Residence Advisor, to schedule activities focusing on time-management, study skills, test-taking strategies, and community service. The Insight Program purposefully blends the academic and social aspects of life at WPI.

### GREAT PROBLEMS SEMINARS

This is a two-course sequence designed to serve as an introduction to project work and university-level research with a focus on themes of current global importance. The Great Problem Seminars (GPS) are all about important problems. Everything students do is tied to current events, societal problems and human needs. The skills students develop are exactly what they need to be successful both in project work at WPI and in their future careers.

Example: In 2007, the *Feed the World Seminar* was built around a sequence of projects tied to food, ranging from the biology of genetically engineered corn to the ethics of price supports and fair trade. This seminar provided one course credit in Chemistry and one course credit in Humanities.

Example: In 2007, the *Power the World Seminar* was built around a sequence of projects tied to energy, ranging from the physics of power generation to the ways that new technologies have changed societies. Students in Power the World earned credit for one course in Physics and one course in Humanities.

New themes will be offered each year.

Enrollment is limited.

### PROJECT-BASED LEARNING COMMUNITY (PLC)

WPI offers a program that blends Physics, Math, and Humanities or Social Science together in a unified learning experience constructed around group projects. The students involved are provided with a special opportunity to explore the relationship between mathematics and science and to appreciate their place in history and society. Benefits of the PLC include an outstanding student-teacher ratio (about 24 to 3); emphasis on teamwork over multiple projects; a new social community and meeting place to build lasting relationships with other first-year students.

The students "own" the PLC room for all of A and B terms. All of these classes are held in this room that is equipped with computers, white boards, and plenty of space to work. WPI's Project-based Learning Community is committed to experimenting with ways of learning through the structure of small group projects and study communities.

Students in the PLC earn credit for two courses in Calculus, Physics, and Humanities.

Enrollment is limited.

### ADDITIONAL RESOURCES ON THE WEB

The Undergraduate Programs Web Site ([www.wpi.edu/Academics/Undergraduate/](http://www.wpi.edu/Academics/Undergraduate/))

The Academic Advising Office ([www.wpi.edu/+OAA](http://www.wpi.edu/+OAA))

The First Year Web Site ([www.wpi.edu/+FYE](http://www.wpi.edu/+FYE))

---

## COMBINED BACHELOR/ MASTER'S PROGRAM

---

The Combined Bachelor/Master's Program is a unitary program leading a student to a bachelor degree and to a master of business administration, master of engineering, or master of science degree. The purpose of the Combined Bachelor/Master's Program is to give WPI undergraduates an opportunity to earn a bachelor and a master's degree from WPI concurrently in less time than would be required if the student were to complete work on the bachelor degree before beginning work on the master's degree. To gain the full benefit of this program, a student should apply for the Combined Program well before the bachelor degree is completed. Application at the beginning of the junior year is recommended.

For the master of science and master of engineering degrees, the Combined Program typically allows a student to complete requirements for both degrees in about one more year of full-time study than would be required to earn the bachelor degree. With careful planning, a student can obtain a similar reduction in the amount of time required to earn an M.B.A.

### PROGRAM REQUIREMENTS

Only registered WPI undergraduates may enter the Combined Program. To enter, a student must apply to the WPI Graduate Program. Admission to the Combined Program is made by the faculty of the program that awards the graduate degree. A student in the Combined Program continues to be registered as an undergraduate until the bachelor's degree is awarded.

While in the Combined Program, a student may continue to take courses or projects toward the undergraduate degree; the student may also register for graduate courses, projects, directed research or thesis credits toward the master's degree.

To obtain a master's degree via the Combined Program, the student must satisfy all requirements for that master's degree, including any requirements of the graduate degree-awarding program for satisfactory completion of specified courses or a master's thesis. To obtain a bachelor's degree via the Combined Program, the student must satisfy all the requirements for that bachelor degree, including distribution and project requirements.

A student in the Combined Program, may, within the program limit and with prior approval, use the same courses toward the bachelor and master's degrees. The limitation is computed from the graduate credit hours for each course. Courses, whose credit hours total no more than 40% of the credit hours required for the master's degree, and which meet all other requirements for each degree, may be used to satisfy requirements for both degrees. Such courses are recorded on the transcript using the credit hours/units and grades appropriate at the graduate or undergraduate levels. For students in the Combined Program, approved undergraduate courses are assigned graduate credit with a conversion rate of 1/3 WPI undergraduate unit = 3 credit hours, while graduate courses applied toward the undergraduate degree are awarded undergraduate credit with a conversion rate of 1 credit hour = 1/9 undergraduate unit. There are some academic departments that allow only 30% or 3 course double counting of credit. Check the graduate catalog for rules pertaining to your program.

Students in the Combined Program may use advanced undergraduate courses to satisfy graduate degree requirements. The department decides which courses may be used in this way. Faculty members teaching these advanced undergraduate courses may impose special requirements, appropriate to an undergraduate course being used for graduate credit, on Combined Program Students.

In many cases, including if the programs awarding the bachelor and master's degrees are not the same, the program awarding the graduate degree may require that the student's Major Qualifying Project relate in some way to the graduate program's discipline. The graduate program may also make other requirements as it deems appropriate in any individual case. These requirements take the form of a written agreement (obtain Course Selection Form from the Office of Graduate Studies & Enrollment or at [www.wpi.edu/+GAO](http://www.wpi.edu/+GAO)) between the student and the graduate program, which must be completed and filed with the registrar before the student may be matriculated in the Combined Program.

The Combined Program is a full-time program of study. Once admitted to the Combined Program, a student must register every fall and spring semester until the graduate degree is completed. A student in the Combined Program who, during the fall or spring semester, has no registered activities is automatically terminated from the Combined Program, and may only be readmitted to the Combined Program by the Committee for Graduate Studies and Research via petition showing extenuating circumstances. Termination from the Combined Program does not affect a student's ability to continue toward the bachelor's degree.

Some graduate-degree-awarding programs impose additional restrictions on students in the Combined Program. Consult the degree requirements of individual programs for details.

Questions relating to the program should be referred to the discipline department heads or to the Office of Graduate Studies & Enrollment.

## COMPUTER RESOURCES

WPI's newest academic building, Fuller Laboratories, is designed to provide dedicated space for faculty, staff and students working in the information sciences. The Computing and Communications Center (CCC) is located in this building, along with the Computer Science Department and the Academic Technology Center.

CCC provides a wide range of services and access to computer resources for the WPI community and manages an array of powerful UNIX, Linux and Windows servers. All WPI students, faculty and staff may obtain a login ID from the CCC for academic course works, research and self-education. The ID will remain in force as long as the person continues to be registered as a student or to be employed by WPI. The systems have been configured so that the user will see the same familiar environment no matter which CCC workstation is used. CCC facilities are accessible from a wide variety of locations on campus or from around the world via the campus connection to the Internet. CCC operates the campus data network and Internet connectivity, including a VPN (Virtual Private Network) to access internal resources remotely. Computer systems operated by academic departments are also on the same CCC communications infrastructure, so they are accessible just as easily.

The CCC facilities offer x-terminals with Linux servers, as well as high-end PCs and several Macs. In addition to several computer classrooms and specialized labs, the CCC supports open access labs in every academic building totaling hundreds of stations across the campus. Each of these labs offers the same user interface, software profile, and network access to personal files as does the CCC lab.

PC file servers drive laser printers in the CCC facilities and other locations across campus. Also accessible in the CCC are a color postscript laser printer and scanning devices. Since the campus network distributes computing services across the campus, network-attached PCs in other buildings can use the CCC print service to generate high-quality output for reports and resumes. The servers also provide file service for many software packages including PC-based desktop publishing, spread sheets, databases, programming languages, and department courseware.

CCC supports the residence and fraternity network services. Using their personal PCs, students in residence halls can access the same software and interface available in CCC PC labs across campus. A wireless network is available in all academic buildings as well as primary residence centers. Wireless laptops are available on loan for use in the library and campus center.

In addition to supporting the academic computing system on campus, CCC operates the administrative system that provides data processing services to WPI administrative offices. The WPI information system provides ready access to important registration information. Students update their biographical information, check grades and drop/add courses over the network via the web interface to the administrative system.

CCC manages a computer help desk to answer users' questions on any of the computer platforms and to provide technical support for endorsed software packages. CCC also provides instruction sessions on supported software in the state-of-the-art computer-training classroom that the CCC maintains in the Gordon Library.

**GENERAL COMPUTER SCIENCE FACILITIES***Fuller 2nd Floor*

The department is housed in the specially designed Fuller Laboratories building, providing substantial office and laboratory space. A wide variety of computing equipment is available for course work, project work, and research in computer science.

The department has multiple Sun UltraSPARC, SGI, and Intel machines running Solaris, IRIX, Linux, and other operating systems, for interactive use. These may be accessed via roughly 70 PC's located in department offices, as well as from any of CCC's publicly available computers.

Every classroom, laboratory and office in Fuller Labs is connected to the campus-wide high speed communications network. The network provides access to other computing resources, including the Computing and Communications Center, and the Internet.

---

**MUSIC AND THEATRE FACILITIES**

---

**COMPUTER MUSIC LABORATORIES***Daniels Hall*

These laboratories support creative and research activity in a variety of music- and sound-related applications including real-time virtual orchestra design and production techniques. The lab contains hardware and software for multi-track digital recording and editing, signal processing, algorithmic composition, sound synthesis, MIDI sequencing, music notation, and music programming.

**GREAT HALL OF ALDEN***Alden Memorial: First Floor*

The Great Hall is used for major productions in Theatre and Music. It is the venue for the Masque Theatre performances. The Hall is sometimes used, in addition, for festive and gala campus functions.

**THE LITTLE THEATRE***Sanford-Riley, Lower Level*

Made possible with a major gift from the George I. Alden Trust, this intimate, 99-seat black-box style theatre is the university's first dedicated theatre facility. With its flexible layout and moveable seating, permanent lighting grid and sound system, control booth, greenroom/dressing room, and handicapped accessibility, the Little Theatre, a new home for the university's diverse theatre programs, is well suited for a wide range of dramatic presentations. For more information, see <http://users.wpi.edu/~ltheatre>.

**GREEN ROOM***Alden Memorial: First Floor*

Alden Hall houses many of the theatre activities at WPI, both academic and extra-curricular. The Green Room serves as the laboratory for Department of Humanities and Arts, Division of Drama Theatre Performance projects and Sufficiencies, MQPs and IQPs. The sub-basement contains the scene shop and props-storage area and also holds a major work room for Lens and Lights. Students interested in theatre performance and Lens and Lights activities have many resources in Alden Hall.

**SPAULDING RECITAL HALL AND OTHER ROOMS FOR REHEARSAL AND PERFORMANCE***Alden Memorial: Lower Level*

Alden Center for the Performing Arts houses the Spaulding Recital Hall, Perreault Chamber Rehearsal Room, the Janet Earle Choral Rehearsal Room, three practice rooms, and the Knight Lecture Room. Available for practice are Steinway grand pianos and the Three Manual Aeolian-Skinner pipe organ in the main Concert Hall. There are three concert grand pianos for recitals, ensemble work and concerts. WPI has some instruments that can be made available to students upon request.

**OTHER MUSIC FACILITIES**

Music facilities also include The Janet Earle Room, The Perreault Chamber Rehearsal Room, the music classroom, practice rooms, computer music labs and storage facilities.

**DRAMA/THEATRE RESOURCE LIBRARY**

The Department of Humanities and Arts Drama/Theatre Resource Library, housed in Salisbury Labs Room 20 and available as posted, contains publications, magazines, published scripts, and other information to assist students working on projects (MQP, IQP, Sufficiency, ISP) in Drama/Theatre. Scripts for current productions can usually be found nearby the Resource Library on the table in the center of the main Humanities and Arts area. Most resource items and display scripts must be used in the immediate area, and this service is not per se a lending library.

---

**GEORGE C. GORDON LIBRARY**

---

The George C. Gordon Library invites all WPI students to take advantage of the services and resources that the library offers. The library is open over one hundred hours each week during the academic year and offers a stimulating atmosphere for study. Technology infused work spaces are available for individual or group work, and scholarly resources in all formats are provided. Media and popular reading collections for recreational purposes are also available.

The library's Web site (<http://www.wpi.edu/+library>) is the focal point for library resources and services. The library catalog, electronic journals and books collections, databases, course-specific information, and many other resources are available from it. Access to WPI users who are off-campus is available through the proxy server.

The library collection supports the curriculum and research needs of the WPI community. Currently the library holds 39,000+ print and electronic journals, 38,000+ electronic books, 181,000+ print books, and 150+ research databases. The library collection also includes undergraduate project reports, graduate theses and dissertations, the WPI Archives and Special Collections, most notably the Robert Fellman Dickens Collection. In addition the library hosts a variety of gallery exhibits each year.

WPI students also have access to the collections of other academic libraries within Central Massachusetts thanks to the library's membership in the Academic and Research Collaborative (ARC). You can find out which libraries participate in this program or acquire an ARC cross-borrowing card by visiting Gordon Library. Students can also request materials not held in

Gordon Library through the Interlibrary Loan Office and Document Delivery service. The Gordon Library staff is both knowledgeable in the use of library resources and ready to assist students with information needs. The Reference Department helps students with research problems and questions, offers library instruction and orientation sessions, and provides research consultations to individuals and to project groups. Members of the staff will be happy to provide students with additional information about library services and resources.

---

## ACADEMIC TECHNOLOGY CENTER

---

The main office of the Academic Technology Center (ATC) is located in the southwest corner on the 1st floor of Fuller Laboratories. The ATC provides a wide variety of technology-based services in support of the teaching and learning needs of students, faculty and staff, and serves as the central coordinating and distribution hub for most of the audio/visual equipment utilized on campus. The ATC supports all of the technology available in WPI's electronic classrooms and conference rooms. In addition, instructional technology and audio/visual equipment can be reserved and signed out for short periods of time to support educational needs. Equipment loans are for valid WPI projects and classes only, and are not for personal use. The ATC's inventory of loan-out equipment includes laptop PCs, video/data projection systems, digital cameras, digital voice recorders, portable video equipment, TVs, VCRs, DVD players, overhead projectors, small and large screens, and other miscellaneous items such as portable storage, laser pointers, tripods, cables, etc.

In addition, the ATC offers graphic production services to faculty, staff and students. These include large format poster printing, image scanning and printing and converting 35mm slide to digital images.

The ATC provides oversight and support for *myWPI*, the university's learning and information portal. The *myWPI* portal is used in support of WPI's academic programs, but also services the communication and collaboration needs of student organizations, faculty/staff committees, and other campus-wide initiatives. The *myWPI* portal is located at [my.wpi.edu](http://my.wpi.edu). For assistance, please e-mail the Helpdesk at [helpdesk@wpi.edu](mailto:helpdesk@wpi.edu).

The ATC supports Interwise, a web conferencing tool that allows remote participants to meet real-time in a web-based environment. Interwise can be used from any location with a computer and high-speed internet connection. Participants can share files and a whiteboard, display video streams, and communicate via voice. Interwise is available for academic work only. For information on Interwise or to request and account for scheduling events, contact [connect@wpi.edu](mailto:connect@wpi.edu).

A state-of-the-art instructional television classroom/studio and two adjacent control rooms are also available and are used primarily in support of WPI's distance learning program - the Advanced Distance Learning Network (ADLN). Members of the WPI community who wish to produce a video in support of an educational activity can obtain professional assistance from the ATC (advanced notice is required). Production costs are usually covered by the ATC. On-location production using portable equipment can also be arranged but require additional preparation and planning.

The head end of the WPI cable TV network is located in the ATC. Announcements pertaining to campus events can be shown on the WPI Video Bulletin Board (submissions can be made from the ATC website). In addition, the ATC operates and maintains WPI's satellite receiver, capable of receiving both Ku and C-based transmissions and ISDN/IP-based videoconferencing systems.

For more information about the services available from the ATC, please refer to the department's website at <http://www.wpi.edu/+ATC>.

---

## STUDENT SERVICES

---

### STUDENT DEVELOPMENT AND COUNSELING CENTER

---

The WPI Student Development and Counseling Center (SDCC) provides a wide range of services that are FREE of charge to all students enrolled in classes at WPI. The primary purpose of the SDCC is to provide counseling, educational programming and training, referral, and crisis intervention services to the entire WPI student community focusing on 1) assisting students in their full and complete development as they go through the process of becoming adults so that they may achieve greater levels of personal, academic, and professional success, and 2) assisting students in becoming aware of, and effective in, their roles, relationships, and responsibilities as members of an ever burgeoning global society. The professional staff are trained to help students deal with a variety of issues including:

**Situational Problems-** poor academic performance; managing stress; time management; relationships with significant others; divorce or other family problems; feelings of loneliness, anger, anxiety, confusion, depression; loss; discrimination; harassment; alcohol or other substance problems; sleep disturbances; medical/physical conditions; learning disabilities.

**Crisis-Related Problems-** physical and/or sexual assault; impulse control problems; suicidal thoughts or behaviors; traumatizing experiences such as date rape, academic setbacks, or the loss of a loved one.

**Developmental Issues-** developing self-esteem; establishing personal and/or gender identity; helping to define sexual orientation; managing stress from earlier traumatic events; exploring personal and professional goals.

The SDCC staff can also provide referral services for psychiatric evaluation, psychological and learning disability assessment, or other treatment.

The services of the SDCC are confidential. The mental health professionals and support staff are highly trained and sensitive to students' privacy and personal concerns.

The SDCC is located at West Street House, 157 West Street, near the corner of Institute Road. Appointments may be made during the academic year (A through E terms) in person or by calling (508) 831-5540. Office hours are 8:30 a.m. to 5:00 p.m. Monday-Friday (8:00 a.m. to 4:00 p.m. June to mid-August).

## MAJOR SELECTION PROGRAM, A SERVICE OF THE CAREER DEVELOPMENT CENTER

Choosing a college major and its associated careers is one of the most important decisions you will make. The Major Selection Program, or MSP, provides you the means to make that decision in an informed manner.

Why? We know that if you are in the “right major” and knowledgeable about the career paths available to you, you will enjoy your coursework, do better academically, and have a passion for your chosen work following graduation.

How can you select a major or learn more about a particular career path that leads to satisfaction? The answer is easy, through the information and experiences the MSP offers.

Contrary to what most people think, the MSP is not just for first-year students. It can help any WPI student to explore, identify and select a major and/or career field.

MSP activities include, but are not limited to:

- Academic Department presentations
- Company tours
- B-term seminar
- Career tests
- Individual Counseling

The CDC is located in the lower level of the Project Center. Appointments may be made in person or by calling (508) 831-5260. Office hours are 8:30am.-5:00pm.

## MASH (MATH AND SCIENCE HELP) PROGRAM

MASH is an academic support program for first-year students in mathematics and science courses. Offered to all students enrolled in a supported course, MASH provides assistance in regularly-scheduled study sessions beginning the first week of the term.

MASH review sessions are offered for a limited number of courses which students and faculty have identified as difficult. These courses may have heavy homework assignments or they may require understanding of new and difficult concepts. Whatever the reason, some courses are more challenging than others. MASH helps students meet that challenge.

Each study group is guided by a MASH leader, an undergraduate student who has taken the course before and who, therefore, understands the course material and what the instructor expects. MASH leaders attend all class lectures, take notes, complete assigned readings and other assignments, and conduct three or four 50-minute MASH sessions each week. By attending class and demonstrating effective student behavior, MASH leaders can assist students with the language of the discipline, the integration of lecture and readings, and the development of good study habits.

Through the MASH program, students become actively involved with the content material in a supportive environment. Studies show students who attend MASH sessions regularly earn higher grades than students electing not to participate. But even more important, MASH participants master new concepts, learn to put ideas into perspective, and develop a better way to study. MASH is offered by the Office of Academic Advising.

## ACADEMIC RESOURCES CENTER

WPI's Academic Resources Center (ARC) provides academic support services that are designed to enrich and enhance the learning experience of all WPI undergraduate students. Its student-based collaborative learning environment offers individualized assistance in a variety of subjects, as well as a comprehensive peer tutoring program, seminars and workshops.

Students may obtain individual counseling in such areas as learning styles, effective study strategies, problem solving and critical thinking skills, and time management. Appointments may be set up with staff members to develop individualized Academic Success Plans which help students set their academic goals, discover their learning strengths and weaknesses, and design the appropriate learning and study strategies that work best for them.

Students may call (508) 831-5281 for an appointment.

Periodically, students may find that they need some individual assistance with a particular subject or topic. The ARC peer tutors, who are certified by the College of Reading and Learning Association, help students one-on-one in a variety of academic subjects. Tutors are available on a walk-in basis Monday through Thursday. See [www.wpi.edu/Admin/ARC/tutorschedule.pdf](http://www.wpi.edu/Admin/ARC/tutorschedule.pdf) for an up to date tutor schedule.

The Academic Resources Center is located in Daniels Hall.

## STUDENT DISABILITY SERVICES OFFICE

The mission of the Student Disability Service Office is to ensure that all students with disabilities can freely and actively participate in all facets of University life; to provide and coordinate support services that enable students with disabilities to maximize their educational potential and to increase the level of awareness among members of the University so that students with disabilities are able to perform at a level limited only by their abilities, not their disabilities.

By law, it is the student's responsibility to identify himself/herself to the Student Disability Services Office (DSO) and to provide documentation of the disability by a licensed professional. (Please note that the documentation for students with learning differences and ADD/ADHD must be dated within the last three years.) All students who have been admitted to WPI have the opportunity to self-identify their disability (physical and/or learning) by filling out the bottom portion of the Voluntary Disclosure form which is enclosed in the New Student Orientation Package. Students should send this form, along with the supporting documentation, to the DSO. Students with disabilities, who are diagnosed after their admission to WPI, must also provide appropriate documentation to the DSO, if they wish to receive accommodations.

For further information please visit the Disability Services web page at <http://www.wpi.edu/Admin/Disabilities/transition.html>. The Disability Services office, located in Daniels Hall, is open Monday - Friday 8:00 a.m. - 4:30 p.m. Students may drop in or call (508) 831-5235 for an appointment.

## WRITING WORKSHOP A Division of the Center for Communication Across The Curriculum (CCAC)

The Writing Workshop offers all WPI students tutorial assistance on writing of any type: course assignments, project work, oral presentations, laboratory reports, proposals, resumes, and letters of application. The workshop is directed by a member of the Humanities and Arts Department faculty and staffed by student peer tutors, all of whom have been trained in a special course on tutoring writing. Students may be referred to the Workshop by faculty, or students may make appointments on their own initiative. The workshop is open according to posted schedules, and its tutorial services are available at no cost.

For more information, visit the CCAC website: [www.wpi.edu/twritng](http://www.wpi.edu/twritng) or drop in at the Project Center.

## WRITING COURSES AND ADVISORS

For information on WPI's writing programs, see Humanities and Arts faculty as follows:

Students for whom English is the native language can consult Prof. J. Trimbur (39 Dean St., Room 258) about these programs.

The WPI advisor for undergraduate students whose native language is not English is Prof. J. Forgeng (SL 08).

## WORLD WIDE WEB

The WPI World Wide Web server is the campus information system. It contains a great deal of useful information about people and programs at the university, and is updated frequently. In addition, by using the Web, students gain access to a vast universe of information on any subject imaginable. This is why the Web is such a useful research tool for both faculty and students.

WPI's Web address, or URL, is: [www.wpi.edu](http://www.wpi.edu). Questions about WPI's Web site should be directed to the Web Development Office, [webmaster@wpi.edu](mailto:webmaster@wpi.edu).

## ENTREPRENEURSHIP

The Collaborative for Entrepreneurship and Innovation (CEI) at WPI is part of the Department of Management. It coordinates opportunities for undergraduate and graduate students within WPI, such as the WPI chapter of the international organization, Collegiate Entrepreneurs Organization (CEO), and is available for consultation on Intellectual Property issues and concerns that students and faculty members might have related to projects. The other major component of the CEI, the WPI VENTURE FORUM, coordinates the outreach opportunities for WPI students and faculty members, as well as those outside of WPI.

Everything we do in the CEI is driven by our mission and goals, which you will find below. That is because we are providing our students with an integrated experience that will help them become the very best entrepreneurs in the world.

### OUR MISSION

The Collaborative for Entrepreneurship and Innovation inspires and nurtures people to discover, create, and commercialize new technological products and services, and to create new organizations based on those products and services, thereby advancing economic development and improving society.

### OUR GOALS

We will:

- Attract students and faculty members to WPI who are interested in using inventions and technology to foster new businesses;
- Foster informed risk-taking among our undergraduate and graduate students and others wishing to pursue the dream of entrepreneurship;
- Build bridges between WPI students, staff, faculty, and alumni, and the wider entrepreneurial business community;
- Encourage corporations to develop an environment that celebrates entrepreneurship as a combined act of discovery, creativity, and innovation; and
- Achieve a leadership role among the preeminent entrepreneurship programs in the U.S.

Currently the CEI offers a number of opportunities to WPI students. These include:

- A minor in Entrepreneurship through our parent organization, the Department of Management.
- Courses in Entrepreneurship for those who do not wish to take a minor.
- MQP and IQP opportunities in Entrepreneurship.
- An external advising team of entrepreneurs and investors who are available to mentor aspiring entrepreneurs among our students.
- Networking opportunities through activities with our community outreach arm, the WPI Venture Forum.
- A student organization, the Collegiate Entrepreneurs Organization (CEO) at WPI, part of a nationwide organization that supports and fosters entrepreneurial intentions among college students.

The CEI@WPI ALL-OUT Business Plan Challenge. All WPI students are eligible to compete for cash and in-kind prizes and the opportunity to advance to other competitions.

For more information on the Collaborative for Entrepreneurship and Innovation, please contact Gina Betti, Associate Director, CEI, 226 Washburn at 508-831-5761; [gbetti@wpi.edu](mailto:gbetti@wpi.edu).

## STUDENT EXCHANGES

As technology and commerce become increasingly international in outlook, students in engineering, science and management must learn about countries and cultures other than their own. To respond to this need, WPI offers its students an extensive range of opportunities to broaden their academic and cultural perspectives through study in a foreign country. Unlike many other exchanges, the WPI program is structured to allow students to work directly with foreign students, faculty, and professionals, and to live in residences with the students of the host institution. For WPI students on these exchanges, time is usually available for additional travel, before or after the formal academic period.

WPI presently offers undergraduate exchanges with universities in Canada, Germany, Mexico and Sweden as described in detail below.



These exchange programs typically involve third-year students, though qualified sophomores and seniors have been accepted. Students could go on these exchanges for a semester or a full year. Where perfecting a foreign language is part of the program in Germany or Sweden, a full year abroad is more common. **The principal academic emphasis in all exchanges is upon course work.** In such programs, students must work closely with their advisor, the academic advisor of the exchange program, and the program coordinator at the site to design an individual program of study. Students have the responsibility of obtaining prior tentative approval from their department that courses taken abroad will count towards departmental distribution requirements. For final transfer credit evaluation, students must provide upon return the necessary detailed information on the content of courses taken abroad and the satisfactory completion of all work. In some exchanges, opportunities exist to complete project work (IQP, MQP, and Humanities and Arts requirement). The exchanges offer exceptional possibilities for projects comparing American and overseas applications of technology and the impact of technology on society.

For more information on these programs, consult with Leanne Johnson in the Project Center or the academic advisor listed for each program.

---

## LANGUAGE REQUIREMENTS

---

The usual language of instruction at most of the exchange institutions is the official language of the host country. While these institutions may offer a few courses taught in English, most lectures will be given in a foreign language. Thus, exchange students who intend to complete substantial course work must acquire the necessary language background. In some cases intensive language instruction can be arranged on site. In other cases, students acquire the language background through courses taught at WPI or other colleges, or by self study. A few exceptions exist at some technical universities where the official language of instruction may be English. For information about language requirements, inquire with the academic advisor listed for each program or Pam O'Bryant in the Project Center.

---

## ECOLE POLYTECHNIQUE; MONTREAL, QUEBEC, CANADA; EXCHANGE

---

Coordinator: Leanne Johnson, Project Center  
Academic Advisor: Prof. W. A. Bland Addison,  
Salisbury Labs 02

The Ecole Polytechnique de Montréal provides WPI students with the opportunity to study in French without incurring the cost of transatlantic travel. The École Polytechnique is located in the beautiful cosmopolitan city of Montreal, known for a rich variety of cultural activities, night life, and easy access to winter sports. This program offers a unique opportunity for an inside look at francophone culture within Canada today. Students study and socialize with French-speaking students at Poly and can take French language courses at the University of Montreal. In coordination with the academic advisor of the program, students can complete French language or French-Canadian Studies sufficiencies or IQPs through the exchange.

---

## MONTERREY INSTITUTE OF TECHNOLOGY; MONTERREY, MEXICO; EXCHANGE

---

Coordinator: Leanne Johnson, Project Center  
Academic Advisor: Prof. Cosme Furlong-Vazquez, Higgins Labs  
WPI has established an exchange agreement with Monterrey Institute of Technology (The Instituto Tecnológico y de Estudios Superiores de Monterrey, ITESM). ITESM was founded in 1943 and is the foremost private technological and management university in Mexico, with programs available in Spanish at the main campus in Monterrey in northern Mexico. Some opportunities also exist for study at selected ITESM satellite campuses at 25 other locations in Mexico, by special arrangement in advance. WPI students have excellent opportunities to study engineering, science, and management in this leading Spanish-speaking university. In addition, ITESM offers special courses for North Americans wanting to learn how to do business in Latin America, and a full program of residential and academic study for English-speaking students seeking to increase their knowledge of Spanish language and culture.

---

## ROYAL INSTITUTE OF TECHNOLOGY; STOCKHOLM, SWEDEN; EXCHANGE

---

Coordinator: Leanne Johnson, Project Center  
Academic Advisor: Holly Ault, Higgins Labs 207  
WPI and the Kungliga Tekniska Hogskolan (Royal Institute of Technology, KTH) in Stockholm, Sweden, have arranged an exchange for WPI students learning Swedish. KTH is a four-year technical university which is divided into ten different schools of engineering which are relatively independent of each other and control their own admissions.

The academic year, approximately August 25 to May 31, is divided into eight periods of four weeks (three weeks of classes and one week of unscheduled activities). Most courses last three to four periods; others may be shorter or longer. Final examinations for courses are normally given three to four times a year and can be taken repeatedly without having to repeat a course. There are some courses with regular examinations. Many students live in rooms and apartments in the city of Stockholm; some live in accommodations provided by the student union. Some scholarship aid is available, and students may fulfill their Sufficiency requirement through the -exchange.

---

## TECHNICAL COLLEGE; MUNICH GERMANY; EXCHANGE

---

Coordinator: Leanne Johnson, Project Center  
Academic Advisor: Prof. David Dollenmayer, Alden 209  
The "Technical College" is an institute for applied technology studies. Located in Munich, the FHSM has approximately 10,000 students. It offers degree programs in civil engineering, mechanical engineering, electrical engineering and computer science/engineering. For students who have developed adequate proficiency in Germany, the FHSM offers the possibility of completing a co-op assignment in Germany.

## WORCESTER CONSORTIUM COURSE CROSS-REGISTRATION

The Worcester Consortium for Higher Education consists of the following institutions: Anna Maria College, Assumption College, Atlantic Union College, Becker College, Clark University, College of the Holy Cross, Nichols College, Quinsigamond Community College, Massachusetts College of Pharmacy, Tufts School of Veterinary Medicine, University of Massachusetts Medical School, Worcester State College and WPI. Full-time WPI students who cross-register for courses at other Worcester Consortium colleges pay no extra fees. Students are limited to one course per semester. The no-charge plan does not include evening colleges or summer school. The Consortium provides buses which make frequent trips every day to all participating institutions.

Students interested in registering for Worcester Consortium courses should discuss their program with their advisors, and then obtain regulations and registration forms from the Registrar's Office.

## COOPERATIVE EDUCATION PROGRAM

### THE CO-OP PROGRAM

#### A Division of the Career Development Center

The WPI Cooperative Education Program provides an opportunity for students to alternate time in the classroom with extended periods of paid, full-time, career-related work experience in industry or private and government agencies. The program, which is optional at WPI, entails work assignments from six to eight months in duration which begin in either January or May.

Most students elect to participate in one co-op placement, though students may choose to work for more than one assignment. Students who participate in the co-op program can graduate on time especially when they have advance placement course work. It is recommended that students pre-plan during their first or second year at school. Preparation of a total college plan with the student's academic advisor is required to ensure a compatible scheduling of work periods and academic courses.

In order to qualify for the co-op program, students must meet the following requirements:

1. they must have completed two years of study but may not participate once they have started their senior year,
2. they must be in good academic standing (students cannot be on academic warning or probation),
3. they are only permitted to register for project credit during the co-op assignment with the approval of their academic and project advisors, co-op supervisor and co-op program coordinator, and
4. they must be full-time students.

Exceptions to any of these requirements are made by submitting a written petition to the Coordinator of Cooperative Education who consults with the WPI Registrar for a final decision.

### ADVANTAGES TO STUDENTS AND EMPLOYERS

Co-op offers several advantages to students:

1. Participating in co-op helps students make career-related decisions.
2. Students can test classroom learning in the real world.

3. Co-op earnings enable students to pay a significant portion of their college expenses.
4. Students improve their after-graduation job prospects by gaining valuable work experience. In fact, more and more companies are using their co-op program to identify candidates for full-time permanent positions when the students graduate and/or seek candidates with co-op experience from other companies.

Employers also benefit in a number of ways:

1. Co-op students can handle assignments that may be difficult for untrained personnel, but that do not require the talents of full-time professionals.
2. The program gives employers the chance to judge the actual on-the-job performance of potential permanent employees.
3. Retention rates for permanent employees recruited through a co-op program are higher than for those hired through other routes.

### THE PLACEMENT PROCESS

Students should attend the co-op orientation. Those who are interested in participating in the co-op program must register with the Career Development Center (CDC) several months before the start date of the work assignment.

Employers seeking to fill a co-op position provide the CDC with a brief job description. Students decide which jobs they are interested in applying for and the CDC forwards their resume to the appropriate companies. Some employers interview candidates on campus; others review resumes and then invite selected students for on-site interviews. The final hiring decision is left to the employer. The student is free to interview with more than one employer and to choose among the employment offers received. It often takes several months before the student is placed in a co-op assignment.

A co-op position is not guaranteed, but every effort is made to locate appropriate work assignments for qualified students. More than 300 employers have provided co-op opportunities to over 2000 students since the program began in 1976. The search for additional employers is an on-going activity.

### OTHER CONSIDERATIONS

The employment experiences gained through the Cooperative Education Program do not substitute for, nor qualify as Major Qualifying Project (MQP) or Interactive Qualifying Project (IQP) requirements. These experiences, however, often generate ideas for qualifying projects with the cooperating companies.

For some students, the co-op orientation and registration period overlaps with an off campus activity, usually involvement with an IQP at one of our project centers. Students should not think that this prevents them from applying for co-op positions since our office has developed systems for dealing with their absence. Students who will be off campus during the orientation and registration period should contact the Career Development Center before their departure to complete the registration process in advance.

### INFORMATION AND REGISTRATION

Students interested in exploring the possibility of participating in the program should contact:

Career Development Center  
Project Center, Lower Level  
(508) 831-5260

During the summer, many courses central to planning major programs of study are offered at a time when all facilities are easily accessible. This is a great time to

- Make up a missing course
- Lighten the load for the next year
- Speed up your time to degree completion

This term also offers an exceptional opportunity to participate in certain types of project activity on a convenient basis since classrooms and laboratories will be less crowded and outside field work unlimited due to weather conditions. The use of the independent study has made it possible to present more individually-oriented course work during this term where class sizes are generally smaller. Many courses offered during Term E are included in the supplement to the catalog which is distrib-

uted to all students in March. A special summer study website is available at [www.wpi.edu/+Summer](http://www.wpi.edu/+Summer), in March. Students planning to participate in Term E should register at the regular spring registration period.

Term E also offers an excellent opportunity to complete a qualifying project or Sufficiency through a full-time effort during a single term. Students from other campuses are also invited to participate in the work of this term.

Admission to the summer session does not imply admission to regular academic year programs. Students desiring to continue their work at WPI following the summer session should seek admission following standard WPI admissions procedures issued through the Admissions Office.

For more information on the summer session, contact the Summer Session Office at (508) 831-5517.

## AWARDS AND PRIZES

Awards and prizes are determined by the academic department or by selected committees.

### COLLEGE AWARDS

#### SALISBURY PRIZE AWARDS

These historic awards are made to 14 highly meritorious seniors. These awards were established by Stephen Salisbury, a WPI founder and former president of the Board of Trustees.

#### TWO TOWERS PRIZE

This prize is awarded to the student who, through general academic competence, campus leadership, regular course work and special work in research and projects, best exemplifies a combined proficiency in the theoretical and practical union implicit in the Two Towers concept, which is at the heart of WPI's Two Towers tradition.

#### SIGMA XI AWARDS IN ENGINEERING AND SCIENCE

These awards in engineering and science are given to the students and their advisors for the Major Qualifying Projects which are judged to be the best in originality, contribution to the field, professional competence, and for the most useful applications.

#### PRESIDENT'S IQP AWARDS

These awards are given to student teams whose conception, performance, and presentation of their Interactive Qualifying Projects have been judged outstanding in focusing on the relationships among science, technology, and the needs of society.

#### PROVOST'S MQP AWARDS

These awards offer recognition to those students who have completed outstanding Major Qualifying Projects as a demonstration of their competency in a chosen academic discipline. Each academic department conducts its own competition to select the winners.

#### UNITED TECHNOLOGIES CORPORATION MINORITY AWARD

This award is presented to an outstanding minority undergraduate student.

### OUTSTANDING WOMEN STUDENT AWARDS

*Marietta E. Anderson Award*, an award which is presented to the most outstanding woman student in one of the three lower classes who not only has a superior academic record, but also has been a work-study student, participated in recognized extracurricular activities, and has been a volunteer for college-sponsored activities.

Funds from an anonymous donor provide the following awards to women students preparing for careers in engineering or science. Awards are based on academic excellence, contributions to the WPI community, and professional goals. The awards are named each year for women who have played significant roles at WPI.

*Bonnie-Blanche Schoonover Award*, honoring WPI's former librarian.

*Ellen Knott Award*, honoring a long-time secretary in the Mechanical Engineering Department.

*Gertrude R. Rugg Award*, honoring WPI's late Registrar Emerita.

### WILMER L. AND MARGARET M. KRANICH PRIZE

Students who are seniors or completing their junior year will be nominated by faculty for the annual award. The award will go to a student majoring in engineering, science or management who best exemplifies excellence in the humanities and in the full integration of humanities into his/her undergraduate experience. Double-majors who fulfill one major in Humanities and Arts are not eligible.

### SPECIAL AWARDS

#### ALPHA PHI OMEGA SERVICE AWARD

#### AMERICAN INSTITUTE OF CHEMISTS FOUNDATION *Chemistry and Biochemistry*

An award by the New England chapter of the American Institute of Chemists to honor outstanding seniors majoring in chemistry and biochemistry.

#### AMERICAN SOCIETY FOR METALS: CHESTER M. INMAN '14 OUTSTANDING STUDENT AWARD *Mechanical Engineering*

The Worcester Chapter of the American Society for Metals presents \$200 to a student for excellence in a Major Qualifying Project dealing with processing or materials science.

**HAROLD S. BLACK AWARD*****Electrical and Computer Engineering***

This award was established in 2001 to honor the memory of inventor Harold S. Black '21. The award is given by the faculty of the Electrical and Computer Engineering (ECE) Department to one or more ECE seniors who have demonstrated outstanding creativity and enthusiasm in engineering problem solving, practical implementation of problem solutions, and exemplary character in their contributions to the welfare of the WPI community.

**CENTRAL NEW ENGLAND AIChE AWARD FOR SIGNIFICANT CONTRIBUTION*****Chemical Engineering***

This award is given to an individual in recognition of significant contributions to the American Institute of Chemical Engineers.

**CLASS OF 1879 PRIZE FOR OUTSTANDING PROJECTS IN THE HUMANITIES*****Humanities and Arts***

This prize is awarded by the Humanities and Arts Department each year to three students for excellent work in Humanities and Arts Sufficiency projects. Sufficiencies must demonstrate exceptional creativity and skill in conceiving, developing and expressing a theme within any discipline in the humanities and arts.

**COMMUNITY SERVICE AWARD PRESENTED IN THE MEMORY OF EDWIN B. COGHLIN '23*****Alumni Office***

This award recognizes individuals who have demonstrated an extraordinary personal commitment above and beyond their normal involvement on campus in both academic and extracurricular activities.

**COMPUTER SCIENCE OUTSTANDING JUNIOR AWARD*****Computer Science***

This award is presented to a computer science junior who has an excellent academic record and who shows promise for continuing success.

**COMPUTER SCIENCE OUTSTANDING SENIOR AWARD*****Computer Science***

This award is presented to one or more computer science seniors who have an outstanding record and who have contributed to the enrichment and professional development of fellow students.

**JAMES F. DANIELLI AWARD*****Biology and Biotechnology***

This award, given by the Department of Biology & Biotechnology, honors the memory of Dr. James F. Danielli, a former department head and world-famous scholar.

**FRANK D. DEFALCO AWARD*****Civil and Environmental Engineering***

Award to WPI undergraduate Civil Engineering students who has completed two and one half years towards a B.S., interested in career constructed facilities and a member of ASCE student chapter.

**ETA KAPPA NU OUTSTANDING STUDENT AWARD*****Electrical and Computer Engineering***

The electrical and computer engineering honor society presents this award to the outstanding senior and junior in recognition of their academic achievement and their service to the WPI community.

**GENERAL CHEMISTRY ACHIEVEMENT AWARD*****Chemistry and Biochemistry***

This award is given to the student who has completed the freshman chemistry course with superior academic performance. Department award.

**ALLAN GLAZER AWARD*****Mechanical Engineering***

Established in 1992 by the family and friends of Allan Glazer '47, this award is given to a junior majoring in mechanical engineering who has demonstrated outstanding academic achievement, special ingenuity in problem solving, and enthusiasm for engineering challenges.

**GOAT'S HEAD AWARD*****Student Government Association***

Awarded annually to the outstanding new Senator of the year.

**THE ROBERT H. GODDARD AWARD*****Physics***

Established by the classes of 1908 and 1909 as a memorial to Dr. Goddard, this prize is awarded for outstanding achievement, scholarship, consistent effort and dedication of purpose in both theoretical and experimental areas of physics.

**HEALD BROTHERS SCHOLARSHIP*****Mechanical Engineering***

This scholarship identifies and supports outstanding young men and women who represent, in modern form, the spirit of "Yankee Ingenuity" that characterizes the evolution of the great manufacturing enterprises from the beginnings of the American Industrial Revolution.

**ANDREW HOLT MEMORIAL AWARD*****Civil and Environmental Engineering***

This award is presented to a civil engineering senior who has consistently earned academic honors and who shows excellent promise for success.

**STEVEN J. KAHN AWARD*****Humanities and Arts***

This award is presented to the outstanding senior in the WPI Glee Club in recognition of his contribution, commitment, and unwavering loyalty to the organization.

**THE WILLARD ELLIOT LAWTON-SAMUEL JAMES PLIMPTON AWARD*****Physics***

Established in honor of Professors Lawton and Plimpton, this award is presented to a student who has shown improvement in scholarship, not only in grades but also in depth of understanding.

**LINCOLN ARC WELDING FOUNDATION AWARD*****Civil and Environmental Engineering***

This award recognizes outstanding achievement in solving design, engineering, fabrication, and research problems.

**MEDWIN HONORS STRING QUARTET SCHOLARSHIP*****Humanities and Arts***

Scholarship money is given to the members of the Medwin Honors string Quartet (4 string players, 2 violins, 1 viola, 1 cellist), who are selected by audition each year.

**THE ALFRED R. AND JANET H. POTVIN AWARD***Biomedical Engineering*

Separate awards are given to the outstanding undergraduate and graduate student in Biomedical Engineering in recognition of their academic performance and their service to WPI and/or the outside community.

**MANAGEMENT EXCELLENCE AWARD***Management*

This award is given to one or more seniors who have demonstrated ability in courses and projects and who exhibits outstanding promise of future success in the field of management engineering.

**CARL F. MEYER IMPROVEMENT AWARD****IN CIVIL ENGINEERING***Civil and Environmental Engineering*

Established by Professor Emeritus Meyer, this award is presented to the civil engineering senior who has demonstrated the most improvement in academic and professional attitude since entering the department.

**RICHARD V. OLSON AWARD***Mathematical Sciences*

Established to honor the memory of mathematics Professor Richard V. Olson, this annual award to a WPI sophomore recognizes outstanding performance in basic mathematics courses.

**EDWARD C. PERRY AWARD***Mechanical Engineering*

This award is given annually to an engineering student or students for an outstanding major qualifying project in the area of mechanical design. The award is made possible through a bequest from Miriam Perry Goll and honors the memory of her father, Edward C. Perry '04, a design engineer with General Electric Company throughout his professional career.

**PI TAU SIGMA AWARD FOR EXCELLENCE***Mechanical Engineering*

The mechanical engineering honor society, Pi Tau Sigma, presents this award to the outstanding junior mechanical engineering student.

**SENIOR MATHEMATICAL SCIENCES MAJOR AWARD***Mathematical Sciences*

This award is presented to the senior mathematical sciences major who has shown outstanding performance and who has made valuable contributions to the WPI mathematical community.

**SOCIETY OF MANUFACTURING ENGINEERING SCHOLARS AWARD***ME/Manufacturing Engineering Program*

An MFE senior, recommended by the MFE faculty and confirmed by the officers of SME chapter 25, who has demonstrated excellent scholarship, leadership, service, potential to contribute to the profession of Manufacturing Engineering.

The award includes scholarship assistance (\$900) for full-time study if the winner enrolls in WPI's graduate MFE program.

**SOCIETY OF MANUFACTURING ENGINEERING UNDERGRADUATE SCHOLARSHIP AWARD***ME/Manufacturing Engineering Program*

Awarded to a 1st, 2nd, or 3rd year MFE major, recommended by the MFE faculty and confirmed by the officers of SME chapter 25, who has demonstrated excellent scholarship, commitment, and contribution to the Manufacturing Engineering program at WPI.

**SOCIETY OF MANUFACTURING ENGINEERS OUTSTANDING STUDENT AWARD***ME/Manufacturing Engineering Program*

The top three MFE majors each year, regardless of year, who have not already received the award.

**SOCIETY OF MANUFACTURING ENGINEERS MQP AWARD***ME/Manufacturing Engineering Program*

An MFE major, selected by a panel of practicing manufacturing engineers to have the best MQP in the area of Manufacturing Engineering.

**STUDENT-ALUMNI INTERACTION AWARD***Alumni Office*

This award is presented by the WPI Alumni Association in recognition of individuals who, through their involvement on campus, have facilitated the continuing development of interaction between students and alumni. Recipients are full-time undergraduate students who have demonstrated extraordinary personal commitment to WPI and the Alumni Association above and beyond the normal involvement on campus.

The award is designed to recognize students who have stepped forward to become leaders in the alumni and student communities and, in doing so, have benefited both WPI students and alumni in a unique and purposeful way.

**CHARLES O. THOMPSON SCHOLARS***Academic Advising*

Named in honor of the first president of WPI, this honor recognizes outstanding performance by first-year students.

To be eligible for membership, students must receive all A's and B's, with a minimum of six A's, in their academic subjects during the first three terms at WPI. Selections are made in Term D.

A cash award is presented to the outstanding first year student. Charles O. Thompson Scholars are eligible to apply for this award by submitting an essay to the Office of Academic Advising during D Term.

**ACS UNDERGRADUATE AWARD IN ANALYTICAL CHEMISTRY***Chemistry and Biochemistry*

Award which is intended to encourage student interest in analytical chemistry and to recognize a student who displays an aptitude for a career in the field. This award is for third-year students.

**WALL STREET JOURNAL AWARD***Management*

The Wall Street Journal presents this award to a senior with an outstanding record of achievement.

## ENGINEERING SOCIETIES

All engineers are professionals in accordance with the definition of engineering, one of which states that “engineering is the profession in which a knowledge of the mathematical and natural sciences gained by study, experience and practice is applied with judgment to develop ways to utilize, economically, the materials and forces of nature for the benefit of mankind.”

Professional engineers also observe a code of ethics, exercise judgment and discretion while providing their services, and are involved in a confidential relationship with their clients. Professional engineers enjoy legal status, use professional titles, and associate together through professional societies.

An excellent way to begin learning about the status of the professional engineer is to join the student branch of a professional society relevant to your interests. At WPI, students are encouraged to join the student branches of such societies as the American Society for Metals (ASM), American Society of Mechanical Engineers (ASME), the Institute of Electrical and Electronic Engineers (IEEE), the American Society of Civil Engineers (ASCE), the -American Institute of Chemical Engineers (AIChE), the American Institute of Aeronautics and Astronautics (AIAA), the Association of Computing Machinery (ACM), the American Nuclear Society (ANS), the Society of Automotive Engineers (SAE), the Society of Manufacturing Engineers (SME), the Society of Fire Protection -Engineers (SFPE), the Society of Women Engineers (SWE), the American Chemical Society, (ACS), and the Society of Hispanic Professional Engineers (SHPE). For information on these organizations, see the appropriate department head.

Undergraduate students should begin the process of becoming professionally registered and licensed by following the steps detailed in the next section.

## ENGINEERING REGISTRATION AND LICENSING

In order to become a “Professional Engineer” (P.E.) and enjoy the legal status which affords certain rights, privileges and responsibilities, engineers must qualify through the formal procedures of registration and licensing. Procedures vary from state to state, but in most cases, the applicant must pass a Fundamentals of Engineering Examination.

### FUNDAMENTALS OF ENGINEERING EXAMINATION

To become legally registered as a professional engineer (P.E.), candidates must submit data regarding formal education and technical ability to the appropriate state Board of Registration for Professional Engineers. Two major examinations, The Fundamentals of Engineering Examination (also called Engineering-in-Training, E.I.T.) and the Professional Practice Examination (P.P.E.), must be successfully completed as a

measure of technical ability. The Fundamentals Examination must be taken first; the Professional Practice Examination must then be taken after a designated period of substantial professional experience, usually a minimum of four years. File applications for E.I.T. by January 1. The E.I.T. Examination will be given in mid-April and late-October. File applications for Professional Practice Examinations (P.P.E.) six months in advance.

There are several possible qualification paths to registration as a P.E. The quickest and most common route is to obtain a degree from an ABET (Accreditation Board for Engineering and Technology-formerly ECPD) accredited curriculum, and to acquire the specified amount of suitable professional level experience in addition to passing the two examinations mentioned above. There are seven ABET accredited curricula at WPI-biomedical engineering, civil engineering, chemical engineering, electrical and computer engineering, manufacturing engineering, industrial engineering, and mechanical engineering. Persons with an unaccredited degree can still become registered in most, but not all, states by submitting evidence of a longer “apprenticeship” period (variable by states) before taking the two examinations. Students should strive, if at all possible, to pursue a program which is accredited by ABET and should work closely with their advisors and appropriate major departments to assure that the total program qualifies for accreditation, since this will greatly facilitate the achievement of registration in the future.

**ALL SENIOR ENGINEERING MAJORS IN BME, CE, CHE, ECE, ME AND MFE ARE URGED TO TAKE THE FUNDAMENTALS OF ENGINEERING EXAMINATION WHICH IS GIVEN ON CAMPUS EACH FALL AND SPRING. There will never be a better time!**

Refresher courses for students, alumni and practicing engineers are available. Successful completion of this examination is normally the first step in eventually obtaining the right to use the initials “P.E.”

WPI’s Office of Continuing Education sponsors an eleven session EIT Refresher course from mid-January through mid-April on the WPI Campus. The course, which is taught by WPI faculty, includes reviews of the major topics covered on the exam. For further information, call 508-831-5517.

### DESCRIPTION OF FUNDAMENTALS OF ENGINEERING EXAMINATION (F.E.E.)

*Typical Date Given:* Last Saturday in October (also in April).

*Typical Application Deadline:* First week in September (also in January).

*Duration:* Eight hours.

*Type:* Multiple choice, open book.



# CAREER DEVELOPMENT AND GRADUATE SCHOOL

Career Development Center .....	191
Graduate Studies .....	191
WPI Graduate Program .....	192

## **SECTION 6**

## CAREER DEVELOPMENT CENTER

The Career Development Center (CDC) at WPI is here to assist students in the development of life-long skills related to careers and the job search process. CDC serves not only undergraduate students but graduate students and alumni as well. Information and guidance is provided in the areas of full-time employment, graduate school, part-time employment, cooperative education and summer positions.

The Career Development Center (CDC) provides a variety of services to students including the following:

1. **INDIVIDUAL CAREER COUNSELING** – Students can arrange to meet a Career Counselor by appointment or during walk-in hours. Help is provided in many areas including assistance with major selection, making career choices, resumes, devising a job search plan, interviewing and applying to graduate school.
2. **CAREER RESOURCE CENTER** – CDC maintains literature and information about various companies that recruit on campus so that students will be well prepared for their interviews and have a reasonably good idea whether they would be interested in a particular company. CDC also provides vocational resources for students researching and exploring various careers. For those students considering graduate school, the center provides information of graduate education at WPI and elsewhere. The center also houses information on standard examinations required by many graduate schools such as the Graduate Record Exam (GRE), Graduate Management Admission Test (GMAT), Medical College Admission Test (MCAT), and Law School Admission Test (LSAT).
3. **CAREER FAIRS** – Each year the CDC organizes job fairs for students to obtain information of full-time, part-time, summer and co-op opportunities.
4. **CAREER WORKSHOPS** – Throughout the year a variety of workshops are offered to students. Topics have included: Resume/Cover Letters, Job Search Strategies, Summer Job Search, Job Offer Decision Making, and Applying to Graduate School.
5. **COMPANY PRESENTATIONS** – Information sessions are provided by recruiters so that students have an opportunity to evaluate and learn more about the companies interviewing on campus.
6. **JOB LISTINGS** – The CDC posts full-time, part-time, summer and co-op opportunities. Students and alumni can access job listings through the CDC's web-based system.

7. **ON-CAMPUS INTERVIEWS** – Annually the CDC brings companies to campus to interview students. Over 200 private, government, civic and professional companies and organizations have participated in this program. Employers interview for summer, co-op or full-time employment. To give you an idea, here are a few organizations which have employed WPI graduates in recent year:

- Analog Devices
- BAE Systems
- General Dynamics-Electric Boat
- General Electric
- IBM
- Kiewit Construction
- MIT Lincoln Lab
- National Grid
- Naval Undersea Warfare Center
- Pratt & Whitney
- Raytheon
- Teradyne

8. **RESUME REFERRAL** – Students can house their resume in the CDC's web-based system. Employers can access students' resumes in two ways, a web resume book or referrals by the CDC for specific positions.

9. **ALUMNI ASSISTANCE** – After students graduate from WPI, the CDC provides assistance to alums seeking new employment or facing a change in career goals.

**LOCATION:** The Career Development Center is located in the Lower Level of the Project Center. The phone number is 508-831-5260. The website is [www.wpi.edu/+CDC](http://www.wpi.edu/+CDC)

## GRADUATE STUDIES

Many students enroll in graduate school on a full- or part-time basis, realizing that a graduate degree can open the door to job opportunities such as advanced research or development, college teaching, upper level management, law or medicine. Graduate study is another step in the self-learning process begun at WPI, a process that will last a lifetime.

Most graduate schools require applicants to take a standard examination such as the Graduate Record Examination (GRE) or Graduate Management Admission (GMAT). Information on such examinations is available from the Office of Graduate Studies & Enrollment or CDC.

The Office of Graduate Studies and Enrollment and the Career Development Center (CDC) can provide information on graduate education at WPI or elsewhere.

---

## INTRODUCTION

For students who wish to continue their education after receiving the bachelor's degree in the same or a related field, the WPI graduate program offers the opportunity either to specialize or to broaden one's preparation. The M.S. degree is typically a 30-36 credit program. Many programs include options for thesis or directed research. Several graduate departments offer the Master of Engineering, a non-thesis option to the M.S. degree. The M.B.A. degree provides preparation for careers in the management of technological enterprises. In addition to master's programs, graduate-level certificates are offered by select departments.

Graduate study represents a natural extension of education beyond the WPI undergraduate Plan. With proper planning, WPI students may shorten the time required to earn the master's degree as described in the "Combined Bachelor's/Master's Program" section, page 178.

The Ph.D. represents recognized original and independent professional work in the form of research for a dissertation and peer-recognized competence in the technical aspects of the profession.

---

## ADMISSION

Admission decisions to a graduate program of any department is made by the faculty of that department with a formal letter issued by the Office of Graduate Studies & Enrollment. Students generally may enroll in a maximum of two to four graduate courses without formal admission to a degree program. Because numerous exceptions to this rule do exist, students are asked to check with their specific program head and the graduate catalog for exceptions to this rule.

Prospective students who desire an advanced degree should contact the Graduate Studies and Enrollment Office specifying the department in which they intend to do their major work. In general, a complete application, transcripts of all college work, and three letters of recommendation are needed for admission to a graduate program. The Graduate Record Examination (GRE) is required in some programs and, for others, is highly recommended; for all Management programs, the GMAT is required. The required \$70 application fee is waived for WPI alumni and current undergraduate students.

---

## REGISTRATION AND TUITION PAYMENT

Registration for graduate courses opens several months in advance of the start of each semester. Students are encouraged to register early in the cycle.

Tuition for courses taken by graduate students is \$1,042 per credit hour for the year 2007-2008. (Undergraduate courses listed as "one-third unit" are equivalent to three credit hours.)

Tuition and fees (including health insurance) must be paid before the start of classes.

---

## COMBINED B.S./M.S. PROGRAM

For description, see page 178.

---

## FINANCIAL AID

### GRADUATE ASSISTANTSHIPS

Assistantships are of two types-teaching and research. Generally, teaching assistants are assigned duties supporting faculty in the grading of papers and the supervision of laboratory sections. Research assistants usually are involved in sponsored-research projects that become a part of their theses or dissertations.

Financial assistance is available for full-time graduate students. This assistance typically includes tuition and a monthly stipend. For details, go to the graduate catalog on-line at [www.wpi.edu/Pubs/Catalogs/Grad/](http://www.wpi.edu/Pubs/Catalogs/Grad/).

### FELLOWSHIPS

Several fellowships are available for students in particular departments and through endowed funds.

The Backlin Fund, administered by the Associate Provost for Academic Affairs provides assistance for students nearing completion of their degree requirements who are recommended by a faculty member and their department chairman.

Competition for the prestigious Goddard Research Fellowship is open to U. S. citizens. Preference is given to doctoral candidates.

Information is available online at <http://www.grad.wpi.edu/Financial/fellowships.html> or by contacting the Graduate Studies and Enrollment Office.

### APPLICATION DEADLINES

Although applications for financial aid are considered at any time, the major distribution of aid is based upon complete admission applications submitted by February 1 for the fall semester. For further information on the above programs, please contact the Graduate Admissions Office.

### LOANS

Additional assistance in the form of federal and private student loan funds is available to graduate students through the Office of Financial Aid. In order to apply for these loans, students need to complete the FAFSA and Graduate Studies and Enrollment Office. For information on these forms, please visit the Office of Financial Aid website at <http://www.wpi.edu/Admin/FA/Grad/>.

---

## GRADUATE DEGREES AND REQUIREMENTS

WPI offers master's degrees in applied math, applied statistics, biology and biotechnology, biomedical sciences, chemistry and biochemistry, computer and communications networks, computer science, management, mathematics for educators, and physics, biomedical/clinical, chemical, civil and environmental, electrical and computer, financial math, industrial math, fire protection, interdisciplinary studies, manufacturing, materials science, and mechanical engineering.

The doctorate is offered in biotechnology, computer science, chemistry, physics, materials science and engineering, mathematical sciences, and in biomedical/clinical, chemical, civil and environmental, electrical and computer, manufacturing, mechanical engineering, and fire protection.

Further information and specific requirements for these advanced degrees may be found in the Graduate Catalog.

---

## PART-TIME GRADUATE PROGRAM

---

The part-time graduate programs provides the opportunity to engage in part-time study leading to the master's degree. The evening program is operated by WPI to serve the educational needs of technical and management professionals in central New England.

Master of science degrees for part-time students are offered in applied math, applied statistics, chemistry and biochemistry, computer and communications networks, computer science, financial math, industrial math, marketing and technological innovation, manufacturing management, and physics, biomedical/clinical, civil and environmental, electrical and computer, fire protection, manufacturing, materials science, and mechanical engineering. The master of engineering for part-time students is offered in biomedical, civil and environmental engineering. The master of business administration (M.B.A.) is also offered.

Although the number of courses in each discipline may be limited in any given year, the schedule of courses is such that students taking two courses per semester are generally able to complete the course requirements for the master of science or master of engineering degree in about three years or the M.B.A. in four years.

Students may enroll in individual evening graduate courses without being admitted to a graduate degree program. Those who wish to obtain a degree must apply for formal admission prior to completing two to four courses. Exceptions to the rule exist, therefore, interested students should verify the actual number of courses allowed prior to matriculation with the specific program department. Graduate-level certificate programs are also available in some departments (see Graduate Catalog for details).

A more detailed description of the program and specific course offerings is available in the Graduate Catalog. Questions relating to the program should be referred to the discipline department heads or to the Office of Graduate Studies & Enrollment.

---

## FIVE YEAR PROGRAMS

---

WPI offers unique five year programs in Fire Protection Engineering, Industrial Mathematics and Financial Mathematics. Each program begins with admission to the freshman year at WPI and ends with both a bachelors and masters degree. The master's degree is limited to one of these three programs.

High school students interested in any one of these programs must apply for admission to WPI and indicate on the application which of the 5-year programs they would like. Applicants accepted to the program will receive a letter of admission to both the undergraduate and graduate program at WPI. During the first four years, it is highly recommended that students major in a field closely related to the graduate degree program. For example, most students choosing the Fire Protection Engineering program will have an undergraduate major in Mechanical or Civil Engineering. An academic advisor will assist students in course selection. Admission to the fifth/graduate year is conditional on completion of an undergraduate degree at

WPI and in good academic standing.

Particulars about each of the programs are available in the department of Mathematics and Fire Protection Engineering, as well as the Office of Graduate Studies & Enrollment.

---

## OFF-CAMPUS GRADUATE STUDY

---

In response to the changing needs of technical professional people, WPI offers a growing number of graduate courses at the Westborough and Waltham campus. Off-campus graduate courses can be used in fulfilling degree requirements and residence requirements at WPI.

---

## GRADUATE COURSE LISTINGS

---

Graduate courses of interest to undergraduate students are listed by title in the "Course Descriptions" section of this catalog. A complete list is included in the graduate catalog. Most courses meet once per week in a fourteen-week format. The credits applied in either case are as shown to the right of the course title. Undergraduate students taking graduate courses may use the conversion factor: 3 credit hours = 1/3 unit. Registration for research or projects is accomplished using an individual program number rather than a course designation.

For more information about WPI's Graduate Programs, please contact:

Office of Graduate Studies & Enrollment

Voice: 508-831-5301

Fax: 508-831-5717

[gse@wpi.edu](mailto:gse@wpi.edu)

[www.grad.wpi.edu](http://www.grad.wpi.edu)

The complete Graduate Catalog and application form are available on-line through our website.

---

## SCHOLARSHIPS AND GRANTS FOR GRADUATE STUDY ABROAD

---

### RHODES SCHOLARSHIPS

Rhodes Scholarships, covering tuition, fees and a stipend for two years of study in selected fields of science and engineering at Oxford University, are assigned through state and regional competitions. Students interested in applying for the Rhodes Scholarships should begin to assemble documentation during the junior year. Applicants should have achieved academic standing sufficiently advanced to assure completion of a bachelor's degree before their projected matriculation at Oxford.

For information, see Prof. Peter Hansen, 39 Dean St., Room 254.

### FULBRIGHT GRANTS

A wide variety of grants for graduate study abroad, usually for research toward the doctorate, is available through the federally-funded Fulbright Grants Program. Contact the Office of Graduate Studies & Enrollment for more information.

# ADMISSION, EXPENSES, FINANCIAL AID AND HOUSING

## **SECTION 7**

Admission to WPI.....	195
Expenses .....	198
Financial Aid.....	200
Housing .....	204

## INTRODUCTION

Selection for admission to the college is based upon such factors as candidates' secondary school record; recommendations by counselors and teachers; standardized test scores; out-of-class activities; work experience; and leadership endeavors. All candidates are invited to submit any supplementary material which they believe will aid the Admissions Committee in evaluating their application.

## VISITING THE CAMPUS

Through research and reading, you can learn a lot about a college. But the best way to determine if WPI is a good match for you is by visiting the campus. Group Information Sessions, Campus Tours, and Open Houses are the very best ways to get to know WPI.

The Group Sessions, for which no appointment is needed, are held Monday-Friday at 10:00 a.m., and 2:00 p.m. in the Admissions Office and are followed by a tour of the campus. Group Sessions are also available on selected Saturdays. Please call the Admissions Office for specific dates and times. WPI also sponsors several Open Houses throughout the fall and spring. Campus tours, presentations by academic departments, and sessions on such topics as placement, financial aid and admissions are highlights. All students on our mailing list will receive an invitation to our Open Houses and should register in advance to attend.

Student-led tours of the campus are offered Monday through Friday at 9:00 a.m., 11:00 a.m., 1:00 p.m. and 3:00 p.m. (although tours run on a limited schedule during WPI's term breaks and in the summer). Lunch with a WPI student is also available from 12:00-1:00 p.m., Monday through Friday, while classes are in session. In addition, we will try to accommodate any requests to sit in on classes, meet privately with a faculty member or shadow a current student. A personal interview is one of the best ways to learn more about WPI. It also gives us the opportunity to learn more about you. Interviews are available on campus by appointment only. We schedule interviews year round, with the exception of March. If you would like to schedule a time to meet with one of our Admissions Office members, please contact the office directly. Whatever option you choose, you can arrange for a campus visit by calling the Admissions Office at (508) 831-5286, and our receptionist will be happy to assist you.

## QUALIFICATIONS

In order to qualify for admission, candidates must have completed a full secondary school course of study including the following secondary school units:

ENGLISH	4	
MATHEMATICS	4	(including pre-calculus)
LAB SCIENCES	2	

Completion of the required mathematics and science courses in less than four years of study may qualify a student for early admission.

## APPLYING TO WPI

Although the vast majority of entering freshmen matriculate in September, WPI does admit freshmen in January. Candidates for the September term should file their application by February 1. Freshman candidates for admission to the January term should file their applications by November 15.

In our efforts to make applying to WPI as easy as possible, we offer a variety of application options. You can use the traditional paper application form or you can apply on-line via [admissions.wpi.edu](http://admissions.wpi.edu). The \$60 application fee is required for all applicants. We also accept the paper and on-line versions of the Common Application and the University Application. For more information on these options, please call the Office of Admissions at (508) 831-5286.

## STANDARDIZED TESTS

Freshmen candidates, who wish for their test scores to be considered for admission must register to take the SAT I **OR** the ACT prior to the application deadline chosen. Candidates may also submit alternative materials through WPI's Flex Path option in lieu of test scores. Those who choose WPI's Flex Path may submit alternative materials that they believe will better reflect their potential for success at WPI and are encouraged to submit examples of academic work or extracurricular projects that reflect a high level of organization, motivation, creativity and problem-solving ability.

Candidates who wish to have their test scores considered should arrange to have their scores submitted directly to WPI by either the College Board or ACT. The WPI code number is 3969 for the College Board tests and 1942 for the ACT test.

## FINANCIAL AID

Students applying for financial aid should check the appropriate box on the application for admission. Financial aid candidates should submit the College Scholarship Service (CSS) PROFILE Application and the Free Application for Federal Student Aid (FAFSA), which are available online at [www.collegeboard.com](http://www.collegeboard.com) and [www.fafsa.ed.gov](http://www.fafsa.ed.gov). For regular admission applicants, these forms should reach the WPI Office of Financial Aid by February 1. Students applying for Early Action should submit the completed PROFILE to the College Scholarship Service beginning November 15. All financial aid candidates are required to send directly to our office, signed copies of their own and their parents' Federal Income Tax Returns and W-2 Forms from the prior year. Financial Aid is available for U.S. citizens and/or permanent residents of the U.S. A limited amount of need-based financial aid is available for International Students which is administered through the WPI Admissions Office. In order to apply for need based assistance, international students need to complete the College Scholarship Service (CSS) PROFILE Application ([www.collegeboard.com](http://www.collegeboard.com)) or the Foreign Student Financial Aid Application which may be obtained in the WPI Admissions Office or online at [wpi.edu/Admin/FA/International/](http://wpi.edu/Admin/FA/International/).

## APPLICATION FEE

A \$60 application fee is required for all applicants. WPI endorses the fee waiver policy of the College Entrance Examination Board.

## NOTIFICATION

All candidates for admission will receive an acknowledgment of the receipt of their application. Should applicants fail to receive this acknowledgment within four weeks, they are encouraged to check with their high school guidance office or the Office of Admissions at WPI. Admissions decisions will be mailed to all applicants no later than April 1.



**DECISION TO MATRICULATE**

Accepted candidates must inform the college by May 1, the candidates' common reply date, of their decision to matriculate by returning a \$500 non-refundable tuition deposit along with the Acceptance of Admission Form.

**EARLY ACTION**

Students may apply to WPI early and receive early notification of their admissions decision under the Early Action plan. The plan is as follows:

1. Candidates should check the early action box on the application.
2. The completed application for admission must be submitted by November 15 for Round 1, or by January 1 for Round 2.
3. The Admissions Committee will review all early action applications and notify all candidates of their decisions by December 15 for Round 1 or by February 1 for Round 2. Early action is a non-binding admissions plan. Accepted students have until May 1 to submit a \$500 non-refundable tuition deposit.
4. Admitted early action candidates who are applying for financial aid will receive notification regarding eligibility for aid soon after their financial aid forms are submitted and complete.

**ADVANCED PLACEMENT**

WPI awards credit to students who score a score a "4" or "5" on the Advanced Placement Examinations. The Director of Academic Advising will notify such students of their earned credit by mailing an AP letter to the home address during early August. You can visit the Academic Advising web site for a complete list of AP credits for exams taken or call 508-831-5381.

**Humanities**

For students who do take the examination in one or more of the WPI humanities areas and score a "4" or "5," the university will award advanced placement credit for one course per examination toward the humanities requirement. Soon after arriving on campus, students receiving such credit must speak with an appropriate humanities department advisor about how this credit may be integrated into a thematic program of studies leading to fulfillment of the WPI humanities requirement.

**Computer Science**

Advanced placement in computer science can be earned by scoring a "4" or "5" on the CS exam. Credit for CS 1000 is granted for the A computer science exam; credit for an additional 1000-level course is granted for a score of "4" or "5" on the AB exam.

**Natural Sciences**

Students who pass the advanced placement test in Biology or Physics B with a "4 or 5" will be awarded 1/3 unit of advanced placement credit. This credit will show on the transcript as "L". For students who score "4 or 5" in Physics C (Mechanics) will be awarded 1/3 credit in Physics 1110/ 1111. Students who score "4 or 5" in Physics C (Electricity and Magnetism) will be awarded 1/3 advanced placement credit for Physics 1120/1121. For those students who pass Physics B will be awarded 1/3

credit in Physics 1000. Students who score "4" or "5" in Chemistry will be awarded 1/3 unit for CH 1010. In addition, students are eligible to earn credit for other general chemistry courses, CH 1020-1040, by achieving scores of 70 or better on course-specific examinations offered by the Department of Chemistry and Biochemistry. General Chemistry Credit exams will be given before the start of each term. Please contact the Chemistry Department at 508-831-5371 for information on when the exams will be offered. Note this policy applies only to WPI students.

**Mathematics**

Students who pass the AB mathematics examination with a "4" or "5" will be awarded 2/3 unit of advanced placement credit for MA 1021 and MA 1022. Students with a "4" or "5" on the advanced placement BC exam will be awarded 1 unit advanced placement credit for MA 1021, MA 1022 and MA 1023.

In the four-course 1021-1024 mathematics sequence, students who arrive at WPI with a one-year high school calculus course, prepared to start with the second (or third) course in the WPI sequence, and who successfully pass that course and the one that follows it in sequence, will be considered to have established advanced placement credit for the first one (or two) courses. To qualify for the credit, the advanced WPI courses must be passed the first time in sequence in A- and B-term of the student's first year. The courses credited retroactively will be listed by number without an assigned grade and will count toward the distribution requirement in mathematics.

Transfer students are not eligible to obtain math credit under this policy.

**NEW STUDENT ORIENTATION**

During the week prior to classes, the Campus Center and Student Activities Department coordinates a comprehensive new student orientation program for all first-year and transfer students. New student orientation provides an introduction to the WPI experience, ranging from academic work and expectations and project-based education, to student life and campus activities. Led by upperclass student team leaders and faculty advisors, new students to WPI attend team meetings that are designed to familiarize them with the overall campus environment.

**READMISSION**

Students who were formerly at WPI but left before completing undergraduate study, and now wish to apply for readmission, should contact the Registrar's Office for information and forms. Completed readmission forms must be received by WPI no later than the following due dates in order to be acted upon for entrance in the indicated term:

July 15 for Term A                      November 15 for Term C

If possible, candidates should also plan on an interview with the Director of Academic Advising and with a departmental consultant in their intended major area of study prior to filing the readmission form.

**TRANSFER STUDENTS**

The WPI Plan provides some advantages that are particularly attractive for transfer students. Transfer applicants should furnish official transcript(s), an autobiographical statement and Math/Science teacher recommendations in addition to the application for admission. The priority deadline for receipt of priority applications for entrance in September is April 15. The deadline for admission for January entrance is November 15. Applicants are encouraged to submit their applications as early as possible.

All transfer students are required to spend at least two years as full-time registered students. For more details on transfer admission, see [admissions.wpi.edu](http://admissions.wpi.edu).

**TRANSFER AGREEMENT**

WPI currently holds formal articulation agreements with specified programs of study at Bristol Community College, Mass Bay Community College, and Quinsigamond Community College. However, WPI will grant appropriate transfer credit on a case-by-case basis from any properly-accredited two-year or four-year institution.

**HUMANITIES AND ARTS REQUIREMENT FOR TRANSFER STUDENTS**

All transfer students should review their humanities and arts record and plan with the Humanities and Arts Department's coordinator for transfer students (J. Hanlan - SL23), who will determine for students the transfer credit applicable towards the Humanities and Arts Requirement.

All transfer students entering WPI with fewer than two units of humanities and arts credit must complete thematically related work in humanities and arts at WPI, including an inquiry seminar or practicum to the extent that the overall humanities and arts credit totals two units. The humanities and arts requirement is considered fulfilled for transfer students who have completed the equivalent of two units of humanities and arts work prior to their matriculation at WPI.

A Completion of Degree Requirement form must be submitted once the Humanities and Arts degree requirement has been satisfied.

Transfer students who have satisfied the Humanities and Arts degree requirement based on work completed at another school and who submit the Completion of Degree Requirement form as part of the transfer-credit posting process will have the Completion of Degree Requirement form and grade recorded without a fee. This process will normally take place prior to or during the first term of full-time enrollment at WPI.

**INTERNATIONAL STUDENTS**

The presence of international students serves as a means of strengthening the knowledge and understanding of foreign countries and cultures and is highly encouraged and supported at WPI. Programs and support services for international students and exchange programs are given high priority. As an institution of higher learning, WPI is dedicated to international education.

In addition to the standardized tests listed above, international applicants must provide proof of English language proficiency. English language proficiency may be demonstrated by the official results of:

- TOEFL (Test of English as a Second Language)-Minimum score: 550 (213 electronic form or 79 internet based)
- IELTS (International English Language Testing System) 6.5 or higher with no band below 6.0.

International students whose score results are less than those above may still be conditionally admitted, with required attendance at WPI's English as a Second Language Program during the summer prior to enrollment.

**THE ENGLISH AS A SECOND LANGUAGE (ESL) PROGRAM**

The ESL Summer Institute is an intensive five-week non-credit course of study in English for specific purposes for conditionally-admitted international students and others whose first language is not English. This ESL program is designed to help prepare these international students for regular courses in engineering, science and technology before the regular academic year begins. A second intake is available for international students who desire only a head-start in preparation for such courses before the academic year begins.

For students who need additional support during the regular academic year, the ESL Seminar, a tutorial course designed to help the student further strengthen linguistic skills, is offered.

During the regular academic year, ESL for Spouses is a non-credit course offered to interested partners accompanying WPI students and professors.

**ESTIMATED EXPENSES**

The expenses for a year at WPI will vary with each student. Expenses for the 2007-08 year are as follows:

Tuition	\$34,000
Social Fee	250
Health Fee	280
Total Tuition and Fees	\$34,830
Room (Typical Freshman Double)	6,104
Board (7-Day, 19-Meal Plan)	4,564
Books and Supplies (Estimated)	1,000
New Student Fee	200
	\$46,698

Health insurance is required for all students. If coverage is not through a parental plan, student health insurance is available at a projected cost of \$940 for the 2007-08 academic year. The health insurance plan is mandatory for international students.

Basic tuition entitles full-time students to full academic and student services including counseling, placement and recreational facilities. Other costs must be anticipated, such as laundry, clothing, travel expenses, entertainment and personal expenses.

**SPECIAL STUDENT**

1/3 unit	\$2,856
1/6 unit	\$1,428
1/12 unit	\$ 714

**PAYMENT OF TUITION DEPOSIT****ENTERING STUDENTS**

Payment of a nonrefundable \$500 deposit is required upon acceptance of admission to WPI. The \$500 will be credited as follows: \$250 to the student's tuition in the first term and \$250 toward the bill for housing. If housing is not needed, then the full \$500 is credited to the tuition bill for the first term.

Information about deferred tuition payment plans offered by commercial firms is available from the WPI Accounting Office.

**ENROLLMENT AND TUITION DUE DATES**

Enrollment for students pursuing a baccalaureate degree will occur three times per year:

1. Fall semester-at the beginning of Term A.
2. Spring semester-at the beginning of Term C.
3. Summer session-at the beginning of Term E.

There will be no enrollment at the start of Terms B and D, although a course change period will be available for students continuing from the previous term.

Special tuition features relative to Term E enrollment will be described in the Summer Session catalog.

Dates upon which semester tuition fees are due are listed in the WPI Chronology of Academic Schedule and Events on the inside front cover of this catalog.

**OVERLOAD CHARGES**

1. There will be a tuition surcharge on registration which contains academic overloads in excess of 2 1/6 unit per semester.
2. Neither physical education or military science will be included in the determination of overloads.
3. The overload charge will be based upon the total registration credit held by the student at the close of the initial change period each of the two terms of that semester. Students will be subject to the appropriate overload charge in effect at the time. (Please consult the Projects and Registrar's Office or the Accounting Office for current fees.)
4. Fall overload billing will take place during Term A and spring overload billing during Term C.
5. The current Term E charge system will not be affected.

**FULL-TIME STUDENTS TUITION CHARGES UPON WITHDRAWAL OR SUSPENSION**

Charges upon formal withdrawal from the college during each semester are:

	<b>Charge</b>
1. Withdrawal after enrollment but prior to first day of classes of the first term of a semester.	\$100.00
2. Withdrawal within one week following first day of classes of the above term.	20% of tuition
3. Withdrawal within two weeks following first day of classes of the above term.	40% of tuition
4. Withdrawal within three weeks following first day of classes of the above term.	60% of tuition
5. Withdrawal prior to end of course change period of the second term of a semester.	80% of tuition
6. Withdrawal after course change period of the second term of a semester.	100% of tuition

To qualify for a reduction in charges, students must submit a formal withdrawal application via the Projects and Registrar's Office. The date this application is received in the Projects and Registrar's Office will determine the charge.

**There is no reduction in charges in the case of withdrawal from individual courses.**

Students who have paid full tuition for eight semesters may be allowed to enroll as special (part-time) students on a per-course basis and be charged tuition accordingly. (Two summer terms enrolled as a full-time student may be counted as a semester.) Application forms for Special Student status are available at the Projects and Registrar's Office.

A late fee ranging from \$25 to \$50 is assessed for payment of bills after the specified dates.

---

## SPECIAL (SU, SX) STUDENTS TUITION CHARGES UPON WITHDRAWAL

---

During the regular academic year (Terms A, B, C and D), withdrawal will result in charges being reduced in the following manner for special students in seven-week courses:

	<b>Charge</b>
1. Withdrawal before the third scheduled class.	\$25.00
2. Withdrawal after the third class but during the first week of class.	25% of tuition
3. Withdrawal during the second week of class.	50% of tuition
4. Withdrawal during the third week of class.	75% of tuition
5. Withdrawal after the third week of class.	100% of tuition

Withdrawal of SU and SX students from 14-week courses will follow the current policies of the Projects and Registrar's Office.

---

## ROOM CHARGES UPON WITHDRAWAL OR SUSPENSION

---

	<b>Charge</b>
1. Withdrawal after enrollment, but prior to the first day of classes. (Forfeiture of advance payment.)	\$100.00
2. Withdrawal after the first day of classes.	100% charge of room fee

---

## BOARD CHARGES UPON WITHDRAWAL OR SUSPENSION

---

	<b>Charge</b>
1. Withdrawal after enrollment, but prior to the first day of classes.	No Charges
2. Withdrawal within four weeks following the first day of classes.	25% of board fee
3. Withdrawal within eight weeks following the first day of classes.	50% of board fee
4. Withdrawal within twelve weeks following the first day of classes.	75% of board fee
5. Withdrawal after twelve weeks following the first day of classes.	100% of board fee

---

## FINANCIAL AID UPON WITHDRAWAL/ SUSPENSION

---

Federal regulations for a student receiving federal financial aid funds require repayments to the fund from excess credit when a student withdraws or is suspended during a semester. Health insurance, health fee, and social fee are neither prorated nor refunded. Federal funds are returned in the following order based on federal guidelines: Unsubsidized Federal Stafford Loan, Subsidized Federal Stafford Loan, Perkins Loan, Federal PLUS Loan, Federal Pell Grant, and Federal Supplemental Educational Opportunity Grant. WPI scholarships and institute loans are reduced up to the amount of remaining credit sources.

WPI is committed to assisting students and their parents in finding ways to finance the cost of a WPI education through financial aid assistance and private financing options. Central to WPI's program is the concept of financial need. This concept is based on the assumption that parents and students together accept the responsibility for educational expenses to the extent they are able. Over 87% of WPI undergraduates are receiving financial help from federal, state, and institutional resources. A combination of grants, loans and/or work study assistance from federal, state and WPI funding are allocated to students who demonstrate financial need. The proportion of grant, or "gift" assistance, versus loan and work, may be determined by the college on the following criteria: the magnitude of the financial need, the student's academic performance, and the availability of funds.

## APPLICATION PROCEDURES

Students are required to file the Free Application for Federal Student Aid (FAFSA) and the CSS (College Scholarship Service) PROFILE Application. Students list WPI's school code number under the section on each form where it designates which schools are to receive the form. In addition, students and their parents are required to send to the WPI Office of Financial Aid a signed copy of their federal income tax forms (or a statement signed by the student/ parent indicating he/she will not file a return), schedules, and W-2 statements from the prior year. In the case of separation or divorce, the student's noncustodial parent must complete the Noncustodial PROFILE.

### EARLY ACTION APPLICATION FOR FINANCIAL AID

Applicants must indicate on their admission application they are applying for financial aid. For those students applying for early action admission, the CSS PROFILE Application (and Noncustodial PROFILE, if applicable) can be submitted as early as October 1st, but no later than February 1st. The FAFSA and the CSS PROFILE Application are available online at [www.fafsa.ed.gov](http://www.fafsa.ed.gov) and [www.collegeboard.com](http://www.collegeboard.com). All federal income tax return forms, as outlined above, are required as soon after January 1st as possible, as well as completion of the FAFSA. No award decision is final until all material is received and reviewed.

Successful candidates for early action admission will be notified of financial aid eligibility on a rolling basis. Applicants will then have from the date of your aid eligibility letter until the candidates' common reply date, May 1st, to either accept or decline the aid offered.

### REGULAR DECISION APPLICATION FOR FINANCIAL AID

Applicants must indicate on their admission application they are applying for financial aid. Successful candidates for admission will be notified of a financial aid decision in early April if a financial aid application has been submitted. Applicants will then have from the date of the financial aid decision until the candidates' common reply date, May 1st, to either accept or decline the aid offered.

To ensure a complete review, we must receive the FAFSA and the CSS PROFILE Application by February 1st. Applications completed after this date will be reviewed subject to available funding. The Office of Financial Aid encourages students to complete the FAFSA and the CSS PROFILE Application (and Noncustodial PROFILE, if applicable), by the beginning of January to ensure that WPI's filing deadline of February 1st is met.

### UPPERCLASS APPLICATION FOR FINANCIAL AID

Upperclass students who received need based financial aid must reapply for financial aid every year by completing the FAFSA and the WPI Financial Aid Upperclass Application. In a few cases, some upperclass students will also be required to submit the CSS PROFILE Application in addition to these requirements. Typically, upperclass students who will need to complete the CSS PROFILE Application are those whose parents are recently separated or divorced, students who are re-admitted to WPI, students whose custodial and noncustodial parents have changed since the prior academic year, and students who did not apply for need based financial aid in the prior academic year. The WPI Office of Financial Aid reserves the right to request that a CSS PROFILE Application be completed by any upperclass student applying for need based financial aid.

The WPI Upperclass Financial Aid Application will be available at the end of Term B and is due by the beginning of Term D. Filing information on the FAFSA (and CSS PROFILE Application, if necessary) as well as signed copies of student and parent federal income tax returns, including all schedules and W-2 statements, is due by April 15th. The complete application provides consideration for grants, scholarships, loans and federal on-campus employment for the following academic year. Students and their parent(s) are expected to obtain and submit all requested forms in a timely manner for each year of planned enrollment. If any of the required forms are submitted late, the student may experience a reduction in his/her grant or scholarship eligibility for the year in which he/she is applying for need based financial assistance. The amount of financial aid upperclass students receive will depend on their family's demonstrated financial need which is determined from the FAFSA, the WPI Upperclass Financial Aid Application and the CSS PROFILE Application, if required.

### WPI NEED BASED SCHOLARSHIPS/GRANTS

WPI need based scholarships and grants awarded to students will not increase in future academic years, regardless of changes in a student's financial need. Conversely, students' WPI need based scholarships and grants can decrease based on a lower financial need and/or poor academic performance (from the prior academic year). Once a student's scholarship or grant has been decreased, it will not be increased in future academic years. Because of this, it is extremely important that students monitor the number of classes they pass each academic year.

### WPI MERIT SCHOLARSHIPS

WPI merit scholarships will not increase or decrease based on changes to a student's financial need. However, a student's merit scholarship will decrease or be eliminated if a student does not meet the renewal criteria to maintain these scholarships. Students should refer to their Admissions Merit Scholarship letter for detailed information on renewal criteria for merit scholarships.

### TRANSFER STUDENTS

Transfer students may apply for financial aid eligibility beginning with their first term of matriculation, and must indicate interest in financial aid on the admission application. Transfer aid applications will be reviewed based on the same documentation required for first year applicants and are packaged on a funds available basis. The FAFSA and CSS PROFILE (and Noncustodial PROFILE, if applicable) are due by March 1st.

## FORMS OF AID

### FEDERAL PELL GRANTS

Federal Pell Grants are awarded to high need students from low and lower middle-income families. These grants range from \$400 to \$4,050 per academic year. A Student Aid Report (SAR) is sent to all students who file a Free Application for Federal Student Aid (FAFSA). The WPI Financial Aid Office will verify the data on the form, making corrections if necessary. In 2006-07, WPI administered over \$920,000 in Federal Pell Grant funds to eligible full and part time students.

### FEDERAL ACADEMIC COMPETITIVENESS GRANT (ACG)

Federal Academic Competitiveness Grants are awarded to full-time undergraduate students enrolled in an eligible program who receive a Federal Pell Grant and are U.S. citizens. Students also must have completed a rigorous secondary school program of study and be enrolled in at least a two-year academic program acceptable for full credit toward a bachelor degree program. The ACG for the first academic year is awarded up to \$750 and up to \$1,300 for the second academic year. In 2006-07, WPI administered over \$87,000 in Federal ACG funds to eligible students.

### FEDERAL NATIONAL SCIENCE AND MATHEMATICS ACCESS TO RETAIN TALENT GRANT (NATIONAL SMART GRANT)

Federal National SMART Grants are awarded to full-time undergraduate students enrolled in the third or fourth academic year of an eligible program, who receive a Federal Pell Grant, and are U.S. citizens. An eligible program in the National SMART Grant is one that leads to a bachelor's degree in an eligible major or a graduate degree program in an eligible major that includes at least three academic years of undergraduate education. The award is up to \$4,000 for each of the third and fourth academic years. In 2006-07, WPI administered over \$318,000 in Federal National SMART Grant funds to eligible students.

### FEDERAL SUPPLEMENTAL EDUCATIONAL OPPORTUNITY GRANTS (FSEOG)

Federal SEOG funds are allocated to institutions by the Federal government. These funds, which are awarded to students as campus based grants, are awarded to high need students who are also eligible for the Federal Pell Grant. WPI students received over \$813,000 in Federal SEOG funds in the 2006-07 academic year.

### FEDERAL STAFFORD STUDENT LOAN

There are two types of Federal Stafford Loans offered to students by the federal government: the Federal Subsidized Stafford Loan and the Federal Unsubsidized Stafford Loan. A student's federal financial need will determine which loan(s) he/she will be offered in the financial aid award.

Federal Subsidized Stafford Loans are loans that the federal government pays the interest on while the student is enrolled in school at least half time and during periods of grace.

Students not eligible for the Federal Subsidized Stafford Loan may borrow through the Federal Unsubsidized Stafford Loan Program. In the Unsubsidized Stafford Loan Program, the federal government does not pay the interest on this loan. Rather, the student has the option to either pay the interest or

capitalize it and postpone repayment of principal and interest until after graduation or falling below at least half time enrollment.

Repayment of both principal and interest for the subsidized and unsubsidized federal Stafford loans begins at the end of the 6 month "grace period" following the last day of enrollment or withdrawal from school. The repayment period is ten years and the interest rate is set for loans borrowed prior to July 1, 2006 at the bond equivalent rate of 91 day Treasury bills (as of the preceding June) plus 2.3%, capped at 8.25%. For loans borrowed after July 1, 2006 the interest rate is fixed at 6.8%. Approximately 3%- 4% in origination and guarantee fees may be deducted by the bank before the proceeds are disbursed to the school.

Students must file a FAFSA so that WPI can determine need-based eligibility for the Federal Stafford Loan. The Federal government sets annual borrowing limits according to the student's year in school or grade level. As of the 2007-2008 academic year, first year students may borrow up to \$3,500, second year students up to \$4,500 and third and fourth year students up to \$5,500. Students cannot borrow in excess of \$23,000 over the life of their undergraduate education.

The WPI Office of Financial Aid recommends and approves the amount a student may borrow for the subsidized and unsubsidized Federal Stafford Loan. For all new borrowers, a Master Promissory Note must be completed. This may be done electronically or on paper. Students will be notified of the availability of the note to be signed. The Master Promissory Note only needs to be signed once during the student's undergraduate time at WPI, unless you wish to change lenders or your current lender changes their fee structure. If you continue on to graduate school at WPI, you do not need to sign a new MPN. If you are a previous borrower with an out-of-state lender and you have not completed a Master Promissory Note, you must obtain and complete a Master Promissory Note from the lender you borrowed from last year and forward it to the WPI Office of Financial Aid for processing. All new WPI students (first year, transfer & graduate) must complete a Master Promissory Note at WPI.

### FEDERAL PERKINS LOAN

Federal Perkins Loans are federally subsidized loans awarded directly to students by colleges. Students are awarded based on funds available. Repayment of principal and interest, currently fixed at 5%, begins nine months after the recipient's last day of enrollment or withdrawal from college. For all new borrowers, a Master Promissory Note must be completed. The Master Promissory Note only needs to be signed once during the student's undergraduate time at WPI. In 2006-07 WPI administered over \$1.9 million in Federal Perkins Loans.

### FEDERAL WORK STUDY PROGRAM

Federal Work Study funds are allocated annually to colleges who offer federally funded work opportunities to high need financial aid applicants. Federal Work Study is included in the financial aid eligibility letter to students if they qualify for these funds. If a student accepts a Federal Work Study offer, he/she may work a maximum of 10 hours per week at the current wage of \$8.00 per hour. Federal Work Study earnings are paid by direct deposit on a bi-weekly basis directly to the student employee. Work is available in a variety of academic and administrative settings on or off campus. The off campus positions are community service positions and must be set up through the Student Activities



Office. Students who work in community service positions are paid \$8.50 per hour in order to cover travel expenses to and from their jobs. The amount of Federal Work Study funds offered in a student's award letter indicates maximum earnings allowed, but is not a guarantee. The best procedure is to take an available position at the start of the academic year and work as much as the schedule allows up to the maximum 10 hours per week. If a student declines an offer of work, it will not affect the other components of his/her award package. However, please note that due to limited funding, if a student declines Federal Work Study funding or employment, this fund will not be renewed in future academic years. In addition, if a student earns less than \$500 in Federal Work Study funds during the academic year this fund is awarded or fails to work the required hours in community service, his/her Federal Work Study funding will not be renewed in future years.

Students are prohibited from Federal Work Study employment if one of the following situations occurs: if the student falls below the WPI established satisfactory progress levels for retention of aid, the student enrolls on a less than full time basis, or the student registers as a "Special Student."

### STATE SCHOLARSHIP PROGRAMS

WPI administered over \$240,000 from the MASSGrant Program during the 2006-07 academic year. The MASSGrant is awarded to Massachusetts residents whose combined family contribution falls within state-determined parameters. Students must file the FAFSA by the state-designated deadline and follow all state program procedures to apply.

Massachusetts has reciprocity agreements with six other states: Connecticut, Maine, New Hampshire, Pennsylvania, Rhode Island and Vermont. These states allow their residents attending institutions in Massachusetts to "carry" need-based state grants into Massachusetts. Grants from all reciprocal states to WPI students last year totaled over \$110,000. Awarding from other state scholarship programs depends on annual state funding levels.

The Massachusetts Gilbert Matching Grants Program is allocated annually to WPI. These funds are awarded to Massachusetts residents who fall within a certain financial need. WPI students received over \$811,000 in the Massachusetts Gilbert Matching Grant during 2006-07.

### STATE FUNDED STUDENT LOAN PROGRAMS

The Commonwealth of Massachusetts provides the Massachusetts No Interest Loan (MA NIL) Program through annual allocations to participating colleges and universities. Students who file the FAFSA and meet state eligibility criteria are eligible for the Massachusetts No Interest Loan on a funds available basis. WPI administered \$173,000 in the MA NIL program in 2006-07.

### WPI COLLEGE SCHOLARSHIP

WPI awards College Scholarships and other restricted or endowed "gift" assistance, to students who have a demonstrated financial need based on review of the complete financial aid application, including the FAFSA, the CSS PROFILE Application (if first year applicant), IRS tax returns, W-2 forms, and the WPI Upperclass Financial Aid Application (if returning undergraduate). WPI gift aid may be combined with federal and state grants to make up a student's total portion of "gift" assistance, before loans and work are packaged. Grants and scholarships funded directly by WPI exceeded \$35 million in 2006-07.

### WPI INSTITUTE STUDENT LOAN PROGRAM

The WPI Institute Loan is an institutional need-based loan awarded to students. Repayment of the principal and interest begins 9 months after the last day of enrollment or withdrawal from college. WPI students borrowed \$1.7 million in Institute Loans during 2006-07. The Institute Loan terms and eligibility criteria are similar to the Federal Perkins Loan Program.

### WPI DEPARTMENT-FUNDED WORK PROGRAM

Students who are not eligible for Federal Work Study funds may seek employment opportunities through departments or offices on campus that set aside funds for hiring undergraduate employees. These employment funds vary from year to year in terms of monies available or the number of students allowed per department/office. Students may also inquire about department-funded summer positions on campus.

---

## FINANCIAL AID POLICIES

---

Financial aid is awarded one year at a time. Aid applicants are required to reapply annually by the beginning of Term D. An annual review of each applicant's financial need is assessed to assure that aid is renewed equitably as different circumstances cause needs to change. The WPI Office of Financial Aid determines a student's financial need through a review of the complete financial aid application and appropriate IRS forms. Financial aid eligibility letters are mailed to upperclass students in early July for the following academic year.

### STUDENT CONTRIBUTION

It is expected that the student's family will contribute its maximum financial effort and that the student will also make a maximum effort through savings from annual earnings and by accepting a proportion of financial aid in the form of loans and/or in-school employment, if eligible. Students at WPI are expected to contribute a minimum \$2,000 each academic year, from summer or other annual earnings. While this minimum student contribution is used, the WPI Office of Financial Aid must review previous calendar year student earnings and student savings/assets as the basis for determining the annual student contribution.

### INDEPENDENT/DEPENDENT STUDENT STATUS

WPI believes that the primary responsibility for an undergraduate education lies with the student and parent, to whatever extent possible. Therefore, all undergraduates applying for WPI institutional funds are required to provide parental information regardless of federal dependency status.

Although a student may meet federal guidelines to be considered an independent student, and therefore receive federal funds as an independent student, the ability of parents to assist their children, regardless of age and dependency status, is a factor WPI considers in determining eligibility for institutional need-based grants. Because of this, the WPI Office of Financial Aid will require parental information (including federal income tax returns, schedules, and W-2 statements) from all students applying for need based institutional aid.

**AID RETENTION/PROGRESS TOWARD A DEGREE**

There are four key elements to the retention of eligibility for financial aid as it relates to academics:

1. All full time students are expected to register and enroll in twelve 1/3 unit classes per academic year. The more classes a student successfully completes (up to a maximum of 12 courses during terms A-D, the more the student's grant/scholarship eligibility is maintained for the next academic year.

Attempting but not successfully completing courses and project work will reduce financial aid. Please note that advanced placement, transfer credit, incompletes, or extensions cannot be counted in the determination of units completed. The student is responsible for resolution of incompletes with the faculty member assigning the grade.

**WPI Financial Need Scholarships/Grants**

WPI scholarships and grants awarded to students will not increase in future academic years; regardless of changes in a student's financial need. Conversely, students' WPI need based scholarships and grants can decrease based on a lower financial need and/or poor academic performance (from the prior academic year). Once a student's scholarship or grant has been decreased, it will not be increased in future academic years. Because of this, it is extremely important that students monitor the number of classes they pass each academic year.

**WPI Merit Scholarships**

WPI merit scholarships will not increase or decrease based on changes to a student's financial need. However, a student's merit scholarship will decrease or be eliminated if a student does not meet the renewal criteria to maintain these scholarships. Please refer to your Admissions Merit Scholarship letter for detailed information on renewal criteria for merit scholarships.

2. Eligibility for consideration for all types of financial aid for the following academic year is lost if a student is placed on Academic Probation (end of B or D term).

**Financial Aid Petitions**

Students placed on Academic Probation may, in cases which involve unusual and extenuating circumstances such as documented medical problems, file a financial aid petition with the WPI Office of Financial Aid\*. The petition will be reviewed by the Financial Aid Appeals Committee which is comprised of academic administrators, not members of the Office of Financial Aid. Determination on financial aid petitions will be made on a case by case basis.

\*Financial Aid Petitions can be obtained in the WPI Office of Financial Aid (2nd floor Bartlett Center) or online at [www.wpi.edu/Admin/FA/Returning/forms.html](http://www.wpi.edu/Admin/FA/Returning/forms.html)

3. Regardless of academic progress status, eligibility for financial assistance (with the exception of the Federal Stafford Loan) is available for the shorter of the two following periods; 16 terms (4 years) of enrollment at WPI\*\*or completion of your Bachelor Degree requirements at WPI.

\*\*16 terms (4 years) of enrollment, NOT 16 terms (4 years) of receiving financial aid.

4. If students receive scholarships/grants, loans of all forms and/or federal work study, they must be registered as a full-time. Students are charged tuition and fees based upon full-time status and that serves as the basis for annual financial aid eligibility determinations.

Students are responsible for knowing their enrollment and academic status and working with an academic advisor to register and enroll for the necessary units to maintain eligibility for financial aid.

PLEASE NOTE: With the exception of the Federal Stafford Loan, financial aid is not available for enrollment during term E (Summer School) at WPI. This includes all forms of assistance including WPI Merit Scholarships. If you enroll during term E and borrow a Federal Stafford Loan, the amount you borrow will be reduced from your Federal Stafford Loan eligibility for the next academic year (terms A-D).

**GRADUATE**

The Federal Stafford Loan is the only source of need based aid administered by the WPI Office of Financial Aid to graduate students. To apply for this loan, graduate students must complete the FAFSA ([www.fafsa.ed.gov](http://www.fafsa.ed.gov)) and a Graduate Student Application which can be obtained at <http://www.wpi.edu/Admin/FA/Grad/gsa.html>.

**INTERNATIONAL STUDENTS**

International students (who do not have official documentation of Permanent Residence in the United States) are ineligible for all sources of financial aid administered by the WPI Office of Financial Aid. Limited scholarships are available for entering international students through the WPI Admissions Office.

**ALTERNATIVE FINANCIAL PROGRAMS****ALTERNATIVE FINANCIAL PROGRAMS**

Alternate financing programs are available to many families who do not apply for aid or who need additional resources beyond federal, state, and institutional financial aid offered. Several payment plans are available, which allow families to pay their annual charges over several months, rather than in two semester payments. Students and parents are encouraged to contact the WPI Accounting Office for further information about payment plan brochures and applications.

There are many long-term financing programs available to assist families in spreading their educational costs over 10 to 20 years. Many of these loans allow families to borrow the difference between the cost of attendance determined by the college and total financial aid received for the academic year. Please contact the WPI Office of Financial Aid or visit <http://www.wpi.edu/Admin/FA/First/fylinks.html> for additional information on available financing options.

**FEDERAL PLUS LOANS**

Federal PLUS Loans are available annually to parents of dependent undergraduates. Repayment begins when the funds are advanced (with the option to defer repayment until after the student graduates or falls below half time enrollment status, depending on the lender), and parents have 10 years to repay. As of July 1, 2006 the interest rate is fixed at 8.5%. Parents should apply for the PLUS loan online at American Student Assistance ([www.amsa.com](http://www.amsa.com)). The parent can choose a lender and electronically sign their Master Promissory Note. The process requires approximately four to five weeks to complete before funds are disbursed to the school for payment.

Graduate Students who need funding beyond the Federal Subsidized and Unsubsidized Stafford Loans may borrow the additional funds under the Graduate PLUS Loan Programs. While the program is very similar to the Parent PLUS Loan program outlined above, there are some differences. Graduate students borrowing under the Graduate PLUS Loan are required to complete a FAFSA and must apply for the Subsidized Stafford Loan before applying for the PLUS Loan. Principal and interest are deferred until the student graduates, withdraws or fall below half-time enrollment. Interest will accrue during the deferment period. Graduate student can apply for the Graduate PLUS Loan online at American Student Assistance (amsa.com). The student can chose a lender and electronically sign their Master Promissory Note. The process requires approximately four to five weeks to complete before funds are disbursed to the school for payment.

## RESERVE OFFICER TRAINING CORPS (ROTC) SCHOLARSHIPS

### ARMY ROTC SCHOLARSHIP PROGRAM

For information on Army ROTC Scholarships, please contact the Army ROTC office at WPI at (508) 831-5268.

### NAVAL ROTC SCHOLARSHIP PROGRAM

For information on Navy ROTC Scholarships, please contact the Naval ROTC Unit at Holy Cross College in Worcester, MA at (508) 832-2433.

### AIR FORCE ROTC SCHOLARSHIP PROGRAM

For information on Air Force ROTC Scholarships, please contact the WPI Department of Aerospace Studies at WPI at (508) 831-5747.

# HOUSING

## RESIDENCE HALLS

WPI provides its undergraduate students with a variety of housing options, both on and off campus. The WPI residence halls offer students a choice of single, double, and triple occupancy rooms as well as suites designed for four and six persons, and two- to seven- person apartments. In addition, WPI owns and staffs four houses located just a short walk from the campus. Off-campus housing alternatives include rooms in homes, apartments, fraternity/sorority living, and commuting from home.

Residence hall living at WPI offers opportunities that can be a valuable part of higher education. For this reason, on-campus housing is guaranteed to all first-year students who request it by June 1 as stated in their admission letter. First-year students admitted for Term A are guaranteed housing in the residence halls for that entire academic year.

Upperclass students may apply for those residence hall spaces not reserved for incoming first-year students. The Housing and Food Service Contract is a legally binding contract which extends from the beginning of Term A through Term D as long as the student is enrolled at WPI.

### RESIDENCE HALL STAFF

Resident Advisors (RAs) are the core of the residential life staff in the residence halls. RAs serve as a source of assistance in resolving students' academic, personal, and social concerns. They plan and implement social and educational programs in the halls, and enforce all WPI policies and regulations in an effort to develop an effective living-learning environment in the residence halls.

The administrative responsibility for the operation of the residence halls rests with the professional staff in Residential Services. They counsel and advise students, work with maintenance and dining hall staffs, and handle many administrative processes for students living on campus.

## OCCUPANCY

Residence halls normally open at 9:00 a.m. four days before Term A begins and close at 12:00 noon on the day following the last day of classes for Term D. Housing and food service privileges are not transferable, nor may any person take up de facto residence without paying rent. The residence halls will be closed during the December recess period.

## FURNISHINGS AND FACILITIES

Students are responsible for the neatness and cleanliness of their rooms. Residence halls are furnished with a twin-size bed, a desk and chair, closet space, and drawer space for each student. All residence halls are smoke free environments and all buildings have complete sprinkler systems in all student bedrooms and common areas. Data network services, telephone, and cable television are included in room rates. Residents provide their own pillows, linens, blankets, and other personal furnishings. Coin-operated laundry facilities are available at four locations on the campus.

The following are not permitted in the residence halls:

- Sale, use or possession of illegal drugs
- Pets, except small fish
- Refrigerators larger than 4.3 cubic feet in size
- Gambling
- Use of alcoholic beverages in violation of Massachusetts State Laws
- Firearms, weapons, explosives, incendiary or toxic chemicals, starting pistols, paint ball guns
- Cooking, except in kitchen areas provided
- Candles or other flame-emitting devices
- Smoking

Mail and express packages should be addressed to the student by name, and box number, WPI, 100 Institute Road, Worcester, MA 01609-2280.

**ROOMMATES**

One of the most memorable aspects of campus life can be the relationship you will build with your roommate(s). Roommates often find that a meaningful relationship is developed through the sharing of thoughts and feelings; in other words, communication. We encourage you to be as open as possible so that you and your roommate can begin early to create a relationship based on respect and understanding. This relationship can help make residence hall living one of the most enjoyable part of your college career.

**ROOM CHARGES**

Since room and board rates for 2008-2009 were not established at the time of this publication, they will be announced separately.

**Room Rates for 2007-08**

*(Note: Room rates listed are for the entire academic year)*

Standard Double, Triple, Quad . . . . .	\$ 6,104
Standard Single . . . . .	\$ 6,458

**Founders**

Double . . . . .	\$ 6,240
Single . . . . .	\$ 6,650

**Ellsworth/Fuller**

2 person . . . . .	\$ 6,402
3 person . . . . .	\$ 6,070
5 person . . . . .	\$ 5,768
7 person . . . . .	\$ 5,226

Note: Each apartment is equipped with basic furnishings including stove and refrigerator.

Payment for housing and food service fees are made in two installments, one each at the beginning of Terms A and C. Reduced charges, if applicable, will be processed according to the established withdrawal policy of the college. Students entering the residence halls other than at the beginning of Term A or C will be issued a prorated billing for the period. This bill must be paid in full prior to occupancy.

As part of the room charges for the first term of residency, the student is assessed a \$150 damage deposit. Students are expected to care for the physical facilities of the residence halls. Damage to the facilities beyond the normal wear and tear shall be the financial responsibility of the residents. The security deposit, less any outstanding charges, will be credited to the students account and appear as a credit on their next bill.

First-year students can expect to receive a Housing and Food Service Contract in early May, after their \$500 tuition deposit is received by the Office of Admissions. On this contract, they will indicate their room preference for the residence halls.

All students wishing to live in the residence halls must submit a signed WPI Housing and Food Service Contract.

**MEALS**

All residence hall students (with the exception of Fuller/Ellsworth apartment residents) are required to participate in one of the four meal plans. The MEALS PLUS PLANS are a combination of traditional meal plans plus additional funds to be utilized at the students discretion.

Once a student has contracted for food service, this is a legally-binding agreement, and students are obligated to assume financial responsibility for the entire academic year.

**Board Plan Rates for the 2007-08 academic year**

*(Note: Students are required to be on a meal plan for the entire academic year)*

19 meals plus \$75 in Bonus Points . . . . .	\$ 4,564
14 meals plus \$175 in Bonus Points . . . . .	\$ 4,564
“The 190”, plus \$100 in Bonus Points . . . . .	\$ 4,306
“The VIP”, plus \$100 in Bonus Points . . . . .	\$ 5,326

Descriptions of the board plans are available in the enclosed Dining Services brochure and at the web address: <http://www.wpi.edu/Admin/Dining/>

**OFF-CAMPUS LIVING**

After the first year, on-campus housing may be at a premium; so if you decide to look for an off-campus apartment, make plans well in advance. Residential Services, located in Ellsworth 16, can be a valuable resource for you as you begin your search for off-campus housing. Residential Services maintains a listing of available housing in the Worcester area, as well as an on-line apartment finder system which can be accessed through the department's web page. In addition, information is available for you to research questions about small claims court, housing codes, leases, tenants rights, etc. The following are a few hints for you as you begin your search for off-campus housing.

**Leases:** Contract periods for off-campus housing vary in length, from twelve-month and nine-month to summer only and three-month leases. As you consider various places, find out what types of leases are available.

**Looking:** Check bulletin boards around campus for apartment ads. Also watch Tech News classifieds. In addition, the Residential Services Office maintains a listing of available off-campus housing.

**Be Prepared:** You'll want to plan realistically for expenses such as utilities, transportation, repairs, laundry, and food. Also, try to pick your roommates carefully and ahead of time.

# TRUSTEES ADMINISTRATION AND FACULTY

## SECTION 8

Trustees . . . . .	207
Administration . . . . .	209
Faculty . . . . .	218
Index . . . . .	234
Policies & Practices . . . . .	237
Currency of Information . . . . .	237
Accreditation . . . . .	238
Directions . . . . .	238
Campus Map . . . . .	IBC

---

## TRUSTEES

---

The administration of the college is entrusted to a Corporation consisting of not less than 12 members, consisting of life, ex-officio, at-large and alumni members. Emeriti members are elected by the Corporation in an advisory capacity. (Dates in parentheses following each name indicate year of election to membership.)

---

## OFFICERS OF THE CORPORATION

---

DONALD K. PETERSON '71

*Chairman*

WARNER S. FLETCHER

*Vice Chairman*

STEPHEN E. RUBIN '74

*Vice Chairman*

DENNIS D. BERKEY

*President and CEO*

JEFFREY S. SOLOMON

*Vice President for Finance and CFO, and  
Secretary and Treasurer of the Corporation*

STEPHANIE PASHA

*Secretary of the Corporation*

A. TRACY HASSETT

*Assistant Secretary*

---

## AT LARGE MEMBERS

---

CURTIS R. CARLSON '67 (2002)

*President and CEO*

SRI International

Menlo Park, CA

JOHN P. CASEY '76 (2007)

*President, Electric Boat Corp.*

General Dynamics Corp.

Groton, CT

RICHARD F. CONNOLLY, JR. (2005)

*Senior Vice President*

Morgan Stanley

Boston, MA

THEODORE L. DYSART '94 (2007)

*Managing Partner of the Americas*

Heidrick & Struggels

Chicago, IL

FREDERICK H. EPPINGER (2007)

*President and CEO*

Hanover Insurance Group

Worcester, MA

DANIEL F. FARRAR (2007)

*General Partner*

Morgenthaler Partners

Boston, MA

WARNER S. FLETCHER (1994)

Fletcher, Tilton & Whipple, P.C.

Worcester, MA

CLAIRE L. GAUDIANI (2001)

*Heyman Center for Philanthropy*

New York University

New York, NY

DAVID K. HEEBNER '67 (1997)

*President*

General Dynamics Land Systems

Sterling Heights, MI

JOHN L. LAMATTINA (2001)

*Vice President*

Pfizer Inc.

*President*

Pfizer Global Research & Development

New London, CT

PETER H. LEVINE, M.D. (1990)

*Health Care Consultant*

BDC Advisors, LLC

Worcester, MA

F. WILLIAM MARSHALL, JR. (1986)

*Retired Consultant*

Chebeague Island, ME

ROBERT R. MARTIN '75 (2007)

*Consultant*

Medfield, MA

JOHN T. MOLLEN (2007)

*Executive Vice President, Human Resources*

EMC Corporation

Hopkinton, MA

PHILIP R. MORGAN (1994)

*President and CEO*

Morgan Construction Company

Worcester, MA

JUDITH NITSCH '75 (1989)

*President*

Judith Nitsch Engineering, Inc.

Boston, MA

DONALD K. PETERSON '71 (1997)

*Former Chairman and CEO*

Avaya Inc.

Basking Ridge, NJ

WINDLE B. PRIEM '59 (1991)

*Retired President and CEO*

Korn/Ferry International

Boston, MA

LEONARD E. REDON '73 (1992)

*Vice President, Western Operations*

Paychex, Inc.

Rochester, NY

STEPHEN E. RUBIN '74 (1995)

*Founder*

Intellution, Inc.

Norwood, MA

JOHN J. SHIELDS (SIM '69) (1990)

*General Partner*

Boston Capital Ventures

Boston, MA

GLENN YEE '74 (1999)

*CEO*

Pacific Can Co., Ltd.

Wanchai, Hong Kong



**EX-OFFICIO MEMBER**

DENNIS D. BERKEY (2004)  
*President of the Institute*

**ALUMNI MEMBERS****To June 30, 2008**

KAREN L. BEAN '86 (2000)  
*Associate Director, Community Programs*  
University of Massachusetts Medical School  
Shrewsbury, MA

STEVEN C. HALSTEDT '68 (2003)  
*Managing Director*  
Centennial Ventures  
Denver, CO

**To June 30, 2009**

FREDERICK D. RUCKER '81 (1996)  
*Managing Partner*  
Capital Management Partners  
Oakton, VA

DONALD P. ZERESKI (SIM '74) (2002)  
*President and CEO*  
Northeast International LTD  
Northborough, MA

**To June 30, 2010**

ORVILLE A. BAILEY '85 (2003)  
Custom Part Net  
Olney, MD

**To June 30, 2011**

ROGER J. HEINEN, JR. '73 (2003)  
*Partner*  
Flagship Ventures  
Cambridge, MA

PAUL A. LACOUTURE '72 (2003)  
*Retired*  
Naples, FL

**To June 30, 2012**

SCOTT W. RAMSAY '68 (2004)  
*Former CFO and Exec VP*  
Shaw's Supermarkets

PHILIP B. RYAN '65 (1999)  
*CEO*  
Merchants Automotive Group  
Hooksett, NH

MICHAEL P. ZARRILLI '71 (1999)  
*Chief Executive Officer*  
Stanwich Capital Group  
Greenwich, CT

**To June 30, 2013**

MICHAEL DOLAN '75 (2006)  
*President*  
Exxon Mobile Chemical Co.  
Houston, TX

**EMERITI TRUSTEES**

GEORGE T. ABDOW '53 (1993)  
Longmeadow, MA

PAUL A. ALLAIRE '60 (2002)  
Norwalk, CT

WALTER J. BANK '46 (1986)  
Bethesda, MD

PAUL W. BAYLISS '60 (1989)  
Topsham, ME

ROBERT H. BECKETT '57 (2004)  
Blue Bell, PA

JOHN LOTT BROWN '46 (1983)  
Oberlin, OH

DANIEL I. COIFMAN '67 (2003)  
Santurce, PR

THOMAS A. CORCORAN (2003)  
Potomac, MD

RICHARD A. DAVIS '53 (1987)  
Quechee, VT

WILLIAM A. DELPHOS '74 (1992)  
McLean, VA

WILLIAM P. DENSMORE '45 (1995)  
Worcester, MA

MICHAEL A. DIPIERRO '68 (2002)  
Shrewsbury, MA

ROBERT A. FOISIE '56 (1993)  
Old Saybrook, CT

RAYMOND J. FORKEY '40 (1989)  
Tequesta, FL

HOWARD G. FREEMAN '40 (1994)  
Worcester, MA

ANSON C. FYLER '45 (1982)  
Waynesville, NC

JOHN J. GABARRO '61 (1987)  
Boston, MA

BARBARA J. B. GATISON '74 (2000)  
Blue Bell, PA

WILLIAM E. HANSON '32 (1972)  
Shelton, WA

FRANCIS S. HARVEY '37 (1976)  
Worcester, MA

JAMES N. HEALD, II (1967)  
Worcester, MA

PETER H. HORSTMANN '55 (1984)  
Worcester, MA

JOHN E. HOSSACK '46 (1994)  
New Canaan, CT

WILFRID J. HOUDE '59 (1998)  
Los Gatos, CA

M HOWARD JACOBSON (1977)  
Westborough, MA

PAUL J. KEATING, II '64 (2000)  
Leominster, MA

PAUL S. KENNEDY '67 (1998)  
Worcester, MA

GORDON P. LANKTON (1980)  
Clinton, MA

C. JOHN LINDEGREN, JR. '39 (1991)  
Westboro, MA

ARTHUR J. LOVETERE '60 (1993)  
Atlanta, MI

CLAUDE P. MANCIEL '71 (1997)  
Belgium

MYLES MCDONOUGH (1999)  
Worcester, MA

CHARLES R. MICHEL '37 (1972)  
Audubon, PA

ALFRED A. MOLINARI, JR. '63 (2004)  
Marlboro, MA

JOHN M. NELSON (1986)  
Boston, MA

DAVID P. NORTON '62 (2000)  
Concord, MA

JOHN F. O'BRIEN (1996)  
Needham, MA

STANLEY C. OLSEN (1985)  
Lecanto, FL

HILLIARD W. PAIGE '41 (1984)  
Williamsburg, VA

CAROL L. REINISCH (2001)  
Falmouth, MA

DONALD E. ROSS '54 (1993)  
Newbury, NH

GEORGE E. SALTUS '51 (1991)  
Boulder, CO

GORDON H. SIGMAN, JR. '59 (1996)  
Port St. Lucie, FL

DOROTHY M. SIMON (1988)  
Pittsboro, NC

H. KERNER SMITH (2003)  
Falmouth, MA

ROBERT C. STEMPEL '55 (1994)  
Oxford, MI

DONALD TAYLOR '49 (2000)  
North Hampton, NH

HOWARD C. WARREN '42 (1982)  
Chicago, IL

LEONARD H. WHITE '41 (1992)  
Worcester, MA

RONALD L. ZARRELLA '71 (2006)  
Rochester, NY

---

## ADMINISTRATION

---

*Numerals following name indicate year(s) of initial appointment.*

---

### OFFICE OF THE PRESIDENT

---

DENNIS D. BERKEY (2004)  
*President of the Institute*  
B.A., Muskingum College, 1969; M.A., Miami University of Ohio, 1971; Ph.D., University of Cincinnati, 1974.

STEPHANIE PASHA (2004)  
*Chief of Staff*  
B.S.B.A., Boston University, 1993; Ed.M., 1997.

---

### ACADEMIC AFFAIRS

---

JOHN A. ORR (1977)  
*Provost ad Interim and Dean of Undergraduate Studies; Professor, Electrical and Computer Engineering*  
B.S., University of Illinois, 1969;  
M.S., Stanford University, 1970;  
Ph.D., University of Illinois, 1977.

MCRAE C. BANKS (1995)  
*Director, Collaborative for Entrepreneurship & Innovation; Professor, Management and Head of Department*  
B.A., Virginia Tech, 1972;  
M.A., Northwestern University, 1973;  
Ph.D., Virginia Tech, 1987.

JAMES A. BARYS (2000)  
*Master Teacher of Mathematics, Massachusetts Academy of Mathematics and Science*  
A.B., Colby College, 1969;  
M.A., Clark University, 1977.

GINA M. BETTI (2000)  
*Associate Director, Collaborative for Entrepreneurship & Innovation*  
B.S., Eastern Michigan University, 1980; M.B.A., 1983.

PETER COLLINS (2007)  
*Visiting Scholar, Mathematics, Massachusetts Academy of Mathematics and Science*  
B.S., University of Connecticut, 1983;  
Masters in Math for Educators, Worcester Polytechnic Institute, 2003.

MARTHA N. CYR (2003)  
*Director, K-12 Outreach*  
B.S., University of New Hampshire, 1982;  
M.S., Worcester Polytechnic Institute, 1987; Ph.D., 1997.

SHARON DEFFELY (1978)  
*Director, Corporate Training, Corporate and Professional Education*  
A.S. Grahm Junior College, 1969.

CHRISTINA DEVRIES (2005)  
*Associate Director, Post-Award and Compliance, Office of Research Administration*  
B.S., University of Nevada - Reno, 1982.

- ALEXANDER A. DI IORIO (1993)  
*Director of the Bioprocess Lab and Adjunct Assistant Professor, Biology and Biotechnology*  
B.A., Columbia University, 1983;  
M.S., Worcester Polytechnic Institute, 1986; Ph.D., 1991.
- WILLIAM F. ELLIS, JR. (2007)  
*Teacher of Science, Massachusetts Academy of Mathematics and Science*  
B.S., University of Massachusetts – Dartmouth, 1996;  
Accelerated Pathways to Teaching, Bridgewater State College, 2003.
- STEPHEN P. FLAVIN (2005)  
*Associate Provost and Dean, Corporate and Professional Education*  
B.S., Suffolk University, 1990; J.D., 1994.
- CAROL A. GAROFOLI (1972)  
*Director of Operations, Metal Processing Institute*  
A.S., Becker Junior College, 1972;  
B.S., Worcester State College, 1982;  
M.B.A., Assumption College, 1998.
- DEBORAH J. GRAVES (1996)  
*Executive Assistant to the Provost*  
A.S., Becker College, 1983.
- LEANNE JOHNSON (2007)  
*Program Administrator, Global Perspective Program, Interdisciplinary and Global Studies Division*  
B.A., Columbia Union College, 1995;  
M.A., American University, 2001.
- TODOR V. KIRYAZOV (2007)  
*Information Systems and Accounting Administrator*  
B.S., Worcester Polytechnic Institute, 2007.
- KAREN M. LANG (2003)  
*Master Teacher of Computer Science, Massachusetts Academy of Mathematics and Science*  
B.A., College of New Rochelle, 1980;  
M.A.T., Tufts University, 1991.
- FRANCOIS D. LEMIRE (2000)  
*Director of Research Administration*  
B.S., University of Rhode Island, 1977.
- DAVID E. LUDT (2005)  
*Teacher of Humanities, Massachusetts Academy of Mathematics and Science*  
B.A., College of the Holy Cross, 1969;  
M.A., Rhode Island College, 1974.
- ANTHONY J. MANGANO, JR. (2003)  
*Director, Corporate and Professional Education*  
B.S., Worcester Polytechnic Institute, 1972; M.S., 1976.
- MICHAEL B. MANNING (2003)  
*Director, Technology Transfer*  
B.S., Tufts University, 1974;  
M.S., University of Maryland, 1977;  
Ph.D., Brown University, 1985.
- JAMES W. MATTHEWS (2002)  
*Research Scientist*  
B.S., Lehigh University, 1963;  
M.S., Polytechnic Institute of Brooklyn, 1967; Ph.D., 1971.
- W. GRANT MCGIMPSEY (1989)  
*Associate Provost for Research and Graduate Studies ad interim; Director, Bioengineering Institute; Professor, Chemistry and Biochemistry*  
B.S., Brock University (Canada), 1978; M.S., 1981;  
Ph.D., Queen's University (Canada), 1985.
- NATALIE MELLO (1993)  
*Director of Global Operations, Interdisciplinary and Global Studies Division*  
B.A., Connecticut College, 1984;  
M.A., Clark University, 1995.
- DAVID PRINCE (2007)  
*Marketing Manager, Department of Management*  
B.A., University of Rhode Island, 1990;  
M.A., Fairfield University, 1992.
- KENT J. RISSMILLER (1988)  
*Associate Dean, Interdisciplinary and Global Studies Division; Associate Professor, Social Science and Policy Studies*  
A.B., Muhlenberg College, 1976;  
J.D., Franklin Pierce Law Center, 1980;  
M.A., Syracuse University, 1981; Ph.D., 1986.
- TED RUSSO (2005)  
*Associate Director, Pre-Award Services, Office of Research Administration*  
A.L.B., Harvard University Extension School, 1993;  
M.P.A., Suffolk University, 1998.
- ROBERT A. SALVATELLI (1999)  
*Director of the Massachusetts Academy of Mathematics and Science*  
B.S., University of Bridgeport, 1964;  
M.S., Fitchburg State College, 1969.
- LANCE E. SCHACHTERLE (1970)  
*Associate Provost for Academic Affairs; Professor of English, Humanities and Arts*  
A.B., Haverford College, 1966;  
A.M., University of Pennsylvania, 1968; Ph.D., 1970.
- PAMELA S. SHELLEY (2000)  
*Assistant Director of the Advanced Distance Learning Network, Corporate and Professional Education*  
B.A., University of Massachusetts – Amherst;  
M.B.A., Suffolk University.
- LAURIE A. SMITH (1990)  
*Director of Academic Operations, Provost's Office*
- DALE E. SNYDER (1999)  
*Director of Academic Advising*  
B.S., Plymouth State College, 1976;  
M.S., Old Dominion University, 1986.
- PAMELA K. ST. LOUIS (1996)  
*Operations Manager, Mechanical Engineering and Academic Affairs*
- JUDITH H. SUMNER (2007)  
*Visiting Scholar, Technical Writing, Massachusetts Academy of Mathematics and Science*  
A.B., Vassar College, 1972;  
M.S., University of Massachusetts – Amherst, 1974;  
Ph.D., 1976.

ROBERT W. TRAVER (2003)  
*Principal, Massachusetts Academy of Mathematics and Science*  
 A.B., Dartmouth College 1975;  
 M.S., Purdue University, 1980;  
 Grad Diploma, University of Canterbury, NZ, 1981;  
 Ed.D., Harvard University, 1991.

JOANN VAN DYKE (1973)  
*Director, Academic Resource Center/Disability Services*  
 R.N., Framingham Union Hospital School of Nursing, 1967;  
 Certified College Health Nurse, American Nurses Credentialing  
 Center, 1994.

RICHARD F. VAZ (1983)  
*Dean, Interdisciplinary and Global Studies Division;*  
*Associate Professor, Electrical and Computer Engineering*  
 B.S.E.E., Worcester Polytechnic Institute, 1979; M.S.E.E.,  
 1984; Ph.D., 1987.

JULIA N. WILDFONG (2006)  
*Teacher of World Languages, Massachusetts Academy of*  
*Mathematics and Science*  
 B.A., Moravian College, 1994;  
 M.A., Boston College, 1998;  
 Framingham State College.

NORMAN D. WILKINSON (1995)  
*Director, Graduate Management Programs*  
 B.A., University of Maine, 1983;  
 M.A., Syracuse University, 1986;  
 J.D., University of Connecticut School of Law, 1992.

PAUL WOOD (2007)  
*Visiting Scholar, Science, Massachusetts Academy of Mathematics*  
*and Science*  
 B.S., Northeastern University, 1987.

---

## CORPORATE AND PROFESSIONAL EDUCATION

---

STEPHEN P. FLAVIN (2005)  
*Associate Provost and Dean,*  
*Corporate and Professional Education*  
 B.S., Suffolk University, 1990; J.D., 1994.

SHARON DEFFELY (1978)  
*Director, Corporate Training, Corporate and Professional Education*  
 A.S. Grahm Junior College, 1969.

ANTHONY J. MANGANO, JR. (2003)  
*Director, Corporate and Professional Education*  
 B.S., Worcester Polytechnic Institute, 1972; M.S., 1976.

PAMELA S. SHELLEY (2000)  
*Assistant Director, Advanced Distance Learning Network*  
 B.S., University of Massachusetts - Amherst  
 M.B.A., Suffolk University

---

## DEVELOPMENT AND ALUMNI RELATIONS

---

DEXTER A. BAILEY  
*Vice President for Development & Alumni Relations*  
 B.S., Ohio University, 1992;  
 MBA, University of Toledo, 1994.

TERRY SCHMIDT ADAMS  
*Director of Corporate Relations*  
 B.S., Worcester Polytechnic Institute, 1992;  
 M.B.A., New Hampshire College, 1997.

JODI M. BRIGGS  
*Associate Director of Alumni Relations*  
 B.A. Keene State College, 1997;  
 M.S., Central Connecticut State College, 2003.

JUDI TAYLOR CANTOR  
*Executive Director of Planned Giving*  
 B.J., University of Texas.

ROBERT N. GRADY  
*Planned Giving Officer*  
 A.B., Davidson College.

BETH HOWLAND  
*Assistant Vice President of Alumni Relations*  
 B.S. 1984, University of Vermont;  
 M.S., University of Connecticut, 1989.

REBECCA KURLAND  
*Assistant Director of Annual Giving*  
 B.A., Assumption College, 2004.

LINDA CARRE LOOFT  
*Assistant Vice President of Government & Community Relations*  
 B.S., Worcester State College, 1994.

SARAH O'BRIEN MACKKEY  
*Director of Executive and Development Communications*  
 B.A., Vassar College, 1989.

LISA C. MAIZITE  
*Assistant Vice President for Development*  
 B.A., University of Vermont, 1992.

REBECCA NORMAN  
*Associate Director of Prospect Management*  
 B.S., University of Wisconsin, Osh Kosh.

ROBERT OBORNE  
*Senior Advancement Researcher*  
 B.A., UMass Amherst, 1974;  
 M.B.A., Rivier College, 1984.

ELIZABETH PARKER  
*Director of Annual Giving*  
 B.A., Wellesley College, 1997;  
 M.B.A., Babson College, 2005.

DENISE R. RODINO  
*Executive Director of Corporate & Foundation Relations*  
 B.A., Rutgers University, 1971.

DONNA K. STOCK  
*Major Gifts Officer*  
 B.A., Colby College, 1982.

CHRISTINE A. TAYLOR  
*Major Gifts Officer*  
 B.S., Cornell University, 1990;  
 M.S., Syracuse University, 1996.

AMY E. WEYMOUTH  
*Development Technology Specialist*  
B.A., Assumption College, 1977.

JAMES WONG  
*Manager of Operations*  
B.S., Worcester Polytechnic Institute, 2005.

BARBARA R. ZIFF  
*Executive Director of Advancement Operations and Research*  
B.F.A., Boston University, 1964.

LUANNE ZINGARELLI  
*Director of Advancement Services*

---

## ENROLLMENT MANAGEMENT

---

KRISTIN R. TICHENOR (2000)  
*Vice President of Enrollment Management*  
B.A., Carleton College, 1985;  
M.A., Clark University, 1994.

CHELSEA ADAMS (2004)  
*Senior Assistant Director of Financial Aid*  
B.A., Trinity College, 2001.

MONICA M. LUCEY BLONDIN (1995)  
*Director of Financial Aid*  
B.A., University of Massachusetts, 1990;  
M.S., Northeastern University, 1994.

JULIE CHAPMAN (2001)  
*Associate Director of Admissions, Director of Frontiers  
and Launch Programs*  
B.A., University of New Hampshire, 1997.

JENNIFER A. CLUETT (1998)  
*Senior Associate Director of Admissions, and Coordinator  
of Counselor Relations*  
A.B., Bowdoin College, 1996.

EDWARD J. CONNOR (2000)  
*Director of Admissions*  
B.S., Worcester Polytechnic Institute, 1992;  
M.S., Boston College, 1999.

MICHAEL J. DIRUZZA, JR. (2000)  
*Associate Director of Financial Aid*  
A.S., Becker College, 1991;  
B.S., New Hampshire College, 1992;  
M.B.A., Anna Maria College, 1998.

ADAM EPSTEIN (2005)  
*Assistant Director of Admissions*  
B.S., Worcester Polytechnic Institute, 2006.

ROBYN ESPOSITO (2005)  
*Assistant Director of Financial Aid*  
B.A., Castleton State College, 1998.

ALEKSANDRA V. FEDOROVICH (2005)  
*Senior Assistant Director of Admissions,  
International Coordinator*  
B.S., Worcester Polytechnic Institute, 2002.

RONALD V. FONTAINE (2006)  
*Associate Registrar*  
B.A., Stonehill College, 1999.

KAREN GOUDEY (2005)  
*Associate Director of Admissions*  
B.A., Smith College, 1989;  
M.A., Lesley College, 1998.

BONNIE HALL (2007)  
*Senior Assistant Director of Admissions,  
Coordinator of Multicultural Recruitment*  
B.A., Clark University, 2001; M.A., 2002.

AARON HARP (2007)  
*Director of Institutional Research*  
B.A., California State University, 1984;  
M.S., Pennsylvania State University, 1987;  
Ph.D., Pennsylvania State University, 1992.

CHARLES J. KORNIK (1989)  
*Administrator of Academic Programs*  
B.S., Fitchburg State College, 1966; M.Ed., 1975.

JASON LAPERRIERE (2007)  
*Assistant Director of Admissions*  
B.A., Assumption College, 2006.

MELISSA M. LEAHY (1997)  
*Enrollment Analyst*  
B.S., Worcester Polytechnic Institute, 1997.

KATHERINE MCINTYRE (2007)  
*Admissions Counselor*  
B.S., Bentley College, 2007.

LEOLYN OSBORN (1980)  
*Senior Associate Director of Financial Aid*  
B.A., Southeastern Massachusetts University, 1976.

WENDELIN RANSOM (1999)  
*Enrollment Systems Manager*  
B.S., Worcester State College, 1992.

MICHAEL P. SMITH (1992)  
*Associate Director of Admissions and Transfer Affairs*  
A.B., Bowdoin College, 1989;  
M.S., Clark University, 1999.

ALAINA WIEHN  
*Registrar*  
B.A., Marist College, 1996;  
M.Ed., Arcadia University, 2000.

---

## FINANCE AND OPERATIONS

---

JEFFREY S. SOLOMON (2005)  
*Executive Vice President/CFO  
Treasurer of the Corporation*  
B.S., Bentley College, 1985;  
M.S., Brandeis University, 2001.

ALFREDO DIMAURO (2007)  
*Assistant Vice President for Facilities*  
B.S., Roger Williams College, 1979;  
M.B.A., Western New England College, 1990.

JENIFER AMEDY (2005)  
*Manager, Bookstore*  
B.S., Bryant College, 2001.

GARY L. ANTINARELLA (1996)  
*Supervisor of Custodians-Night*

- HEATHER BILOTTA (2007)  
*Research Accountant*  
B.A. Mount Holyoke College, 2001.
- PATTI-LYNNE CAMPOMIZZI (1997)  
*Senior Budget Analyst*  
B.S. Worcester State College, 1977.
- BARRY E. CARMEL (1985)  
*Senior Staff Accountant*  
A.S., Central New England College, 1972.
- KAREN CHROBAK (2007)  
*Staff Accountant*  
B.B.A. Assumption College, 1985.
- LORI A. COSTELLO (2005)  
*Payroll Manager*  
A.S., Quinsigamond Community College, 1985.
- DAVID CROKE (2007)  
*Information Analyst*  
Nichols College, 1996.
- MICHAEL J. CURLEY (1979)  
*University Compliance Officer*  
B.S., University of Massachusetts, 1973;  
M.S., Bridgewater State College, 1976.
- CHAD FARRELL (1983)  
*Supervisor, Printing Services*
- SADIE C. GOESCH (1990)  
*Administrative Services Manager*
- YVONNE D. HARRIS (1988)  
*Assistant Controller*  
B.S., Central Connecticut State University, 1985;  
M.B.A., Nichols College, 1997.
- NORMAN F. HUTCHINS (2001)  
*Mechanical Operations Supervisor*
- JAMES F. KENARY (1981)  
*Events Program Manager*
- RONALD F. KLOCEK (1988)  
*Manager of Grounds and Properties*  
A.A., Central New England College, 1983.
- JOSEPH M. KRASKOUSKAS (1995)  
*Director, Dining Services (Chartwell's)*
- HAILAN LI (2003)  
*Manager, Research Accounting*  
B.S., Sichuan Technology Institute, 1991;  
M.S., Worcester Polytechnic Institute, 2003.
- CELIA MCLAREN (1987)  
*Supervisor, Mail Services*
- DAVID H. MESSIER (1982)  
*Environmental & Occupational Safety Manager*  
A.S., Quinsigamond Community College, 1993.
- THOMAS MOREAU (1986)  
*Supervisor of Custodians*  
A.S., Becker Junior College, 1977.
- MARLYN MYERS (1976)  
*Plant Services-Manager of Properties*
- TERRENCE J. PELLERIN (1981)  
*Associate Director of Facilities*
- ROBERT C. PEPIN (1985)  
*Supervisor of Custodians*
- MICHELLE PICKETT (2007)  
*Treasury Analyst*  
B.S. Worcester State College, 2000.
- DEBBORAH PIZZIMENTI (2007)  
*Senior Accountant*  
B.A. SUNY @ Stonybrook, 1981;  
M.S. CW Post, CW Post, 1992.
- CLARENCE PLANT (1985)  
*Property Administrator*  
CPPM, CF
- RICHARD J. ROGAN (2002)  
*University Controller*  
B.B.A., University of Massachusetts, 1981;  
M.S., Bentley, 1984; CPA, 1984.
- CHRISTOPHER L. SALTER (1998)  
*Associate Director of Facilities*  
B.S., University of Massachusetts, 1974.
- ANN S. SCHLICKMANN (1982)  
*Director of Administrative Services*  
B.A., Regis College, 1963.
- NANCY SMITH (2006)  
*Assistant Director of Financial Services*  
B.S.B.A., Worcester State College, 1989;  
M.B.A., Nichols College, 1995; C.M.A., 2002.
- ELIZABETH TOMASZEWSKI (2003)  
*Information Systems Supervisor*  
M.B.A., Bentley College, 1983.
- JUDITH L. TRAINOR (1987)  
*Director of Budget and Planning*  
B.A., Smith College, 1971;  
M.A., University of Connecticut, 1973;  
M.B.A., Babson College, 1983; CPA, 1986.
- JANET L. WHITTIER (1964)  
*Accounts Receivable Manager*  
Salter Secretarial School, 1964.

---

## HUMAN RESOURCES

---

- A. TRACY HASSETT, SPHR (1998)  
*Vice President for Human Resources*  
B.S. Roger Williams University, 2002.
- CYNTHIA J. PELLEGRINO (2001)  
*Associate Director of Human Resources*  
M.B.A., Nichols College, 2005.
- AUDRA M. GAUL (2006)  
*Manager, Training & Development & Human Resources Communications*  
B. A. Boston University, 1996;  
M.A. Boston University, 2004.



**INFORMATION TECHNOLOGY**

- THOMAS J. LYNCH III (1998)  
*Vice President for Information Technology and Chief Information Officer*  
B.S., University of Cincinnati, 1972;  
S.M., Massachusetts Institute of Technology, 1974; E.E., 1975;  
Ph.D., 1981.
- CHARLES R. ANDERSON (1999)  
*Network Engineer*  
B.S., Worcester Polytechnic Institute, 1999.
- JON BARTELSON (1998)  
*Assistant Director of Computing Services*  
B.S., Worcester Polytechnic Institute, 2001;  
M.B.A., Bentley College, 2006.
- JOANNE BELLER (1980)  
*Reference Coordinator*  
B.S.Ed., Framingham State College, 1975;  
M.L.S., Simmons College, 1980.
- WALTER G. BERTRAND (1994)  
*Manager of Telecommunications*
- KATE E. BEVERAGE (2005)  
*Instructional Technology Specialist*  
B.A., University of Connecticut, 2002.
- DEBORAH A. BOCKUS (1989)  
*Access Services Manager*  
A.A., Mount Wachusett Community College, 1986;  
B.S., Worcester State College, 1989;  
M.L.S., Simmons College, 2002.
- LORA T. BRUECK (1974)  
*Assistant Director, Collections*  
B.A., University of Massachusetts, 1969;  
M.L.S., Spalding College, 1970.
- THOMAS L. COLLINS, III (2001)  
*Windows System Administrator*  
B.S., Worcester Polytechnic Institute, 2001.
- PAULA M. DELANEY (2001)  
*Administrative Applications Manager*  
B.S., Worcester Polytechnic Institute, 1976.
- PHILLIP G. DENEALT (2004)  
*Network Security Officer*  
B.S., Worcester Polytechnic Institute, 2006
- DEBRA L. DEXTER (1995)  
*Software Applications Instructor*  
B.A., University of Massachusetts, Amherst, 1992;  
M.S., Clark University, 2006.
- MARIE DIRUZZA (1997)  
*Assistant Director, Desktop Support*  
B.A., Our Lady of the Elms College, 1992.
- ROGER A. DONAHUE (1987)  
*Database Administrator*  
A.A., Worcester Industrial Technical Institute, 1974.
- CHRISTINE DREW (2004)  
*Manager, Instruction and Outreach*  
B.A., Worcester State College, 1992;  
M.L.S., Southern Connecticut State University, 1994.
- BRUCE M. FIENE (2000)  
*Assistant Manager, Campus Media Services*  
B.F.A., Massachusetts College of Art, 1989.
- BRYAN FERGUSON (2006)  
*Assistant Windows Systems Administrator*
- AARON FOINT (2006)  
*Windows Systems Administrator*  
B.S., Westfield State College 2001.
- DAVID W. GALVIN (1973)  
*ERP Administrator*
- MARTHA GUNNARSON (1987)  
*Assistant Director, Serials*  
A.B., Clark University, 1972;  
M.L.S., Simmons College, 1976.
- MATT HALL (2006)  
*Director of User Services; Assistant Library Director*  
B.A., Bowdoin College, 1992;  
M.S., Simmons College, 1996.
- LAURA ROBINSON HANLAN (2005)  
*Interlibrary Loan/Reference Librarian*  
B.A., University of Connecticut, 1996;  
M.S., Simmons College, 2002.
- MARY BETH HARRITY (1989)  
*Director, Academic Technology Center*  
A.B., College of the Holy Cross, 1979;  
M.Ed., University of Massachusetts, 1984.
- STEPHEN W. HEMMING (2002)  
*Manager, Campus Media Services*  
B.A., Ithaca College, 1981.
- ADRIANA HERA (2005)  
*Academic Computer Application Scientist*  
B.S., Polytechnic Institute of Bucharest, 1989;  
M.S., Worcester Polytechnic Institute, 2001; Ph. D., 2005.
- ALLAN E. JOHANNESSEN (1970)  
*Assistant Vice President for Technology Infrastructure*  
B.S., Worcester Polytechnic Institute, 1968.
- JOSEPH M. KRZESZEWSKI (2000)  
*Network Engineer*  
B.S., Worcester Polytechnic Institute, 2000.
- VICKI LYNN (2000)  
*Sr. Project Manager*  
B.S., Bates College, 1972;  
M.S., Central Connecticut State College, 1978;  
M.B.A., University of Connecticut, 1984.
- JAMES MONACO  
*Multimedia Production Specialist*  
B.S., Georgia Institute of Technology, 2006.
- SIA M. NAJAFI (1995)  
*Director, Research Computing and Academic IT Support*  
B.S., Worcester Polytechnic Institute, 1984; M.S., 1990.
- RODNEY G. OBIEN (2000)  
*Curator of Special Collections and Archives*  
B.A., Virginia Wesleyan College, 1992;  
M.L.I.S., Catholic University of America, 1996.

CHRISTOPHER M. O'CONNOR (2000)  
*Senior Windows System Administrator*  
 A.S., Community College of the Air Force, 1989;  
 B.A., Ohio State University, 1992;  
 MCSE Certification, Worcester Polytechnic Institute, 2000.

KERRIE O'CONNOR (1997)  
*Office Operations Computer Support Services*  
 B.A., College of the Holy Cross, 1992.

SEAN M. O'CONNOR (1997)  
*Assistant Vice President for Information Security and Networking*  
 B.S., Worcester Polytechnic Institute, 1994;  
 M.S., Rensselaer Polytechnic Institute, 1998.

AMY E. PARTRIDGE (1984)  
*Administrative Support Analyst*  
 A.A., Colby-Sawyer College, 1978.

MIN QUI (2003)  
*Assistant Data Base Administrator*  
 B.S., Xiangtan University, China, 1993; M.S., 1996.

AMY RICCI (2005)  
*Assistant Director, Academic Technology Center*  
 B.A., Syracuse University, 1992;  
 M.B.A., Rochester Institute of Technology, 1995;  
 M.A., George Washington University, 2005.

DONALD G. RICHARDSON (1976)  
*Assistant Director, Library Systems*  
 B.A., Colby College, 1974;  
 M.L.S., Simmons College, 1976.

LYNNE RILEY (2005)  
*Access Services Librarian*  
 B.S., Worcester State College, 2001;  
 M.L.I.S., University of Pittsburgh, 2005.

CARLA RISI (2000)  
*Administrative User Support Specialist*

KEVIN R. SHANAHA (1978)  
*Programmer/Analyst*  
 A.A., Worcester Industrial Technical Institute, 1978.

ROBERT M. SHEEHAN (1995)  
*Programmer/Analyst*

GREG SMITH (2005)  
*Information Systems Specialist*  
 B.S. Tufts University, 1991.

ANDREW M. STONE (2001)  
*Information Services and Technologies Engineer*  
 B.S., Worcester Polytechnic Institute, 2001;  
 M.S., Worcester Polytechnic Institute, 2006.

FRANK E. SWEETSER (1998)  
*Network Engineer*  
 B.S., Worcester Polytechnic Institute, 2001.

DAVID TARANTO (2002)  
*Manager, Media Production Services*  
 B.S., New England Institute of Technology, 1999.

MARK J. TAYLOR (2001)  
*UNIX Systems Administrator*  
 UNIX Certification, Worcester Polytechnic Institute, 1996;  
 Technology Certification, 1998.

BENJAMIN R. THOMPSON (1975)  
*Associate Vice President for Information Technology;*  
*Associate Chief Information Officer*  
 B.S., Worcester Polytechnic Institute, 1973.

ANNE M. VALERIO (1996)  
*Office Operations Computer Support Specialist*  
 B.A., University of Massachusetts, North Dartmouth, 1985.

---

## MARKETING AND COMMUNICATIONS

---

CHRISTOPHER J. HARDWICK (2005)  
*Vice President, Marketing and Communications*  
 B.A., University of Wisconsin, 1979;  
 M.A., University of Maryland, 1980.

KIMBERLY A. ALLEN (2006)  
*Marketing Communications Specialist*  
 B.S., Northeastern University, 1993.

MICHAEL W. DORSEY (1985)  
*Director, Research Communications*  
 B.A., University of Connecticut, 1976.

NICHOLAS P. GALOTTI III (2006)  
*Web Applications Administrator*  
 B.S., Worcester Polytechnic Institute, 2005.

PEGGY L. ISAACSON (1974)  
*Graphic Designer*  
 The Salter School, 1958.

SARAH MACKEY (2006)  
*Director, Executive and Development Communications*  
 B.A., Vassar College, 1989.

CRAIG A. MAYNARD (2007)  
*Communications Specialist*  
 B.A., Massachusetts College of Liberal Arts, 2005.

EILEEN BRANGAN MELL (2007)  
*Director, Public Relations*  
 B.A., Rivier College, 1993.

JOAN KILLOUGH-MILLER (1993)  
*Alumni Editor*  
 B.A., Hamilton College, 1979;  
 M.A., Syracuse University, 1986.

TARA MYERS (2002)  
*Director, Marketing Strategy*  
 B.A., Boston University, 1997;  
 M.B.A., Clark University, 2005.

ANNMARIE NICHOLS (2006)  
*Interactive Designer*  
 B.A., Clark University, 2002.

TONYA PRICE (2007)  
*Director, Marketing and Web Operations*  
 B.A., Oberlin College;  
 M.B.A., Cornell University.

TARA A. PROBECK (2006)  
*Marketing Communications Specialist*  
 B.S., Bryant College, 1996.

LORRAINE URBANSKI (2006)  
*News Writer*  
 B.A., University of Massachusetts at Amherst, 1997.

DIANNE VANACORE (2007)  
*Communications Coordinator*  
 B.A., State University of New York at Oswego, 1976.

CHARNA WESTERVELT, (2005)  
*Director, Editorial Services*  
 B.A., Ithaca College, 2000.

---

## STUDENT AFFAIRS AND CAMPUS LIFE

---

JANET BEGIN RICHARDSON (1980)  
*Vice President for Student Affairs and Campus Life*  
 B.A., Salem State College, 1975;  
 Ed. S., SUNY at Albany, 1977; M.S., 1977.

CHRISTOPHER J. BARTLEY (2001)  
*Assistant to the Athletic Director;*  
*Head Men's Varsity Basketball Coach;*  
*Instructor, Physical Education*  
 B.A., University of Massachusetts/Lowell, 1994.

RODERICK J. BEATON (1992)  
*Associate Director of Public Safety*  
 B.S., Boston College, 1976;  
 M.A., Clark University, 1980.

PAUL A. BENNETT (2004)  
*Head Swimming and Diving Coach;*  
*Instructor, Physical Education*  
 B.A., University of Wyoming, 2000.

KAREN M. BUENO (2006)  
*Sergeant, Campus Police*  
 A.S., Quinsigamond Community College.

SHARON E. CAHILL (1990)  
*Nurse*  
 St. Vincent Hospital, 1966.

DOROTHY A. CAMPANIELLO (1994)  
*Recruiting Coordinator, Career Development Center*

NAOMI B. CARTON (2001)  
*Director of Residential Services*  
 B.A., Regis College, 1999;  
 M.A., University of Connecticut, 2001.

CHRISTOPHER CARPENTER (1995)  
*Police Officer, Campus Police*

PHILIP N. CLAY (1993)  
*Dean of Students*  
 B.A., St. Lawrence University, 1982;  
 M.A., University Center at Binghamton, 1986.

GREG CRUM (2006)  
*Assistant Football Coach;*  
*Director of Intramurals;*  
*Instructor, Physical Education*  
 B.A., Worcester State College, 2000.

MICHAEL J. DESAVAGE (2002)  
*Head Athletic Trainer;*  
*Instructor, Physical Education*  
 B.S., Keene State College, 1992;  
 M.Ed., Temple University, 2000.

JEANETTE M. DOYLE (2002)  
*Director, Career Development Center*  
 B.S., Framingham State College, 1989;  
 M.Ed., Springfield College, 1994.

JOHN E. DYLEWICZ (1977)  
*Police Officer, Campus Police*

MICHAEL W. ELLSWORTH (1999)  
*Sergeant, Campus Police*  
 B.S., Worcester State College;  
 M.A., Anna Maria College.

RUSTY EGGEN (2006)  
*Assistant Athletic Director;*  
*Sports Information Director*  
 B.S. Slippery Rock University, 1996.

CHERISE GALASSO (2000)  
*Assistant Director of Athletics;*  
*Senior Women's Administrator;*  
*Head Women's Basketball Coach*  
 B.A., The University of Rochester, 1992;  
 M.S., Nazareth College, 1994.

LAUREN C. GIANGRANDE (2007)  
*Nurse Practitioner*  
 ADN, Quinsigamond Community College, 2002;  
 BSN, Anna Maria College, 2005;  
 MSN, University of Massachusetts, 2007.

SHERRY A. GIBSON (1999)  
*Police Officer, Campus Police*

CHRISTOPHER J. GILMORE (2007)  
*Police Officer, Campus Police*

CHRISTINE GIROUARD (2007)  
*Assistant Director of Student Activities*  
 B.S., Salve Regina University, 2005;  
 M.S., Central Connecticut State University, 2007.

PHILIP J. GREBINAR (1972)  
*Associate Professor of Physical Education*  
 B.S., State University College at Cortland, 1971; M.S., 1972.

EDWIN R. GUZMAN (2005)  
*Police Officer, Campus Police*

MICHAEL HAMILTON (2007)  
*Complex Coordinator, Residential Services*  
 B.A., Bridgewater State College, 2007.

DANA L. HARMON (2002)  
*Director of Physical Education, Recreation & Athletics*  
 B.A., Bellamine College, 1987;  
 M.S., Umass /Amherst, 1994.

PATRICK K. HICKEY (1999)  
*Assistant Football Coach;*  
*Fitness Center Director;*  
*Instructor, Physical Education*  
 B.S., Assumption College, 1999.

CALVIN R. HILL (2003)  
*Assistant Dean of Students and Director of Diversity Programs*  
 B.A., Bethany College, 1993;  
 M.S., Emporia State University, 1997;  
 Ph.D., Howard University, 2004.

CONSTANCE H. HORWITZ (2003)  
*Assistant Director, Career Development Center*  
 B.S., Northeastern University, 1972; M.B.A., 1979.

JOSEPH M. KRASKOUSKAS (1995)  
*Director, Dining Services*  
 (Chartwell's)

- ANNE LANDRY (2002)  
*Registered Nurse*  
Memorial Hospital, 1965;  
BSN, UMass Amherst, 1991.
- JEFFREY S. LARAMEE  
*Police Officer, Campus Police*
- BRIAN F. LAVALLEE (1998)  
*Police Officer, Campus Police*
- EDMOND W. LORION (2002)  
*Manager, Bowling Center;*  
*Instructor, Physical Education*
- KAROLINA MARKLE (2006)  
*Complex Coordinator, Residential Services*  
B.S., Boston University, 2001.
- CHERYL A. MARTUNAS (2005)  
*Director of Public Safety*  
B.S., Anna Maria College
- SHAWN MCAVEY (1990)  
*Facilities Manager*
- BILLY D. MCGOWAN (1997)  
*Director, ESL*  
B.A., University of New Orleans, 1972;  
M.A., Troy State University, 1982;  
Graduate Certificate in ESL, Clark University, 1996.
- JAMES H. MCLAUGHLIN (2000)  
*Director of Campus Center and Student Activities*  
B.A., Bridgewater State College, 1975;  
M.A., Fairfield University, 1977.
- ANDREA J. MORAIS  
*Police Officer, Campus Police*
- CHARLES C. MORSE (1993)  
*Director, Student Development and Counseling Center*  
B.A., University of Massachusetts, Amherst, 1981;  
M.A., Assumption College, 1993.
- KRISTIN MURPHY (2005)  
*Assistant Director of Residential Services*  
B.S., Bridgewater State College, 2001;  
M.Ed., Suffolk University, 2005.
- MICHELLE E. NICHOLSON (2005)  
*Director of Women's Programs*  
B.A., Roger Williams University, 1994; M.S., 1998.
- LAWRENCE NOBLE (1999)  
*Director of Rowing, Head Coach - Men's Crew;*  
*Instructor, Physical Education*  
B.A., Columbia College, 1984;  
M.A., University of Virginia, 1994.
- KAITLYN O'MALLEY (2006)  
*Assistant Woman's Basketball Coach;*  
*Instructor, Physical Education*  
B.A. Stonehill College, 2004.
- EMILY PERLOW (2005)  
*Associate Director of Student Activities and Greek Life Programs*  
B.A., The Ohio State University, 2002;  
M.A., Bowling Green State University, 2005.
- MICHELLE POVERMAN (2005)  
*Mental Health Counselor, Student Development and Counseling Center*  
B.A., Westfield State College, 1997;  
M.A., Antioch University New England, 2005.
- HEINZ J. RING (1980)  
*Sergeant, Campus Police*
- REGINA A. ROBERTO (2001)  
*Director/Nurse Practitioner, Health Services*  
BSN, Northeastern University, 1980  
M.S., Regis College, 1998
- REBEKAH FREEMAN SCHULZE (2007)  
*Outreach Coordinator, Student Development and Counseling Center*  
B.A., Colby College, 1994;  
M.A., New York University, 1988.
- GREGORY A. SNODDY (1996)  
*Associate Dean of Students & Director of PERA Student Programs*  
B.S., Ohio University, 1983;  
M.Ed., Bowling Green State University, 1985;  
Ed.D., West Virginia University, 1996.
- ROBERT SOUTHALL (2005)  
*Assistant Men's Basketball Coach;*  
*Instructor, Physical Education*  
B.S., Springfield College, 2002; M.Ed., 2004.
- NEIL SPELLMAN (2001)  
*Police Officer, Campus Police*  
B.S. Westfield State College
- JASON R. STEELE (1999)  
*Head Women's Varsity Crew Coach and Facilities Coordinator;*  
*Instructor, Physical Education*  
B.A., Emory University, 1994.
- ROSEMARY TAYLOR (2006)  
*Registered Nurse*  
BFA, New York University, 1988;  
BSN, Northeastern University, 1998.
- TOM H. THOMSEN (1986)  
*Director of International Students and Scholars*  
M.S.W., Copenhagen School of Social Work, 1981;  
C.A.G.S., Clark University, 1994.
- ROBERT J. VANDAL (1996)  
*Police Officer, Campus Police*
- DONNA J. WELCH  
*Police Officer, Campus Police*
- EDMOND ZALOOM (1998)  
*Head Football Coach;*  
*Instructor, Physical Education*  
B.S., Cortland State University, 1975;  
M.S., University of Albany, 1980.

**ADMINISTRATORS EMERITI**

- WILLIAM R. GROGAN (1946-1990)  
*Dean of Undergraduate Studies Emeritus and Professor Emeritus*
- ROBERT J. HALL (1956-1990)  
*Professor Emeritus*
- OWEN W. KENNEDY, JR. (1946-1987)  
*Dean of Academic Computing Emeritus and Professor Emeritus*
- DAVID A. LUCHT (1978-)  
*Director Emeritus, Center for Firesafety Studies*
- DONALD N. ZWIEP (1957-1990)  
*Professor and Department Head Emeritus*

**ACADEMIC DEPARTMENT HEADS**

- LTC TERRANCE A. LEARY  
*Air Force Aerospace Studies*
- ERIC W. OVERSTRÖM  
*Biology and Biotechnology*
- YITZHAK MENDELSON (INTERIM)  
*Biomedical Engineering*
- DAVID DiBIASIO  
*Chemical Engineering*
- KRISTIN N. WOBBE (INTERIM)  
*Chemistry and Biochemistry*
- TAHAR EL-KORCHI (INTERIM)  
*Civil and Environmental Engineering*
- MICHAEL A. GENNERT  
*Computer Science*
- FRED J. LOOFT III  
*Electrical and Computer Engineering*
- KATHY A. NOTARIANNI  
*Fire Protection Engineering*
- JAMES P. HANLAN (INTERIM)  
*Humanities and Arts*
- MCRAE C. BANKS  
*Management*
- BOGDAN M. VERNESCU  
*Mathematical Sciences*
- GRETAR TRYGGVASON  
*Mechanical Engineering*
- LTC NORMAND A. GAUTHIER  
*Military Science*
- DANA L. HARMON  
*Physical Education*
- GERMANO S. IANNACCHIONE  
*Physics*
- JAMES K. DOYLE  
*Social Science and Policy Studies*

**FACULTY**

- (As of December 1, 2007)  
*Numerals following name indicate year(s) of initial appointment.*
- Generally, in this listing, faculty with the titles “associate professor” or “professor” are tenured, and with the title “assistant professor” are on the tenure track. Faculty with titles other than these three are full-time but not tenured or tenure track.
- JONATHAN P. ABRAHAM (2004)  
*Actuarial Program Coordinator;*  
*Adjunct Instructor, Mathematical Science*  
B.S. University of Iowa 1980;  
F.S.A., Society of Actuaries 1991.
- DAVID S. ADAMS (1984)  
*Professor, Biology and Biotechnology*  
B.S., Oklahoma State University, 1974;  
M.S., University of Houston, 1976;  
Ph.D., University of Texas, 1979.
- WILLIAM A. B. ADDISON, JR. (1986)  
*Associate Professor of History; Humanities and Arts*  
B.A., University of South Carolina, 1965;  
M.A., University of Virginia, 1967;  
M.Phil., Columbia University, 1974; Ph.D., 1986.
- EMMANUEL O. AGU (2002)  
*Assistant Professor, Computer Science*  
B.Eng., University of Benin, Nigeria, 1994;  
M.S., University of Massachusetts/Amherst, 1996; Ph.D., 2001.
- LEONARD D. ALBANO (1992)  
*Associate Professor, Civil and Environmental Engineering*  
*Associate Professor, Fire Protection Engineering*  
B.S., Tufts University, 1982;  
M.S., Northwestern University, 1983;  
Ph.D., Massachusetts Institute of Technology, 1992, P.E.
- ALBERTO J. AMEAL-PÉREZ (2007)  
*Adjunct Assistant Professor, Humanities and Arts*  
Licenciado en Letras, Facultad de Filosofía y Letras,  
Universidad Nacional de Buenos Aires, 2001;  
M.A., University of Houston, 2004; Ph.D., 2007.
- DIRAN APELIAN (1990)  
*Professor, Mechanical Engineering;*  
*Howmet Professor of Engineering;*  
*Director, Metal Processing Institute*  
B.S., Drexel University, 1968;  
Sc.D., Massachusetts Institute of Technology, 1972.
- PADMANABHAN K. ARAVIND (1984)  
*Professor, Physics, and Associate Head of Department*  
B.S., Delhi University (India), 1971; M.S., 1973;  
Ph.D., Northwestern University, 1980.
- JOSÉ M. ARGÜELLO (1996)  
*Professor, Chemistry and Biochemistry*  
B.S., National University of Cordoba, 1979;  
Ph.D., National University of Rio Cuarto, Argentina, 1986.
- HOLLY K. AULT (1983)  
*Associate Professor, Mechanical Engineering;*  
*Co-Director Design Studio*  
B.S., Worcester Polytechnic Institute, 1974; M.S., 1983;  
Ph.D., 1988.

- M. ENGIN AYTURK (2007)  
*Research Assistant Professor, Chemical Engineering*  
B.S., Middle East Technical University (Turkey), 1999;  
M.S., 2001;  
Ph.D., Worcester Polytechnic Institute, 2007.
- JOSEPH C. BAGSHAW (1984)  
*Professor, Biology and Biotechnology*  
B.A., Johns Hopkins University, 1965;  
Ph.D., University of Tennessee - Oak Ridge Graduate School, 1969.
- WILLIAM A. BALLER (1986)  
*Administrator of History Research Seminars;*  
*Adjunct Assistant Professor of History; Humanities and Arts*  
B.A., Marquette University, 1971;  
M.A., Providence College, 1975;  
M.S., Columbia University, 1976;  
M.A., State University of New York at Albany, 1982;  
Ph.D., Clark University, 1994.
- MCRAE C. BANKS (1995)  
*Professor, Management, and Head of Department*  
*Director, Collaborative for Entrepreneurship and Innovation*  
B.A., Virginia Tech, 1972;  
M.A., Northwestern University, 1973;  
Ph.D., Virginia Tech, 1987.
- ISA BAR-ON (1982)  
*Professor, Mechanical Engineering*  
B.S., Hebrew University of Jerusalem, 1974;  
M.S., 1977; Ph.D., 1984.
- JOHN A. BERGENDAHL (2000)  
*Associate Professor, Civil and Environmental Engineering*  
*Associate Professor, Chemical Engineering*  
B.S., University of Connecticut, 1985; M.S., 1996;  
Ph.D., 1998.
- FREDERICK BIANCHI (1994)  
*Professor of Music; Humanities and Arts*  
B.A., Cleveland State University, 1980;  
M.S., Ball State University, 1982; Ph.D., 1985.
- KRISTEN L. BILLIAR (2002)  
*Assistant Professor, Biomedical Engineering*  
*Assistant Professor, Mechanical Engineering*  
B.S., Cornell University, 1991;  
M.S., University of Pennsylvania, 1992; Ph.D., 1998.
- STEPHEN J. BITAR (1994)  
*Program Coordinator and Adjunct Instructor, Electrical and Computer Engineering*  
B.S., Worcester Polytechnic Institute, 1985; M.S., 1995.
- MARCEL Y. BLAIS (2005)  
*Visiting Assistant Professor, Mathematical Sciences*  
B.S., Fairfield University, 1999;  
Special Masters, Cornell University, 2003.
- JOHN J. BLANDINO (2001)  
*Associate Professor, Mechanical Engineering*  
B.S., Rensselaer Polytechnic Institute, 1987;  
M.S., Massachusetts Institute of Technology, 1989;  
Ph.D., California Institute of Technology, 2001.
- YEVGENIY BOGDANOV (2002)  
*Research Assistant Professor, Bioengineering Institute*  
B.S., Worcester Polytechnic Institute, 1997; M.S., 1998;  
Ph.D., 2002.
- SGT. MICHAEL E. BORING (2007)  
*Assistant Professor, Military Science*
- JOEL J. BRATTIN (1990)  
*Professor of English; Humanities and Arts*  
A.B., University of Michigan, 1978;  
Ph.D., Stanford University, 1985.
- ULRIKE BRISSON (2006)  
*Visiting Assistant Professor;*  
*Administrator of German Studies, Humanities and Arts*  
B.S., University of Hannover -Germany;  
M.A., The Pennsylvania State University, 1995;  
Ph.D., The Pennsylvania State University, 2000.
- CHRISTOPHER A. BROWN (1989)  
*Professor, Mechanical Engineering*  
B.A., University of Vermont, 1975;  
M.S., 1979; Ph.D., 1983.
- DAVID C. BROWN (1980)  
*Professor, Computer Science; Professor, Mechanical Engineering*  
B.S., North Staffordshire Polytechnic, 1970;  
M.S., University of Kent at Canterbury, 1974;  
M.S., Ohio State University, 1976; Ph.D., 1984.
- DONALD R. BROWN (2000)  
*Associate Professor, Electrical and Computer Engineering*  
B.S., University of Connecticut, 1992; M.S., 1996;  
Ph.D., Cornell University, 2000.
- MICHAEL A. BUCKHOLT (2001)  
*Biology Laboratory Instructor and Director, Biology and Biotechnology Project Labs;*  
*Adjunct Assistant Professor, Biology and Biotechnology*  
B.S., The Pennsylvania State University, 1987;  
Ph.D., Worcester Polytechnic Institute, 1992.
- STEVEN C. BULLOCK (1989)  
*Professor of History; Humanities and Arts*  
B.A., Houghton College, 1978;  
M.A., SUNY-Binghamton, 1980;  
A.M., Brown University, 1982; Ph.D., 1986.
- CORINNE G. B. BURGOS (2005)  
*Visiting Assistant Professor, Mathematical Sciences*  
B.S., De La Salle University (Philippines), 1991; M.S., 1994;  
Ph.D., University of the Philippines/Los Banós, 2002.
- NANCY A. BURNHAM (2000)  
*Associate Professor, Physics*  
B.A., Colgate University, 1980;  
M.S., University of Colorado, 1985; Ph.D., 1987.
- TERRI ANNE CAMESANO (2000)  
*Associate Professor, Chemical Engineering*  
*Associate Professor, Civil and Environmental Engineering*  
B.S., University of Rochester, 1995;  
M.S., University of Arizona, 1997;  
Ph.D., Pennsylvania State University, 2000.

- FABIO CARRERA (1991)  
*Director of Boston and Venice Project Centers;*  
*Adjunct Assistant Professor, Interdisciplinary and*  
*Global Studies Division*  
B.S., Worcester Polytechnic Institute, 1984; M.S., 1996;  
Ph.D., Massachusetts Institute of Technology, 2004.
- MSG SERAFIN M. CASCALHEIRA (2006)  
*Senior Military Instructor, Military Science*
- PETER R. CHRISTOPHER (1963)  
*Professor, Mathematical Sciences*  
A.B., Clark University, 1959; M.A., 1963; Ph.D., 1982.
- MICHAEL J. CIARALDI (1999)  
*Professor of Practice, Computer Science*  
B.A., Cornell University, 1973;  
M.S., Rochester Institute of Technology, 1979;  
M.S., University of Rochester, 1983.
- EDWARD A. CLANCY (2000)  
*Associate Professor, Electrical and Computer Engineering*  
*Associate Professor, Biomedical Engineering*  
B.S., Worcester Polytechnic Institute, 1983;  
M.S., Massachusetts Institute of Technology, 1987;  
Ph.D., 1991.
- CONSTANCE A. CLARK (2006)  
*Assistant Professor, Humanities and Arts*  
B.S., State University of New York/Stony Brook, 1978;  
M.A., University of Colorado/Boulder, 1996; Ph.D., 2002.
- WILLIAM M. CLARK (1986)  
*Associate Professor, Chemical Engineering*  
B.S., Clemson University, 1979;  
Ph.D., Rice University, 1984.
- MARK L. CLAYPOOL (1998)  
*Associate Professor, Computer Science;*  
*Director, Interactive Media and Game Development*  
B.A., Colorado College, 1990;  
M.S., University of Minnesota, 1993; Ph.D., 1996.
- KEVIN A. CLEMENTS (1970)  
*Professor, Electrical and Computer Engineering*  
B.E.E., Manhattan College, 1963;  
M.S., Polytechnic Institute of Brooklyn, 1966; Ph.D., 1970.
- EBEN C. COBB (1995)  
*Visiting Assistant Professor, Mechanical Engineering*  
B.S., Norwich University, 1977;  
M.S., University of Wisconsin, 1978;  
M.S., Boston University, 1981;  
Ph.D., University of Connecticut, 1985.
- ROBERT E. CONNORS (1976)  
*Professor, Chemistry and Biochemistry,*  
*and Associate Head of Department*  
B.S., University of Massachusetts, 1967;  
Ph.D., Northeastern University, 1972.
- THEODORE C. CRUSBERG (1969)  
*Associate Professor, Biology and Biotechnology*  
B.A., University of Connecticut, 1963;  
M.S., Yale University, 1964;  
Ph.D., Clark University, 1968.
- DAVID CYGANSKI (1976)  
*Professor, Electrical and Computer Engineering;*  
*Associate Director, Robotics Engineering Program*  
B.S., Worcester Polytechnic Institute, 1975;  
M.S., 1976; Ph.D., 1981.
- ERWIN DANNEELS (2000)  
*Associate Professor, Management*  
B.A., University of Ghent (Belgium), 1990; M.B.A., 1991;  
M.S., University of California/Davis, 1994;  
Ph.D., Pennsylvania State University, 1998.
- RAVINDRA DATTA (1998)  
*Professor, Chemical Engineering*  
B.T., Indian Institute of Technology (India), 1972;  
Ph.D., University of California, 1981.
- PAUL W. DAVIS (1970)  
*Professor, Mathematical Sciences*  
B.S., Rensselaer Polytechnic Institute, 1966;  
M.S., 1967; Ph.D., 1970.
- MAJ. ROBERT G. DAVIS  
*Assistant Professor, Aerospace Studies*  
B.A., Fayetteville State University, 1993.
- JOHN F. DELOREY (2001)  
*Director of Choral Music;*  
*Adjunct Instructor, Humanities and Arts*  
B.A., Vassar College, 1981;  
M.M., The Boston Conservatory, 2003.
- NICHOLAS A. DEMBSEY (1995)  
*Associate Professor, Fire Protection Engineering*  
B.S., University of Michigan, 1986  
M.S., University of California at Berkeley, 1988; Ph.D., 1995.
- MICHAEL A. DEMETRIOU (1997)  
*Associate Professor, Mechanical Engineering*  
B.S., University of Southern California, 1987; M.S., 1989;  
M.S., 1990; Ph.D., 1993.
- CHRYSANTHE DEMETRY (1993)  
*Associate Professor, Mechanical Engineering;*  
*Director, Center for Educational Development and Assessment*  
*(CEDA)*  
B.S., Worcester Polytechnic Institute, 1988;  
Ph.D., Massachusetts Institute of Technology, 1993.
- JAMES DEMPSEY (2004)  
*Administrator of Literary Studies;*  
*Adjunct Instructor, Humanities and Arts*  
B.A., University of Liverpool (U.K.), 1976;  
M.A., Clark University, 1978.
- DECLAN G. DE PAOR (2005)  
*Adjunct Assistant Professor, Physics*  
B.S., National University of Ireland/Dublin, 1973;  
M.S., National University of Ireland/Cork, 1976; Ph.D., 1981.
- DAVID DIBIASIO (1980)  
*Associate Professor, Chemical Engineering,*  
*and Head of Department*  
B.S., Purdue University, 1972; M.S., 1977; Ph.D., 1980.
- FRANK A. DICK (2007)  
*Adjunct Assistant Professor, Physics*  
B.S., University of Texas/San Antonio, 1984;  
M. S., Worcester Polytechnic Institute, 2005; Ph.D., 2007.



- MIKHAIL F. DIMENTBERG (1994)  
*Professor, Mechanical Engineering*  
M.S.C., Moscow Institute of Power Engineering, 1958;  
Ph.D., 1963; Doctor of Technical Sciences, 1971.
- JAMES P. DITTAMI (1985)  
*Professor, Chemistry and Biochemistry*  
B.A., College of The Holy Cross, 1975;  
M.S., Boston College, 1978;  
Ph.D., Rensselaer Polytechnic Institute, 1983.
- ANTHONY G. DIXON (1980)  
*Professor, Chemical Engineering*  
B.S., Edinburgh University, 1975; Ph.D., 1978.
- SOUSSAN DJAMASBI (2004)  
*Assistant Professor, Management*  
B.S., Christian Albert University (Germany), 1988;  
M.S., University of New Mexico, 1991;  
Ph.D., University of Hawaii, 2004.
- DAVID B. DOLLENMAYER (1990)  
*Professor of German; Humanities and Arts*  
B.A., Princeton University, 1967; Ph.D., 1977.
- DANIEL J. DOUGHERTY (2002)  
*Professor, Computer Science*  
B.A., University of Maryland, 1974; Ph.D., 1982.
- JAMES K. DOYLE (1992)  
*Associate Professor, Social Science and Policy Studies,  
and Head of Department*  
B.A., University of California/Berkeley, 1982;  
M.A., University of Colorado/Boulder, 1990; Ph.D., 1991.
- R. JAMES DUCKWORTH (1987)  
*Associate Professor, Electrical and Computer Engineering*  
B. Eng., Bradford University, 1981;  
Ph.D., Nottingham University, 1984.
- JOSEPH B. DUFFY (2006)  
*Associate Professor, Biology and Biotechnology*  
B.S., Cornell University, 1987;  
Ph.D., University of Texas, 1992.
- BETHEL L. EDDY (2007)  
*Assistant Professor of Religion, Humanities and Arts*  
B.S., Northeast Louisiana University, 1978;  
M.A., University of North Carolina/Greensboro, 1992;  
M.A., Princeton University, 1995; Ph.D., 1998.
- TAHAR EL-KORCHI (1987)  
*Professor, Civil and Environmental Engineering,  
and Interim Head of Department*  
B.S., University of New Hampshire, 1980,  
M.S., 1982; Ph.D., 1986.
- MICHAEL B. ELMES (1990)  
*Professor, Management*  
B.S., Union College, 1975;  
M.A., Colgate University, 1979;  
Ph.D., Syracuse University, 1989.
- ALEXANDER E. EMANUEL (1974)  
*Professor, Electrical and Computer Engineering*  
B.S., Technion, Israel Institute of Technology (Haifa), 1963;  
M.S., 1965; D.Sc., 1969. P.E.
- MICHELLE EPHRAIM (1999)  
*Associate Professor of English; Humanities and Arts*  
B.A., Tufts University, 1991;  
M.A., University of Wisconsin, Madison, 1993; Ph.D., 1998.
- RICHARD G. FALCO (1979)  
*Director of Jazz Studies; Humanities and Arts*  
B.A., University of Massachusetts, 1989;  
M.A., Clark University, 1992.
- JOSEPH FARBROOK (2001)  
*Assistant Professor, Humanities and Arts*  
B.A., University of Colorado/Boulder, 2001; M.F.A., 2004.
- WILLIAM W. FARR (1989)  
*Associate Professor, Mathematical Sciences*  
B.S., University of California - Davis, 1975;  
M.A., University of California - Los Angeles, 1981;  
Ph.D., University of Minnesota, 1986.
- JOSEPH D. FEHRIBACH (1992)  
*Associate Professor, Mathematical Sciences;  
Associate Professor, Chemical Engineering*  
B.A., Centre College, 1980;  
M.A., Duke University 1982; Ph.D., 1985.
- DAVID FINKEL (1988)  
*Professor, Computer Science, and Associate Head of Department*  
B.A., Temple University, 1966;  
M.S., University of Chicago, 1967; Ph.D., 1971.
- KATHRYN FISLER (2000)  
*Associate Professor, Computer Science*  
B.A., Williams College, 1991;  
M.S., Indiana University, 1992; Ph.D., 1996.
- MUSTAPHA S. FOFANA (1997)  
*Associate Professor, Mechanical Engineering*  
B.S./M.S., Budapest Technical University, 1986;  
M.A.S., University of Waterloo, 1989; Ph.D., 1993.
- JEFFREY L. FORGENG (1999)  
*Adjunct Associate Professor of History; Humanities and Arts;  
The Paul S. Morgan Curator, The Higgins Armory Museum*  
B.A., Brown University, 1983;  
M.A., Centre for Medieval Studies, University of Toronto,  
1985; Ph.D., 1991.
- COSME FURLONG-VAZQUEZ (1999)  
*Assistant Professor, Mechanical Engineering*  
B.Eng., University of the Americas, 1989;  
M.S., Worcester Polytechnic Institute, 1992; Ph.D., 1999.
- RAFAEL GARCIA (2003)  
*Assistant Professor, Physics*  
B.A., Cornell University, 1988;  
M.S., Penn State University, 1995; Ph.D., 1999.
- NIKOLAOS A. GATSONIS (1994)  
*Associate Professor, Mechanical Engineering;  
Director, Aerospace Engineering Program  
George F. Fuller Professorship in Mechanical Engineering  
(2007-2010)*  
B.S., Aristotelian University of Thessaloniki, 1983;  
M.S., University Michigan, 1986;  
M.S., Massachusetts Institute of Technology, 1987;  
Ph.D., 1991.

GLENN R. GAUDETTE (2006)

*Assistant Professor, Biomedical Engineering*  
B.S., University of Massachusetts/Dartmouth, 1989;  
M.S., Georgia Institute of Technology, 1992;  
Ph.D., State University of New York/Stony Brook, 2002.

LTC NORMAND A. GAUTHIER (2006)

*Professor, Military Science, and Head of Department*  
B.S., Concordia University, 1985;  
M.B.A., Canisius College, 1998.

MICHAEL A. GENNERT (1987)

*Associate Professor, Computer Science, and Head of Department;*  
*Associate Professor, Electrical and Computer Engineering;*  
*Director, Robotics Engineering Program*  
S.M.E.E., S.B.C.S., S.B.E.E., Massachusetts Institute of  
Technology, 1980; Sc.D., 1987.

ARTHUR GERSTENFELD (1976)

*Professor, Management*  
B.M.E., Rensselaer Polytechnic Institute, 1950;  
M.S., Massachusetts Institute of Technology, 1966;  
Ph.D., 1967.

DANIEL G. GIBSON III (1983)

*Assistant Professor, Biology and Biotechnology*  
B.A., Stanford University, 1966;  
M.A., College of William and Mary, 1969;  
Ph.D., Boston University, 1980.

JANICE D. GOBERT (2005)

*Visiting Associate Professor, Social Science and Policy Studies,*  
*and Computer Science*  
B.A., Laurentian University (Canada), 1985;  
M.A., McGill University (Canada), 1989;  
Ph.D., University of Toronto (Canada), 1994.

DOMINIC GOLDING (2007)

*Program Manager/Adjunct Assistant Professor, IGSD*  
B.A., Exeter College, 1981;  
M.A., Clark University, 1986; Ph.D., 1988.

ROGER S. GOTTLIEB (1981)

*Professor of Philosophy, Humanities and Arts*  
B.A., Brandeis University, 1968; Ph.D., 1975.

JOHN GOULET (1993)

*Coordinator, Masters in Mathematics for Educators Program;*  
*Adjunct Assistant Professor, Mathematical Sciences*  
B.S., Worcester Polytechnic Institute, 1973;  
M.S., RPI, 1974; Ph.D., 1976.

DEBORAH E. GRAY (1991)

*Adjunct Instructor of History, Humanities and Arts*  
B.A., Elmira College, 1971;  
M.A., Clark University, 1989.

PHILIP J. GREBINAR (1972)

*Associate Professor, Physical Education and Athletics*  
B.S., State University College at Cortland, 1971; M.S., 1972.

HOSSEIN HAKIM (1984)

*Associate Professor, Electrical and Computer Engineering, and*  
*Associate Head of Department*  
B.S.E.E., Arya Mehr University (Iran), 1975;  
M.S.E.E., Purdue University, 1977; Ph.D., 1982.

MARGARITA HALPINE (2006)

*Adjunct Assistant Professor, Humanities and Arts*  
B.A., College of New Rochelle, 1976;  
M.A., Columbia University, 1980; M. Ph., 1984;  
Ph.D., University of Connecticut, 1995.

GLYNIS M. HAMEL (1991)

*Teaching Assistant Coordinator;*  
*Adjunct Instructor, Computer Science*  
B.S., University of Lowell, 1977;  
M.S., Worcester Polytechnic Institute, 1986.

JAMES P. HANLAN (1975)

*Professor of History; Humanities and Arts,*  
*and Interim Head of Department*  
A.B., College of the Holy Cross, 1967;  
M.A., Clark University, 1971; Ph.D., 1979.

PETER H. HANSEN (1992)

*Associate Professor of History; Humanities and Arts*  
B.A., Carleton College, 1984;  
M.A., Harvard University, 1986; Ph.D., 1991.

FREDERICK L. HART (1974)

*Professor, Civil and Environmental Engineering*  
B.S.E., University of Connecticut, 1969;  
M.S., 1971; Ph.D., 1974.

GEORGE HEATON (1986)

*Adjunct Associate Professor, Management;*  
*Adjunct Associate Professor, Social Science and Policy Studies*  
B.S., University of Pennsylvania, 1969;  
J.D., Boston University, 1974.

NEIL T. HEFFERNAN (2002)

*Assistant Professor, Computer Science*  
B.A., Amherst College, 1993;  
M.S., Carnegie Mellon University, 1998; Ph.D., 2001.

DESTIN HEILMAN (2006)

*Visiting Assistant Professor, Chemistry and Biochemistry*  
B.S., The Pennsylvania State University, 2000;  
Ph.D., University of Massachusetts Medical School, 2006.

GEORGE T. HEINEMAN (1996)

*Associate Professor, Computer Science*  
B.A., Dartmouth College;  
M.S., Columbia University; Ph.D., 1996.

ARTHUR C. HEINRICHER, JR. (1992)

*Professor, Mathematical Sciences*  
B.S., University of Missouri/St. Louis, 1980;  
Ph.D., Carnegie Mellon University, 1986.

MICHAEL F. HENRY (2007)

*Research Professor, Mechanical Engineering*  
B.S., Northeastern University, 1965;  
M.S., Massachusetts Institute of Technology, 1967;  
Sc.D., Rensselaer Polytechnic Institute, 1974.

HUONG NGO HIGGINS (1998)

*Associate Professor, Management*  
B.A., (French), University of Ho Chi Minh City, 1990;  
B.A., (English), 1990;  
M.A., Georgia State University, 1996; Ph.D., 1998.

- LORRAINE D. HIGGINS (2003)  
*Associate Professor of English; Humanities and Arts;*  
*Director of the Center for Communication Across the Curriculum*  
B.A., Carnegie Mellon University, 1985; M.A., 1991;  
Ph.D., 1992.
- ALLEN H. HOFFMAN (1970)  
*Professor, Mechanical Engineering*  
B.S., Worcester Polytechnic Institute, 1963; M.S., 1967;  
Ph.D., University of Colorado, 1970. P.E.
- MICHA HOFRI (1998)  
*Professor, Computer Science*  
B.S., Technion-IIT (Haifa), 1964; M.S., 1965; D.Sc., 1972.
- ZHIKUN HOU (1991)  
*Professor, Mechanical Engineering*  
B.S., Fudan University, 1974;  
M.S., Tongji University, 1981;  
M.S., California Institute of Technology, 1986; Ph.D., 1990.
- VOLODYMYR HRYNKIV (2006)  
*Visiting Assistant Professor, Mathematical Sciences*  
Diploma of Specialist (Physics), Lviv State University  
(Ukraine) 1994;  
M.S., Tennessee Technological University, 2000;  
Ph.D., University of Tennessee, 2006.
- XIN-MING HUANG (2006)  
*Assistant Professor, Electrical and Computer Engineering*  
B.S., Northwestern Polytechnic University (China), 1994;  
M.Eng., 1996;  
Ph.D., Virginia Polytechnic Institute and State University, 2001.
- DANA L. HUDSON (2006)  
*Assistant Professor, Military Science*  
B.S., Ohio University, 1999.
- MAYER HUMI (1971)  
*Professor, Mathematical Sciences*  
B.S., Hebrew University of Jerusalem, 1963; M.S., 1964;  
Ph.D., Weizmann Institute of Science, 1969.
- VELVEL S. HUSHWATER (2006)  
*Adjunct Assistant Professor, Physics*  
M.S., Moscow Institute of Electronic Engineering;  
Ph.D., University of Maryland.
- ISLAM I. HUSSEIN (2006)  
*Assistant Professor, Mechanical Engineering*  
B.S., American University in Cairo (Egypt), 2000;  
M.S., University of Michigan, 2002; Ph.D., 2005.
- GERMANO S. IANNACCHIONE (1998)  
*Associate Professor, Physics, and Head of Department*  
B.S., University of Akron, 1987; M.S., 1990;  
Ph.D., Kent State University, 1993.
- SUSAN M. JARVIS (2005)  
*Adjunct Instructor, Electrical and Computer Engineering*  
B.S., University of Massachusetts/Dartmouth, 1985;  
M.S., 1987.
- STEPHEN N. JASPERSON (1970)  
*Professor, Physics*  
B.S., University of Wisconsin, 1963;  
M.A., Princeton University, 1965; Ph.D., 1968.
- PARAMASIVAM JAYACHANDRAN (1977)  
*Associate Professor, Civil and Environmental Engineering*  
B.E., University of Madras (India), 1966;  
M.S., University of Wisconsin, 1971; Ph.D., 1975.
- J. SCOTT JUSTO (2004)  
*Assistant Professor, Interdisciplinary and Global Studies Division*  
B.S., Empire State College (SUNY), 1992;  
M.A., University of Albany (SUNY), 1998;  
Ph.D., Clark University, 2004.
- SHARON A. JOHNSON (1988)  
*Associate Professor, Management;*  
*Director of Industrial Engineering Program*  
B.S., University of Michigan, 1983;  
M.S., Cornell University, 1986; Ph.D., 1989.
- CHICKERY J. KASOUF (1990)  
*Associate Professor, Management*  
B.A., Providence College, 1975;  
M.B.A., Syracuse University, 1985; Ph.D., 1991.
- ROBERT N. KATZ (1990)  
*Research Professor, Mechanical Engineering*  
B.S., Massachusetts Institute of Technology, 1961;  
M.S., University of Michigan, 1963;  
Ph.D., Massachusetts Institute of Technology, 1969.
- NIKOLAOS KAZANTZIS (2001)  
*Associate Professor, Chemical Engineering*  
B.S., University of Thessaloniki, Greece, 1990;  
M.S., University of Michigan, 1992; M.S.E., 1993;  
Ph.D., 1997.
- THOMAS H. KEIL (1967)  
*Professor, Physics*  
B.S., California Institute of Technology, 1961;  
Ph.D., University of Rochester, 1965.
- RYUNG SUK KIM (2006)  
*Assistant Professor, Mathematical Sciences*  
B.S., Seoul National University (Korea), 2000;  
Ph.D., Harvard University, 2005.
- ROBERT E. KINICKI (1978)  
*Professor, Computer Science*  
B.S., Case Western Reserve University, 1968;  
M.S., Indiana University, 1975;  
Ph.D., Duke University, 1978.
- ANDREW G. KLEIN (2007)  
*Assistant Professor, Electrical and Computer Engineering*  
B.S., Cornell University, 1998; Ph.D., 2005;  
M.S., University of California/Berkeley, 2000.
- STEPHEN A. KOEHLER (2007)  
*Assistant Professor, Physics*  
B.S., University of Michigan, 1989;  
Ph.D., University of Chicago, 1997.
- CAROLANN KOLECI (2001)  
*Assistant Professor, Physics*  
B.S., State University of New York/Albany, 1994;  
M.S., Brown University, 1996; M.S., 1998; Ph.D., 2001.
- J. ROBERT KRUEGER (2004)  
*Assistant Professor, Interdisciplinary and Global Studies Division*  
B.S., Oklahoma State University, 1991;  
M.S.L., Vermont Law School, 1992;  
M.A., Clark University, 1998; Ph.D., 2004.

- UMA T. KUMAR (1996)  
*Senior Laboratory Instructor, Chemistry and Biochemistry*  
Ph.D., University of Cincinnati, 1993.
- ROBERT C. LABONTÉ (1997)  
*Professor of Practice, Electrical and Computer Engineering*  
B.S., Worcester Polytechnic Institute, 1954; M.S., 1960.
- DIANA A. LADOS (2006)  
*Assistant Professor, Mechanical Engineering*  
B.S./M.S., Polytechnic University of Bucharest, 1997;  
M.S., Southern Illinois University, 1999;  
Ph.D., Worcester Polytechnic Institute, 2004.
- CHRISTOPHER R. LAMBERT (2001)  
*Research Associate Professor, Bioengineering Institute*  
B.S., University College (Wales), 1979;  
Ph.D., Paisley College of Technology (Scotland), 1983.
- CHRISTOPHER J. LARSEN (1996)  
*Associate Professor, Mathematical Sciences*  
B.S., Carnegie Mellon University, 1989;  
J.D., University of Maryland School of Law, 1992;  
M.S., Carnegie Mellon University; Ph.D., 1996.
- LTC TERRANCE A. LEARY (2006)  
*Professor, Air Force Aerospace Studies, and Head of Department*  
B.S., U.S. Air Force Academy, 1986;  
M.S., George Washington University, 1988.
- CHANG H. LEE (2006)  
*Visiting Assistant Professor, Mathematical Sciences*  
B.S., Korea University, 1997; M.S., 2000;  
M.S., University of Minnesota, 2005; Ph.D., 2006.
- STEPHEN J. LEMIRE (2007)  
*Distinguished Academic Visitor; Executive Director of the  
National Professional Science Masters Association (NPSMA),  
Mathematical Sciences*  
B.S., University of Lowell, 1985; M.S., 1987.
- JIANYU LIANG (2004)  
*Assistant Professor, Mechanical Engineering*  
B.S., Central South University (China), 1995; M.E., 1998;  
Ph.D., Brown University, 2004.
- ROBERT W. LINDEMAN (2005)  
*Assistant Professor, Computer Science*  
B.A., Brandeis University, 1987;  
M.S., University of Southern California, 1992;  
D.Sc., The George Washington University, 1999.
- KENT P. LJUNGQUIST (1977)  
*Professor of English, Humanities and Arts*  
B.A., Clark University, 1970;  
M.A., University of Connecticut, 1972;  
Ph.D., Duke University, 1975.
- ELEANOR T. LOIACONO-COLLA (2000)  
*Associate Professor, Management*  
B.A., Boston University, 1992;  
M.B.A., Boston College, 1996;  
Ph.D., University of Georgia, 2000.
- FRED J. LOOFT III (1980)  
*Professor, Electrical and Computer Engineering, and Head of  
Department; Professor, Biomedical Engineering;  
Professor, Mechanical Engineering*  
B.S., University of Michigan, 1973; M.S., 1974, 1976;  
Ph.D., 1979.
- WENJING LOU (2003)  
*Assistant Professor, Electrical and Computer Engineering;  
Joseph Samuel Satin Distinguished Fellowship (2006-2007)*  
B.E., Xi'an Jiaotong University, 1993; M.E., 1996;  
M.A. Sc., Nanyang Technological University, 1998;  
Ph.D., University of Florida, 2003.
- JIACAI LU (2006)  
*Research Assistant Professor, Mechanical Engineering*  
B.S., Xi'an Jiaotong University (China), 1994; Ph.D., 1999.
- REINHOLD LUDWIG (1986)  
*Professor, Electrical and Computer Engineering;  
Professor, Biomedical Engineering;  
Professor, Mechanical Engineering*  
Diplom-Ingenieur, University of Wuppertal  
(West Germany), 1983;  
Ph.D., Colorado State University, 1986.
- ROGER YIN-MAN LUI (1983)  
*Professor, Mathematical Sciences*  
B.S., University of Minnesota, 1975; Ph.D., 1981.
- TAO LUO (2007)  
*Associate Professor, Mathematical Sciences*  
B.S., Xiamen University (China), 1987;  
M.S., Guizhou University (China), 1992;  
Ph.D., Chinese Academy of Science, 1995.
- KONSTANTIN A. LURIE (1989)  
*Professor, Mathematical Sciences*  
M.Sc., Leningrad Polytechnical Institute (USSR), 1959;  
Ph.D., A.F. Ioffe Physical-Technical Institute, Academy of  
Sciences (USSR), 1964; D.Sc., 1972.
- JAMES M. LYNEIS (2002)  
*Professor of Practice, Social Science and Policy Studies*  
S.B., Massachusetts Institute of Technology, 1971;  
Ph.D., University of Michigan, 1974.
- YI H. MA (1967)  
*Professor, Chemical Engineering  
Frances B. Manning Professorship*  
B.S., National Taiwan University, 1959;  
M.S., University of Notre Dame, 1963;  
Sc.D., Massachusetts Institute of Technology, 1967.
- JOHN C. MACDONALD (2001)  
*Associate Professor, Chemistry*  
B.A., Bowdoin College, 1987;  
Ph.D., University of Minnesota, 1993.
- TUCKER P. MAHONEY (2007)  
*Assistant Professor, Military Science*  
B.S., U.S. Military Academy/West Point, 2002.
- SERGEY N. MAKAROV (2000)  
*Associate Professor, Electrical and Computer Engineering*  
M.S., St. Petersburg State University (Russia), 1982;  
Ph.D., 1986.
- MAKHLOUF M. MAKHLOUF (1989)  
*Professor, Mechanical Engineering;  
Director, Aluminum Casting Research Laboratory*  
B.S., American University (Cairo), 1978;  
M.S., New Mexico State University, 1981;  
Ph.D., Worcester Polytechnic Institute, 1989.

- RAJIB B. MALLICK (1998)  
*Associate Professor, Civil & Environmental Engineering*  
B.S., Jadavpur University (India), 1989;  
M.S., Auburn University, 1993; Ph.D., 1997.
- MURALI MANI (2003)  
*Assistant Professor, Computer Science*  
B.Tech., Indiana Institute of Technology, 1998;  
M.S., University of California, 2000; Ph.D., 2003.
- MD. MANIRUZZAMAN (2003)  
*Research Assistant Professor, Mechanical Engineering*  
B.S., Bangladesh University of Engineering and  
Technology, 1987; M.S., 1989;  
M.S., Tuskegee University, 1995;  
Ph.D., Worcester Polytechnic Institute, 2000.
- WILLIAM J. MARTIN (2000)  
*Associate Professor, Mathematical Sciences;*  
*Associate Professor, Computer Science*  
B.A., State University of New York/Potsdam, 1986;  
M.A., 1986; Ph.D., University of Waterloo (Canada), 1992.
- JUN MASAMUNE (2006)  
*Visiting Assistant Professor, Mathematical Sciences*  
M.S., Tohoku University (Japan), 1997; Ph.D., 1999.
- PAUL P. MATHISEN (1993)  
*Professor, Civil and Environmental Engineering*  
B.S., University of Massachusetts, 1984;  
S.M., Massachusetts Institute of Technology, 1989;  
Ph.D., 1993.
- LAUREN M. MATHEWS (2003)  
*Assistant Professor, Biology and Biotechnology*  
B.A., Connecticut College, 1996;  
Ph.D., University of Louisiana/Lafayette, 2001.
- INGRID E. MATOS-NIN (2003)  
*Administrator of Hispanic Studies and Activities;*  
*Adjunct Assistant Professor, Humanities and Arts*  
B.A., Universidad de Puerto Rico/Mayaguez, 1981;  
B.A., Pontificia Universidad Católica de Puerto Rico, 1984;  
M.A., 1988; B.S., 1997;  
Ph.D., Boston University, 2004.
- W. GRANT MCGIMPSEY (1989)  
*Professor, Chemistry and Biochemistry;*  
*Director, Bioengineering Institute;*  
*Associate Provost for Research and Graduate Studies ad Interim*  
B.S., Brock University (Canada), 1978; M.S., 1981;  
Ph.D., Queen's University (Canada), 1985.
- JOHN A. MC NEILL (1994)  
*Associate Professor, Electrical and Computer Engineering*  
A.B., Dartmouth College, 1983;  
M.S., University of Rochester, 1991;  
Ph.D., Boston University, 1994.
- BRIAN J. MEACHAM (2007)  
*Associate Professor, Fire Protection Engineering*  
B.S., Worcester Polytechnic Institute, 1984; M.S., 1991;  
Ph.D., Clark University, 2000.
- YITZHAK MENDELSON (1983)  
*Associate Professor, Biomedical Engineering and*  
*Interim Department Head*  
B.S., State University of New York at Buffalo, 1975; M.S., 1976;  
Ph.D., Case Western Reserve University, 1983.
- WILLIAM R. MICHALSON (1992)  
*Professor, Electrical and Computer Engineering;*  
*Professor, Computer Science*  
B.S. E.E., Syracuse University, 1981;  
M.S., Worcester Polytechnic Institute, 1985; Ph.D., 1989.
- FABIENNE MILLER (2007)  
*Assistant Professor, Management*  
M.M., Ecole de Management de Lyon, 1985;  
M.P.A., Montana State University, 1998;  
Ph.D., Michigan State University, 2007.
- JAMIE P. MONAT (2004)  
*Director, Executive Education;*  
*Adjunct Assistant Professor of Management, Corporate and*  
*Professional Education*  
B.S., Princeton University, 1973;  
M.S., Stanford University, 1974; Ph.D., 1978.
- UMBERTO MOSCO (2005)  
*Professor, Mathematical Sciences;*  
*Harold J. Gay Professorship in Mathematics*  
Laurea in Mathematical Sciences, University of Rome, 1959;  
Laurea in Physics, University of Rome, 1961;  
Libera Docenza in Mathematical Methods in Physics, Italy, 1967.
- WESLEY T. MOTT (1987)  
*Professor of English; Humanities and Arts*  
A.B., Boston University, 1968; A.M., 1969; Ph.D., 1974.
- KANKANA MUKHERJEE (2002)  
*Assistant Professor, Mechanical Engineering*  
B.A., North Eastern Hill University (India), 1983; MA, 1985;  
M.Phil., 1989;  
M.A., University of Connecticut, 1992; Ph.D., 1997.
- BALGOBIN NANDRAM (1989)  
*Professor, Mathematical Sciences*  
B.Sc., University of Guyana, 1977, Dip. Ed., 1979;  
M.Sc., University of London, Imperial College, 1981;  
Ph.D., University of Iowa, 1989.
- SVETLANA NIKITINA (2004)  
*Adjunct Assistant Professor, Humanities and Arts*  
B.A./M.A., Moscow University (Russia), 1984; Ph.D., 1988;  
Ed.M., Harvard University, 1999.
- ROBERT L. NORTON (1981)  
*Professor, Mechanical Engineering*  
B.S., Northeastern University, 1967;  
M.S., Tufts University, 1970. P.E.
- KATHY A. NOTARIANNI  
*Associate Professor, Fire Protection Engineering, and Head of*  
*Department; Associate Professor, Mechanical Engineering*  
B.S., Worcester Polytechnic Institute, 1986; M.S., 1989;  
M.S., Carnegie Mellon University, 1997; Ph.D., 2000.
- JOHN T. O'CONNOR (1970)  
*Professor, Social Science and Policy Studies; Professor, Management*  
A.B., College of the Holy Cross, 1960;  
M.B.A., The Wharton School, 1962;  
Ph.D., University of Notre Dame, 1970;  
M.P.H., Harvard University, 1975.
- DEAN O'DONNELL (1993)  
*Administrator/Instructor of Interactive Media and*  
*Game Development*  
B.S., Worcester Polytechnic Institute, 1986;  
M.F.A., Brandeis University, 1990.

- DAVID J. OLINGER (1990)  
*Associate Professor, Mechanical Engineering*  
B.S., Lafayette College, 1983;  
M.S., Rensselaer Polytechnic Institute, 1985;  
M.S., Yale University, 1988; Ph.M., 1988; Ph.D., 1990.
- JOHN A. ORR (1977)  
*Professor, Electrical and Computer Engineering;*  
*Provost ad Interim and Dean of Undergraduate Studies*  
B.S., University of Illinois, 1969;  
M.S., Stanford University, 1970;  
Ph.D., University of Illinois, 1977.
- JAMES C. O'SHAUGHNESSY (1986)  
*Professor, Civil and Environmental Engineering*  
B.S., University of New Hampshire, 1965;  
M.S., Pennsylvania State University, 1970; Ph.D., 1973.
- ERIC W. OVERSTRÖM (2004)  
*Professor, Biology and Biotechnology, and Head of Department*  
B. A., College at Oswego (SUNY), 1974;  
M.S., University of Massachusetts (Amherst), 1978;  
Ph.D., 1981.
- MAJ. FEDENCIA PAGADUAN (2003)  
*Assistant Professor, Military Science*  
B.S., Santa Clara University, 1989.
- KAVEH PAHLAVAN (1985)  
*Professor, Electrical and Computer Engineering;*  
*Professor, Computer Science*  
M.S., University of Teheran, 1975;  
Ph.D., Worcester Polytechnic Institute, 1979.
- CAPT THEODORE S. PAINTER (2004)  
*Assistant Professor, Military Science; Recruiting Officer*  
B.A., University of Massachusetts (Amherst), 1999.
- E. MALCOLM PARKINSON (1974)  
*Associate Professor of History; Humanities and Arts*  
B.S., Queen's University of Belfast, 1963;  
Ph.D., Belfast, 1966;  
M.A., Princeton University, 1970.
- OLEG V. PAVLOV (2002)  
*Assistant Professor, Social Science and Policy Studies*  
B.S., University of Southern California, 1994; Ph.D., 2000.
- PEDER C. PEDERSEN (1987)  
*Professor, Electrical and Computer Engineering;*  
*Professor, Biomedical Engineering*  
B.S., Aalborg Engineering College, 1971;  
M.E., University of Utah, 1974; Ph.D., 1976.
- CREIGHTON PEET (2000)  
*Program Coordinator/Adjunct Assistant Professor,*  
*Interdisciplinary and Global Studies Division*  
B.A., Harvard College, 1966;  
P.Phil., Columbia University, 1978; Ph.D., 1978.
- JOSEPH D. PETRUCCELLI (1978)  
*Professor, Mathematical Sciences*  
A.B., Boston College, 1971;  
M.S., Purdue University, 1974; Ph.D., 1978.
- ROBERT A. PEURA (1968)  
*Professor, Biomedical Engineering;*  
*Professor, Electrical and Computer Engineering*  
B.S., Worcester Polytechnic Institute, 1964;  
M.S., Iowa State University, 1967; Ph.D., 1969.
- GEORGE D. J. PHILLIES (1985)  
*Professor, Physics*  
S.B., Massachusetts Institute of Technology, 1969, M.S., 1971;  
D.Sc., 1973.
- ROBERTO PIETROFORTE (1992)  
*Associate Professor, Civil and Environmental Engineering*  
Laurea University of Rome, 1974;  
M.S., Massachusetts Institute of Technology, 1987; M.S., 1987;  
Ph.D., 1992.
- GEORGE D. PINS (2000)  
*Associate Professor, Biomedical Engineering*  
B.S., Rutgers College of Engineering, 1989;  
Ph.D., Rutgers University, 1996.
- JEANINE D. PLUMMER (1999)  
*Associate Professor, Civil & Environmental Engineering;*  
*Director, Environmental Engineering*  
B.S., Cornell University, 1993;  
M.S., University of Massachusetts/Amherst, 1995; Ph.D., 1999.
- SAMUEL M. POLITZ (1988)  
*Associate Professor, Biology and Biotechnology*  
B.S., Louisiana State University, 1973;  
Ph.D., University of California at Los Angeles, 1978.
- GARY F. POLLICE (2002)  
*Professor of Practice, Computer Science*  
B.A., Rutgers University, 1973;  
M.S., University of Massachusetts/Lowell, 1994.
- REETA PRUSTY RAO (2005)  
*Assistant Professor, Biology and Biotechnology*  
B.S., Birla Institute of Technology and Science (India), 1991;  
M.S., Drexel University, 1994;  
Ph.D., Penn State University Medical College, 1999.
- RYSZARD J. PRYPUTNIEWICZ (1978)  
*Professor, Mechanical Engineering; Professor,*  
*Electrical and Computer Engineering;*  
*Kenneth G. Merriam Distinguished Professorship*  
B.S., University of Hartford, 1972;  
M.S., University of Connecticut, 1974; Ph.D., 1976. P.E.
- RICHARD S. QUIMBY (1982)  
*Associate Professor, Physics*  
B.S., Clarkson College of Technology, 1975;  
Ph.D., University of Wisconsin at Madison, 1979.
- MICHAEL J. RADZICKI (1990)  
*Associate Professor, Social Science and Policy Studies*  
B.A., St. Norbert College, 1979;  
M.A., University of Notre Dame, 1982; Ph.D., 1985.
- L. RAMDAS RAM-MOHAN (1978)  
*Professor, Physics; Professor, Electrical and Computer Engineering*  
B.S., Delhi University (India), 1964;  
M.S., Purdue University, 1967; Ph.D., 1971.

- ALI S. RANGWALA (2006)  
*Assistant Professor, Fire Protection Engineering*  
B.S., Government College of Engineering (India), 2000;  
M.S., University of Maryland, 2002;  
Ph.D., University of California, 2006.
- MALCOLM H. RAY (1998)  
*Professor and White Chair, Civil & Environmental Engineering;*  
*Professor, Mechanical Engineering*  
B.S., University of Vermont, 1983;  
M.S., Carnegie-Mellon University, 1984;  
Ph.D., Vanderbilt University, 1992.
- CHARLES RICH (2007)  
*Professor, Computer Science and Interactive Media and*  
*Game Development*  
B.A. Sc., University of Toronto (Canada), 1973;  
S.M., Massachusetts Institute of Technology, 1975; Ph.D., 1980.
- CAPT. DANIEL RICHARDS (2007)  
*Assistant Professor, Air Force Aerospace Studies*  
B.T., Charleston Southern University, 1999.
- MARK W. RICHMAN (1985)  
*Associate Professor, Mechanical Engineering*  
B.S., State University of New York at Buffalo;  
M.S., University of Michigan, 1979;  
Ph.D., Cornell University, 1983.
- KENT J. RISSMILLER (1988)  
*Associate Dean, Interdisciplinary and Global Studies Division;*  
*Associate Professor, Social Science and Policy Studies*  
A.B., Muhlenberg College, 1976;  
J.D., Franklin Pierce Law Center, 1980;  
M.A., Syracuse University, 1981; Ph.D., 1986.
- ANGEL A. RIVERA (1994)  
*Associate Professor of Spanish; Humanities and Arts*  
B.A., University of Puerto Rico, 1983; M.A., 1987;  
Ph.D., Rutgers University, 1994.
- THOMAS ROBERTSON (2006)  
*Assistant Professor, Humanities and Arts*  
B.A., Williams College, 1989;  
M.A., The University of Wisconsin, 1999; Ph.D., 2005.
- MARSHA W. ROLLE (2007)  
*Assistant Professor, Biomedical Engineering*  
B.S., Brown University, 1995;  
Ph.D., University of Washington, 2003.
- YIMING RONG (1998)  
*Professor, Mechanical Engineering*  
*John Woodman Higgins Professorship in Engineering*  
*(2002-2005) (2005-2008), and*  
*Associate Director of Manufacturing Engineering*  
B.S., Harbin University of Science and Technology (China), 1981;  
M.S., Tsinghua University (China), 1984;  
M.S., University of Wisconsin-Madison, 1987;  
Ph.D., University of Kentucky, 1989.
- JOSHUA P. ROSENSTOCK (2005)  
*Assistant Professor, Humanities and Arts*  
B.A., Brown University, 1996;  
M.F.A., School of Art Institute of Chicago, 2004.
- JENNIFER M. RUDOLPH (2007)  
*Associate Professor of Asian History, Humanities and Arts*  
A.B., University of Chicago, 1985;  
M.A., University of Washington, 1993; Ph.D., 1999.
- CAROLINA RUIZ (1998)  
*Associate Professor, Computer Science*  
B.S., University of Los Andes, Colombia, 1988; B.S., 1989;  
M.S., 1990;  
Ph.D., University of Maryland, 1996.
- JILL RULFS (1990)  
*Associate Professor, Biology and Biotechnology;*  
*and Associate Head of Department;*  
*Pre-Health Professions Advisor*  
B.S., University of Massachusetts, 1973;  
Ph.D., Tufts University, 1982.
- ELKE A. RUNDENSTEINER (1996)  
*Professor, Computer Science*  
B.S., Johann Wolfgang Goethe University, Frankfurt, West  
Germany; M.S., 1984;  
M.S., Florida State University, Irvine, 1992.
- ELIZABETH F. RYDER (1996)  
*Associate Professor, Biology and Biotechnology*  
A.B., Princeton University, 1980;  
M.S., Harvard School of Public Health, 1985;  
Ph.D., Harvard Medical School, 1993.
- KHALID SAEED (1997)  
*Professor, Social Science and Policy Studies*  
B.S., University of Engineering and Technology, Parkistan, 1968;  
M.E., Asian Institute of Technology, Thailand, 1975;  
Ph.D., Massachusetts Institute of Technology, 1981.
- GUILLERMO F. SALAZAR (1983)  
*Associate Professor, Civil and Environmental Engineering*  
B.S., University of La Salle (Mexico), 1971;  
M.Eng., University of Toronto, 1977;  
Ph.D., Massachusetts Institute of Technology, 1983.
- M. DAVID SAMSON (1991)  
*Associate Professor of Art History/Architecture; Humanities and Arts*  
B.A., University of Chicago, 1980;  
Ph.D., Harvard University, 1988.
- JOHN SANBONMATSU (2003)  
*Assistant Professor, Humanities and Arts*  
B.A., Hampshire College, 1984;  
Ph.D., University of California at Santa Cruz, 2000.
- JESSICA T. SANDS (2005)  
*Administrator of Technical Theatre and Adjunct Instructor of*  
*Drama, Humanities and Arts*  
B.S., Worcester Polytechnic Institute, 1998;  
M.A., Emerson College, 2002.
- MARCUS SARKIS (1998)  
*Associate Professor, Mathematical Sciences*  
B.S., Instituto Tecnológico de Aeronáutica (Brazil), 1984;  
M.S., Pontifícia Universidade Católica de Rio de Janeiro  
(Brazil), 1989;  
Ph.D., New York University, 1994.



- BRIAN J. SAVILONIS (1981)  
*Professor, Mechanical Engineering; Professor, Biomedical Engineering; Head Coach, Cross-Country*  
B.S., Worcester Polytechnic Institute, 1972; M.S., 1973;  
Ph.D., State University of New York, 1976.
- HASANJAN SAYIT (2007)  
*Assistant Professor, Mathematical Sciences*  
B.S./M.S., Xinjiang University (China), 1998;  
M.S., Cornell University, 2004; Ph.D., 2005.
- ALFRED A. SCALA (1966)  
*Professor, Chemistry and Biochemistry*  
B.S., Brooklyn College, 1957; M.S., 1961;  
Ph.D., Polytechnic Institute of Brooklyn, 1965.
- LANCE E. SCHACHTERLE (1970)  
*Professor of English; Humanities and Arts;  
Associate Provost for Academic Affairs*  
A.B., Haverford College, 1966;  
A.M., University of Pennsylvania, 1968; Ph.D., 1970.
- JEROME J. SCHAUFELD (2005)  
*Visiting Instructor, Management*  
B.S., New Jersey Institute of Technology;  
M.B.A., Northeastern University.
- STANLEY M. SELKOW (1980)  
*Professor, Computer Science*  
B.S., Carnegie Institute of Technology, 1965;  
M.S., University of Pennsylvania, 1967; Ph.D., 1970.
- BRIGITTE I. SERVATIUS (1987)  
*Professor, Mathematical Sciences*  
Magister der Naturwissenschaften der Universitat Graz,  
Austria, 1978;  
Ph.D., Syracuse University, 1987.
- EUNMI SHIM (2002)  
*Assistant Professor, Humanities and Arts*  
B.M., Seoul National University (Korea), 1987;  
M.M., University of Illinois at Urbana-Champaign, 1993;  
Ph.D., 1999.
- SATYA SHIVKUMAR (1990)  
*Professor, Mechanical Engineering;  
Professor, Biomedical Engineering;  
Russell M. Searle Instructorship in Mechanical Engineering  
(2006-2007)*  
B.S., Regional Engineering College, 1978;  
M.S., Indian Institute of Technology, 1980;  
M.S., Stevens Institute of Technology, 1987; Ph.D., 1987.
- RICHARD D. SISSON, JR. (1976)  
*Professor, Mechanical Engineering, and  
Director of Manufacturing Engineering;*  
B.S., Virginia Polytechnic Institute, 1969;  
M.S., Purdue University, 1971; Ph.D., 1975.
- JEANINE L. SKORINKO (2007)  
*Assistant Professor, Social Science and Policy Studies*  
A.A., Simon's Rock College, 1999;  
B.A., Rice University, 2001;  
M.A., University of Virginia, 2004; Ph.D., 2007.
- RUTH L. SMITH (1983)  
*Associate Professor of Religion; Humanities and Arts*  
B.A., East Tennessee State University, 1969;  
M.A., Ohio University, 1971;  
M.T.S., Harvard University Divinity School, 1976;  
Ph.D., Boston University, 1982.
- CHRISTOPHER H. SOTAK (1988)  
*Professor, Biomedical Engineering;  
Professor, Chemistry & Biochemistry*  
B.A., University of Northern Colorado, 1975; M.A., 1980;  
Ph.D., Syracuse University, 1983;  
M.B.A., Worcester Polytechnic Institute, 1995.
- DAVID I. SPANAGEL (2005)  
*Visiting Assistant Professor, Humanities and Arts*  
B.A., Oberlin College, 1982;  
M.S. Ed., University of Rochester, 1984;  
Ph.D., Harvard University, 1996.
- KENNETH A. STAFFORD (1999)  
*Director, Robotics Program;  
Adjunct Assistant Professor, Mechanical Engineering*  
B.S., Oregon State University, 1973;  
M.S., Air Force Institute of Technology, 1980.
- DIANE M. STRONG (1995)  
*Associate Professor, Management*  
B.S., University of South Dakota, 1974;  
M.S., New Jersey Institute of Technology, 1978;  
M.S., Carnegie Mellon University, 1983;  
Ph.D., Carnegie Mellon University, 1988.
- JOHN M. SULLIVAN, JR. (1987)  
*Professor, Mechanical Engineering;  
Professor, Electrical and Computer Engineering;  
Professor, Biomedical Engineering; Professor, Computer Science*  
B.S., Zoology, University of Massachusetts, 1973;  
B.S., Mec.E., 1977; M.S., Mec.E., 1978;  
Ph.D., Thayer School of Engineering, Dartmouth  
College, 1986.
- BERK SUNAR (2000)  
*Associate Professor, Electrical and Computer Engineering*  
B.S., Middle East Technical University (Turkey), 1995;  
Ph.D., Oregon State University, 1998.
- DALIN TANG (1988)  
*Professor, Mathematical Sciences;  
Professor, Biomedical Engineering*  
B.A., Nanjing Institute of Technology, 1981;  
Ph.D., University of Wisconsin at Madison, 1988.
- MINGJIANG TAO (2007)  
*Assistant Professor, Civil and Environmental Engineering*  
B.S., Fuzhou University (China), 1997;  
M.S., Tongji University (China), 2000;  
Ph.D., Case Western Reserve University, 2003.
- GLORIA J. TASHJIAN (2003)  
*Adjunct Assistant Professor, Mathematical Sciences*  
B.S., University of Massachusetts/Amherst, 1970;  
Ph.D., Wesleyan University, 1975.

- STEVEN S. TAYLOR (2002)  
*Assistant Professor, Management*  
B.S., Massachusetts Institute of Technology, 1982;  
M.A., Emerson College, 1993;  
Ph.D., Boston College, 2000.
- ZHONGZHAO TENG (2007)  
*Research Assistant Professor, Mathematical Sciences*  
B.S., Fudan University (China), 1998; Ph.D., 2003.
- VENKAT R. THALLADI (2002)  
*Assistant Professor, Chemistry and Biochemistry*  
B.S., Kakatiya University (India), 1990; M.S., 1992;  
Ph.D., University of Hyderabad (India), 1998.
- ROBERT W. THOMPSON (1976)  
*Professor, Chemical Engineering*  
B.S., Clarkson Institute of Technology, 1971; M.S., 1973;  
Ph.D., Iowa State University, 1975.
- ROBERT W. TRAVER (2003)  
*Adjunct Assistant Professor; Principal, Massachusetts Academy of Mathematics and Science*  
A.B., Dartmouth College 1975;  
M.S., Purdue University, 1980;  
Grad Diploma, University of Canterbury, NZ, 1981;  
Ed.D., Harvard University, 1991.
- GRÉTAR TRYGGVASON (2000)  
*Professor, Mechanical Engineering, and Head of Department; Associate Director, Robotics Engineering Program*  
B.S., University of Iceland, 1980;  
M.S., Brown University, 1982; Ph.D., 1985.
- BENGISU TULU (2006)  
*Assistant Professor, Management*  
B.S., Middle East Technical University (Turkey), 1997;  
M.S. 2000;  
M.S., Claremont Graduate University, 2003; Ph.D., 2006.
- JAMES D. VAN DE VEN (2007)  
*Assistant Professor, Mechanical Engineering*  
B.S., South Dakota School of Mines and Technology, 2001;  
Ph.D., University of Minnesota, 2006.
- HELEN G. VASSALLO (1982)  
*Professor, Management; Professor, Biology and Biotechnology*  
B.S., Tufts University, 1953; M.S., 1955;  
Ph.D., Clark University, 1967;  
M.B.A., Worcester Polytechnic Institute, 1982.
- RICHARD F. VAZ (1983)  
*Associate Professor, Electrical and Computer Engineering; Dean, Interdisciplinary and Global Studies Division*  
B.S.E.E., Worcester Polytechnic Institute, 1979;  
M.S.E.E., 1984; Ph.D., 1987.
- DOMOKOS VERMES (1990)  
*Associate Professor, Mathematical Sciences*  
M.S. (Electrical), Technische Universitat, 1970;  
M.S. (Mathematics), 1971;  
Ph.D., University of Szeged, 1975.
- BOGDAN M. VERNESCU (1991)  
*Professor, Mathematical Sciences, and Head of Department*  
B.S., University of Bucharest, 1982; M.S., 1982;  
Ph.D., Institute of Mathematics - Bucharest, 1989.
- SUSAN VERNON-GERSTENFELD (1987)  
*Adjunct Professor, Interdisciplinary and Global Studies Division; Director of Academic Programs and Planning for IGSD*  
B.A., Boston University, 1962; M.S.W., 1974;  
Ph.D., Boston College, 1987.
- SUSAN VICK (1981)  
*Professor of Drama/Theatre, and Director of Theatre; Humanities and Arts*  
A.B., Catawba College, 1967;  
M.F.A., Southern Methodist University, 1969;  
Ph.D., University of Illinois, 1979.
- DARKO VOLKOV (2004)  
*Assistant Professor, Mathematical Sciences*  
B.Sc., University of Paris (France), 1993;  
Ph.D., Rutgers University, 2001.
- HOMER F. WALKER (1997)  
*Professor, Mathematical Sciences*  
B.A., Rice University, 1966;  
M.S., New York University, 1968; Ph.D., 1970.
- MATTHEW O. WARD (1986)  
*Professor, Computer Science*  
B.S., Worcester Polytechnic Institute, 1977;  
M.S., University of Connecticut, 1979, Ph.D., 1981.
- PAMELA J. WEATHERS (1979)  
*Professor, Biology and Biotechnology*  
B.S., Marquette University, 1969;  
Ph.D., Michigan State University, 1974.
- DOUGLAS G. WEEKS (1980)  
*Administrator of Applied Music, Humanities and Arts*  
B.S., University of New Hampshire, 1964;  
M.S., Gorham State, 1968;  
M.M., University of Massachusetts., 1970;  
Ed.D., Boston University, 1987.
- SUZANNE L. WEEKES (1998)  
*Associate Professor, Mathematical Sciences, and Associate Head of Department*  
B.S., Indiana University, 1989;  
M.S., University of Michigan, 1990; Ph.D., 1995.
- JOANN WHITEFLEET-SMITH (1995)  
*Senior Laboratory Instructor; Adjunct Assistant Professor, Biology and Biotechnology*  
B.A., Hope College, 1976;  
M.S., Purdue University, 1979;  
Ph.D., University of Wisconsin-Madison, 1984.
- JAYSON D. WILBUR (2002)  
*Assistant Professor, Mathematical Sciences*  
B.S., Worcester Polytechnic Institute, 1997;  
M.S., Purdue University, 2000; Ph.D., 2002.
- JOHN M. WILKES (1975)  
*Associate Professor, Social Science and Policy Studies*  
B.A., Bates College, 1970;  
M.A., Cornell University, 1973; Ph.D., 1976.
- CRAIG E. WILLS (1990)  
*Associate Professor, Computer Science*  
B.S., University of Nebraska, 1982;  
M.S., Purdue University, 1984; Ph.D., 1988.

KRISTIN NELSON WOBBE (1995)

*Associate Professor, Chemistry and Biochemistry, and  
Interim Head of Department*

B.A., St. Olaf College, 1983

Ph.D., Harvard University, 1991

ALEXANDER M. WYGLINSKI (2007)

*Assistant Professor, Electrical and Computer Engineering*

B. Eng., McGill University (Canada), 1998; Ph.D., 2004;

M.S., Queen's University (Canada), 2000.

VADIM V. YAKOVLEV (1999)

*Research Associate Professor, Mathematical Sciences*

M.S., Saratov State University (USSR), 1979; Ph.D., 1984.

WILLIAM W. YU (2007)

*Assistant Professor, Chemistry and Biochemistry*

B.S., Shandong University (China), 1991; M.S., 1994;

Ph.D., Chinese Academy of Sciences, 1997.

Z. AMY ZENG (1999)

*Associate Professor, Management*

B.S., Beijing University of Aeronautics and Astronautics, 1990;

M.S., University of Washington, 1992;

Ph.D., The Pennsylvania State University, 1996.

QINGYANG ZHANG (2002)

*Research Assistant Professor, Bioengineering Institute*

B.S., Shanghai University Industry College, 1981;

M.S., Shanghai University of Technology, 1988;

M.S., Worcester Polytechnic Institute, 1993; Ph.D., 1998.

WANLI ZHAO (2007)

*Assistant Professor Management*

B.S., Harbin Institute of Technology (China), 1993;

M.B.A., Temple University, 2000; Ph.D., 2007.

H. SUSAN ZHOU (2005)

*Assistant Professor, Chemical Engineering;*

*Leonard P. Kinnicutt Professorship (2006-2009)*

B.S., Huazhong University (China), 1996;

M.S., Clarkson University, 1999;

Ph.D., University of California, 2002.

JOE ZHU (1998)

*Associate Professor, Management*

B.M., Huzhou Normal College (China), 1987;

M.S., Southeast University (China), 1992; Ph.D., 1995;

Ph.D., University of Massachusetts, 1998.

ALEX A. ZOZULYA (1998)

*Professor, Physics*

B.S., Moscow Engineering Physical Institute, 1978;

Ph.D., Lebedev Physics Institute of the Academy of Sciences of  
the USSR, 1984.

## FACULTY EMERITI

*Numerals following name indicate years of service.*

ALLEN BENJAMIN (1963-1980)

*Professor Emeritus, Civil Engineering*

LADISLAV H. BERKA (1965-2001)

*Professor Emeritus, Chemistry and Biochemistry*

RONALD R. BIEDERMAN (1968-2004)

*Professor Emeritus, Mechanical Engineering*

VAN F. W. BLUEMEL (1966-1999)

*Professor Emeritus, Physics*

ROY R. BOURGAULT (1955-1985)

*Professor Emeritus, Mechanical Engineering*

JOHN M. BOYD (1966-1994)

*Professor Emeritus, Mechanical Engineering*

GORDON C. BRANCHE (1959-1997)

*Professor Emeritus, Mathematical Sciences*

ELLIOT R. BUELL (1957-1978)

*Professor Emeritus, Mathematics*

A. FATTAH CHALABI (1959-1991)

*Professor Emeritus, Civil Engineering*

RONALD D. CHEETHAM (1973-2006)

*Professor Emeritus, Biology and Biotechnology*

EDWARD N. CLARKE (1965-1994)

*Professor Emeritus*

VINCENT CONNOLLY (1956-1998)

*Professor Emeritus, Mathematical Sciences*

EDMUND T. CRANCH (1978-1985)

*Professor Emeritus and President Emeritus*

LOUIS J. CURRAN, JR. (1966-2004)

*Professor Emeritus, Humanities and Arts*

ROBERT A. D'ANDREA (1974-2005)

*Professor Emeritus, Civil & Environmental Engineering*

FRANK D. DEFALCO (1960-1999)

*Professor Emeritus, Civil & Environmental Engineering*

JAMES S. DEMETRY (1971-2000)

*Professor Emeritus, Electrical & Computer Engineering*

RICHARD D. DESROSIERS (1972-1991)

*Professor Emeritus, Civil Engineering*

WILHELM H. EGGIMANN (1964-1999)

*Professor Emeritus, Electrical & Computer Engineering*

ROBERT W. FITZGERALD (1963-2005)

*Professor Emeritus, Civil & Environmental Engineering and  
Fire Protection Engineering*

MALCOM S. FITZPATRICK (1977-2006)

*Professor Emeritus, Civil & Environmental Engineering*

LEE FONTANELLA (1993-2002)

*Professor and Department Head Emeritus, Humanities and Arts*

LEONARD GOODWIN (1974-1989)

*Professor Emeritus, Social Science and Policy Studies*

HARTLEY T. GRANDIN, JR. (1957-1996)

*Professor Emeritus, Mechanical Engineering*

LEON S. GRAUBARD (1969-2002)

*Professor Emeritus, Management*

- WILLIAM R. GROGAN (1946-1990)  
*Professor Emeritus, Electrical Engineering;  
Emeritus Dean of Undergraduate Studies*
- RAYMOND R. HAGGLUND (1956-2004)  
*Professor Emeritus, Mechanical Engineering*
- ROBERT J. HALL (1956-1990)  
*Professor Emeritus, Mechanical Engineering and  
Management; Former Director of Continuing Education*
- MARY M. HARDELL (1972-1996)  
*Professor Emeritus, Computer Science*
- WILLIAM J. HARDELL (1960-1994)  
*Professor Emeritus, Mathematical Sciences*
- EDMUND M. HAYES (1964-1997)  
*Professor Emeritus, Humanities and Arts*
- CHARLES R. HEVENTHAL (1963-1990)  
*Professor Emeritus, Humanities*
- HAROLD W. HILSINGER (1962-1998)  
*Professor Emeritus, Physics*
- WILLIAM D. HOBAY (1963-2005)  
*Professor Emeritus, Chemistry and Biochemistry*
- OWEN W. KENNEDY, JR. (1946-1987)  
*Professor Emeritus, Electrical Engineering;  
Emeritus Dean of Academic Computing*
- KRISHNASWAMIENGAR KESHAVAN (1967-1998)  
*Professor Emeritus, Civil & Environmental Engineering*
- NICHOLAS K. KILDAHL (1976-2005)  
*Professor Emeritus, Chemistry and Biochemistry*
- WALTER A. KISTLER (1954-1994)  
*Professor Emeritus, Mechanical Engineering*
- DIETER KLEIN (1979-1999)  
*Professor Emeritus, Management*
- MICHAEL W. KLEIN (1979-1995)  
*Professor Emeritus, Physics*
- CARL H. KOONTZ (1952-1986)  
*Professor Emeritus, Civil Engineering*
- H. PETER LANYON (1967-1999)  
*Professor Emeritus, Electrical & Computer Engineering*
- J. J. MALONE (1971-2000)  
*Professor Emeritus, Mathematical Sciences*
- JO ANN MANFRA (1972-2006)  
*Professor Emeritus, Humanities and Arts*
- JOHN A. MAYER (1956-1990)  
*Professor Emeritus, Mechanical Engineering*
- ARCHIE K. MC CURDY (1955-1994)  
*Professor Emeritus, Electrical and Computer Engineering*
- DAVID P. MC KAY (1956-1993)  
*Professor Emeritus, Music*
- BRUCE C. MC QUARRIE (1960-1990)  
*Professor Emeritus, Mathematical Sciences*
- LAURA J. MENIDES (1976-2005)  
*Professor Emeritus, Humanities and Arts*
- WILLIAM B. MILLER (1963-1989)  
*Professor Emeritus, Mathematical Sciences*
- WILLIAM R. MOSER (1981-2000)  
*Professor Emeritus, Chemical Engineering*
- DONALD F. NELSON (1981-2004)  
*Professor Emeritus, Physics*
- MERL M. NORCROSS (1952-1994)  
*Professor Emeritus, Physical Education and Athletics*
- NICHOLAS L. ONORATO (1955-1994)  
*Professor Emeritus, Social Science and Policy Studies/Management;  
Director, School of Industrial Management*
- GILBERT H. OWYANG (1961-1990)  
*Professor Emeritus, Electrical Engineering*
- EDWARD A. PARRISH (1995-2004)  
*Professor Emeritus and President Emeritus*
- JAMES W. PAVLIK (1974-2007)  
*Professor Emeritus, Chemistry and Biochemistry*
- JOSEPH D. SAGE (1957-1994)  
*Professor Emeritus, Civil Engineering*
- THOMAS A. SHANNON (1973-2005)  
*Professor Emeritus, Humanities and Arts*
- MICHAEL M. SOKAL (1970-2005)  
*Professor Emeritus, Humanities and Arts*
- GEORGE E. STANNARD (1946-1986)  
*Professor Emeritus, Electrical Engineering*
- CARLTON W. STAPLES (1948-1986)  
*Professor Emeritus, Mechanical Engineering*
- ROBERT E. WAGNER (1949-1987)  
*Professor Emeritus, Chemical Engineering*
- ADRIAAN WALTHER (1972-2001)  
*Professor Emeritus, Physics*
- STEPHEN J. WEININGER (1965-2005)  
*Professor Emeritus, Chemistry and Biochemistry, and  
Interdisciplinary and Global Studies*
- ALVIN H. WEISS (1966-1994)  
*Professor Emeritus, Chemical Engineering*
- JERALD A. WEISS (1962-1988)  
*Professor Emeritus, Physics*
- LESLIE C. WILBUR (1957-1987)  
*Professor Emeritus, Mechanical Engineering;  
Professor and Chairman of Nuclear Reactor Facility Emeritus*
- JOHN F. WILD (1962-1992)  
*Professor Emeritus, Physics*
- LYLE E. WIMMERGREN (1969-1994)  
*Professor Emeritus, Management*
- DOUGLAS W. WOODS (1970-2000)  
*Professor Emeritus, Social Science and Policy Studies*
- ROBERT G. ZALOSH (1990-2006)  
*Professor Emeritus, Fire Protection Engineering*
- JOHN F. ZEUGNER (1971-2005)  
*Professor Emeritus, Humanities and Arts*
- DONALD N. ZWIEP (1957-1990)  
*Professor and Department Head Emeritus, Mechanical Engineering*

**SPECIAL PROFESSORSHIPS**

NIKOLAOS A. GATSONIS

*George J. Alden Chair in Engineerig (2007-2010)**George F. Fuller Professorship in Mechanical Engineering (2007-2010);*

WENJING LOU

*Joseph Samuel Satin Distinguished Fellowship (2006-2007)*

YI H. MA

*Frances B. Manning Professorship*

UMBERTO MOSCO

*Harold J. Gay Professorship in Mathematics*

ROBERT L. NORTON

*Milton Prince Higgins II Distinguished Professorship (2007-2010)*

RSYZARD J. PRYPUTNIEWICZ

*Kenneth G. Merriam Distinguished Professorship (2004-2007) (2007-2010)*

MALCOLM H. RAY (1998)

*Ralph H. White Family Distinguished Professorship*

YIMING (KEVIN) RONG

*John Woodman Higgins Professorship in Engineering (2002-2005) (2005-2008)*

SATYA SHIVKUMAR

*Russell M. Searle Instructorship in Mechanical Engineering (2006-2007)*

H. SUSAN ZHOU

*Leonard P. Kinnicutt Professorship (2006-2009)***BOARD OF TRUSTEES' AWARD FOR OUTSTANDING SERVICE**

1989 WILLIAM R. GROGAN

**BOARD OF TRUSTEES' AWARD FOR OUTSTANDING CREATIVE SCHOLARSHIP**

1981 KEVIN A. CLEMENTS

1982 AUDREY M. HARRIS

1983 LEONARD GOODWIN AND DAVID P. MC KAY

1984 ALVIN H. WEISS

1985 LEONARD B. SAND

1986 ALEXANDER E. EMANUEL

1987 MICHAEL W. KLEIN

1988 THOMAS A. SHANNON AND MICHAEL M. SOKAL

1989 ALLEN H. HOFFMAN

1990 PAUL W. DAVIS AND L. RAMDAS RAM-MOHAN

1991 RSYZARD J. PRYPUTNIEWICZ

1992 GEORGE D. J. PHILLIES

1993 WESLEY T. MOTT

1994 YI H. MA

1995 DONALD F. NELSON

1996 DAVID CYGANSKI

1996 ALBERT SACCO, JR.

1996 CHRISTOPHER H. SOTAK

1997 DAVID C. BROWN

1998 KENT P. LJUNGQUIST

1999 WILLIAM R. MOSER

2000 PAMELA J. WEATHERS

2001 BARBARA E. WYSLOUZIL

2002 W. GRANT MCGIMPSEY

2003 STEVEN C. BULLOCK

2004 NIKOLAOS A. GATSONIS

2005 HOMER F. WALKER

2006 DIRAN APELIAN

2007 ELKE A. RUNDENSTEINER

**TRUSTEES' AWARD FOR OUTSTANDING ACADEMIC ADVISING (Formerly Tau Beta Pi Award, 1991-1999)**

1991 JOHN F. ZEUGNER

1992 MARY M. HARDELL

1993 JOHN GRIFFIN

1994 KENT P. LJUNGQUIST

1995 ROBERT A. D'ANDREA

1996 LEONARD D. ALBANO

1997 JILL RULFS

1998 MICHAEL A. GENNERT

1999 RICHARD F. VAZ

2000 DAVID S. ADAMS

2001 ALEXANDER E. EMANUEL

2002 PHILLIP E. ROBAKIEWICZ

2003 JONATHAN R. BARNETT

2004 GEORGE D. PINS

2004 ANN GARVIN

2005 JEANINE D. PLUMMER

2006 CAROLANN KOLECI

2007 JON P. ABRAHAM

---

**BOARD OF TRUSTEES' AWARD FOR  
OUTSTANDING TEACHING**

---

1968 WILBUR B. BRIDGMAN  
1969 WILLIAM R. GROGAN  
1970 JOHN P. VAN ALSTYNE  
1971 KENNETH E. SCOTT  
1972 ROBERT E. WAGNER  
1973 JAMES HENSEL  
1974 RAYMOND R. HAGGLUND  
1975 ROMEO L. MORUZZI  
1976 JOHN M. BOYD  
1977 FRANK D. DEFALCO  
1978 THOMAS H. KEIL  
1979 CARLTON W. STAPLES  
1980 ALLEN H. HOFFMAN  
1981 JAMES W. PAVLIK  
1982 ALEXANDER E. EMANUEL  
1983 HARTLEY T. GRANDIN, JR.  
1984 DAVID CYGANSKI  
1985 JOHN F. ZEUGNER  
1986 DAN H. WOLAVER  
1987 RICHARD D. SISSON, JR.  
1988 PATRICK P. DUNN  
1989 HAROLD W. HILSINGER  
1990 DAVID S. ADAMS  
1991 ROBERT LONG II  
1992 ANDREAS N. ALEXANDROU  
1993 RICHARD F. VAZ  
1994 L. RAMDAS RAM-MOHAN  
1995 JAMES S. DEMETRY  
1996 VAN BLUEMEL  
1996 NICHOLAS K. KILDAHL  
1997 SUSAN VICK  
1998 LEONARD D. ALBANO  
1999 JOHN A. MCNEILL  
2000 STEPHEN J. WEININGER  
2001 STEPHEN N. JASPERSON  
2002 CHRYSANTHE DEMETRY  
2003 HELEN G. VASSALLO  
2004 JUDITH E. MILLER  
2005 ROBERT L. NORTON  
2006 JEANINE D. PLUMMER  
2007 JOHN A. GOULET

---

**DENISE NICOLETTI TRUSTEES' AWARD FOR  
SERVICE TO COMMUNITY**

---

2003 JAMES P. O'ROURKE  
2004 WILLIAM A. BALLER  
2005 HOLLY K. AULT  
2006 ALLEN H. HOFFMAN  
2007 ELIZABETH TOMASZEWSKI

- Academic Advising 11  
 Academic Honesty Policy 170  
 Academic Probation 171  
 Academic Progress 171  
 Academic Resources Center 182  
 Academic Schedule and Events IFC  
 Academic Suspension 171  
 Academic Technology Center 181  
 Academic Warning 171  
 Accounting 142  
 Accreditation 238  
 Actuarial Mathematics 85  
 Actuarial Mathematics Major Program Chart 86  
 Administration 209  
 Administrative Obligations and Holds 172  
 Admission 195  
   Advanced Placement 196  
   Application Fee 195  
   Decision To Matriculate 196  
   Early Action 196  
   English as a Second Language (ESL) Program 197  
   International Students 197  
   New Student Orientation 196  
   Notification 195  
   Qualifications 195  
   Readmission 196  
   Standardized Tests 195  
   Transfer Students 197  
 Advanced Chemistry Courses 116  
 Advanced Placement 196  
 Advising 11  
 Aerospace Engineering 32  
 Aerospace Engineering Program Chart 33  
 Air Force Aerospace Studies 34, 105  
 Application Fee 195  
 Application for Degree 174  
 Applying to WPI 195  
 Art History/Architecture 128  
 Australia Project Center 24  
 Awards 186  
 Awards And Prizes 186  
  
 Bachelor/Master's Program 178  
 Bachelor of Arts Degree 74  
 Basic Sciences 106  
 Biochemistry 45  
 Biochemistry Courses 116  
 Biology and Biotechnology 35, 106  
 Biology and Biotechnology Lab Courses 108  
 Biomaterials 39  
 Biomechanics 39  
 Biomedical Engineering 36, 110  
 Biomedical Engineering Program Chart 38  
 Biomedical Imaging 40  
 Biosensors and Bioinstrumentation 41  
 Boston Project Center 19  
 Budapest Project Center 21  
 Business 142  
  
 Campus Map IBC  
 Cape Town Project Center 22  
 Career Development and Graduate School 191  
 Career Development Center 191  
 Change of Registration Information 175  
 Changing Project Advisor 175  
 Chemical Engineering 42, 112  
 Chemical Engineering Suggested Course Sequence 44  
 Chemistry 46  
 Chemistry and Biochemistry 45, 114  
 Chronology of Academic Schedule and Events IFC  
 Civil and Environmental Engineering 47, 117  
 Civil Engineering Area Consultants 51  
 Civil Engineering Program Chart 49  
 Class Year 170  
 Combined Bachelor/Master's Program 178  
 Commencement 169  
 Commitment to Pluralism 4  
 Computer Resources 179  
 Computer Science 52, 119  
 Computer Science Course Flow Chart 54  
 Computer Science Minor 55  
 Computer Science Program Chart 53  
 Concentrations 12  
 Concentrations for Chemical Engineering Majors 43  
 Concentrations for Humanities and Arts Majors 65  
 Contents 1  
 Cooperative Education Program 185  
 Costa Rica Project Center 24  
 Counseling Center 181  
 Course Changes 174  
 Course Descriptions 104  
 Courses Qualifying for Engineering Distribution Areas 104  
 Cross-registration 185  
 Cumulative Point Average 167  
 Currency Of Information 237  
  
 Degree Audits 174  
 Degree Options 12  
 Degree Requirements 9, 175  
 Denmark Project Center 21  
 Department and Program Descriptions 32  
 Designation of Class Year 170  
 Designation of Major Area of Study 169  
 Directions 238  
 Directory Information 172  
 Directory Information and Release of Information 172  
 Disability Services Office 182  
 Double Major 13, 170  
 Drama/Theatre Minor 67  
  
 Early Action 196  
 Ecole Polytechnique; Montreal, Quebec, Canada 184  
 Economic Growth, Stability and Development 18  
 Economics 159  
 Education in a Technological Society 18  
 Electrical and Computer Engineering 56, 122  
 Electrical and Computer Engineering Course Flow Chart 58  
 Energy and Resources 18  
 Engineering Physics 60  
 Engineering Registration and Licensing 189  
 Engineering Science Courses 60  
 Engineering Science Interdisciplinary 126  
 Engineering Societies 189  
 English 129  
 English as a Second Language (ESL) Program 197  
 Enrollment 174  
 Enrollment and Tuition Due Dates 198  
 Entrepreneurship 142, 183  
 Entrepreneurship Minor 78  
 Environmental Concentration 50  
 Environmental Engineering 61  
 Environmental Engineering Program Chart 62  
 Environmental Interests 63  
 Environmental Programs 60  
 Estimated Expenses 198  
 Exchanges 183  
   Ecole Polytechnique; Montreal, Quebec, Canada 184  
   Language Requirements 184  
   Monterrey Institute of Technology; Monterrey, Mexico 184  
   Royal Institute of Technology; Stockholm, Sweden 184  
   Technical College; Munich Germany 184  
 Expenses 198  
   Board Charges upon Withdrawal or Suspension 199  
   Enrollment and Tuition Due Dates 198  
   Estimated Expenses 198  
   Financial Aid upon Withdrawal/ Suspension 199  
   Students Tuition Charges upon Withdrawal or Suspension 198  
   Payment of Tuition Deposit 198  
   Room Charges upon Withdrawal or Suspension 199  
  
 Faculty 218  
 Finance 143  
 Financial Aid 200  
   Alternative Financial Programs 203  
   Application Procedures 200  
   Financial Aid Policies 202  
   Forms of Aid 201



- Reserve Officer Training Corps (ROTC) Scholarships 204
- Financial Aid Policies 202
- Fire Protection Engineering 64, 127
- First Year Students 178
- Five Year Programs 193
- Forms of Aid 201
- Fulbright Grants 193
- Fundamentals of Engineering Examination (F.E.E.) 189
- Gateway Park 178
- Gender, Race, and Technology 25
- General Social Science 163
- George C. Gordon Library 180
- Geosciences 106
- German 131
- Gillette Company Project Center 17
- Global Perspective Program 19
  - Australia Project Center 24
  - Boston Project Center 19
  - Budapest Project Center 21
  - Cape Town Project Center 22
  - Costa Rica Project Center 24
  - Denmark Project Center 21
  - Gender, Race, and Technology 25
  - Hong Kong Project Center 23
  - Individually Sponsored Residential Projects 24
  - Limerick Project Center 21
  - Living Museums Program 25
  - London Humanities Programs 22
  - London Project Center 21
  - Morocco Humanities Program 23
  - Namibia Project Center 23
  - Nancy Project Center 22
  - Nantucket Island Project Center 20
  - On-campus IQP Programs 25
  - Program in The South Pacific 24
  - Programs in Africa 22
  - Programs in Asia 23
  - Programs in Europe 21
  - Programs in Latin America 24
  - Programs in The United States 19
  - Puerto Rico Project Center 24
  - Silicon Valley Project Center 20
  - Venice Project Center 22
  - Wall St. Project Center 20
  - Washington Project Center 19
  - Worcester Community Project Center 20
  - Wuhan Project Center 24
- Global Technological University 6
- Goal of WPI 3
- Grade Appeal and Grade Change Policy 167
- Grades 166
  - Cumulative Point Average 167
  - Grade System Selection 166
  - Incomplete (I) 166
- No Record (NR) 166
- Project Grading 166
- Satisfactory Progress (SP) 166
- Grade System Selection 166
- Graduate Calendar 2008-2009 ii
- Graduate Chemistry Courses of Interest to Undergraduates 117
- Graduate Course Listings 193
- Graduate Degrees and Requirements 192
- Graduate Program 192
- Graduate Studies 191
  - Admission 192
  - Combined B.S./M.S. Program 192
  - Financial Aid 192
  - Five Year Programs 193
  - Fulbright Grants 193
  - Graduate Degrees And Requirements 192
  - Part-time Graduate Program 193
  - Registration And Tuition Payment 192
  - Rhodes Scholarships 193
- Graduation with Honors 169
- Health Care and Technology 18
- Historic and Artistic Preservation Technology 18
- History 132
- Holds 172
- Honesty Policy 170
- Hong Kong Project Center 23
- Housing 204
  - Furnishings and Facilities 204
  - Meals 205
  - Occupancy 204
  - Off-campus Living 205
  - Residence Halls 204
  - Room Charges 205
  - Roommates 205
- Humanistic Studies of Technology 18
- Humanities 135
- Humanities and Arts 64, 128
- Humanities and Arts minors 67
- Humanities and Arts Requirement 26
- Humanities and Arts with American Studies Concentration 65
- Humanities and Arts with Environmental Studies Concentration 66
- Humanities and Arts with Humanities Studies of Science and Technology Concentration 66
- Incomplete (I) 166
- Independent Study Registration 174
- Individually Sponsored Residential Projects 24
- Industrial Engineering 68
- Industrial Engineering Program Chart 68
- Inorganic and Physical Chemistry Courses 115
- Interactive Media and Game Development 69, 140
- Interactive Qualifying Project 17
  - Economic Growth, Stability and Development 18
  - Education in a Technological Society 18
  - Energy and Resources 18
  - Health Care and Technology 18
  - Historic and Artistic Preservation Technology 18
  - Humanistic Studies of Technology 18
  - Law and Technology 18
  - Safety Analysis and Liability 18
  - Science and Technology – Policy and Management 18
  - Social and Human Services 18
  - Social Studies of Science and Technology 18
  - Technology and Environment 18
  - Urban and Environmental Planning 18
- Interdisciplinary 141
- Interdisciplinary Programs 70
- International Students 197
- International Studies 72
- Late Fee 174, 198
- Law and Technology 18
- Law and Technology Minor 73
- Liberal Arts and Engineering (Bachelor of Arts Degree) 74
- Library 180
- Limerick Project Center 21
- Lincoln Laboratory Project Center 16
- Living Museums Program 25
- London Humanities Programs 22
- London Project Center 21
- Major Area of Study 169
- Major Areas of Study 10
- Major Qualifying Project 16
- Major Selection Program 182
- Management 76, 142
- Management Engineering 77
- Management Information Systems 77, 143
- Management Minor 78
- Manufacturing Engineering 79
- Manufacturing Engineering Minor 81
- Manufacturing Engineering Program Chart 80
- Marketing 144
- MASH (Math and Science Help) Program 182
- Master Builder Program 50
- Materials Engineering 81
- Mathematical Sciences 82, 146
- Mathematical Sciences Major Program Chart 84
- Mathematics Minor 87
- Meals 205
- Mechanical Engineering 88, 149
- Mechanical Engineering Department Concentrations 90
- Mechanical Engineering Program Chart 89

- Military Science 92, 154  
 Military Science Course Flow Chart 92  
 Minor in Computer Engineering 59  
 Minor in Foreign Language (German or Spanish) 67  
 Minor in Materials 81  
 Minors 12  
 MIS Minor 78  
 Mission of WPI 3  
 Monterrey Institute of Technology; Monterrey, Mexico 184  
 Morocco Humanities Program 23  
 MQP Project Centers 16  
   Gillette Company Project Center 17  
   Lincoln Laboratory Project Center 16  
   Sun Microsystems, Inc. Project Center 16  
 UMASS Memorial Health Care/University of Massachusetts Medical School/Tufts University School of Veterinary Medicine Project Centers 17  
 Music 136  
 Music and Theatre Facilities 180  
 Music Ensembles 136  
 Music Minor 67  
  
 Namibia Project Center 23  
 Nancy Project Center 22  
 Nantucket Island Project Center 20  
 New Student Orientation 196  
 No Record (NR) 166  
  
 Obligations 172  
 Off-Campus Living 205  
 Office of the Registrar 174  
 On-Campus IQP Programs 25  
 Operations and Industrial Engineering 144  
 Organic Chemistry Courses 115  
 Organizational Behavior and Change 145  
 Organizational Leadership Minor 79  
 Overloads of Courses 174  
 Overload with Project 175  
  
 Part-Time Graduate Program 193  
 Payment of Tuition Deposit 198  
 Philosophy 137  
 Physical Education 155  
 Physical Education, Recreation, and Athletics 93  
 Physics 94, 156  
 Physics and Engineering-Physics Programs 95  
 Physics Minor 96  
 Policies & Practices 237  
 Policies and Procedures 166  
 Political Science, Government and Law 160  
 Pre-Law Programs 97  
 Pre-MBA Program (Dual Degree) 97  
 Pre-Medical, Pre-Dental and Pre-Veterinary Programs 98  
  
 Prizes 186  
 Probation 171  
 Professionally Accredited Programs 11  
 Professional Writing 71  
 Program in the South Pacific 24  
 Programs in Africa 22  
 Programs in Asia 23  
 Programs in Europe 21  
 Programs in Latin America 24  
 Programs in the United States 19  
 Project-Based Learning Community Option 98  
 Project and Independent Study Registration 174  
 Project Completion 175  
 Project Conferences 175  
 Project Grading 166  
 Project Registration 175  
 Project Registration Topic Codes 176  
 Projects 14  
 Psychology 161  
 Puerto Rico Project Center 24  
  
 Qualifications 195  
  
 Readmission 196  
 Registration 174  
 Registration Policy for Degree Requirements 175  
 Release of Information 172  
 Religion 138  
 Reserve Officer Training Corps (ROTC) Scholarships 204  
 Residence Halls 204  
 Residential Programs 19  
 Resources and Special Programs 178  
 Rhetoric (RH) and Writing 138  
 Rhodes Scholarships 193  
 Robotics Engineering 98, 158  
 Room Charges 205  
 Roommates 205  
 Royal Institute of Technology; Stockholm, Sweden 184  
  
 Safety Analysis and Liability 18  
 Satisfactory Academic Progress 171  
 Satisfactory Progress (SP) 166  
 Science and Technology – Policy and Management 18  
 Silicon Valley Project Center 20  
 Social and Human Services 18  
 Social Science and Policy Studies 99, 159  
 Social Science Minors 102  
 Social Science Requirement 30  
 Social Studies of Science and Technology 18  
 Societies, Registration and Licensing 189  
 Society/Technology Studies 163  
 Sociology 163  
  
 Spanish 139  
 Special Students 175  
 Standardized Tests 195  
 Statement of Values for Undergraduate Education at WPI 3  
 Statistics Minor 87  
 Student Development and Counseling Center 181  
 Student Disability Services Office 182  
 Student Exchanges 183  
 Student Services 181  
 Students Tuition Charges upon Withdrawal or Suspension 198  
 Summer Session (Term E) 186  
 Sun Microsystems, Inc. Project Center 16  
 Suspension 171  
 System Dynamics 162  
  
 Teacher Licensing 71  
 Technical College; Munich Germany 184  
 Technology and Environment 18  
 Tissue Engineering 42  
 Transcript Fees 174  
 Transfer Credit 168  
 Transfer Students 197  
 Trustees 207  
 Two Towers Tradition: The Second Century 5  
  
 UMASS Memorial Health Care/University of Massachusetts Medical School/Tufts University School of Veterinary Medicine Project Centers 17  
 Undergraduate Calendar 2008-2009 i  
 Undergraduate Learning Outcomes 4  
 University Policies and Procedures 166  
 Urban and Environmental Planning 18  
  
 Venice Project Center 22  
 Visiting the Campus 195  
  
 Wait Lists 174  
 Wall St. Project Center 20  
 Warning 171  
 Washington Project Center 19  
 Withdrawal from Courses 174  
 Withdrawal from WPI 174  
 Worcester Community Project Center 20  
 Worcester Consortium Course Cross-Registration 185  
 World Wide Web 183  
 WPI Plan 5  
 Writing and Rhetoric Minor 68  
 Writing Courses and Advisors 183  
 Writing Workshop 183  
 Wuhan Project Center 24

**NOTICE OF NONDISCRIMINATORY POLICY AS TO STUDENTS**

It is the policy of Worcester Polytechnic Institute that each qualified individual, regardless of race, color, sex, religion, sexual orientation, national origin, age as defined by law, or handicap, shall have equal opportunity in education, employment or services of Worcester Polytechnic Institute. It is the policy of WPI to follow U.S. federal government eligibility guidelines in the administration of its institutional financial aid program.

**STUDENT RESPONSIBILITIES FOR ETHICAL AND PROFESSIONAL CONDUCT**

WPI expects all its students to demonstrate the highest sense of honor in respecting academic and professional traditions such as acknowledging the borrowing or use of other people's ideas. Willful violations (like plagiarism) of such academic traditions or of legal restrictions (like those regarding copyright) will be considered violations of the "Campus Code" as described in the Student Planner.

WPI education is strongly committed to project-based learning, to providing students with access to state-of-the-art technology, and to working with professionals, on and off campus. Therefore, when students are exposed to proprietary and/or confidential information, they must accept responsibilities appropriate to their preparation for life-long careers in which codes of ethics govern professional conduct.

Facilities such as the off-campus projects, employment sites, and those listed in "Resources Available to Undergraduates" (pages 8-16) permit students to gain experience with techniques at the forefront of industrial and research development. With this access comes the added responsibility of safeguarding students of any agreements they sign regarding conditions or restrictions for access to certain equipment or information will also be considered a violation of the "Campus Code" as described in the Student Planner.

Record of any penalties assigned by the WPI Campus Judicial System which result from violation of standards of ethical conduct will become a permanent part of that student's disciplinary record.

**STUDENT ABSENCE DUE TO RELIGIOUS BELIEFS**

Section 2B, Chapter 151C of the General Laws of the Commonwealth of Massachusetts: "Any student in an educational or vocational training institution, other than a religious or denominational educational or vocational training institution, who is unable, because of his/her religious beliefs, to attend classes or to participate in any examination, study, or work requirement on a particular day shall be excused from any such examination or study or work requirement, and shall be provided with an opportunity to make up such examination, study, or work requirement which he/she may have missed because of such absence on any particular day; provided, however, that such makeup examination or work shall not create an unreasonable burden upon such school. No fees or any kind shall be charged by the institution for making available to the said student such opportunity. No adverse or prejudicial effects shall result to any students because of his/her availing himself/herself of the provisions of this section."

**POLICY FOR INSTITUTIONAL CHARGES AND REFUNDS FOR STUDENTS CALLED TO MILITARY ACTION**

WPI recognizes the obligations of our students who are called to active duty by the U.S. Military. To support these students WPI has established this policy to facilitate their transition from, and back to active student status.

Such students shall receive 100% refund for the uncompleted term(s) of the semester at the date of the notice. If such student has a loan obligation to WPI they will be granted an in-school deferment status during the period of active duty service, not to exceed a total of three years.

To initiate the process to be classified "On leave for military service" the student must indicate, in writing, that he/she is requesting school deferment status while being called to active duty. A copy of the official call to active duty notice from the military must be included with this request and be submitted to the Registrar's Office.

**CURRENCY OF INFORMATION**

The information contained in this Undergraduate Catalog is not a complete statement of all the policies, practices, rules and regulations of Worcester Polytechnic Institute. Any statement made in this publication is for current informational purposes only and is subject to change by the governing body of WPI or its duly authorized representatives. Certain policies, rules and regulations are not published in this publication but are promulgated directly by the appropriate department. Members of the WPI community are expected to abide by the current policies, practices, rules and regulations of the college, even

though they may not be contained in this publication or may not be consistent with the information contained in this publication, whether due to a properly authorized change or to a printing error.

Changes, deletions, and additions authorized by the governing body of WPI, after the printing of this catalog, are posted on WPI's web page at [www.wpi.edu/](http://www.wpi.edu/) as a supplement to the undergraduate catalog, and includes the effective date of the action.

Worcester Polytechnic Institute is accredited by the New England Association of Schools and Colleges, Inc., through its Commission on Institutions of Higher Education.

Accreditation of an institution of higher education by the New England Association indicates that it meets or exceeds criteria for the assessment of institutional quality periodically applied through a peer review process. An accredited college or university is one which has available the necessary resources to achieve its stated purposes through appropriate educational programs, is substantially doing so, and gives reasonable evidence that it will continue to do so in the foreseeable future. Institutional integrity is also addressed through accreditation.

Accreditation by the New England Association is not partial but applies to the institution as a whole. As such, it is not a guarantee of every course or program offered, or the competence of individual graduates. Rather, it provides reasonable assurance about the quality of opportunities available to students who attend the institution.

Inquiries regarding the accreditation status by the New England Association should be directed to the Office of the Provost.

In addition, the programs leading to majors in biomedical engineering, chemical engineering, civil engineering, electrical and computer engineering, industrial engineering, manufacturing engineering and mechanical engineering are accredited by the Engineering Accreditation Commission of ABET.

The Chemistry and Biochemistry Department and its program at WPI are approved by the American Chemical Society for a major in chemistry or biochemistry. Those chemistry majors who complete a program satisfying the guidelines established by the American Chemical Society are certified to that organization as having received an undergraduate professional education in chemistry or biochemistry.

The computer science program has been accredited by the Computing Accreditation Commission of ABET.

The undergraduate and graduate business offerings in the Department of Management are accredited by AACSB International, the Association to Advance Collegiate Schools of Business. AACSB International is a not-for-profit organization consisting of more than 900 educational organizations and corporations. Its mission is excellence in management education in colleges and universities. Headquartered in Tampa, Florida, AACSB International is the premier accrediting agency and service organization for business schools.

## DIRECTIONS

### DRIVING TO WPI

#### FROM THE EAST:

Take Mass. Turnpike (I-90) to Exit 11A (I-495). Proceed north to I-290, then west into Worcester. Take Exit 18, turn right at end of ramp, then an immediate right before next traffic light. At next light, proceed straight through, bearing to the right on Salisbury St. At the WPI sign, turn left onto Boynton St., then right onto Institute Rd., then right onto West St. Visitor parking is on the left after footbridge.

#### FROM THE NORTH:

Take I-495 south to I-290. Follow directions as from east.

#### FROM THE SOUTH AND WEST:

Take Mass. Turnpike (I-90) to Exit 10 (Auburn). Proceed east on I-290 into Worcester. Take Exit 17, turn left at end of ramp, follow Rte. 9 west through Lincoln Sq., straight onto Highland St., then right at light onto West St. and through first intersection. Visitor parking is on the left after footbridge.

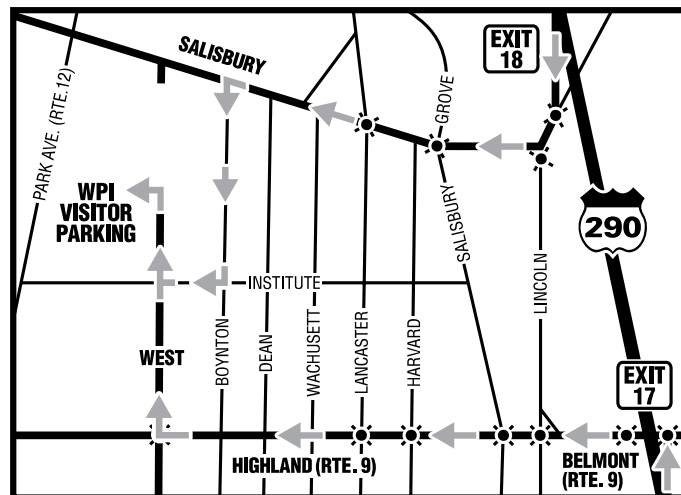
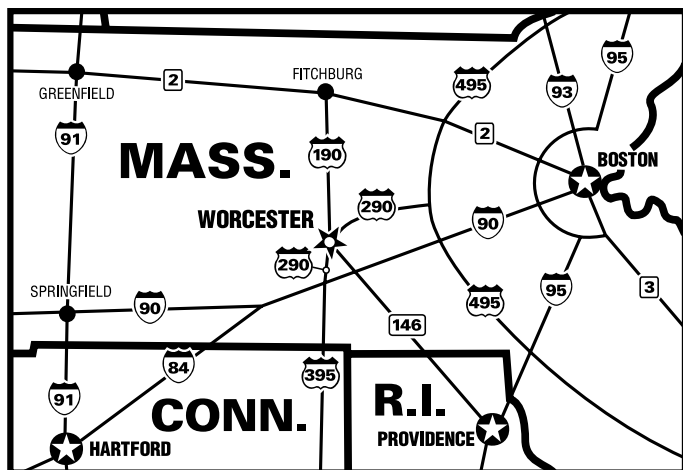

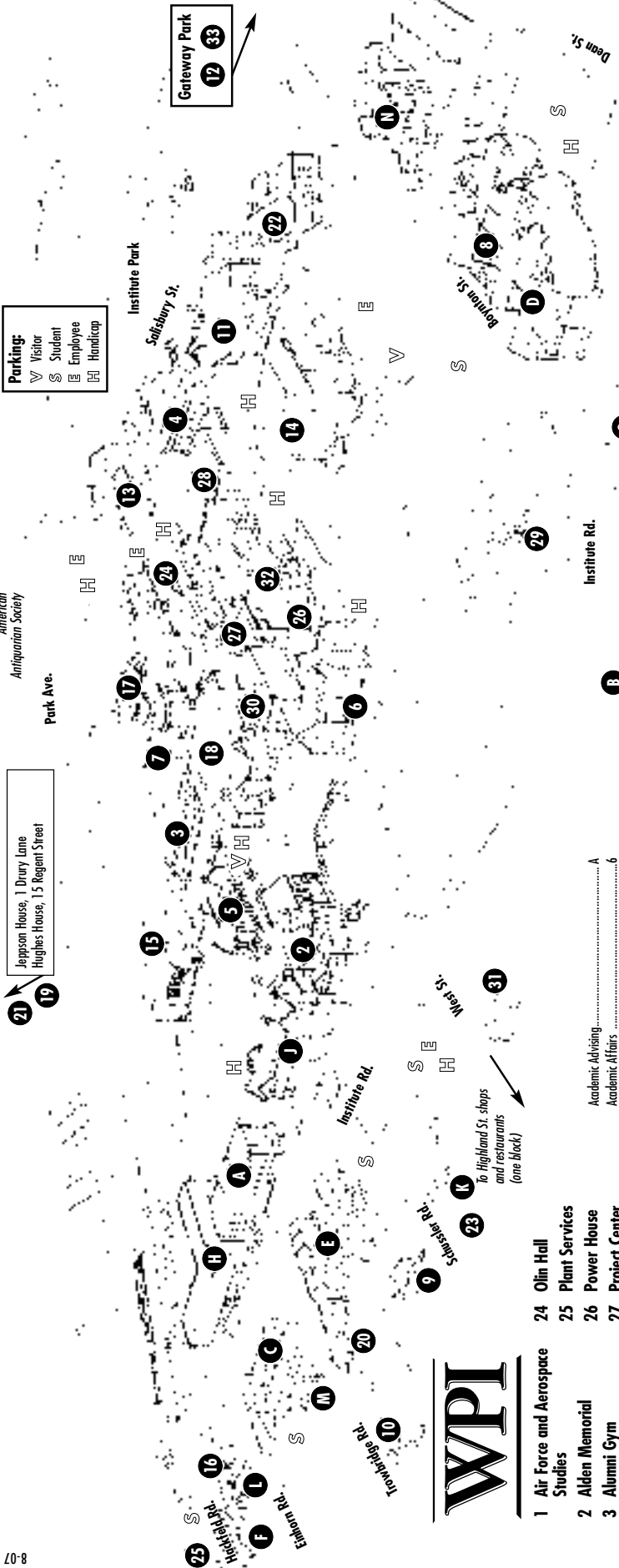

1 Air Force and Aerospace Studies	24 Olin Hall	Academic Advising..... A	Dining Hall (Morgan)..... H	International Students & Scholars..... 20	Perreault Lecture Hall..... 11
2 Alden Memorial	25 Plant Services	Academic Affairs..... 6	Dining Services..... H	K-12 Outreach Programs..... 18	Physical Education, Recreation, & Athletics..... 3
3 Alumni Gym	26 Power House	Academic Resources Center..... A	Disability Services..... A	Kimnart Lecture Hall..... 28	Physic Dept..... 24
4 Atwater Kent Laboratories	27 Project Center	Academic Technology Center (ATC)..... 11	Discovery Classroom..... 18	Legal Counsel..... 6	Plant Services..... 25, A
5 Bartlett Center	28 Salsbury Laboratories	Access Grid..... H	Diversity Programs..... 7	Pre-Health Center..... 6	Pre-Health Center..... 28
6 Boynton Hall	29 Skull Tomb	Accounting and Treasury Office..... 6	Educational Development, Technology, & Assessment, Center for..... 4	Printing Services..... 6	President's Office..... 6
7 Campus Center	30 Stratton Hall	Administrative Services..... D	Electrical & Computer Engineering Dept..... 4	Projects Administration..... A	Projects Administration..... A
8 Campus Police	31 Student Development and Counseling Center	Admissions (Undergraduate)..... 5	Emergency Medical Service..... D	Property Administration..... 33	Property Administration..... 33
9 Collegiate Religious Center	32 Washburn Shops and Stoddard Laboratories	Advanced Distance Learning Network..... 12	Entrepreneurship & Innovation, Collaborative for..... 32	Provost's Office..... 6	Provost's Office..... 6
10 20 Trowbridge Road	33 85 Prescott Street	Air Force & Aerospace Studies..... 1	ESL Program..... 20	Radio Station WPHI..... 7	Radio Station WPHI..... 7
11 Fuller Laboratories	A Daniels Hall	Alcohol/Drug Education Director..... 3	Events Office..... 7	Registrar..... A	Registrar..... A
12 WPI Life Sciences and Bioengineering Center	B 16 Elbridge	Alumni Relations..... 17	Faculty Governance..... H	Research Administration..... A	Research Administration..... A
13 Goddard Hall	C Ellsworth Apartments	Applied Music Division..... 2	Finance & Operations..... 6	Research Communications..... 6	Research Communications..... 6
14 Gordon Library	D Founders Hall	Archives Room..... 14	Financial Aid..... 5	Residential Services..... C	Residential Services..... C
15 Harrington Auditorium	E Fuller Apartments	Basketball Courts (Indoor)..... 15	Fire Protection Engineering Dept..... 18	Riley Commons..... J	Riley Commons..... J
16 Health Center	F 26 Hackfeld	Biology & Biotechnology Dept..... 12, 28	Fitness Center..... 3	Social Committee (SoComm)..... 7	Social Committee (SoComm)..... 7
17 Higgins House	G Institute Hall	Bioengineering Institute..... 12	Food Court..... 7	Sports Information..... 4	Sports Information..... 4
18 Higgins Laboratories	H Morgan Hall	Biomedical Engineering Dept..... 12, 28	Goat's Head Restaurant..... D	Squash Courts..... 15	Squash Courts..... 15
19 Hughes House	J Sanford Riley Hall	Bookstore..... 7	Health Center..... 16	Student Affairs..... 7	Student Affairs..... 7
20 International House	K 22 Schussler	Campus Police and Public Safety..... 8	Healthy Alternatives..... H	Student Development & Counseling Center..... 31	Student Development & Counseling Center..... 31
21 Jeppson Complex	L Stoddard Complex	Career Development Center..... 27	Help Desk..... 11	Swimming Pool..... 3	Swimming Pool..... 3
22 Kaven Hall	M 25 Trowbridge	Chemical Engineering Dept..... 13	Higgins Club (dining room)..... 17	Tech News (student newspaper)..... 7	Tech News (student newspaper)..... 7
23 OASIS	N New Residence Hall (under construction)	Chemistry & Biochemistry Dept..... 12	Higgins Lecture Hall..... 6	Telecommunications..... 6	Telecommunications..... 6
		Civil & Environmental Engineering Dept..... 9	Human Resources..... 7	Web Communications..... 6	Web Communications..... 6
		Collegiate Religious Center..... 9	Information Technology (IT)..... 21	Wrestling Facility..... 3	Wrestling Facility..... 3
		Computing and Communications Center..... 11	Interdisciplinary & Global Studies..... 7		
		Computer Science Dept..... 11			
		Corporate & Professional Education..... 12			
		Corporate & Foundation Relations..... 6			
		Dean of Students..... 7			
		Development..... 6, 10, 17			



**Worcester Polytechnic Institute**

100 Institute Road

Worcester, MA 01609-2280

[www.wpi.edu](http://www.wpi.edu)

