



Worcester Polytechnic Institute

The University of Science and Technology. And Life.™

CHRONOLOGY OF ACADEMIC SCHEDULE AND EVENTS

2005-2006 Academic Year

January 3	Tuition for Terms C and D Due
January 8	Residence Halls Open for Term C
January 9-13	Web Enrollment for Spring Semester
January 11	Deadline for Completion of Degree Requirement Forms for February 2006 Candidates
January 12	First Day of Classes, Term C
January 16	First Day of Classes for Graduate Courses
February 16	Advising Appointment Day (No Undergraduate Classes)
March 2	Last Day of Classes, Term C
March 3	Reserved for Weather-Cancellation Makeup
March 3-13	Spring Recess
March 14	First Day of Classes, Term D
April 18	Project Presentation Day (No Undergraduate Classes)
April 27	Deadline for Completion of Degree Requirement Forms for May 2006 Candidates
April 28	Last Day of Classes for Semester Courses
May 2	Last Day of Classes, Term D
May 4	12 noon - Residence Halls Close
May 15	First Day of Classes, Summer Session-tentative
May 19	Baccalaureate Ceremony
May 20	Spring Commencement
May 29	Memorial Day Holiday
June 9-11	Alumni Reunion
July 4	Independence Day Holiday (no classes)
August 23	Deadline for Completion of Degree Requirement Forms for Fall 2006 Candidates

2006-2007 Academic Year

August 9	Tuition for Terms A and B Due
August 19	Residence Halls Open for NEW Students; New Student Orientation (Freshmen/Transfer) Begins
August 20	Residence Halls and Apartments Open for Returning Students
August 21-25	Web Enrollment for Fall Semester
August 23	Deadline for Completion of Degree Requirement Forms for Fall 2006 Graduation
August 24	First Day of Classes, Term A
August 24	(Thurs.) Follow Monday Class Schedule
September 4	Labor Day Holiday (No Classes)

September 5	First Day of Classes for Graduate Courses
September 22	President's IQP Awards Entry Deadline
October 6-7	Homecoming
October 12	Last Day of Classes, Term A
October 13-23	Fall Recess
October 24	First Day of Classes, Term B
October 24	(Tues.) Follow Friday Class Schedule
November 22-26	Thanksgiving Recess (Last Day of Class - Undergraduates - November 21) (Last Day of Class - Graduate Students - November 20)
December 6	President's IQP Award Competition
December 14	Last Day of B-term Classes
December 15	12 noon - Residence Halls Close For Term Break
December 15- January 10, 2007	Winter Recess
January 2	Tuition for Terms C and D Due
January 7	Residence Halls Open for Term C
January 8-12	Web Enrollment for Spring Semester
January 10	Deadline for Completion of Degree Requirement Forms for February 2007 Candidates
January 11	First Day of Classes, Term C
January 15	First Day of Classes for Graduate Courses
February 15	Advising Appointment Day (No Undergraduate Classes)
March 1	Last Day of Classes, Term C
March 2	Reserved for Weather-Cancellation Makeup
March 2-12	Spring Recess
March 13	First Day of Classes, Term D
April 17	Project Presentation Day (No Undergraduate Classes)
April 26	Deadline for Completion of Degree Requirement Forms for May 2007 Candidates
April 27	Last Day of Classes for Semester Courses
May 1	Last Day of Classes, Term D
May 3	12 noon - Residence Halls Close
May 14	First Day of Classes, Summer Session-tentative
May 18	Baccalaureate Ceremony
May 19	Spring Commencement
May 28	Memorial Day Holiday
June 8-10	Alumni Reunion
July 4	Independence Day Holiday (no classes)
August 22	Deadline for Completion of Degree Requirement Forms for Fall 2007 Candidates

UNDERGRADUATE CALENDAR 2006-2007

		S	M	T	W	R	F	S			S	M	T	W	R	F	S			
A	AUG	30	31	1	2	3	4	5	FEB	11	12	13	14	15	16	17	FEBRUARY 15 ACAD. ADVISING DAY (PROJ. OPPORTUNITIES)			
		6	7	8	9	10	11	12		18	19	20	21	22	23	24				
	SEPT	SEPT	13	14	15	16	17	18	19	MAR	25	26	27	28	1	2	3	MARCH 2 SNOW DAY (AS NEEDED)		
			20	21	22	23	24	25	26		4	5	6	7	8	9	10			
		SEPT	SEPT	27	28	29	30	31	1	2	APR	11	12	13	14	15	16	17	D	
				3	4	5	6	7	8	9		18	19	20	21	22	23	24		
		OCT	OCT	10	11	12	13	14	15	16	MAY	25	26	27	28	29	30	31	APRIL 17 PROJECT PRES. DAY	
				17	18	19	20	21	22	23		1	2	3	4	5	6	7		
			OCT	OCT	24	25	26	27	28	29	30	JUNE	8	9	10	11	12	13	14	Graduation
					1	2	3	4	5	6	7		15	16	17	18	19	20	21	
NOV	NOV		8	9	10	11	12	13	14	JULY	22	23	24	25	26	27	28	JULY 4 INDEPEND. DAY		
			15	16	17	18	19	20	21		29	30	1	2	3	4	5			
B	NOV	22	23	24	25	26	27	28	AUG	6	7	8	9	10	11	12	MAY 28 MEMORIAL DAY			
		29	30	31	1	2	3	4		13	14	15	16	17	18	19				
	DEC	DEC	5	6	7	8	9	10	11	AUG	20	21	22	23	24	25	26	JULY 4 INDEPEND. DAY		
			12	13	14	15	16	17	18		27	28	29	30	31	1	2			
	JAN	JAN	19	20	21	22	23	24	25	AUG	3	4	5	6	7	8	9	JULY 4 INDEPEND. DAY		
			26	27	28	29	30	1	2		10	11	12	13	14	15	16			
	FEB	FEB	3	4	5	6	7	8	9	AUG	17	18	19	20	21	22	23	JULY 4 INDEPEND. DAY		
			10	11	12	13	14	15	16		24	25	26	27	28	29	30			
	FEB	FEB	17	18	19	20	21	22	23	AUG	1	2	3	4	5	6	7	JULY 4 INDEPEND. DAY		
			24	25	26	27	28	29	30		8	9	10	11	12	13	14			
FEB	FEB	31	1	2	3	4	5	6	AUG	15	16	17	18	19	20	21	JULY 4 INDEPEND. DAY			
		7	8	9	10	11	12	13		22	23	24	25	26	27	28				
FEB	FEB	14	15	16	17	18	19	20	AUG	29	30	31	1	2	3	4	JULY 4 INDEPEND. DAY			
		21	22	23	24	25	26	27		5	6	7	8	9	10	11				
FEB	FEB	28	29	30	31	1	2	3	AUG	12	13	14	15	16	17	18	JULY 4 INDEPEND. DAY			
		4	5	6	7	8	9	10		19	20	21	22	23	24	25				

August 24 =
MONDAY
schedule

SEPTEMBER 5
LABOR DAY

October 24 =
FRIDAY
schedule

NOVEMBER 23
THANKSGIVING

C

GRADUATE CALENDAR 2006-2007

		S	M	T	W	R	F	S			S	M	T	W	R	F	S		
FALL	AUG	30	31	1	2	3	4	5	FEB	11	12	13	14	15	16	17	SPRING		
		6	7	8	9	10	11	12	18	19	20	21	22	23	24				
		13	14	15	16	17	18	19	25	26	27	28	1	2	3				
		20	21	22	23	24	25	26	4	5	6	7	8	9	10				
	SEPT	MAR	27	28	29	30	31	1	2	11	12	13	14	15	16	17			
			3	4	5	6	7	8	9	18	19	20	21	22	23	24			
			10	11	12	13	14	15	16	25	26	27	28	29	30	31			
			17	18	19	20	21	22	23	1	2	3	4	5	6	7			
	OCT	APR	24	25	26	27	28	29	30	8	9	10	11	12	13	14			
			1	2	3	4	5	6	7	15	16	17	18	19	20	21			
			8	9	10	11	12	13	14	22	23	24	25	26	27	28			
			15	16	17	18	19	20	21	29	30	1	2	3	4	5			
NOV	MAY	22	23	24	25	26	27	28	6	7	8	9	10	11	12				
		29	30	31	1	2	3	4	13	14	15	16	17	18	19				
		5	6	7	8	9	10	11	20	21	22	23	24	25	26				
		12	13	14	15	16	17	18	27	28	29	30	31	1	2				
DEC	JUNE	19	20	21	22	23	24	25	3	4	5	6	7	8	9				
		26	27	28	29	30	1	2	10	11	12	13	14	15	16				
		3	4	5	6	7	8	9	17	18	19	20	21	22	23				
		10	11	12	13	14	15	16	24	25	26	27	28	29	30				
JAN	JULY	17	18	19	20	21	22	23	1	2	3	4	5	6	7				
		24	25	26	27	28	29	30	8	9	10	11	12	13	14				
		31	1	2	3	4	5	6	15	16	17	18	19	20	21				
		7	8	9	10	11	12	13	22	23	24	25	26	27	28				
FEB	AUG	14	15	16	17	18	19	20	29	30	31	1	2	3	4				
		21	22	23	24	25	26	27	5	6	7	8	9	10	11				
		28	29	30	31	1	2	3	12	13	14	15	16	17	18				
		4	5	6	7	8	9	10	19	20	21	22	23	24	25				

SEPTEMBER 4
LABOR DAY

NOVEMBER 23
THANKSGIVING

Graduation

MAY 28
MEMORIAL DAY

SUMMER

JULY 4
INDEPEND. DAY

Chronology of Academic Schedule and Events	IFC
Undergraduate Calendar 2006-2007	i
Graduate Calendar 2006-2007	ii
The Mission of WPI	3
The Goal of WPI	3
A Statement of Values for Undergraduate Education at WPI	3
WPI Undergraduate Learning Outcomes	4
WPI's Commitment to Pluralism	4
The Two Towers Tradition: The Second Century	5
The WPI Plan	5
WPI: A Global Technological University	6
Global Program Sites	6
Resources Available to Undergraduates	8
Computer Resources	8
Resources in Fuller Laboratories	8
Resources in Higgins Laboratories	8
Resources in The Washburn Laboratories	9
Project and Educational Facilities	9
Research Centers and Institutes	10
Metal Processing Institute (MPI)	10
Research Laboratories and Facilities	11
Music and Theatre Facilities	16
George C. Gordon Library	16
Academic Technology Center	17
Advising and Student Services	17
Student Development and Counseling Center	17
MASH (Math and Science Help) Program	18
Academic Resources Center	18
Student Disability Services Office	18
Writing Workshop	19

SECTION 1:
THE WPI PLAN 20

WPI Degree Requirements	21
The Planning Process	22
Academic Advising	23
Major Areas of Study	24
Concentrations	25
Minors	25
Double Majors	26
Minimum Distribution Requirements for Students	27
Courses Qualifying for Engineering Distribution Areas	35
Projects	35
Projects Program	37
Project Centers	37
The Major Qualifying Project	39
The Interactive Qualifying Project	39
Residential Project Programs	47
On-Campus IQP Programs	52
The Sufficiency	53
The Social Science Requirement	60
Awards and Prizes	60

SECTION 2:
**DEPARTMENT AND
PROGRAM DESCRIPTIONS 65**

Aerospace Engineering	65
Air Force Aerospace Studies	67
Biology and Biotechnology	68
Biomedical Engineering	72
Chemical Engineering	93
Chemistry and Biochemistry	97
Civil and Environmental Engineering	101
Computer Science	108
Computer Science Minor	114
Electrical and Computer Engineering	114
Minor in Computer Engineering	123
Engineering Science Courses	123
Engineering Physics	123
Environmental Programs	124
Fire Protection Engineering	126
Humanities and Arts	127
Minor in Foreign Language (German or Spanish)	130
Minor in Music	130
Minor in Writing and Rhetoric	131
Industrial Engineering	131
Interdisciplinary Programs	132
Teacher Licensing	134
International Studies	134
Law and Technology Minor	136
Management	136
Entrepreneurship Minor	145
Management Minor	146
MIS Minor	146
Organizational Leadership Minor	147
Manufacturing Engineering	147
Minor in Manufacturing Engineering	150
Materials Engineering	150
Minor in Materials	150
Mathematical Sciences	151
Statistics Minor	159
Mathematics Minor	159
Mechanical Engineering	160
Military Science	166
Physical Education	168
Physics	169
Physics Minor	173
Pre-Law Programs	173
Pre-MBA Program (Dual Degree)	173
Pre-Medical, Pre-Dental and Pre-Veterinary Programs	174
Project-Based Learning Community Option (PLC)	175
Robotics	175
Social Science and Policy Studies	175
Social Science Minors	186

**SECTION 3:
COURSE DESCRIPTIONS 188**

Air Force Aerospace Studies	188
Basic Sciences	189
Biology and Biotechnology	189
Biomedical Engineering	193
Chemical Engineering	195
Chemistry and Biochemistry	197
Civil and Environmental Engineering	200
Computer Science	202
Electrical and Computer Engineering	205
Engineering Science Interdisciplinary	208
Fire Protection Engineering	209
Humanities and Art	210
Interactive Media and Game Development	220
Interdisciplinary	221
Management	222
Mathematical Sciences	225
Mechanical Engineering	229
Military Science	233
Physical Education	234
Physics	235
Social Science and Policy Studies	237

**SECTION 4:
ACADEMIC POLICIES AND PROCEDURES 243**

Academic Policies and Procedures	243
Grades	243
Grade Appeal and Grade Change Policy	245
Transfer Students	246
Transcript Fees	246
Degree Audits	246
Designation of Major Area of Study	247
Double Major	247
Designation of Class Year	247
Guidelines for the Determination of Satisfactory Academic Progress, Academic Warning, Academic Probation and Academic Suspension	247
Administrative Obligations	248
Directory Information and Release of Information	248
Registration	249
Project and Independent Study Registration	249
Registration Policy for Degree Requirements	250
Special Students	250
Project Registration Topic Codes	251
Coding of Project Advisors	252

**SECTION 5:
UNIQUE OPPORTUNITIES AT WPI 255**

Entrepreneurship	255
Student Exchanges	255
Project-Based Learning Community Option (PLC)	257
Worcester Consortium Course Cross-Registration	257
Cooperative Education Program	257
Summer Session (Term E)	258
Societies, Registration and Licensing	259

**SECTION 6:
CAREER DEVELOPMENT AND
GRADUATE SCHOOL 261**

Career Development	261
Graduate Studies	261
Graduate Program	262

**SECTION 7:
ADMISSION, EXPENSES,
FINANCIAL AID AND HOUSING 265**

Admission to WPI	266
Expenses	269
Financial Aid	271
Housing	276

**SECTION 8:
TRUSTEES, ADMINISTRATION AND FACULTY 278**

Trustees	279
Administration	282
Faculty	291
Faculty Emeriti	301
Special Professorships	303
Board of Trustees' Award for Outstanding Creative Scholarship	303
Board of Trustees' Award for Outstanding Teaching	304
Board of Trustees' Award for Outstanding Service	304
Trustees' Award for Outstanding Academic Advising	304
Denise Nicoletti Trustees' Award for Service to Community	304
Index	305
Accreditation	309
Policies & Practices	309
Currency of Information	310
Directions	310
Campus Map	IBC

WPI educates talented men and women in engineering, science, management, and humanities in preparation for careers of professional practice, civic contribution, and leadership, facilitated by active lifelong learning. This educational process is true to the founders' directive to create, to discover, and to convey knowledge at the frontiers of academic inquiry for the betterment of society.

Knowledge is created and discovered in the scholarly activities of faculty and students ranging across educational methodology, professional practice, and basic research. Knowledge is conveyed through scholarly publication and instruction.

Adopted by the Board of Trustees, May 22, 1987

THE GOAL OF WPI

WPI was founded in 1865 to create and convey the latest science and engineering knowledge in ways that would be most useful to the society from which its students came. Since that time, the disciplines of human inquiry have expanded extraordinarily, as have WPI's constituencies. The WPI curriculum, accordingly, has been reshaped numerous times, but it has remained true to its original mission of fusing academic inquiry with social needs, of blending abstraction with immediacy, of linking new knowledge to applications.

The goals of the undergraduate program are to lead students to develop an excellent grasp of fundamental concepts in their principal areas of study; to lay a foundation for life-long renewal of knowledge; to gain a mature understanding of themselves; and, most importantly, to form a deep appreciation of the interrelationships among basic knowledge, technological advance, and human need. These principles are today manifest in the *WPI Plan*, a unique, project-oriented program which emphasizes intensive learning experiences and direct application of

knowledge. WPI remains committed to continued educational improvement and innovation.

The goals of WPI's programs of graduate instruction and research are to create and convey knowledge at the frontiers of academic inquiry. These endeavors are founded on the principle that vigorously pursued and rigorously assessed scholarship is the lifeblood of the institution. High quality graduate instruction conveys the arts of scholarship to new generations, and it assists working professionals in maintaining currency in a world where knowledge becomes obsolete with ever-increasing rapidity.

A WPI education encompasses continuous striving for excellence coupled with an examination of the contexts of learning so that knowledge is won not only for its own sake but also for the sake of the human community of which the people of WPI are part.

Endorsed by the WPI Faculty on March 5, 1987, and by the Board of Trustees on October 16, 1987.

A STATEMENT OF VALUES FOR UNDERGRADUATE EDUCATION AT WPI

1. WPI's programs shall emphasize fundamental concepts, knowledge, and skill, and ensure that students are able to apply them within the context of their major disciplines.
2. WPI's programs shall emphasize the development of students as effective thinkers and communicators, able to use evidence to present their ideas with logic, clarity, and persuasion.
3. Programmatic breadth in general, and balance between technical and humanistic components in particular, are the hallmarks of a WPI undergraduate education. In addition to educating students in their major discipline, WPI's programs shall provide students with a broad preparation for fulfilling lives as responsible professionals and informed citizens.
4. Grounded in project and course experiences, a WPI education shall provide a firm foundation for life-long learning in a variety of fields. WPI programs shall emphasize inquiry-based learning and open-ended problem solving. Students shall bear a considerable responsibility for learning outside of the classroom.
5. WPI's programs shall be sufficiently flexible so as to allow students significant choice in and responsibility for planning their courses of study. Faculty, via the central teaching tasks of project and academic advising, shall ensure that student learning experiences encourage critical reflection, decision making, and personal growth.
6. WPI's programs shall emphasize the scientific, technical, societal, and humanistic contexts in which knowledge is applied and constructed. Education activities shall challenge students to make connections between disciplines, to consider multiple viewpoints, and to appreciate the consequences of their actions. The curriculum shall prominently feature integrative and interdisciplinary activities.
7. WPI's learning environment and educational activities shall balance personal responsibility and individual accountability with cooperation, collaboration and mutual respect. Members of the community shall be encouraged to value academic integrity, and to become conscious of the value that such integrity confers to themselves and to the community.
8. WPI shall be committed to assessment and improvement of student learning.

Graduates of WPI will:

1. have a base of knowledge in mathematics, science, and humanistic studies.
2. have mastered fundamental concepts and methods in their principal areas of study.
3. understand and employ current technological tools.
4. be effective in oral, written and visual communication.
5. function effectively both individually and on teams.
6. be able to identify, analyze, and solve problems creatively through sustained critical investigation.
7. be able to make connections between disciplines and to integrate information from multiple sources.
8. be aware of how their decisions affect and are affected by other individuals separated by time, space, and culture.
9. be aware of personal, societal, and professional ethical standards.
10. have the skills, diligence, and commitment to excellence needed to engage in lifelong learning.

WPI'S COMMITMENT TO PLURALISM

Pluralism, as a social condition, means that several distinct ethnic, religious, and racial communities live side by side, have equitable access to resources, are willing to affirm each other's dignity, are ready to benefit from each other's experiences, and are quick to acknowledge each other's contributions to the common welfare. Recognizing the importance of pluralism to creativity, innovation, and excellence, WPI is dedicated to creating an atmosphere that encourages diversity in all aspects of campus life—from academics, to residence hall living, to social interactions among students, faculty, and staff. The Institute recognizes the special obligation of promoting a multicultural community based on mutual respect and tolerance. This commitment is part of WPI's institutional plan for encouraging pluralism and increasing diversity, a plan that proclaims the importance of having students understand and appreciate other cultures, and prepares them fully to pursue rewarding careers in an increasingly global economy.

Concepts endorsed by the WPI Faculty on April 21, 1994.



WPI, the nation's third oldest private technological university, was established in 1865 by the New England industrialists John Boynton, Ichabod Washburn, and their associates. Boynton and Washburn endowed the first two buildings on campus, as academic classrooms and practical shops. Boynton Hall and the Washburn Shops — renovated today into state-of-the-art facilities — still preserve their distinctive original towers. These “Two Towers” represent WPI's continued commitment to academic excellence through real-life project experience that synthesizes classroom learning.

The “Two Towers” tradition of academic achievement and practical application is reflected in WPI's motto, “Lehr und Kunst” or “Theory and Practice.”

WPI has awarded graduate degrees since 1898, adding new programs regularly in response to the developing needs of the professional world. WPI is among the top 50 science colleges in the nation in terms of the percentage of undergraduates who receive doctorates. Presently, WPI offers the master's degree in 25 disciplines and the doctorate in 14.

The current student body of over 3,600 men and women includes about 1,000 full- and part-time graduate students. Currently, students attend WPI from almost every state and over 60 foreign nations.



THE WPI PLAN

In 1970 WPI adopted a revolutionary new undergraduate program known as the *WPI Plan*. The Plan replaced the traditional rigidly-prescribed curriculum — typical of conventional engineering education — with a flexible, exciting, and academically challenging program aimed at helping students to learn *how to learn*.

The Plan continues the “Two Tower” tradition by synthesizing classroom experience in projects that solve real-world problems. The WPI project program prepares graduates for their future professional lives by helping them learn how to identify, investigate and report on open-ended problems. Alumni indicate that project experiences also prepare them uniquely well for managing team efforts, and for communicating both in oral and written forms according to professional standards.

All WPI students complete three projects. The Major Qualifying Project (or MQP) challenges students to solve problems typical of those to be encountered in their professional discipline. The Interactive Qualifying Project (or IQP) presents an issue at the intersection of science, technology, and culture, and emphasizes the need to learn about how technology affects societal values and structures. Also, students complete a Sufficiency project on a theme emerging from a five-course, self-selected series of courses in Humanities and Arts, thus insuring that WPI students develop an understanding of the humanities as well as of technology. Taken together, the three projects emphasize that technological professionals must learn not only to create technology, but also to assess and manage the social and human consequences of that technology.

Global Program Sites



WPI students must prepare to live and work in the interdependent world of the next century. Professionals no longer can study, and live in ignorance of other countries and cultures, as professional practice and commerce increasingly cross over national boundaries.

WPI thus emphasizes real-world project experience, and provides extensive opportunities for studying the kinds of global issues that will dominate professional and political life in the 2000's.



To support classroom and project work, WPI makes every effort to provide students with hands-on experience with state-of-the-art research and support facilities. Below are a few of the facilities available to WPI undergraduates:

COMPUTER RESOURCES

RESOURCES IN FULLER LABORATORIES

WPI's newest academic building, Fuller Laboratories, is designed to provide dedicated space for faculty, staff and students working in the information sciences. The Computing and Communications Center (CCC) is located in this building, along with the Computer Science Department and the Academic Technology Center.

CCC provides a wide range of services and access to computer resources for the WPI community and manages an array of powerful UNIX, Linux and Windows servers. All WPI students, faculty and staff may obtain a login ID from the CCC for academic course works, research and self-education. The ID will remain in force as long as the person continues to be registered as a student or to be employed by WPI. The systems have been configured so that the user will see the same familiar environment no matter which CCC workstation is used. CCC facilities are accessible from a wide variety of locations on campus or from around the world via the campus connection to the Internet. CCC operates the campus data network and Internet connectivity, including a VPN (Virtual Private Network) to access internal resources remotely. Computer systems operated by academic departments are also on the same CCC communications infrastructure, so they are accessible just as easily.

The CCC facilities offer x-terminals with Linux servers, as well as high-end PCs and several Macs. In addition to several computer classrooms and specialized labs, the CCC supports open access labs in every academic building totaling hundreds of stations across the campus. Each of these labs offers the same user interface, software profile, and network access to personal files as does the CCC lab.

PC file servers drive laser printers in the CCC facilities and other locations across campus. Also accessible in the CCC are a color postscript laser printer and scanning devices. Since the campus network distributes computing services across the campus, network-attached PCs in other buildings can use the CCC print service to generate high-quality output for reports and resumes. The servers also provide file service for many software packages including PC-based desktop publishing, spread sheets, databases, programming languages, and department courseware.

CCC supports the residence and fraternity network services. Using their personal PCs, students in residence halls can access the same software and interface available in CCC PC labs across campus. A wireless network is available in all academic buildings as well as primary residence centers. Wireless laptops are available on loan for use in the library and campus center.

In addition to supporting the academic computing system on campus, CCC operates the administrative system

that provides data processing services to WPI administrative offices. The WPI information system provides ready access to important registration information. Students update their biographical information, check grades and drop/add courses over the network via the web interface to the administrative system.

CCC manages a computer help desk to answer users' questions on any of the computer platforms and to provide technical support for endorsed software packages. CCC also provides instruction sessions on supported software in the state-of-the-art computer-training classroom that the CCC maintains in the Gordon Library.

GENERAL COMPUTER SCIENCE DEPARTMENT FACILITIES

Fuller 2nd Floor

The department is housed in the specially designed Fuller Laboratories building, providing substantial office and laboratory space. A wide variety of computing equipment is available for course work, project work, and research in computer science.

The department has multiple Sun UltraSPARC, SGI, and Intel machines running Solaris, IRIX, Linux, and other operating systems, for interactive use. These may be accessed via roughly 70 PC's located in department offices, as well as from any of CCC's publicly available computers.

Every classroom, laboratory and office in Fuller Labs is connected to the campus-wide high speed communications network. The network provides access to other computing resources, including the Computing and Communications Center, and the Internet.

RESOURCES IN HIGGINS LABORATORIES

KECK DESIGN CENTER

[Mechanical Engineering]

The Computer Classroom

2nd Floor

The Keck Design Center contains computer workstations with state-of-the-art computer-aided design software for mechanical devices and is primarily used to support entry-level CAD courses. The software also allows the modeled geometry to be transported to other analysis packages available in the Center.

Laboratory lectures are held in this room which allows the instructor to lecture and the students have hands-on availability of the material being presented.

The Design Studio

2nd Floor

The Design Studio provides an environment linked by computational equipment and networks to outside manufacturing facilities. High-end Sun Workstations, with software support for video-picture-within-the-monitor teleconferencing, provide two-way communication of audio, video, and data between the Design Studio and to off-campus sites.

In the computationally equipped studio, students have clustered seating around multiple workstations. Design work can be done on the workstations and discussed or analyzed with off-campus sponsors or collaborators in real time as changes are made. Part files can be ported to

rapid prototyping machines or lithography units within the Design Studio and beyond. Video cameras at the prototyping stations show the real-time fabrication within a window on the workstations.

RESOURCES IN THE WASHBURN LABORATORIES

HAAS TECHNICAL CENTER FOR COMPUTER-CONTROLLED MACHINING

[Mechanical Engineering] First Floor

The center is primarily for undergraduate teaching and projects. The eight new CNC machine tools include a lathe with live tooling and a barfeeder, as well as two vertical machining centers with four, and more, axes. They are used in ME 1800, ME 3820, and ES 3323. The machine tools provide for the fabrication, i.e., realization, of parts, especially those designed on computers. The machine tools are important for supporting WPI's project based-education. The machine tools are also used in graduate education and manufacturing engineering research, as well as to produce apparatus to support research efforts in other fields. The center is part of a network of over 30 other colleges and universities in North America which also have Haas Technical Centers designed by Haas Automation, Oxnard, CA.

MANAGEMENT MICROCOMPUTER LABORATORY

[Management] Second Floor

The Management Microcomputer Lab contains fourteen personal computers that are networked to the University backbone. Spreadsheet, word processing, and database management packages are accessible from the lab, as well as software for simulation, quality control, and management science analyses. Students use the lab for course work and projects. The lab is open during normal business hours for the Department of Management and until 10 pm weekdays only.

THE MANUFACTURING DESIGN STUDIO

[Mechanical Engineering] First Floor

The eight (8) Sun workstations and 10 PCs, with CAD and CAM software, in the Manufacturing Design Studio are linked through WPI's computer network to the CNC machine tools in the Haas Technical Center. This provides a modern multi-user design and prototype production facility for student use for projects, research and class/lab work.

MANUFACTURING ENGINEERING RESEARCH CENTER

[Mechanical Engineering] First Floor

This consists of six laboratories: Haas Technical Center, Manufacturing Laboratory, Computer-aided Manufacturing Lab, Machining Dynamics Lab, Surface Metrology Lab, and the Robotics Lab. These include a wide variety of instrumentation, measurement and computational and facilities for the control and monitoring, modeling and design of manufacturing tools, products and processes. The center also has access to external machine shop facilities.

These labs combine a large machinery bay area with an attached air-conditioned computer laboratory. Equipment

in the Robotics Lab includes a number of industrial robots, a Coordinate Measurement Machine (CMM), a machining area with CNC machine tools, and specialized automation equipment interfaced to PLC's. The Surface Metrology Laboratory has scanning laser microscopes, conventional profilers, specialized software for analyzing measured surface fixtures, including fractal analysis. The CAM Lab includes several Unix-based engineering graphics workstations used for CAD, solid modeling, kinematics analysis, FEA, CIM and expert system development, and a number of computers set up for data acquisition and real-time control. Cooperative research is frequently done with faculty in many areas.

MIS/OIE ORACLE/LEAN LAB

[Management] Second Floor

The Department of Management is a participating member in Oracle Corporation's Oracle Academic Initiative. OAI participants integrate Oracle products in a number of their courses to provide students with real-world experience working with enterprise systems. The MIS/OIE Oracle/Lean Lab is located in WB228. In addition to 24 high-end desktop computers with flat panel screens, the lab houses numerous servers as well as specialized equipment and servers used for test purposes. Each computer is wired to the university backbone through a 100 megabit connection. Additionally, there is an internal network that is used with the Department's servers.

In addition to the computing resources available in the MIS/OIE Oracle/Lean Lab, moveable tables support process-oriented laboratories associated with lean design and the OIE program.

PROJECT AND EDUCATIONAL FACILITIES

ADVANCED CASTING RESEARCH CENTER

(See full description under Research Centers and Institutes on page 10.)

CENTER FOR HEAT TREATING EXCELLENCE (CHTE)

(See full description under Research Centers and Institutes on page 11.)

MORRIS (BUTCH) BOORKY POWDER METALLURGY RESEARCH CENTER (PMRC)

(See full description under Research Centers and Institutes on page 11.)

COMPUTER SCIENCE PROJECT LABORATORIES

Fuller

Because project work is a significant part of a WPI education, the Computer Science Department has several laboratories devoted to undergraduate and graduate project work. These laboratories have a wide variety of computer equipment available for student use.

DISCOVERY CLASSROOM

[Mechanical Engineering] Higgins: Second Floor

This state-of-the-art classroom provides a non-traditional, discovery-based learning environment that supports learning modules which unify the analytical, computa-

tional, and experimental engineering approaches. The room seats 90 and features experimental facilities that allow students to examine the details of physical phenomena during interactive class exercises. A multi-purpose laboratory adjacent to the classroom permits small-group exercises and design work.

ENGINEERING EXPERIMENTATION LABORATORY

[Mechanical Engineering] Higgins: Basement

The Experimental Laboratory provides the support for undergraduate courses designed to develop analytical and experimental skills in modern engineering methods based on current electronic instrumentation and computer-based data acquisition systems. Engineering analysis and design, and the principles of instrumentation are emphasized. The laboratory affords the student an opportunity to use modern devices in actual experiments in areas such as heat transfer, flow measurement and visualization, force/torque/strain measurements, motion and vibration measurements, and laser applications.

HAAS TECHNICAL CENTER FOR COMPUTER-CONTROLLED MACHINING

(See full description under Resources in Washburn Laboratories on page 9.)

MECHANICAL ENGINEERING PROJECT LABORATORY

[Mechanical Engineering] Higgins: Basement

The Project Lab is a dedicated multipurpose laboratory for Major Qualifying Projects, which need construction and storage space. This lab includes a fully staffed machine shop to assist the students in the design, layout and fabrication of components needed for students' experiments.

RESEARCH CENTERS AND INSTITUTES

A number of faculty members have formed multi-disciplinary research centers and institutes at WPI. These active research centers and programs provide excellent and unique interdisciplinary research opportunities. All of these centers and groups conduct outstanding state-of-the-art research sponsored by governmental and industrial agencies.

The centers listed and described below offer opportunities to undergraduates to work with ongoing research activities through MQPs, industrial internships, coop opportunities, summer employment and international project activities.

CENTER FOR HOLOGRAPHIC STUDIES AND LASER TECHNOLOGY (CHLST)

[Mechanical Engineering] Higgins: First Floor

The CHSLT was founded in 1978 and is furnished with state-of-the-art facilities which are used for research and educational activities. These activities range from fundamental studies of laser light interaction with materials to sophisticated applications in metrology.

The CHSLT research is in areas relating to microelectronics, radar technology, microtechnology, micromechanics, submarine technology, jet engine technology, avionics, biomedicine, modern powder materials, ceramics, composites,

energy systems, micro-scale material science and engineering, interconnection technology, and computational modeling. The strength of the CHSLT lies in a comprehensive utilization of laser technology, optics, computational methods, mechanical engineering, materials science and engineering, and computer data acquisition and processing. Building on these strengths, greatly diversified projects in a number of areas of current interest are being conducted using the Center's own technique and innovative methods.

The CHSLT develops and maintains cooperative and exchange programs with leading teaching and research institutions in the United States and abroad.

METAL PROCESSING INSTITUTE (MPI)

[Mechanical Engineering] Washburn: Third Floor

The Metal Processing Institute (MPI) is an industry-university alliance. Its mission is to design and carry out research projects identified in collaboration with MPI's industrial partners in the field of near and net shape manufacturing. MPI creates knowledge that will help enhance the productivity and competitiveness of the metal processing industry, and develops the industry's human resource base through the education of WPI students and the dissemination of new knowledge. More than 100 private manufacturers participate in the institute and their support helps fund fundamental and applied research that addresses technological barriers facing the industry. The MPI researchers also develop and demonstrate best practices and state-of-the-art processing techniques.

MPI offers educational opportunities and corporate resources to both undergraduate and graduate students. Specifically,

- International exchanges and internships with several leading universities around the globe—Europe and Asia.
- MQP opportunities with the industrial sector wherein the students spend the summer months prior to their senior year in industry.
- Graduate internship programs leading to a Masters or Doctoral degree where the research work is carried out at the industrial site.

For further details visit the MPI office on the third floor of Washburn, Room 326, or the MPI website: www.wpi.edu/+mpi.

MPI's research programs are carried out by three distinct research consortia. These are described below:

- Advanced Casting Research Center (ACRC)
- Center for Heat Treating Excellence (CHTE)
- Morris (Butch) Boorky Powder Metallurgy Research Center (PMRC)

ADVANCED CASTING RESEARCH CENTER (ACRC)

[Mechanical Engineering] Washburn: Basement

The laboratory provides experimental facilities for course laboratories and for undergraduate and graduate projects. The laboratory is equipped with extensive melting and casting facilities, computerized data acquisition systems for solidification studies, thermal analysis units, liquid metal filtration apparatus, rheocasting machines and a variety of heat treating furnaces. The laboratory has strong collaborations with industry and students work directly with professional engineers from sponsoring

companies. Fifty-five corporate members participate in and support the casting research programs. Student scholarships offered by the Foundry Education Foundation (FEF) are available through the laboratory. The ACRC conducts workshops, seminars, and technical symposiums for national and local industries. The laboratory is available throughout the year for project activity and thesis work as well as summer employment. Project opportunities at international sites are also available through ACRC/MPI.

CENTER FOR HEAT TREATING EXCELLENCE (CHTE)

[Mechanical Engineering] Washburn: Third Floor

The center is an alliance between the industrial sector and researchers to collaboratively address short-term and long-term needs of the heat treating industry. It is the center's intent to enhance the position of the heat treating industry by applying research to solve industrial problems and to advance heat treatment technology. The center's objective is to advance the frontiers of thermal processing through fundamental research and development.

Specifically, the center will pursue research to develop innovative processes to:

- Control microstructure and properties of metallic components
- Reduce energy consumption
- Reduce process time
- Reduce production costs
- Achieve zero distortion
- Increase furnace efficiency
- Achieve zero emissions

Over thirty-five corporate members participate and support the CHTE research programs. MPI project opportunities, industrial internship, and summer employment are available through CHTE/MPI.

MORRIS (BUTCH) BOORKY POWDER METALLURGY RESEARCH CENTER (PMRC)

[Mechanical Engineering] Washburn: Third Floor

The center addresses the scientific, engineering, and managerial problems of the powder metallurgy industry.

By integrating facilities from different disciplines, the center has developed research programs in engineering and management, addressing new technologies as well as methodologies for their implementation, i.e., valve creation and management issues in a small fragmented industry. The objectives of the PMRC are as follows:

- Establish an educational and research center for the powder metallurgy industry, and to provide a vehicle for manufacturing excellence and competitiveness of the industry.
- Establish long-term relationships between the academic community and members of management, manufacturing, and research in the industry.
- Develop course and project experiences for graduate and undergraduate students that will foster an understanding of the industry.

Eighteen corporate members participate and support the PMRC research programs. MQP project opportunities, industrial internships, and summer employment are available through PMRC/MPI.

RESEARCH LABORATORIES AND FACILITIES

These labs are MQP and research activity opportunities.

AEROSPACE LABORATORY

[Mechanical Engineering] Higgins: Basement

These experimental facilities provide support for courses, major qualifying projects, faculty and graduate student research. The facilities and instrumentation include a closed-return, high quality 2'x2' wind tunnel, a subsonic open-return wind tunnel with a 18"x24" test section, a supersonic flow facility, laser Doppler velocimeter, hot-wire anemometry system, laser diagnostics, an intensified camera system, and computer data acquisition systems, and an ultrasonic measurement system.

ANALOG/MIXED SIGNAL MICROELECTRONICS LABORATORY

[Electrical and Computer Engineering Department]

Atwater Kent

The Analog/Mixed Signal Microelectronics Research Laboratory comprises instrumentation, workstations, and software for the complete integrated circuit design and verification process. Full CAD software tools are available for schematic capture, simulation, layout, parasitic extraction, and layout-vs.-schematic verification. Fabrication facilities are available through MOSIS and industry partners. The equipment required to test the fabricated circuits (thereby verifying the design principles and completing the design process) has been purchased with a grant awarded by the National Science Foundation under the CISE Research Instrumentation Grant program.

Undergraduate projects and graduate research are ongoing in the areas of system-on-a-chip design for biomedical applications, self-calibrating analog-to-digital converters, and low-jitter phase-locked-loop systems.

ANTENNA LABORATORY

[Electrical and Computer Engineering Department]

Atwater Kent

The antenna laboratory focuses on the design and development of some basic and specialized antennas and antenna systems for measurement and testing purposes, including the Microwave Nondestructive Evaluation (Microwave NDE).

The antenna laboratory is equipped with the state-of-the-art measurement devices including Agilent8722 Network Analyzer (0.5-40 GHz), numerous signal sources, power meters, RF power amplifiers, and a full set of standard-gain horns covering the range from 1 to 30 GHz. The laboratory has been particularly active in the area of patch antenna design and in the UHF antenna design. The laboratory contains numerous facilities for the numerical simulation of diverse RF and radiating systems including 25 Ansoft HFSS v. 10.0 on site licenses and in-house Method-of-Moments software.

BIOMECHANICAL ENGINEERING LABORATORIES

[Mechanical Engineering] Higgins: First Floor

This complex provides experimental and computational facilities for the laboratory component of courses, major qualifying projects, and graduate research. The Biomechanical Engineering Laboratory complex includes the following:

The Biomechanics/Biofluids Laboratory: provides experimental facilities in the areas of biomechanics and biofluids. The laboratory has equipment for measuring force, deformation and kinematic variables as well as fluid flow, pressure and velocity. The laboratory contains PC-based computational and data acquisition facilities.

The Biomaterials Laboratory: is equipped for the evaluation of biological tissues, biomedical materials and surgical constructs with a focus on orthopedic and dental applications. The laboratory contains a computer controlled biaxial testing machine for use in these studies.

The Rehabilitation Engineering Laboratory: provides experimental facilities for the design, development and testing of electro-mechanical assistive devices. The Assistive Technology Resource Center is a part of the laboratory.

BIOPROCESS LABORATORY

[Biology and Biotechnology] Salisbury

The Department of Biology and Biotechnology has a 1600 square foot laboratory for courses, projects and research in bioprocess, which is the application of biotechnology and engineering principles to produce valuable products. This lab houses state-of-the-art equipment for fermentation, centrifugation, tangential flow filtration, rheometry, spectrophotometry, and high performance liquid chromatography. The lab is used for courses in Fermentation, Separation of Biological Molecules, Downstream Processing, and a course in Scale-Up that enables students to gain experience in bioprocessing at the 50 liter scale. This combination of facilities and courses gives WPI students experience unmatched by any other university in the country.

CENTER FOR SENSORY AND PHYSIOLOGIC SIGNAL PROCESSING - C(SP)2

[Electrical and Computer Engineering Department]

Atwater Kent

Researchers within the C(SP)2 apply signal processing, mathematical modeling, and other electrical and computer engineering skills to study applications involving electromyography (EMG - the electrical activity of skeletal muscle).

We are improving the detection and interpretation of EMG for such uses as the control of powered prosthetic limbs, restoration of gait after stroke or traumatic brain injury, musculoskeletal modeling and clinical/scientific assessment of neurologic function.

CENTER OF COMPARATIVE NEUROIMAGING (CCNI)

[Electrical and Computer Engineering Department]

Atwater Kent

CCNI operates two high-performance superconducting magnetic resonance (MR) scanners at field strengths of 4.7 T and 9.4 T. Both systems are used for imaging rodents

and rhesus monkeys. The lab designs and develops custom-tailored gradient and RF coil technology and switching electronics to conduct leading-edge functional imaging of fully awake animals.

CCNI occupies approximately 1200 sq. ft. floor space in AK014 - 018 and is equipped with high-end computer systems, network analyzers, LCR meters, frequency sweepers, gradient amplifiers, power supplies and other dedicated magnetic resonance imaging equipment. A number of powerful custom-developed numerical analysis tools (Method of Moments and Multi-Transmission Line models) are available to simulate the behavior of low and high-frequency coils in the presence of biological loads for a wide-range of imaging applications. Single and multi-coil RF systems for high and ultra-high fields suitable for cranial imaging of mice, rats, marmosets, and rhesus monkeys have been designed and implemented. The lab also develops multi-channel human head coils in clinical 3T and experimental 7T MR scanners.

Another focus of CCNI is the development of RF coils for high resolution breast imaging for early stage cancer detection. The lab is presently developing anatomically correct multi-mode and array coil configurations for deployment in commercial MR scanners.

CENTER FOR WIRELESS INFORMATION NETWORKING STUDIES (CWINS)

[Electrical and Computer Engineering Department]

Atwater Kent

The Center for Wireless Information Network Studies is a renowned compact wireless research laboratory with a successful history of research alliances with other industrial and academic groups. The center has performed research for government agencies and has close ties with the world-leading organizations in the wireless industry.

The core competence of the center is in indoor radio channel propagation measurement modeling and in the development of testbeds and tools for design and performance monitoring of wireless indoor networks.

CERAMIC PROCESSING LABORATORY

[Mechanical Engineering] Washburn: Third Floor

This facility serves the Materials Science and Engineering Program, the Manufacturing Engineering Program, and other departments. The laboratory contains a variety of powder processing and characterization equipment, as well as equipment for green body consolidation and sintering. A specially equipped room houses the electric discharge-machining laboratory.

CITY LAB

[Interdisciplinary and Global Studies Division] Project Center
In collaboration with:

[Electrical and Computer Engineering Department]

Atwater Kent

[Computer Science Department] Fuller

City Lab is an interdisciplinary laboratory dedicated to the study of cities and to the development of urban information technologies – both soft and hard – to assist municipalities in their maintenance, management and planning activities. The lab focuses on the collection, archival, manipulation and analysis of municipal informa-

tion that can be used for urban and environmental maintenance, management and planning. The lab assists project teams that complete urban and environmental Interactive Qualifying Projects at WPI Project Centers. Major Qualifying Projects with the Computer Science department foster the creation of web-based **urban information systems** that are incubated on City Lab servers to facilitate the dissemination and utilization of the accumulated city knowledge resulting from WPI's interdisciplinary and global studies. Innovative **urban technologies** are developed, through Major Qualifying Projects in City Lab's hardware laboratory located in the Electrical and Computer Engineering department, to automate the collection of urban information. City Lab also promotes a number of **urban initiatives** in a variety of service-learning contexts. Current initiatives include: the Hometown Initiative, the E-campus Initiative and the City Sounds Initiative.

COMPUTATIONAL GAS AND PLASMA DYNAMICS LABORATORY (CGPL)

[Mechanical Engineering] Higgins: Second Floor

The mission of CGPL is to develop and apply advanced computational methodologies in the modeling of complex gas and plasma flows. Research studies in CGPL are focused on aerospace systems and technologies that include: electric propulsion, spacecraft-induced environment interactions, small thruster internal and plume flows, rarefied gas dynamics, magnetogasdynamics, and crystal growth in microgravity. Strong emphasis is placed in CGPL's participation in space programs and missions. CGPL is equipped with several UNIX and personal workstations, data storage devices and printers.

CONVERGENT TECHNOLOGIES CENTER (CTC)

[Electrical and Computer Engineering Department]

Atwater Kent

The laboratories in this center combine diverse expertise for the exploration of the emerging and converging technologies of computing, communications and cognition. The Polaroid Machine Vision Laboratory (PMVL) and the Network Computing Applications and Multimedia (NETCAM) laboratory focus on the development of new algorithms and moving emergent technologies into commercial, medical and defense related applications for its sponsors.

Research in the NETCAM lab derives from the technologies generated by the success of the Internet, digital multimedia and distributed objects and middleware. Current projects explore the optimization of network protocols for multimedia, and other QoS (Quality of Service) dependent internet traffic, especially in satellite based and other extreme network architectures.

Research in the PMVL lab has resulted in the development of highly efficient algorithms and new theoretical performance bounds for machine vision, automatic target recognition and image fusion for optical, Radar IR, SAR, and SONAR data.

CRYPTOGRAPHY AND INFORMATION SECURITY (CRIS) LABORATORY

[Electrical and Computer Engineering Department]

Atwater Kent

The CRIS Laboratory conducts research and development in cryptography and its applications. One research focus are fast implementations of the next generation of public-key algorithms such as elliptic and hyperelliptic curve schemes. We work on fast software algorithms and efficient hardware architectures. The lab is equipped with industry-standard development tools for ASIC and FPGA target hardware. We also apply Xilinx FPGAs and Altera EPLDs to a new type of crypto systems which allow for a fast switch of private-key encryption algorithms ("algorithm agility").

Another research focus is the integration of cryptography and data security into new communication networks. We work on the design and implementation of security protocols for wireless networks, with an emphasis on wireless LANs. Another network type of interest are high-speed Asynchronous Transfer Mode (ATM) networks. We investigate system design and algorithmic issues.

DATA/KNOWLEDGE BASE RESEARCH LABORATORY

[Computer Science] Fuller

The Data/Knowledge Base Research Laboratory supports research in very large data and knowledge base systems. Current research covers three topics; 1) distributed warehousing; 2) XML data management; and 3) continuous query processing systems. The laboratory is equipped with a number of Intel-based PCs.

DISTRIBUTED PROCESSING LABORATORY

[Computer Science] Fuller

The Distributed Systems Laboratory supports research and project work in distributed processing and distributed systems. The laboratory is equipped with a number of Intel-based PCs.

FIRE SCIENCE LABORATORY

[Fire Protection Engineering] Higgins: Basement

The Fire Science Laboratory supports small-scale and medium-scale experimentation in fire dynamics, combustion/explosion phenomena, detection, and fire and explosion suppression.

Serving as both a teaching and research facility, the lab accommodates undergraduate projects as well as graduate students in fire protection engineering, mechanical engineering, and related disciplines.

FLUID DYNAMICS LABORATORY

[Mechanical Engineering] Higgins: Third Floor

This laboratory provides experimental facilities and instrumentation for experimental activities in the area of fluid dynamics. A small, open-return subsonic wind tunnel is available for use, and small experiments may be set up as required. Separate areas are provided for model preparation and small-scale experiments on space experiment packages.

HYDRODYNAMICS LABORATORY*[Mechanical Engineering] Higgins: Basement*

This laboratory provides experimental facilities and instrumentation for characterization of liquid flow phenomena. A free surface water tunnel with a 2x2-foot test section and vertical water tank are available. These facilities allow for flow visualization and are supported by data acquisition systems and various flow measurement devices.

LASER LABORATORIES*[Mechanical Engineering] Higgins: First Floor*

The laser laboratories are used for both research and educational activities. The labs are equipped with several systems utilizing He-Ne, Arion, and Nd:TAG Lasers.

The labs are supported by a self-contained network of computers and peripheral facilities, as well as supporting instrumentation systems. The lasers, computers and supporting instrumentation are used in studies of fundamental phenomena governing high-energy-density interactions in thin film imaging, with powder metal materials, plastics, ceramics and composites, micro-machining, underwater propagation, holography, displacement and strain measurement, vibrations, fracture mechanics, mathematical modeling, numerical computations and applications to other problems of modern science, engineering and technology.

MANUFACTURING LABORATORY*[Manufacturing Engineering] Washburn: First Floor*

A range of manufacturing processes (sawing, drilling, grinding, bending, MIG and spot welding, and a large selection of manual and Haas CNC machine tools and eight (8) workstations and 10 PCs with CAD/CAM software) are available to support the academic programs in Manufacturing Engineering and Mechanical Engineering. Students can also draw on many other resources available, including a wide variety of robots, a coordinate measuring machine, and CAD/CAM systems.

See the Manufacturing Design Studio and Haas Technical Center for computer-controlled machining, under Resources in Washburn Laboratories on page 9.

MATHEMATICS LABORATORIES*[Mathematical Sciences]*

To complement WPI's math classes, the department has two computer laboratories: The Statistics Multimedia Classroom, an interactive classroom with PCs; The Math Lab with X-terminals. The labs are also supported by a full time Computer Operations Manager and Instructors' Associates who assist students with their mathematical computer needs.

MECHANICAL TESTING LABORATORIES*[Mechanical Engineering] Washburn: First Floor*

Experimental mechanical testing laboratories are available for teaching and research related to mechanical properties and deformation of metals, ceramics, and composite materials. Equipment available includes: two computer-controlled Instron 8502 Servo-Hydraulic Tension-Compression Systems with supporting grips, environmental chambers, and furnaces; an Instron Model 4201 computerized tensile tester for high-accuracy, low-load testing of

ceramic materials; an ASCERA hydraulic tensile tester for brittle materials; two high-temperature and three room-temperature stress-rupture systems.

NUCLEAR MAGNETIC RESONANCE (NMR) IMAGING FACILITY*[Biomedical Engineering]*

A Nuclear Magnetic Resonance (NMR) Imaging facility is located at the Central Massachusetts Magnetic Imaging Center (CMMIC) and is part of a joint research program between the Biomedical Engineering Department and the Department of Radiology at UMass Memorial Health Care. This facility houses a General Electric (GE) 2.0 Tesla (T) imaging spectrometer as well as a chemistry/electronics laboratory for sample preparation and radio frequency coil research. In addition to the 2.0 T instrument, two GE 1.5 T clinical imaging instruments are also available at CMMIC for suitable research projects.

OPTICAL AND ELECTRON MICROSCOPY LABORATORIES*[Mechanical Engineering] Washburn: Second Floor*

One scanning electron microscopes (SEM), an analytical scanning transmission electron microscope (AEM), optical reflection and transmission microscopes, and supporting sample preparation and photographic equipment are the major facilities available for microstructural analysis. The JSM840 (SEM) is equipped with stage-automated digital image analysis, a light element (Uranium down to Boron) Quantum X-Ray detector with a Kevex Delta system, and a wavelength dispersive X-ray analyzer. The JEOL 100C (AEM) is equipped with a Devex 8000 EDX system. These facilities are used primarily for microstructural analysis and determination of crystal structures of fine phases present in metals and ceramics.

PAVEMENT RESEARCH LABORATORY*[Civil and Environmental Engineering] Kaven: Basement*

The pavement research laboratory provides support for research and courses, major qualifying projects, faculty and graduate student. It is well equipped to conduct complete characterization of pavement materials. The state of the art array of equipment includes compactor, moisture susceptibility testing equipment, loaded wheel tester and extraction and recovery equipment. The laboratory contains some of the most advanced testing equipment - most notable of these are the material testing system (capable of conducting a wide range of tests, including stress-strain tests, indirect tensile strength, repeated uniaxial loading, Quality Control/Quality Assurance (QC/QA) frequency sweep, resilient modulus, and triaxial shear strength), the Model Mobile Load Simulator (use of this equipment enables the simulation of a large amount of traffic within a short period of time and evaluation of long-term performance of pavement materials), and an array of Non Destructive Testing equipment consisting of the Portable Seismic Property Analyzer, Falling Weight Deflectometer and Ground Penetrating Radar. In addition, WPI researchers will have access to field instrumentation available from the Maine DOT full-scale pavement loading and testing program. A major focus of the pavement engineering program is on integration of undergraduate and graduate curriculum with research projects funded by

Maine Department of Transportation, Federal Highway Administration, New England Transportation Consortium and National Science Foundation.

SATELLITE NAVIGATION LABORATORY

*[Electrical and Computer Engineering Department]
Atwater Kent*

This laboratory provides facilities for work on civilian uses of satellite systems, especially the Global Positioning System. Receivers, signal processors and computers are provided for work on the utilization of the DOD BPS system for civilian purposes, especially aircraft navigation and landing.

SIGNAL PROCESSING AND INFORMATION NETWORKING LABORATORY (SPINLAB)

*[Electrical and Computer Engineering Department]
Atwater Kent*

The Signal Processing and Information Networking Laboratory (spinlab) provides test equipment and computational resources for MQPs and directed research projects in the areas of digital signal processing, wireless communication systems, software radio, and networking. Recent project sponsors include Bose Inc., General Electric Inc., DARPA, and NSF.

SOFTWARE ENGINEERING RESEARCH LABORATORY

[Computer Science] Fuller

The Software Engineering Research Lab houses the various software engineering projects led by Prof. George Heineman. The coordinating theme behind the projects is a strong emphasis on developing component-based software systems (CBSE) and providing tools and technologies to support CBSE. Professor Heineman actively pursues research in component-based software engineering, refactoring legacy systems to extract reusable software components, and approaches to monitor complex component-based systems.

SURFACE METROLOGY LABORATORY (SURF MET LAB)

[Mechanical Engineering] Washburn Second Floor

The Surf Met Lab is dedicated to supporting product and process design by advancing the understanding of surface topographies (i.e.; roughness) and the processes which make them. Topographic characterization methods are developed for the reduction of large topographic data sets, such as those acquired by atomic probe microscopy, confocal microscopy, scanning interferometric microscopes, and conventional profilers. The Surf Met Lab has: two scanning laser profilers, a scatterometer (ARS), and a conventional profiler. In addition, the Surf Met Lab has access to AFMs and other equipment through collaborations in the US, and Europe. The Surf Met Lab also has the use of sophisticated analysis software which employs fractal geometry principles.

ULTRASOUND RESEARCH LABORATORY

*[Electrical and Computer Engineering Department]
Atwater Kent*

The Ultrasound Research Laboratory is a 1200 sq. ft. facility, with office space for 5 graduate students and research space for ultrasound experiments, numerical modeling work, and development of electronic circuits. An experienced electronic technician is also part of the lab.

The lab is set up for a wide variety of medical ultrasound development work, including 3D ultrasound hardware and software, development of custom ultrasound systems, and development of ultrasound phantoms. The lab is equipped with medical ultrasound scanners modified for research purposes, such as the HP ImagePoint digital ultrasound system. Ultrasound pulser/receivers and measurement tanks are available, including a scanning tank with stepper motor controlled positioning system for the ultrasound measurements. General instrumentation includes LeCroy digital oscilloscopes, a LeCroy arbitrary function generator, a 350 MHz Tektronix oscilloscope, a HP 3585A Spectrum Analyzer, frequency synthesizers, and plotters.

VIBRATIONS/CONTROL/DYNAMICS LABORATORY

[Mechanical Engineering] Higgins: Basement

The Vibrations Laboratory supports educational, project, and research activities in the areas of vibrations and controls. The equipment housed in this lab includes signal analyzers, a 100-lb. shaker table, and computational hardware and software for various vibrations and controls applications.

VISUALIZATION AND IMAGE SCIENCE LABORATORY

[Computer Science] Fuller

The VIS Laboratory is used for research in visualization, graphics, image processing, and computer vision. Current projects include large-scale multivariate data visualization, volume visualization, multiple object recognition, and model-based vision. The Lab contains an Intel-based server, several SGI workstations (an Octane, 2 O2's, an Indy, and an Indigo 2), and a Pentium 2 PC.

VLSI DESIGN LABORATORY

*[Electrical and Computer Engineering Department]
Atwater Kent*

The VLSI laboratory supports state of the art design facilities based on both PC and workstation systems. These systems and software are available for the design, testing, simulation, layout and generation of analog, digital and mixed signal integrated circuits.

The software available is based on Tanner Tools for undergraduate and graduate course work, and on Tanner Tools or Cadence Design Systems EDA tools for project and thesis work. Both sets of tools support analog and digital design work. Additionally, the Tanner tools can be used for basic MEMS design work.

Integrated circuits can be fabricated through the MOSIS facility.

X-RAY DIFFRACTION LABORATORY*[Mechanical Engineering] Washburn: Second Floor*

Two fully-automated and computerized x-ray diffractometers are available for teaching and research. In addition, a variety of software has been developed to utilize these instruments effectively. Currently, background modeling, peak searching, and curve fitting with deconvolution, are in use for quantitative phase analysis and residual stress analysis. Search of the JCPDS Powder Diffraction File is available. A variety of x-ray cameras and goniometers are available along with the choice of x-ray tubes targets to provide a wide x-ray diffraction capability. Additional support software is shared with the Electron Microscopy Facility to generate diffraction patterns for any crystal system in any desired orientation.

MUSIC AND THEATRE FACILITIES

COMPUTER MUSIC LABORATORIES*Daniels Hall*

These laboratories support creative and research activity in a variety of music- and sound-related applications including real-time virtual orchestra design and production techniques. The lab contains hardware and software for multi-track digital recording and editing, signal processing, algorithmic composition, sound synthesis, MIDI sequencing, music notation, and music programming.

GREAT HALL OF ALDEN*Alden Memorial: First Floor*

The Great Hall is used for major productions in Theatre and Music. It is the venue for the Masque Theatre performances. The Hall is sometimes used, in addition, for festive and gala campus functions.

THE LITTLE THEATRE*Sanford-Riley, Lower Level*

Made possible with a major gift from the George I. Alden Trust, this intimate, a 99-seat black-box style theatre is the university's first dedicated theatre facility. With its flexible layout and moveable seating, permanent lighting grid and sound system, control booth, greenroom/dressing room, and handicapped accessibility, the Little Theatre, a new home for the university's diverse theatre programs, is well suited for a wide range of dramatic presentations. For more information, see <http://users.wpi.edu/~ltheatre>.

GREEN ROOM*Alden Memorial: First Floor*

Alden Hall houses many of the theatre activities at WPI, both academic and extra-curricular. The Green Room serves as the laboratory for Department of Humanities and Arts, Division of Drama Theatre Performance projects and Sufficiencies, MQPs and IQPs. The sub-basement contains the scene shop and props-storage area and also holds a major work room for Lens and Lights. Students interested in theatre performance and Lens and Lights activities have many resources in Alden Hall.

SPAULDING RECITAL HALL AND OTHER ROOMS FOR REHEARSAL AND PERFORMANCE*Alden Memorial: Lower Level*

Alden Center for the Performing Arts houses the Spaulding Recital Hall, Perreault Chamber Rehearsal Room, the Janet Earle Choral Rehearsal Room, three practice rooms, and the Knight Lecture Room. Available for practice are Steinway grand pianos and the Three Manual Aeolian-Skinner pipe organ in the main Concert Hall. There are three concert grand pianos for recitals, ensemble work and concerts. WPI has some instruments that can be made available to students upon request.

OTHER MUSIC FACILITIES

Music facilities also include The Janet Earle Room, The Perreault Chamber Rehearsal Room, the music classroom, practice rooms, computer music labs and storage facilities.

DRAMA/THEATRE RESOURCE LIBRARY

The Department of Humanities and Arts Drama/Theatre Resource Library, housed in Salisbury Labs Room 20 and available as posted, contains publications, magazines, published scripts, and other information to assist students working on projects (MQP, IQP, Sufficiency, ISP) in Drama/Theatre. Scripts for current productions can usually be found nearby the Resource Library on the table in the center of the main Humanities and Arts area. Most resource items and display scripts must be used in the immediate area, and this service is not per se a lending library.

GEORGE C. GORDON LIBRARY

The George C. Gordon Library invites all WPI students to take advantage of the services and resources that the library offers. The library is open over one hundred hours each week during the academic year and offers a stimulating atmosphere for study. Technology infused work spaces are available for individual or group work, and scholarly resources in all formats are provided. Media and popular reading collections for recreational purposes are also available.

The library's Web site (<http://www.wpi.edu/+library>) is the focal point for library resources and services. The library catalog, electronic journals and books collections, databases, course-specific information, and many other resources are available from it. Access to WPI users who are off-campus is available through the proxy server.

The library collection supports the curriculum and research needs of the WPI community. Currently the library holds 25,000+ electronic journals, 2900+ print journals, 29,000+ electronic books, 181,000+ print books, and 150+ research databases. The library collection also includes undergraduate project reports, graduate theses and dissertations, the WPI Archives and Special Collections, most notably the Robert Fellman Dickens Collection.

WPI students also have access to the collections of other academic libraries within Central Massachusetts thanks to the library's membership in the Academic and Research Collaborative (ARC). You can find out which libraries

participate in this program or acquire an ARC cross-borrowing card by visiting Gordon library. Students can also request materials not held in Gordon Library through the Interlibrary Loan Office and Document Delivery service. Students will find that the Gordon Library staff is both knowledgeable in the use of library resources and ready to assist them with their information needs. The Reference Department helps students with research problems and questions, offers library instruction and orientation sessions, and provides research consultations to individuals and to project groups. Members of the staff will be happy to provide students with additional information about library services and resources.

ACADEMIC TECHNOLOGY CENTER

The main office of the Academic Technology Center (ATC) is located in the southwest corner on the 1st floor of Fuller Laboratories. The ATC provides a wide variety of technology-based services in support of the teaching and learning needs of students, faculty and staff, and serves as the central coordinating and distribution hub for most of the audio/visual equipment utilized on campus. The ATC supports all of the technology available in WPI's electronic classrooms and conference rooms. In addition, instructional technology and audio/visual equipment can be reserved and signed out for short periods of time to support educational needs. Equipment loans are for valid WPI projects and classes only, and are not for personal use. The ATC's inventory of loan-out equipment includes laptop PCs, video/data projection systems, digital cameras, digital voice recorders, portable video equipment, TVs, VCRs, DVD players, overhead projectors, small and large screens, and other miscellaneous items such as portable storage, laser pointers, tripods, cables, etc.

In addition, the ATC offers graphic production services to faculty, staff and students. These include large format poster printing, image scanning and printing and converting 35mm slide to digital images. Workshops on using multimedia and presentation graphics software, as well as covering effective design techniques are offered throughout the year.

Extensive multimedia development tools are available in the multimedia resource lab located in the Gordon Library, Room 208 (next to the Circulation Desk). The multimedia resource lab (a.k.a. the Movie Lab) contains 15 Multimedia PCs, DVD/RWs, two flatbed scanners, a PDF scanner, and an instructor station for workshops and classes. Each computer is fully loaded with popular multimedia software, including Photoshop, Premiere, Publisher, 3D Studio Max for animation as well as the Microsoft Office Suite and the full version of Acrobat. Students, faculty and staff have the option of producing their own materials with or without the assistance of ATC staff.

The ATC is also responsible for *myWPI*, the university's learning and information portal. The *myWPI* portal is used in support of WPI's academic programs, but also services the communication and collaboration needs of

student organizations, faculty/staff committees, and other campus-wide initiatives. The *myWPI* portal is located at my.wpi.edu. For the fastest assistance, please e-mail the *myWPI* support team at myhelp@wpi.edu.

A state-of-the-art instructional television classroom/studio and two adjacent control rooms are also available and are used primarily in support of WPI's distance learning program – the Advanced Distance Learning Network (ADLN). Members of the WPI community who wish to produce a video in support of an educational activity can obtain professional assistance from the ATC (advanced notice is required). Production costs are usually covered by the ATC. On-location production using portable equipment can also be arranged but require additional preparation and planning.

The head end of the WPI cable TV network is located in the ATC. Announcements pertaining to campus events can be shown on the WPI Video Bulletin Board (submissions can be made from the ATC website). In addition, the ATC operates and maintains WPI's satellite receiver, capable of receiving both Ku and C-based transmissions and ISDN/IP-based videoconferencing systems.

For more information about the services available from the ATC, please refer to the department's website at <http://www.wpi.edu/+ATC>.

ADVISING AND STUDENT SERVICES

STUDENT DEVELOPMENT AND COUNSELING CENTER

The WPI Student Development and Counseling Center (SDCC) provides a wide range of services that are FREE of charge to all students enrolled in classes at WPI. The primary purpose of the SDCC is to provide counseling, educational programming and training, referral, and crisis intervention services to the entire WPI student community focusing on 1) assisting students in their full and complete development as they go through the process of becoming adults so that they may achieve greater levels of personal, academic, and professional success, and 2) assisting students in becoming aware of, and effective in, their roles, relationships, and responsibilities as members of an ever burgeoning global society. The professional staff are trained to help students deal with a variety of issues including:

Situational Problems— poor academic performance; managing stress; time management; relationships with significant others; divorce or other family problems; feelings of loneliness, anger, anxiety, confusion, depression; loss; discrimination; harassment; alcohol or other substance problems; sleep disturbances; medical/physical conditions; learning disabilities.

Crisis-Related Problems— physical and/or sexual assault; impulse control problems; suicidal thoughts or behaviors; traumatizing experiences such as date rape, academic setbacks, or the loss of a loved one.

Developmental Issues— developing self-esteem; establishing personal and/or gender identity; helping to define sexual orientation; managing stress from earlier traumatic events; exploring personal and professional goals.

The SDCC staff can also provide referral services for psychiatric evaluation, psychological and learning disability assessment, or other treatment.

The services of the SDCC are confidential. The mental health professionals and support staff are highly trained and sensitive to students' privacy and personal concerns.

The SDCC is located at West Street House, 157 West Street, near the corner of Institute Road. Appointments may be made during the academic year (A through E terms) in person or by calling (508) 831-5540. Office hours are 8:30 a.m. to 5:00 p.m. Monday-Friday (8:00 a.m. to 4:00 p.m. June to mid-August).

MAJOR SELECTION PROGRAM, A SERVICE OF THE CAREER DEVELOPMENT CENTER

Choosing a college major and its associated careers is one of the most important decisions you will make. The Major/Career Selection Program, or MSP, provides you the means to make that decision in an informed manner.

Why? We know that if you are in the "right major" and knowledgeable about the career paths available to you, you will enjoy your coursework, do better academically, and have a passion for your chosen work following graduation.

How can you select a major or learn more about a particular career path that leads to satisfaction? The answer is easy, through the information and experiences the MSP offers.

Contrary to what most people think, the MSP is not just for first-year students. It can help any WPI student to explore, identify and select a major and/or career field.

MSP activities include, but are not limited to:

- Academic Department presentations
- Company tours
- B-term seminar
- Career tests
- Individual Counseling

The CDC is located in the lower level of the Project Center. Appointments may be made in person or by calling (508) 831-5260. Office hours are 8:30am.-5:00pm.

MASH (MATH AND SCIENCE HELP) PROGRAM

MASH is an academic support program for first-year students in mathematics and science courses. Offered to *all* students enrolled in a supported course, MASH provides assistance in regularly-scheduled study sessions beginning the first week of the term.

MASH review sessions are offered for a limited number of courses which students and faculty have identified as difficult. These courses may have heavy homework assignments or they may require understanding of new and difficult concepts. Whatever the reason, some courses are more challenging than others. MASH helps students meet that challenge.

Each study group is guided by a MASH leader, an undergraduate student who has taken the course before and who, therefore, understands the course material and what the instructor expects. MASH leaders attend all class lectures, take notes, complete assigned readings and other assignments, and conduct three or four 50-minute MASH sessions each week. By attending class and demonstrating effective student behavior, MASH leaders can assist students with the language of the discipline, the integration of lecture and readings, and the development of good study habits.

Through the MASH program, students become actively involved with the content material in a supportive environment. Studies show students who attend MASH sessions regularly earn higher grades than students electing not to participate. But even more important, MASH participants master new concepts, learn to put ideas into perspective, and develop a better way to study. MASH is offered by the Office of Academic Advising.

ACADEMIC RESOURCES CENTER

WPI's Academic Resources Center (ARC) provides academic support services that are designed to enrich and enhance the learning experience of all WPI undergraduate students. Its student-based collaborative learning environment offers individualized assistance in a variety of subjects, as well as a comprehensive peer tutoring program, seminars and workshops.

Students may obtain individual counseling in such areas as learning styles, effective study strategies, problem solving and critical thinking skills, and time management. Appointments may be set up with staff members to develop individualized Academic Success Plans which help students set their academic goals, discover their learning strengths and weaknesses, and design the appropriate learning and study strategies that work best for them.

Students may call (508) 831-5281 for an appointment.

Periodically, students may find that they need some individual assistance with a particular subject or topic. The ARC peer tutors, who are certified by the College of Reading and Learning Association, help students one-on-one in a variety of academic subjects. Tutors are available on a walk-in basis Monday through Thursday. See www.wpi.edu/Admin/ARC/tutorschedule.pdf for an up to date tutor schedule.

The Academic Resources Center is located in Daniels Hall.

STUDENT DISABILITY SERVICES OFFICE

The mission of the Student Disability Service Office is to ensure that all students with disabilities can freely and actively participate in all facets of University life; to provide and coordinate support services that enable students with disabilities to maximize their educational potential and to increase the level of awareness among members of the University so that students with disabilities are able to perform at a level limited only by their abilities, not their disabilities.

By law, it is the student's responsibility to identify himself/herself to the Student Disability Services Office (DSO) and to provide documentation of the disability by a licensed professional. (Please note that the documentation for students with learning differences and ADD/ADHD must be dated within the last three years.) All students who have been admitted to WPI have the opportunity to self-identify their disability (physical and/or learning) by filling out the bottom portion of the Voluntary Disclosure form which is enclosed in the New Student Orientation Package. Students should send this form, along with the supporting documentation, to the DSO. Students with disabilities, who are diagnosed after their admission to WPI, must also provide appropriate documentation to the DSO, if they wish to receive accommodations.

For further information please visit the Disability Services web page at <http://www.wpi.edu/Admin/Disabilities/transition.html>. The Disability Services office, located in Daniels Hall, is open Monday – Friday 8:00 a.m. – 4:30 p.m. Students may drop in or call (508) 831-5235 for an appointment.

WRITING WORKSHOP A Division of the Center for Communication Across The Curriculum (CCAC)

The Writing Workshop offers all WPI students tutorial assistance on writing of any type: course assignments, project work, oral presentations, laboratory reports, proposals, resumes, and letters of application. The workshop is directed by a member of the Humanities and Arts Department faculty and staffed by student peer tutors, all of whom have been trained in a special course on tutoring writing. Students may be referred to the Workshop by faculty, or students may make appointments on their own initiative. The workshop is open according to posted schedules, and its tutorial services are available at no cost.

For more information, visit the CCAC website: www.wpi.edu/twwriting or drop in at the Project Center.

WRITING COURSES AND ADVISORS

For information on WPI's writing programs, see Humanities and Arts faculty as follows:

Students for whom English is the native language can consult Prof. J. Trimbur (39 Dean St., Room 258) about these programs.

The WPI advisor for undergraduate students whose native language is not English is Prof. J. Forgeng (SL 08).

WORLD WIDE WEB

The WPI World Wide Web server is the campus information system. It contains a great deal of useful information about people and programs at the university, and is updated frequently. In addition, by using the Web, students gain access to a vast universe of information on any subject imaginable. This is why the Web is such a useful research tool for both faculty and students.

WPI's Web address, or URL, is: **www.wpi.edu**. Questions about WPI's Web site should be directed to the Web Development Office, webmaster@wpi.edu.

THE WPI PLAN

S E C T I O N

one

WPI Degree Requirements	21
The Planning Process	22
Academic Advising	23
Major Areas of Study	24
Concentrations	25
Minors	25
Double Majors	26
Minimum Distribution Requirements for Students	27
Courses Qualifying for Engineering Distribution Areas	35
Projects	35
Projects Program	37
Project Centers	37
The Major Qualifying Project	39
The Interactive Qualifying Project	39
Residential Project Programs	47
On-Campus IQP Programs	52
The Sufficiency	53
The Social Science Requirement	60
Awards and Prizes	60

WPI's academic requirements are specifically designed to develop an overall educational experience which meets the goals of the college. Each requirement plays a supporting role as follows:

- To provide intellectual breadth and a better understanding of themselves, their cultures and their heritage, every WPI student must complete a **Humanities and Arts Sufficiency Project**;
- To provide an understanding of the priorities of other sectors of society, develop the ability to communicate effectively with disparate groups, organize and derive solutions to complex problems, and gain an awareness of the interrelationships between technology and people, every WPI student must complete an **Interactive Qualifying Project (IQP)**;
- To provide a capstone experience in the professional discipline, to develop creativity, instill self-confidence and enhance the ability to communicate ideas and synthesize fundamental concepts, every student must complete a **Major Qualifying Project (MQP)**;
- To provide for learning through an academic program with fabric and course balance while encouraging individual student choices within that framework, every student must fulfill **Distribution Requirements**.

WPI TERMS AND CREDIT UNITS

The Bachelor of Science degree from WPI normally is based upon a residency at WPI of 16 terms. WPI operates on a quarterly system with four seven-week *terms*, two in the autumn semester (Terms A and B) and two in the spring semester (Terms C and D). A seven-week summer session, Term E, is also available. The normal academic load for each term is defined as *one unit* of work, usually divided among *three* courses or projects. Thus, the usual credit unit for courses or independent study/projects is 1/3 unit. *Qualifying Projects*, defined on pages 35-37, require one full unit of activity which may be concentrated into a single term (especially if conducted off-campus) or spread throughout an academic year. The degree will be awarded upon completion of the following:

DEGREE REQUIREMENTS

1. **The Humanities and Arts Sufficiency Project** (See page 53)
Qualification by overall evaluation of two units of work in the area. Students majoring in a scientific or engineering field or in business management or the social sciences fulfill the requirement in a humanities and arts area. Students majoring in a humanities and arts area fulfill this requirement in a scientific or engineering area.
 2. **The Interactive Qualifying Project** (See page 39)
Successful completion of a qualifying project relating science and/or technology to society (the Interactive Qualifying Project, or IQP) representing at least one unit of credit in project or independent study work. The format of the documentation is to be in accordance with current WPI policy on such documentation.
- An IQP shall address a topic relating science and/or technology to society. In this context, both "society" and "technology" should be construed as broadly as possible. Technology refers to the application of rational and efficient principles to a body of knowledge or to the control of space, matter and/or human beings. Thus, the IQP encompasses not only techniques of production embodied in tools and machines, but also advances in methods of social and economic organization, in managerial techniques, and in methods of analysis in science, mathematics, and engineering. Society refers not only to a grouping of individuals but also to the culture, values, laws, customs, and institutions shared by these individuals.
3. **The Major Qualifying Project** (See page 39)
Successful completion of a qualifying project in the major area of study (the Major Qualifying Project, or MQP) representing at least one unit of credit in project or independent study work. The format of the documentation is to be in accordance with current WPI policy on such documentation.
 4. **Distribution Requirements** (See page 27)
Satisfaction of published academic activity distribution requirements in or relating to the major area of study. These requirements total no more than ten units (including the MQP) and are specified by general topical subject area, not by specific courses. Completion of distribution requirements will be certified by the appropriate departmental or Interdisciplinary and Global Studies Division (IGSD) Program Review Committee (PRC), upon recommendation by the student's academic advisor. For students desiring designation of a major area for which a determination regarding distribution requirements has not previously been made and published, a faculty committee will be appointed by the department head or IGSD dean to review and approve the student's program of study.
 5. **Social Sciences** (See page 60)
Completion of 2/3 unit of work in the social sciences, exclusive of qualifying project.
 6. **Residency Requirement**
A minimum of eight units *must* be completed satisfactorily in residence at WPI. (It is anticipated the normal residence at WPI will be 16 terms.)
 7. **Minimum Academic Credit**
The minimum academic credit required for the Bachelor of Science Degree is 15 units. Credit accumulated beyond the published distribution requirements shall be accomplished by the addition of "free elective" work.
 8. **Physical Education** (See page 168)
Qualification in physical education shall be established by completing 1/3 unit of course work (four PE classes) or its equivalent. Such an equivalent, for example, may be participation in club or varsity sports.

PLANNING FOR PROFESSIONAL DEVELOPMENT

To prepare fully for the challenges of professional work and further education, during the normal 16 terms (i.e., four years) of residency, WPI students should make the most of the many important and exciting educational programs available under the Plan *in addition to* the formal degree requirements as stated above. Therefore, from the beginning of their education at WPI, all students should consider seriously the following key activities which can enrich the basic program (see below):

- Courses or projects taken to prepare for the IQP.
- Projects taken to explore new fields of interest.
- Participation in one of WPI's foreign exchange programs or international project centers.
- Study in areas of management, economics, or law.
- Expansion of project depth in the IQP or MQP areas.
- Additional advanced courses in your own and related fields, including graduate courses.
- Participation in the WPI B.S./M.S. program—an excellent gateway to the M.S. degree.

- Special course work at a liberal arts college through the Worcester Consortium.
- Exploration of that "other area" of science, computer science, or engineering that you always wondered about.
- Double majors involving both technical and nontechnical fields.
- Special programs of study for Entrepreneurship.
- Pursuit of a minor in an area of interest.

The opportunities at WPI are extraordinary for those who wish to develop the full degree of professional depth and educational breadth which are the hallmarks of WPI's education.

Students are strongly encouraged to discuss the advantages of graduate study with their departmental advisors in the sophomore, junior, and senior years. Excellent opportunities exist to integrate upper level courses with graduate study at WPI through the WPI combined B.S./M.S. program described on pages 74, 106, 144, 173 and 263.

THE PLANNING PROCESS

At WPI, students, with the aid of their advisors, structure their own academic programs within the guidelines of the program distribution requirements. Thus, examples of specific programs presented in this catalog do not have to be followed literally. There can be as many different individual programs as there are students, provided the distribution requirements designated for that program are followed.

An undergraduate program should avoid premature over-specialization. Students must obtain a firm, rigorous understanding of the fundamental concepts of their disciplines. An acquaintance with an aspect of state-of-the-art technology is often best achieved through the MQP. Concentrating too soon on changing technological specialties will deprive students of the broad background necessary to educate themselves in new areas as they emerge. Students in engineering, for example, must obtain a firm grounding in mathematics and science, as well as the engineering sciences. Some study *in at least one other area of engineering outside* the major field is highly valuable for professional practice.

The IQP should be integrated carefully with your overall program, especially the social science requirements. Establish your plans early to take advantage of exciting opportunities WPI offers, at home or abroad. (IQP and exchange opportunities are discussed annually in the fall.)

Information on programs can come from many sources: advisors, other faculty, other students, professionals in the field. As soon as possible in the first year, students will discuss their academic goals with their advisor and plan a general academic program for their entire residence at WPI. If changes in details or even major goals occur, students can integrate them into a cohesive educational pattern which can maximize WPI's unique program. As students mature, their confidence about making decisions for their own education will grow, too. Indeed, accepting responsibility for

program planning is a major and exciting educational effort. Students consult with their advisors, but *the final responsibility for program construction remains with each student.*

Through courses and independent studies in the first two years, students should sample, explore, and learn the basic concepts of the disciplines necessary to their academic goals. This exploration and sampling will provide, first, a base of knowledge to build upon for further learning; and second, an insight into their basic interests for educational development.

In the latter portion of the academic program, students have the opportunity as they mature to explore, in some depth, specific areas within their disciplinary interests. These experiences should develop ability in self-learning and should involve a significant scholarly effort. Students should strive to learn how to educate themselves from a base of fundamental concepts so that they can develop in new intellectual areas throughout their lifetime.

PROFESSIONALLY ACCREDITED PROGRAMS

WPI is accredited as an institution by the New England Association of Schools and Colleges. In addition, a number of major areas are accredited within their specific disciplines. Seven majors at WPI are accredited by the Engineering Accreditation Commission of ABET. These majors are *biomedical engineering, civil engineering, chemical engineering, electrical and computer engineering, industrial engineering, mechanical engineering, and manufacturing engineering.* *Computer Science* is accredited by the Computing Accreditation Commission of ABET. Please note that some departments bearing those particular names may also grant designated majors through their programs that are *not* ABET accredited (e.g., Sanitary Engineering). The titles of majors are carried on the students' transcripts and have a bearing on engineering licensing and other professional activities.

Programs *other than* biomedical engineering, civil engineering, chemical engineering, computer science, electrical and computer engineering, industrial engineering, mechanical engineering, and manufacturing engineering are *not* ABET accredited.

The program distribution requirements reflect the ABET guidelines for these programs; see pages 27-34 for a review of these guidelines.

Projects and courses carry the same credit weight in establishing all distribution levels. Establishing some engineering breadth and technical literacy *outside* one's own field is an important element in establishing a versatile background for an unknown future.

The Chemistry and Biochemistry Department and its program at WPI are approved by the American Chemical

Society for a major in chemistry. Those chemistry majors who complete a program satisfying the guidelines established by the American Chemical Society are certified to that organization as having received an undergraduate professional education in chemistry.

The undergraduate and graduate business offerings in the Department of Management are accredited by AACSB International, the Association to Advance Collegiate Schools of Business. AACSB International is a not-for-profit organization consisting of more than 900 educational organizations and corporations. Its mission is excellence in management education in colleges and universities. Headquartered in St. Louis, AACSB International is the premier accrediting agency and service organization for business schools.

ACADEMIC ADVISING

As a student, you have the responsibility of choosing your own program of studies. Your advisor can inform you of available academic alternatives. While your advisor will be willing to suggest specific study programs, he or she will not insist that you follow a particular course of study. By the end of the first semester, you and your advisor should agree upon a tentative four-year academic plan.

A successful advising program is based on a cooperative and understanding relationship between student and advisor. Consult your advisor regularly. Drop in and tell your advisor how the term is going. If you add or drop a course, you should notify your advisor. Many advisors post office hours during which they are available for conversation. If you cannot find your advisor in his or her office, leave a note with the appropriate departmental secretary, indicating your wish to make an appointment; in that note, indicate several times when you could meet with your advisor and also indicate the means by which you can be contacted. Above all, do not hesitate to call or e-mail your advisor on campus, to ask questions, or to arrange for an appointment.

FIRST-YEAR ADVISING (PRE DECLARATION OF MAJOR)

Under WPI's Insights Program, first year students are advised by a small number of faculty academic advisors who make a real commitment to working with groups of students, usually in their residence halls. New students

are assigned an Insight advisor who advises a group of 25 to 30 students. These advisors represent all the departments and programs at WPI, and in many cases are the senior faculty members and the most experienced advisors. At WPI, first year advising is much more about mentoring students and much less about course scheduling. Each group is also assigned a peer advisor whose main role is to assist the academic advisor. At the end of the first semester, in December, students officially declare their majors and are assigned an advisor from the department of the declared major.

UPPERCLASS ADVISING

During December or January of the first year, most first-year students wish to be assigned to a new advisor in their major areas of study. Forms to change advisors can be obtained from the office of the Director of Academic Advising at any time during the academic year.

The determination of an appropriate four-year program requires considerable thought and information. Not only your advisor but also departmental consultants, the Projects Office, and the consultants in the Humanities and Arts Department can provide you with assistance in planning for both qualifying projects and a Sufficiency area.

Guidelines for the construction of the most common major programs are given alphabetically by area in the "Department and Program Descriptions" section beginning on page 64. The exact program of study for any student, however, is developed by the student with the aid of an advisor.

Please note that only areas of study which are accredited at WPI by ABET are biomedical engineering, civil engineering, chemical engineering, computer science, electrical and computer engineering, industrial engineering, mechanical engineering, manufacturing engineering, or subareas within those disciplines where appropriate as listed below. For further discussion of accredited degrees, see "Professionally Accredited Programs" on page 22.

The WPI student is not restricted to a major whose name coincides with a department name. Under the WPI Plan, students may major in any area in which the WPI faculty is competent both to help them learn and to evaluate their performance on a suitable professional level. Students should not overlook a wide range of possible majors available at WPI in the Social Sciences, Humanities and Arts, Management, and Interdisciplinary Studies areas.

In the examples below, some programs are listed that are developed through the departments indicated in parentheses. In the past, WPI has graduated students in the following fields, but this list should not be interpreted as necessarily putting any restriction on a student's "major:"

Applied Mathematics (MA)
 Actuarial Mathematics (MA)
 Biochemistry (CH) (certified by the American Chemical Society)
 Biology (BB)
 Biomedical Engineering (BME)
 Biomedical Sciences (IGSD)
 Biotechnology (BB)
 Chemical Engineering (accredited by ABET) (CHE)
 Chemical Engineering with Biomedical Interests
 Chemistry (certified by the American Chemical Society)
 Civil Engineering (accredited by ABET)
 Computer Science (accredited by ABET)
 Computers with Applications (CS)
 Construction Management (CE)
 Economic Science (SSPS)
 Electrical and Computer Engineering (accredited by ABET)
 Areas within the ECE major:
 Aerospace and Control Systems
 Analog Microelectronics
 Biomedical Engineering
 Communications and Signal Analysis
 Computer Engineering
 Power Systems Engineering
 Robotics
 RF Circuits and Microwaves
 Engineering Physics (PH)
 Engineering Science (IGSD)
 Environmental Policy & Development (SSPS)
 Environmental Studies (IGSD)
 Fire Protection Engineering* (FPE)

Humanities and Arts (HU)

Concentrations in:

American Studies
 Art History/Architecture
 Drama/Theatre
 Environmental Studies
 German Studies
 Hispanic Studies
 History
 Humanities Studies of Science & Technology
 Literature
 Music
 Philosophy
 Religion
 Writing and Rhetoric

Industrial Engineering (accredited by ABET) (MG)

Interdisciplinary (by arrangement) (IGSD)

International Studies (IGSD)

Management (MG) (accredited by AACSB)

Management Engineering (MG) (accredited by AACSB)

Management Information Systems (MG) (accredited by AACSB)

Manufacturing Engineering (ME; accredited by ABET)

Materials Engineering* (ME)

Mathematical Sciences (MA)

Mechanical Engineering (accredited by ABET)

Concentrations in:

Aerospace
 Biomechanical
 Engineering Mechanics
 Mechanical Design
 Manufacturing
 Materials Science
 Robotics
 Thermal-Fluids

Nuclear Science* (IGSD)

Operations Research (MA)

Physics (PH)

Psychological Science (SSPS)

Society, Technology & Policy (SSPS)

Statistics/Probability (MA)

Structural and Geotechnical Engineering (CE)

System Dynamics (SSPS)

Technical, Scientific, and Professional Communications (HU or IGSD)

Transportation Systems (CE)

*Usually combined with MS major programs.

Programs for students interested in medicine, law or pre-college education can be readily developed from many of the above majors.

Interdisciplinary (individually-designed) majors (ID) may also be developed; see Interdisciplinary Programs, page 132.

WPI undergraduate diplomas designate "Bachelor of Science" for *all* students. The transcript will list the student's major. If a specialization was completed, this will also be included on the transcript. For example, an entry of "Electrical and Computer Engineering with Biomedical Interests" could be made for a student whose course spectrum and qualifying projects substantiate that orientation.

The number of majors associated with a single WPI Bachelor of Science degree is **limited to two**.

DEFINITION:

A Concentration is an option associated with a Major which provides recognition for focused and coordinated academic work either within the Major or within an area of study closely related to the Major.

RULES:

1. All Concentrations require completion of two units of integrated academic study plus an MQP with a topic and content appropriate to the given Concentration.
2. Concentrations deemed to belong exclusively or primarily within the stated Major must be accommodated within the distribution requirements of that Major.
3. Concentrations deemed to have a substantial interdisciplinary nature can exceed the normal 10-unit allotment of the Major by as much as 1 unit, provided that the additional requirements do not include or permit academic work designated by the Major prefix or coursework normally taken to satisfy the Major's portion of the distribution requirements. Furthermore, Concentrations of an interdisciplinary nature are permitted to use up to 1 unit of the academic program beyond the distribution requirements of the Major, including the IQP, Sufficiency, Social Science requirement, and Free Electives, as deemed appropriate.
4. The requirements of the Concentration must be designed to offer choices for the student within the Major area and, if relevant, outside the distribution requirements of the Major; however, the Concentration requirements must not preclude meeting the normal distribution requirements for the Major.

5. Rules and guidelines for each Concentration will be formulated by the faculty associated with the governing Major, and must be reviewed by the Committee on Academic Operations (CAO) and subsequently approved by the Faculty. CAO is empowered to rule on whether a proposed Concentration is disciplinary or interdisciplinary.
6. An individual program of study leading to a Major with a Concentration will be planned by a student in consultation with his/her academic advisor. The student's intention to pursue a Concentration will be declared by application to the appropriate Program Review Committee in accordance with that Committee's schedule of deadlines. Application deadlines should be designed to enable Committee review and communication of decisions to students at a sufficiently early point that flexibility of schedule still exists. Extenuating circumstances may be considered at the discretion of the Program Review Committee.
7. Concentrations and minors are additional degree designations. Any credit earned for an additional degree designation must not overlap with credit earned for another additional degree designation by more than one unit. Also, no credit-bearing activity may be triple-counted towards degree designations or degree requirements.

Listings of Concentrations may be found in the "Department and Program Descriptions" section beginning on page 64.

MINORS

DEFINITION:

A Minor is a thematically-related set of academic activities leading to a degree designation in addition to but separate from that granted by the Major. A Minor should be available to students of any Major, with the exception of a Minor which overlaps with a Major area to such an extent that it is not sufficiently distinct from that Major. The Committee on Academic Operations (CAO) is responsible for the review of proposed Minor Programs and decisions regarding allowed Major/Minor combinations.

RULES:

1. A Minor requires completion of two or more units of thematically related activity. The concluding 1/3 unit of the Minor must be a capstone experience that marks completion of the Minor.
2. It is expected that Minor requirements will be structured so that all acceptable Major/Minor combinations can be accommodated within a normal 16 term framework.
3. A Minor may include any portion of the academic program, excluding the MQP and the final Type 5 IS/P of the Sufficiency. Academic activities used in satisfying the regular degree requirements may be double-counted toward meeting all but one unit of the Minor requirements, subject to the following restrictions:
 - a. The first unit of double-counted work may include at most 1/3 unit of the IQP, 3/3 units of the Sufficiency (excluding the final Type 5 IS/P), or a combination thereof.
 - b. At least one unit of the Minor, including the capstone activity, must be free elective choices.
4. The Program Review Committee for a Minor area will consist of faculty members designated by the sponsoring faculty members.
5. A Minor area must be proposed by a sponsoring group of faculty and must be defined by the purpose of achieving an educational goal beyond those apparent or implicit in the regular degree requirements. Student-initiated Minor Programs must be developed with the approval of a sponsoring group of faculty advisors. Each Minor Program must be reviewed by CAO for its individual merit.
6. Concentrations and minors are additional degree designations. Any credit earned for an additional degree designation must not overlap with credit earned for another additional degree designation by more than one unit. Also, no credit-bearing activity may be triple-counted towards degree designations or degree requirements.

Minors are described in the “Program Description” section of this catalog. Minors sponsored by a department are described following the department. Others are listed alphabetically by title. As of the printing of this catalog, the following *Minors* have been approved:

Computer Science; Entrepreneurship; Foreign Language; International Studies; Law and Technology; Management; Management Information Systems; Manu-

facturing Engineering; Materials; Music; Organizational Leadership; Physics; Social Science; Economics; Political Science and Law; Psychology; Sociology; System Dynamics; Statistics; Writing & Rhetoric.

Interdisciplinary or Individually Designed (ID) minors are approved by the Committee on Academic Operations (CAO).

DOUBLE MAJORS

An option for some students who wish to broaden their WPI experience is the completion of two distinct majors through the double major option. The choice to pursue a double major should be made early in a student’s career. The limit on the number of majors that a student may complete per degree is two.

Students are reminded that WPI offers only one undergraduate degree. Each graduating undergraduate student receives only one diploma, which reads “Bachelor of Science.” For double majors, the diploma may list both majors (in order of preference by the student), either major, or no major as indicated by the student.

The following modifications are made to the degree requirements for students who elect to pursue a double major:

1. THE SUFFICIENCY.

If a major requires the completion of a humanities and arts sufficiency, satisfactory completion of an MQP in Humanities & Arts or International Studies shall satisfy the humanities and arts sufficiency requirement.

If a major requires completion of a technical sufficiency, satisfactory completion of an MQP in a science, engineering, or mathematics discipline shall satisfy the technical sufficiency requirement.

2. THE INTERACTIVE QUALIFYING PROJECT.

If a major is in Social Science and Policy Studies, a single project bearing at least one unit credit may be used to satisfy both the MQP requirement for the SSPS major and the IQP requirement. In order to be used to satisfy both requirements, the combined social science MQP and IQP must meet the goals of both projects. It must be interactive in nature involving an aspect of technology, and must also be an application of social science knowledge and analytical techniques. In order to select a single project that satisfies both the goals of the MQP and the goals of the IQP, the decision to pursue a social science double major needs to be made fairly early in the student’s career.

3. THE MAJOR QUALIFYING PROJECT.

At least one separate and distinct major qualifying project of at least one unit of work must be completed for each major.

4. DISTRIBUTION REQUIREMENTS.

The distribution requirements for each major must be met, but requirements common to both majors only need to be satisfied once. Students pursuing multiple majors, concentrations, and/or minors should also consult the rule on *Credit Overlap for Degree Designations and Requirements* (page 245). The requirements for each individual major must be completed and certified by the Program Review Committee of the department offering that major.

Some departments offer more than one major. A degree may not include more than one major course of study from the same department unless provided for in the list of exceptions below.

Exceptions:

- A student may major in Industrial Engineering and also in either Management, Management Engineering, or Management Information Systems.
- A student may major in Chemistry and also in Biochemistry.
- If a student wishes to complete two Interdisciplinary (Individually-Designed) Major Programs, the double major must be proposed in a single Educational Program Proposal which must be approved by the student’s Program Advisory Committee for each major. The Committees shall ensure that the majors are substantially non-overlapping.

OTHER PROVISIONS.

If a student’s double major includes an Interdisciplinary (Individually-Designed) Major Program, the double major must be described in the Educational Program Proposal for the Interdisciplinary Major.

MATRICULATING AFTER MAY, 2006

The distribution requirements for students who have matriculated before May, 2006 (if different from the requirements printed below) are listed in the individual program descriptions beginning on page 64.

The normal period of residency at WPI is 16 terms. In addition to the WPI requirements applicable to all students (see page 21), distribution requirements apply to 10 units of study in specific areas as listed on the following pages:

AEROSPACE ENGINEERING Requirements	Minimum Units
1. Mathematical and Basic Sciences (Notes 1 and 2)	4
2. Engineering Science and Design (Includes MQP) (Notes 3, 4, 5, 6, 7, 8, 9)	6
NOTES:	
1. Must include a minimum of 5/3 units of mathematics including differential calculus and differential equations.	
2. Must include a minimum of 3/3 units in physics and 1/3 unit in chemistry.	
3. Must include 5/3 units in Aerodynamics and Propulsion with topics in Incompressible Fluid Dynamics, Viscous Flows, Compressible Flows, Aerodynamics, Rocket and Spacecraft Propulsion	
4. Must include 3/3 units in Aerospace Structures and Materials with topics in Materials Science, Stress Analysis, and Aerospace Structures	
5. Must include 2/3 units in Spacecraft Dynamics and Control with topics in Orbital Mechanics, Spacecraft Dynamics and Control	
6. Must include 1/3 units in Aerospace Systems Design that integrates either aeronautical or astronautical topics.	
7. Must include 2/3 units Avionics and Information Systems with topics in Aerospace Avionics Systems.	
8. Must include 1/3 Unit of Capstone Design Experience. This Capstone experience can be satisfied by completing an MQP which integrates course work and involves engineering design. At the time of registration for the MQP the project advisor will determine whether the MQP will meet the Capstone Design requirement or not. If not, the advisor will identify an additional 1/3 unit of course work to be taken in order to meet the ABET Capstone Design requirement.	
9. Must include 2/3 units of Engineering Science and Design electives.	

ACTUARIAL MATHEMATICS Requirements	Minimum Units
1. Mathematics (including MQP) (See notes 1-6).	7
2. Management (See note 7).	4/3
3. Additional courses or independent studies (except MS, PE courses, and other degree requirements) from any area (See note 8).	5/3
NOTES:	
1. Must include MA 3831 and MA 3832, or their equivalents, at least one of MA 3257, MA 3457, or equivalent, and at least one of MA 3631, MA 4632, or equivalent.	
2. Must include two of the following: MA 2073, MA 2271, MA 2273, MA 2431, MA 2631, or their equivalents.	
3. Must include three of the following: MA 3211, MA 3212, MA 4213, MA 4214, or their equivalents.	
4. May not include independent studies directed toward Society of Actuaries exams.	
5. May not include either MA 2201 or MA 2210.	
6. May not include both MA 2631 and MA 2621.	
7. Must include ACC 2101 and FIN 2200 or their equivalents.	
8. Must include 2/3 units of computer science.	

BIOCHEMISTRY	Minimum Units
1. Mathematics and Physics (Note 1).	2
2. Chemistry and Biochemistry (Note 2).	4
3. Biology (Note 3).	1 2/3
4. Chemistry and Biochemistry/ Biology Laboratory (Note 4).	1
5. Other Natural or Computer Science (Note 5).	1/3
6. MQP	1

- Notes:**
- The mathematics in MA 1021-MA 1024 or the equivalent is recommended. The physics in PH 1110-PH 1120 or equivalent is recommended.
 - These four units must include one unit of organic, one unit of biochemistry, and 1/3 unit each of physical (3000 level or higher) and inorganic chemistry (3000 level or higher).
 - These 1 2/3 units must include 1/3 unit of cell biology, 1/3 unit of genetics, and 2/3 unit of advanced work (3000 level or higher).
 - This unit must include a minimum of 1/3 unit in Chemistry and Biochemistry, and a minimum of 1/3 unit in Biology.
 - Any course in the natural sciences (not used to satisfy another requirement) or in computer science may be used to satisfy this requirement.

BIOLOGY/BIO TECHNOLOGY	Minimum Units
1. Mathematical Science, Physics, Computer Science, Engineering (see Note 1)	5/3
2. Chemistry	5/3
3. BB 1000/2000-level (see Note 2)	4/3
4. BB Laboratory Experience (see Note 3)	4/3
5. BB 3000/4000-level (see Note 4)	5/3
6. Related Courses (see Note 5)	4/3
7. MQP	1

- NOTES:**
- BB 3040 may count toward this requirement.
 - Only one BB course at the 1000 level (excluding BB 1001 & 1002) may be counted toward this requirement.
 - Chosen from among BB 2000/3000/4000 Laboratories or from Laboratory Experience List for all Concentrations. Must include at least 1/2 unit of course work at the 2000 level.
 - In certain cases, 500-level courses are appropriate for undergraduate credit with explicit permission of the instructor.
 - Chosen from among the Related Courses Lists for all BB Concentrations.

BIOLOGY/BIO TECHNOLOGY WITH A CONCENTRATION (Note 1)	Minimum Units
1. Mathematical Science, Physics, Computer Science, Engineering (see Note 2)	5/3
2. Chemistry	5/3
3. BB 1000/2000-level (see Note 3)	4/3
4. BB Laboratory Experience (see Note 4)	4/3
5. BB 3000/4000-level (see Note 5)	5/3
6. Related Courses (see Note 6)	4/3
7. MQP (see Note 7)	1

- NOTES:**
- Students pursuing a Concentration must fulfill all requirements for that Concentration. No course may count in more than one category, including university and departmental distribution requirements.
 - BB 3040 may count toward this requirement.
 - Only one BB course at the 1000 level (excluding BB 1001 & 1002) may be counted toward this requirement.

28 MINIMUM DISTRIBUTION REQUIREMENTS FOR STUDENTS

4. Chosen from among BB 2000/3000/4000 Laboratories or from Laboratory Experience List. Appropriate courses are suggested for each Concentration. Must include at least 1/2 unit of course work at the 2000 level.
5. 2/3 or more units must come from the appropriate approved Concentration List. In certain cases 500-level courses are appropriate for undergraduate credit with explicit permission of the instructor.
6. Chosen from among courses specified within each concentration's Related Courses List.
7. Must be approved by the MQP advisor of record as appropriate for the Concentration.

BIOMEDICAL ENGINEERING	Minimum Units
1. Mathematics (See Note 1)	2
2. Basic Science (See Note 2)	2
3. Supplemental Science (See Note 3)	2/3
4. Laboratory experience with living systems (See Note 4)	1/3
5. Biomedical Engineering and Engineering (See Note 5)	4 1/3
6. MQP (See Note 6)	1

NOTES:

1. Mathematics must include differential and integral calculus, differential equations and statistics.
2. Two courses from each of the following areas: BB, CH and PH.
3. Two courses from BB, CH or PH.
4. Experimental Physiology (e.g., BB 3511 and BB 3514) or equivalent.
5. Thirteen courses from Biomedical Engineering (BME) or Engineering (CE, CHE, ECE, ES, or ME) as specified in the WPI Catalog "Courses Qualifying for Engineering Department Areas" with the following distribution: (1) seven courses from Biomedical Engineering or Engineering, one of which must be an engineering design course; (2) four courses from Biomedical Engineering or Engineering at the 3000-level or above; (3) two courses in Biomedical Engineering at the 4000-level or above. A minimum of eight of the thirteen courses must be from Biomedical Engineering, not including BME 3110.
6. Must include 1/3 unit Capstone Design Experience.

CHEMICAL ENGINEERING	Minimum Units
1. Mathematics and Basic Science (Notes 1, 2).	4
2. Engineering Science and Design (Notes 3, 4).	6
3. Advanced Chemistry (Note 5).	2

NOTES:

1. Must include differential and integral calculus and differential equations.
2. Must include 2 courses in physics.
3. Must include 1 unit of MQP, 1/3 unit of capstone design experience (e.g., CHE 4404), and at least 1/3 unit of engineering study outside the major. Courses used to satisfy this requirement must be at the 2000-level or above, with the exception of CHE 1011.
4. Must include at least 4 units from the following list of core chemical engineering courses: CHE 2011, CHE 2012, CHE 2013, CHE 2014, ES 3004, ES 3003, ES 3002, CHE 3201, CHE 3501, CHE 4401, CHE 4402, CHE 4403, CHE 4404, CHE 4405.
5. All CH courses qualify except CH 1010, CH 1020, and CH 1030 which are basic science. Up to 1 unit of Advanced Chemistry may be double counted as both Advanced Chemistry and Basic Science. One course of Advanced Natural Science (2000 level and above BB, PH, GE) may be substituted for one Advanced Chemistry course.

CHEMISTRY	Minimum Units
1. Mathematics and Physics (Note 1).	2 1/3
2. Chemistry (Note 2).	4
3. Additional Science/Engineering (Note 3).	3 2/3

NOTES:

1. Must include differential and integral calculus and at least 2/3 units of physics.
2. Must be above the level of general chemistry (2000 level or higher). These 4 units must include courses in experimental chemistry (either 4/3 unit or 3/3 unit), inorganic chemistry (1/3 unit), organic chemistry (3/3 unit), physical chemistry (3/3 unit), and biochemistry (either 1/3 unit or 2/3 unit, depending on the number of experimental chemistry courses taken). At least 2/3 units must be at or higher than the 4000 level.
3. Distributed among the MQP, the natural and physical sciences, computer science, mathematics, and engineering (and including general chemistry, CH 1010-1040).

CIVIL ENGINEERING	Minimum Units
1. Mathematics and Basic Science (Notes 1,2).	4
2. Engineering Science and Design (including the MQP) (Notes 3,4,5,6).*	6

NOTES:

1. Mathematics must include differential and integral calculus, differential equations, and probability and statistics.
2. Must include both chemistry and physics with a minimum of one course in physics and two courses in chemistry.
3. A minimum of 4 units of work must be within the Civil Engineering area. All CE courses including the MQP, ES 2503, and ES 3004 are acceptable within the Civil Engineering area.
4. The curriculum must include at least one engineering science course outside the major discipline area. Courses acceptable to satisfy the requirement of outside-of-discipline course are those taught in other engineering departments. The course must be a 2000-level or above and cannot include ES 2501, ES 2502, ES 2503, and ES 3004.
5. All students are required to include an appropriate laboratory experience as part of their overall program. This experience can be met by the completion of two undergraduate CE lab courses, selected from among the following: CE 2020, CE 3024, CE 3026, CE 3054, CE 4046, and CE 4060. Alternately, an appropriate laboratory experience could also be accomplished by a student through careful planning of course and laboratory work and approval by petition through the Department Program Review Committee.
6. Must include 1/3 unit of Capstone Design Experience.

COMPUTER SCIENCE	Minimum Units
1. Computer Science (including the MQP) (Notes 1, 2).	6
2. Mathematics (Notes 2, 3, 5).	7/3
3. Basic Science and/or Engineering Science (Notes 2, 4).	5/3

NOTES:

- a. Only CS 1101, CS 1102 and computer science courses at the 2000-level or higher will count towards the computer science requirement. CS 2118 will not count towards the computer science requirement.
- b. Must include at least 1/3 unit from each of the following areas: Systems (CS 3013, CS 4513, CS 4514, CS 4515), Theory and Languages (CS 3133, CS 4123, CS 4533), Design (CS 3041, CS 3431, CS 3733, CS 4233), and Social Implications of Computing (CS 3043, STS 2208, GOV/ID 2314). (If STS 2208 or GOV/ID 2314 is used to satisfy this requirement, it does not count as part of the 6 units of CS.)

- c. At least 5/3 units of the Computer Science requirement must consist of 4000-level courses. These units can also be met by WPI graduate CS courses, with the exception of CS 501 and CS 507.
- d. Only one of CS 1101 and CS 1102 may count towards the computer science requirement. Only one of CS 2301 and CS 2303 may count towards the computer science requirement.
- 2. A cross-listed course may be counted toward only one of areas 1, 2, 3, above.
- 3. Must include at least 1/3 unit from each of the following areas: Probability (MA 2621, MA 2631) and Statistics (MA 2611, MA 2612).
- 4. Courses satisfying the science requirement must come from the BB, BME, CE, CH, CHE, ECE, ES, GE, ME, PH disciplines. At least three courses must come from BB, CH, GE, PH, where at least two courses are from one of these disciplines.
- 5. At most four 1000-level Mathematics courses may be counted towards this requirement.

COMPUTERS WITH APPLICATIONS	Minimum Units
1. Computer Science (including the MQP) (Notes 1, 2).	16/3
2. Mathematics (Note 2).	7/3
3. Basic Science (Notes 2, 3).	2/3
4. Application Area (Notes 2, 4).	5/3

NOTES:

- 1. a. Only CS 1101, CS 1102 and computer science courses at the 2000-level or higher will count towards the computer science requirement. CS 2118 will not count towards the computer science requirement.
- b. Must include at least 1/3 unit from each of the following areas: Systems (CS 3013, CS 4513, CS 4514, CS 4515), Theory and Languages (CS 3133, CS 4123, CS 4533), Design (CS 3041, CS 3431, CS 3733, CS 4233), and Social Implications of Computing (CS 3043, SS 2208). (If SS 2208 is used to satisfy this requirement, it does not count as part of the 16/3 units of CS.)
- c. At least 5/3 units of the Computer Science requirement must consist of 4000-level courses. These units can also be met by WPI graduate CS courses, with the exception of CS 501 and CS 507.
- d. The MQP must involve the application of computer science concepts to the Application Area specified in Requirement 4.
- e. Only one of CS 1101 and CS 1102 may count towards the computer science requirement. Only one of CS 2301 and CS 2303 may count towards the computer science requirement.
- 2. A cross-listed course may be counted toward only one of areas 1, 2, 3, 4 above.
- 3. The two courses satisfying the science requirement must both come from one of the following disciplines: BB, CH, GE, PH.
- 4. This requirement is satisfied by a cohesive set of work from disciplines other than Computer Science. Work used for any other degree requirements cannot be used for the Application Area. At least 3/3 units must be course work at the 3000 level or higher. Independent Study/Project (ISP) work, if any, must be conducted under the supervision of a member of the faculty in that discipline.

ECONOMIC SCIENCE	Minimum Units
1. Economics (Note 1).	3
2. Economics and/or Management (Note 2)	2/3
3. Other Social Science	1
4. Modeling Techniques	2/3
5. Mathematics (Note 3)	2
6. Basic Science	1
7. Electives	2/3
8. MQP	1

NOTES:

- 1. Must include courses in both micro and macro economic theory at the intermediate level and in econometrics and international trade (available through the Consortium or independent study).
- 2. Must include financial accounting, ACC1100. May include other relevant management courses as approved by the Departmental Program Review Committee.
- 3. Must include differential equations, integral calculus, and statistics.

ELECTRICAL AND COMPUTER ENGINEERING	Minimum Units
1. Mathematics and Basic Science (Notes 1a-1d).	4
2. Engineering Science and Design (ES/D) (including the MQP) (Notes 2a-2g).	6

NOTES:

- 1. Mathematics and Basic Science:
 - 1a. Must include at least 7/3 units of math (prefix MA). Mathematics must include differential and integral calculus, differential equations, discrete mathematics, and probability and/or statistics.
 - 1b. Must include at least 2/3 units of physics (prefix PH).
 - 1c. Must include at least 1/3 units of chemistry (prefix CH) or 1/3 units biology (prefix BB).
 - 1d. Must include an additional 2/3 units of math or basic science (prefixes MA, PH, CH, BB, or GE)
- 2. Engineering Science and Design (including the MQP):
 - 2a. Must include at least 5 units within the Electrical and Computer Engineering area (including the MQP). All courses with prefix ECE (except ECE 3601) are applicable to these 5 units. Also, courses ES 3011, BME 4011, and BME 4201 are applicable to these 5 units.
 - 2b. The 5 units within the Electrical and Computer Engineering area must include at least 1 unit of courses from an approved list of Electrical Engineering courses (see page 116)
 - 2c. The 5 units within the Electrical and Computer Engineering area must include at least 2/3 unit of courses from an approved list of Computer Engineering courses (see page 116)
 - 2d. The 5 units within the Electrical and Computer Engineering area must include 1/3 unit of Capstone Design Experience. (This requirement is typically fulfilled by the MQP.)
 - 2e. Must include at least 1/3 unit of computer science (prefix CS), at the 2000 level or above (other than CS 2011, CS 2022, CS 3043 which cannot be applied to this requirement).
 - 2f. Must include at least 1/3 unit of engineering science (prefix ES) at the 2000 level or above. This requirement may also be satisfied by ME 3601. ES 3011 cannot be applied to this requirement.
 - 2g. Must include an additional 1/3 unit of engineering science and design at the 2000 level or above, selected from courses having the prefix BME, CE, CHE, CS (other than CS 2011, CS 2022, CS 3043), ECE (other than ECE 3601), ES, FP, or ME.

ENVIRONMENTAL POLICY AND DEVELOPMENT

	Minimum Units (Note 1)
1. SS & PS (Note 2).	12/3
2. Mathematics (Note 3).	5/3
3. Basic Science (Note 4).	2/3
4. Technical Concentration (Note 5).	2
5. Department Electives (Note 6).	2/3
6. MQP.	1

NOTES:

- 1/3 unit = 1 course. 15 units are required for graduation.
- Students must complete 5/3 units (5 courses) in *one* of three social science areas: (a) economics, (b) psychology/sociology, (c) political science (includes SS & PS courses in law and policy analysis) and 2/3 unit (2 courses) in *each* of the other two social science areas. The particular courses chosen must include six out of the following nine courses: A Psychological Perspective on Environmental Problem Solving, American Public Policy, Development Economics, Environmental Economics, International Environmental Policy, Introduction to System Dynamics Modeling, Environmental Policy and Law, Technical Expertise in Governmental Decision Making, and the Society-Technology Debate. Students must also complete three other social science courses (1 unit) of their choosing.
- Must include both calculus and statistics.
- Basic science courses must be selected from the disciplines of Physics, Chemistry, or Biology.
- The technical concentration must include at least six thematically related courses in science, engineering or management that have been approved by the Department's Program Review Committee.
- Departmental electives must be selected from the areas of mathematics, basic science, social science, or the technical concentration.

HUMANITIES AND ARTS

	Minimum Units
1. Humanities and Arts (including MQP) (Note 1).	6
2. Electives (Note 2).	4

NOTES:

- Humanities and Arts majors may choose to complete 2 units of work and an MQP in one of the following areas of Concentration: History, Literature, Music, Philosophy, Religion, Drama/Theatre, Writing and Rhetoric, Art History/Architecture, German Studies, Hispanic Studies, American Studies, Environmental Studies, or Humanities Studies of Science and Technology.
- May be from any area except Aerospace Studies, Military Science, or Physical Education. Courses used to satisfy other degree requirements (i.e. the IQP and the Sufficiency) may not be used to fulfill this requirement.

DOUBLE MAJOR IN HUMANITIES AND ARTS

Students may pursue a double major in Humanities and Arts and in an area of science, engineering, or management. To pursue the double major, a student must satisfy all of the degree requirements of the technical discipline including an MQP and Distribution Requirements. In addition, the double major in Humanities and Arts requires 6 units of studies in the Humanities and Arts, including the MQP. Students pursuing a double major in Humanities and Arts are not required to complete a Sufficiency Program in Humanities and Arts, nor are they required to complete a second IQP. Students interested in pursuing this option should contact Prof. B. Addison, 39 Dean St., Room 260, for additional information.

INDUSTRIAL ENGINEERING (Management Department)

	Minimum Units
1. Mathematics and Basic Science (Notes 1, 2)	4
2. Industrial Engineering Topics (including the MQP) (Notes 3, 4)	6

NOTES:

- Mathematics must include differential and integral calculus, ordinary differential equations, and 2/3 units in probability and statistics.
- Basic Science must include both chemistry and physics, with a minimum of two courses in either.
- Must include 1/3 unit of Capstone Design Experience.
- Industrial Engineering Topics must include courses in the following three topic areas.
 - 3 units of industrial engineering core courses, including 1/3 unit in each of the following 9 areas: engineering basics outside industrial engineering, deterministic operations research methods, process design, production planning and control, simulation, stochastic methods in operations research, information systems design, financial modeling and organizational science.
 - 1 unit in Industrial Engineering electives. 3000/4000 level OIE courses, MIS 3720, MIS 4720, and Operations Research courses in Mathematics qualify. Courses in financial modeling and organizational science do not qualify.
 - 1 unit in technical electives. Industrial Engineering electives and any other Engineering Science/Design courses qualify.

INTERACTIVE MEDIA AND GAME DEVELOPMENT

	Minimum Units
Core IMGD (Note 1)	2/3
Math	1/3
Science	1/3
Computer Science	1/3
Social and Philosophical Issues (Note 2)	1/3
Computer Art	1/3
Computer Music	1/3
English (Note 3)	1/3
Advanced IMGD (Note 4)	2/3
Major Qualifying Project (Note 5)	3/3

In addition to the requirements listed above, students must satisfy one of the two area requirements, Technical (Computer Science) or Artistic (Humanities and Arts):

AREA	Minimum
Computer Science (Note 6)	10/3
Humanities and Arts (Notes 7, 8)	10/3

Students have electives that can be tailored to meet specific degree requirements and interests:

ELECTIVES	Minimum
Total Electives (Notes 9, 10)	6/3

NOTES:

- Choose from: Critical Studies of Interactive Media and Games (IMGD 1000), The Game Development Process (IMGD 1001), Storytelling in Interactive Media and Games (IMGD 1002).
- Choose from Social Issues in Interactive Media Games (IMGD 2000) or Philosophy and Ethics of Computer Games (IMGD 2001).
- Courses with the prefix EN or WR.
- Taken from 2 technical offerings (IMGD 3000 and IMGD 4000) or 2 artistic offerings (IMGD 3500 and IMGD 4500).

5. Students who double-major in IMGD with the Technical area requirement and a second major in Humanities and Arts or International Studies will be deemed to have satisfied the Sufficiency requirement. Students who double major in IMGD with the Artistic area requirement and a second major in a science, engineering, or mathematics discipline will be deemed to have satisfied the Sufficiency requirement. In these cases, the IMGD MQP advisor must certify that the content of the IMGD MQP matches the student's Artistic or Technical IMGD area requirement.
6. At least 4/3 from: Human-Computer Interaction (CS 3041), Software Engineering (CS 3733, CS 4233), Computer Architecture (CS 4732), Computer Networks (CS 4514), Graphics (CS 4731), Animation (CS 4732), or Artificial Intelligence (CS 4341).
7. At least 1/3 from each of the following areas: Art, Music and English.
8. At least 5/3 units at the 2000-level or higher.
9. Electives must be chosen from the following areas: Computer Science, Humanities and Arts, Interactive Media and Game Development, Mathematics, Science, Social Science, Management, or Engineering.
10. At least 3/3 units must be in a single one of the areas listed in Note 9.

INTERDISCIPLINARY

By individual arrangement; see page 132.

INTERNATIONAL STUDIES

Minimum Units

- | | |
|--------------------------------------|---|
| 1. International Core (Note 1) | 1 |
| 2. International Fields (Note 2) | 4 |
| 3. International Experience (Note 3) | 0 |
| 4. Electives (Note 4) | 4 |
| 5. MQP | 1 |

NOTES:

1. International Core: One course must be selected from each of these categories:
 - a) An introductory course in international history, such as HI 1341 or HI 1313, HI 1321, HI 1322, HI 1323.
 - b) A course in understanding cross-cultural differences, such as one of the following: HU 3411 Pro-Seminar in Global Perspectives, or SS 2406 Cross-Cultural Psychology; or SS 1203 Social Problems and Policy Issues; or PY 2716 Philosophy of Difference.
 - c) HU 4411 Senior Seminar in International Studies.
2. International Fields: Majors complete at least one unit of work in each of the following areas. They must also complete at least one additional unit of work in one of these areas, which will be considered their primary field.
 - a) Historical Analysis. These include any courses in European history, world history, or American foreign policy.
 - b) Language, Literature, and Culture. These include any course in foreign languages, civilization, and literature offered at WPI or in the Consortium with the prior approval of the Program Review Committee; also courses approved by the Program Review Committee in Art History (e.g. AR 1111, AR 2111), English Literature (e.g. EN 2243, EN 3222), Music History (e.g. MU 2615), or Philosophy and Religion (e.g. RE 2721, RE 2724). Majors who designate Language, Literature, and Culture (LLC) as their primary field may not take courses in a second foreign language unless they have achieved 3000-level proficiency in the first. LLC designees should take most of their courses in a single discipline or in a coherent program approved by the Program Review Committee.

- c) Social Sciences. These include international courses in the social sciences (e.g. GOV 1320, ECON 2125, GOV 2312, PSY 2406). Students may count courses taken for the two-course requirement in Social Sciences.
3. International Studies majors are required to have a study-abroad experience. (In very unusual cases, exceptions may be made to this requirement, but only with prior approval of the Director and Program Review Committee). This abroad experience may take the form of a project, exchange, or internship approved by the Program Review Committee. The study-abroad experience should be educational in nature and equivalent in length to at least one WPI term.
4. Electives may be from any area except Aerospace Studies, Military Science or Physical Education. Double-majors may count as electives courses taken for their other major. Majors who are not completing a double-major are required to complete a two-unit technical sufficiency in an area of science, engineering, or mathematics apart from these electives.

MANAGEMENT (Note 1)

Minimum Units

- | | |
|-----------------------------------|------|
| 1. Management Foundation (Note 2) | 11/3 |
| 2. Mathematics (Note 3) | 4/3 |
| 3. Basic Science | 2/3 |
| 4. Management Major (Note 4) | 6/3 |
| 5. Breadth Electives (Note 5) | 3/3 |
| 6. Computer Science (Note 6) | 1/3 |
| 7. MQP | 3/3 |

NOTES:

1. Courses may not be counted more than once in meeting these distribution requirements. The total number of units taken in the Department of Management may not exceed 50% of the total number of units earned for the degree.
2. The Management Foundation must cover the foundation knowledge in the management functional areas, including at least 1/3 unit of financial accounting, managerial accounting, financial management, organizational science, deterministic management science, operations management, marketing management, information systems management, and business law and ethics. Microeconomics and Macroeconomics are required and also fulfill the WPI Social Science requirement.
3. Mathematics must include 2/3 units of calculus and 2/3 units of statistics.
4. Students selecting the Management Major must complete six courses from at most three (3) course clusters as specified in the WPI Undergraduate Catalog "For the MG Major" or work with their academic advisor to create a custom MG Program that includes courses in the specified clusters and/or other areas of Humanities & Arts and Social Sciences & Policy Studies. Such custom programs must be approved by the advisor and the Department of Management's Undergraduate Policy & Curriculum Committee.
5. Breadth Electives must include at least 1/3 unit from among the 3000- and 4000-level courses in the Department. The remaining 2/3 units specified in the requirement may be satisfied with courses from Mathematics, Basic Science, Computer Science, Social Science, or courses with any of the following prefixes: ACC, BUS, ETR, FIN, MIS, MKT, OBC, or OIE, but excluding courses FIN 1250 and OIE 2850.
6. A minimum of 1/3 unit of Computer Science (except CS 2022 and CS 3043). Either CS 1101 or CS 1102 is recommended.

MANAGEMENT ENGINEERING (Note 1)	Minimum Units
1. Management Foundation (Note 2)	11/3
2. Mathematics (Note 3)	4/3
3. Basic Science	2/3
4. Management Engineering Major (Note 4)	6/3
5. Breadth Electives (Note 5)	3/3
6. Computer Science (Note 6)	1/3
7. MIS MQP	3/3

NOTES:

1. Courses may not be counted more than once in meeting these distribution requirements. The total number of units taken in the Department of Management may not exceed 50% of the total number of units earned for the degree.
2. The Management Foundation must cover the foundation knowledge in the management functional areas, including at least 1/3 unit of financial accounting, managerial accounting, financial management, organizational science, deterministic management science, operations management, marketing management, information systems management, and business law and ethics. Microeconomics and Macroeconomics are required and also fulfill the WPI Social Science requirement.
3. Mathematics must include 2/3 units of calculus and 2/3 units of statistics.
4. The Management Engineering Major must complete six courses from one of the concentrations as specified in the WPI Undergraduate Catalog "For the MGE Major" or work with their academic advisor to create a custom MGE Program. Such custom programs must be approved by the advisor and the Department of Management's Undergraduate Policy & Curriculum Committee.
5. Breadth Electives must include at least 1/3 unit from among the 3000- and 4000-level courses in the Department. The remaining 2/3 units specified in the requirement may be satisfied with courses from Mathematics, Basic Science, Computer Science, Social Science, or courses with any of the following prefixes: ACC, BUS, ETR, FIN, MIS, MKT, OBC, or OIE, but excluding courses FIN 1250 and OIE 2850.
6. A minimum of 1/3 unit of Computer Science (except CS 2022 and CS 3043). Either CS 1101 or CS 1102 is recommended.

MANAGEMENT INFORMATION SYSTEMS (Note 1)	Minimum Units
1. Management Foundation (Note 2)	11/3
2. Mathematics (Note 3)	4/3
3. Basic Science	2/3
4. Management Information Systems Major (Note 4)	6/3
5. Breadth Electives (Note 5)	3/3
6. Computer Science (Note 6)	1/3
7. MIS MQP	3/3

NOTES:

1. Courses may not be counted more than once in meeting these distribution requirements. The total number of units taken in the Department of Management may not exceed 50% of the total number of units earned for the degree.
2. The Management Foundation must cover the foundation knowledge in the management functional areas, including at least 1/3 unit of financial accounting, managerial accounting, financial management, organizational science, deterministic management science, operations management, marketing management, information systems management, and business law and ethics. Microeconomics and Macroeconomics are required and also fulfill the WPI Social Science requirement.

3. Mathematics must include 2/3 units of calculus and 2/3 units of statistics.
4. The Management Information Systems Major must complete six courses from those specified in the WPI Undergraduate Catalog "For the MIS Major" or work with their academic advisor to create a custom MIS Program. Such custom programs must be approved by the advisor and the Department of Management's Undergraduate Policy & Curriculum Committee.
5. Breadth Electives must include at least 1/3 unit from among the 3000- and 4000-level courses in the Department. The remaining 2/3 units specified in the requirement may be satisfied with courses from Mathematics, Basic Science, Computer Science, Social Science, or courses with any of the following prefixes: ACC, BUS, ETR, FIN, MIS, MKT, OBC, or OIE, but excluding courses FIN 1250 and OIE 2850.
6. A minimum of 1/3 unit of Computer Science (except CS 2022 and CS 3043). Either CS 1101 or CS 1102 is recommended.

MANUFACTURING ENGINEERING	Minimum Units
1. Mathematics and Basic Science (Notes 1,2).	4
2. Engineering Science and Design (including the MQP) (Note 3,4).	6

NOTES:

1. Mathematics must include differential and integral calculus and differential equations.
2. Science must include both chemistry and physics with a minimum of two courses in either.
3. At least one unit from each of the following areas is required:
 - A. Materials and Processes
 - B. Product Engineering and Tool Design
 - C. Computer Control and Manufacturing Systems
 - D. Production Systems Engineering
4. Must include 1/3 unit of Capstone Design Experience.

MATHEMATICAL SCIENCE	Minimum Units
1. Mathematics including MQP (See notes 1-4).	7
2. Courses from other departments that are related to the student's mathematical program. At least 2/3 unit in computer science must be included; the remaining courses are to be selected from science, engineering, computer science or management (except FIN 1250) (see Note 5).	2
3. Additional courses or independent studies (except MS, PE courses, and other degree requirements) from any area.	1

NOTES:

1. Must include MA 3831-3832, or their equivalents, at least one of MA 3257, MA 3457, or equivalent, and at least one of MA 3823, MA 3825, or equivalent.
2. Must include at least three of the following: MA 2073, MA 2271, MA 2273, MA 2431, MA 2631, or their equivalents.
3. At least 7/3 units must consist of MA courses at the 3000 level or above.
4. May not include both MA 2631 and MA 2621.
5. May not include both CS 3043 and CS 2022.

MECHANICAL ENGINEERING **Minimum Units**

- | | |
|---|---|
| 1. Mathematics and Basic Science (Notes 1, 2, 3). | 4 |
| 2. Engineering Science and Design (includes MQP) (Notes 3, 4, 5, 6, 7, 8, 9). | 6 |

NOTES:

1. Must include a minimum of 5/3 units of mathematics, including differential and integral calculus and differential equations.
2. Must include a minimum of 1/3 unit in chemistry and 2/3 unit in physics, or 1/3 unit in physics and 2/3 unit in chemistry.
3. Must include an activity that involves basic matrix algebra and the solution of systems of linear equations, and an activity that involves data analysis and applied statistical methods.
4. Must include 1/3 unit in each of the following: electrical engineering, materials science, and mechanical engineering experimentation.
5. Must include at least one unit of ME courses at the 4000-level or higher.
6. May include 1000 level courses only if designated ES or ME.
7. Must include two stems of coherent course and/or project offerings as noted below in a and b.
 - a. A minimum of one unit of work in thermofluid systems that includes the topics of thermodynamics, fluid mechanics and heat transfer, plus an activity that integrates thermofluid design.
 - b. A minimum of one unit of work in mechanical systems that includes the topics of statics, dynamics, and stress analysis, plus an activity that integrates mechanical design.
8. Must include an activity which realizes (constructs) a device or system.
9. Must include 1/3 unit of Capstone Design Experience. Items 3, 5, 7a integration, 7b integration, 8, 9 may all be "multiple-counted."

PHYSICS **Minimum Units**

- | | |
|---|---|
| 1. Mathematics (Note 1). | 3 |
| 2. Physics (including the MQP) (Notes 2, 3). | 5 |
| 3. Other subjects to be selected from mathematics, science, engineering, computer science, and management (Note 3). | 2 |

NOTES:

1. Mathematics must include at least 2/3 unit of mathematics at the level of MA 3000 or higher.
2. ES 3001 and CH 3510 count as physics courses.
3. Either item 2 or 3 must include at least 1/3 unit from each of the five principal areas of physics: mechanics, experimental physics, electromagnetism, quantum mechanics, and thermal and statistical physics. This core distribution requirement is satisfied by successfully completing at least one course from each of the following five sets of courses: PH 2201 or 2202 (mechanics); PH 2651 or 2601 (experimental physics); PH 2301 or 3301 (electromagnetism); PH 3401 or 3402 (quantum mechanics); ES 3001, CH 3510, or PH 4206 (thermal and statistical physics); or other courses approved by the department Program Review Committee following petition by the student.

ENGINEERING PHYSICS

1. Same requirements as PHYSICS, with the addition that the 10 units must include 2 units of coordinated engineering and other technical/scientific activities. The 2-unit program must be formulated prior to final year of study by the student in consultation with the academic advisor, and must be certified prior to the final year by the departmental Program Review Committee.

These distribution requirements *in physics* apply to all students matriculating at WPI after May, 2005. Students who matriculated prior to May, 2005, have the option of satisfying the degree requirements in the catalog current at the time of their matriculation.

PROFESSIONAL WRITING **Minimum Units**

- | | |
|---|---|
| 1. Scientific and/or technical concentration (Note 1) | 6 |
| 2. Writing and Rhetoric concentration (Note 2) | 3 |
| 3. MQP | 1 |

NOTES:

1. The student's scientific and/or technical concentration must be a plan of study, approved by the student's program review committee, with a clear underlying rationale in mathematics, basic science, computer science, engineering, and/or management.
2. The Writing and Rhetoric concentration consists of 1 unit in each of the 3 following categories of courses. Courses taken to fulfill these distribution requirements will not include courses that fulfill other degree requirements, such as the Humanities and Arts Sufficiency and the Social Sciences requirement. Exceptions to this restriction, not to exceed 1 unit, must be approved by the student's program review committee, and will be granted only under unusual circumstances.

A. Written communication (1 unit)

Recommended courses:

- EN/WR 2211 Elements of Writing
- EN/WR 3011 Peer Tutoring in Writing
- EN/WR 3214 Writing About Disease and Public Health
- EN/WR 3216 Writing in the Professions or equivalent writing courses or ISPs

B. Rhetoric and communication studies (1 unit)

Recommended courses:

- RH 3111 The Study of Writing
- RH 3112 Rhetorical Theory
- RH 3211 Rhetoric of Visual Design or ISP or any of the courses listed in Category A not used to fulfill that requirement.

C. Electives (1 unit)

The 1 unit of electives must be coherently defined and approved by the student's program review committee.

Students may draw on:

- Courses in science, technology, and culture studies (such as AR/ID 3150, CS 3041, CS 3043, EN 2252, EN 3235, HI 2331, HI 2332, HI 2333, HI 2334, HI 3331, STS 2208, or GOV 2302);
- Philosophy and ethics courses (such as PY 2711, PY 2713, PY 2714, PY 2716, PY 2717, PY/RE 2731, PY/RE 3731);
- Foreign language courses;
- Management courses.

34 MINIMUM DISTRIBUTION REQUIREMENTS FOR STUDENTS

PSYCHOLOGICAL SCIENCE	Minimum Units
1. Psychological Science (Note 1)	3
2. Psychological Science and/or Related Courses (Note 2)	1
3. Other Social Science (Note 3)	1
4. Basic Science, Computer Science, and/or Engineering (Note 4)	5/3
5. Mathematics (Note 5)	4/3
6. Electives (Note 6)	1
7. MQP	1

NOTES:

1. Must include introductory psychology, social psychology, cognitive psychology, and research methods.
2. Related courses must be chosen from a list of psychology-related courses from other departments maintained by the Psychology Program Review Committee.
3. May include no more than two courses at the 1000-level.
4. Must include 1/3 unit of biology. Must include 1/3 unit of computer science (except CS 2022 and CS 3043).
5. Must include 2/3 units of calculus and 2/3 unit of statistics.
6. The 1 unit of electives must be coherently defined and approved by the Psychology Program Review Committee.

SOCIETY, TECHNOLOGY and POLICY	Minimum Units
1. Social Science (Notes 1, 2).	4
2. Minimum Basic Science background.	2/3
3. Minimum Mathematics background (Note 3).	1
4. Technical concentration (Note 4).	5/3
5. Electives (Note 5).	5/3
6. MQP	1

NOTES:

1. Students must obtain approval of their proposed program from the Departmental Program Review Committee. Course distribution will focus on a disciplinary specialty and either policy analysis or a society-technology specialization such as Social Impact Analysis or Technology Assessment.
2. Relevant Humanities and Arts or Management courses approved by the Departmental Review Committee may be counted for a maximum of 2/3 of a unit in fulfilling the 4-unit requirement.
3. One course in calculus-based statistics is required.
4. A series of courses in one field of science, engineering, or management or a combination of courses approved by the Departmental Review Committee which focus on issues to be developed in the MQP.
5. These courses are to be approved by the Departmental Review Committee and are meant to broaden the technical concentration and tie it to social concerns.

SYSTEM DYNAMICS	Minimum Units
1. System Dynamics (Note 1)	5/3
2. Other Social Science (Note 2)	5/3
3. Management (Note 3)	2/3
4. Mathematics/basic sciences/engineering (Note 4)	8/3
5. Computer Science (Note 5)	2/3
6. Application Area (Note 6)	5/3
7. MQP	1

NOTES:

1. Only social science courses with a "5" in the second digit of the course number count toward the system dynamics requirement.
2. Must include microeconomics or macroeconomics, cognitive or social psychology, and public policy.
3. Must include organizational science.
4. Must include differential and integral calculus, differential equations, and numerical analysis or statistical analysis.
5. Courses on computer programming and programming languages are recommended.
6. This requirement is satisfied by a cohesive set of work from the fields of social science, management, science, mathematics, computer science, or engineering as specified in the curriculum the guidelines for system dynamics major.

COURSES QUALIFYING FOR ENGINEERING DISTRIBUTION AREAS

Mathematics

All Courses designated "MA."

Advanced placement established by AP exam or through passing WPI advanced courses (see page 267) also qualify.

Basic Science

All courses designated "PH," "CH," "BB," and GE 2341.

Engineering Science/Design

The following courses may be applied to the "Engineering Science and Design" distribution requirement for each respective engineering major:

BME: All courses designated "BME" (except BME 3110) and CE, CHE, ECE, and ME courses at the 2000-level or above.

CE: All courses designated "CE". Also ES 2503 and ES 3004.

CHE: All courses designated "CHE." Also ES 3002, ES 3003, ES 3004, and other courses approved by the Chemical Engineering Department. See page 96, and consult with your academic advisor for details.

ECE: All courses designated "ECE" except ECE 3601. Also ES 3011, BME 4011, and BME 4201 may be included in the six-unit ECE area distribution requirement.

ME: All courses designated "ME" except ME 3601.

IE: OIE courses including OIE 2500, OIE 3401, OIE 3405, OIE 3420, OIE 3450, OIE 3460, OIE 3501, OIE 4410, and OIE 4460.

In addition, engineering majors selecting "Engineering Science/Design" courses from *outside* their major may choose appropriate activities from any of the following:

All courses designated ES, ECE, CHE, ME.

All OIE courses listed above (for ME majors only).

All courses designated as CE except CE 3022.

All courses designated as CS except CS 1101, CS 1102, and CS 3043.

(Electrical and Computer Engineering majors are restricted to these courses at the 2000-level or higher.)

All ABET engineering programs require six units of Engineering Science and Design.

All graduate-level courses may be counted in the appropriate categories.

PROJECTS

Project activity is an integral part of the educational experience for all students under the WPI Plan. The two types of qualifying projects are:

1. A project in the major field of study (the Major Qualifying Project, or MQP).
2. A project which relates technology and science to society or human needs (the Interactive Qualifying Project, or IQP).

Projects should be chosen in consultation with the student's academic advisor and must be accepted by a project advisor before project registration can be completed. Many project opportunities come from off-campus organizations, and provide challenges to solve real-world problems and thus gain experience invaluable for seeking jobs and for professional practice. Students are encouraged to develop their own projects, to solicit support for their ideas from potentially interested faculty, and to form teams to pool resources and share points of view.

The Major Qualifying Project should focus on the synthesis of all previous study to solve problems or perform tasks in the major field with confidence, and communicate the results effectively.

The Interactive Qualifying Project should challenge students to relate social needs or concerns to specific issues raised by technological developments.

PAY AND CREDIT

The WPI Faculty approved the following project policies in 1973:

1. A student may receive pay for related work that is above and beyond the work clearly defined for academic credit for a project.
2. Wherever possible remuneration for this extra work will be paid by WPI to the student from funds directly obtained through grants from the company to the college.
3. Results obtained from paid or unpaid work performed while students are not registered for project credit at WPI may be used in projects only after consultation with the project advisor. When possible such consultation should take place before the work begins.
4. Students who wish to pursue project work off-campus for WPI credit can do so only if 1) they are registered for that term at WPI, 2) their project advisors have established appropriate methods of supervising the off-campus work. Such supervision must make adequate provision for periodic review and advising.

RESOURCES - GETTING STARTED

Students are encouraged to avail themselves of the many resources and advice areas found in the Projects Program web page (www.wpi.edu/Academics/Projects).

In addition, personal advice can be provided by meeting with the Projects Administrator (Projects & Registrar's Office—Boynnton Hall) or the project coordinators listed on page 251.

AVAILABLE PROJECTS

Students may obtain information about new or ongoing projects from a variety of sources. Principal sources include discussions with other students, especially those currently involved in a project, the Projects Program web site, department offices, or their web pages. Off-campus projects are discussed annually in the fall. In the spring, "Available Projects" on the Projects Program web site (www.wpi.edu/Academics/Projects/) can be used as a directory of specific projects or as a source of ideas for developing your own projects. Some students will find a project listed which fits their needs and interests exactly. In other cases, the listing will serve to lead students to a faculty member with whom project involvement can be negotiated. The proposals in the Projects Program web page are updated periodically to provide an accurate listing of available projects.

PROJECT ADVISOR

Academic advisors can assist students in identifying a project. They are aware of the project interests of many other faculty members, and have a list of faculty interests which will enable a student to find a faculty member who can help to develop a project idea. Faculty associated with the Interdisciplinary and Global Studies Division (IGSD) are available to assist students in interdisciplinary and interactive projects. The Projects & Registrar's Office can also assist in finding an appropriate project advisor. See pages 252-253.

PROJECT PERFORMANCE

A student is normally expected to expend 15-17 hours per week on the average for each 1/3 unit of credit for project work, and expected achievement is based upon that commitment.

A project group, whether it involves one student or more, should have a minimum of one scheduled conference per week with the advisor(s). Additional time should be scheduled when the effort exceeds 1/3 unit per student or when more students are involved.

Students should be prepared to submit written project reports to the advisor each week. Students are also encouraged to complete a proposal at the beginning of the project activity to define the scope and timeline for completion of the effort. In addition, oral reports may be required as determined by the advisor. At the end of the project, a report must be prepared to the satisfaction of the project advisor. For projects sponsored by off-campus organizations, both a written and oral report for the sponsors is normally expected. Written qualifying project reports go on file in Gordon Library for a period of five years.

QUALIFYING PROJECT DOCUMENTATION

In completing the qualifying project degree requirement, students must submit to their project advisors a final document of record. It is expected that the qualifying project documentation will, in most cases, consist of a written report only. In some cases, however, the project documentation may include, in addition to the written report, material in another medium or form, such as software, a video tape, a CD-Rom, or a publication. It is reasonable to expect that the scope of the written report in such instances may be narrower than would be the case if the documentation were by written report only; for example, the objective of a project might be the preparation of a videotape to serve a special purpose, meet a specified need, record a singular event, etc. At the very least, however, the written report portion of the project documentation should provide the reader with a history of the student's involvement with the project, its aims and objectives, its rationale, the role played in the project by the material in the other medium, and the conclusions reached and recommendations framed by the student. All additional forms of documentation must also be submitted with the written report.

FINAL REPORT PROCEDURES

The student will submit the project documentation (the original copy of the written report plus any additional documentary material) to the project advisor. The deadline for the submission of the initial report draft and the final document may be established at the discretion of the project advisor. Drafts and reports need *not* be accepted by the advisor after the established deadline.

The qualifying project advisor will fill out the "Completion of Degree Requirement" form and forward both the form and the project documentation to the Registrar. The Registrar will record the completion of the degree requirement and the evaluation grade only if the project documentation accompanies the form. Otherwise, the Registrar will return the form to the initiator. In the case of a group project report, a separate completion form must be submitted for each student.

The student is responsible for the cost of preparing only the original copy of the written report. The cost of additional copies will be borne by the individual or organization desiring them. It is highly recommended that each student retain a copy of their project for future reference.

GROUP QUALIFYING PROJECT EFFORTS

Students meeting a qualifying project degree requirement by participation in a group, or team effort, will submit, at the discretion of the project advisor, either a single, comprehensive written report from the group, or individual written reports from each member of the group. A single, comprehensive written report must, however, include some means by which each individual's contribution to the group effort may be clearly identified. This identification may take the form of an "authorship page," simply a list of individual chapters and their respective authors, or

of a prefacing statement in which each contributing group member is named as having carried out one or more specific tasks within the overall project effort.

In the case where one or more students leave an ongoing group project after having contributed at least one unit each of project effort, those students, again at the discretion of the project advisor, will submit either a single written report or individual written reports in satisfying the qualifying project documentation requirement. The same means of identifying individual contributions will be employed as described above.

CENTER FOR COMMUNICATION ACROSS THE CURRICULUM

(Upper Level; Project Center)

Accompanying strong emphasis on project work at WPI is strong emphasis on high quality presentation of materials such as proposals, written reports, term papers, and abstracts. To assist you in developing your writing and oral presentation skills, WPI has established a Center for Communication Across the Curriculum that offers writing and presentation consultations, style guidelines, writing manuals and presentation videotapes. Style guidelines, writing manuals and specially prepared

handouts concerned with report writing are available. Small group or individual conferences scheduled by appointment with the writing tutors constitute an additional service provided by the Center to help students with their writing skills. For further information, contact Dr. Higgins at x5503.

DISSEMINATION OF PROJECT REPORTS

MQPs and IQPs completed for off-campus agencies are usually distributed within the sponsoring agency by the agency project liaison. MQP and IQP reports are catalogued for reference in the Gordon Library for five years after being submitted to the faculty advisor. After that period, they are returned to the faculty advisor(s).

Students thus must be responsible for keeping personal copies of project reports for their own permanent professional records. WPI strongly encourages students to prepare MQP and IQP reports in electronic as well as hard copy formats. In this way, reports can be reviewed for later use by students, and incorporated into a professional portfolio.

Thus, MQPs and IQPs are best viewed as research reports which establish good professional practices as well as being potential sources for further study and research.

PROJECTS PROGRAM

Project opportunities have been established at industrial, institutional, and governmental organizations. Projects are available in nearly all disciplines. Announcements of off-campus project opportunities are made annually in February.

Students work on problems at the off-campus site in cooperation with site personnel and under the overall supervision of WPI faculty. The WPI project centers feature programs *specifically* chosen for the *educational* merit and close relationship to the student's interest.

Students may participate on a full-time basis. Only students who have demonstrated by acceptable work at WPI the necessary aptitude and sense of responsibility will be approved for study at a center. Students and advisors interested in off-campus project opportunities should contact the Projects Office for further information.

OFF-CAMPUS INSURANCE AND LEGAL AGREEMENTS

WPI's insurance program includes a broad range of coverage for students doing projects in cooperation with off-campus organizations. This insurance coverage requires proper documentation of individual student participation. All students doing project work with off-campus organizations must complete the pertinent portion of the project registration form. In certain cases, where the project is included as part of a regular course, the course

instructor must submit to the Projects Office a list of the students going off campus and the name(s) and address(es) of the organization(s) involved.

WPI has entered into a variety of agreements with off-campus organizations, covering a wide range of issues common to the projects program. Students agree to abide by these agreements during the registration for the project.

PROJECT CENTERS

Each Project Center has a WPI faculty member as the director, well-defined procedures for completing project work, and selective admissions processes. The Centers tend to be highly structured and require superior performance.

At the present time, the WPI project centers close to campus are:

- Gillette Company Project Center.
 - Lincoln Laboratory Project Center.
 - UMass Memorial Health Care, University of Massachusetts Medical Center, and Tufts School of Veterinary Medicine Project Centers.
 - Worcester Community Project Center.
- See also page 47 for residential Project Centers at a distance from WPI.

LINCOLN LABORATORY PROJECT CENTER

MIT Lincoln Laboratory located in Lexington, MA was founded in 1951 as a Federally Funded Research and Development Center of MIT. The Laboratory's fundamental mission is to apply science and advanced technology to critical problems of national security. The scope of problems includes air defense, communications, space surveillance, missile defense, tactical surveillance systems and air traffic control.

The WPI-MIT Lincoln Laboratory MQP Program is a one-term, off-campus, multidisciplinary for students to complete their MQP requirements. Students participating in the program will be required to complete a Preliminary Qualifying Project (PQP) in D-Term 2006 or at the end of summer employment at Lincoln Laboratory. During this PQP, the students will learn about the project, perform background research, and interact with their project sponsor at Lincoln Laboratory. One of the outcomes of the PQP will be detailed proposal describing the general area of the project, the specific problem to be addressed, and the approach the students will take to solve the problem.

During A-Term 2006, the students will work full-time for 7 weeks at Lincoln Laboratory on their projects. They will work with a mentor from Lincoln Laboratory and with one or more WPI faculty advisors. Descriptions of the 2006 project opportunities may be found at MIT's Lincoln Laboratory Web site.

Admission to the WPI-MIT Lincoln Laboratory MQP Program is based on the following criteria: academic standing, and performance, essay response, evidence of maturity and independence, availability of projects in a specific area, qualifications relevant to the project offered, and results of an interview.

Project opportunities typically exist in the following disciplines:

- Computer Science
- Electrical and Computer Engineering
- Mathematics
- Mechanical Engineering
- Physics

GILLETTE COMPANY PROJECT CENTER

Gillette is the world leader in grooming products. Their South Boston Manufacturing Center (SBMC) is their primary location for the manufacture of shaving systems such as the Mach 3 and Venus razors, where over a billion units are produced each year. Many major qualifying project opportunities are available, principally in mechanical and manufacturing engineering. Projects can range from the design of equipment for automated production systems to the analysis and modeling of the kinematics, dynamics, and vibrations of existing systems. Students who do these projects will have the opportunity to solve real engineering problems, interact with professional engineers at one of the most automated assembly facilities in the world, and demonstrate their presentation skills. Those interested in exploring project opportunities at Gillette should contact Professor Robert L. Norton, Mechanical Engineering Department.

UMASS MEMORIAL HEALTH CARE/UNIVERSITY OF MASSACHUSETTS MEDICAL SCHOOL/ TUFTS UNIVERSITY SCHOOL OF VETERINARY MEDICINE PROJECT CENTERS

Biomedical projects (MQP, IQP, PQP, and thesis) are available at UMass Memorial Health Care, University of Massachusetts Medical School (UMMS), and Tufts University School of Veterinary Medicine (TUSVM) for students from all disciplines on campus. Each of these centers is located close to WPI.

It is recommended that students spread their projects over the entire academic year. However, in some cases, full-time activity for a term can be accommodated. Students interested in project opportunities should contact the Biomedical Engineering Department Projects Faculty Coordinator well in advance of their planned project activity.

The qualifying project in the major field of study should demonstrate application of the skills, methods, and knowledge of the discipline to the solution of a problem that would be representative of the type to be encountered in one's career. The project's content area should be carefully selected to complement the student's total educational program. In defining the project area within which a specific topic is to be selected, the student and academic advisor should pay particular attention to the interrelationships that will exist between the bodies of knowledge represented by courses, independent studies, and Preliminary Qualifying Projects; and by the Interactive Qualifying Projects.

MQP activities encompass research, development, and application, involve analysis or synthesis, are experimental or theoretical, emphasize a particular subarea of the major, or combine aspects of several subareas. In many cases, especially in engineering, MQP's involve capstone design activity. Long before final selection of a project topic, serious thought should be given as to which of these types of activities are to be included. Beyond these considerations, the MQP can also be viewed as an opportunity to publish, to gain experience in the business or public sectors, or to utilize special facilities like those listed on pages 8 through 16.

Off-campus MQPs are also very valuable for access to state-of-the-art resources and contacts for future professional work.

GETTING STARTED ON AN MQP

Project topics are originated by students, faculty, or practicing professionals participating in WPI's off-campus project programs. A faculty member in each academic department acts as Project Coordinator for all majors within the department. The Project Coordinator has assembled MQP topic descriptions being proposed and has identified the faculty who will serve as project advisors for each topic. All project opportunities—MQP, IQP, PQP, on-campus originated and off-campus originated—are made available to the student body through a planned information-sharing program of activities during C and D terms of the academic year prior to the start of the project.

PROJECT PROPOSALS

Students are strongly encouraged to begin their MQPs with a project proposal. A detailed guide to preparing project proposals is available in department offices or on the Projects Program web page (www.wpi.edu/Academics/Projects/).

THE INTERACTIVE QUALIFYING PROJECT

The Interactive Qualifying Project (IQP) challenges students to address a problem that lies at the intersection of science or technology and societal structures or human needs. The objective of the IQP is to enable WPI graduates to understand, as citizens and as professionals, how their careers will affect the larger society of which they are part. Generally, these projects involve some analysis of how technology affects, and is affected by, individuals and communities. Many of the projects are proposed by external agencies or organizations, and most are done in teams.

The IQP is an intentionally broad and integrative educational experience; student teams are drawn from all disciplines, and the topic is not necessarily related to the students' major field. The procedure employed to relate the scientific or technological component to a social issue sometimes arises from students' training in the social sciences or humanities. The IQP provides opportunities for significant international and pre-professional experience that are unique in technological education. (See Residential Project Centers, page 47)

PREPARING FOR THE IQP

While the preparation of most students for the Major Qualifying Project (MQP) involves extensive studies in technology, preparing for the IQP emphasizes the development of an understanding of the concepts and analytical techniques of the social sciences. The social science courses taken to satisfy the 2/3-unit social science requirement should be chosen to support IQP preparation (as

explained on pages 179-180). In some cases, this background will include the study of other disciplines relevant to particular IQP topics. Preparation guidelines are included in the respective IQP division descriptions which follow, pages 40-46.

Students should begin preparing for their IQPs during their first two years at WPI; most of this preparation should be completed prior to work on the project itself. Be sure to discuss IQP opportunities with your first-year advisor. In preparing for specific IQPs, you can seek the assistance of the IQP division coordinators indicated on the following pages by the divisions below.

RESOURCES

To help students decide on an area of study and to identify faculty members who might be potential advisors, the division descriptions that follow indicate the chief areas of IQP interest. The names of faculty who have expressed interest in advising projects in each of these divisions may be determined by scanning the project proposals listed on the web-site, www.wpi.edu/Academics/Projects/. A list of residential project centers, with associated faculty, follows the division descriptions. These consultants can provide you with more information about the areas, and can assist you in finding an advisor. If you have questions or need assistance with your early exploration of interactive project opportunities, see the staff at the Interdisciplinary and Global Studies Division Office in the Project Center. Also, consulting the database of Completed Projects (on the campus computer system) is most helpful in suggesting topics and/or advisors.

PROJECT PROPOSALS

Students are strongly encouraged to begin their IQP activity with a project proposal. A detailed outline on preparing project proposals is available in the Interdisciplinary and Global Studies Division Office in the Project Center. *Only students submitting project proposals and the accompanying budget are eligible for college financial support for their IQPs.*

DIVISION 41, TECHNOLOGY AND ENVIRONMENT

IQPs in the environmental area have dealt with a wide range of subjects, including hazardous waste, open space planning, climate changes, acid rain, aquatic weed control, and environmental impact statements. Topics may be global or a local issue; some projects are experimental and generate new data, while others are more theoretical in nature and apply prior research data. Projects must define an appropriate interaction, and be defined and managed within the allotted time period. Environmental projects require a broad base of interest and knowledge, and therefore should be undertaken by student teams rather than isolated individuals. A faculty advisor familiar with your topic and knowledgeable in its interdisciplinary aspects will be able to help your project group.

A project proposal should be done before the actual project is initiated. This proposal should state the question being examined, review the literature in the area of concern, summarize the methodology to be used in the project, suggest the data which will have to be collected, and describe the intended usefulness of the project. This proposal may be done as the first stage of the project, or as a PQP, depending on the advisor's requirements.

A wide range of environmental problems are available for projects. The solution to some of these problems may be sought by various environmental organizations (such as Massachusetts Audubon Society) or governments (municipalities or state agencies); the chance to work on such problems provides the student group with the opportunity to solve a real problem while providing the organization or community with a beneficial report.

PREPARATION GUIDELINES

The following courses may provide some basic skills for projects:

BB 2040	Principles of Ecology
CE 3059	Environmental Engineering
ECON 2117	Environmental Economics
GOV 2311	Legal Regulation of the Environment

Other courses should be taken, depending upon the particular project selected; for this reason it is helpful to think about the project in your sophomore year.

DIVISION 42, ENERGY AND RESOURCES

This division focuses on the problem of meeting society's needs for energy and other mineral resources. The division seeks to promote interdisciplinary project work on energy and resource use and supply. We are concerned with the technological alternatives, the economic, environmental and human value questions that must be faced in choosing among these alternatives, and the role of our social systems and institutions in determining the choices that are made.

Emergence of energy as a distinct area of project activity began at WPI with the energy crisis of 1973-1974. Since then, the pattern of interests in this area both here and elsewhere have evolved in response to international energy developments. Initially, issues of scarcity — the adequacy of the world's energy resources to meet a growing demand and the sudden massive escalation of energy prices that occurred from 1974-1979 — were a primary concern. This period witnessed much activity in modeling energy markets and forecasting trends in energy demand, supply, and prices. Similar concerns were raised about the supply of basic metals and minerals. Many studies were undertaken of the markets for these natural resources to identify long-run price trends, the prospects for cartelization, and the need for stockpiles.

More recently, at WPI, the interests of students and faculty alike have shifted to an emphasis on "solutions." In the last half dozen or so years, most of our interdisciplinary student projects have examined the economic feasibility, the environmental side effects, and the impact on public health and mortality of various resource technologies. Renewable sources of energy such as solar, wind, wood, and hydroelectric have been investigated frequently. More conventional alternatives to high-priced oil such as coal, natural gas, and nuclear power have received their share of attention. Many of these investigations have been of the case study type, examining the feasibility of a new technology in a particular setting. Energy independence at the level of the individual home owner has been a popular theme. But other projects have examined more global issues such as the public's attitude toward nuclear power and its role in shaping national energy policy.

PREPARATION GUIDELINES

The implementation of government resource policies frequently involves manipulation of resource markets. The decisions our society makes about alternative sources of natural resources and the extent of resource conservation adopted will, to a large extent, be determined by the economic laws of supply and demand operating in these markets. Therefore, an understanding of how the economy functions at the level of individual economic decision makers and individual markets is essential for the effective conduct of many resource IQPs. Appraising the economic viability of alternative means of obtaining resources frequently involves making investment studies; i.e., capital budgeting.

The role of government and public opinion in the formation of our national energy policy can best be understood and analyzed by a student who has a background in sociology or political science.

To obtain information on these subjects a student would take as many of the following courses as possible:

Management

FIN 2200	Financial Management
OIE 2850	Engineering Economics
OIE 3400	Production System Design

Philosophy and Religion

PY 2712	Social and Political Philosophy
PY 2714	Ethics and the Professions: Personal, Professional and Social Dilemmas

Social Sciences

ECON 1110	Introductory Microeconomics
ECON 1120	Introductory Macroeconomics
STS 1207	Introduction to Psycho-sociology of Science
GOV 1301	U. S. Government
GOV 1303	American Public Policy
GOV 2304	Governmental Decision Making and Administrative Law

The Social Sciences courses listed above may be counted toward the 2/3-unit social science requirement.

DIVISION 43, HEALTH CARE AND TECHNOLOGY

For much of the period since the advent of Medicare and Medicaid legislation in the mid-1960s, the cost of medical care has grown explosively. Both in inflation adjusted dollars and as a percentage of Gross Domestic Product, medical care in the United States is now at a level greatly exceeding that of the early 1960s. Furthermore, because of the aging of the American population (the over-85 age group — the so-called “frail elderly” — is the fastest growing element of our population) and the growth of expensive medical technology, forces remain strong towards an even higher level of medical expenditures.

Projects in this division address the interaction between health care technologies and the delivery of medical care in the United States. These IQPs focus on major social concerns in medicine (e.g., Magnetic Resonance Imaging — MRI, the potential for computer-based “expert systems” in medical care, new technologies for maintaining the independence of the elderly, managerial systems to control the cost of medical care, laser surgery, etc.) and medical-moral issues (e.g., the living will, the right-to-die controversy, organ transplantation, wrongful-death and wrongful-life issues, human cloning, use of steroids in sports, universal health insurance, abortion, fetal tissue transplants, etc.).

There are several off-campus institutions and project centers available as resources for students interested in projects in this area. They include: St. Vincent Hospital, the University of Massachusetts Medical Center, the Massachusetts Biotechnology Park (located in Worcester), San Francisco General Hospital, and St. Mary’s Hospital, San

Francisco. The division coordinators should be contacted for the names of WPI faculty members associated with these institutions.

PREPARATION GUIDELINES

Projects in this division are multidisciplinary and should appeal to students with widely differing backgrounds and interests. Those students planning to do IQPs in this area should develop institutional and methodical background in both the technological and social science areas appropriate to their projects. Examples of courses which introduce social science concepts fundamental to this project area are listed below; course work in more specific topics within this project area (e.g., PY 2713, Bioethics, etc.) is also available.

ECON 1110	Introductory Microeconomics
ECON 1120	Introductory Macroeconomics
STS 1207	Introduction to Psycho-sociology of Science
GOV 1301	U. S. Government
GOV 1310	Law, Courts and Politics
PSY 1402	Introduction to Social Psychology
GOV 2302	Science-Technology Policy

The Social Sciences courses listed above may also be counted toward the 2/3-unit social science requirement.

DIVISION 44, URBAN AND ENVIRONMENTAL PLANNING

Urban and Environmental Planning IQPs offer the student a wide range of opportunities to investigate and analyze problems that require a systematic and comprehensive approach. IQP topics cover a wide range of areas, including:

Environmental analysis—such as the investigation of the “quality of life” or the impact resulting from physical alterations of the environment.

Environmental impact statements.

Resource management programs—such as water management programs for lakes, groundwater, rivers; or forest management programs for fuel, lumber, and recreation.

Redevelopment and renewal of city neighborhoods.

Rehabilitation of historic places and buildings.

Fiscal analysis and program impacts—such as those resulting from the implementation in Massachusetts of Proposition 2 1/2.

Preservation of agricultural lands.

Conservation and open-space planning.

Demographic policies and community facilities planning.

Land use planning.

Impacts of infrastructure development.

Often these problems are complex, requiring the use of concepts and skills provided by a range of professions and disciplines: sociology, economics, political science, physical science, law, and engineering. Ignoring these

contributions often leads to environmental and social impact, such as air and water pollution, unexpected fiscal burdens, noise, environmental disasters, and unhealthy living conditions. These now are evident in the "treated" water from our urban areas, in the disposal of solid waste from our consumer society, in the sterility of our "planned" subdivisions, and in the global alteration of fragile environment. Comprehensive planning for our urban and natural environment necessitates a holistic approach to solving specific problems which are faced by our neighborhoods, rural environments, urban areas, and the nation, as well as the world itself. Such problems will become worse unless comprehensive planning is understood and used.

PREPARATION GUIDELINES

The concepts and skills necessary for a planning-project will depend on the specific area. Often these multi-disciplinary skills are brought to a project through a team effort, in which individuals share their learned disciplinary skills and concepts to solve the problem together. The following are suggested courses which could be beneficial to students who are interested in doing projects in Area 44:

Civil Engineering

CE 3070	Urban and Environmental Planning
CE 3074	Environmental Analysis
CE 4071	Land Use Development and Controls

Social Science

STS 1207	Introduction to Psycho-sociology of Science
ECON 2117	Environmental Economics
GOV 2311	Legal Regulation of the Environment

The Social Sciences courses listed above may be counted toward the 2/3-unit social science requirement.

DIVISION 45, SCIENCE AND TECHNOLOGY: POLICY AND MANAGEMENT

Projects in this division share a concern for government's role in solving or preventing a problem related to science and technology. Society must make collective choices about technology; increasingly, it does so through the political process. The politics of nuclear power, impact of urban forests on the environment, consumer needs and their impact upon public policy, the relationship between the educational needs of society and responses in the field of education, health policy, and organizational approaches to information management, examples of the issues addressed by students and their advisors. Frequently, the projects use one of the many techniques of policy analysis, which include statistical measures, interviews, and examination of legal case materials.

Policy analysis is one approach, but other projects have used a slightly different approach by focusing on the organizations that perform research and develop technologies. These projects contribute to the design of successful public and organizational policy by explaining how uni-

versities and corporations operate, and by identifying those organizational characteristics that are pertinent to corporate or to public policy. IQPs have analyzed the prospects for university-industry relations, the development of entrepreneurs, the implications of the diffusion of innovations in organizations, the impact of new technologies on jobs, and the government's role in moderating the social impact of the shift to a high-technology service economy.

PREPARATION GUIDELINES

Students should prepare for these projects by learning about the American political economy, public policy, the legal system, and in some cases the management of organizations.

Political Economy and Public Policy

STS 1207	Introduction to Psycho-sociology of Science
GOV 1301	U. S. Government
GOV 2302	Science-Technology Policy

Legal System

GOV 1310	Law, Courts, and Politics
GOV 2311	Legal Regulation of the Environment

Students are encouraged to blend their technical knowledge with a policy analysis. They could identify a policy issue in their major field and look at it from an economic, political, legal, or management perspective.

DIVISION 46, SOCIAL STUDIES OF SCIENCE AND TECHNOLOGY

Projects in this area cover a variety of specific topics, but are united by a general perspective which is characteristic of the field of Science, Technology and Society studies. S.T.S., as it is called, is known by its emphasis on the critical examination of conventional wisdom about the social implications of science and technology.

When proponents proclaim the dawn of a new era or predict that great social progress will accompany the emergence of a technology, S.T.S. people look for the other side of the coin. When opponents attack technology, due to the alienation, loss of meaning, and control issues it creates, S.T.S. proponents probe to see what new possibilities will emerge. Whether the result will be new freedom or new tyranny often depends on the surrounding social arrangements.

In short, the aim of a S.T.S. project is to put aside traditional thinking about the nature of technology, and really examining the ways in which technologies interact with social systems. One starts by dropping the idea that technology impacts society, rather than vice versa, and by questioning the assumption that technological advances automatically represent social progress. Much follows from this modest beginning.

S.T.S. is sometimes called "the Science of Science," as you adopt an attitude of scientific skepticism and then look at science itself, or a technological issue. The result is

a critical, but not negative, perspective on technology which paves the way toward a balanced assessment of the benefits and costs of technical change.

Classic S.T.S. projects might involve analysis of tension between technical experts and democratically-elected leaders, the conditions under which technology seems to become an irresistible social force or the way in which distribution of wealth, power, and status are affected by technological change. Organizational “mindsets” leading to technical accidents have also been good project themes.

Technology is rarely neutral in socio-political terms, but its impact can be subtle. The most challenging and rewarding type of S.T.S. study deals with the way technology affects the way in which we relate to the world or view ourselves. Those interested in the interface of technology and society are often like a fish trying to understand water, the medium in which it lives. The great challenge of this field, but also its greatest reward, is that it seems to require considerable reflection about society and the role of the technologist in it to do a first rate S.T.S. project.

CURRENT PROJECT THEMES

Within this broad field, four general project themes are being developed into continuing project streams. A few illustrations of each type are offered below from the list of completed projects.

1. Technological Literacy and Public Understanding of Science
2. Reception of Scientific and Technical Innovations by Affected Communities and Technical Professions
3. Impact and Equity Issues Related to Gender, Race, Ethnicity or Social Class.
4. Reforms in Science or Engineering Education
5. Processes of Technology Transfer and Product Innovation

PREPARATION GUIDELINES

As one can see, S.T.S. is by its nature an interdisciplinary field. Hence, project preparation could appropriately draw from a range of academic disciplines. However, it is usually best to concentrate on picking up the perspective first, and a variety of courses in social sciences, history, and philosophy are taught from S.T.S. perspective. The courses that do the best job of introducing this approach include:

STS 2208	The Society-Technology Debate
HI 3331	Topics in Science, Technology and Society
ID/AR 3150	Light, Vision, and Understanding
GOV 2302	Science-Technology Policy
GOV 2304	Governmental Decision Making and Administrative Law
CS 3043	Social Implications of Information Processing
HI 2334	European Technology Development
EN 2252	Science and Scientists in Modern Literature

DIVISION 47, SAFETY ANALYSIS AND LIABILITY

Projects in this division deal with issues of people and property safety and the management of risk associated with the hazards inherent in today's society.

The analysis of risk required two components:

1. a measure of severity, and
2. a probability distribution

Typical measures of severity include deaths, injuries, dollars of property damage and days of business interruption. The probability distribution gives a probability for each value the severity measure can take. Some of the risks that have been studied as part of this project division have included risks due to unwanted fires, the misuse and abuse of consumer products, those risks associated with workplace safety and risks associated with natural disasters. Risk management and analysis tools used have included scenario development, fault tree construction and event tree analysis.

The risk associated with unwanted fires is of special interest because each year fires claim a greater toll than earthquakes, floods, tornadoes, and all other natural disasters combined. In just a few minutes time, a single fire or explosion can have catastrophic consequences in facilities ranging from hotels, hospitals and schools to high-rise offices and complex manufacturing operations. Projects in this topic have examined fire department operation, investigated the economic consequences of design changes in residential smoke detectors and evaluated firesafety risks in passive solar heated homes.

Liability issues focus on the risk associated with products and the consequences of people's actions. Some recent projects in this have been:

1. *Forensic Investigation of an LP-Gas Cylinder Explosion*
2. *An Injury Investigation of Quadriplegia Resulting from an Automatic Shoulder Seatbelt: Design Failure or Negligent in Use*
3. *Rollover Propensity of the Suzuki Samurai*
4. *Legal, product liability and personal injury issues resulting from the case of Locke vs. Mack Trucking, Inc.*

Some useful courses for preparing for “Safety Analysis and Liability” IQP's include:

FP 3070	Fundamental of Firesafety Analysis
BUS 2950	Business Law and Ethics
MA 4213	Risk Theory
STS 1207	Introduction to Psycho-sociology of Science
GOV 1301	U. S. Government
GOV 1310	Law, Courts, and Politics
GOV 2311	Legal Regulation of the Environment

DIVISION 48, HUMANISTIC STUDIES OF TECHNOLOGY

The overall theme of projects in this group is the interaction of science and technology with the humanistic and nonquantitative aspects of culture. Together with the relevant fields in science and technology, the appropriate areas of culture from which the methodologies and substance of the projects will be drawn include philosophy, literature, history, religion, humanistic psychology, and the fine arts, with emphasis on values and ideas. The interaction of all levels of technology with the cultures of traditional and developing societies, as well as developed ones, is within the scope of the group. Thus, projects can range over an enormously broad area to include such diverse topics as the relationship of the literature to technology or science, philosophical analysis of the nature and role of the individual in a high-level technological society, or an historical examination of the reductionist view of man as a machine.

Whenever possible, two faculty members will advise each project, one advisor being drawn from the appropriate humanities or art discipline. Faculty members will explain to students the scientific, technological, and humanistic background necessary to begin the projects for which they will act as advisors.

PREPARATION GUIDELINES

Besides a general familiarity with the basic concepts and ideas in the physical sciences, projects in this area involve historical, cultural, social, psychological, or philosophical analysis. Many projects are aided by a general background and familiarity with the literature and fine arts of the modern era.

EN 2252	Science and Scientists in Modern Literature
HI 2332	American Science and Technology from 1859
HI 2333	History of Science From 1700
HI 2334	European Technological Development
HI 3331	Topics in Science, Technology and Society
ID/AR 3150	Light, Vision, and Understanding
PY 2711	Philosophical Theories of Knowledge and Reality
PY 2713	Bioethics
STS 2208	The Society - Technology Debate

Courses might also be selected from the literature, music, art, and philosophy offerings appropriate for the period and national group being studied (either American, European, or Asian), or the history of architecture.

The Social Science course listed above may be counted toward the 2/3-unit social science requirement.

DIVISION 49, ECONOMIC GROWTH, STABILITY AND DEVELOPMENT

There are two major areas of interest in the division:

A. PROBLEMS OF STABILITY AND CHANGE IN MATURE COUNTRIES

This project area is concerned with many of the issues that confront the world's developed economies. These issues include the distribution of income and wealth, the kinds and quantities of available jobs, who obtains or fails to obtain the more desirable jobs, and the causes and consequences of inflation and recession. The analysis can focus upon particular sectors or upon the nation as an aggregate. Emphasis is placed upon the manner in which technological and social changes are integrated into the organization of work in society. Economic, social, psychological, as well as political and technological questions can be raised in this project area.

B. PROBLEMS ASSOCIATED WITH GROWTH IN DEVELOPING NATIONS

This project area is intended to encompass a wide range of problems facing developing nations. Generally, projects analyze the environmental, social, economical, and distributional impacts of growth and development, and the design of policies aimed at eradicating poverty and unemployment. In more specific terms, these projects address such issues as sustainable development strategies, the choice of sectoral policies, the choice of monetary and fiscal policies, rapid population growth, housing and urbanization, education and training, questions of "appropriate technology" and its transfer, import substitution and export promotion, foreign aid and foreign debt, foreign investment, and the role of international firms.

PREPARATION GUIDELINES

The foci of these project areas are economics, psychology and policy studies. Students anticipating work in these areas should have a background in economics, social science, and psychology, and a familiarity with the techniques of statistical analysis and/or computer simulation. Among the courses suggested for preparation are:

ECON 1120	Introductory Macroeconomics
ECON 2120	Intermediate Macroeconomics
ECON 2125	Development Economics
ECON 1110	Introductory Microeconomics
ECON 2110	Intermediate Microeconomics
ECON 2117	Environmental Economics

PSY 1402	Social Psychology
PSY 2405	A Psychological Perspective on Environmental Problem Solving
PSY 2406	Cross Cultural Psychology: Human Behavior in a Global Perspective
GOV 1303	American Public Policy
GOV 1310	Law, Courts, and Politics
GOV 2311	Legal Regulation of the Environment
GOV 2312	International Environmental Policy

The courses listed above may be counted toward the 2/3-unit social science requirement.

DIVISION 50, SOCIAL AND HUMAN SERVICES

The delivery of social services is one of the most difficult and controversial problems currently faced by our society. In the past, IQPs have examined such issues as services for the mentally or physically handicapped, especially public school students, rehabilitation of juveniles, treatment for alcoholism and drug abuse, consumer information awareness, assessment of college life and student attitudes, and other community service concerns. Many projects in this division will be concerned with the strengths and deficiencies of the systems which the private and the public sectors of our society have established or are proposing to establish for dealing with community problems.

PREPARATION GUIDELINES

Projects in this category are multidisciplinary, and should appeal to students with widely differing backgrounds and interests. Those students who expect to do IQPs in this area should develop analytic backgrounds in the particular social science area(s) appropriate to their project. Examples of courses which introduce concepts fundamental to this division are listed below. Students anticipating IQPs which involve economic analysis should consider course work in that discipline. Also, projects involving surveying of public attitudes will require background in social analysis as found in SS 1402 and SS 2403. SS 2203 is an excellent introduction to problem-solving in the social sciences. MG 2300 is recommended for projects involving conflict resolution and management of social problems through industrial engineering techniques.

Recommended Courses

OBC 2300	Organizational Science—Foundation
ECON 1110	Introductory Microeconomics
ECON 1120	Introductory Macroeconomics
STS 1207	Introduction to Psycho-sociology of Science
GOV 2311	Legal Regulation of the Environment

The Social Sciences courses listed above may be counted towards the 2/3-unit social science requirement.

Examples of IQPs recently completed in this division are:

- A Guide to References That Assist Wheelchair Users in Addressing Concerns That Can Occur During College Careers.
- Alcohol and Youth Culture in Spain and the U.S.
- Computer Adaptations for Visually Impaired.
- Streamlining Communication Systems for Autistic Children

DIVISION 51, EDUCATION IN A TECHNOLOGICAL SOCIETY

Offerings in this area include projects in which WPI students teach and/or develop curricula at all grade levels from K through college in a variety of subjects. In other projects, students apply technology to learning (through research and development of teaching aids and machines), deal with mass media (methods and implications of teaching large segments of the population), or focus on the teaching-learning process (through study and research of learning models and theories).

Many projects are carried out with local regional public and private schools through the "WPI School-College Collaboration in Mathematics and Science Education." WPI has a close working relationship with the nearby Doherty High School. For details of these programs, contact Assistant Provost Lance Schachterle, Boynton Hall.

PREPARATION GUIDELINES

Education plays a dominant role in the modern, technical society. It is a compulsory, long-term experience for a significant segment of the American population. To prepare for projects in this area, the student should have a perspective on modern American history with emphasis on the development and growth of the present educational system, an understanding of psychological development and theories of learning, and a background in the elementary concepts of social science research.

PSY 1402	Introduction to Social Psychology
PSY 2401	The Social Psychology of Education
STS 1207	Introduction to Psycho-Sociology of Science

The Social Sciences courses listed above may be counted toward the 2/3-unit social science requirement.

For students planning to develop science curriculum, the appropriate science and mathematics background is assumed.

TEACHER LICENSING OPTION

Students doing education IQPs may be interested in also qualifying as a secondary school mathematics or science teacher. For information on this option, see "Teacher Licensing" on page 134.

DIVISION 52, LAW AND TECHNOLOGY

Technological developments take place in the context of a complex legal and regulatory environment. For example, courts will apply principles drawn from unwritten common law to restrict land uses by property owners. In contrast, developments in communications, energy, and pharmaceuticals are governed by an interlocking structure of statutes and regulations at both the state and federal levels.

IQPs in this division focus on the interaction between legal and regulatory institutions and technology. Project students study statutes and their history, regulatory systems, agency decision making, and judicial decisions to determine their impact on technology.

In addition, students study the operation of technology in a legal environment to determine whether social goals expressed in law are realized in practice. Will the Clean Air Act clean air? Do regulations for the handling and disposal of toxic materials protect the public? Can regulation effectively promote energy conservation? Do procedures governing drug approval unnecessarily prevent the speedy introduction of new treatment methods?

Aspects of legal and regulatory decision making are also studied. When do courts accept scientific evidence as determinative of facts? Can scientists provide objective, expert advice for governmental decisions or are scientists destined to become partisan policy advocates?

The answers to all these questions are important if technology is to aid us in the achievement of social goals and if courts and regulatory agencies are to succeed in defining and implementing social policy.

PREPARATION GUIDELINES

Successful completion of IQPs on the topics described above depend, in part, on prior preparation in government, law and society-technology issues. The following courses support IQP research in this division:

HI 2317 Law and Society in America, 1865-1910
 ECON 1110 Introductory Microeconomics
 ECON 1120 Introductory Macroeconomics
 GOV 1301 U.S. Government
 GOV 1303 American Public Policy

GOV 1310 Law, Courts, and Politics
 STS 2208 The Society-Technology Debate
 GOV 2302 Science-Technology Policy
 GOV 2304 Governmental Decision Making and Administrative Law
 GOV 2310 Constitutional Law
 GOV 2311 Environmental Policy and Law

Students should consider combining courses listed above to form sequences in policy studies, law, or society-technology studies. Additional information on sequences appears in the description of social science courses.

DIVISION 53, HISTORIC AND ARTISTIC PRESERVATION TECHNOLOGY

Projects in this division examine the value and policy issues surrounding decisions on which historic and artistic objects such as buildings, battlefields, statues, monuments, prints, drawings, paintings, and sculptures should be preserved and how best to preserve them. They may also deal with the technical issues involved in art conservation and restoration and involve application of the technical methods available for analyzing the composition of historic objects.

PREPARATION GUIDELINES

Ideal preparation for projects in this division would include art history and material science and familiarity with data base management programs.

Recommended Courses:

AR 1111 Introduction to Art History
 AR/ID 3150 Light, Vision, and Understanding
 AR 2113 Topics in 19th and 20th Century Architecture
 HI 1331 Introduction to the History of Science
 HI 1332 Introduction to the History of Technology
 ES 2001 Introduction to Materials Science
 ME 2820 Materials Processing

In addition to IQP and MQP opportunities on campus, through the Global Perspective Program, WPI students have many opportunities to work for a seven-week term at one of WPI's residential project sites. Project work conducted at these sites provides teams of students with extraordinary opportunities to learn by solving problems provided by professional or government agencies. Most of these programs offer IQPs; MQPs and one-term Sufficiencies (see pages 58-59) are available depending on faculty advisors.

Registration for IQP work in these programs begins in the fall with the Global Opportunities Fair. At the Fair, IQP and exchange program directors will be available to talk with students about these opportunities. Students should apply in the fall of the year preceding the year in which they would like to participate. Further information is available at the Interdisciplinary and Global Studies Division in the Project Center.

All students accepted to an off-campus IQP Center are required to register for the preparation course ID 2050 in the term immediately preceding their time off campus. Students must also be making satisfactory progress in their academic program.

RESIDENTIAL PROGRAMS

All programs offer the students the opportunity to complete a project in seven weeks of full-time work. Advance preparation is required. Faculty advisors are in residence at the site.

	TERMS OFFERED				
	A	B	C	D	E
Limerick, Ireland*	<input type="checkbox"/>				
Washington, D.C.		<input type="checkbox"/>			
Worcester, Massachusetts		<input type="checkbox"/>	<input type="checkbox"/>		
London, England*/**		<input type="checkbox"/>			
Wall Street, NY*		<input type="checkbox"/>			
Venice, Italy		<input type="checkbox"/>			
Bangkok, Thailand			<input type="checkbox"/>		
Hong Kong			<input type="checkbox"/>		
London, England			<input type="checkbox"/>		
Nancy, France*			<input type="checkbox"/>		
Silicon Valley, California*			<input type="checkbox"/>		
Boston, Massachusetts				<input type="checkbox"/>	
Copenhagen, Denmark				<input type="checkbox"/>	
London, England				<input type="checkbox"/>	
Melbourne, Australia				<input type="checkbox"/>	
San Juan, Puerto Rico				<input type="checkbox"/>	
Windhoek, Namibia				<input type="checkbox"/>	
London, England					<input type="checkbox"/>
San José, Costa Rica					<input type="checkbox"/>

* MQP opportunities only.

** Sufficiency opportunities only.

PROGRAMS IN THE UNITED STATES

WASHINGTON PROJECT CENTER

Director: Prof. D. DiBiasio, Goddard Hall 218A

WPI's Washington Project Center operates in Term B each year. Students, usually juniors and seniors, work in three-member project teams with a variety of federal, private, and nonprofit groups. In the past, projects have been completed with the U.S. Coast Guard, the Office of Patents and Trademarks, the National Science Foundation, the National Academy of Engineering, the National Society of Professional Engineers, the Agency for International Development, the Consumer Product Safety Commission, the Department of Health and Human Services, among many others. Students work on their projects at the sponsoring agency for the entire seven-week term, while living in downtown Washington, D.C., within several blocks of the White House and many government agencies.

There are several qualities that every Washington Project Center applicant should have. Most importantly, students should have a curiosity about how government works and the importance of national action in the areas of the environment, education, health, and defense, for instance, and the importance of U.S. actions on global matters. Washington is one of the information capitols of the world; thus students have the opportunity to conduct interviews with policy makers of many different disciplines and to examine data not available elsewhere. International students would find this experience to be very valuable. Secondly, students should be willing to learn about tools of social science research, which may include conducting surveys by mail, by telephone interviewing, or by face-to-face interviewing.

Living in Washington provides students an endless access to the free national museums that are part of the Smithsonian complex. They include the Air and Space Museum, the Museum of American History, the Natural History Museum, the National Gallery, the museums of African and Oriental Art. In addition there are the Lincoln, Jefferson and Vietnam Memorials; the National Holocaust Museum; the National Archives; the Washington Monument; and of course, the Senate and House hearings, which are open to the public.

BOSTON PROJECT CENTER

Director: Prof. F. Carrera, Project Center

WPI's Boston Project Center operates in Term D each year. WPI project teams, with a resident WPI faculty member, work on topics offered by government agencies, environmental and community organizations, medical and financial institutions, and private-sector industrial firms.

Boston is a world-class city, with a wealth of cultural, educational, recreational and touristic opportunities. It is an exciting, vital, and stimulating environment. It is, of course, not far from WPI, which minimizes the expense of getting there and back compared to a site half-a-world away.

Students will work in teams of three on projects at the sponsoring organization for the entire seven-week term. Student housing and project assignments are arranged in advance. Selection of students for this program takes place in Term B for the following academic year. All Boston students are required to register for a preparation course offered in the C term preceding the D-Term project.

WORCESTER COMMUNITY PROJECT CENTER

Director: Prof. R. Krueger, IGSD

Students work in offices in central Worcester and commute daily from their WPI base.

Projects are recruited from private and public Worcester agencies focusing on policy issues where recommendations can make significant contributions to improving the city we live in. Sponsorship includes government, public interest, charitable and educational organizations.

Recent examples of projects include: a) a study of community Internet accessibility (sponsor: Worcester Information Technology Project); b) marketing of the Worcester Convention Center and the City Hall Plaza (sponsor: Director of Marketing for the City of Worcester); c) implementing an engineering curriculum at Doherty High School (sponsor: Worcester Public Schools) and d) issues in rehabilitating old commercial properties in the Prescott St. area for new high-tech ventures.

SILICON VALLEY PROJECT CENTER

Co-Directors: Prof. D. Finkel, Fuller Labs 231
Prof. J. Orr, Atwater Kent 229

Silicon Valley, California, is the home to many of the most dynamic companies in the computer industry and in other related high-technology industries. Established companies, such as Sun, Intel, and Hewlett-Packard, mix with small start-ups to provide an exciting atmosphere of technology and entrepreneurship. The projects will expose students to both the cutting-edge technology and the dynamic entrepreneurship of Silicon Valley.

Students participating in the Silicon Valley project center will participate in a Preliminary Qualifying Project (PQP) during B-Term, 2003. During this PQP, the students will perform background research in the area of their project, learn about the company and the industry where they will be performing their project, and hold discussion with their company mentor about their project work. One of the outcomes of the PQP is a detailed proposal, describing the general era of the project, the specific problem to be addressed, and the approach the students will adopt to solving the problem.

The projects will be conducted during C-Term 2004 in Silicon Valley. The students will work full-time at their sponsor's site for approximately 9 weeks, from early January through early March. The students will work with a mentor from the sponsoring company and with a WPI faculty advisor. The project work will include the completion of an MQP report and a presentation on the project work to the sponsoring organization.

Admission to the Silicon Valley Project Center is based on academic standing and performance, essay response, evidence of maturity and independence, availability of projects in a specific area, qualifications relevant to the project offered, and results of an interview.

Projects may be available in a number of disciplines, including:

- Biology/Biotechnology
- Chemical Engineering
- Computer Science
- Electrical and Computer Engineering

PROGRAMS IN EUROPE

DENMARK PROJECT CENTER

Directors: Prof. P. C. Pedersen, Atwater Kent 205
T. H. Thomsen, International House

What makes Denmark an ideal place for an IQP Project Center is a combination of several factors. The Danish culture is very much open to the kind of interdisciplinary academic questioning which is the foundation of any good IQP project.

The Denmark Project Center, located in Copenhagen, operates in D term each year. In the past, projects have been completed with The National Museum, NOAH (Danish Friends of the Earth), The Engineering College of Copenhagen, The Danish Society for the Blind and the Danish Bicycle Federation. It is expected that future IQP projects in Denmark will be related to disability and environmental issues and work with museums, in addition to continuing to work for not-for-profit organizations.

A WPI faculty advisor remains in residence throughout the 8-week period. Students are required to register for 1/6 PQP in B-term and 1/3 PQP in C term (ID 2050) prior to leaving for Denmark. PQP work consists of project preparation including writing a project proposal and a seminar in Danish history and culture. In addition, students participate in a five-day orientation program in Denmark.

The program gives an introduction to Copenhagen, Danish language and contemporary issues.

Housing in Copenhagen will, in most cases, be apartments located near the center of Copenhagen, with stores and public transportation within a few minutes walk.

LIMERICK, IRELAND

Directors: Prof. R. Vaz, Atwater Kent

Limerick is Ireland's third largest city, and a center for both tourism and business, yet it retains the charm and feel of a small community in many ways. Limerick's center is located on the River Shannon, and features both medieval and Georgian influences; the outskirts of the city are home to a number of high-technology business parks and a major university. The areas surrounding Limerick are famous for their natural beauty and historical significance; the Republic of Ireland is small enough so that it can be explored from end to end in a series of weekend excursions. Visitors to Ireland encounter spectacular scenery including 3,500 miles of coastline, a rich cultural and literary heritage, vibrant cities and villages, and a warm and friendly populace eager to help visitors feel at home.

MQPs in the Limerick area involve working on-site at local electronics and computer firms and research laboratories. In B term of the preceding year, project opportunities are identified for particular areas within electrical and computer engineering and students are selected. The following A term, students spend 10 weeks in Limerick, living among Irish people and working fulltime in collaboration with engineers at the local firms on the projects.

MQPs in Limerick involve most areas of specialization within electrical and computer engineering, including analog and mixed-signal hardware design, digital design and embedded systems, signal processing and communications, and software engineering. Special project statements are not available until the beginning of the projects, as project sponsors typically provide the opportunity for students to work on cutting-edge problems of immediate interest to the companies.

Admission to the ECE MQP Program in Limerick is based on the following criteria: academic standing and performance, evidence of maturity and independence, qualifications relevant to the anticipated projects, faculty references, and the results of an interview.

LONDON PROJECT CENTER

Directors: Prof. P. Davis, IGSD

IQPs are available at the London Project Center in terms C, D and E. (Sufficiencies are available in terms D and E; see the accompanying description of the London Sufficiency Program.) Together with a resident WPI faculty adviser, teams of WPI students find solutions to problems posed by British public and private agencies. Housing and project assignments are arranged in advance with the assistance of WPI's London-based Center Coordinator. Many opportunities are available during the term for vis-

its to cultural institutions in and around London. Each term in London also includes a long weekend to permit extended travel outside of London.

Sponsors of London Center IQPs include the Tower of London, the Museum of Science and Industry, the London Borough of Merton, the Victoria and Albert Museum, the Institution for Electrical Engineers, the Association of Chief Executives of National Voluntary Organizations, the Royal Hospital for Neuro-disability, the Dickens House and many other organizations.

Selection of students for the London Center for the following summer and academic year normally begins in term B. Interested students can begin the application process by attending the Global Opportunities Fair in September. All London IQP students are required to enroll in ID 2050 and to complete a PQP in the term preceding their work in London.

LONDON HUMANITIES PROGRAMS

Coordinator: Prof. J. Brattin, Salisbury Labs 24

WPI offers Sufficiency Projects in London in Terms B and E. London Sufficiency Projects are interdisciplinary and intended for students with many backgrounds in the humanities and arts. London was once the center of a global empire and its influence continues to radiate throughout the British Isles and well beyond. Sufficiency students in London study topics that might include history, literature, music, theatre, or culture, and work on projects that build on at least three previous courses in humanities and arts. As an interdisciplinary program, the London Sufficiency is not limited to the history or literature of Britain, but all projects take advantage of the unique resources available in London. These include some of the world's most vibrant theatre and the arts, outstanding museums, ambitious architecture, the libraries of the University of London, collections of film or sound recordings, and much more. London Sufficiency Projects are appropriate for students with a background in art history/architecture, drama/theatre, history, literature, music, philosophy, religion, or writing/rhetoric. Students planning a minor or major in International Studies, Humanities and Arts, or Technical Scientific, and Professional Communication, also may study in London in conjunction with this program.

VENICE PROJECT CENTER

Director: Prof. F. Carrera, IGSD

Called the most beautiful city in the world, Venice has a haunting atmosphere which easily evokes the splendor of its past. A city with an outstanding historical, artistic and architectural heritage, much of its uniqueness comes from its symbiotic relationship with the sea and the lagoon. Yet today, this relationship contributes to serious environmental and economic problems. As daily life revolves around the canals, proposed solutions to these problems usually have a direct impact of the inhabitants of Venice.

The IQPs in Venice provide an opportunity for students to see the implementation of their projects put to use for

the benefit of an entire city. Projects are conducted for Venetian, American and international organizations and include environmental, socioeconomic, artistic, cultural and technical concerns important to the sustainability of this historic city.

Prior knowledge of the Italian language is not required. Language training is provided to participating students as part of the project preparation activities, which also include ID2050 and a PQP.

Students and faculty stay in apartments in the historic center of Venice. Due to the aquatic nature of the city, everything is within walking distance or reachable through the local public boat transportation system. During the term, the Venice Project Center operates out of a centrally-located office where meetings and academic activities take place on a daily basis.

PROGRAMS IN ASIA

BANGKOK PROJECT CENTER

Directors: Prof. C. Demetry, Washburn Shops
Prof. R. Vaz, Atwater Kent

To commemorate the 125th anniversary of the college with its theme of "WPI in the World," WPI established its first Project Center for IQPs in Asia in 1989. Students conduct IQPs in Bangkok, Thailand, in Term C annually. WPI students carrying out IQPs in Bangkok have incomparable opportunities to investigate, first-hand, the rapidly growing technologies and economies of Asia. While all projects are conducted in English, students have many opportunities to encounter Thai culture. Projects are usually sponsored by local universities, government agencies, or by U.S. companies with Asian offices. Numerous projects involving the environment and service to the poor have been carried out in Bangkok since the Center's founding.

IQP topics, housing, and travel arrangements for Bangkok are arranged in advance through resident coordinators in Bangkok, in conjunction with Chulalongkorn University.

HONG KONG, CHINA PROJECT CENTER

Coordinator: Prof. C. Peet, IGSD

The Project Program in Hong Kong provides a gateway to the most dynamic and important region on the planet. The wealth of the world has moved to Asia and Hong Kong plays a crucial role in the development of China — historically the most significant actor in Asia. This city radiates energy as it rapidly modernizes and takes the lead in economic development, high-rise building, historic preservation and artistic conservation.

In Hong Kong, WPI is aligned with Caritas, a Catholic Charity and educational institution with a worldwide network of sites. Caritas has advised IQPs since 1990, and, with Hong Kong's reversion, Caritas has expanded its operations to the mainland of China. Caritas maintains resort housing available to WPI students on the outer is-

lands of Hong Kong, and the Bianchi Lodge in Kowloon. WPI is also working with the "Civic Exchange", a newly established think tank in Hong Kong that deals with a vast variety of issues including environmental and energy policies.

IQPs will deal with environmental, energy and social issues, web applications, educational surveys, and other topics as appropriate.

MQPs may be available in a number of disciplines, including:

- Chemical Engineering
- Electrical Engineering
- Civil Engineering
- Other fields as negotiated

PROGRAMS IN LATIN AMERICA

COSTA RICA PROJECT CENTER

Director: Prof. S. Vernon-Gerstenfeld, IGSD

The project center, located in San José, Costa Rica, operates in E-term. In this stable democracy, students have the opportunity to perform IQPs in a variety of settings ranging from rain forests, to local manufacturing plants, to multi-national companies and organizations, to non-profit organizations, and to Costa Rican government offices.

Since Costa Rica is a rapidly developing nation, the intractions between technology and social implications are graphic. Working full-time, in each sponsoring organization, students experience the thrill of a new culture and the pleasure of providing needed work for the sponsor. Teamwork is the rule for participating students, who have designed a national GIS system for the fire department, developed a method for removing latex from the processing of bananas so that there can be 100 percent recycling of water, developed an interactive rainforest exhibit in the national science museum, worked to develop an inexpensive fish farming system to supply a means of living for with subsistence farmers in any developing nation, organized a plan for ecological education through a bird watching program for a world renowned botanical garden, developed an environmental policy for a rainforest that operates tourist activities according to sustainable development principles, as well as many others.

Before leaving to go on-site, students participate in a 1/2 unit of preparation. In Costa Rica, students have the opportunity of improving their Spanish, if they have some, or learning enough for survival through a short intensive course taken during the beginning of their stay. They continue their immersion during their off-hours on all of the myriad excursions they will undertake throughout the country or by simply being in Costa Rica. However, most of the projects can take place using English. Housing and transportation are arranged before the students leave.

Costa Rica is the center of bird migration from both South and North America. It hosts live and dormant volcanoes, dense but very explorable jungles and rainforests, and has world-renowned beaches, as well as very amicable people.

PUERTO RICO PROJECT CENTER

Director: Prof. S. Vernon-Gerstenfeld, IGSD

The Puerto Rico Project Center operates in D-term in San Juan, Puerto Rico, the capital of the Commonwealth of Puerto Rico. As in other off-campus centers, students work full-time, in the offices of the government of the Commonwealth, as well as in industry. Students perform their work under the guidance of a WPI faculty person who accompanies the students to San Juan. In addition, the sponsoring agency or company provides a liaison person to work with the students.

Projects span a wide variety of topics such as transportation, health, housing, the environment, social welfare, infrastructure, and land use for a few examples. The fact that these concerns apply to an island and a culture different from that of mainland U.S. makes them particularly interesting.

Students interested in this center will have the opportunity to learn some Spanish if they wish or to apply that which they already know. They will also have the opportunity to be immersed in a Latin culture and to having access to a large metropolitan area. There will be abundant opportunities to see other parts of the island and to visit sites such as the Arecibo (outerspace) Observatory, El Junque national rain forest, the phosphorescent bay at La Parguera, the art museum at Ponce, El Moro fortress in San Juan, the white sand beach at Loquillo, and various indigenous people. Housing and transportation are arranged before the students arrive on site.

Students participate in 1/2 unit of preparation prior to leaving campus for the on-site portion of their work.

PROGRAMS IN AUSTRALIA

AUSTRALIA PROJECT PROGRAM

Directors: Prof. J. Barnett, Higgins Laboratory 105
Prof. H. Ault, Higgins Laboratory

WPI's Australia Project Program, based in the city of Melbourne, operates in Term D each year. As this is a relatively new project site, the project topics in Melbourne may change significantly from year to year. Current sponsors include the Fire Protection Association of Australia, the Department of Human Services, the Commonwealth Scientific and Industrial Research Organization and Arup Fire, a local engineering consulting firm.

Melbourne, situated along Australia's southeast coast, is the country's second largest city. It is a city of parks and gardens, specializing in arts festivals, sporting events, and fine dining. It was voted "the world's most livable city" in the international survey. Melbourne is also a fine place from which to explore the diversity of Australian life, being a short distance from mountains, deserts, beaches, mining towns, and extensive parklands and wildlife reserves.

It is anticipated that opportunities will exist for some satellite projects, without a resident WPI faculty member,

in Darwin and possibly other major Australian cities.

Students will normally complete two 1/6 unit PQP activities. These will normally be completed in terms B and C.

Students will work in teams of three or four with a resident WPI faculty member, on projects at the sponsoring organization for the entire seven-week term. Student housing and project assignments are arranged in advance. Selection of students for this program takes place in Term B for the following academic year.

REQUIREMENTS FOR INDIVIDUALLY SPONSORED RESIDENTIAL PROJECTS (ISRPS)

Many students and faculty augment the educational opportunities available at WPI's formal project centers and programs with individually sponsored residential, off-campus projects. All such programs must adhere to common, carefully structured risk management protocols such as those developed and implemented at established project centers. Otherwise, students, faculty, and WPI are exposed to unnecessary risk.

Hence, the Provost requires completion of the following risk management protocol by all faculty intending to advise students who will earn academic credit while in residence off-campus in individually sponsored projects.

1. Two terms in advance of the off-campus activity: Faculty advisor sends a letter of intent to the Provost's office. The letter describes the scope of the anticipated project, where it will happen, how many students will participate, and the term that the students will be off-campus.
2. Ten weeks prior to departure: Faculty advisor submits a completed ISRP form (126KB PDF) to the Provost's office. The ISRP form is co-signed by the academic department head (MQP or Sufficiency) or Dean of IGSD (IQP). At this time a signed Transcript and Judicial Release Form (55KB PDF) must be submitted for each potential student participant.
3. Eight weeks prior to departure: All students expecting to participate in an ISRP should be in good academic standing at this time. WPI reserves the right to withdraw acceptance to students who are subsequently placed on academic warning. Students placed on academic probation are not eligible to participate. Upon review of academic and judicial records for each student the IGSD will inform the advisor of students who may be disqualified due to poor academic performance or judicial history at WPI.
4. Six weeks prior to departure: Student participant(s) submit the following forms to the faculty advisor: the Acknowledgement of Voluntary Participation, the Off-Campus Students' Health Update and Records Release Form, and the WPI Off-Campus Travel Information Form (198 KB PDF).
5. Five weeks prior to departure: The advisor submits these completed forms (item 3) to the IGSD. Please note that all forms can be found at the IGSD Web Page.

Please note that all forms can be located on the Web at <http://www.wpi.edu/Academics/Depts/IGSD/> Project registration will not be complete until the conditions of this protocol are met.

At the completion of step 2, WPI's risk managers will review the information provided and make a recommen-

ation to the Dean of IGSD, who will assist the Provost in making a final decision to approve or disapprove the activity based on considerations of risk management. The faculty advisor will learn of this decision no later than the first day of the term preceding the proposed activity.

	E Term Away	A Term Away	B Term Away	C Term Away	D Term Away
Proposal made to Provost's Office	By January 10th	By March 10th	By May 10th	By September 10th	By November 10th
Completed ISRP form submitted to Provost's Office	By March 15th	By June 20th	By August 25th	By October 25th	By January 5th
Completed Health & Safety Forms for each student submitted to the IGSD	By April 20th	By July 25th	By September 25th	By December 5th	By February 5th

ON-CAMPUS IQP PROGRAMS

LIVING MUSEUMS PROGRAM

The Living Museums Program provides students with unusual opportunities to carry out IQP projects at various culturally rich museums of New England. Museums synthesize knowledge and combine artifacts with primary and secondary documents, often to create an entire social and physical environment. Thus, as students work with professional staff, documents, and artifacts at museum sites, they gain an understanding of the past and present, and begin to see how distinct aspects of human life fit together to form a specific culture. At the outstanding museums participating in the program, students can select projects from a varied list of areas ranging from medieval warfare at the Higgins Armory Museum in Worcester to the rich history and literary culture of Concord, MA, at the Concord Museum and the Thoreau Lyceum.

Special projects are available each summer in Term E at several museums and historical institutions such as : Mechanics Hall, Worcester, MA; the Worcester Historical Museum; Fruitlands Museum in Harvard, MA, Martha's Vineyard, and Higgins Armory Museum.

GENDER, RACE, AND TECHNOLOGY

Prof. S. Vernon-Gerstenfeld, IGSD

Student projects in this program research issues in two general areas: (a) the participation of women and people of color in engineering and science education and in engineering professions, and (b) the effects of particular technologies on women, African Americans, Hispanics, Native Americans, and other specific racial or ethnic groups.

Projects are often coadvised, with one advisor from humanities or social science, and one advisor from science, engineering, or computer science disciplines.

Past and ongoing project topic areas include:

- effects of automation on office workers
- women in science and engineering professions
- underrepresented groups in science and engineering professions

- sex differences in learning styles in technical subjects
- ethics and reproductive technologies
- science and math education for precollege Native Americans, Hispanics and African Americans.

Project ideas in these or other areas related to gender, race, and technology can be initiated by students or faculty. For more information, contact Prof. Susan Vernon-Gerstenfeld, Project Center 216.

AWARDS AND SCHOLARSHIPS

THE PRESIDENT'S IQP AWARDS

The President's IQP Awards have been established to encourage and recognize meritorious accomplishment in the performance of the Interactive Qualifying Project. To be considered for an award, the IQP, while of overall good quality, should be outstanding in conception, execution, and presentation. There are no predetermined categories for the awards, but the award will recognize the qualities in which the project excels. By thus calling attention to projects which are deemed to be outstanding, the awards help to establish standards for exceptional quality in IQPs.

Each award consists of a certificate of merit to each student and an honorarium. The IQP awards competition is conducted each fall. For further information, see Dean Paul Davis, IGSD Office, Project Center.

THE PROVOST'S MQP AWARDS

The Provost of WPI conducts an annual competition to recognize several project teams in each discipline whose MQPs, in the view of the judges, have been unusually innovative, well executed, and well presented. To qualify as a contestant, the student team must be identified by the department of the team as one of the best presenters in the department oral competition. For more information, contact Associate Provost Lance Schachterle in Boynton Hall.

The word “Sufficiency” usually designates the WPI humanities and arts degree requirement. It indicates a thematically related course and project sequence “sufficient” to give students an idea of how knowledge is obtained and expressed in a non-technical discipline.

Rather than offer merely an impression of many different areas of the humanities and arts, the WPI Plan calls for a meaningful grasp of a single thematic topic or a single discipline. The Sufficiency is not equivalent to fulfilling a distribution requirement by passing a certain number of unrelated courses. Instead, courses are taken in a chosen area of the humanities or arts, or they are focused on a theme that combines more than one area. They culminate in a final independent study, in which the student begins to do original work in an aspect of the humanities or arts.

The culmination of each student-selected sequence will be an independent study, producing a critical or research essay or, in combination with an analysis, short stories, poems, works of music or musical performances, visual art, or dramatic performances. (See also “Foreign Language Sufficiency” exception.) The final accomplishment must sum up the previous work in the humanities and arts not only by drawing upon what has been learned in previous work, but also by exploring new territory. The goal is to give the student enough background in one area of the humanities and arts so that—just as a student with an engineering or science major gains insight into how human creativity is exercised in such fields—in fulfilling the Sufficiency, the student learns how the mind creates, appreciates and criticizes work in the humanities and arts.

GOALS OF THE SUFFICIENCY

To develop an ability to display increased knowledge and initiate critical thinking and to present arguments in a manner consistent with the type of project.

To develop an ability to communicate clearly, precisely, and accurately about the process, product, or research selected for the project.

To develop an ability to discover and employ appropriate resources or references throughout the project work.

To develop an ability to apply individual creativity and originality in an effort directed toward achieving the goals of the project.

To develop the ability to present the project work in a mode that is consistent with the professional standards for the type of project undertaken.

REQUIREMENT MET BY “OVERALL EVALUATION OF TWO UNITS OF WORK”

Students normally fulfill the humanities and arts degree requirement by completing two units of work consisting of five student-selected, thematically related courses or independent studies (each for 1/3 unit of credit) of increasing complexity. These courses culminate in the final 1/3 unit of independent study dealing with the theme running through the previous work. The theme of the Sufficiency project may derive from a single discipline or may draw upon ideas or use analytic tools from more than one humanities and arts discipline.

The faculty member advising the final independent study will certify that the student’s theme is consistent with previous work. Evaluation of this final independent study, which will be based on a research essay or on creative works or performance accompanied by analysis or participation in a seminar, will result in the final grade for the Sufficiency as a degree requirement. (See “Foreign Language Sufficiency” exception.) Students and faculty members should make clear at the outset of the final independent study what specific means of evaluation will be used for the culmination of the Sufficiency.

Advice and guidelines for the setting up of Sufficiency themes are available from department members as listed on pages 54 and 251. However, responsibility for the selection of specific courses leading to the final independent study rests ultimately with the student. Students are, therefore, urged to consult with a Humanities and Arts Department faculty member about possible final themes for the Sufficiency no later than the beginning of their third course in humanities and arts. Such early discussion of possible thematic topics enables students to plan effectively for additional work and strengthens greatly the cohesiveness of the final independent study.

A file (filed by advisor’s name) of all essays and portfolios accepted in completion of the Sufficiency in the previous academic year is available in the Humanities and Arts Department office. Students wishing to see what kinds of topics have been completed previously and how they relate to course work should examine examples of essays in areas of interest to them.

TRANSFER STUDENTS AND THE SUFFICIENCY REQUIREMENT

Transfer credit in the Humanities and Arts at WPI is granted on a course-for-course basis. All Transfer and 3-2 Program students entering WPI with *fewer than six courses or their equivalent of transfer credit in the Humanities and Arts* must complete thematically-related work in the Humanities and Arts, including a Sufficiency evaluation (#5 Independent Study/Project) to the extent that the overall Humanities and Arts credit totals two units.

No credit toward the Humanities and Arts requirement is given for introductory-level foreign-language courses unless the entire Sufficiency program is in that foreign language. Usually only one transfer course in Freshman English can be applied toward the Sufficiency requirement. In all cases, the Humanities and Arts Consultant who will serve as the advisor of the student’s #5 IS/P (“Sufficiency”) has the final decision on what courses are acceptable within the student’s Sufficiency sequence leading up to the project. Up to one unit (i.e. three courses) of transferred work in the Humanities and Arts that is not credited toward the Humanities and Arts Requirement can be credited toward the fifteen-unit graduation requirement; such courses shall receive credit under the category of EL 1000.

If a Transfer or 3-2 Program student *has completed two units of acceptable college-level work in the Humanities and*

Arts prior to entering WPI, a Completion of Degree Requirement form will be submitted by the Humanities and Arts Department Coordinator for Transfer Students at the request of the student. The grade for such a Humanities and Arts Requirement met by transfer credit is normally a B or C, but a student can request a grade of "CR". Students whose grades on transferred courses average A can submit samples of their course work and may be awarded an A for the Humanities and Arts Sufficiency Requirement. Alternately a transfer student may elect to undertake a #5 Sufficiency IS/P in an effort to achieve an A grade. These evaluation options must be exercised prior to the Department's submission of the Completion of Degree Requirement form to the Registrar.

Decisions concerning credit toward the Humanities and Arts requirement are made by the Humanities and Arts Coordinator for Transfer Students, Professor James Hanlan. He can be contacted in room 26 of Salisbury Laboratories, or at extension 5438, or email jphanlan@wpi.edu.

DEVELOPING A SUFFICIENCY PROGRAM IN HUMANITIES AND ARTS

The Humanities and Arts department offers most of its courses at the 1000-, 2000-, and 3000-level. Students are strongly encouraged to include one 1000-level course, two 2000-level courses, and one or more 3000-level courses in their program of *five* humanities and arts courses prior to their Sufficiency project term. Since the 1000-level courses may prove useful in developing a sense of what constitutes a *theme* in an area of the humanities or arts, the Department will accept two 1000-level courses toward the final Sufficiency project, as long as one of the courses involves material thematically related to that project. This progression through an area of study offers the student an opportunity to build an intellectual understanding of a subject while acquiring a cohesive broadening of knowledge that will lead to a challenging and rewarding Sufficiency program.

1000-Level Courses

Courses on this level introduce a discipline through exploration of available resources and research techniques, identification of critical issues, and examination of major themes, ideas, and interpretations.

2000-Level Courses

Courses on this level enhance both the knowledge and understanding of an area of study through concentration on specific themes, ideas, or approaches and refinement of expressive and analytic skills.

3000-Level Courses

Courses on this level, offered in a seminar format, focus on the application of those critical and analytical skills developed in lower-level courses, leading students to well defined Sufficiency project topics.

AREAS FOR THE SUFFICIENCY IN HUMANITIES AND ARTS

In developing the Sufficiency requirement (see the "Humanities and Arts Sufficiency" section, page 21), students will choose courses from traditional academic disciplines within the broad area of the humanities and arts at WPI. The Sufficiency program may be limited to courses in a single discipline, such as European history or English literature, or it may include more than one discipline and involve courses, for example, in the history, literature and philosophy of a particular period. In both cases, it is essential that a single "theme," derived from the various courses, be developed in the final Independent Study/Project (IS/P). Students are urged, before or during their third course in the sequence, to consult with a Humanities and Arts faculty member regarding their intended final IS/P.

Humanities and Arts Areas and Consultants

Topics	Project Advisor
Topics in American Studies	S. Bullock (SCB), J. Hanlan (JPH), K.Ljungquist (KPL), J. Manfra (JM), W. Mott (WTM), J. Trimbur (JOT)
Topics in Art	J. Rosenstock (JR1), M. D. Samson (MDS)
Topics in Drama/Theatre	J. Sands (JTS), S. Vick (SV), J. Zinn (JWZ)
Topics in Foreign Language (German)	D. Dollenmayer (DZD)
Topics in Foreign Language (Other)	A. Rivera (AAR)
Topics in Foreign Language (Spanish)	H. J. Manzari (HJM), A. Rivera (AAR)
Topics in Global Studies	W. Addison (WAA), E. Choi (EYC), P. Hansen (PHH)
Topics in History (American)	W. Baller (WXB), M. Barroll, S. Bullock(SCB), D. Gray (DEG), J. Hanlan (JPH), J. Manfra (JM), D. Rawson (DZR), J. Watters (JEW)
Topics in History (European)	W. Addison (WAA), W. Baller (WXB), J. Forgeng (JLS), P. Hansen (PHH)
Topics in History (Science and Technology)	M. Barroll, J. Forgeng (JLS), E. Parkinson (EMP), D. Spanagel (DIS), J. Watters (JEW)
Topics in International Studies- Humanities (Interrelated)	B. Addison (WAA), P. Hansen (PHH)
Topics in Literature (American)	J. Dempsey (JD4), K. Ljungquist (KPL), W. Mott (WTM), S. Nikitina (SNZ)
Topics in Literature (Contemporary)	J. Trimbur (JOT)
Topics in Literature (English)	J. Brattin (JYB), M. Ephraim (MKE), P. Quinn (PJQ)
Topics in Music	F. Bianchi (FB), J. Delorey (JD2), R. Falco (RGF), E. Shim (ES1), D. Weeks (DGW)
Topics in Philosophy	R. Gottlieb (RSG), J. Sanbonmatsu (JS6)
Topics in Religion	D. Shikiar (DAS), R. Smith (RLS)
Topics in Writing, Rhetoric, and Communications	L. Higgins (LDH), J. Trimbur (JOT)
International Students	J. Forgeng (JLS)
IMGD	D. O'Donnell (DMO), J. Rosenstock (JR1)

A descriptive listing of the humanities/arts disciplines follows.

AM—AMERICAN STUDIES

Students considering Sufficiencies in American Studies may begin with HU 1411, Introduction to American Studies, or may include that course early in their sequence. American Studies is an interdisciplinary Sufficiency program. Students should select courses from the areas of literature (EN), history (HI), philosophy (PY), religion (RE), art history and architecture (AR), and music (MU) and should, in the final Sufficiency project, investigate an American theme which derives from the courses selected.

AR—ART HISTORY/ARCHITECTURE

Students considering Sufficiencies in the history of art or architecture should begin with AR 1111, Introduction to Art History, or the 2000-level course offerings in modern art or architecture. Another WPI course relevant to an art Sufficiency is AR/ID 3150, Light, Vision, and understanding, which relates painting to the history and philosophy of science. A variety of independent studies are also available. Students are encouraged to consider studio art courses and some of the more specific upper-level courses in the arts offered elsewhere in the Worcester Consortium, especially at Clark University and the College of the Holy Cross (catalogs available at Gordon Library).

EN—LITERATURE (INCLUDING DRAMA/THEATRE)

Students selecting Sufficiencies in literature may begin by selecting any of the 1000- or 2000-level EN courses. Subsequent courses may emphasize American or British literature, drama/theatre, fiction or poetry, or any mixture of these; or subsequent courses may seek to define themes involving any other humanities and arts disciplines. However, in every case students should consider with care how the first five courses are preparing them to define and develop a theme in their final Sufficiency independent study.

FOREIGN LANGUAGES

For a description of Sufficiencies in German, Spanish, and in other foreign languages, see page 57.

GS—GLOBAL STUDIES

Students considering Sufficiencies in Global Studies may begin with HI 1341 Introduction to Global History, or may include that course early in their sequence. Global Studies is an interdisciplinary Sufficiency program. Students should select courses from the areas of: literature (EN); foreign language, civilization and literature (SP, GN); history (HI); philosophy (PY); religion (RE); art history and architecture (AR); and music (MU). In the final Sufficiency project, they should investigate an issue from a global perspective that derives from the courses selected.

HI—HISTORY (INCLUDING HISTORY OF SCIENCE AND TECHNOLOGY)

Students selecting Sufficiencies in history may begin by taking any of the 1000- or 2000-level HI courses. Subsequent courses may emphasize history in the following categories: general, cultural, diplomatic, intellectual, psychological, social, science and technology, or any mixture

of these. Subsequent courses may also seek to define themes involving any other humanities and arts discipline.

In any event, students should consider carefully how the five courses are preparing them to define and develop a theme in their final Sufficiency independent study.

HU—HUMANITIES

Courses in a variety of topics are listed under the general title of Humanities; many of these could be used in interdisciplinary Sufficiency themes or related to conventional disciplinary themes in several areas.

MU—MUSIC

Music courses are available to any interested WPI student, and private instruction is available in both vocal and instrument music. For those planning a Sufficiency in music (involving five courses and a final IS/P), a minimal level of music capability on the student's part is assumed.

For Sufficiency students, MU 1611 and MU 2611, Fundamentals of Music I and II (or the equivalent knowledge) should be completed early in students' musical course work. The Sufficiency's purpose is to acquaint students with the basic vocabulary of music (in Fundamentals); with aspects of music history (in the 2000 courses), and with areas of special interest, which might include performance work in ensembles or in private lessons, independent study (such as composition or theory, and computer music), or selected work at other Consortium institutions.

Also available to interested students are the following ensembles sponsored by the music faculty. Those listed here currently receive credit toward the music Sufficiency.

Choral	Men's Glee Club Women's Chorale Chamber Choir
Instrumental	Brass Ensemble Concert Band Jazz Band Stage Band Medwin String Ensemble Chamber Orchestra

There is no sequential significance to courses above 2000; however, students should select five courses (or three beyond Fundamentals I and II) which give meaningful sequential significance to their particular musical interests, with the final IS/P reflecting the realization of these goals.

PY AND RE—PHILOSOPHY AND RELIGION

Students can follow a sequence of courses concentrating on either philosophy or religion, though a coherent combination of philosophy and religion courses is also possible. Students doing a Sufficiency in philosophy or religion will normally take three courses below the 3000 level before pursuing more advanced courses at the 3000 level. Since each individual 3000-level course is offered every other year, students should plan early the advanced topics they wish to pursue in order to organize their sequences around the year(s) in which are offered the 3000-level courses of particular interest to them. In planning their Sufficiency sequences, students might find it constructive to take humanities and arts courses outside philosophy or religion that relate to the theme of their Sufficiency.

GETTING STARTED IN HUMANITIES AND ARTS

These are the “1000” or “2000” level courses from which most students select their first Humanities and Arts elective.

Art History and Architecture

AR 1111 Introduction to Art History

English

EN 1221 Introduction to Drama: Theatre on the Page and on the Stage
 EN 1222 Shakespeare in the Age of Elizabeth
 EN 1231 American Literature: Beginnings Through Hawthorne
 EN 1242 Introduction to English Poetry
 EN 1251 Introduction to Literature
 EN 1257 Introduction to African American Literature and Culture*
 EN/WR 2211 Elements of Writing

Foreign Language

GN 1511, 1512 Elementary German I,II
 GN 2511, 2512 Intermediate German I,II
 SP 1523, 1524 Elementary Spanish I,II
 SP 2521, 2522 Intermediate Spanish I,II

History

HI 1311 Introduction to American Urban History
 HI 1312 Introduction to American Social History
 HI 1313 Introduction to the Study of Foreign Policy and Diplomatic History
 HI 1314 Introduction to Early American History
 HI 1321 Introduction to European Social History
 HI 1322 Introduction to European Cultural History
 HI 1331 Introduction to the History of Science
 HI 1332 Introduction to the History of Technology
 HI 1341 Introduction to Global History

Interdisciplinary

HU 1411 Introduction to American Studies*
 HU 1412 Introduction to Asia

For International Students

IS 1811 Writing for Non-native Speakers of English
 IS 1812 Speech for Non-native Speakers of English
 IS 1813 American History for International Students

Music

MU 1611 Fundamentals of Music I

Philosophy and Religion

PY/RE 1731 Introduction to Philosophy and Religion

*Offered in alternate years.

PERFORMANCE SUFFICIENCY IN MUSIC

The final IS/P in music is available as a performance IS/P only with the written permission of a WPI faculty member in music. Such consent must be obtained before the beginning of the term in which the student is to perform. Performance Sufficiencies will be available only to students who can demonstrate an underlying knowledge of essential music theory and music history.

In addition to their performance, all students in a performance Sufficiency must submit a substantial essay that articulates how their academic knowledge of music was enhanced by the performance. The grade for the Sufficiency will be based on the level of both the performance recital and the essay.

PERFORMANCE SUFFICIENCY IN DRAMA/THEATRE

Students may complete a performance Sufficiency project in theatre by participating in a production of a play, either as part of the regularly scheduled Humanities and Arts Department Productions, as a part of the Masque season of play production, or in some other way. In addition to the performance, each student must complete a substantial written document which reflects the performance work and demonstrates considerable knowledge of the area of expertise. Project advisors: Prof. S. Vick, J. Sands, and J. Zinn, Humanities and Arts.

The IGSD periodically cosponsors projects at the London Project Center or the Edinburgh International Festival Fringe in conjunction with the Department of Humanities and Arts. For more information on these opportunities, contact the Department of Humanities & Arts, Division of Drama/Theatre.

FOREIGN LANGUAGE SUFFICIENCY

Students who have taken some German or Spanish before coming to WPI should attend the foreign-language placement session during New Student Orientation to determine the appropriate level at which to begin the Sufficiency. Most students complete the Sufficiency in Foreign Language by passing six courses in the language. Students who can begin language study at WPI on or near the advanced level may complete the Sufficiency by writing a final IS/P in German or Spanish.

Students interested in a language other than German and Spanish can complete a Sufficiency in that language by taking courses offered by the Consortium. For further details see Prof. Rivera, Salisbury Labs 16.

FOREIGN LANGUAGE AND CIVILIZATION SUFFICIENCY

Students who wish to combine foreign language courses with other fields in the humanities and arts should note the following guidelines:

Students may supplement intermediate or advanced foreign language courses by completing their Sufficiencies in related humanities and arts fields that deal with the culture of that language and the countries where it is spo-

ken. The final IS/P must be written in English. Note: Elementary courses in the foreign language do not count towards this Sufficiency.

For further details on foreign language courses and Sufficiencies, see Prof. Dollenmayer, Alden Memorial 209 or Prof. Rivera, Salisbury Labs 16.

GUIDELINES FOR GRANTING TRANSFER CREDIT TO U.S. STUDENTS FOR FOREIGN LANGUAGE STUDY

- A. Credit for study on the high school level:
 1. Transfer credit of 1/3 unit is given for Advanced Placement with a score of 4 or 5.
 2. Students with three or more years of foreign-language study in high school, but who have not taken the Advanced Placement examination in that language, may receive 1/3 unit credit for their high school language study upon satisfactory completion of two courses in the same language on the intermediate level or above. (Note: Courses in German and Spanish in addition to those offered at WPI, as well as courses in other languages, are available at other colleges in the Consortium.)
 3. In either case 1. or 2. above, in order to receive 1/3 unit credit, students must begin their WPI course sequence at the Elementary II level or above.
- B. Credit for study at other colleges and universities:
 1. Language study which is done at other universities and colleges prior to entering WPI, or done with the prior written permission of the student's Humanities and Arts Consultant (not the Department Head) as part of an agreed-upon Sufficiency sequence, transfers on a course-for-course basis.
 2. Language study which is done at foreign universities, language institutes, cultural institutes, etc., prior to entering WPI, or done with the prior written permission of the student's Humanities and Arts Consultant (not the Department Head) as part of an agreed-upon Sufficiency sequence, is assessed by the Foreign Languages Consultant on the basis of matriculation papers and the level of work accomplished.

SUFFICIENCY PROGRAM FOR HUMANITIES AND ARTS MAJORS

Students majoring in Humanities and Arts would normally fulfill the Sufficiency requirement in an engineering or science area. One of the primary responsibilities of the Humanities and Arts student will be to devise, with an advisor's help, a substantial program of scientific and technological studies leading to the completion of the Sufficiency requirement. Before developing their programs, students should have clearly in mind what career goals they wish to reach and should be prepared to schedule as many scientific courses as are needed to qualify them as literate in some area of technology. The minimum technological requirement for the student fulfilling the Sufficiency requirement by coursework is two units of study. Many career opportunities may demand more extensive preparation in technological disciplines, and students are

strongly advised to take full advantage of WPI's resources in science, technology, and mathematics by pursuing the Sufficiency well beyond the minimum requirement.

Areas Available	Faculty Consultants
Biology and Biotechnology	E. Overström
Biomedical Engineering	Y. Mendelson
Chemical Engineering	D. DiBiasio
Chemistry and Biochemistry	J. Pavlik
Civil and Environmental Engineering	F. Hart
Computer Science	D. Finkel, M. Gennert
Electrical and Computer Engineering	F. Looft, H. Hakim
Industrial Engineering	S. Johnson
Interdisciplinary Studies	R. Vaz
Mathematical Sciences	B. Vernescu
Mechanical Engineering	G. Tryggvason
Physics	J. Norbury

SUFFICIENCY FOR INTERNATIONAL STUDENTS

In order to take full advantage of their opportunity to study in the United States, all international students whose native language is not English must fulfill their Sufficiency requirement through studies conducted in the English language. Exceptions to this policy may be made by the Consultant for Sufficiencies for International Students (CSIS), in the case of students who have had extensive educational experience in the English language, e.g., English-speaking secondary school. The actual sequence of courses should be determined with the advice of the Consultant for Sufficiencies for International Students. Two approaches are suggested:

BASIC SUFFICIENCY FOR INTERNATIONAL STUDENTS

Students whose command of the English language is not on the level of that of an undergraduate whose native language is English should begin their program by successfully completing IS 1811 (Writing for Non-native Speakers of English) and IS 1812 (Speech for Non-native Speakers of English). They may then choose three other courses in Art, English, History, Music, or Philosophy/Religion by arrangement with the Consultant (CSIS). Especially appropriate are the various Humanities Concepts courses and IS 1813, American History for International Students. The final Sufficiency project may be done with any Department member who agrees to advise the topic.

THEMATIC SUFFICIENCY FOR INTERNATIONAL STUDENTS

Students who believe that their command of English is sufficient to begin work on the level of the undergraduate whose native language is English should, with the advice of the Consultant (CSIS), select a first course in an area of their likely interest for the final Sufficiency project. Students passing this first course should proceed through the regular Sufficiency sequence leading to a final project with any Department member who agrees to advise their work. If students do not pass this first course, and the instructor in consultation with the Consultant determines that inadequate proficiency in English was a factor, then such students should proceed through the basic Sufficiency for International students outlined above.

OTHER OPTIONS

SOCIAL SCIENCE COURSES

Humanities and Arts Sufficiency project advisors may allow students to include one social science course in their Sufficiency sequence on the basis of that course's suitability to the development of students' particular humanities themes.

Such a course must be more than "related to" or "in support of" a given theme. It must be at the interface of humanities (normally history) and blend in with certain Humanities and Arts courses. A course in American government, for example, could logically be included in any number of American history sequences.

The inclusion of a social science course in the Humanities and Arts Sufficiency of any student requires the *written* "advice and consent" of his or her Sufficiency project advisor *after* the theme has been determined and *before* the student registers for the course.

One of the following social science courses (and *no* other) may be included in the Humanities and Arts Sufficiency sequence:

GOV 1301 U.S. Government
 PSY 1402 Introduction to Social Psychology
 STS 2208 The Society - Technology Debate

INTERDISCIPLINARY SUFFICIENCY AT THE AMERICAN ANTIQUARIAN SOCIETY

A unique opportunity for interdisciplinary work in the humanities and arts is offered by the American Studies Seminar sponsored each fall by the American Antiquarian Society. Organized in collaboration with Worcester's five undergraduate colleges and universities, this seminar focuses on topics that allow students to investigate the Society's rich holdings in early American history, literature, and culture. The Society's unparalleled collection of documents is a short walk from the campus. Information on application deadlines and academic credit toward this Sufficiency is available from the WPI Campus Representative to the American Antiquarian Society.

OFF-CAMPUS SUFFICIENCY OPTION

WPI offers the option to complete the Humanities and Arts Sufficiency Requirement during one term of study at several Project Centers. Normally, students complete the sufficiency requirement through at least six courses or independent-study projects on campus. However, the "Off-Campus Sufficiency" option allows students to combine at least three courses on campus with one term studying the humanities and arts at a Project Center. Since this one-term project is equivalent to three courses, students may use it to complete the sufficiency requirement.

Off-campus sufficiency projects are available in Germany for the study of foreign languages and in London for other fields. These off-campus sufficiency programs have a flexible format. Students devote themselves to one term studying the history, literature, language or culture at the project site with a WPI faculty advisor. The program

might combine a thematic seminar in an area of the faculty advisor's expertise with visits to museums, the theatre, musical performances, or cultural excursions.

Although themes or areas of emphasis vary from year to year, all off-campus sufficiency projects culminate in a written report in an area of interest to the student.

To be eligible for this one-unit sufficiency project, students must have already completed three courses in humanities and arts before they leave campus. Students may apply to the off-campus sufficiency program before they have taken all three courses. However, students may not participate in the program unless they successfully complete one unit of work in humanities and arts before the term of the project. In addition, students going to any Project Center must complete all of the forms required by the Interdisciplinary and Global Studies Division.

Requirements:

- Students must have completed at least three courses in the Humanities and Arts at WPI, or have earned equivalent course credit approved by the Humanities and Arts Department, before the term of the off-campus sufficiency project. The Department may allow students to count transfer or advanced placement credits toward the three course minimum;
- Students must be accepted into the off-campus sufficiency program by the Humanities and Arts Department, and complete all forms required by the Interdisciplinary and Global Studies Division, in order to register for these projects.
- Students might be required by the faculty advisor to complete a PQP or attend required meetings before the off-campus project;
- Students must submit a written report or paper at the end of the project. Students also may be required to submit written updates at various times in the course of the project. In all cases, the faculty advisor at the project site will determine the precise form of the written requirements.
- Students may be required to give an oral presentation at the end of the project;
- Under normal circumstances, students must complete the project within one term in order to receive the full unit of credit;
- Only members of the Humanities and Arts faculty at WPI may advise off-campus Humanities and Arts sufficiency projects.

Recommendations

All off-campus sufficiency options benefit from advance planning. Discuss the possibility of an off-campus sufficiency with your academic advisor at the beginning of the freshman year. Consult with the WPI faculty who

will advise these off-campus projects as early as possible, since they may be able to suggest useful courses or other background resources for the projects. Also keep in mind that three courses are the *minimum* required, but many students find it advantageous to take additional courses before going away.

The *interdisciplinary London sufficiency program* is open to students with a background in areas of the humanities and arts besides foreign languages, including art history and architecture, drama/theatre, history, literature, music, philosophy, religion, or writing/rhetoric. After taking at least three courses in any of these areas on campus, you could then go to London to complete your sufficiency project. Some students also have gone to London with this program to study beyond the sufficiency requirement for international studies, history, literature, music, theatre, or other areas.

WPI offers sufficiency programs in the *German language at Darmstadt*. This program requires completion of foreign language courses through the level of intermediate II or above (2000-level or above) before going abroad. For students who have taken foreign language courses in high school, language placement exams are available during New Student Orientation. Some students with basic foreign language preparation have completed their arts projects in Germany. We welcome a creative approach to off-campus study.

More advanced students may participate these off-campus programs by doing work toward a minor or major. A student who had already completed their sufficiency requirement on campus, for example, might be able to work in the humanities and arts on an Independent Study Project that could count toward minors. Or a student at one of these sites could work on a Major Qualifying Project in fields such as Humanities and Arts, International Studies, or Technical, Scientific and Professional Communication.

The Humanities and Arts Department advertises upcoming project locations and application deadlines at the Global Opportunities Fair each September. Future project opportunities might include other foreign locations or projects that provide the context for an intensive study of humanistic themes associated with particular locales within the United States. Contact the Department of Humanities and Arts for more information.

Social science deals with the behavior of individuals and groups as well as the functioning of the economic and political systems and institutions that shape and control our lives. As such, it offers a perspective that is essential for anyone desiring a well-rounded education.

Therefore, WPI, in common with other colleges, requires some exposure to the social sciences for its graduates. In satisfying the two-course social science requirement, students are free to take courses in any of the traditional social sciences: economics, political science, sociology, and psychology. The social science courses offered at WPI are grouped into two broad categories. The first consists of core courses that introduce students to the social sciences and help them understand the scope and limits of social science approaches and how they might be related to the design of Interactive Qualifying Projects. The second, more advanced, set of courses looks in depth

at particular issues and problems, providing students with a more detailed understanding of social science disciplines and their use in social problem solving and interactive projects.

To obtain maximum benefit from their study of social science, students should choose courses that will provide knowledge and skills relevant to their Interactive Qualifying Project. These courses should be taken prior to or concurrent with undertaking the IQP and should be selected, if possible, after the student has identified the general topic area in which his or her interactive project work will be carried out.

More information on the alternatives available and the factors that should be considered in choosing courses to satisfy the social science requirement are presented in the Social Science and Policy Studies section of this catalog, page 175.

AWARDS AND PRIZES

Awards and prizes are determined by the academic department or by selected committees.

COLLEGE AWARDS

SALISBURY PRIZE AWARDS

These historic awards are made to 14 highly meritorious seniors. These awards were established by Stephen Salisbury, a WPI founder and former president of the Board of Trustees.

TWO TOWERS PRIZE

This prize is awarded to the student who, through general academic competence, campus leadership, regular course work and special work in research and projects, best exemplifies a combined proficiency in the theoretical and practical union implicit in the Two Towers concept, which is at the heart of WPI's Two Towers tradition.

SIGMA XI AWARDS IN ENGINEERING AND SCIENCE

These awards in engineering and science are given to the students and their advisors for the Major Qualifying Projects which are judged to be the best in originality, contribution to the field, professional competence, and for the most useful applications.

PRESIDENT'S IQP AWARDS

These awards are given to student teams whose conception, performance, and presentation of their Interactive Qualifying Projects have been judged outstanding in focusing on the relationships among science, technology, and the needs of society.

PROVOST'S MQP AWARDS

These awards offer recognition to those students who have completed outstanding Major Qualifying Projects as a demonstration of their competency in a chosen academic discipline. Each academic department conducts its own competition to select the winners.

UNITED TECHNOLOGIES CORPORATION MINORITY AWARD

This award is presented to an outstanding minority undergraduate student.

OUTSTANDING WOMEN STUDENT AWARDS

Marietta E. Anderson Award, an award which is presented to the most outstanding woman student in one of the three lower classes who not only has a superior academic record, but also has been a work-study student, participated in recognized extracurricular activities, and has been a volunteer for college-sponsored activities.

United Technologies Corporation and the Society of Women Engineers Award

This award is presented to an outstanding woman undergraduate student.

Funds from an anonymous donor provide the following awards to women students preparing for careers in engineering or science. Awards are based on academic excellence, contributions to the WPI community, and professional goals. The awards are named each year for women who have played significant roles at WPI.

Bonnie-Blanche Schoonover Award, honoring WPI's former librarian.

Ellen Knott Award, honoring a long-time secretary in the Mechanical Engineering Department.

Gertrude R. Rugg Award, honoring WPI's late Registrar Emerita.

WILMER L. AND MARGARET M. KRANICH PRIZE
Students who are seniors or completing their junior year will be nominated by faculty for the annual award. The award will go to a student majoring in engineering, science or management who best exemplifies excellence in the humanities and in the full integration of humanities into his/her undergraduate experience. Double-majors who fulfill one major in Humanities and Arts are not eligible.

SPECIAL AWARDS

ALPHA PHI OMEGA SERVICE AWARD

AMERICAN INSTITUTE OF CHEMISTS FOUNDATION

Chemistry and Biochemistry

An award by the New England chapter of the American Institute of Chemists to honor outstanding *seniors majoring in chemistry and biochemistry*.

AMERICAN SOCIETY FOR METALS: CHESTER M. INMAN '14 OUTSTANDING STUDENT AWARD

Mechanical Engineering

The Worcester Chapter of the American Society for Metals presents \$200 to a student for excellence in a Major Qualifying Project dealing with processing or materials science.

HAROLD S. BLACK AWARD

Electrical and Computer Engineering

This award was established in 2001 to honor the memory of inventor Harold S. Black '21. The award is given by the faculty of the Electrical and Computer Engineering (ECE) Department to one or more ECE seniors who have demonstrated outstanding creativity and enthusiasm in engineering problem solving, practical implementation of problem solutions, and exemplary character in their contributions to the welfare of the WPI community.

CENTRAL NEW ENGLAND AIChE AWARD FOR SIGNIFICANT CONTRIBUTION

Chemical Engineering

This award is given to an individual in recognition of significant contributions to the American Institute of Chemical Engineers.

CLASS OF 1879 PRIZE FOR OUTSTANDING PROJECTS IN THE HUMANITIES

Humanities and Arts

This prize is awarded by the Humanities and Arts Department each year to three students for excellent work in Humanities and Arts Sufficiency projects. Sufficiencies must demonstrate exceptional creativity and skill in conceiving, developing and expressing a theme within any discipline in the humanities and arts.

COMMUNITY SERVICE AWARD PRESENTED IN THE MEMORY OF EDWIN B. COGLIN '23

Alumni Office

This award recognizes individuals who have demonstrated an extraordinary personal commitment above and beyond their normal involvement on campus in both academic and extracurricular activities.

COMPUTER SCIENCE OUTSTANDING JUNIOR AWARD

Computer Science

This award is presented to a computer science junior who has an excellent academic record and who shows promise for continuing success.

COMPUTER SCIENCE OUTSTANDING SENIOR AWARD

Computer Science

This award is presented to one or more computer science seniors who have an outstanding record and who have contributed to the enrichment and professional development of fellow students.

JAMES F. DANIELLI AWARD

Biology and Biotechnology

This award, given by the Department of Biology & Biotechnology, honors the memory of Dr. James F. Danielli, a former department head and world-famous scholar.

FRANK D. DEFALCO AWARD

Civil and Environmental Engineering

Award to WPI undergraduate Civil Engineering students who has completed two and one half years towards a B.S., interested in career constructed facilities and a member of ASCE student chapter.

ETA KAPPA NU OUTSTANDING STUDENT AWARD

Electrical and Computer Engineering

The electrical and computer engineering honor society presents this award to the outstanding senior and junior in recognition of their academic achievement and their service to the WPI community.

GENERAL CHEMISTRY ACHIEVEMENT AWARD

Chemistry and Biochemistry

This award is given to the student who has completed the *freshman* chemistry course with superior academic performance. Department award.

ALLAN GLAZER AWARD

Mechanical Engineering

Established in 1992 by the family and friends of Allan Glazer '47, this award is given to a junior majoring in mechanical engineering who has demonstrated outstanding academic achievement, special ingenuity in problem solving, and enthusiasm for engineering challenges.

GOAT'S HEAD AWARD FOR OUTSTANDING CONTRIBUTION TO THE STUDENT GOVERNMENT ASSOCIATION

Student Government Association

THE ROBERT H. GODDARD AWARD*Physics*

Established by the classes of 1908 and 1909 as a memorial to Dr. Goddard, this prize is awarded for outstanding achievement, scholarship, consistent effort and dedication of purpose in both theoretical and experimental areas of physics.

HEALD BROTHERS SCHOLARSHIP*Mechanical Engineering*

This scholarship identifies and supports outstanding young men and women who represent, in modern form, the spirit of "Yankee Ingenuity" that characterizes the evolution of the great manufacturing enterprises from the beginnings of the American Industrial Revolution.

ANDREW HOLT MEMORIAL AWARD*Civil and Environmental Engineering*

This award is presented to a civil engineering senior who has consistently earned academic honors and who shows excellent promise for success.

STEVEN J. KAHN AWARD*Humanities and Arts*

This award is presented to the outstanding senior in the WPI Glee Club in recognition of his contribution, commitment, and unwavering loyalty to the organization.

THE WILLARD ELLIOT LAWTON-SAMUEL**JAMES PLIMPTON AWARD***Physics*

Established in honor of Professors Lawton and Plimpton, this award is presented to a student who has shown improvement in scholarship, not only in grades but also in depth of understanding.

LINCOLN ARC WELDING FOUNDATION AWARD*Civil and Environmental Engineering*

This award recognizes outstanding achievement in solving design, engineering, fabrication, and research problems.

MEDWIN HONORS STRING QUARTET SCHOLARSHIP*Humanities and Arts*

Scholarship money is given to the members of the Medwin Honors string Quartet (4 string players, 2 violins, 1 viola, 1 cellist), who are selected by audition each year.

THE ALFRED R. AND JANET H. POTVIN AWARD*Biomedical Engineering*

Separate awards are given to the outstanding undergraduate and graduate student in Biomedical Engineering in recognition of their academic performance and their service to WPI and/or the outside community.

MANAGEMENT EXCELLENCE AWARD*Management*

This award is given to one or more seniors who have demonstrated ability in courses and projects and who exhibits outstanding promise of future success in the field of management engineering.

CARL F. MEYER IMPROVEMENT AWARD IN CIVIL ENGINEERING*Civil and Environmental Engineering*

Established by Professor Emeritus Meyer, this award is presented to the civil engineering senior who has demonstrated the most improvement in academic and professional attitude since entering the department.

RICHARD V. OLSON AWARD*Mathematical Sciences*

Established to honor the memory of mathematics Professor Richard V. Olson, this annual award to a WPI sophomore recognizes outstanding performance in basic mathematics courses.

EDWARD C. PERRY AWARD*Mechanical Engineering*

This award is given annually to an engineering student or students for an outstanding major qualifying project in the area of mechanical design. The award is made possible through a bequest from Miriam Perry Goll and honors the memory of her father, Edward C. Perry '04, a design engineer with General Electric Company throughout his professional career.

PI TAU SIGMA AWARD FOR EXCELLENCE*Mechanical Engineering*

The mechanical engineering honor society, Pi Tau Sigma, presents this award to the outstanding junior mechanical engineering student.

SENIOR MATHEMATICAL SCIENCES MAJOR AWARD*Mathematical Sciences*

This award is presented to the senior mathematical sciences major who has shown outstanding performance and who has made valuable contributions to the WPI mathematical community.

SOCIETY OF MANUFACTURING ENGINEERING SCHOLARS AWARD*ME/Manufacturing Engineering Program*

An MFE senior, recommended by the MFE faculty and confirmed by the officers of SME chapter 25, who has demonstrated excellent scholarship, leadership, service, potential to contribute to the profession of Manufacturing Engineering.

The award includes scholarship assistance (\$900) for full-time study if the winner enrolls in WPI's graduate MFE program.

SOCIETY OF MANUFACTURING ENGINEERING UNDERGRADUATE SCHOLARSHIP AWARD*ME/Manufacturing Engineering Program*

Awarded to a 1st, 2nd, or 3rd year MFE major, recommended by the MFE faculty and confirmed by the officers of SME chapter 25, who has demonstrated excellent scholarship, commitment, and contribution to the Manufacturing Engineering program at WPI.

**SOCIETY OF MANUFACTURING ENGINEERS
OUTSTANDING STUDENT AWARD**

ME/Manufacturing Engineering Program

The top three MFE majors each year, regardless of year, who have not already received the award.

**SOCIETY OF MANUFACTURING ENGINEERS
MQP AWARD**

ME/Manufacturing Engineering Program

An MFE major, selected by a panel of practicing manufacturing engineers to have the best MQP in the area of Manufacturing Engineering.

STUDENT-ALUMNI INTERACTION AWARD

Alumni Office

This award is presented by the WPI Alumni Association in recognition of individuals who, through their involvement on campus, have facilitated the continuing development of interaction between students and alumni.

Recipients are full-time undergraduate students who have demonstrated extraordinary personal commitment to WPI and the Alumni Association above and beyond the normal involvement on campus.

The award is designed to recognize students who have stepped forward to become leaders in the alumni and student communities and, in doing so, have benefited both WPI students and alumni in a unique and purposeful way.

CHARLES O. THOMPSON SCHOLARS

Academic Advising

Named in honor of the first president of WPI, this honor recognizes outstanding performance by first-year students.

To be eligible for membership, students must receive all A's and B's, with a minimum of six A's, in their academic subjects during the first three terms at WPI. Selections are made in Term D.

A cash award is presented to the outstanding first year student. Charles O. Thompson Scholars are eligible to apply for this award by submitting an essay to the Office of Academic Advising during D Term.

**ACS UNDERGRADUATE AWARD
IN ANALYTICAL CHEMISTRY**

Chemistry and Biochemistry

Award which is intended to encourage student interest in analytical chemistry and to recognize a student who displays an aptitude for a career in the field. *This award is for third-year students.*

WALL STREET JOURNAL AWARD

Management

The Wall Street Journal presents this award to a senior with an outstanding record of achievement.

DEPARTMENT AND PROGRAM DESCRIPTIONS

Aerospace Engineering	65
Air Force Aerospace Studies	67
Biology and Biotechnology	68
Biomedical Engineering	72
Chemical Engineering	93
Chemistry and Biochemistry	97
Civil and Environmental Engineering	101
Computer Science	108
Computer Science Minor	114
Electrical and Computer Engineering	114
Minor in Computer Engineering	123
Engineering Science Courses	123
Engineering Physics	123
Environmental Programs	124
Fire Protection Engineering	126
Humanities and Arts	127
Minor in Foreign Language	130
Minor in Music	130
Minor in Writing and Rhetoric	131
Industrial Engineering	131
Interdisciplinary Programs	132
Teacher Licensing	134
International Studies	134
Law and Technology Minor	136
Management	136
Entrepreneurship Minor	145
Management Minor	146
MIS Minor	146
Organizational Leadership Minor	147
Manufacturing Engineering	147
Minor in Manufacturing Engineering	150
Materials Engineering	150
Minor in Materials	150
Mathematical Sciences	151
Statistics Minor	159
Mathematics Minor	159
Mechanical Engineering	160
Military Science	166
Physical Education	168
Physics	169
Physics Minor	173
Pre-Law Programs	173
Pre-MBA Program (Dual Degree)	173
Pre-Medical, Pre-Dental and Pre-Veterinary Programs	174
Project-Based Learning Community Option (PLC)	175
Robotics	175
Social Science and Policy Studies	175
Social Science Minors	186

S E C T I O N
two

AEROSPACE ENGINEERING

DIRECTOR: N. A. GATSONIS

PROFESSORS: M. Demetriou, W. Durgin, N.A. Gatsonis, H. Johari, F. Looft, R. Sisson

ASSOCIATE PROFESSORS: D. Olinger, M. Richman

ASSISTANT PROFESSORS: J. Blandino

PROFESSOR OF PRACTICE: R. Labonte

MISSION STATEMENT

The primary goal of the Aerospace Program at Worcester Polytechnic Institute is to provide students with a comprehensive education that will enable them to establish productive careers in the aerospace industry, government, or academia. To this end, the program seeks to impart strong technical competence in fundamental engineering principles along with specialized competence in astronautical and aeronautical topics. At the same time we nourish a student's creative talents through research opportunities, with the goal to develop a personal high standard of excellence and professionalism in our students. Finally, an appreciation of the role of the engineer in society, including ethical and environmental concerns relevant to the profession, is provided.

PROGRAM OUTCOMES

The Aerospace Engineering Program educates its graduates to have:

- an ability to apply knowledge of mathematics, science, and engineering.
- an ability to design and conduct experiments, as well as to analyze and interpret data.
- an ability to design aircraft, spacecraft, or other vehicular systems and components that require integration of aeronautical or astronautical topics.
- an ability to function on multi-disciplinary teams.
- an ability to identify, formulate, and solve engineering problems.
- an understanding of professional and ethical responsibility.
- an ability to communicate effectively.
- the broad education necessary to understand the impact of engineering solutions in a global and societal context.
- a recognition of the need for, and an ability to engage in life-long learning.
- a knowledge of contemporary issues in aerospace engineering.
- the ability to use the techniques, skills, and modern engineering tools necessary for aerospace engineering practice.
- knowledge of orbital mechanics, space environment, attitude determination and control, telecommunications, space structures, and rocket propulsion.
- knowledge of aerodynamics, structures, and propulsion.

PROGRAM OVERVIEW

Aerospace Engineering is a challenging and exciting field that is concerned with the design of aircraft and space systems. The US aerospace industry is the world leader and one of the largest positive contributors to the US economy. WPI's aerospace program is well balanced to assure that the students develop strong technical competency in the fundamental principles in mathematics, basic science, while offering comprehensive education in Aerospace Engineering. The structure of the program enhances the student's educational scope while opening career opportunities both in Aeronautics or Astronautics related fields. The Aerospace program at WPI is exemplary through its courses and senior Major Qualifying Projects (MQPs). Students obtain hands on experience through the completion of an aerospace-related MQP and through laboratory work in courses. Experimental facilities available for course and projects in aerospace engineering include several wind tunnels, vacuum chambers, and controls instrumentation. Modern computational laboratories are also available.

Program Distribution Requirements for the Aerospace Engineering Major

The normal period of residency at WPI is 16 terms. In addition to the WPI requirements applicable to all students (see page 21) students wishing to receive a BS degree in "Aerospace Engineering", must satisfy additional distribution requirements. These requirements apply to 10 units of study in the areas of mathematics, basic sciences, aerospace engineering science and design.

Requirements	Minimum Units
1. Mathematical and Basic Sciences (Notes 1 and 2)	4
2. Engineering Science and Design (Includes MQP) (Notes 3, 4, 5, 6, 7, 8, 9)	6

NOTES:

1. Must include a minimum of 5/3 units of mathematics including differential calculus and differential equations.
2. Must include a minimum of 3/3 units in physics and 1/3 unit in chemistry.
3. Must include 5/3 units in Aerodynamics and Propulsion with topics in Incompressible Fluid Dynamics, Viscous Flows, Compressible Flows, Aerodynamics, Rocket and Spacecraft Propulsion
4. Must include 3/3 units in Aerospace Structures and Materials with topics in Materials Science, Stress Analysis, and Aerospace Structures
5. Must include 2/3 units in Spacecraft Dynamics and Control with topics in Orbital Mechanics, Spacecraft Dynamics and Control
6. Must include 1/3 units in Aerospace Systems Design that integrates either aeronautical or astronautical topics.
7. Must include 2/3 units Avionics and Information Systems with topics in Aerospace Avionics Systems.
8. Must include 1/3 Unit of Capstone Design Experience. This Capstone experience can be satisfied by completing an MQP which integrates course work and involves engineering design. At the time of registration for the MQP the project advisor will determine whether the MQP will meet the Capstone Design requirement or not. If not, the advisor will identify an additional 1/3 unit of course work to be taken in order to meet the ABET Capstone Design requirement.
9. Must include 2/3 units of Engineering Science and Design electives.

AEROSPACE ENGINEERING PROGRAM CHART

12/3 UNITS OF GENERAL EDUCATION ACTIVITIES

6/3 UNITS H&A SUFFICIENCY	See WPI Requirements
3/3 UNIT INTERACTIVE QUALIFYING (IQP) PROJECT	See WPI Requirements
2/3 UNIT SOCIAL SCIENCE	See WPI Requirements
1/3 UNIT PHYSICAL EDUCATION	See WPI Requirements

3/3 UNITS OF FREE ELECTIVE

3/3 UNITS FREE ELECTIVE	See Catalog
-------------------------	-------------

12/3 UNITS OF MATHEMATICS AND BASIC SCIENCE

MATHEMATICS 5/3 Units Required	BASIC SCIENCE (Note 1) 4/3 Units Required	ELECTIVES 3/3 Units Required
MA 1021 Calculus I MA 1022 Calculus II MA 1023 Calculus III MA 1024 Calculus IV MA 2051 Ordinary Different. Equations	PH 1110 General Physics- Mechanics PH 1120 General Physics- Electricity and Magnetism PH 2201 Intermediate Mechanics I PH 2202 Intermediate Mechanics II CH 1010 Chemistry I CH 1020 Chemistry II	See Catalog

16/3 UNITS OF ENGINEERING SCIENCE AND DESIGN (Notes 2 and 3)

AERODYNAMICS AND PROPULSION 5/3 Units Required	AEROSPACE STRUCTURES AND MATERIALS 3/3 Units Required	SPACECRAFT DYNAMICS AND CONTROLS 2/3 Units Required	AEROSPACE SYSTEMS DESIGN 1/3 Units Required	AVIONICS AND INFORMATION SYSTEMS 2/3 Units Required
ES 3004 Fluid Mechanics ME 3602 Intermediate Fluid Mechanics ME 3410 Compres. Flow ME 3711 Subsonic Aerodynamics ME 4716 Airbreathing Propulsion or ME 4717 Rocket and Spac. Propulsion	ES 2001 Intro to Materials ES 2502 Stress Analysis ME 4715 Aerospace Structures	ME 2713 Astronautics ME 4713 Spacecraft Dyna. and Control	ME 4770 Aircraft Design ME 4771 Spacecraft and Mission Design	ECE 2011 Intro to ECE ECE 3601 Principles of ECE ECE 3305 Aerospace Avionics Systems
MAJOR QUALIFYING PROJECT (MQP) 3/3 Units Required				

The courses above can be replaced by other equivalent courses, with the approval of the AE Program Committee

2/3 UNITS OF ENGINEERING SCIENCE AND DESIGN ELECTIVES

THERMOFLUID SYSTEMS	MECHANICAL SYSTEMS	ELECTROMECHANICAL SYSTEMS
ES 3001 Introduction to Thermodynamics ES 3003 Heat Transfer ME 4429 Thermo-fluid Application and Design ME 4712 Supersonic Aerodynamics ME 4724 High Speed Flow	ES 1310 Introduction to CAD ME 2300 Introduction to Engineering Design ES 2501 Introduction to Static Systems ES 3323 Advanced CAD ME 3501 Elementary Continuum Mechanics ME 3505 Mechanical Vibrations ME 3512 Introduction to FEM	CS 2005 Data Structures and Programming Techniques ECE 2311 Continuous -Time Signal and System Analysis ES 3011 Control Engineering I ME 3901 Engineering Experimentation

Note 1: Must take three physics and one chemistry course

Note 2: Cannot take both ECE 2011 and ECE 3601

Note 3: 1/3 of an activity must be in Capstone Design (can be satisfied with MQP, ME 4770, ME4771)

MAJOR QUALIFYING PROJECTS

The Aerospace Engineering Program provides opportunities, resources and organization for MQPs in aeronautics or astronautics. MQPs are conducted in the research laboratories of the Aerospace Engineering program, in conjunction with industry or government research centers. MQPs are often conducted in collaboration with graduate students and serve as a vehicle for integration of undergraduate studies with research in state of the art technologies. Students are encouraged and often supported to participate in the AIAA Northeast Student Conference, other professional meetings organized by AIAA as well as national design competitions.

Aeronautics

These project opportunities are for students interested in aircraft and/or aircraft systems design. Central activity in these projects is the design, construction, and testing of remotely piloted aircraft and micro aerial vehicles. Other projects may include topics in aerodynamics, controls, wake flows, and gas dynamics.

Astronautics

These project opportunities are for students interested in space science and engineering. Topics include electric propulsion, micro-propulsion, and control of space structures.

AIR FORCE AEROSPACE STUDIES

LTC EDWARD N. IRELAND, HEAD

PROFESSOR: Lt. Col. E. N. Ireland

ASSISTANT PROFESSORS: Lt. K. Bender,
Capt. A. Sorensen

INTRODUCTION

The Air Force Reserve Officer Training Corps (AFROTC) program offered at WPI is designed to provide a college student the opportunity to become an Air Force commissioned officer while completing requirements for an undergraduate or graduate degree. Enrollment is voluntary and open to young men and women who are U. S. citizens of good moral character and sound physical condition who seek the challenge of being an officer in the U. S. Air Force upon graduation from college. In addition to WPI students, students at any of the **Worcester Consortium for Higher Education** institutions are also eligible to apply for Air Force ROTC at WPI.

MISSION AND EDUCATIONAL OBJECTIVES

Mission: The mission of AFROTC is to produce leaders for the Air Force and build better citizens for America. Its vision is to be "a highly successful organization, respected throughout the Air Force, the educational community and the nation".

Educational Objectives:

Students who successfully complete the AFROTC program will have:

1. An understanding of the fundamental concepts and principles of Air and Space.
2. A basic understanding of associated professional knowledge.

3. A strong sense of personal integrity, honor, and individual responsibility.
4. An appreciation of the requirements for national security.

AIR FORCE ROTC PROGRAMS

There are two traditional routes to an Air Force commission through Air Force ROTC. Entering students may enroll in the Air Force Four-Year Program. Students with at least two academic years remaining in college may apply for the Two-Year Program. However, there are opportunities for Freshmen, Sophomores, Juniors, and in some cases Seniors and Graduate Students. Please check with the AFROTC Detachment Staff for these special circumstances.

FOUR-YEAR PROGRAM

The more popular and preferred program is the traditional Four-Year Program. To enroll, simply register for Air Force Aerospace Studies in the fall term of the freshman year in the same manner as other college courses. There is NO MILITARY OBLIGATION for the first two years of Air Force ROTC unless you have an Air Force ROTC scholarship.

The first two years are known as the General Military Course (GMC). Classes meet one hour per week and are required for freshmen and sophomores.

Individuals who successfully complete the GMC compete nationwide for entry into the Professional Officers Course (POC). POC classes meet three hours per week and are required for all juniors and seniors. Officer Candidates enrolled in the POC and on scholarship receive a nontaxable subsistence allowance of up to \$400 each month.

Qualified Officer candidates will attend the Air Force ROTC field-training program for four weeks between their sophomore and junior years.

TWO-YEAR PROGRAM

The Two-Year Program is available for college students with two years of undergraduate or graduate study remaining. Applicants must apply for the program no later than the beginning of Term C (spring semester) preceding those two final years. The applicant will take the Air Force Officer Qualifying Test, will be given a physical examination at no expense, and will meet a selection board.

Applicants for the Two-Year Program will attend the Air Force ROTC field training for six weeks instead of four at an Air Force base prior to their entry into the Professional Officer Course (POC). Like their four year counterparts, they are paid while at field training and will receive travel pay to and from the Air Force base hosting field training. Students accepted into the Two-Year Program will complete the Professional Officer Course as described above.

SCHOLARSHIP OPPORTUNITIES

By participating in Air Force ROTC, students may compete for Air Force scholarships ranging from two years to three years in duration. Full scholarships cover tuition, most fees, and a textbook allowance. Partial scholarships are also available which contribute up to 80% of fees and tuition, in addition to a textbook allowance. A tax-free

subsistence allowance of \$250 to \$400 is paid to all scholarship students each academic month.

Entering freshmen may compete for an Air Force ROTC Four-Year Scholarship during their senior year in high school (deadline Dec. 1 of their high school senior year). Details of this program can be obtained by e-mailing afrotc@wpi.edu, by writing: Department of Aerospace Studies, WPI, 100 Institute Rd., Worcester MA 01609-2280, or through most high school counseling offices, or visiting www.afrotc.com.

OTHER ASPECTS OF THE AFROTC PROGRAM

Leadership Laboratory:

Air Force ROTC officer candidates participate in a Leadership Laboratory (LLAB) where the leadership skills and management theories acquired in the classroom are put into practice. The LLAB meets once each week for approximately two hours.

This formal military training is largely planned and directed by the officer candidates. The freshmen and sophomores are involved in such initial leadership experiences as problem solving, dynamic leadership, team building, Air Force customs and courtesies, drill movements, Air Force educational benefits, Air Force career opportunities, and preparation for field training. The juniors and seniors are involved in more advanced leadership experiences as they become more responsible for the planning and organizing of wing activities, to include conducting the Leadership Laboratory itself.

Field Training:

Field Training is, in most cases, an officer candidate's first exposure to a working Air Force environment. The summer program is designed to develop military leadership, discipline, and to provide Air Force officer orientation and motivation. At the same time, the Air Force can evaluate each student's potential as an officer. Field training includes aircraft and aircrew orientation, Air Force professional development orientation, marksmanship training, officer training, physical fitness, and survival training. Uniforms, lodging, and meals are provided at no cost to the cadet, and travel at Air Force expense is authorized by air or privately owned vehicle to and from the individual's home of record or school. Additionally, after applicable deductions, cadets receive pay of about \$500 for the four-week encampment and about \$750 for the six-week summer camp.

Base Visits:

Air Force ROTC officer candidates have the opportunity to visit Air Force bases for firsthand observation of the operating Air Force. These trips are frequently made on weekends or scheduled to coincide with school vacation periods. Officer candidates may be flown by military aircraft to an Air Force base where they spend the day, remain on base overnight, and return to campus the following day.

Other Benefits:

The Air Force provides all Air Force ROTC uniforms and textbooks for on-campus programs and field training. All officer candidates who have received an Air Force scholarship or are enrolled in the Professional Officer Course (POC) may travel free on military aircraft on a space-available basis.

Additional Information:

In addition to formal activities, the Cadet Wing plans and organizes a full schedule of social events throughout the academic year. These include a Dining-In, Military Ball, a Field Day, and intramural sports activities. Professional Development Training Programs, such as Parachute Freefall and Glider Instruction, are also available to selected volunteer officer candidates during the summer.

Arnold Air Society:

Each officer candidate can elect to be part of a national society dedicated to conducting service related events for the Air Force and local community. These Arnold Air Society members are involved in a myriad of service projects to include charity work, service to the poor, work with local orphanages, and similar activities. Twice a year, members participate in conventions/conclaves held in various cities and attended by members from all the schools in the country sponsoring AFROTC. Membership is by nomination after completion of a one semester, project-oriented pledge program.

Civil Air Patrol:

All Air Force ROTC officer candidates at AFROTC Detachment 340 have the opportunity to become members of the Civil Air Patrol and to receive up to 8 flight orientation rides on Civil Air Patrol aircraft at Worcester Airport.

BIOLOGY AND BIOTECHNOLOGY

E. W. OVERSTRÖM, HEAD

PROFESSORS: D. S. Adams, J. C. Bagshaw, R. D. Cheetham, E. W. Overström, P. J. Weathers

ASSOCIATE PROFESSORS: T. C. Crusberg, S. M. Politz, J. Rulfs, E. Ryder

ASSISTANT PROFESSORS: D. G. Gibson III, L. Mathews, R. Prusty

AFFILIATE PROFESSORS: A. Di Iorio

ADJUNCT ASSISTANT PROFESSOR/SENIOR LAB

INSTRUCTOR: J. Whitefleet-Smith

ADJUNCT ASSISTANT PROFESSOR/LAB

INSTRUCTOR: M. Buckholt

INTRODUCTION

Undergraduates majoring in Biology and Biotechnology have the opportunity to gain extensive knowledge of the scientific basis of biological investigation ranging from biological macromolecules, through genes and cells, to organisms and their interactions with the environment. Students also choose experiences in hands-on laboratory and field techniques in aspects of modern biology, including cell and molecular biology, bioprocess, recombinant DNA methods, microbiology, physiology, and environmental biology. Opportunities also exist to pursue practical exposure to methods of computational biology, including bioinformatics and simulation modeling. Students who major in biology and biotechnology will be uniquely qualified for positions in academic, industrial or governmental research facilities, or for further studies in graduate or professional (medical, dental, veterinary) schools.

MISSION STATEMENT

The Department of Biology and Biotechnology will make scholarly scientific and technological advances that will address the changing needs of society. We will prepare well educated scientists able to approach problems with creativity and flexibility. A key element in this preparation is active participation in the process of scientific inquiry.

EDUCATIONAL OBJECTIVES

The educational objectives of the Department of Biology and Biotechnology are to prepare students to function as scientists and educators in a broad array of biological disciplines. We recognize that the well educated scientist needs facility in technology and skill in critical thinking to function effectively in the professional arena as well as in the global community.

EDUCATIONAL OUTCOMES

Students graduating with a Bachelor of Science degree from the Department of Biology and Biotechnology:

- have mastered a broad range of basic lab skills applicable to biology and biotechnology.
- have mastered applied research skills at an advanced level in at least one area of biology and biotechnology.
- know and understand a broad range of basic biological concepts, and can apply and analyze these in at least one speciality area.
- are able to generate hypotheses, design approaches to test them, and interpret the data from those tests to reach valid conclusions.
- have developed the ability to place their own work in a broader scientific context.
- have developed oral and written communication skills relevant to professional positions in biology and biotechnology.
- can find, read and critically evaluate the original scientific literature.
- possess skills necessary for life-long professional learning.
- can function effectively as members of a team.
- demonstrate adherence to accepted standards of professional and ethical behavior.

BIOLOGY AND BIOTECHNOLOGY

Biology, simply stated, is the study of living organisms. Biotechnology is broadly defined as the use of organisms and their components for the manufacture or modification of products, the alteration of animals and plants, and the adaptation of microorganisms to specific tasks. Biotechnology is as old as winemaking, farming, and animal husbandry and as new as methods of DNA recombination. In the modern context, biotechnology is further defined as the use of technological research tools in deciphering questions about living organisms, and the application of engineering principles and methods to these questions.

Students may choose to pursue a generalist degree in biology and biotechnology, or to structure their academic programs within any of five concentrations: bioprocess, cell and molecular biology and genetics, computational

biology, ecology and environmental biology, or organismal biology. These concentrations provide not only guidelines for course choices within the department, but also include educational opportunities that cross academic disciplines.

UNDERGRADUATE RESEARCH PROJECTS

The biology and biotechnology facilities offer an exceptional learning opportunity since research in an active laboratory group is the principal teaching tool. Tools for modern biochemistry, molecular biology, tissue culture, fermentation, ecology, microscopy and computer integration are all available to undergraduates.

In conjunction with the faculty, students who wish to expand their educational opportunities pursue many off-campus projects each year. Investigations may take place at institutions that have traditionally worked with WPI, such as the University of Massachusetts Medical School, the Worcester Biotechnology Research Park, Tufts University School of Veterinary Medicine, and the Woods Hole Marine Biological Laboratories. The department also has established links with several companies that provide opportunities for project work and summer employment in applied biology and biotechnology.

Undergraduate research projects may be proposed by individual students or groups of students, or may be selected from on-going research activities of the faculty. The departmental faculty must be consulted for approval of a project before student work begins.

BASIC CURRICULUM

Programs within the department provide a broad base of scientific information and experience with in-depth laboratory study in personally selected areas of biology and biotechnology. With your faculty advisor, you will plan your own unique program, which will include a variety of course work and research experiences.

A modern biologist also needs exposure to other sciences and mathematics in order to process experimental data, solve problems, and understand the chemical and physical rules under which biological systems operate. Students may select general chemistry, organic chemistry, biochemistry, physics, calculus or statistics to round out their scientific education.

GUIDELINES FOR SELECTION OF BB COURSES

Introductory survey courses are numbered at the 1000-level. Courses at the 2000-level introduce basic concepts in a defined area. Advanced subjects taught mostly from texts are at the 3000-level, and courses at the 4000-level are taught using mostly the original scientific literature.

Program Distribution Requirements for the Biology and Biotechnology Major

Requirements	Minimum Units
1. Mathematical Science, Physics, Computer Science, Engineering (Note 1)	5/3
2. Chemistry	5/3
3. BB 1000/2000-level (Note 2)	4/3
4. BB Laboratory Experience (Note 3)	4/3
5. BB 3000/4000-level (Note 4)	5/3
6. Related Courses (Note 5)	4/3
7. MQP	1

NOTES:

- BB 3040 may count toward this requirement.
- Only one BB course at the 1000 level may be counted toward this requirement. Neither BB 1001 nor BB 1002 may count in this category.
- Chosen from among BB 2000/3000 Laboratories or from the Other Laboratory Experience List. Must include at least 1/2 unit of course work at the 2000 level.
- In certain cases, 500-level courses are appropriate for undergraduate credit with explicit permission of the instructor.
- Chosen from among the Related Courses Lists for all BB Concentrations.

Program Distribution Requirements for the Biology and Biotechnology Concentrations Major

Requirements	Minimum Units
1. Mathematical Science, Physics, Computer Science, Engineering (Note 2)	5/3
2. Chemistry	5/3
3. BB 1000/2000-level (Note 3)	4/3
4. BB Laboratory Experience (Note 4)	4/3
5. BB 3000/4000-level (Note 5)	5/3
6. Related Courses (Note 6)	4/3
7. MQP (Note 7)	1

NOTES:

- Students pursuing a Concentration must fulfill all requirements for that Concentration. No course may count in more than one category, including university and departmental distribution requirements.
- BB 3040 may count toward this requirement.
- Only one BB course at the 1000 level may be counted toward this requirement. Neither BB 1001 nor BB 1002 may count in this category.
- Chosen from among BB 2000/3000 Laboratories or from the Other Laboratory Experience List. Appropriate courses are suggested for each Concentration. Must include at least 1/2 unit of course work at the 2000 level.
- 2/3 or more units must come from the appropriate approved Concentration List. In certain cases 500-level courses are appropriate for undergraduate credit with explicit permission of the instructor.
- Chosen from among courses specified within each concentration's Related Courses List.
- Must be approved by the MQP advisor of record as appropriate for the Concentration.

OTHER LABORATORY EXPERIENCE LIST

BME 562 Small Animal Surgery
 CE 4060 Environmental Engineering Laboratory
 CE 4061 Hydrology
 CH 4150 Experimental Biochemistry
 GE 2341 Geology

APPROVED COURSES FOR THE CONCENTRATION IN BIOPROCESS

BB LABORATORY EXPERIENCE

The 4/3 Units Laboratory Experience requirement may be fulfilled by any BB 2000/3000 laboratory or by courses from the Other Laboratory Experience List. At least 1/2 unit of course work must be at the 2000 level. The most relevant upper level laboratory courses for a Concentration in Bioprocess are suggested below.

BB 3513 Cell Culture Techniques for Animal Cells
 BB 3516 Separation Techniques in Biotechnology
 BB 3517 Fermentation
 BB 3519 Protein Purification
 CH 4150 Experimental Biochemistry

BB 3000/4000-LEVEL

Students concentrating in Bioprocess MUST choose 5/3 Units of course work in Biology and Biotechnology at the 3000 or 4000 level. At least 2/3 Units MUST come from the Approved Courses below.

BB 3055 Microbial Physiology
 BB 4008 Cell Culture Theory and Applications
 BB 4070 Separation of Biological Molecules (not available for credit in addition to BB560)
 BB 505 Fermentation Biology
 BB 509 Scale-up of Bioprocessing
 BB 560 Separation of Biological Molecules (not available for credit in addition to BB4070)

RELATED COURSES

Students concentrating in Bioprocess must choose AT LEAST 1/3 Unit in Chemistry from the list below, but MAY NOT COUNT more than 2/3 Units in Chemistry toward this Concentration requirement. Remaining Units must be selected from "Other Courses" as listed below:

Chemistry

CH 3510 Chemical Thermodynamics
 CH 4110 Biochemistry I
 CH 4120 Biochemistry II

Other Courses

CHE 2011 Chemical Engineering Fundamentals
 CHE 2013 Applied Chemical Engineering Fundamentals
 CHE 3301 Introduction to Biological Engineering
 CS 1101 Introduction to Program Design
 CS 2005 Data Structures and Programming Techniques
 CS 2301 System Programming for Non-Majors
 ES 3002 Mass Transfer

APPROVED COURSES FOR THE CONCENTRATION IN CELL AND MOLECULAR BIOLOGY AND GENETICS

BB LABORATORY EXPERIENCE

The 4/3 Units Laboratory Experience requirement may be fulfilled by any BB 2000/3000 laboratory or by courses from the Other Laboratory Experience List. At least 1/2 unit of course work must be at the 2000 level. The most relevant upper level laboratory courses for a Concentration in Cell and Molecular Biology and Genetics are suggested below.

BB 3512 Molecular Genetics Lab
 BB 3513 Cell Culture Techniques for Animal Cells
 BB 3516 Separation Techniques in Biotechnology
 BB 3518 Molecular Biology Lab
 BB 3519 Protein Purification
 BB 3520 Recombinant DNA Technology
 BB 3524 Bioinformatics Lab
 CH 4150 Experimental Biochemistry

BB 3000/4000-LEVEL

Students concentrating in Cell and Molecular Biology and Genetics must choose 5/3 Units of course work in Biology and Biotechnology at the 3000 or 4000 level. At least 2/3 Units MUST come from the Approved Courses below.

BB 3055 Microbial Physiology
 BB 3080 Neurobiology
 BB 3620 Developmental Biology
 BB 3920 Immunology
 BB 4008 Cell Culture Theory and Applications
 BB 4010 Advanced Molecular Genetics
 BB 4065 Virology
 BB 4160 Population Genetics and Phylogeography
 BB 4170 Molecular Ecology
 BB 4550 Advanced Cell Biology
 BB 4910 Advanced Molecular Biology
 BB 4955 Recombinant DNA

RELATED COURSES

Students concentrating in Cell and Molecular Biology and Genetics must choose at least 2/3 Units in Chemistry from the list below. Remaining Units may be selected either from Chemistry options below, or from "Other Courses" as listed below.

Chemistry

CH 2330 Organic III
 CH 4110 Biochemistry I
 CH 4120 Biochemistry II
 CH 4150 Experimental Biochemistry
 CH 4160 Membrane Biophysics
 CH 4910 Regulation of Gene Expression

Other Courses

BB 3055 Microbial Physiology
 BB 3080 Neurobiology
 BB 3620 Developmental Biology
 BB 3920 Immunology
 BB 4008 Cell Culture Theory and Applications
 BB 4010 Advanced Molecular Genetics
 BB 4065 Virology
 BB 4160 Population Genetics and Phylogeography
 BB 4170 Molecular Ecology
 BB 4550 Advanced Cell Biology
 BB 4910 Advanced Molecular Biology
 BB 4955 Recombinant DNA

APPROVED COURSES FOR THE CONCENTRATION IN COMPUTATIONAL BIOLOGY

BB LABORATORY EXPERIENCE

The 4/3 Units Laboratory Experience requirement may be fulfilled by any BB 2000/3000 laboratory or by courses from the Other Laboratory Experience List. At least 1/2 unit of course work must be at the 2000 level. The most relevant upper level laboratory courses for a Concentration in Computational Biology are suggested below.

BB 3512 Molecular Genetics Lab
 BB 3518 Molecular Biology Lab
 BB 3520 Recombinant DNA Technology
 BB 3524 Bioinformatics Lab
 CH 4150 Experimental Biochemistry

BB 3000/4000-LEVEL

Students concentrating in Computational Biology must choose 5/3 Units of course work in Biology and Biotechnology at the 3000 or 4000 level. At least 2/3 Units MUST come from the Approved Courses below:

BB 3040 Experimental Design and Data Analysis
 BB 4010 Advanced Molecular Genetics
 BB 4065 Virology
 BB 4160 Population Genetics and Phylogeography
 BB 4550 Advanced Cell Biology
 BB 4910 Advanced Molecular Biology

The University of Massachusetts Medical School offers a graduate course which can be used to fulfill 1/3 Unit of this requirement:

MS 700 Bioinformatics

RELATED COURSES

Students concentrating in Computational Biology must choose at least 4/3 Units from the list of related courses below. At least 2/3 Unit must be CS or MA courses.

CH 4110 Biochemistry I
 CH 4120 Biochemistry II
 CH 4910 Regulation of Gene Expression
 CS 2022/
 MA 2201 Discrete Mathematics
 CS 2102 Object-Oriented Design Concepts
 CS 2223 Algorithms
 CS 2303 Systems Programming Concepts
 CS 3041 Human-Computer Interaction
 CS 3431 Database Systems I
 CS 4032 Numerical Methods for Linear and Nonlinear Systems
 CS 4120 Analysis of Algorithms
 CS 4341 Introduction to Artificial Intelligence
 CS 4445 Data Mining and Knowledge Discovery in Databases
 MA 2051 Ordinary Differential Equations
 MA 2201/
 CS2022 Discrete Mathematics
 MA 2271 Graph Theory
 MA 2273 Combinatorics
 MA 2431 Mathematical Modeling with Ordinary Differential Equations
 MA 2621 Probability for Applications
 MA 2631 Probability
 MA 3231 Linear Programming
 MA 3233 Discrete Optimization

APPROVED COURSES FOR THE CONCENTRATION IN ECOLOGY AND ENVIRONMENTAL BIOLOGY

BB LABORATORY EXPERIENCE

The 4/3 Units Laboratory Experience requirement may be fulfilled by any BB 2000/3000 laboratory or by courses from the Other Laboratory Experience List. At least 1/2 unit of course work must be at the 2000 level. The most relevant upper level laboratory courses for a Concentration in Ecology and Environmental Biology are suggested below.

BB 3511 Nerve and Muscle Physiology
 BB 3514 Circulatory and Respiratory Physiology
 BB 3525 Plant Physiology
 BME 562 Small Animal Surgery
 CE 4060 Environmental Engineering Laboratory
 CE 4061 Hydrology
 GE 2341 Geology

BB 3000/4000-LEVEL

Students concentrating in Ecology and Environmental Biology must choose 5/3 Units of course work in Biology and Biotechnology at the 3000 or 4000 level. At least 2/3 Units MUST come from the Approved Courses below.

- BB 3055 Microbial Physiology
- BB 3101 Hum. Anat. & Phys.: Movement and Communication
- BB 3102 Hum. Anat. & Phys.: Transport and Maintenance
- BB 3120 Plant Physiology and Cell Culture
- BB 3140 Evolution: Pattern and Process
- BB 3160 Behavioral Ecology
- BB 4160 Population Genetics and Phylogeography
- BB 4170 Molecular Ecology

RELATED COURSES

Students concentrating in Ecology and Environmental Biology must choose 3/3 Units in Science and Engineering and 1/3 Unit in Humanities and Social Sciences from the list below.

Science and Engineering:

- BB 3055 Microbial Physiology
- BB 3101 Hum. Anat. & Phys.: Movement and Communication
- BB 3102 Hum. Anat. & Phys.: Transport and Maintenance
- BB 3120 Plant Physiology and Cell Culture
- BB 3140 Evolution: Pattern and Process
- BB 3160 Behavioral Ecology
- CE 3059 Environmental Engineering
- CE 3061 Waste Water Treatment
- CE 3070 Urban and Environmental Planning
- CE 3074 Environmental Analysis
- CE 4071 Land Use Development and Controls

Humanities and Social Sciences:

- EN 3231 New England Supernaturalism
- PY 2717 Philosophy and the Environment
- ECON 2117 Environmental Economics
- GOV 2311 Environmental Policy and Law
- GOV 2312 International Environmental Policy
- PSY 2405 The Psychological Study of Environmental Issues

APPROVED COURSES FOR THE CONCENTRATION IN ORGANISMAL BIOLOGY**BB LABORATORY EXPERIENCE**

The 4/3 Units Laboratory Experience requirement may be fulfilled by any BB 2000/3000 laboratory or by courses from the Other Laboratory Experience List. At least 1/2 unit of course work must be at the 2000 level. The most relevant upper level laboratory courses for a Concentration in Organismal Biology are suggested below.

- BB 3511 Nerve and Muscle Physiology
- BB 3513 Cell Culture Techniques for Animal Cells
- BB 3514 Circulatory and Respiratory Physiology
- BB 3517 Fermentation
- BB 3525 Plant Physiology
- BME 562 Small Animal Surgery
- CH 4150 Experimental Biochemistry

BB 3000/4000-LEVEL

Students concentrating in Organismal Biology must choose 5/3 Units of course work in Biology and Biotechnology at the 3000 or 4000 level. At least 2/3 Units MUST come from the Approved Courses below:

- BB 3080 Neurobiology
- BB 3101 Hum. Anat. & Phys.: Movement and Communication
- BB 3102 Hum. Anat. & Phys.: Transport and Maintenance
- BB 3120 Plant Physiology and Cell Culture
- BB 3140 Evolution: Pattern and Process
- BB 3170 Plant Morphology and Development
- BB 3620 Developmental Biology

RELATED COURSES

Students concentrating in Organismal Biology must choose at least 2/3 Units in Biology and Biotechnology from the list below. Remaining Units may be selected from additional Biology and Biotechnology below, or from "Other Courses" as listed below:

Biology and Biotechnology:

- BB 3055 Microbial Physiology
- BB 3080 Neurobiology
- BB 3101 Hum. Anat. & Phys.: Movement and Communication
- BB 3102 Hum. Anat. & Phys.: Transport and Maintenance
- BB 3120 Plant Physiology and Cell Culture
- BB 3140 Evolution
- BB 3160 Behavioral Ecology
- BB 3170 Plant Morphology and Development
- BB 3620 Developmental Biology
- BB 3920 Immunology
- BB 4008 Cell Culture Theory and Applications
- BB 4065 Virology

Other Courses:

- BME 562 Small Animal Surgery
- BME 4541 Biological Systems
- CH 4110 Biochemistry I
- CH 4120 Biochemistry II
- PSY 1401 Cognitive Psychology

BIOMEDICAL ENGINEERING

C. H. SOTAK, HEAD**Primary BME Faculty**

PROFESSORS: R. A. Peura, C. H. Sotak
 ASSOCIATE PROFESSOR: Y. Mendelson
 ASSISTANT PROFESSORS: K. L. Billiar, G. D. Pins
 RESEARCH ASSISTANT PROFESSOR: K. G. Helmer

Collaborative BME Faculty

PROFESSORS: D. Cyganski, W. W. Durgin,
 A. H. Hoffman, F. J. Looft, R. Ludwig, J. A. Orr,
 P. C. Pedersen, B. J. Savilonis, J. M. Sullivan, D. Tang
 ASSOCIATE PROFESSORS: H. Ault, E. A. Clancy,
 S. Shivkumar
 ASSISTANT PROFESSORS: T. A. Camesano

MISSION STATEMENT

The Biomedical Engineering Department prepares students for rewarding careers in the health care industry or professional programs in biomedical research or medicine.

EDUCATIONAL OBJECTIVES

The educational objectives of the Biomedical Engineering Department are to prepare professionals who possess fundamental knowledge of engineering and basic science and can apply these principles to solve problems in biology and medicine. Through a project-oriented curriculum, which closely embraces the WPI educational philosophy, we prepare students to engage in a lifetime of professionalism and learning.

EDUCATIONAL OUTCOMES

The Biomedical Engineering Department has established 13 educational outcomes in support of our department objectives. The general and specific program criteria indicated above in parentheses meet the requirements for Biomedical Engineering accreditation by ABET (the Accreditation Board for Engineering and Technology). Accordingly, students graduating from the Biomedical Engineering Department will demonstrate:

1. An ability to apply knowledge of advanced mathematics (including differential equations and statistics), science, and engineering to solve the problems at the interface of engineering and biology (**general criterion 3a and program criteria**).
2. An ability to design and conduct experiments, as well as to analyze and interpret data from living and non-living systems (**general criterion 3b and program criteria**).
3. An ability to design a system, component, or process to meet desired needs (**general criterion 3c**).
4. An ability to function on multi-disciplinary teams (**general criterion 3d**).
5. An ability to identify, formulate, and solve engineering problems (**general criterion 3e**).
6. An understanding of professional and ethical responsibilities (**general criterion 3f**).
7. An ability to communicate effectively (**general criterion 3g**).
8. The broad education necessary to understand the impact of engineering solutions in a global and societal context (**general criterion 3h**).
9. A recognition of the need for, and an ability to engage in life-long learning (**general criterion 3i**).
10. A knowledge of contemporary issues (**general criterion 3j**).
11. An ability to use the techniques, skills, and modern engineering tools necessary for engineering practice (**general criterion 3k**).
12. An understanding of biology and physiology (**program criteria**).
13. An ability to address the problems associated with the interaction between living and non-living materials and systems (**program criteria**).

Biomedical engineering is the application of engineering principles to the solution of problems in biology and medicine for the enhancement of health care. Students choose this field in order:

- to be of service to people;
- to work with living systems; and
- to apply advanced technology to solve complex problems of medicine.

Biomedical engineers may be called upon to design instruments and devices, to integrate knowledge from many sources in order to develop new procedures, or to pursue research in order to acquire knowledge needed to solve problems. The major culminates in a Major Qualifying Project, which requires that each student apply his or her engineering background to a suitable biomedical problem, generally in association with the University of

Massachusetts Medical School, Tufts University School of Veterinary Medicine, one of the local hospitals, or a medical device company.

Each student's program will be developed individually with an advisor to follow the Biomedical Engineering program chart. WPI requirements applicable to all students must also be met. See page 21.

Biomedical engineering is characterized by the following types of activity in the field:

1. Uncovering new knowledge in areas of biological science and medical practice by applying engineering methods;
2. Studying and solving medical and biological problems through analytical techniques in engineering;
3. Designing and developing patient-related instrumentation, biosensors, prostheses, biocompatible materials, and diagnostic and therapeutic devices; and bioengineered tissues and organs;
4. Analyzing, designing, and implementing improved health-care delivery systems and apparatus in order to improve patient care and reduce health-care costs in contexts ranging from individual doctors' offices to advanced clinical diagnostic and therapeutic centers.

The modeling of biological systems is an example of applying engineering analytical techniques to better understand the dynamic function of biological systems. The body has a complex feedback control system with multiple subsystems that interact with each other. The application of modeling, computer simulation, and control theory provides insights into the function of these bodily processes.

Recently, there has been increased emphasis on the application of the biomedical engineering principles embodied in the third and fourth areas listed above. Examples of the third area include:

- designing and developing tissues and organs;
- development of implantable biomaterials;
- design of an implantable power source;
- design of transducers to monitor the heart's performance;
- development of electronic circuitry to control the system;
- bench and field testing of devices in animals;
- application of new technology to patients.

The fourth area involves closer contact with the patient and health-care delivery system. This area is commonly referred to as Clinical Engineering. The engineer in the clinical environment normally has responsibility for the medical instrumentation and equipment including:

- writing procurement specifications in consultation with medical and hospital staff;
- inspecting equipment for safe operation and conformance with specifications;
- training medical personnel in proper use of equipment;
- testing within hospital for electrical safety; and
- adaptation of instrumentation to specific applications.

Biomedical engineering projects are available in WPI's Salisbury and Higgins Laboratories as well as at the affiliated institutions previously listed.

COMBINED BS/MASTER'S DEGREE PROGRAM

The goal of the Combined BS/Master's Degree Program, hereafter called the Combined Program, is to give qualified WPI undergraduate students an opportunity to obtain a cost-effective and time-efficient advanced degree in BME, while at the same time enhancing the quality of the graduate program by attracting WPI's most talented undergraduates. It affords an opportunity for outstanding WPI undergraduate students to earn both a Bachelor's degree and a Master's degree in BME from WPI concurrently and in less time than would typically be required to earn each degree separately. The principal advantage of this program is that it allows for certain courses to be counted towards both degree requirements, thereby reducing total class time. With careful planning and motivation, this program typically allows a student to complete the requirements for both degrees with only one additional year of study (5 years total). However, because a student must still satisfy all graduate degree requirements, the actual time spent in the program may be longer than 5 years. There are two degree options for students: a thesis-based Master of Science (BS/MS) option and a non-thesis Master of Engineering (BS/ME) option.

ADMISSION REQUIREMENTS

To take advantage of the Combined Program, a student must:

- Be a currently registered WPI undergraduate.
- Successfully participate in and complete a two-step application process, consisting of a course approval process followed by a separate, full application for admission into one of the BME Master's Programs. Completion of the course approval process does not imply or guarantee admittance to the Combined Program.
- Have an equivalent grade point average (GPA) of 3.2 (out of 4.0) in all coursework and a minimum GPA of 3.5 (out of 4.0) in all departmental coursework (typically all BME courses) at the time of the full application. Because the Combined Program is an accelerated program, only students demonstrating very strong academic skills and potential will be admitted.
- Maintain continuous full-time registration. It is a full-time program of study.

APPLICATION PROCEDURE

Application to the Combined Program is a two-step process: submission of a signed *Course Designation Form* listing the courses that will count toward both degree requirements and a Full Application to one of the BME Master's Programs.

Course Approval Process: On the *Course Designation Form* (available from the Graduate Studies and Enrollment Office website), the student lists the courses that he/she plans to count towards both degrees. A maximum of four courses (12 credits) are allowed, with a maximum of three courses (9 credits) at the 4000-level (the 4th course must be a graduate course). These courses must meet the degree requirements for both the Bachelor's and Masters degree and courses designated for graduate students only

cannot be listed. This form must bear the signature of each course instructor and be submitted to the Chairman of the BME Graduate Studies Committee for signature no later than the last day of registration for any undergraduate or graduate course to be used for graduate credit. This form will then be forwarded to the Graduate Studies and Enrollment Office for distribution to course instructors and administrators. A grade of B or better is required for any course to be counted towards both degrees and additional work may be required for undergraduate courses taken for graduate credit. For students in the Combined Program, approved undergraduate courses are assigned graduate credit with a conversion rate of 1/3 WPI undergraduate unit = 3 credit hours, while graduate courses applied toward the undergraduate degree are awarded undergraduate credit with a conversion rate of 1 credit hour = 1/9 undergraduate unit.

The *Course Designation Form* serves two purposes. First, it assures the student that if he/she is admitted into the Combined Program, the courses listed will count towards both degrees. Second, the instructor in each course listed will be formally notified that the course was approved for the Combined Program. The instructor then has a right (but not an obligation) to require additional work of the student. It is important to understand that the approval of this *Course Designation Form* does not guarantee admission to the graduate program, nor does it obligate the student to complete the full application process or enter the program. Students who fail to submit a *Course Designation Form* to the Chairman of the BME Graduate Studies Committee on time will not be eligible for the Combined Program, but may still apply for one of the regular graduate programs in BME.

Formal Application: The Full Application for the Combined Program follows the same process required of all undergraduate students interested in the BME graduate programs at WPI, with the following modifications:

- Graduate Record Examination (GRE) scores are not required. However, because acceptance into the Combined Program is competitive and not guaranteed, an interested student should still consider taking the GRE and applying to other graduate programs where the GRE may be required. If desired, GRE scores may be submitted to strengthen an application to the Combined Program.
- The application and transcript fees are waived.
- The application should not be submitted before the student has completed, or is actively involved in, their MQP project. A Full Application submitted earlier than this will not be considered.

The Full Application will be evaluated by the BME Departmental Admissions Committee in exactly the same manner as any application from an undergraduate at another university. A student should not assume that he/she will be admitted to the Combined Program based on approval of the Preliminary Application or submission of the Full Application and should consider and plan for other career options. A student admitted into the Combined Program is considered a graduate student only after the successful completion of the Bachelor's degree.

FINANCIAL AID

Fellowships, research assistantships (RAs), and teaching assistantships (TAs) are available to outstanding graduate students in the Combined Program. Fellowships are awarded by WPI, national organizations, and corporate sponsors. RAs are awarded to graduate students by individual faculty members. A student requiring financial aid is urged to discuss the possibility of obtaining a fellowship or RA first with their MQP advisor(s), and then with any faculty member with whom they might be interested in working. Teaching assistantships (TAs) are awarded on a competitive basis to support undergraduate teaching in the BME Department. Decisions regarding departmental TAs are made during the spring semester for the following academic year. However, because a TA is required to commit 20 hours per week during the academic year to teaching support, a student with TA support will find it more difficult to finish the Combined Program in 5 years. Students should consider this possibility before accepting a teaching assistantship.

ADDITIONAL INFORMATION

Because students in the Combined Program must independently meet the degree requirements for both the Bachelor's and Master's degree, a Combined Program student should consult the appropriate chapter of the WPI Graduate Catalog (either MS or ME Degree Program) for more detailed information on the specific BME Graduate Degree Program being sought.

SUMMARY

A student interested in the Combined Program should complete the following steps:

1. Early in the junior year, complete and submit a *Course Designation Form* on which the courses to count towards both degrees are listed. This form must bear the necessary signatures. Students who fail to complete this step will not be eligible for the Combined Program, but may apply for the regular graduate programs in BME.
2. For the BS/MS Combined Program option, choose an MQP that can be extended into an MS thesis. Discuss this possibility with your prospective MQP advisor before you sign up. The earlier you start looking, the better your chances of finding the right MQP. Success in the BS/MS program hinges on the ability of the student to extend their MQP project into a quality master's thesis. There is little likelihood that the Combined Program can be completed in 5 years without the MQP as a preliminary effort.
3. Take the GRE general test. While not a requirement for the Combined Program, it may be necessary for other graduate programs.
4. In the fall of your final (senior) year, submit a Full Application for admission to a BME master's program. Remember that you must meet the minimum GPA requirement (3.2 in all coursework and 3.5 in departmental coursework).
5. Work hard on your MQP. A strong performance will increase the likelihood that you will be able to complete the BS/MS program in 5 years.

As with all decisions regarding your educational objectives and career, you should discuss the appropriateness of the Combined Program with your academic advisor and knowledgeable colleagues. While there are many advantages to the Combined Program, there are situations where it may not be appropriate. For example, a student who plans to pursue a PhD degree at another institution and has a strong academic record (GPA well above 3.2, GRE scores in the 70th percentile or better) may be better served by skipping the master's degree at WPI.

Program Distribution Requirements for the Biomedical Engineering Major

The normal period of residency at WPI is 16 terms. In addition to the WPI requirements applicable to all students (see page 21), a biomedical engineer needs a solid background in mathematics, physical and life sciences. The distribution requirements are satisfied as follows:

BIOMEDICAL ENGINEERING	Minimum Units
1. Mathematics (See Note 1)	2
2. Basic Science (See Note 2)	2
3. Supplemental Science (See Note 3)	2/3
4. Laboratory experience with living systems (See Note 4)	1/3
5. Biomedical Engineering and Engineering (See Note 5)	4 1/3
6. MQP (See Note 6)	1

NOTES:

1. Mathematics must include differential and integral calculus, differential equations and statistics.
2. Two courses from each of the following areas: BB, CH and PH.
3. Two courses from BB, CH or PH.
4. Experimental Physiology (e.g., BB 3511 and BB 3514) or equivalent.
5. Thirteen courses from Biomedical Engineering (BME) or Engineering (CE, CHE, ECE, ES, or ME) as specified in the WPI Catalog "Courses Qualifying for Engineering Department Areas" with the following distribution: (1) seven courses from Biomedical Engineering or Engineering, one of which must be an engineering design course; (2) four courses from Biomedical Engineering or Engineering at the 3000-level or above; (3) two courses in Biomedical Engineering at the 4000-level or above. A minimum of eight of the thirteen courses must be from Biomedical Engineering, not including BME 3110.
6. Must include 1/3 unit Capstone Design Experience.

OVERVIEW OF BME PROGRAM COMPONENTS

The path towards a BS degree in BME varies greatly from student to student. Since there are no required courses, students must tailor their programs to fit their specific academic needs, working within the boundaries of the major's distribution requirements and the WPI's general degree requirements. *Because BME is such a broad and diverse discipline, the distribution requirements for BME have been purposely written to provide students with a great deal of flexibility. However, with this flexibility comes responsibility.* This section is intended to give students a broad overview of the BME program components and to clarify those elements of the program that should be addressed before they begin selecting specific courses and projects. Planning a program in BME should be started only after students understand how these broad program elements will impact their total degree plan.

SPECIALIZATIONS WITHIN BME

Perhaps the most important decision students need to make when planning a BME program of study is the selection of a specialization. BME is so broad in scope that it is effectively impossible to develop sufficient rigor and understanding in all areas. By choosing a specialization, students bring focus to their coursework and project planning. BME specializations are not concentrations and do not change their degree requirements. In fact, students do not have to formally declare a specialization and their course options are not at all restricted within a specialization. They simply help to better organize the diverse field of biomedical engineering. Five specializations have already been created for students:

- Biomaterials
- Biomechanics
- Biomedical Imaging
- Biomedical Sensors and Instrumentation
- Tissue Engineering

To develop a BME program of study within one of these specializations, students should *first* understand the general program guidelines and advising issues (this section of the UG catalog) and *then* develop a plan of study within their chosen area of specialization. Within each specialization, there are additional and more specific advising guidelines, as well as information on project ideas and research opportunities.

The five specializations listed above were developed by the BME faculty because they cover most of the major sub-disciplines and research thrusts within biomedical engineering and because there is faculty expertise at WPI in these areas. However, students should not feel constrained to the courses and projects outlined within these specializations. In consultation with an academic advisor, students might be able to develop a unique specialization that is more precisely matched to their own academic needs. While students must work within the boundaries of the major's distribution requirements and the WPI's general degree requirements, the flexibility of the BME distribution requirements gives students the opportunity to either select one of the preexisting specializations or develop one of their own.

BASIC AND SUPPLEMENTAL SCIENCE REQUIREMENT

Because BME exists at the exciting intersection of engineering and biology, a firm foundation in the sciences (physics, chemistry, and biology) is critical. In fact, this is one aspect of a BME degree that distinguishes it from other engineering programs that have a biomedical engineering or biologic component. Biology, chemistry, and physics are not simply peripheral to the BME curriculum, but absolutely integral. The total science requirement is 8 courses (2-2/3 units), which is divided into two parts: a basic science requirement (6 courses) and a supplemental science requirement (2 courses). Within the basic science requirement, students must take 2 biology (BB), 2 chemistry (CH), and 2 physics (PH) courses, generally at the introductory level. The supplemental science requirement extends the science-related coursework into a particular

BME specialization. These two additional courses (BB, CH, or PH) should be chosen after selecting a specialization and students should consult the recommendations within that specialization for guidance. Broadly speaking, the supplemental science requirement should be used to develop greater science proficiency within a chosen specialization.

ENGINEERING OUTSIDE OF BME

As one might expect, the BME department does not teach every engineering course required for a BS in BME. The cross-disciplinary nature of a BME degree means that some of the engineering coursework, particularly at the sophomore- (2000+) and junior-levels (3000+), will come from other engineering departments. In general, students will take a sequence of courses within a particular engineering department based upon their selection of a BME specialization. For example, a student seeking a specialization in biomechanics will need to take a sequence of courses in mechanical engineering. Similarly, a student seeking a specialization in bioinstrumentation will need to take a sequence of courses in electrical engineering. This is why a BME specialization should be chosen as early as possible, since this choice dictates which engineering department will provide the majority of the fundamental engineering coursework. Since most engineering departments have core course sequences that begin at the 2000-level (sophomore-level), the selection of a BME specialization should be made no later than the middle of the sophomore year.

CORE BME COURSES

Before students begin developing a BME program of study, they should consider the important concept of "breadth versus depth". Within the limited time period here at WPI, it is impossible to develop sufficient knowledge, or "depth", in all areas of biomedical engineering. At the same time, a successful biomedical engineer is someone who has a fundamental understanding of many diverse areas of biomedical engineering (mechanical, electrical, and chemical). This is discipline "breadth" and should not be dismissed when planning a program of study. Because students can not take every course necessary to establish depth in all areas of biomedical engineering, the BME department has a series of core courses (a.k.a. bridge courses), mostly at the sophomore-level, that serve two fundamental purposes. First, they bridge the basic biology and science courses with the more advanced engineering coursework in biomedical engineering. Second, they provide breadth within an area of biomedical engineering that may lie outside of a chosen area of specialization. Thus these courses, taken as a group, serve to provide breadth in some areas of biomedical engineering and start students down a path towards depth within a chosen specialization. As students develop their BME programs of study, they should consider which of the BME core courses will provide them with the best combination of breadth and depth within BME.

MAJOR QUALIFYING PROJECT (MQP) AND BME DESIGN

In many cases, the pinnacle of a student's undergraduate work at WPI is the MQP, the senior-level design project. Most likely, students will choose or develop an MQP within their chosen area of specialization and will work with a specific BME program faculty member doing projects in that area. The MQP is an extremely important part of the degree program: it is a single project that accounts for the equivalent of three BME courses and provides some of the most directly relevant preparation that students will receive for graduate school or a job in industry. The MQP can be very rewarding, exciting, and even fun. However, it can also be quite frustrating if students are not adequately prepared. Consequently, when planning their program of study, students should make a good deal of effort to ensure that they have developed a solid foundation in BME before they begin a project. In addition, advanced leg-work to identify suitable projects should be a central component of their junior-year program planning.

As with all engineering departments at WPI, BME requires that the MQP satisfy the 1/3 unit capstone design experience. This means that, in addition to possible hypothesis-testing and experimentation during their MQP, students will be doing engineering design work. Engineering design is a process that must be learned, like most topics of importance, and there exists a BME course (BME 3300 – BME Design) to teach them the design process and the unique application of this process to biomedical engineering. This course should be taken prior to starting an MQP, typically in the junior-year.

In the section below on "Planning a Program in BME", students will find much more specific information to help them to choose or develop their MQP. However, before beginning this process, students should keep in mind that most BME program faculty are receptive to helping them realize a particular project idea that *they* might have. Students do not necessarily have to select a project created by someone else. If they have a specific interest in an area of biomedical engineering and don't see it described anywhere, students should not be dissuaded from speaking directly with a BME program faculty member about it. If the project idea is within biomedical engineering, has sufficient engineering design, and is of general interest to that BME program faculty member, it might be feasible. These types of self-defined projects are often the most rewarding for all involved, including the faculty.

LABORATORY EXPERIENCE WITH LIVING SYSTEMS

In its program criteria for biomedical engineering, the Accreditation Board for Engineering and Technology (ABET) requires that graduating undergraduate students have an understanding of biology and physiology and demonstrate an ability to make measurements on and interpret data from living systems. This particular requirement is specific to biomedical engineering programs and further clarifies the separation between biomedical engineering and other engineering disciplines.

HUMANITIES AND THE SUFFICIENCY

The humanities requirement and associated sufficiency is a requirement that all WPI students must satisfy to graduate. While it is possible to satisfy this requirement at any time during their tenure at WPI, it is generally much easier for students to complete it by the end of their sophomore-year. Like the MQP, the sufficiency is one of the major program requirements and due vigilance is certainly needed to ensure that the project is a satisfying experience. Students should identify a sufficiency advisor, typically a faculty member in Humanities and Arts, as soon as they can.

PLANNING A PROGRAM OF STUDY IN BME

The following section is intended to be a guide for students planning their BME degree program. Of course, it is by no means a *complete* guide and can not substitute for the BME distribution requirements (which *must* be met to graduate). In addition to the recommendations outlined here, students should also read and understand:

- WPI's general degree requirements.
- Information regarding the three required projects (Sufficiency, IQP, and MQP).
- Specific course descriptions in the undergraduate catalog.

After delving into this background material, students can begin to plan their program of study. Students will get the most out of this process if they complete the following tasks *in order*:

- Read the Overview of BME Program Components section above. This material provides general program guidelines and advising issues that are common to all BME students, regardless of specialization.
- Read the recommendations outlined in this section, which are intended to provide very practical and specific recommendations for all BME students, regardless of specialization.
- Read the specific advising and program planning guidelines for a chosen area of BME specialization.
- Choose specific courses for each term, projecting as far into the future as possible. There are advising forms on the web to help with this process. Consider the challenges of scheduling an off-campus IQP and dealing with Category II courses in the junior and senior years.
- Discuss their BME plan of study with their academic advisor. While there is a distinct academic advising day scheduled in the spring, students should always feel free to seek advice at any time.
- Refine and adjust academic plans as often as necessary to meet their educational goals. Be sure to consult with an academic advisor for matters related to the course scheduling and the fulfillment of degree requirements.

A NOTE ON ACADEMIC ADVISING

Our department, and WPI as a whole, offers students the opportunity of an education that is highly individualized. As no two students are identical in terms of their academic skills, interests, and aspirations, no two students should have identical academic programs. *The chance to tailor a degree program to their individual needs is indeed a great opportunity, but the burden of seizing such an opportunity falls primarily on the student.* Adapting to

WPI's complex system of courses, projects, and other degree requirements is certainly not an easy task.

Fortunately, students possess a set of resources to help them, including their peers, the faculty and staff of the BME department, the Academic Advising Office, and most importantly, their academic advisor. As students proceed through their years of undergraduate education, they should always remember that their academic advisor can be of great assistance. He or she is a source of advice and information, helping students with decisions about what courses to take, what projects to pursue, their personal and professional development, and how ultimately to make the most of their WPI experience. The academic advisor can even help students find a job or get accepted to a graduate program or medical school.

As students get to know their academic advisor, students should remember: though he or she may contribute as much guidance as possible, most of the effort in planning a program must come from the student. However, if a student simply cannot work well with their academic advisor for any reason, it is the students responsibility to find one with whom they are more comfortable.

CHOOSING A SPECIALIZATION

Whether students choose a pre-existing specializations or create one of their own, it is vitally important that they make this decision early on in their academic program. If students are unsure about what they want to do with their BME degree, then they should learn more about the different specializations first and also consider taking the "Introduction to Biomedical Engineering" course (BME 1001). This course was created to provide students with a broad overview of the different specializations within BME. It is offered every D-term and it is recommended for all BME freshmen who are unsure about their choice of specialization.

SELECTING COURSES IN BME

The program distribution requirements for BME specify 10-1/3 units of coursework (out of the 15 units required for graduation). This BME coursework requirement is subdivided into five major areas, each with a specific minimum coursework requirement:

1. Mathematics (6 courses, 2 units), which must include differential and integral calculus.
2. Basic science (6 courses, 2 units), which must include two courses each from biology (BB), chemistry (CH), and physics (PH).
3. Supplemental Science (2 courses, 2/3 units), which must be from BB, CH, or PH. These two courses do *not* have to be from the same department.
4. Laboratory experience with living systems (1/3 unit), which can be satisfied by taking Experimental Physiology (e.g., BB 3511 and BB 3514) or an equivalent laboratory-based course sequence in biology.
5. Biomedical Engineering and Engineering (13 courses, 4-1/3 units), which must be composed of the following components: (1) seven courses from Biomedical Engineering or Engineering as specified in the WPI Catalog "Courses Qualifying for Engineering Department Areas", one of which must be an engineering design course; (2) four courses in biomedical engineering or

engineering at the 3000-level or above; (3) two courses in biomedical engineering at the 4000-level or above. A minimum of eight of the thirteen courses must be from biomedical engineering, not including BME 3110.

There are a number of different ways to navigate these distribution requirements, which at first glance may seem intimidating. First, students should continue reading this document to get more insights into selecting individual courses, specifically the recommendations broken down by academic year. Second, students should utilize all of the available advising documents that have been created for their use. Finally, students should consult with their academic advisors, as needed, to ensure that their chosen coursework will satisfy these distribution requirements.

The mathematics requirement (6 courses) is fairly straightforward and does not deviate substantially from the other engineering programs at WPI. Competency in mathematics and statistics (MA 2611 – Statistics) is essential for a biomedical engineer. Through advanced testing and previous AP credits, the mathematics department will typically determine where students should begin in the calculus sequence. If students are fortunate enough to get advanced credit for some of their calculus, they should seriously consider using this credit to redesign their academic programs. Generally, advanced credit provides students with a wonderful opportunity to take additional courses of interest without extending their matriculation time at WPI.

The basic science requirement is intended to address basic "breadth" in the sciences and is typically accomplished by taking the first two introductory courses in both physics (Mechanics and Electricity and Magnetism) and general chemistry (Molecularity and Forces and Bonding). The recommendations for biology are slightly different, as the introductory-level (1000-level) biology courses are not usually the best choice for a biomedical engineer. It is recommended that students begin biology at the 2000-level, starting with Cell Biology (BB 2550), and do not take this first biology course until after they have completed the physics and chemistry requirements. This generally means that biology courses should not be taken in the freshmen year, but deferred until the start of the sophomore year. The following table summarizes the recommendations for the basic science requirement in biomedical engineering.

Biological (BB)	Chemistry (CH)	Physics (PH)
BB 2550 Cell Biology	CH 1010 Molecularity	PH 1110 Mechanics
BB 3102 Physiology	CH 1020 Forces and Bonding	PH 1120 Electricity and Magnetism

The supplemental science requirement is intended to extend the science-related coursework into a particular BME specialization. As such, the specific course recommendations are part of each BME specialization and students should consult the specific guidelines of their chosen specialization for additional information.

The "laboratory experience with living systems" requirement is truly unique to biomedical engineering and, as such, is listed as a separate and distinct degree requirement. Students can satisfy this requirement by taking

BB 3511 – Nerve and Muscle Physiology and BB 3514 – Circulatory and Respiratory Physiology or an equivalent laboratory-based two course sequence in biology.

The final course distribution requirement is probably the most complex, as it involves a sequence of engineering courses that must simultaneously satisfy a number of conditions. First, there must be a minimum of 13 of engineering courses, with four at the 3000-level (or higher) and two at the 4000-level (or higher). Second, some of these courses must also be biomedical engineering courses, since students must ultimately take 8 biomedical engineering courses (not counting BME 3110) to graduate. Engineering courses at the 1000-level, with the exception of BME 1001, can not be used to satisfy this engineering distribution requirement. If students want to take a 1000-level engineering course besides BME 1001, then they must count it as a free elective. Because the specific course recommendations are different for each specialization, students should consult the specific guidelines in their chosen specialization for additional information on choosing engineering courses (after reading this section).

With the basic course structure outlined above, students should consider now how they might develop a plan of study year-by-year. The paragraphs below provide important general advising guidelines, starting with the freshman year.

FIRST YEAR

Planning the first year at WPI may appear confusing and difficult, especially since there are so many different options. This section will help students make sense of these options, and identify the courses that are most important to complete in the first year. Always remember, though, that there is no single “perfect” academic program. In general, students should plan coursework in three main areas:

- **Mathematics** - Before students can begin more advanced coursework in the BME department, they need a proper foundation in mathematics. Students should begin by completing differential and integral calculus as soon as possible. If students have insufficient background in pre-calculus topics, they may begin with the semester-long MA 1020 course. If not, then students should begin with MA 1021. In either case, students should definitely follow with MA 1022. Students with a background in high school calculus (such as an AP course) may skip ahead to begin with MA 1022, MA 1023, or even MA 1024. Students should use the recommendations provided by the Mathematics Department, and they should consult their advisor to find out which starting point is right for them.
- **Basic Science Requirement** - The next step in planning the freshman year is to address the basic science requirements, particularly in physics and chemistry. The basic physics courses most directly relevant to BME are PH 1110 or PH 1111 (which deals with mechanics) and PH 1120 or PH 1121 (which deals with electricity and magnetism). When choosing physics courses, be sure to pay attention to any recommended background such as calculus. The basic chemistry courses most directly relevant to BME are CH 1010 (which deals with molecularity) and CH 1020 (which deals with forces

and bonding). Biology, which is an essential basic science requirement, should generally be deferred to the sophomore year. The 1000-level introductory biology courses offered at WPI are not the best starting point.

- **Humanities** - In addition to all of their major coursework and its related background, students should not forget that, at some point, they will need to complete a Sufficiency project! Students may want to schedule some Sufficiency-related coursework for their first year, especially if they want to complete the project in their sophomore year (which is highly recommended). In general, social science courses should not be taken in the first year, but should be considered in conjunction with IQP planning. Finally, students should not forget about their physical education requirement.

As students enter the spring semester of their first year, they should be thinking about what specialization they will likely pursue. As mentioned before, the earlier students choose their specialization, the earlier they can get started on the courses needed for competency within that specialization. If students are unsure about their selection, or desire to have a broad overview about the different areas of biomedical engineering, then BME 1001 is the recommended first step. This course is offered in D-term every year and is used by many students to help them choose a specialization. While students can defer their selection of a specialization into the early part of the sophomore year, making this decision at the conclusion of the first year is more desirable.

In choosing their courses for the first year, students should keep in mind that the BME degree requirements call for two “free elective” courses; if they pass all of their classes at WPI (15 units), they will end up with a total of five courses which they can choose with no restrictions whatsoever (2 free electives + 1 term). This flexibility can be used for a variety of purposes, such as pursuing another major or minor, delving deeper into a Sufficiency area, honing their skills within their major beyond the minimum courses required, preparing for medical, dental, or veterinary schools, or even just taking a few extra courses that interest them. In other words, students should not be afraid early on to take a course simply because it may not be “worth credit” toward their degree. Freshman year is a great time to explore the wide array of topics a WPI education has to offer.

SOPHOMORE YEAR

As students plan for their sophomore year, the most important task will be to continue progress in their major. In general, students should pursue coursework in three main areas:

- **Basic biology (within the basic science requirement)** – The biology courses most directly relevant to BME are BB 2550 (which deals with cellular biology) and BB 3102 (which deals primarily with organ systems physiology). BB 2550 is usually offered every A-term and should be one of the first courses that students put on their schedule.
- **BME core courses** – If students took BME 1001 in their freshman year, then they should choose at least two of the remaining 2000-level core course. Which two is generally a matter of individual preference. Students can choose a particular course to develop “breadth” within

BME or as a more rigorous introduction to their chosen specialization. Students should consult the recommendations associated with each specialization and their advisor for additional guidance. If students did not take BME 1001 in their freshman year, then they should take three of the 2000-level BME core courses.

- **Fundamental engineering outside of BME** – Now is the time to start taking the introductory engineering sequence within the engineering department that is associated with their specialization. For example, if a student's chosen area of specialization is bioinstrumentation, then they should begin taking the fundamental ECE course sequence (starting with ECE 2011). If their chosen area of specialization is biomechanics, then they should begin taking the fundamental ME course sequence (starting with ES 2501). Students should remember that they are trying to develop some rigor in another area of engineering and their course selections should follow the recommendations of that engineering department. As a note of caution, engineering courses outside of BME at the 1000-level can not be used to satisfy the engineering requirement in BME and can only be used to satisfy a free elective.

By the end of their sophomore year, students should have finished taking most of their mathematics and basic science courses, as these courses serve as background for further work in their major.

Many students choose to complete their Sufficiency project in the sophomore year. If students have finished the 5 course requirement for the Sufficiency, then they many consider this option. Before students schedule their project, they should be sure to find and approach an advisor with whom they would like to work. On the other hand, if they did not make much progress in completing humanities courses as a freshman, they should do so this year. Do not feel rushed, though – students do not necessarily have to complete their Sufficiency requirement as a sophomore. Some of the best Sufficiency projects are completed by juniors and seniors, so students should feel free to schedule their work in the humanities in a way that best suits them.

Another important task in the second year is to investigate WPI's "Global Perspective Program". Many WPI students perform their IQP at an off-campus project site. If students are planning to complete their IQP off-campus as a junior, then the application process begins in the *sophomore* year. For more information about off-campus projects, see the Projects section or go to the Interdisciplinary and Global Studies Division (IGSD). If the term that students want to do an off-campus IQP is also the term that BME 3300 is offered (typically A-term), then they should plan to take BME 3300 this year. BME 3300 should not be delayed to the senior year.

JUNIOR YEAR

With all the freshman- and sophomore-level background finally completed, the third year of education in the BME department offers students a chance for greater flexibility and control over their degree program. In general, students should pursue coursework in three main areas:

- **Engineering and BME** – students should continue to take courses within BME and the engineering discipline associated with their specialization. Keep in mind that not all courses are offered every year (Cat. II courses) and students should consider the possibility that an important course that they want to take in their senior-year may not be offered that year. If taking this course in the junior-year is the only option, then students should look carefully at the recommended background for the course and be sure that they are prepared to take this course in their junior-year. Specific course recommendations for the junior year are provided within each specialization.
- **Supplemental science** – mixing science and engineering courses is an excellent way to bring diversity to an academic program. Specific course recommendations are provided within each specialization.
- **Laboratory experience with living systems** – the recommended courses that meet this requirement are BB 3511 and BB 3514, BB 2903 or equivalent.
- **Biomedical engineering design (BME 3300)** – this BME course is technically part of the engineering requirement, but is discussed separately to emphasize its importance in the BME program. *BME 3300 teaches the design process as applied to the area of biomedical engineering and should definitely be taken prior to starting an MQP project.* Because the MQP project is a senior-level design project, this means that BME 3300 should be taken this year.

While "3000-level" is generally used to define courses appropriate for juniors, students will likely find it necessary to take a few 4000-level courses in their junior year. This is often dictated by scheduling problems and is not easily addressed within an engineering discipline that crosses so many departmental boundaries. This is why it is so important to develop the basic engineering competency as early as possible, so that students are prepared to take some 4000-level courses in their junior-year.

Despite the opportunities available to students in BME, one of the most substantial components of their work junior year will be the Interactive Qualifying Project (IQP). If students are planning to complete their IQP off-campus, students should be sure to take additional care in planning their courses around the term that they will be away. Also, in the term before students leave, off-campus projects typically require 1/6 unit or more of preparatory work. Students should take this extra burden into account as part of the workload for that term.

Yet another key undertaking of the junior year is the responsibility to find an MQP (usually in C or D terms). Biomedical engineering projects can be advised by any faculty member at WPI or at the University of Massachusetts Medical School (UMMS) who is also a BME Program Faculty Member. BME Program Faculty members have research and teaching interests within the discipline of biomedical engineering. If the BME Program faculty member that a student wants to work with does not have an academic appointment in the BME Department at WPI, most likely because they work at UMMS, then they must also find a co-advisor from the BME Department. Most of the BME Program Faculty at WPI also have a

BME academic appointment and advise many of the MQP projects for the BME department.

SENIOR YEAR

Depending on how well students have done in developing their degree program in the previous three years, planning for their senior year can be a breeze – or a disaster. However, even if students are new to the idea of taking academic planning seriously, there is still plenty they can do to ensure that they will be walking across the stage on graduation day.

By far, the most important part of senior year is the MQP. A typical on-campus MQP usually requires 1/3 unit of work in each of three consecutive terms – commonly A-term through C-term of the senior year. More often than not in BME, senior projects extend into D-term. This is due primarily to the multi-disciplinary nature of BME projects that mix engineering design and science. Any student wishing to graduate on time must remember three things: (1) all MQP students must be ready to give their final presentations on the annual Project Presentation Day in April, (2) the final MQP report, with the proper accompanying paperwork, must be submitted by the registrar's specific deadline (often called the CDR day or drop-dead day), and (3) students must be registered for MQP credit in the term that they submit their final MQP reports.

If a student's MQP is on the right track, the next step is to choose the remaining courses, which can be accomplished in many different ways. Some students select courses that will directly help them in an upcoming job or graduate program. Other students choose courses to supplement the topics they are covering in their MQP. Some use the remaining courses to expand their breadth of knowledge into an area where they are weak, while others use senior year to take those one or two 4000-level courses in areas where they desire more expertise. Graduate courses are certainly an option if students have the necessary background. All of these approaches are valid; the important issue is for students to think critically about their academic goals, and choose a path that best fits their current academic program, while allowing them to explore courses that appear interesting.

Besides their remaining major coursework, a student's plans for senior year must include everything else they need to complete for graduation. For example, some students choose to do their Sufficiency project senior year. Also, students should not forget the many other degree requirements that have been repeatedly mentioned – students certainly do not want to graduate late because they forgot a 1/12-unit physical education class! Students should be sure to have their academic advisor check their course plan at the *beginning* of senior year, to verify that they have not overlooked anything.

GRADUATION AND BEYOND

There is one additional, essential task for ALL senior year students. As the year progresses, seniors must plan for the "next step" – their lives *after* graduation.

A common direction for student to choose upon graduate is full-time employment. The job-seeking process is not always easy, requiring mastery of many important life

skills, such as writing a resume or participating in a job interview. Fortunately, there are many resources available to aid students in this process, including the Career Development Center, their academic advisor, other professors, alumni and their peers. One effective way to network with potential employers is at any of the regularly scheduled "career fairs", when companies send representatives to WPI to search for qualified applicants. Also, students should utilize the internet as a tool for publishing resumes, investigating potential employers and looking for job postings. Since a thorough and comprehensive job search can last several months, be sure to start early in the year (A or B term).

Another option is to continue with a program of academic study – typically a graduate or professional degree. A Master's degree in BME, perhaps through the Combined BS/Master's program at WPI, is a popular option for WPI undergraduates in BME. Remember, though, that the BS/MS program is a competitive program for very strong students. If students wish to begin study in the fall semester, they should realize that most graduate schools set their applications deadlines in December or January, and the deadlines for many fellowship competitions may occur even earlier. In any case, if students are interested in beginning a graduate program directly after graduation, they should be investigating potential schools, the programs they offer, and any fellowships or scholarships that may be available by the end of their junior year and during the following summer. Once again, the internet can provide invaluable assistance during this effort. Note that many graduate schools and fellowship applications require students to take certain standardized tests, such as the Graduate Record Examination (GRE's). Be sure to investigate thoroughly dates of preparation courses, test dates, and the delay time for receiving test results. Students must allow time to prepare for and take all the necessary tests, and still receive the results in time to use with your graduate applications. Finally, do not forget that a degree in BME is useful for far more than a future in engineering. The degrees we offer are excellent preparation for a wide array of graduate studies, including medicine, education, business, and law. Perhaps more importantly, no other engineering program at WPI makes it easier to prepare for medical, dental, or veterinary school.

When choosing one of these routes, keep in mind that the BME department expects a commitment to lifelong learning. In other words, even if students choose not to continue immediately with their formal studies, it does not mean the end of their education! First, there is always the chance to learn within a job in industry, through projects, training programs, and other learning opportunities. Furthermore, many students decide to return to graduate school after a few years of working, often finding that such "real-world" experience is a great advantage upon returning to academia. Regardless of the path students choose after leaving the BME department, they should always remember that their WPI degree (while extremely valuable) is certainly not the end of their education – it is only the foundation for years of learning yet to come.

BIOMEDICAL ENGINEERING PROGRAM CHART

	FRESHMAN/SOPHOMORE	JUNIOR	SENIOR
COURSE RECOMMENDATIONS	<p>Mathematics (6 courses) MA 1021 (Calculus I) MA 1024 (Calculus IV) MA 1022 (Calculus II) MA 2051 (Differential Equations) MA 1023 (Calculus III) MA 2611 (Statistics)</p> <p>Biology (2 courses) BB 2550 (Cell Biology) BB 3102 (Physiology: Transport and Maintenance)</p> <p>Chemistry (2 courses) CH 1010 (Molecularity) CH 1020 (Forces and Bonding)</p> <p>Physics (2 courses) PH 1110 (Physics I) PH 1120 (Physics II)</p> <p>Supplemental Science (2 courses) Pick 2 from BB, CH, or PH (See suggested courses from specialization areas listed below)</p> <p>BioMed. Eng. (select 3 courses) BME 1001 (Intro. to Bio. Med. Eng.) BME 2204 (Bioelectric Foundations) BME 2504 (Foundations in Biomechanics) BME 2604 (Foundations in Biol. Transport)</p> <p>H&A Sufficiency (2 Units) Social Science Physical Education</p>	<p>IQP</p> <p>BioMed. Eng. (2 courses) BME 3300 (BME Design)</p>	<p>MQP</p>
	<p>Social Science</p> <p>Free Electives</p> <p>Physical Education</p> <p>From the biomedical engineering specialization areas listed below, select nine (9) courses from BME or other engineering disciplines (four of these courses must be at the 3000-level or above, and must include two BME courses at the 4000-level or above).</p>		
	Note: The total minimum number of BME courses is eight (8)		
DEGREE REQUIREMENTS	H&A Sufficiency (2 units)		
		IQP (1 unit)	
	Math/Science (4 units)		
	Supplemental Science (2/3 Unit)		MQP (1 unit)
		Biomedical and other Engineering Topics (13/3 Units)	
		Living Systems Lab (1/3 Unit)	
		Social Science (2/3 Units)	
		Free Electives (2/3 Unit)	
	Physical Education (1/3 Units)		

TRANSFER STUDENTS

Since the curriculum at WPI and within the BME department is different from traditional programs offered at many other schools, transfer students must be sure to confer with their advisor to plan their WPI program. Transfer students with no previous BME courses should begin the program in the same way as first-year students. Students with some transfer credit may be able to start at a different place in the program. Those transferring from traditional engineering programs lacking a strong science component should be sure to immediately schedule their basic science courses. Course content in BME should be compared to the BME core courses.

PREPARATION FOR MEDICAL, DENTAL, OR VETERINARY SCHOOLS

Students interested in medical, dental, or veterinary school must be prepared to do some additional work, including the scheduling of additional coursework in the sciences. This is because these programs have admission requirements that are somewhat distinct from typical engineering programs, particularly in the sciences. Fortunately, by choosing BME for an undergraduate degree, students have already made it much easier to meet these admission requirements without substantially increasing their course load. No other engineering program at WPI gives students greater flexibility to simultaneously satisfy both the BME distribution requirements and the admission requirements for medical, dental, or veterinary school.

If students are interested in developing a pre-medical, pre-dental, or pre-veterinary program in BME, then they must be prepared to take additional courses in biology, general and organic chemistry, and physics. This coursework must include some laboratory experience, usually in organic chemistry. Most of it can be satisfied within the basic and supplemental science requirements for BME, but students will also need to utilize some of their elective credits (and then some). Students should start scheduling these additional courses as early as possible. This means that the decision to pursue a pre-health program should be made as early as possible—freshman year is not too early.

Student can pursue a pre-health program within any of the BME specializations and should adhere to the following general course recommendations:

- Supplemental Science – since a full year of general chemistry and physics is required (3 WPI courses = 1 year), students must take one course in both chemistry and physics (preferably CH 1030 or CH 1040 and PH 1140) in addition to the two in each area (CH 1010, CH 1020, PH 1110, and PH 1120) required by the BME program.
- Free electives – because of the requirement for three organic chemistry courses (with labs), it is recommended that students use their two free electives for two (CH 2310 and CH 2320) of these three courses. The third course (CH 2360) would be taken outside of the BME program requirements.

After reading these guidelines, students should also speak with faculty advisors in the Pre-Health Center for current information about course requirements and advice. If students are interested in becoming veterinarians, they should consider applying for admission to the joint BS / DVM program offered by WPI and Tufts University School of Veterinary Medicine. Students accepted into this program are guaranteed admission to veterinary school as early as their high school senior year and, in addition, can complete their entire program in seven years, rather than the traditional eight.

BIOMEDICAL ENGINEERING SPECIALIZATIONS

Because BME is such a broad and diverse discipline, it is convenient to subdivide it into a number of different specializations, or tracks. At the undergraduate level, these specializations help to bring focus to course and project planning. At the graduate-level, these specializations are aligned with the research interests of our faculty. Here at WPI, five specializations have been defined: Biomaterials, Biomechanics, Biomedical Imaging, Biomedical Sensors and Instrumentation, and Tissue Engineering. If students are interested in developing an undergraduate program of study in one of these specializations, they should first consult both the *Overview of BME Program Components* and *Planning a Program of Study in BME* sections of the catalog, which are relevant for all specializations, and then consult the information within their chosen area of specialization.

BIOMATERIALS

Biomaterials is a specialization within biomedical engineering that integrates engineering fundamentals in materials science with principles of cell biology, chemistry and physiology to aid in the design and development of materials used in the production of medical devices. When most people first think of biomaterials, implants such as surgical sutures, artificial hips or pacemakers generally comes to mind, but many other aspects are included in this diverse field of study:

- Biomaterials Design – Identify the physiological and engineering criteria that an implantable biomaterial must meet. Select the proper chemical composition to insure that the biomaterial imparts the desired mechanical properties and evokes the appropriate tissue response for the specified application.
- Mechanics of Biomaterials – Characterize the magnitude and nature of the mechanical properties of biomaterials. Predict and measure how the physical/structural properties of a biomaterial determine its mechanical properties.
- Biomaterials-Tissue Interactions – Examine the molecular, cellular and tissue responses to implanted medical devices. Design biomaterials with properties that induce the desired wound healing and tissue remodeling responses from the body.

Biomaterials research and development has improved our health care in many ways including:

- Design and manufacturing of replacement parts for damaged or diseased tissues and organs (e.g. artificial hip joints, kidney dialysis machines)
- Improved wound healing (e.g. sutures, wound dressings)
- Enhanced performance of medical devices (e.g. contact lenses, pacemakers)
- Correct functional abnormalities (e.g. spinal rods)
- Correct cosmetic problems (e.g. reconstructive mammaplasty, chin augmentation)
- Aid in clinical diagnostics (e.g. probes and catheters)
- Aid in clinical treatments (e.g. cardiac stents, drains and catheters)
- Design biodegradable scaffolds for tissue engineering (e.g. dermal analogs)

PLANNING AN UNDERGRADUATE PROGRAM OF STUDY IN BIOMATERIALS

Students interested in biomaterials should blend the disciplines of physics, mathematics, biology, materials science, and engineering according to their individual interests. The following section is intended to be a guide for planning a BME specialization degree program in biomaterials. It includes general advising guidelines as well as specific course recommendations.

IMPORTANT SUBJECTS TO MASTER

Because biomedical engineering is fundamentally an engineering discipline, a mathematics and engineering background is required. Engineering competence is best accomplished by pursuing coursework in materials science and mechanical engineering, since these disciplines have the greatest relevance for biomaterials. Therefore, most of the engineering courses that students will take outside of BME should come from the ME department.

In addition to an engineering background, a strong background in physics (mechanics) and chemistry is necessary. Furthermore, students interested in biomaterials (e.g., titanium hip implants, living skin equivalents) need to understand the interaction between materials with cells and the biochemical environment. Therefore, their supplemental science and, perhaps, some of their elective coursework should be in biology and biochemistry.

COURSE SELECTION GUIDELINES

The following section provides specific course recommendations for students pursuing a specialization in biomaterials. Note: *Category II (cat. II) indicates that the course is offered every other year.*

Supplemental Science Courses: As mentioned above, it is recommended that students pursue physics, biology, and chemistry courses within the BME supplemental science requirement. The order in which students take physics and chemistry is not critical.

For those interested in the design, synthesis and characterization of biomaterials, particularly biopolymers, supplemental science courses at the more advanced level

are suggested. Organic Chemistry I (CH 2310) and Polymer Chemistry (CH 4550) are highly recommended for those interested in biopolymers. Students that are interested in biomaterial-tissue interactions and the biocompatibility of biomaterials should also consider taking Biochemistry (CH 4110) as it discusses many of the important bio-molecules that make up the tissues. For hands on laboratory skills for working with cells and tissues, experimental biology (e.g., BB 2901, BB 2902 and BB 2903) and Cell Culture Theory and Applications (BB 4008) are recommended.

Biomedical Engineering Courses: Because biomaterials science is built upon a core of mechanical engineering, materials science, physics, mathematics, and biology, there are a few specific biomaterials courses, except at the senior- and graduate-levels. Students should definitely plan to take Foundations in Biomechanics (BME 2504) and Foundations in Biological Transport (BME 2604) in their sophomore-year, Biomaterials (BME/ME 4814) and Biomaterials-Tissue Interactions (BME 4828) in their senior year. For their other BME coursework, students may want to take Bioelectric Foundations (BME 2204), Biomechanics (BME 4504, cat II) and Biofluids (BME 4606, cat II). In consultation with their academic advisor, students might also consider coursework in biomaterials at the graduate-level. These courses include Biomaterials in the Design of Medical Devices (BME 595B) and Tissue Engineering (BME/ME 550, cat II).

Other Engineering Courses: The majority of the engineering courses outside of the BME department should be taken in the ME department. Introduction to Material Science, Static Systems, and Stress Analysis, are fundamental courses for biomaterials engineers. In addition, students should consider the following courses:

- **Biomaterials Synthesis and Characterization:** Introduction to Thermodynamics (ES 3001), Materials Processing (ME 2820), Advanced Mechanics of Materials (ME 3502), and Chemistry, Properties and Processing of Plastics (ME 4821) are important core courses for biomaterials engineers.
- **Mechanical Properties of Biomaterials; Design of Prosthetics:** If interested in characterizing the mechanical properties of biomaterials or prosthetics, Intro to Material Science (ES 2001), Mechanical Behavior and Modeling Properties of Engineering Materials (ME 3023) and Advanced Mechanics of Materials (ME 3502), are important. Fluid mechanics (ES 3004) and Continuum Mechanics (ME 3502) are also important fundamental courses if students plan to study the mechanical properties of biomaterials.

Suggested Course Table and Sequence

Supplemental Science (Select two courses)

Select two from the following science courses below:

- BB 2901 - Molecular Biology, Microbiology, and Genetics
- BB 2902 - Enzymes, Proteins, and Purification
- BB 2903 - Anatomy and Physiology
- BB 3101 - Human Physiology: Movement and Communication
- BB 4008 - Cell Culture Theory and Application
- CH 2310 - Organic Chemistry I
- CH 4110 - Biochemistry I
- CH 4550 - Polymer Chemistry (cat. II)

Engineering (Select nine courses)

Select three fundamental engineering courses, preferred choices include:

- ES 2001 - Introduction to Materials Science
- ES 2501 - Introduction to Static Systems
- ES 2502 - Stress Analysis
- ME 2820 - Materials Processing

Select two 3000-level (or higher) engineering courses, preferred choices include:

- ES 3001 - Introduction to Thermodynamics
- ES 3004 - Fluid Mechanics
- ME 3023 - Mechanical Behavior and Modeling properties of Engineering Materials
- ME 3501 - Continuum Mechanics
- ME 3502 - Advanced Mechanics of Materials
- ME 4821 - Chemistry, Properties and Processing of Plastics (cat. II)

Select four 3000- and 4000-level BME courses, preferred choices include: [Note #1]

- BME/ME 4504 - Biomechanics (cat. II)
- BME/ME 4606 - Biofluids (cat. II)
- BME/ME 4814 - Biomaterials
- BME 4828 - Biomaterials-Tissue Interactions
- BME/ME 550 - Tissue Engineering (cat. II)
- BME 595B - Biomaterials in the Design of Medical Devices

Note #1: At least 2 of the BME courses must be at the 4000-level or above. Graduate level courses can substitute for 4000-level courses.

BIOMECHANICS

Biomechanics is a specialization within biomedical engineering that involves the application of engineering mechanics to the study of biological tissues and physiological systems. When most people first think of biomechanics the way we move or the strength of bones generally comes to mind but many other aspects are included in this diverse field of study including:

- Dynamics – analysis of human movement including walking, running, and throwing.
- Statics – determination of the magnitude and nature of forces in joints, bones, muscles and implanted prostheses, and characterization of the mechanical properties of the tissues in our bodies.
- Fluid mechanics – analysis flow of blood through arteries and air through the lung.

Biomechanics research has improved our understanding of, among other things:

- Design and manufacturing of medical instruments, devices for disabled persons, artificial replacements, and implants.
- Human performance in the workplace and in athletic competition.
- Normal and pathological human and animal locomotion.

- The mechanical properties of hard and soft tissues.
- Neuromuscular control.
- The connection between blood flow and arteriosclerosis.
- Air flow and lung pathology.
- The effects of mechanical loads on cellular mechanics and physiology.
- Morphogenesis, growth, and healing.
- The mechanics of biomaterials.
- Engineering of living replacement tissue (tissue engineering).

PLANNING AN UNDERGRADUATE PROGRAM OF STUDY IN BIOMECHANICS

Students interested in biomechanics should blend the disciplines of physics, mathematics, biology, computer science, and engineering according to their individual interests. The following section is intended to be a guide for planning a BME specialization degree program in biomechanics. It includes general advising guidelines as well as specific course recommendations.

IMPORTANT SUBJECTS TO MASTER

Because biomedical engineering is fundamentally an engineering discipline, a mathematics and engineering background is required. Engineering competence is best accomplished by pursuing coursework in mechanical engineering, since this discipline has the greatest relevance for biomechanics. Therefore, most of the engineering courses that students will take outside of BME should come from the ME department.

In addition to an engineering background, a strong background in physics (mechanics) is necessary. Furthermore, students interested in the biomechanics of cells, tissues, and biomaterials (e.g., bioprosthetic heart valves, living skin equivalents) need to understand cell physiology and biochemistry. Therefore, their supplemental science and, perhaps, some of their elective coursework should be in biology and biochemistry.

Finally, if a student's interests in biomechanics are focused on design of implantable components (e.g., hip prostheses) and medical devices (e.g., wheel chairs), then a proficiency in finite element analysis and design will likely be very helpful.

COURSE SELECTION GUIDELINES

The following section provides specific course recommendations for students pursuing a specialization in biomechanics.

Supplemental Science Courses: As mentioned above, it is recommended that students pursue physics, biology, and chemistry courses within the BME supplemental science requirement. The order in which students take physics and chemistry is not critical. Besides the biology courses taken as part of the basic science requirement for BME, probably the most relevant course is Human Physiology: Movement and Communication (BB 3101).

Biomechanics of cells and tissues: For those interested in the biomechanics of cells and tissues, supplemental science courses at the more advanced level are suggested. Biochemistry (CH 4110) is highly recommended as it discusses many of the important bio-molecules that make up the tissues; Organic Chemistry I (CH 2310) and Polymer

Chemistry (CH 4550) are also suggested for those interested in biomaterials. For hands on laboratory skills for working with cells and tissues, Experimental Biology I (BB 2940) and Cell Culture Theory and Applications (BB 4008) are recommended.

Biomedical Engineering Courses: Because biomechanics is built upon a core of mechanical engineering, physics, mathematics, and biology, there are only a few specific biomechanics courses, except at the senior- and graduate-levels. Students should definitely plan to take Foundations in Biomechanics (BME 2504) and Foundations in Biological Transport (BME 2604) in their sophomore-year, Biomechanics (BME 4504, cat II) in their junior or senior-year (it is only offered every other year), and Biofluids (BME/ME 4606, cat II). For the Biomechanics specialization, BME 2504 may aid in understanding the material in ES 2501 and ES 2502, but it does *NOT* replace these courses. In planning their 4-year courses of study, students should note that BME 4504 and BME 4606 are offered in alternating years. For their other BME coursework, students may want to take Bioelectric Foundations (BME 2204) and Biomaterials (BME/ME 4814). In consultation with their academic advisor, they might also consider coursework in biomechanics at the graduate-level. These courses include Tissue Mechanics (BME/ME 552), Composites with Biomedical and Materials Applications (BME/ME 554, cat II) and Tissue Engineering (BME/ME 550, cat II).

Other Engineering Courses: The majority of a student's engineering courses outside of the BME department should be taken in the ME department. Introduction to Material Science, Static Systems, Stress Analysis, Dynamic systems and Control Systems are fundamental courses for biomechanical engineers; at least 3 of the following topics should be covered:

- **Heat and flow in biological systems:** Introduction to Thermodynamics (ES 3001), Fluid Mechanics (ES 3004) and Heat Transfer (ES 3003) are important core courses for biomechanical engineers interested in heat and flow.
- **Design of prosthetics and rehabilitation engineering:** If interested in design of prosthetics and rehabilitation engineering, Intro to Material Science (ES 2001) Advanced Mechanics of Materials (ME 3502), Rehabilitation Engineering (ME 3506), and Advanced Computer Aided Design (ES 3323) are important.
- **Human movement and sports biomechanics:** Those interested in human movement and sports biomechanics should consider Dynamics (ES 2503), Kinematics of Mechanisms (ME 3310), and Dynamic Modeling (ME 3321).
- **Cell and tissue mechanics:** To specialize in cell and tissue mechanics, students should consider Introduction to Material Science (ES 2001), Mechanical Behavior and Modeling properties of Engineering Materials (ME 3023) and Continuum Mechanics (ME 3501), and Advanced Mechanics of Materials (ME 3502).

Suggested Course Table and Sequence

Supplemental Science (Select two courses)

Select two from the following science courses below:

- BB 2901 - Molecular Biology, Microbiology, and Genetics
- BB 2902 - Enzymes, Proteins, and Purification
- BB 2903 - Anatomy and Physiology
- BB 3101 - Human Anatomy & Physiology: Movement and Communication
- BB 3102 - Human Anatomy & Physiology: Transport and Maintenance
- CH 2310 - Organic Chemistry I
- CH 4110 - Biochemistry I
- CH 4550 - Polymer Chemistry (Cat. II)

Engineering (Select nine courses)

Select three fundamental engineering courses, preferred choices include:

- ES 2001 - Introduction to Materials Science [Note #2]
- ES 2501 - Introduction to Static Systems
- ES 2502 - Stress Analysis [Note #2]
- ES 2503 - Introduction to Dynamic Systems

Select two 3000-level (or higher) engineering courses, preferred choices include:

- ES 3001 - Introduction to Thermodynamics
 - ES 3003 - Heat Transfer
 - ES 3004 - Fluid Mechanics [Note #3]
 - ES 3011 - Control Systems
 - ES 3323 - Advanced Computer Aided Design
 - ME 3023 - Mechanical Behavior and Modeling properties of Engineering Materials
 - ME 3310 - Kinematics of Mechanisms
 - ME 3321 - Dynamic Modeling
 - ME 3501 - Continuum Mechanics (Cat. II) [Note #4]
 - ME 3502 - Advanced Mechanics of Materials
 - ME 3506 - Rehabilitation Engineering
 - ME 4512 - Introduction to Finite Element Method
- Select four 3000- and 4000-level BME courses, preferred choices include: [Note #1]
- BME/ME 4504 - Biomechanics (Cat. II)
 - BME/ME 4606 - Biofluids
 - BME/ME 4814 - Biomaterials
 - BME/ME 552 - Tissue Mechanics (Cat. II)
 - BME/ME 550 - Tissue Engineering (Cat. II)
 - BME/ME 554 - Composites with Biomedical and Materials Applications

Note #1: At least 2 of the BME courses must be at the 4000-level or above. Graduate level courses can substitute for 4000-level courses.

Note #2: These courses should be completed before taking BME 4814.

Note #3: This course should be completed before taking BME 4606.

Note #4: This course should be completed before taking BME 4504 or BME 552.

BIOMEDICAL IMAGING

Biomedical imaging is a broad specialization within biomedical engineering that involves the application of quantitative science and engineering to detect and visualize biological processes. An important sub-area in biomedical imaging is the application of these tools and knowledge to the study of diseases with an ultimate goal of aiding medical intervention. While x-ray imaging is an obvious and familiar example with tremendous diagnostic utility, it represents only a small aspect of this important field. Biomedical imaging:

- Includes the numerous and diverse imaging technologies that nearly cover the electromagnetic spectrum. Examples include x-ray imaging, visible light (optical) imaging, near-infrared imaging, magnetic resonance imaging, and ultrasound imaging. The detected radiation can be either naturally emitted by the body (such as

infrared radiation) or re-emitted radiation (as in magnetic resonance imaging). It also includes technologies that produce images following the introduction of a chemical agent into the body, such as nuclear medicine imaging and luminescence-based imaging.

- Involves the development of sophisticated instrumentation to acquire and process images from the body, most often in a non-invasive or minimally-invasive manner. A biomedical engineer is not simply a user of an imaging technology, but an active participant in the development of new technologies.
- Requires an understanding of how energy interacts with biological tissue and how this interaction is used to produce images of diagnostic utility. This understanding is rooted in the disciplines of physics, chemistry, and biology. A biomedical engineer, therefore, must have a strong background in the physical sciences.
- Involves both image acquisition *and* image processing. Rarely are the signals acquired by the instrumentation immediately interpretable. For example, image processing is used to create two- and three-dimensional images from the acquired "raw" signals and to extract important image features. An example is computed tomography, which converts a series of through-body x-ray images into a cross-sectional image that reveals internal tissue structures. Image processing is grounded in the disciplines of mathematics and computer science.
- Is capable of generating much more than simple anatomic images. For example, newer biomedical imaging technologies are being used to image and quantify blood flow and metabolic activity in normal and diseased tissue. The development of these "functional" imaging technologies has tremendous potential to substantially advance our understanding of biological and disease processes. Because it is often completely non-invasive, biomedical imaging is already revolutionizing the study of brain function in humans.
- Involves all size scales, from sub-cellular to whole body.
- Is an important component of many other disciplines and specializations, including biology and tissue engineering. Without the technical advances in biomedical imaging, we would often be at the mercy of time-consuming and tedious chemical or histological analyses to probe cellular function and microscopic structures. Non-invasive methods also allow biological processes to be studied over time on the same sample.

PLANNING AN UNDERGRADUATE PROGRAM OF STUDY IN BIOMEDICAL IMAGING

Students interested in biomedical imaging should blend the disciplines of physics, chemistry, mathematics, biology, computer science, and engineering according to their individual interests. The following section is intended to be a guide for planning a BME specialization degree program in biomedical imaging. It includes general advising guidelines as well as specific course recommendations.

IMPORTANT SUBJECTS TO MASTER

Because biomedical engineering is fundamentally an engineering discipline, a mathematics and engineering background is required. Engineering competence is best accomplished by pursuing coursework in electrical engineering, since this discipline has the greatest relevance for

biomedical imaging. Therefore, most of the engineering courses that students will take outside of BME should come from the ECE department.

At its most basic level, biomedical imaging uses information on the interaction of electromagnetic energy with cells and tissues to form images. A student's plan of study should therefore allow them to investigate the range of wavelengths used in biomedical imaging, how electromagnetic energy propagates through and interacts with molecules, cells, and tissues, the types of information that can be extracted with a particular technique, and the limitations of each particular technique. Many of these issues are addressed within the disciplines of physics and chemistry. Therefore, a student's supplemental science and, perhaps, some of their elective coursework should include courses in physics and chemistry.

Finally, if a student's interests in biomedical imaging are focused on the important area of image processing, then proficiency beyond basic computer science will likely be very helpful. While computer science is not a distribution requirement in BME, students might consider adding some coursework in computer science.

COURSE SELECTION GUIDELINES

The following section provides specific course recommendations for students pursuing a specialization in biomedical imaging.

Supplemental Science Courses: As mentioned above, it is recommended that students pursue physics and chemistry courses within the BME supplemental science requirement. Besides the two chemistry courses taken as part of the basic science requirement for BME, probably the most relevant course is Dynamics (CH 1040). This course examines the nature of molecular motions and the interaction with electromagnetic energy. Various types of molecular spectroscopy, which form the basis for many biomedical imaging technologies, are discussed. At the more advanced level, Biochemistry (CH 4110) is highly recommended, as it discusses many of the important biomolecules that are often probed with biomedical imaging technologies. Within the discipline of physics, the most relevant course is probably Oscillations and Waves (PH 1140). This course introduces the concepts of traveling waves, interference, and reflection, which are particularly relevant to a biomedical imaging student. If a student's interests in biomedical imaging are in the area of visible light imaging, then Photonics (PH 2501), Lasers (PH 2502), and Photonics Laboratory (PH 2601) may also be appropriate. While Electromagnetic Fields (PH 2301) is also a highly recommended course, much of this material is also covered in an ECE equivalent course (ECE 2112). By taking the ECE version, students are able to count it as an engineering course instead of a supplemental science course.

Biomedical Engineering Courses: Because biomedical imaging is built upon a core of engineering (usually electrical engineering), physics, mathematics, and chemistry, there are only a few specific biomedical imaging courses, except at the senior- and graduate-levels. Students should plan to take Bioelectric Foundations (BME 2204) in their sophomore-year and Biomedical Imaging (BME 4201) in their senior-year. For other BME coursework, bioinstru-

mentation courses, including Bioinstrumentation and Biosensors (BME 3011), Biomedical Instrumentation Design I (BME 4023) and Biomedical Instrumentation Design II (BME 4025) would be extremely helpful. In consultation with their academic advisors, students might also consider coursework in biomedical imaging at the graduate-level. These courses include Medical Imaging Systems (BME 581) and Principles of In Vivo Nuclear Magnetic Resonance Imaging (BME 582).

Other Engineering Courses: The majority of the engineering courses outside of the BME department should be taken in the ECE department. Students should choose a sequence of courses based on the recommendations provided by the ECE department.

Suggested Course Table and Sequence

Supplemental Science (Select two courses)

Preferred choices include:

CH 1040 – Chemistry IV (Dynamics)
 CH 4110 – Biochemistry
 PH 1140 – Oscillations and Waves
 PH 2501 – Photonics
 PH 2601 – Photonics Laboratory

Engineering (Select nine courses)

Select three fundamental engineering courses; preferred choices include:

ECE 2011 – Introduction to Electrical and Computer Engineering
 ECE 2111 – Physical Principles of ECE Applications
 ECE 2112 – Electromagnetic Fields
 ECE 2311 – Continuous-Time Signal and System Analysis
 ECE 2312 – Discrete-Time Signal and System Analysis

Select two 3000-level (or higher) engineering courses; preferred choices include:

ECE 3113 – Introduction to RF Circuit Design
 ECE 3204 – Microelectronic Circuits II
 ME 4922 – Theory and Practice of Laser Instrumentation
Select four 3000- and/or 4000-level BME courses; preferred choices include [Note #1]:

BME 3011 – Bioinstrumentation and Biosensors
 BME 4011 – Biomedical Signal Analysis
 BME 4201 – Biomedical Imaging
 BME 4541 – Biological Systems
 BME 581 – Medical Imaging Systems
 BME 582 – Principles of In Vivo Nuclear Magnetic Resonance Imaging

Note #1: At least 2 of the BME courses must be at the 4000-level or above. Graduate level courses can substitute for 4000-level courses.

BIOSENSORS AND BIOINSTRUMENTATION

Modern health care relies heavily on a large array of sophisticated medical instrumentation to diagnose health problems, to monitor patient condition and administer therapeutic treatments, most often in a non-invasive or minimally-invasive manner. During the past decade, computers have become an essential part of modern bioinstrumentation, from the microprocessor in a single-purpose instrument used to do a variety of small tasks to the desk-top microcomputer needed to process the large amount of clinical information acquired from patients.

A biomedical engineer is not simply a user of measurement technology, but an active participant in the development of new diagnostic and therapeutic modalities. Hence, the Biosensors and Bioinstrumentation track of our program focuses on training students to design, test,

and use sensors and biomedical instrumentation in humans and animals to further enhance the quality of health care. Emphasis is placed both on understanding the physiological systems involved in the generation of the measured variable or affected by therapeutic equipment as well as the engineering principles of new sensors and advanced measurement devices. This track provides an excellent training experience that prepares students for careers in industry, higher education as well as medical school.

Examples of common biomedical sensors, devices, and instrumentation developed by biomedical engineers and used routinely in medicine include:

- Blood chemistry sensors (e.g. electrolytes, O₂, CO₂, pH, glucose)
- Specialized instrumentation for genetic testing
- Physical sensors (e.g. pressure, temperature, flow)
- Electrical sensors (electrodes)
- Electrocardiographs (a device that measures the electrical activity of the heart)
- Electroencephalograph (a device that measures the electrical activities of the brain)
- Electromyography (a device that measures the electrical activities of muscles)
- Mechanical respirator
- Cardiac pacemaker
- Defibrillators
- Artificial heart
- Pulse oximeters
- Ultrasonic equipment
- Imaging scanners (nuclear cameras, CAT, MRI)
- Drug infusion and insulin pumps
- Electrosurgical equipment
- Heart-lung machine
- Anesthesia machine
- Kidney dialysis machine
- Specialized equipment used by disabled people (e.g. hearing aids)
- Laser systems for eye surgery

PLANNING AN UNDERGRADUATE PROGRAM OF STUDY IN BIOSENSORS AND BIOINSTRUMENTATION

Students interested in biomedical sensors and instrumentation should blend the disciplines of physics, chemistry, biology, electrical and computer engineering, and biomedical engineering according to their individual interests. The following section is intended to be a guide for planning a BME specialization degree program in biomedical sensors and instrumentation. It includes general advising guidelines as well as specific course recommendations.

IMPORTANT SUBJECTS TO MASTER

Because biomedical engineering is fundamentally an engineering discipline, an engineering background is required. Engineering competence is best accomplished by pursuing coursework in both electrical engineering and physics, since these two disciplines have the greatest relevance for biomedical sensors and instrumentation. Therefore, most of the engineering courses that students will take outside of BME should come from the ECE department.

In addition to a strong engineering background, students concentrating in biomedical sensors and instrumentation need to understand the origin of different biomedical signals. This knowledge is important to support diagnostic and therapeutic procedures. Therefore, their supplemental science and, perhaps, some of their elective coursework should be in biology and physiology. Students should also learn how to select appropriate sensors and instrumentation for studying biomedical relevant problems through the acquisition of physiological data from the body.

Since the living body is a “challenging” environment to measure, accurate detection of physiological signals require sensors and instrumentation that have high specificity and selectivity. Therefore, students need to know how to amplify and filter relatively small and noisy electrical signals. Additionally, it is important that they learn other important issues related to biomedical sensors and instrumentation such as biocompatibility and electromagnetic interferences. Computers are an essential part of modern bioinstrumentation, from the microprocessor in a single-purpose instrument used to do a variety of small tasks to the more general microcomputer used to process the large amount of clinical information. Therefore, a proficiency in computer engineering will likely be very helpful. Other important and emerging areas to consider involve sensors and instrumentation based on Micro-Electro Mechanical-Systems (MEMS) and wireless data communication.

COURSE SELECTION GUIDELINES

The following section provides specific course recommendations for students pursuing a specialization in biomedical sensors and instrumentation. Generally, the Biomedical Sensors and Instrumentation track should include courses in electrical circuits, electronics, microprocessors, systems and signal analysis, as well as biomedical engineering courses in sensors. It is essential that students take as many laboratory and design courses as possible that use also “breadboard” development and emphasize different design concepts.

Supplemental Science Courses: As mentioned above, it is recommended that students pursue biology and physics courses within the BME supplemental science requirement. Besides the two chemistry and physics courses taken as part of the basic science requirement for BME, within the discipline of Biology, experimental biology (e.g., BB 2901, BB 2902, BB 2903) provide basic procedures and experimental skills needed to study living organisms at the cellular level. Within the physics discipline, the most relevant courses are: Introduction to 20th Century Physics (PH 1130), Oscillations and Waves (PH 1140), Photonics (PH 2501), Lasers (PH 2502) and Photonics Laboratory (PH 2601). The material in PH 1130 and PH 1140 cover concepts related to nuclear physics, X-rays, traveling waves, interference, and reflection physics which are more relevant for students interested in instrumentation used for biomedical imaging. If their interests are in optical-based biomedical instrumentation, then PH 2501, PH 2502, and PH 2601 may be more appropriate.

Biomedical Engineering Courses: Students interested in the Biomedical Sensors and Instrumentation track should select courses covering fundamental principles of electrical and control engineering, signal analysis, and engineering design. Students should take Bioelectric Foundations (BME 2204) in their sophomore year and Bioinstrumentation and Biosensors (BME 3011) in their junior year. Depending on their background and level, if they are ready, students should start taking BME courses related to their area of concentration as early as the junior year. The recommended courses are: Biomedical Instrumentation Design I (BME 4023), Biomedical Instrumentation Design II (BME 4025), Biomedical Signal Analysis (BME 4011), and Biological Systems (BME 4541). In consultation with their academic advisor, students might also consider coursework in biomedical imaging (BME 4201) or more advanced graduate-level courses in bioinstrumentation.

Other Engineering Courses: The majority of the engineering courses outside of the BME department should be taken in the ECE department. Students should choose a sequence of courses in consultation with their academic advisor based on their interest (e.g. microprocessors, signal analysis, hardware, software, etc.) following the general recommendations provided below.

Suggested Course Table and Sequence

Supplemental Science (Select two courses)

Preferred choices include:

- BB 2901 – Molecular Biology, Microbiology, and Genetics
- BB 2902 – Enzymes, Proteins, and Purification
- BB 2903 – Anatomy and Physiology
- BB 3101 – Human Physiology: Movement and Communication
- PH 1130 – Introduction to 20th Century Physics
- PH 1140 – Oscillations and Waves
- PH 2501 – Photonics

Engineering (Select nine courses)

Select three fundamental ECE courses; preferred choices include:

- ECE 2011 – Introduction to Electrical and Computer Engineering
- ECE 2022 – Introduction to Digital Circuits & Computer Engineering
- ECE 2111 – Physical Principles of ECE Applications
- ECE 2201 – Microelectronic Circuits I
- ECE 2311 – Continuous-Time Signal and System Analysis
- ECE 2312 – Discrete-Time Signal and System Analysis
- ECE 2799 – Electrical & Computer Engineering Design

Select two 3000-level (or higher) engineering courses;

- preferred choices include:
- ES 3011 – Control Engineering
 - ECE 3204 – Microelectronic Circuits II
 - ECE 3703 – Real-Time Digital Signal Processing
 - ECE 3801 – Advanced Logic Design

Select four 3000- and/or 4000-level BE courses; preferred choices include [Note #1]:

- BME 3011 – Bioinstrumentation and Biosensors
- BME 4011 – Biomedical Signal Analysis
- BME 4023 – Biomedical Instrumentation I
- BME 4025 – Biomedical Instrumentation II
- BME 4541 – Biological Systems

Note #1: At least 2 of the BE courses must be at the 4000-level or above. Graduate level courses can substitute for 4000-level courses.

TISSUE ENGINEERING

Tissue engineering integrates the principles and methods of engineering with the fundamentals of life sciences towards the development of biological substitutes to restore, maintain or improve tissue/organ function. When most people first think of tissue engineering, artificial skin and cartilage generally comes to mind, but many other aspects are included in this diverse field of study:

- **Scaffold/Biomaterial Design** – Identify the physiological and engineering criteria that a biodegradable scaffold must meet. Select the proper biochemical composition to insure that the cells perform in a physiologic manner on the surface of the scaffold.
- **Functional/Biomechanical Tissue Engineering** – Characterize the roles of biomechanical stimuli on the growth and development of bioengineered cells, tissues and organs. Measure the biomechanical properties of bioengineered tissues and organs.
- **Bioreactor Design** – Design reactors that control the rates at which nutrients and growth factors are supplied to bioengineered tissues and organs during growth and development in a laboratory environment.

PLANNING AN UNDERGRADUATE PROGRAM OF STUDY IN TISSUE ENGINEERING

Students interested in tissue engineering should blend the disciplines of physics, mathematics, biology, and engineering according to their individual interests. The following section is intended to be a guide for planning a BME specialization degree program in tissue engineering. It includes general advising guidelines as well as specific course recommendations.

IMPORTANT SUBJECTS TO MASTER

Because biomedical engineering is fundamentally an engineering discipline, a mathematics and engineering background is required. Engineering competence is best accomplished by pursuing coursework in either chemical or mechanical engineering, since these disciplines have the greatest relevance for tissue engineering. Therefore, most of the engineering courses that you will take outside of BME should come from the mechanical engineering (ME) or chemical engineering (CHE) departments.

Students interested in tissue engineering (e.g., tissue engineered cartilage, living skin equivalents) need to understand cell physiology and biochemistry. Therefore, their supplemental science and, perhaps, much of their elective coursework should be in biology and biochemistry.

COURSE SELECTION GUIDELINES

The following section provides specific course recommendations for students pursuing a specialization in tissue engineering. Note: Category II (cat. II) indicates that the course is offered every other year.

Supplemental Science Courses: As mentioned above, it is recommended that students pursue physics, cell biology, and biochemistry courses within the BME supple-

mental science requirement. The order in which they take these courses is not critical. Taking physics and chemistry in the freshman year are highly recommended. Advanced, laboratory-based biology, chemistry and physiology courses should also be incorporated into a course of study.

For those interested in the design, synthesis and characterization of bioengineered tissues and organs, supplemental science courses at the more advanced level are suggested. Organic Chemistry I (CH 2310) and Biochemistry (CH 4110) are highly recommended. For hands on laboratory skills for working with cells and tissues, experimental biology (e.g., BB 2901, BB 2902, BB 2903) and Cell Culture Theory and Applications (BB 4008) are recommended.

Biomedical Engineering Courses: Because tissue engineering is built upon a core of mechanical or chemical engineering, materials science, physics, mathematics, and biology, there are only a few specific tissue engineering courses, except at the senior- and graduate-levels. Students should definitely plan to take Foundations in Biomechanics (BME 2504) and Foundations in Biological Transport (BME 2604) in their sophomore-year, and Biomaterials (BME/ME 4814) and Biomaterials-Tissue Interactions (BME 4828) in their senior year. For their other BME coursework, students may want to take Bioelectric Foundations (BME 2204), Biomechanics (BME 4504, cat II) and Biofluids (BME 4606, cat II). In consultation with their academic advisors, students might also consider coursework in tissue engineering at the graduate-level. These courses include Biomaterials in the Design of Medical Devices (BME 595B) and Tissue Engineering (BME/ME 550, cat II).

Other Engineering Courses: The majority of the engineering courses outside of the BME department should be taken in the ME or CHE department. Introduction to Material Science, Static Systems, and Stress Analysis, are fundamental courses for tissue engineers. In addition, students should consider the following courses:

- **Design and Characterization of Scaffolds for Bioengineered Tissues:** If interested in characterizing the mechanical properties of bioengineered tissues, Intro to Materials Science (ES 2001), Mechanical Behavior and Modeling Properties of Engineering Materials (ME 3023), Advanced Mechanics of Materials (ME 3502), and Chemistry, Properties and Processing of Plastics (ME 4821) are important. Fluid mechanics (ES 3004) and Continuum Mechanics (ME 3502) are also important fundamental courses if students plan to study the mechanical properties of biomaterials.
- **Bioreactor Design and Biotransport Characterization of Bioengineered Tissues:** If interested in characterizing the biotransport properties of bioreactors and engineered tissues Introduction to Thermodynamics (ES 3001), Mass Transfer (ES 3002), Heat Transfer (ES 3003) and Fluid Dynamics (ES 3004) are important core courses for tissue engineering.

Suggested Course Table and Sequence

Supplemental Science (Select two courses)

Select two from the following science courses below:

- BB 2901 – Molecular Biology, Microbiology, and Genetics
- BB 2902 – Enzymes, Proteins, and Purification
- BB 2903 – Anatomy and Physiology
- BB 3101 – Human Physiology: Movement and Communication
- BB 4008 – Cell Culture Theory and Application
- CH 2310 – Organic Chemistry I
- CH 4110 – Biochemistry I
- CH 4550 – Polymer Chemistry (cat. II)

Engineering (Select nine courses)

Select three fundamental engineering courses, preferred choices include:

- ES 2001 – Introduction to Materials Science
- ES 2501 – Introduction to Static Systems
- ES 2502 – Stress Analysis
- ES 2503 – Introduction to Dynamic Systems

Select two 3000-level (or higher) engineering courses, preferred choices include:

- ES 3001 – Introduction to Thermodynamics
- ES 3002 – Mass Transfer
- ES 3003 – Heat Transfer
- ES 3004 – Fluid Mechanics
- ME 3023 – Mechanical Behavior and Modeling properties of Engineering Materials
- ME 3502 – Advanced Mechanics of Materials
- ME 4821 – Chemistry, Properties and Processing of Plastics (cat. II)

Select four 3000- and 4000-level BME courses, preferred choices include: [Note #1]

- BME/ME 4606 – Biofluids (cat. II)
- BME/ME 4814 – Biomaterials
- BME 4828 – Biomaterials-Tissue Interactions
- BME/ME 550 – Tissue Engineering (cat. II)
- BME 595B – Biomaterials in the Design of Medical Devices

Note #1: At least 2 of the BME courses must be at the 4000-level or above. Graduate level courses can substitute for 4000-level courses.

PROJECT/RESEARCH AREAS

BIOMATERIALS/TISSUE ENGINEERING

Research focused on understanding the interactions between cells and precisely bioengineered scaffolds that modulate cellular functions such as adhesion, migration, proliferation, differentiation and extracellular matrix remodeling. Understanding cell-matrix interactions that regulate wound healing and tissue remodeling will be used to improve the design of tissue engineered analogs for the repair of soft and hard tissue injuries. Research areas include: 1) studies investigating the roles of micro-fabricated scaffolds on keratinocyte function for tissue engineering of skin 2) development of tissue scaffolds that mimic the microstructural organization and mechanical responsiveness of native tissues 3) development of microfabricated cell culture systems to understand how extracellular matrix molecules regulate epithelial cell growth and differentiation.

SOFT TISSUE BIOMECHANICS/ TISSUE ENGINEERING

Research focused on understanding the growth and development of connective tissues and on the influence of mechanical stimulation on cells in native and engineered three-dimensional constructs. Research areas include: 1) micromechanical characterization of tissues, 2) constitutive modeling, 3) creation of bioartificial tissues in vitro, and 4) the effects of mechanical stimulation on the functional properties of cells and tissues.

BIOMEDICAL SENSORS AND BIOINSTRUMENTATION

The development of integrated biomedical sensors for invasive and noninvasive blood gas and glucose monitoring. Design and in vivo evaluation of reflective pulse oximeter sensors. Microcomputer-based medical instrumentation, fiber-optic sensors for medical instrumentation, application of optics to biomedicine, physiological signal processing.

The development and testing of various invasive and noninvasive biosensors and associated bioinstrumentation. Noninvasive optical sensors for measuring glucose in diabetic individuals, urea in hemodialysis dialysate, other biochemical analytes, as well as reagentless chemistry measurements are being developed.

NUCLEAR MAGNETIC RESONANCE IMAGING AND SPECTROSCOPY

Research projects in nuclear magnetic resonance (NMR) imaging and spectroscopy stress experimental aspects of NMR and their application in both medical and non-biological areas. Major biological research projects include: (1) development of NMR imaging methods to delineate the "area of risk" following stroke and assess potential therapeutic intervention; and (2) development of non-invasive NMR methods for evaluating the response of neoplasms to radiotherapy and chemotherapy.

BACTERIAL ADHESION TO BIOMATERIALS

The mechanisms governing bacterial adhesion to teeth, contact lenses, and implanted or transdermal devices are poorly understood at this time. However, it is known that the presence of a biofilm on a biomaterial surface will lead to infection and cause an implanted device to fail. Often, removal of the device is the only option since microbes attached to a surface are highly resistant to antibiotics. Research in the laboratory is aimed at characterizing bacterial interaction forces and adhesion to biomaterials, using novel techniques to probe bacterial-surface interactions, in order to design materials that are resistant to microbial colonization.

BIOMECHANICS

Research involving the relationship between the applied stress and the response on neurons located in soft tissues as well as investigation in biotransport phenomena is being conducted at the University of Massachusetts Medical School. Flow-patterns at arterial stenosis are being investigated, and the influence of arteriosclerosis on vasculative and dynamic aortic compliance. Modeling gas transport

during high frequency ventilation. Heat and mass transfer in biological systems (and thermodynamic modeling). Evaluation of osteoarthritis and osteoporosis models. Elasticity and continuum mechanics measurements of tissues and their interface with engineered biomaterials as well as biofluid and biosolid interaction.

MEDICAL IMAGING

Contrast agents for nuclear medicine. Dose reduction using new detectors. Development of new detection devices for diagnostic radiology and nuclear medicine. Characterization of image intensifiers, radiation dosimetry. Tomographic image reconstruction; scatter and attenuation correction; restoration filtering; image segmentation.

SENSORY AND PHYSIOLOGIC SIGNAL PROCESSING

Application of signal processing, mathematical modeling and other electrical and computer engineering skills to the study of issues related to human sensation and physiology. Major areas of focus are vision, hearing, tactile reception, and electromyography (EMG). In the area of vision research, digitally produced pulse code modulated patterns that evoke multicolor sensations from black and white and monochromatic flicker patterns have been produced. Hearing research is concentrating on improved signal processing in hearing aid devices to improve speech perception by the hearing impaired. The purpose of the tactile receptor studies is to develop an understanding of the stimulus encoder characteristics of tactile mechanoreceptors. In the area of EMG (the electrical activity of skeletal muscle), improvements to the detection and interpretation of EMG for such uses as the control of powered prosthetic limbs and musculoskeletal modeling are continuing.

SPECTROSCOPIC MEASUREMENT OF BLOOD AND TISSUE CHEMISTRY

Applications of optical spectroscopy for the noninvasive measurement of blood and tissue chemistry, ultimately to be able to perform chemical analysis and diagnosis without removing a sample from the patient. Currently investigating the use of near infrared spectroscopy in combination with in-vivo chemometric techniques to determine tissue pH, blood hematocrit and electrolyte concentration. Also interested in the application of this technology in the triage and treatment of trauma patients and diagnosis of vulnerable plaque.

ULTRASOUND MEASUREMENTS

Applications under current investigation include detection of arteriosclerotic plaque and skin examination, for evaluating injuries, burns, and skin cancer. Several new research projects deal with the generation and application of coherent swept frequency signals for quantifying the medium (such as tissues) that is being examined. Doppler ultrasound is used for detection of motion, and the clinical applications include blood flow imaging and fetal heart rate monitoring. A Doppler project dealing with the detection of blood clots in the leg, a condition called deep vein thrombosis, is presently being carried out.

TEACHING LABORATORIES/FACILITIES

The following facilities are maintained by the Department of Biomedical Engineering to support teaching and project activities.

BIOINSTRUMENTATION AND BIOSIGNALS LABORATORY (SL 311)

This teaching laboratory provides the necessary equipment and supplies for the computer-based acquisition and processing of biological signals. It supports the laboratory component of our undergraduate-(BME 1001, BME 2204, BME 3011, and BME 4011) and graduate-level (BME 523, BME 525, and BME 551) biomedical engineering courses in bioinstrumentation, biosensors, and bioelectric signals and is also available for project activities and graduate-level research. The laboratory is equipped with digital multimeters, waveform generators, power supplies, oscilloscopes, and the necessary accessories, electronic components, and data books for effective and productive hardware project development.

BIOMECHANICAL ENGINEERING

LABORATORIES (Higgins First Floor) *Maintained in cooperation with Mechanical Engineering*

This laboratory complex provides experimental and computational facilities for the laboratory component of BME courses (BME/ME 4504, BME/ME 4606, and BME/ME 552), Major Qualifying Projects, and graduate research. Faculty associated with these facilities include Allen H. Hoffman, (ME, Lab Director), Brian J. Savilonis (ME), and Holly K. Ault (ME).

Included in this complex are the following individual laboratories:

BIOMECHANICS/BIOFLUIDS LABORATORY

(Higgins First Floor) provides experimental facilities in the areas of biomechanics and biofluids. The laboratory has equipment for measuring force, deformation, and kinematic variables as well as fluid flow, pressure, and velocity. The laboratory contains PC-based computational and data acquisition facilities.

REHABILITATION ENGINEERING LABORATORY

(Higgins First Floor) provides experimental facilities for the design, development, and testing of electro-mechanical assistive devices. The Assistive Technology Resource Center is part of this laboratory.

COMPUTING AND IMAGING FACILITY (SL 412)

This computing facility, maintained by the College Computer Center (CCC), contains network attached PC-based personal computers for use by BME students and the general WPI community. In addition, the facility houses computer-based imaging hardware and software to support our undergraduate- (BME 4011, BME 4201) and graduate-level (BME 551) biomedical engineering courses and projects in biomedical imaging and biomedical signal processing. Multimedia support for most types of traditional and electronic presentations and demonstrations is also available in this facility through the Academic Technology Center (ATC).

MQP/PROJECTS LABORATORY (SL 415)

Because project work is a significant component of a WPI education, the department maintains a dedicated laboratory for Major Qualifying Projects (MQPs), Interactive Qualifying Projects (IQPs), and independent projects. The facility contains network-attached PC-based personal computers, computer-based data acquisition systems, general electronic testing equipment, biomechanical and biomaterial testing equipment, and other common laboratory equipment and supplies with which to complete MQPs, IQPs, and independent projects.

PHYSIOLOGY TEACHING FACILITY (SL 313, SL 319)

This teaching facility supports our graduate-level (BME 562) biomedical engineering courses in experimental physiology and small animal surgery. The laboratory and associated animal holding quarters, contains all the necessary equipment and supplies for anesthesia, surgery, and physiologic manipulation in small animals.

CHEMICAL ENGINEERING

D. DIBIASIO, HEAD

PROFESSORS: R. Datta, A. G. Dixon, Y. H. Ma, R. W. Thompson

ASSOCIATE PROFESSORS: W. M. Clark, D. DiBiasio, N. K. Kazantzis

ASSISTANT PROFESSORS: T. A. Camesano, J. Wilcox, H. Zhou

RESEARCH ASSOCIATE PROFESSOR: I. Fishtik

RESEARCH ASSISTANT PROFESSORS: I. Mardilovich

ADJUNCT ASSISTANT PROFESSORS: H. W. Nowick, T. Starr, S. Kmiotek

MISSION

The Department of Chemical Engineering at WPI is dedicated to providing excellent education to undergraduate and graduate students in chemical engineering, and to vigorously pursuing discovery, creation, and dissemination of knowledge at the frontiers of chemical engineering. Chemical engineers are uniquely positioned to continue to contribute to the betterment of society through advancements in new materials, biomedicine, alternative energy, transportation, environmental pollution abatement, resource conservation, and sustainable development. The Department aspires to contribute to this vision by achieving national distinction in selected areas of scholarly inquiry and by educating men and women to become leaders in industrial practice, civil service, education, and research. The Department strives to produce technically competent and socially aware chemical engineers through project-based, innovative, and rigorous educational programs that promote global and societal awareness, innovative thinking, and life-long learning skills.

OBJECTIVES

The Chemical Engineering Department has established the following objectives of the undergraduate program in support of our mission and that of the Institute.

1. To educate students in the fundamental principles of chemical engineering.
2. To help students develop the ability to use chemical engineering principles to solve problems of practical importance to society.
3. To help prepare students, through broad education, for a lifetime of success as productive and informed members of society as well as of their professional community.
4. To help students become effective communicators.

OUTCOMES

The Chemical Engineering Department has established fifteen educational outcomes in support of our objectives. The outcomes are grouped under the objectives that they support.

Objective 1

- 1.1 Chemical engineering graduates will possess a working knowledge of the fundamentals of chemistry, physics, and mathematics, including knowledge of advanced elective science subjects such as organic and inorganic chemistry, material science, and biochemistry, etc.
- 1.2 Chemical engineering graduates will possess a working knowledge of conservation principles and their applications, physical and chemical equilibria, transport and rate processes, separation processes, chemical process control, and reaction engineering.

Objective 2

- 2.1 Chemical engineering graduates will be able to formulate, analyze, and solve practical chemical engineering problems.
- 2.2 Chemical engineering graduates will be able to design experiments, safely gather and analyze data, and apply the results to address practical chemical engineering problems.
- 2.3 Chemical engineering graduates will be able to use appropriate mathematical concepts and methods to solve chemical engineering problems.
- 2.4 Chemical engineering graduates will be able to design a chemical system, process, or component with consideration of realistic constraints including practical, economic, environmental, safety, ethical, social, and political implications.
- 2.5 Chemical engineering graduates will be able to use computers effectively for solving chemical engineering problems.

Objective 3

- 3.1 Chemical engineering graduates will be able to function and work effectively alone and in a team environment, including multidisciplinary teams.
- 3.2 Chemical engineering graduates will possess an appreciation of professional, ethical, and contemporary issues, and the societal and global impact of chemical engineering processes.
- 3.3 Chemical engineering graduates will possess self-learning skills to ensure life-long learning.

- 3.4 Chemical engineering graduates will possess an appreciation for the humanities and social sciences.
- 3.5 Chemical engineering graduates will be able to use their chemical engineering education to serve the chemical engineering profession or a related profession or pursue advanced studies.
- 3.6 Chemical engineering graduates will have selected technical elective courses, concentrations, projects, and minors that satisfy their professional interest or career goals.

Objective 4

- 4.1 Chemical engineering graduates will be able to write coherent, concise, and accurate technical reports.
- 4.2 Chemical engineering graduates will be able to make concise and effective oral presentations.

INTRODUCTION

Chemical engineers solve a wide variety of problems facing humanity by utilizing chemistry and engineering principles. Chemical engineers are vital to a broad range of material technologies such as plastic parts for automobiles, ceramic engine components, high-performance food packaging materials, nanotechnology, optoelectronic devices and modern construction materials. The fields of energy and transportation rely heavily on chemical engineering. Chemical engineers have been key contributors in the development of designer gasoline to meet new product performance and emission requirements; liquid fuels from natural gas, coal, shale; batteries with high energy density; and novel energy-conversion technology such as fuel cells and solar cells. Many technologies to improve public health depend significantly on chemical engineering such as biomaterials, biomedical devices, medical diagnostics, tissue engineering, the chemical synthesis of drugs, computer-aided drug design, the genetic engineering of therapeutic proteins, drug delivery systems and medical imaging technology. Finally, chemical engineering plays a dominant role in most environmental technologies. Examples are: atmospheric chemistry, product life cycle analysis, bioremediation, environmental risk and impact analysis, environmental friendly manufacturing technology and products, separation and conversion technologies for waste reduction and the cleanup of contaminated sites. Although the department strives to give all students a broad education, students can learn more in a given area of concentration by directing their course and project work to emphasize those areas.

Program Distribution Requirements for the Chemical Engineering Major

The normal period of residency at WPI is 16 terms. In addition to the WPI requirements applicable to all students (see page 21), students wishing to receive the ABET-accredited degree designated "Chemical Engineering" must satisfy certain distribution requirements. These requirements apply to 10 units of study in the areas of mathematics, basic science, engineering science and design, and 2 units of advanced chemistry as follows:

Requirements	Minimum Units
1. Mathematics and Basic Science (Notes 1, 2).	4
2. Engineering Science and Design (Notes 3, 4).	6
3. Advanced Chemistry (Note 5).	2

NOTES:

- Must include differential and integral calculus and differential equations.
- Must include 2 courses in physics.
- Must include 1 unit of MQP, 1/3 unit of capstone design experience (e.g. CHE 4404), and at least 1/3 unit of engineering study outside the major. Courses used to satisfy this requirement must be at the 2000-level or above, with the exception of CHE 1011.
- Must include at least 4 units from the following list of core chemical engineering courses: CHE 2011, CHE 2012, CHE 2013, CHE 2014, ES 3004, ES 3003, ES 3002, CHE 3201, CHE 3501, CHE 4401, CHE 4402, CHE 4403, CHE 4404, CHE 4405.
- All CH courses qualify except CH 1010, CH 1020, and CH 1030 which are basic science. Up to 1 unit of Advanced Chemistry may be double counted as both Advanced Chemistry and Basic Science. One course of Advanced Natural Science (2000 level and above BB, PH, GE) may be substituted for one Advanced Chemistry course.

CAPSTONE DESIGN REQUIREMENT

Students may elect to satisfy WPI's capstone design requirement in Chemical Engineering by either of two routes. The preferred manner for the student to satisfy this degree requirement is to successfully complete the design course, CHE 4404, which by its nature is the very essence of capstone design as described by the chemical engineering professional society, AIChE. Alternatively, at least 1/3 unit of the MQP may be designated as "capstone design." This option must be chosen at the time the student and the advisor agree to the content and scope of the project, and so noted on the student's project registration form.

CONCENTRATIONS FOR CHEMICAL ENGINEERING MAJORS

Chemical engineering majors may choose to focus their studies by obtaining one of the following Concentrations: Biochemical, Biomedical, Environmental, or Materials.

REQUIREMENTS

Concentrations within the Chemical Engineering Department comply with WPI's requirements for Concentrations. Students must complete an MQP and two units of integrated study in the area of their Concentration. The two units of study will include at least one unit of coursework from a designated list of courses for the Concentration^(a). The remaining one unit of work within the concentration area can be selected from additional courses from the designated list, or from the IQP, portions of the Sufficiency, or the Social Science requirement, when the course or project work supports a coherent and focused program of study in the subject area of the Concentration.

A coherent and focused program of study must be preapproved by the Department Program Review Committee. It is the student's responsibility to develop an integrated program that satisfies WPI's requirements and his/her own career aspirations. Therefore, students

CHEMICAL ENGINEERING SUGGESTED COURSE SEQUENCE

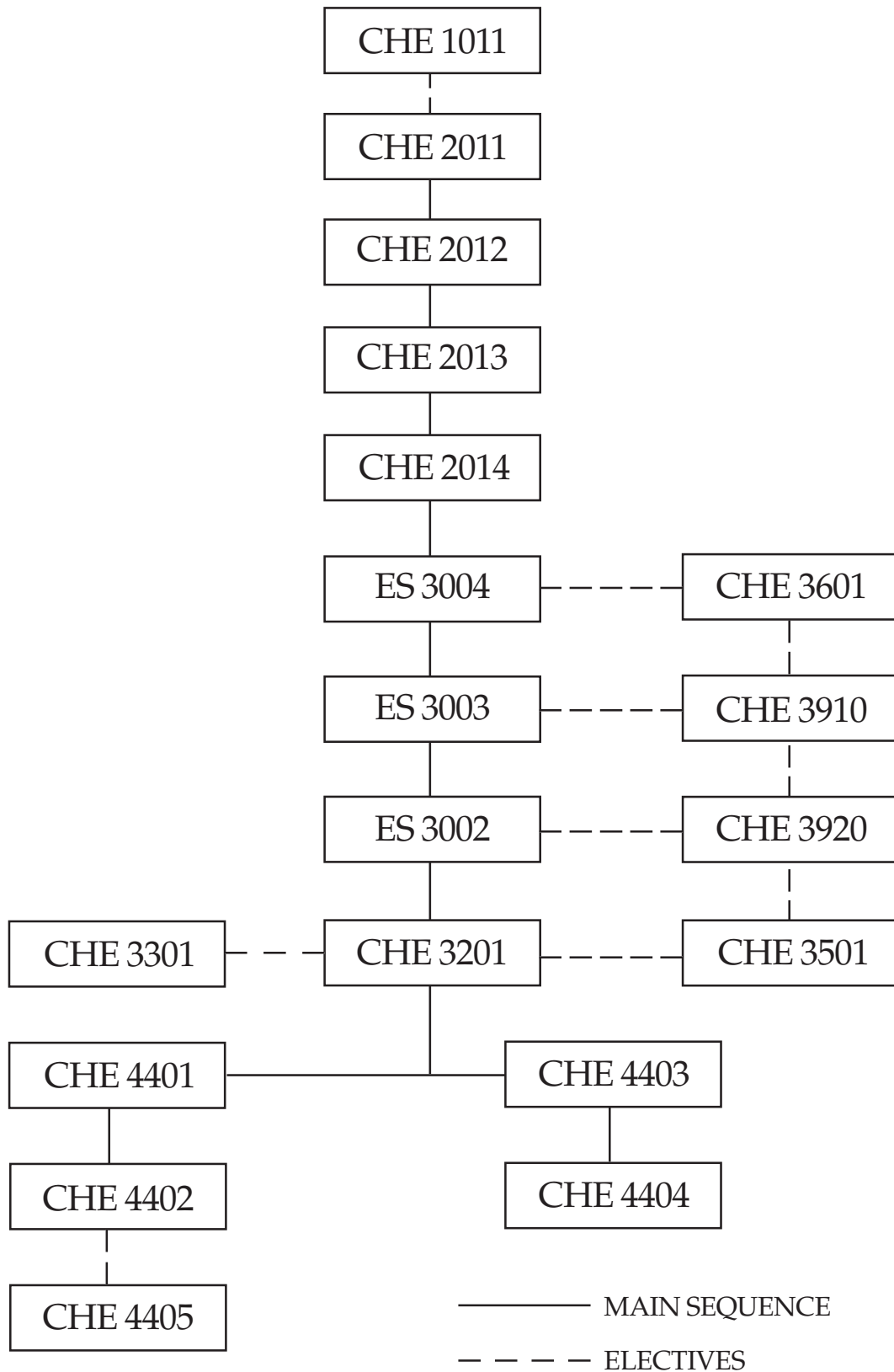

should plan their Concentration work with careful consultation of their Academic Advisor and the Program Review Committee. The Program Review Committee should be notified of plans for completing a Concentration before the student begins work on the Concentration. If IQP or Sufficiency work is to be used it must be certified as pertaining to the Concentration subject area by the IQP or Sufficiency advisor. The written certification should also state how many units (1/3, 2/3, or 1) the project advisor recommends be counted towards the Concentration.

- (a) Experimental CHE courses that emphasize the Concentration subject matter may also be used to fulfill this requirement. In special cases other courses may be approved by petition to the Program Review Committee.

DESIGNATED LISTS OF COURSES

For each Concentration a minimum of one unit of coursework must be selected from the lists of courses given below. Courses in these lists can also be counted as Basic Science, Advanced Chemistry, or Engineering Science and Design to fulfill distribution requirements as indicated. Students are also reminded that one course of Advanced Natural Science (2000 level and above PH, BB, or GE) may be substituted for one Advanced Chemistry course in meeting the department's distribution requirements. Some courses not on this list may be approved for a Concentration by petition to the Program Review Committee.

CHEMICAL ENGINEERING WITH BIOCHEMICAL CONCENTRATION

Basic Science:

Any BB course. No more than one 1000 level course may be counted, however. Recommended courses include:

- BB 2002 Microbiology
- BB 3055 Microbial Physiology
- BB 4008 Cell Culture Theory and Applications
- BB 4070 Separation of Biological Molecules
- BB 560 Separation of Biological Molecules

Engineering Science and Design:

- BB 509 Scale-Up of Bioprocessing
- CHE 3301 Introduction to Biological Engineering
- CHE 521 Biochemical Engineering
- BME 1001 Introduction to Biomedical Engineering

Advanced Chemistry:

- CH 4110 Biochemistry I
- CH 4120 Biochemistry II
- CH 4130 Biochemistry III
- BB 4910 Advanced Molecular Biology

CHEMICAL ENGINEERING WITH BIOMEDICAL CONCENTRATION

No more than one 1000-level course may be counted. Recommended courses include:

Basic Science:

- (at most, one of these three)
- BB 1030 Introduction to Biological Macro Molecules
 - BB 2550 Cell Biology
 - BB 2940 Experimental Biology I
 - BB 3102 Human Anatomy & Physiology: Transport and Maintenance
 - BB 4065 Virology

Engineering Science and Design:

- BME 1001 Introduction to Biomedical Engineering
- BME 2604 Foundations in Biological Transport Phenomena
- BME/ME 4504 Biomechanics
- BME/ME 4606 Biofluids
- BME/ME 4814 Biomaterials
- CHE 3301 Introduction to Biological Engineering

CHEMICAL ENGINEERING WITH ENVIRONMENTAL CONCENTRATION

Basic Science:

- GE 2341 Geology
- BB 2040 Principles of Ecology

Engineering Science and Design:

- CHE 3301 Introduction to Biological Engineering
 - CHE 3910 Chemical and Environmental Technology
 - CHE 3920 Air Quality Management
 - CHE 580 Transformation and Transport in the Environment
- (at most, one of these three)
- CE 3059 Environmental Engineering
 - CE 3070 Introduction to Urban and Environmental Planning
 - CE 3074 Environmental Analysis
 - CE 3060 Water Treatment
 - CE 3061 Wastewater Treatment
 - CE 4060 Environmental Engineering Lab.
 - CE 4061 Hydrology

CHEMICAL ENGINEERING WITH MATERIALS CONCENTRATION

Engineering science and design:

- CHE 3601 Chemical Materials Engineering
- ES 2001 Introduction to Material Science
- CHE 508 Catalysis and Surface Science of Materials
- ME 2820 Materials Processing
- ME 3811 Microstructure Analysis and Control
- ME 4813 Ceramics
- ME 4814 Biomaterials
- ME 4821 Chemistry, Properties, and Processing of Plastics
- ME 4840 Physical Metallurgy
- ME 4850 Solid State Thermodynamics

Advanced chemistry:

- CH 4550 Polymer Chemistry

MAJOR SUB-AREAS WITHIN DEPARTMENT

The sub-areas normally available are closely tied to the research programs pursued by the faculty. Undergraduates can become involved in these areas to the extent they desire by properly selecting MQPs and by pursuing advanced courses or IS/Ps. The main areas of research are:

- Bioengineering
- Chemical Kinetics, Catalysis, and Reaction Engineering
- Environmental Engineering
- Material Science and Engineering

RECOMMENDED PROGRAM

Students who select chemical engineering or related fields will progress through the chemical engineering sequence as shown in the chart on page 95: first, by becoming familiar with the chemical engineering fundamentals; second, by studying the engineering sciences; and third, by becoming involved in chemical engineering design. In addition, specialized science and technology studies are recommended. This progress can be achieved by judicious selection of courses, projects, and IS/Ps.

In all program planning, students should work closely with their academic advisors not only to fulfill their personal interests, but to provide a sound professional background for a successful career in chemical engineering.

RELATED COURSES

Courses are offered either by the department faculty (CHE) or by the engineering faculty under the Engineering Science (ES) label to provide the necessary background in each of the areas indicated.

PROJECT OPPORTUNITIES

Projects available to the chemical engineering student are of the widest possible variety. Projects may be of the research type (as would be encountered in graduate school) or of a more developmental, industrial nature.

Nonexperimental design projects or theoretical projects are also available. They are available on campus, sometimes with graduate students working on sponsored research; in off-campus governmental laboratories; or in industry, as well as overseas.

Areas of specialization in the department currently are:

Adsorption	Kinetics
Biochemical Engineering	Mass Transfer
Biofilms	Materials Synthesis
Biominiaturization	Microfluidics
Bioremediation	Molecular Modeling
Biosensors	Process Dynamics,
Biotechnology	Supervision and Control
Catalysis	Reaction Engineering
Diffusion	Scientific Computing
Drug Delivery	Separation Processes
Fuel Cells	Thermodynamics
Hydrogen Technology	Water Remediation
Inorganic Membranes	Zeolites

CHEMISTRY AND BIOCHEMISTRY**J. W. PAVLIK, INTERIM HEAD**

PROFESSORS: R.E. Connors, J.P. Dittami, W.G. McGimpsey, J.W. Pavlik, A.A. Scala, C. Sotak
ASSOCIATE PROFESSORS: J.M. Arguello, K.N. Wobbe
ASSISTANT PROFESSORS: J.C. MacDonald, V. Thalladi
RESEARCH PROFESSOR OF CHEMISTRY: L.H. Berka

MISSION STATEMENT

Through dynamic and innovative classroom instruction and exciting cutting edge research programs, the Department of Chemistry and Biochemistry strives to provide students with both a broad understanding of the fundamentals of the chemical sciences and an opportunity to create new chemical and biochemical knowledge through original research. We aspire to produce graduates who will enter their scientific careers with the confidence and competence to lead the advance of chemistry and biochemistry in the 21st century.

PROGRAM EDUCATIONAL OBJECTIVES

The Department of Chemistry and Biochemistry will graduate outstanding professionals possessing fundamental knowledge of the chemical sciences. Graduates will be able to apply this knowledge to the solution of problems in chemistry and biochemistry for the advancement of knowledge in these fields and the improvement of the standard of living of all humanity.

EDUCATIONAL OUTCOMES

Students graduating with a major in Chemistry or Biochemistry will be able to demonstrate an ability to

- perform accurate and precise quantitative measurements
- use and understand modern instruments, particularly NMR, IR, and UV-vis spectrometers, chromatographs, electrochemical instruments, and lab computers
- keep legible and complete experimental records
- analyze data statistically and assess reliability of results
- anticipate, recognize, and respond properly to hazards of chemical manipulations
- interpret experimental results and draw reasonable conclusions
- plan and execute experiments through use of the literature
- design experiments
- communicate effectively through oral and written reports
- critically assess their work for reasonableness and self-consistency
- achieve high ethical standards
- learn independently

OVERVIEW

Students in the Department of Chemistry and Biochemistry (CBC) may major in either *chemistry* or *biochemistry*. Chemistry is concerned with the structure and transformations of matter, the design and synthesis of new substances, and the potential applications of these substances. Biochemistry is concerned with understanding the chemistry of life at the molecular level. Both disciplines create new knowledge that benefits humanity in countless ways. CBC is deeply committed to the advancement of knowledge through the research programs of its faculty. The department is also strongly committed to the communication of this knowledge to its major students and to students in other majors requiring a strong foundation in chemistry. Via its program of major qualifying projects, CBC enables its undergraduate majors to take part in this exciting activity of developing new scientific knowledge at the same time that they are learning the ideas and concepts that allow rationalization of this knowledge at the atomic/molecular level of matter.

It is an exciting time to be a chemist or biochemist. Chemists are becoming adept at creating and manipulating new molecules to achieve desired ends. The blossoming area of nanoscale technology depends directly on the ability of the chemist to create molecules that function in a specific mechanical or electrical way. Molecules can be designed to have one shape under some circumstances and a different shape in others. This suggests the "on" or "off" type application needed in computer memory design. Molecules called carbon nanotubes have been designed that function as molecular wires. Even DNA, the molecule of heredity, has been shown by a chemist to function as a molecular wire. Chemists are now able to design and synthesize in the laboratory molecules that serve as medicines and/or drugs. Further, they can carry out "design changes" on existing medicines or drugs that

result in even more effective agents. Chemists can use lasers and coupled spectroscopic methods to “photograph” movements of atoms in individual molecules that occur in less than 1 femtosecond (10^{-15} s). Thus the possibilities for exciting research in today’s chemistry laboratory are almost limitless.

At the same time, biochemists have made tremendous advances in understanding the molecular basis for life since the elucidation of the molecular structure of DNA in 1953. Using modern biochemical tools such as restriction enzymes, PCR (polymerase chain reaction) and cloning, biochemists are well on the way to determining the entire human genome (that is, identifying all of the genes present in human chromosomes, and the proteins that these genes encode). Detailed structures of the active sites of enzymes have enabled biochemists to understand the mechanisms by which these fascinating molecules catalyze specific chemical reactions. These studies have in turn made it possible to use enzymes as catalysts for industrial processes. In addition, the biochemist is particularly concerned with the compartmentation of functions within and between cells. Understanding the structure of the molecular receptors for hormones and neurotransmitters, and of the molecular complexes involved in physiological signal transduction is key to the design of modern drugs. Progress in biochemistry in the last half of the 20th century was remarkable; it will only get better in the 21st.

BIOCHEMISTRY

Biochemistry is a major for students who wish to work at the interfaces of biology, chemistry and medicine. Biochemists seek to understand at the molecular level the complex chemical structures and accompanying reactions that determine biological processes such as metabolism, reproduction and growth, and their regulation through chemical messenger-receptor interactions in the immune, endocrine and nervous systems. The distribution requirements represent a balance between chemistry and biology, and between lecture and laboratory, while the overall program develops the distinct professional perspective needed to bridge molecular science to physiology.

Students who graduate with a degree in Biochemistry are well qualified for positions as professional biochemists in the pharmaceutical industry and large hospitals in areas such as drug-receptor research, bioanalytical chemistry and drug metabolism, and in the biotechnology field in jobs dealing with protein isolation, purification and modification for medical use, as well as in a variety of other employment opportunities. The program also provides excellent preparation for those who intend to further their studies in Biochemistry or related fields (e.g. Pharmacology or Immunology) at the graduate level.

Since Biochemistry embodies in its distribution requirements all the technical courses needed for admission to medical, dental and veterinary schools, it is the major of choice for prehealth professionals.

Major Qualifying Projects may be carried out under the direction of a member of the Department of Chemistry and Biochemistry or any one of the Associated Faculty listed below; see their respective department descriptions for further details. MQP opportunities are also available at research centers such as the University of Massachusetts Medical Center and Tufts University School of Veterinary Medicine.

Program Distribution Requirements for the Biochemistry Major

In addition to the WPI requirements applicable to all students (see page 21), students wishing to graduate with a degree in biochemistry must meet the *distribution requirements* detailed below.

Requirements	Minimum Units
1. Mathematics and Physics (Note 1).	2
2. Chemistry and Biochemistry (Note 2).	4
3. Biology (Note 3).	1 2/3
4. Chemistry and Biochemistry / Biology Laboratory (Note 4).	1
5. Other Natural or Computer Science (Note 5).	1/3
6. MQP	1

Notes:

- The mathematics in MA 1021-MA 1024 or the equivalent is recommended. The physics in PH 1110-PH 1120 or equivalent is recommended.
- These four units must include one unit of organic, one unit of biochemistry, and 1/3 unit each of physical (3000 level or higher) and inorganic chemistry (3000 level or higher).
- These 1 2/3 units must include 1/3 unit of cell biology, 1/3 unit of genetics, and 2/3 unit of advanced work (3000 level or higher).
- This unit must include a minimum of 1/3 unit in Chemistry and Biochemistry, and a minimum of 1/3 unit in Biology.
- Any course in the natural sciences (not used to satisfy another requirement) or in computer science may be used to satisfy this requirement.

RECOMMENDATIONS FOR STUDENTS

A typical Biochemistry curriculum is given below.

Premedical students should take three terms of Physics, as well as one of the Organic Chemistry Laboratories (CH 2360 or CH 2660), by the end of their third year. BB 1001 (Term B) is recommended as the initial course for students who need to strengthen their background in biology. Note that a total of one unit designated Elective in the table must be in Biology.

Students should take 1/3 unit of advanced Biology laboratory (BB 3512, 3518, 3519, 3520 are recommended) at their discretion as to the term; however, this should preferably be done before the MQP is commenced.

Year	Term A	Term B	Term C	Term D
First	CH 1010 BB 2550 MA	CH 1020 HU MA	CH 1030 BB 2920 MA	CH 1040 HU MA
Second	CH 3510 PH HU	CH 2310 PH HU	CH 2320 CH 2660 HU	CH 2330 SS HU
Third	CH 4110 BB Lab SS	CH 4120 Elective IQP	CH 4130 CH 3410 IQP	CH 4150 Elective IQP
Fourth	Elective MQP Elective	Elective MQP Elective	CH 4160 MQP Elective	CH 4190 MQP Elective

ASSOCIATED BIOCHEMISTRY FACULTY

D. S. Adams (BB), J. C. Bagshaw (BB), T. C. Crusberg (BB),
G. D. J. Phillis (PH), S. M. Politz (BB), J. Rulfs (BB),
E. Ryder (BB), P. J. Weathers (BB).

CHEMISTRY

Chemistry is a fundamental science concerned with discovering new knowledge about the structure, properties, and reactivities of existing forms of matter; and with the creation of new forms of matter by manipulating atoms and molecules in the laboratory. The ability of chemists to actually make new substances distinguishes chemistry from any other science, in which the practitioners are limited to studying what is already there. The knowledge created by fundamental scientific study allows us to understand our world better and to make it a more hospitable place in which to live.

In addition to its intrinsic value, chemistry is central to other areas of human endeavor, including materials science and engineering, biology, medicine, electronics, law enforcement, and even psychology. Chemistry is inherently experimental, but experiments are performed within a theoretical framework that enables interpretation of experimental results and points the way to new, fruitful areas for investigation.

Many careers are available to a chemistry graduate. Some elect to pursue an advanced degree in graduate school, medical school, veterinary school, or law school. Others decide to seek employment in industry, government, or health care. Still others may choose to pursue a teaching career. Chemistry provides an exceptionally good background for a wide variety of careers not traditionally associated with chemistry, but in which the expertise and thinking patterns of the chemist may be applicable. Examples include oceanography, environmental control, materials science, biology, biomedical engineering, mental health, and patent law. A high percentage of WPI chemistry graduates seek advanced degrees at prestigious graduate schools nationwide, while others pursue careers in many of the areas mentioned above.

Program Distribution Requirements for the Chemistry Major

In addition to the WPI requirements applicable to all students (see page 21), students wishing to graduate with a degree in chemistry must meet the *distribution requirements* detailed below.

Requirements	Minimum Units
1. Mathematics and Physics (Note 1).	2 1/3
2. Chemistry (Note 2).	4
3. Additional Science/Engineering (Note 3).	3 2/3

Notes:

- Must include differential and integral calculus and at least 2/3 units of physics.
- Must be above the level of general chemistry (2000 level or higher). These 4 units must include courses in experimental chemistry (either 4/3 unit or 3/3 unit), inorganic chemistry (1/3 unit), organic chemistry (3/3 unit), physical chemistry (3/3 unit), and biochemistry (either 1/3 unit or 2/3 unit, depending on the number of experimental chemistry courses taken). At least 2/3 units must be at or higher than the 4000 level.
- Distributed among the MQP, the natural and physical sciences, computer science, mathematics, and engineering (and including general chemistry, CH 1010-1040).

PREVIOUS DISTRIBUTION REQUIREMENTS FOR CHEMISTRY

The above distribution requirements apply to all students whose matriculation date is after May 1, 2004. Students who matriculated prior to May 1, 2004, should consult the catalog for their year of entry or the Chair of the Chemistry Distribution Review Committee.

The Distribution requirements provided above constitute the minimum coursework necessary to achieve a degree in chemistry. Additional courses are necessary to be eligible for American Chemical Society (ACS) certification. The following section provides detailed recommendations for certified degrees in chemistry.

RECOMMENDATIONS FOR STUDENTS

Chemistry utilizes many of the concepts of physics and the tools of mathematics. Thus students should acquire a background in these subjects early in their programs. The material addressed in MA 1021 through MA 1024 is recommended for all chemistry majors. Students will also benefit from knowledge of differential equations, as discussed in MA 2051. Physics background should include mechanics, and electricity and magnetism. Either the PH 1110-1120 or the PH 1111-1121 sequence is recommended. Students seeking more depth in physics are advised to pursue PH 1130 and PH 1140.

The subject matter of chemistry was traditionally divided into the areas of inorganic, organic, physical, and analytical chemistry to aid in the organization and presentation of the subject. Although burgeoning knowledge in and applications of chemistry have made this system of compartmentalization largely obsolete in the research sphere, courses in chemistry are still organized by this older system. Every chemist should have a sound background in each of these traditional areas precisely because new directions in chemistry require an ever-broader grasp of physical and chemical principles. In addition,

because chemistry is an experimental (i.e., laboratory-driven) science, familiarity with laboratory operations is essential for understanding the subject matter and for developing the practical skills needed for project work and for the pursuit of further education or a career. Four laboratory courses are designed to fulfill this need. It is strongly recommended that they be taken in the second year to provide the basis for project work in the remaining years. Finally, basic knowledge of biochemistry is considered essential.

AMERICAN CHEMICAL SOCIETY APPROVAL AND CERTIFICATION

The Department of Chemistry and Biochemistry has an American Chemical Society (ACS) approved program. Thus graduates who complete programs satisfying the ACS recommendations have their degrees *certified to the society* by the department. Accordingly, students can earn an "ACS-Certified Degree in Chemistry" or an "ACS-Certified Degree in Chemistry with a Biochemistry Option."

ACS-Certified graduates are eligible for immediate membership in the ACS and thus are able to secure the benefits of membership, which include helpful services such as finding employment.

ACS-CERTIFIED DEGREE IN CHEMISTRY

The following sequence of courses, recommended to provide fundamental background in chemistry, will result in an ACS-certified degree in chemistry. Specialization in particular areas of interest is best accomplished via additional courses and projects, generally taken in the third and fourth years.

Recommended CBC Courses for an ACS-Certified Degree in Chemistry

Year	Term A	Term B	Term C	Term D
First	CH 1010	CH 1020	CH 1030	CH 1040
Second	CH 2640 (lab) CH 3510 (phys)	CH 2650 (lab) CH 2310 (org)	CH 2660 (lab) CH 2320 (org)	CH 2670 (lab) CH 2330 (org)
Third		CH 3550 (phys)	CH 3410 (inorg) CH 3530 (phys)	
Fourth	CH 4110 (bioch)			CH 4420 (inorg)*

*Because this course is offered every other year, some students may have to take it in Term D of the third year. Students can still earn a chemistry degree without taking CH 4420. However, to obtain ACS Certification this course, along with the others shown, must be completed.

Students seeking certification should plan to study calculus through multivariate analysis (MA 1021-1024), differential equations (MA 2051) and linear algebra (MA 2071), and should take a minimum of two course in physics (for example, PH 1111 and 1121).

ACS-CERTIFIED DEGREE IN CHEMISTRY WITH A BIOCHEMISTRY OPTION

Students seeking the ACS-Certified Degree with Biochemistry Option must complete the following work in addition to those requirements noted above for an ACS-Certified Degree in Chemistry.

- Three semester hours (1/3 unit) of biology which contains cell biology, microbiology or genetics.
- Six semester hours (2/3) of biochemistry that has organic chemistry as a prerequisite.
- One semester of a laboratory in biochemical methods.
- Research in biochemistry culminating in a comprehensive written report is highly recommended.

CONCENTRATION IN MEDICINAL CHEMISTRY

Medicinal Chemistry is the application of principles of biology and chemistry to the rational design and synthesis of new drugs for treatment of disease. A medicinal chemist applies knowledge of chemistry, biochemistry and physiology to generate solutions to health-related problems.

A concentration in medicinal chemistry is excellent preparation for students interested in entering health related professions, such as the pharmaceutical industry, upon graduation. Possible employment positions are numerous and expected to increase in the future.

Course Requirements

In order to be eligible to receive the Medicinal Chemistry designation on their transcripts, chemistry majors need to satisfy the following course requirements:

- Three biomedically oriented courses selected from the following list must be included in the distribution requirements:
 - CH 4110 Biochemistry I
 - CH 4120 Biochemistry II
 - CH 4130 Biochemistry III
 - BB 4910 Advanced Molecular Biology
 - BB 4955 Recombinant DNA Principles and Applications
 - CH 539 Molecular Pharmacology
- Three courses oriented toward structure, synthesis, or mechanisms selected from the following list must be included in the distribution requirements. (All graduate courses in chemistry are open to undergraduates.)
 - CH 4330 Organic Synthesis
 - CH 516 Chemical Spectroscopy
 - CH 533 Physical Organic Chemistry
 - CH 538 Medicinal Chemistry
 - CH 554 Molecular Modeling
- In addition to the above course requirements, chemistry majors must complete an MQP in the medicinal chemistry area, approved by the Program Coordinator. Examples of available projects are:
 - Synthesis of huperzine analogs. New acetylcholinesterase inhibitors for treatment of Alzheimer's.
 - Synthesis of opiate analogs.
 - Synthesis and testing of compounds that influence transport properties of biological membranes.

PROJECT ACTIVITY

A student undertaking a Major Qualifying Project in chemistry and biochemistry chooses a faculty advisor in the department with whom to work. This choice is normally made because the student is interested in the research program directed by the faculty member, and wants to become a part of this activity. The student is given a research problem to work on for a minimum of 20

hours a week for 3 terms. Although most MQP projects in chemistry and biochemistry are individual student efforts, team projects involving up to 3 students are occasionally available, depending on the faculty member concerned. The project culminates in a formal written MQP report and a poster session presentation to the department faculty and students. MQP projects in chemistry and biochemistry require a substantial effort from the student in both the laboratory and writing phases. Many projects result in professional publications and/or presentations at professional meetings. The department offers a variety of areas of specialization (see AREAS OF SPECIALIZATION IN CHEMISTRY AND BIOCHEMISTRY below) in which Major Qualifying Projects may be carried out.

Some students, particularly those in biochemistry, choose to do their MQPs at off-campus laboratories. Biochemistry projects have recently been completed at the University of Massachusetts Medical Center and Tufts University School of Veterinary Medicine.

Faculty in the department of chemistry and biochemistry participate in a range of IQP activities involving students from all disciplines. Some recent examples of IQPs supervised by chemistry and biochemistry faculty include

- Soviet science fiction
- Teaching science in the public schools
- Physical environment, human thought, and creativity
- Heavy metal pollution in the Nashua River
- Health effects of radon in Worcester
- Nanotechnology and society

IQP activities are administered through the Projects & Registrar's Office.

INFORMATION FOR NONMAJORS

Chemistry is often called the "central science" because it underlies so much of human activity. Some fundamental understanding of the central science is essential for anyone planning a career in science or technology. The four-course sequence CH 1010-1040 is recommended to provide this fundamental background.

Students interested in physics, chemical engineering, biology, biotechnology, biomedical engineering, medicine, or veterinary science should take more advanced courses in chemistry. The sequence of organic chemistry courses, CH 2310-2330 and CH 2360 (laboratory) provides essential background for biology, biotechnology, plastics, and polymer science. Students planning to attend medical school must take CH 2310, CH 2320, and CH 2360 to satisfy medical school entrance requirements.

Other advanced chemistry and biochemistry courses may be appropriate for particular areas of interest. Students should seek advice from their academic advisors and the chemistry/biochemistry faculty.

AREAS OF SPECIALIZATION IN CHEMISTRY AND BIOCHEMISTRY

Computational Chemistry and Molecular Modeling
Forensic Studies
Gene Regulation
Ion Transport
Materials
Medicinal Chemistry
Membrane Proteins

Molecular Spectroscopy
Nanoscale Design
Natural Products Synthesis
Plant-Virus Biochemistry
Photochemistry
Photophysics
Sensors
Supramolecular Chemistry

CIVIL AND ENVIRONMENTAL ENGINEERING

F. L. HART, HEAD

PROFESSORS: T. El-Korchi, F. L. Hart,

J. C. O'Shaughnessy

ASSOCIATE PROFESSORS: L. D. Albano,

M. S. FitzPatrick, P. Jayachandran, R. Mallick,

P. P. Mathisen, R. Pietroforte, J. Plummer, M. Ray,

G. F. Salazar

ASSISTANT PROFESSOR: J. Bergendahl

MISSION STATEMENT

The Civil and Environmental Engineering program at WPI prepares graduates for careers in civil engineering, emphasizing professional practice, civic contributions, and leadership, sustained by active life-long learning. The curriculum combines project based learning environment with a broad background in the fundamental principles of civil engineering. Students have the flexibility to explore various civil engineering disciplines and career opportunities.

EDUCATIONAL OBJECTIVES

1. A graduate should be able to apply the fundamental principles of mathematics, science, and civil engineering to analyze and design a component, process or system.
2. A graduate should have the interpersonal and communication skills, an understanding of ethical responsibility, and a professional attitude necessary for a successful engineering career.
3. A graduate should have the ability to engage in life-long learning.
4. A graduate should have an appreciation for the interrelationships among basic knowledge, technology, and society.

CEE PROGRAM OUTCOMES

1. Preparation for engineering practice, including the technical, professional, and ethical components.
2. Preparation for the future changes in civil engineering.
3. A solid understanding of the basic principles of civil engineering
4. An understanding of appropriate scientific concepts, and an ability to apply them to civil engineering.
5. An understanding of the engineering design process and an ability to perform engineering design, which includes the multidisciplinary aspects of the engineering design process, the need for collaboration and communications skills, plus the importance of cost and time management.

6. Demonstration of an ability to set up experiments, gather and analyze data, and apply the data to practical engineering problems.
7. Demonstration of in-depth understanding of at least one specialty within civil engineering.
8. Understanding of options for careers and further education, and the educational preparation necessary to pursue those options.
9. An ability to learn independently.
10. The broad education envisioned by the WPI Plan, and described by the Goal and Mission of WPI.
11. An understanding of civil engineering profession in a societal and global context.

INTRODUCTION

The major designated as "Civil Engineering" is the only program accredited by the Accreditation Board for Engineering and Technology (ABET) within the Department of Civil Engineering.

The broad range of work in civil and environmental engineering practice allows an individual to contribute professionally in a variety of different ways. On the one hand, the engineer may be involved in the broad scope of planning and managing the successful completion of a complex project that benefits our society. Examples of these types of projects include water resources and facilities; wastewater treatment facilities; hazardous or solid waste disposal systems; site design; buildings of all types; or transportation systems, such as highways and bridges, tunnels, mass transportation, airports, or harbor facilities. On the other hand, the engineer may wish to specialize and become expert in the professional activities associated with one of the many subdisciplines, such as structural engineering, environmental engineering, transportation engineering, geotechnical engineering, or materials engineering.

You have enormous flexibility in defining your educational program at WPI, and academic planning is one of the more important activities in which you will engage. With some limitations, you may specialize in one area, or you may develop a broad educational program that involves several subdisciplines. For most students, it is important to develop a program that has a broad overall structure, and, at the same time, has the flexibility to be modified with little disruption as conditions and your growth in understanding evolve. You should work closely with your advisors to develop a program that meets WPI and ABET professional requirements, while at the same time meeting your objectives and providing opportunities for explorations and educational expansion.

In developing your educational program, it is possible, and often desirable, to construct a general civil engineering program with focus on two or more of the subdisciplines. This type of program allows maximum flexibility and employment opportunities upon graduation. It also is possible to develop a program that provides a concentration of studies in one subdiscipline with minimal breadth in related subdisciplines. Each of these types of goals has advantages and limitations from both professional and educational viewpoints. The Civil and Environmental Engineering Department advisors can provide you with a document that provides guidance and sample programs within the context of WPI and ABET requirements.

The professional career opportunities for civil engineers are many and broadly varying. Normally, it is valuable to become a registered professional engineer as early in a career as possible. The usual route to becoming a registered professional engineer involves (a) obtaining a degree from an ABET-accredited program; (b) passing the Fundamentals of Engineering Examination (FEE); (c) acquiring the necessary amount of professional level engineering experience; and (d) passing the professional engineers examination of the appropriate state licensing board. One can get the ABET accredited program in civil engineering at WPI. It is recommended that you take the Fundamentals of Engineering Examination (FEE) during the last year at WPI. This educational background should prepare you for the entry level engineering work necessary to complete the other professional registration requirements.

It is possible to enter the professional work force after receiving the BS degree. An additional opportunity that should be considered sometime before the final year is the integration of the BS with a MS degree. These degrees can be earned with five complete academic years of education. It is becoming more common to consider the MS degree as the first professional degree. Individuals who have recognized career objectives should consider this opportunity. The integration allows both graduate and undergraduate courses to be incorporated into the programs with possible reductions in costs and time. It is also possible, of course, to obtain advanced degrees in civil engineering specialty disciplines or in other fields concurrently with professional employment through a continuing education program.

Program Distribution Requirements for the Civil Engineering Major

The normal period of undergraduate residency at WPI is 16 terms. In addition to the WPI requirements applicable to all students (see page 21), students wishing to receive the ABET-accredited degree designated "Civil Engineering" must satisfy certain distribution units of study in the areas of mathematics, basic science, and engineering science and design as follows:

Requirements	Minimum Units
1. Mathematics and Basic Science (Notes 1,2).	4
2. Engineering Science and Design (including the MQP) (Note 3,4,5,6).*	6

Notes:

1. Mathematics must include differential and integral calculus, differential equations, and probability and statistics.
2. Must include both chemistry and physics with a minimum of one course in physics and two courses in chemistry.
3. A minimum of 4 units of work must be within the Civil Engineering area. All CE courses including the MQP, ES 2503, and ES 3004 are acceptable within the Civil Engineering area.
4. The curriculum must include at least one engineering science course outside the major discipline area. Courses acceptable to satisfy the requirement of outside-of-discipline course are those taught in other engineering departments. The course must be 2000-level or above and cannot include ES 2501, ES 2502, ES 2503, and ES 3004.

5. All students are required to include an appropriate laboratory experience as part of their overall program. This experience can be met by the completion of two undergraduate CE lab courses, selected from among the following: CE 2020, CE 3024, CE 3026, CE 3054, CE 4046, and CE 4060. Alternately, an appropriate laboratory experience could also be accomplished by a student through careful planning of course, project and laboratory work and approval by petition through the Department Program Review Committee.
6. Must include 1/3 unit of Capstone Design Experience.

RECOMMENDED FUNDAMENTAL BACKGROUND

MATHEMATICS AND BASIC SCIENCE

It is essential that civil engineering students be well grounded in mathematics, the basic language of all engineers. For students with a normal secondary school background, the following courses should be taken: MA 1021, MA 1022, MA 1023, MA 2051 and MA 2611. At least one, and preferably several additional courses are valuable to a civil engineering education and may be selected from the following courses, depending upon the student's interests: MA 2210, or MA 2071. MA 2210, Mathematical Methods in Decision Making, in particular, is useful in working with civil engineering systems. As students progress and begin to develop a keen interest in a specific area of civil engineering, they should be prepared to seek additional mathematical support for advanced-level work. Advanced placement from high school, properly included in the WPI transcript, will be given appropriate credit.

A background in basic sciences is required. The student must include both physics and chemistry with a minimum of one course in physics and two courses in chemistry. Possible basic science courses are PH 1110, PH 1120, PH 1130, CH 1010, CH 1020, CH 1030, CH 1040, GE 2341, BB 1001 and BB 2002. Advanced placement from high school, properly included in the WPI transcript, will be given appropriate credit.

ENGINEERING SCIENCE AND DESIGN

Engineering sciences have their roots in mathematics and basic sciences, but carry knowledge further toward creative application. Courses in engineering science provide a bridge between basic science and engineering practice. A student should select the engineering sciences that are appropriate for advanced professional design courses, and then fill out any additional requirements of engineering science with electives that provide a broad base for engineering practice. Consideration should be given to those engineering sciences required for the Fundamentals of Engineering Examination (FEE). At least one course must be from outside of the major area. Please note that ES 2503 and ES 3004 are regarded as civil engineering courses, and are an important part of the FEE examination. The engineering science requirement can be met by selecting a combination of courses from several disciplines. A partial listing of applicable courses from other disciplines that are useful for civil and environmental engineering students includes ES 3001, ECE 3601, and FP 3070. Civil engineering courses that are considered engineering science include: CE 2000, CE 2001, CE 2002, CE 2020, CE 3024, CE 3026, CE 3041, and CE 4007. In addition, other courses designated CE have a significant engi-

neering science component. Students can obtain information on these courses in consultation with their academic advisors.

Engineering design is the process of devising a system, component or process to meet desired needs. It is a decision-making process (often iterative) to convert resources to meet a stated objective. Among the fundamental elements of the design process are the establishment of objectives and criteria, synthesis, analysis, construction, testing, and evaluation. With the exception of those CE courses designated engineering science, all other CE courses are design courses or have a significant design component. Students can obtain information on these courses in consultation with their academic advisor. At least two units of engineering design consisting of appropriate civil engineering courses and the MQP are required as part of the ABET six-unit engineering science and design distribution requirement.

SUBAREAS OF CIVIL ENGINEERING

STRUCTURAL AND GEOTECHNICAL ENGINEERING

The practice of structural engineering involves the analysis and design of buildings, bridges and other structures which are generally a part of all civil engineering systems. Geotechnical engineering encompasses a broad spectrum of interests including the design, analysis and construction of foundations for buildings and other structures, highway embankments, dams and waste containment facilities. It also considers tunnels, ground water development and engineering in the ocean environment.

An educational program leading to preparation for a career in structural and geotechnical engineering must necessarily include in-depth studies in the basic sciences, mechanics of materials, structural analysis, and design, computer applications, and engineering properties of construction materials. The important courses in this area are CE 2002, CE 3010, CE 3006, CE 3008, CE 3044, CE 3026, CE 4046, CE 4048 and CE 4007. Structures generally are a part of large engineering projects and systems. A valuable component of an engineering education involves the interface with other engineering areas. Knowledge of subject matter contained in CE 3020, CE 3059, CE 3050 and CE 3070 is useful for the structural or geotechnical engineer. Major Qualifying Projects in this field often focus primarily on either structural or geotechnical aspects, although many projects integrate the two areas, in addition to construction project management. Representative recent MQP topics include comparative building design and integration of design and construction.

ENVIRONMENTAL ENGINEERING

Environmental engineering is that branch of civil engineering involved with environmental quality control. The practicing environmental engineer is concerned with planning, design, construction, operation and regulation of water quality control systems related to water supply and treatment, and waste water collection and treatment. The environmental engineer is also concerned with solid waste management, public health, radiological health, and air pollution control. The Civil Engineering Department

CIVIL AND ENVIRONMENTAL ENGINEERING PROGRAM CHART

STUDENTS EARNING AN ABET ACCREDITED DEGREE IN CIVIL ENGINEERING MUST COMPLETE A MINIMUM OF 15 UNITS OF STUDY ARRANGED IN ACCORDANCE WITH THE DISTRIBUTION REQUIREMENTS. THIS CHART SUMMARIZES COURSE RECOMMENDATIONS—SEE YOUR ADVISOR TO DEVELOP YOUR PROGRAM SCHEDULE.

MATHEMATICS	SCIENCE †
4 Units Required	
MA1020/1021*	CH 1010
MA 1022*	CH 1020
MA 1023*	CH 1030
MA 1024	PH 1110
MA 2051*	PH 1120
MA 2071	PH 1130
MA 2210	BB 1001
MA 2611*	GE 2341

NOTES

Basic math and science courses should be completed early in the curriculum, prior to taking many CE courses. Students may select from other math and science courses in addition to those listed here.

* Mathematics requirements include differential and integral calculus, differential equations, and probability and statistics.

† Science: Must include both chemistry and physics with a minimum of one course in physics and two courses in chemistry.

ENGINEERING SCIENCE AND DESIGN						
6 Units Minimum Required						
(Minimum 4 Units in the Civil Engineering area as noted in Distribution Requirements)						
Fundamental Courses	CE 1030 (1), CE 2000 (1), CE 2001 (1), CE 2020 (3), ES 3004 (1), CE 3041					
Background Courses	CE 3030, ES 2503 (1), ES 3001 (1,2), ECE 3601 (1,2)					
Area (4,5)	Structural	Geotechnical	Environmental and Hydraulics	Urban and Environmental Planning	Transportation	Construction and Management
Breadth	CE 3010	CE 3041	CE 3059	CE 3070	CE 3050	CE 3020 (1)
Depth	CE 2002 CE 3006 CE 3008 CE 3026 (3) CE 4007 CE 4017	CE 3044 CE 4046 (3) CE 4048	CE 3060 CE 3061 CE 3062 CE 4060 (3) CE 4061	CE 3074 CE 4071	CE 3051 CE 3054 (3)	CE 3021 CE 3022 (1) CE 3023 CE 3024 (3)
MQP	1 Unit Emphasizing Design (in area of choice) Should be completed in senior year and meet capstone design requirement.					

NOTES

- Includes material covered on Fundamentals of Engineering General Exam.
- Meets the requirement for at least one engineering science course outside of Civil Engineering.
- Meets the requirement for appropriate laboratory experience (two laboratory courses required).
- To demonstrate breadth, students must select courses from a minimum of four areas. Courses should also be selected to demonstrate depth in at least one area.
- Many areas are interrelated. See your advisor for information on depth courses that are related to your area of interest.

ADDITIONAL DEGREE REQUIREMENTS

4 UNITS REQUIRED

Social Science	2/3 Units
Humanities and Arts	2 Units (includes Sufficiency)
IQP	1 Unit
Physical Education	1/3 Unit

at WPI emphasizes water quality aspects of environmental engineering. Key courses of this subarea are CE 3004, CE 3059, CE 3060, CE 3061, CE 3062, and CE 3074. Further depth in this field can be obtained by taking CE 4060, CE 4048, CE 4061 and other appropriate courses in chemistry, biology and biotechnology, chemical engineering, and fluid mechanics. The student should attempt to obtain some social science background, particularly in economics and possibly in law. Other engineering areas will enhance the environmental component of large projects. Courses such as CE 3010, CE 3020, CE 3050 and CE 3070 will be helpful. Recent MQP topics have focused on multimedia contaminant transport, pollution prevention, water quality issues, biosolids, and environmental impact.

TRANSPORTATION ENGINEERING

Transportation engineering is concerned with finding solutions to transportation problems such as designing and constructing safe, stable and durable pavement to carry large volumes of traffic vehicles that will be used in the 21st century. The highway infrastructure system in the US plays an important role in the commerce, economic development and security of the nation. These systems are deteriorating at a fast pace because of age, heavy increase in use and loading and deferred maintenance. While the highway infrastructure systems needs to be enhanced and maintained in order to provide the mobility needs of the nation, improvements must also be safe, efficient and environmentally benign.

A comprehensive set of courses is offered for providing both basic and in-depth knowledge in transportation engineering. The principal emphasis of transportation engineering at WPI is on traffic engineering, highway design, highway and roadside safety, principles of drainage and construction materials and pavement management. Students can gain basic understanding from breadth courses and in-depth knowledge about specific topics by taking depth courses. Breadth courses in this area are CE 3050 and CE 3026. Depth courses are CE 3051, and CE 3054.

The transportation engineering sub-area offers a wide range of MQP topics, which involve practical application of design principles in solving real-world problems. Recent MQP topics include structural design of airport pavements, use of non destructive testing in pavement design and evaluation, design of durable asphalt pavement mixtures, a study of parking needs and options on the WPI campus, an analysis of traffic accidents in Worcester, an economic study of the pros and cons of having trees in highway medians and ride quality study.

URBAN AND ENVIRONMENTAL PLANNING

The principal emphasis of urban design at WPI is the spatial arrangement of sites, neighborhoods, communities and regions, expressed through comprehensive site and development plans. These show the recommended uses of land such as residential, business, industrial, and recreational. The preservation of open space is also a major concern.

Key courses of this subarea are CE 3070, CE 3074, and CE 4071. Further depth in this field can be obtained by taking CE 4046, CE 4048, and selected graduate courses. An understanding of the other engineering areas will enhance the urban design area. Courses such as

CE 3010, CE 3059, CE 2020, and CE 3026 will be helpful. Recent MQP topics include highway route selection, highway environmental impact, design of residential area and design of new towns, and GIS applications to planning.

CONSTRUCTION ENGINEERING AND PROJECT MANAGEMENT

The civil engineering program in construction engineering and project management is directed to students whose interests lie in the design engineering process but who are also concerned with the problems in social science, management, business, labor and legal relations, and the interaction of governmental and private interests as they relate to major construction projects.

Because of the multidisciplinary nature of the program, students are encouraged to complete courses in management. Information and control systems are important to construction management, and competence in utilizing computers in these areas is expected. Students are encouraged to work with the profession through projects and other activities. Key courses in the area are CE 3006, CE 3008, CE 3020, CE 3021, CE 3022, CE 3023, CE 3024, and CE 3030. An understanding of other engineering areas will enhance a construction engineering and management program. Courses such as CE 3044, CE 3050, CE 4071, and CE 3059 will be helpful. Typical project topics include computers in construction, prefabricated buildings, rehabilitative construction strategies, scheduling of construction projects, cost evaluation of construction, and integration of design and construction.

MASTER BUILDER PROGRAM

INTRODUCTION

The civil engineering practice is undergoing significant, rapid and revolutionary changes, demanding a much higher level of knowledge and experience of new engineers than in previous generations. Today engineers must have skills in computer applications, information technology, management, communications and foreign languages, as well as fundamental engineering skills. They must also grasp the political economic and social implications of projects. Engineers must have an increased depth of knowledge of specialty areas and keep up with technological advances in methods and materials. A master's degree may become soon the first recognized professional degree leading to professional licensing.

The Master Builder Program is a new Masters of Engineering program created by the Department of Civil and Environmental Engineering to respond to the needs of the profession for the 21st Century. It has been designed within the context of WPI's project-based education and teamwork. It is available through the combined-degree program for those undergraduate students in the civil and environmental department that wish to accelerate their graduate work by careful development of their undergraduate plan of study leading to a B.S. degree and a M.E. degree in five years. The combined-degree requires 16 units for the completion of the B.S. degree. However, students can apply 12 credits counted toward the master's degree to be counted toward the bachelor's degree.

The Master Builder program has been designed to educate engineers with technical competency and management proficiency, able to effectively participate and play a leadership role in multi-disciplinary teams within the increasingly complex and demanding architectural/engineering/construction industry. These professionals are prepared to effectively integrate the planning, design construction and management of constructed facilities. They should be able to work for clients such as private developers and public agencies, traditional design, construction and facilities management firms as well as with integrated design-build firms.

COMBINED-DEGREE PROGRAM FIVE-YEAR PROGRAM

High school seniors can be admitted to the combined-degree Master Builder Program as freshman, allowing them to complete both a bachelors of science and master of engineering degree in civil and environmental in five years.

GRADUATE INTERNSHIPS AND CO-OP PROGRAM

A unique graduate internship program is available, allowing students to gain important clinical experiences in a practical engineering and research environments. Students are able to earn income, alternating work and on-campus classroom and laboratory activities.

PROJECTS

A great variety of projects are available to civil and environmental engineering students. Students should select project topics which are related to their subarea of emphasis. Project work is an extremely important part of civil engineering education, and the WPI Plan provides an excellent opportunity to strengthen this aspect of undergraduate education. Project activities are a combination of design, sponsored research, laboratory investigations, field work, and internship activities with governmental agencies and private industry. Students may become involved in project work at an early stage of the education program, and should have some Major Qualifying Project activity either under way or well in mind by the end of the junior year. The objectives of such work should include the development of the student's ability to analyze comprehensive situations, consider alternative solutions, define key problems, pick out major variables, and estimate orders of magnitude for reaching decisions. A major objective is the development of sound judgment and skill, incorporating engineering economics and social factors into problem solving.

Each civil engineering student must complete a capstone design experience which draws on past course work, involves significant engineering design, and relates to the practice of civil engineering. Normally, this will be accomplished as part of the MQP. At the time of registration for the MQP, the project advisor will indicate whether this project will meet the capstone requirement. If not, the advisor will provide an additional 1/3 unit of capstone design (not MQP) work to meet the requirement. Alternatively, another MQP which meets the requirement could be selected.

INFORMATION FOR NONMAJORS

Students from other departments find certain civil engineering courses to be valuable in the construction of their individual programs. The specific courses to be taken depend upon the interest of each student. CE 2000, CE 2001, CE 3010, and CE 3041 are useful if the student's program has a need for structures and geotechnical background. CE 3059, CE 3060 and CE 3061 are good courses for students interested in water quality control. Other courses of interest to nonmajors in this field are CE 3062 and CE 4061. CE 2020, CE 3050, CE 3051, CE 3070, and CE 3074 are valuable to students interested in transportation and urban and environmental planning. For students interested in construction engineering and management, the key courses are CE 2020, CE 3020, CE 3021, CE 3022, and CE 3023.

In addition to courses, the Civil and Environmental Engineering Department offers project opportunities for nonmajors as part of a project team.

PROGRAM DEVELOPMENT

The development of broad goals with an advisor is an important early step in the construction of a cohesive educational program that has substantial opportunity for flexibility and changes throughout the undergraduate association at WPI. The program will include mathematics, basic sciences, social sciences, humanities and arts sufficiency, physical education, and engineering science and design. The civil engineering advisors are listed below, organized in the general areas of interests. All of the advisors are available to provide counsel for either specific or general civil engineering programs.

CIVIL ENGINEERING AREA CONSULTANTS

Structural and Geotechnical Engineering

L. Albano
T. El-Korchi
P. Jayachandran

Environmental Engineering

J. Bergendahl
M. FitzPatrick
F. Hart
P. Mathisen
J. O'Shaughnessy
J. Plummer

Transportation and Urban Planning

T. El-Korchi
M. FitzPatrick
R. Mallick
M. Ray

Construction Engineering and Management

L. Albano
R. Pietroforte
G. Salazar

The civil engineering part of the program has requirements, although no unique courses are specifically required to complete the program. Nevertheless, certain courses normally are considered a part of a civil engineering education, unless a strong basis for deviation exists.

Consultation with an advisor will help an individual to construct a program that both meets WPI and ABET requirements and also provides a breadth and professional training in areas of interest. To provide guidance in structuring a program, the following courses normally should be considered as a basic expectation for all civil engineering programs:

CE 1030	Fundamentals of Computers and Civil Engineering	I
CE 2000	Analytical Mechanics I	I
CE 2001	Analytical Mechanics II	I
ES 3004	Fluid Mechanics	I
CE 2020	Surveying	I
CE 3041	Soil Mechanics	I

The following courses should be considered as fundamental to most civil engineering programs:

CE 2002	Introduction to Analysis and Design	I
CE 3026	Materials of Construction	I
CE 3030	Fundamentals of Civil Engineering AutoCAD	I

The courses listed below are designed to develop a professional base for more advanced work in the specialty areas, as well as to provide a terminal knowledge for students who wish to select areas of concentration in other disciplines. Student programs should include as many of these courses as possible to provide a breadth of understanding across the major civil engineering disciplines.

CE 3010	Structural Engineering	I
CE 3020	Project Management	I
CE 3059	Environmental Engineering	I
CE 3070	Urban and Environmental Planning	I

A cohesive program should include a selection of courses in the professional areas noted below. The student should incorporate courses in as many areas as practicable to develop a program that has both substance and breadth. Many of the courses have interactive applications in two or more engineering disciplines.

Construction Engineering and Management		Category
CE 3021	Cost Estimating, Scheduling, and Cost Control	II
CE 3022	Legal Aspects in Design and Construction	II
CE 3023	Architectural Engineering Systems	I
CE 3024	Control Surveying	II

Environmental Engineering		
CE 3060	Water Treatment	I
CE 3061	Waste Water Treatment	I
CE 3062	Hydraulics in CE	I
CE 4060	Environmental Engineering Lab	I
CE 4061	Hydrology	I

Geotechnical Engineering		
CE 3044	Foundation Engineering	I
CE 4046	Experimental Soil Mechanics	II
CE 4048	Earth Structures	II

Structural Engineering		
CE 3006	Design of Steel Structures	I
CE 3008	Design of Reinforced Concrete Structures	I
CE 4007	Matrix Analysis of Structures	I
CE 4017	Prestressed Concrete Design	I

Transportation and Planning

CE 3050	Introduction to Transportation Engineering	I
CE 3051	Introduction to Pavement Materials Design and Management	I
CE 3054	Asphalt Technology	I
CE 3070	Urban and Environmental Planning	I
CE 3074	Environmental Analysis	I
CE 4071	Land Use Development and Controls	I

Civil/Environmental Engineering with Emphasis on Water Quality Control

COORDINATORS: Profs. O’Shaughnessy, Mathisen, Hart, Plummer, or Bergendahl

The Department of Civil and Environmental Engineering at WPI provides courses leading to an ABET-accredited degree in Civil Engineering. Areas of emphasis include: the planning, design, construction, operation, and regulation of water quality control systems related to water supply and waste treatment. Environmental areas also include: public health, water supply, waste minimization treatment, and management. The engineering focus is in the area of large systems associated with municipal and other public projects.

At the undergraduate level, students often complete study in the areas of hydrology, hydraulics, hydrogeology, water supply, wastewater treatment, environmental analysis, and hazardous waste management. These areas are evaluated using physical, chemical, and biochemical techniques.

In addition to municipal and regional approaches covered in most courses, many MQP projects focus on industrial environmental problems. Typical problems include: ground water and soil contamination, waste minimization, water quality, biosolids, and hazardous waste management.

Students majoring in this program would follow a general curriculum in Civil and Environmental Engineering, with emphasis on the environmental engineering sub-area. Such preparation leads to a degree recognized by the professional accrediting organization, ABET (Accreditation Board of Engineering and Technology), and is an excellent start for entry-level professional placement or graduate study in environmental engineering.

Environmental Concentration

COORDINATORS: Profs. Hart, Plummer, Bergendahl, Mathisen, O’Shaughnessy, FitzPatrick

A disciplinary environmental concentration may be earned by completing six courses from the below list (or alternate courses through petition) plus an MQP in the environmental area. An environmental concentration in the CEE Department focuses on the planning, design, construction, operation and regulation of water quality control systems in addition to solid waste management, public health and air pollution control.

Typical MQPs include the analysis and design of innovative wastewater, water and solid waste treatment systems, disinfection processes, water quality monitoring and control system designs, water resources systems and groundwater studies.

CE 3059	Environmental Engineering
CE 3060	Water Treatment
CE 3061	Wastewater Treatment
CE 3062	Hydraulics in Civil Engineering
CE 3070	Urban and Environmental Planning
CE 3074	Environmental Analysis
CE 4060	Environmental Engineering Laboratory
CE 4061	Hydrology
CE 4071	Land Use Development & Controls
CHE 3201	Kinetics and Reactor Design
CHE 3920	Air Quality Management

COMPUTER SCIENCE

M. A. GENNERT, HEAD;

D. FINKEL, ASSOCIATE HEAD

PROFESSORS: D. C. Brown, D. Dougherty, D. Finkel, M. Hofri, E. A. Rundensteiner, S. M. Selkow, M. O. Ward

ASSOCIATE PROFESSORS: M. Claypool, M. A. Gennert, G. T. Heineman, R. E. Kinicki, K. A. Lemone, C. Ruiz, C. E. Wills

ASSISTANT PROFESSORS: E. Agu, K. Fisler, N. Heffernan, R. Lindeman, M. Mani

PROFESSOR OF PRACTICE: M. Ciaraldi, G. F. Pollice

AFFILIATED ASSOCIATE PROFESSOR: G. N. Sarkozy

INSTRUCTORS: V. Dobrushkin, G. Hamel, J. J. Wong

MISSION STATEMENT

The mission of the Computer Science Department at WPI is to provide outstanding education to its undergraduate and graduate students in accordance with the principles of the WPI mission, to advance scholarship in key domains of the computing sciences, and to engage in activities that improve the welfare of society and enhance the reputation of WPI. The Department aims to maintain an environment that promotes innovative thinking; values mutual respect and diversity; encourages and supports scholarship; instills ethical behavior; and engenders life-long learning.

GOALS

The goals of the WPI Computer Science Program are to:

1. Prepare students to function professionally as computer scientists and software engineers.
2. Prepare students for graduate studies in computer science and related disciplines.
3. Develop in students critical thinking and problem-solving skills.
4. Prepare students to assume responsible positions in society.
5. Prepare students for life-long learning.
6. Foster in students a sense of ethical behavior and respect for diversity.

OBJECTIVES

The objectives established by the WPI Computer Science Program in support of its goals and mission are to graduate students with a Computer Science major who:

1. Are prepared technically for computer science and software engineering practice.
2. Understand the basic principles of computer science and software engineering.
3. Understand appropriate mathematical concepts and are able to apply them to computational problems.
4. Have knowledge of computer hardware and architecture.
5. Understand and follow the software engineering process.
6. Are prepared to design and implement software systems.
7. Are prepared to analyze and evaluate software systems.
8. Understand fundamental scientific principles and the scientific method.
9. Can function effectively in diverse teams and situations.
10. Can communicate effectively in speech and in writing.
11. Are able to learn independently and find relevant resources.
12. Are prepared for future changes in computer science and software engineering.
13. Are prepared to uphold professional and ethical standards.
14. Understand and appreciate the role of computer science and software engineering in a societal context.
15. Are aware of career and further educational opportunities.
16. Have a mature understanding of themselves and others.

OUTCOMES

Based on the above objectives, the specific outcomes to be achieved for the WPI Computer Science major are that:

1. All students will demonstrate an understanding of programming language concepts.
2. All students will demonstrate knowledge of computer organization.
3. All students will demonstrate an ability to analyze the behavior of computational systems.
4. All students will demonstrate knowledge of computer operating systems.
5. All students will demonstrate an understanding of the foundations of computer science.
6. Almost all students will demonstrate an understanding of software engineering principles and the ability to apply them to software design.
7. A majority of students will demonstrate an understanding of human-computer interaction.
8. All students will complete a large-scale software project.
9. All students will demonstrate advanced knowledge of computer science topics.

10. All students will demonstrate an understanding of the mathematical foundations of computer science.
11. All students will demonstrate knowledge of probability or statistics.
12. All students will demonstrate an understanding of scientific principles.
13. A majority of students will demonstrate the ability to design experiments and interpret experimental data.
14. All students will demonstrate independent learning.
15. All students will demonstrate the ability to locate and use technical information from multiple sources.
16. All students will demonstrate an understanding of professional ethics.
17. All students will demonstrate an understanding of the links between technology and society.
18. A majority of students will belong to at least one professional organization, including IEEE, ACM, and UPE.
19. All students will participate in a class or project team.
20. Almost all students will demonstrate the ability to communicate effectively in speech.
21. All students will demonstrate the ability to communicate effectively in writing.

INTRODUCTION

Computer scientists should be broadly-educated individuals with a clear understanding of the natural laws and social orders that govern the world around them. Well-educated individuals in our technical society must be knowledgeable in the areas of mathematics, humanities and social science, science, and engineering. Therefore, a student's program of study should include in-depth studies in several disciplines in addition to computer science. Broad-based education cannot be mandated by simply listing courses or topics to be studied. Instead, the WPI Plan encourages an integration of formal course work, project activity, self-study, and personal experiences. We cannot urge strongly enough that students make the very best use of the diverse educational opportunities available to them.

To be effective in business and society, computer scientists must be able to do more than design computing systems. They must relate to and communicate with people, so as to apply these systems to improving real-life situations. In recognition of the need for technical specialists who also have human-oriented skills, the WPI Plan requires a strong background in the humanities. To ensure breadth within the broad discipline of computer science and a firm grounding in mathematics and science, a student must complete the department's program distribution requirements.

The major designated as "Computer Science" is the only program accredited by the Computing Accreditation Commission of ABET within the Department of Computer Science.

Program Distribution Requirements for the Computer Science Major

The normal period of residency at WPI is 16 terms. In addition to the WPI requirements applicable to all students (see page 21) mathematics, basic science, and related fields as follows:

COMPUTER SCIENCE	Minimum Units
1. Computer Science (including the MQP) (Notes 1, 2).	6
2. Mathematics (Notes 2, 3, 5).	7/3
3. Basic Science and/or Engineering Science (Notes 2, 4).	5/3

NOTES:

1. a. Only CS 1101, CS 1102 and computer science courses at the 2000-level or higher will count towards the computer science requirement. CS 2118 will not count towards the computer science requirement.
 - b. Must include at least 1/3 unit from each of the following areas: Systems (CS 3013, CS 4513, CS 4514, CS 4515), Theory and Languages (CS 3133, CS 4120, CS 4123, CS 4533, CS 4536), Design (CS 3041, CS 3431, CS 3733, CS 4233), and Social Implications of Computing (CS 3043, SS 2208, SS/ID 2314). (If SS 2208 or SS/ID 2314 is used to satisfy this requirement, it does not count as part of the 6 units of CS.)
 - c. At least 5/3 units of the Computer Science requirement must consist of 4000-level courses. These units can also be met by WPI graduate CS courses, with the exception of CS 501 and CS 507.
 - d. Only one of CS 1101 and CS 1102 may count towards the computer science requirement. Only one of CS 2301 and CS 2303 may count towards the computer science requirement.
2. A cross-listed course may be counted toward only one of areas 1, 2, 3, above.
3. Must include at least 1/3 unit from each of the following areas: Probability (MA 2621, MA 2631) and Statistics (MA 2611, MA 2612).
4. Courses satisfying the science requirement must come from the BB, BME, CE, CH, CHE, ECE, ES, GE, ME, PH disciplines. At least three courses must come from BB, CH, GE, PH, where at least two courses are from one of these disciplines.
5. At most four 1000-level Mathematics courses may be counted towards this requirement.

The Computer Science Department offers a second program not accredited by the Computing Accreditation Commission of ABET and not bearing the title "Computer Science." The distribution requirements for that program are:

Program Distribution Requirements for the Computers with Applications Major

COMPUTERS WITH APPLICATIONS	Minimum Units
1. Computer Science (including the MQP) (Notes 1, 2).	16/3
2. Mathematics (Note 2).	7/3
3. Basic Science (Notes 2, 3).	2/3
4. Application Area (Notes 2, 4).	5/3

NOTES:

1. a. Only CS 1101, CS 1102 and computer science courses at the 2000-level or higher will count towards the computer science requirement. CS 2118 will not count towards the computer science requirement.

- b. Must include at least 1/3 unit from each of the following areas: Systems (CS 3013, CS 4513, CS 4514, CS 4515), Theory and Languages (CS 3133, CS 4120, CS 4123, CS 4533, CS 4536), Design (CS 3041, CS 3431, CS 3733, CS 4233), and Social Implications of Computing (CS 3043, STS 2208). (If STS 2208 is used to satisfy this requirement, it does not count as part of the 16/3 units of CS.)
 - c. At least 5/3 units of the Computer Science requirement must consist of 4000-level courses.
These units can also be met by WPI graduate CS courses, with the exception of CS 501 and CS 507.
 - d. The MQP must involve the application of computer science concepts to the Application Area specified in Requirement 4.
 - e. Only one of CS 1101 and CS 1102 may count towards the computer science requirement. Only one of CS 2301 and CS 2303 may count towards the computer science requirement.
2. A cross-listed course may be counted toward only one of areas 1, 2, 3, 4 above.
 3. The two courses satisfying the science requirement must both come from one of the following disciplines: BB, CH, GE, PH.
 4. This requirement is satisfied by a cohesive set of work from disciplines other than Computer Science. Work used for any other degree requirements cannot be used for the Application Area. At least 3/3 units must be course work at the 3000 level or higher. Independent Study/Project (ISP) work, if any, must be conducted under the supervision of a member of the faculty in that discipline.

PREVIOUS DISTRIBUTION REQUIREMENTS FOR COMPUTER SCIENCE AND COMPUTERS WITH APPLICATIONS MAJOR

The above distribution requirements apply to all students whose matriculation date is after May 1, 2006. Students who matriculated prior to May 1, 2006 should consult the catalog for their year of entry or consult with their academic advisor or the Chair of the Department Distribution Review Committee.

PLANNING A COMPUTER SCIENCE MAJOR

Computer science students, upon completion of their program of study, should have developed a number of areas of competence. This competence is a blend of practical skills and knowledge of applied techniques and theoretical concepts. "Core" courses in computer science provide a foundation in the areas of programming, data structures, computer organization and operating systems, mathematics and theoretical computer science, and the social impact of computing.

The ability to program is a major practical skill to develop. This is fundamental, of course, to the application of computers for any purpose whatsoever. Programming is not a mere synonym for coding. It includes a skillful evaluation of the problem statement, the development of an efficient algorithm and data structure for the solution of the problem, a clear specification of the algorithm and data structure, an evaluation of the cost of executing the algorithm, the actual coding, and the creation of sufficient test cases to verify the accuracy of the solution. The student must develop a strong programming ability in at least one high-level language as well as an ability to program in an assembler language.

The efficient organization of data into structures of varying complexity is an important part of the solution to most programming problems. Students must study not

only the theoretical aspects of such structures but also their applications. In addition, students must become familiar with the techniques of representing various structures within the limitations imposed by the memory and languages available on the computer.

Students should have a clear understanding of the fundamental processes that occur within a general-purpose computing system. Familiarity with the operation of the hardware should be developed, as well as knowledge of the way hardware, operating systems, and user programs interact to form an effective computing system.

The theoretical aspects of computer science depend upon discrete mathematics for their description, so computer scientists should be familiar with this area of mathematics and how it relates to computer science theory.

In today's society the computer is a tool which affects the lives of everyone. The computer scientist cannot, in good conscience, remain blissfully ignorant of the impact caused by his or her own decisions and actions. Therefore, the computer science student is urged to study the relation between individuals, society and the computer.

Majors in computer science should be familiar with material in the following areas, although students are not required to take all of these.

CORE COURSES FOR MAJORS IN COMPUTER SCIENCE

Computer Science

CS 1101	Introduction to Program Design
CS 1102	Accelerated Introduction to Program Design
CS 2011	Introduction to Machine Organization and Assembly Language
CS 2022	Discrete Mathematics
CS 2102	Object-Oriented Design Concepts
CS 2223	Algorithms
CS 2303	Systems Programming Concepts
CS 3013	Operating Systems
CS 3041	Human-Computer Interaction
CS 3043	Social Implications of Information Processing
CS 3133	Foundations of Computer Science
CS 3733	Software Engineering

Mathematics

MA 1021	Calculus I
MA 1022	Calculus II
MA 1023	Calculus III
MA 1024	Calculus IV
MA 2071	Matrices and Linear Algebra I
MA 2611	Applied Statistics I
MA 2621	Probability

Note that other mathematics courses, such as MA 2051, may be useful background for advanced Computer Science courses.

The Computer Science Department advises all CS majors to have significant experience with science and with the application of the scientific method. This experience may be obtained through one or more of the following:

- Taking four sciences courses,
- Taking engineering courses with a significant science component,
- Researching and solving a scientific problem as part of the MQP, or
- Utilizing the scientific method in the MQP.

For students who wish to improve their communication skills, the following courses are recommended: IS 1811, Writing for International Students, IS 1812, Speech for International Students, or EN 2211, Elements of Writing.

ADVANCED COURSES IN COMPUTER SCIENCE

After students have established a firm foundation in computer science, they should explore advanced topics, leading toward MQP work. Students must take at least one course from each of the following areas: Systems (CS 3013, CS 4513, CS 4514, CS 4515), Theory and Languages (CS 3133, CS 4123, CS 4533), Design (CS 3041, CS 3431, CS 3733, CS 4233), and Social Implications of Computing (CS 3043, SS 2208, SS/ID 2314). Other 4000-level courses may be divided among these areas or concentrated in a particular area according to each student's program objectives. The diagram on page 112 indicates how the material presented in each course is used by sub-

sequent courses. Some variation in course order may occur, but the student considering taking courses out of sequence is advised to check the course descriptions for recommended background.

Listed below are several areas of computer science in which the student may wish to specialize, including some courses from other departments. These areas are meant to be illustrative; one should choose the course of study that best meets one's own needs and plans.

Robotics

CS 3733	Software Engineering
CS 4341	Introduction to Artificial Intelligence
CS 4732	Computer Animation
CS 4120	Analysis of Algorithms
ES 2xxx	Introduction to Robotics
ECE 2801	Foundations of Embedded Systems
ME 4815	Industrial Robots

COMPUTER SCIENCE PROGRAM CHART

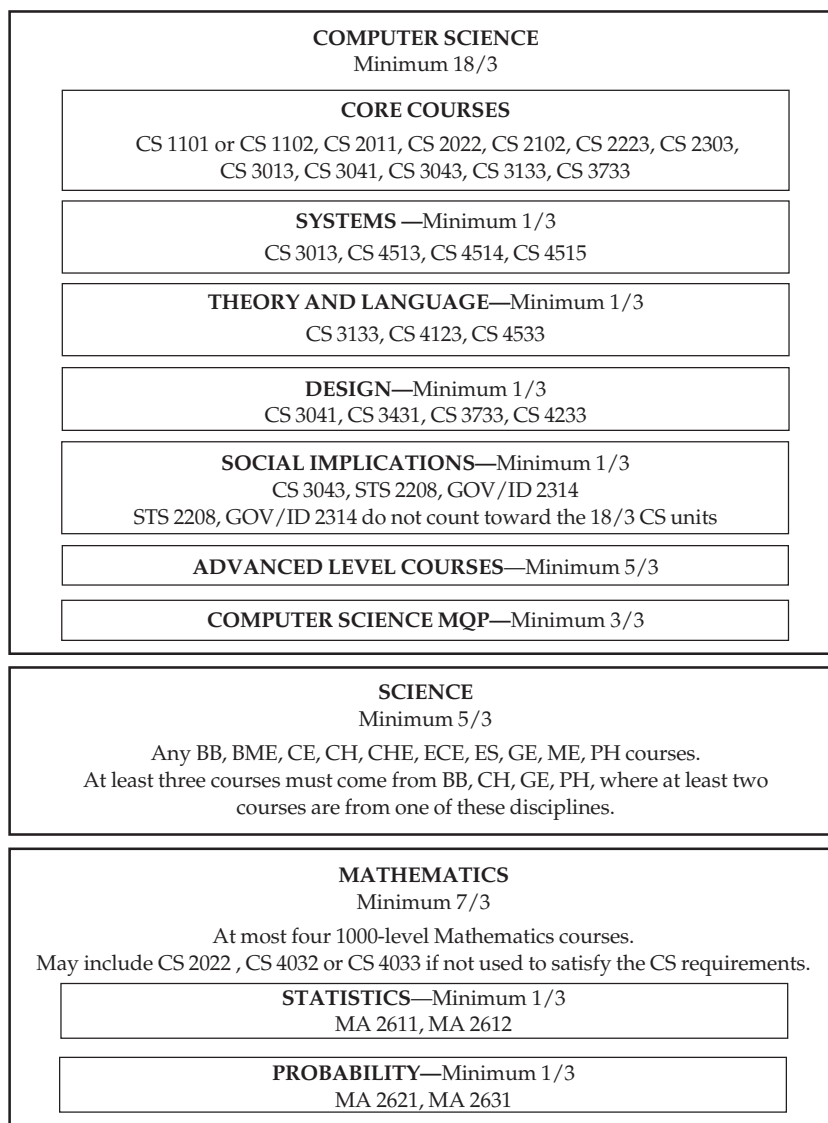

COMPUTER SCIENCE COURSE FLOW CHART

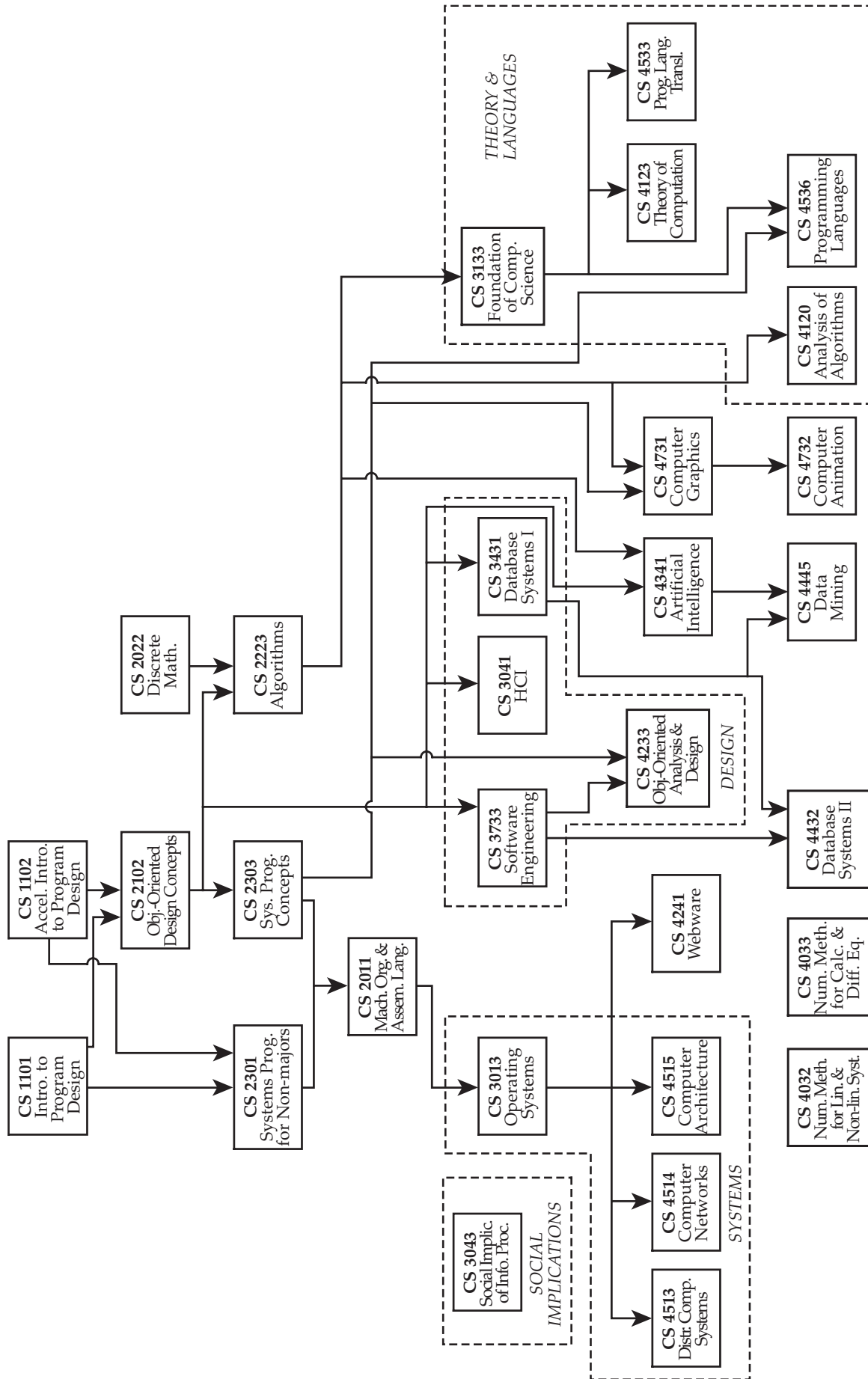

Operating Systems

- CS 3013 Operating Systems
 CS 4513 Distributed Computing Systems
 CS 4514 Computer Networks: Architecture and Implementation
 CS 4515 Computer Architecture
 MA 2051 Ordinary Differential Equations
 MA 2621 Probability for Applications

Software Systems

- CS 3041 Human-Computer Interaction
 CS 3431 Database Systems I
 CS 3733 Software Engineering
 CS 4233 Object Oriented Analysis and Design
 CS 4241 Webware

Human-Computer Interaction

- CS 3013 Operating Systems
 CS 3041 Human-Computer Interaction
 CS 3043 Social Implications of Information Processing
 CS 3431 Database Systems I
 CS 3733 Software Engineering
 CS 4241 Webware: Computational Technology for Network Systems
 CS 4341 Introduction to Artificial Intelligence
 CS 4432 Database Systems II
 CS 4731 Computer Graphics

Languages And Compilers

- CS 3041 Human-Computer Interaction
 CS 3133 Foundations of Computer Science
 CS 3733 Software Engineering
 CS 4233 Object-Oriented Analysis and Design
 CS 4533 Techniques of Programming Language Translation
 CS 4536 Programming Languages

Theoretical Computer Science

- CS 3133 Foundations of Computer Science
 CS 4120 Analysis of Algorithms
 CS 4123 Theory of Computation
 CS 4533 Techniques of Programming Language Translation
 MA 2271 Graph Theory
 MA 2273 Combinatorics
 MA 4631 Probability and Mathematical Statistics I

Scientific Applications

- CS 4032 Numerical Methods for Linear and Non-linear Systems
 CS 4033 Numerical Methods for Calculus and Differential Equations
 CS 4731 Computer Graphics
 MA 1021 Calculus I
 MA 1022 Calculus II
 MA 1023 Calculus III
 MA 1024 Calculus IV
 MA 2051 Ordinary Differential Equations
 MA 2621 Probability for Applications
 MA 3231 Linear Programming
 MA 4411 Numerical Analysis of Differential Equations
 PH 1110 General Physics — Mechanics
 PH 1120 General Physics — Electricity and Magnetism

Hardware Orientation

- CS 4515 Computer Architecture
 ECE 3601 Principles of Electrical Engineering
 ECE 3801 Advanced Logic Design
 ECE 3803 Microprocessor System Design
 ECE 3810 Advanced Digital System Design
 ECE 4801 Advanced Computer System Design

Students who are interested in the hardware aspects of computers, yet do not need a strong background in electronics, may omit the introductory electrical engineering courses and begin with ECE 3801. Such a decision should be discussed with one's academic advisor.

INDEPENDENT STUDY

Independent study and project work provide the opportunity for students, working under the direction of faculty members, to study or conduct research in an area not covered in courses, or in which the students require a greater depth of knowledge. The background required of a student for independent study work depends on the particular area of study or research.

PROJECT OPPORTUNITIES

Off-campus qualifying projects are available at the Silicon Valley Project Center, the NASA/Goddard Space Center, and the Wall Street Project Center.

Projects are also available on campus, both to support the on-going research activities of the faculty, and to expand and improve the applications of computers for service, education, and administration.

Additionally, the department supports IQPs in a number of areas including assistance with, and development of, computer science education at neighboring area schools.

COMBINED BACHELOR'S/MASTER'S PROGRAM

Computer Science majors are advised to investigate the opportunity to enroll in the Combined Bachelor's/Master's Program described on page 263. For application information, consult the CS department office.

COMPUTER SCIENCE FOR THE NONMAJOR

A knowledge of computer programming is essential for professionals in most technical disciplines. The Computer Science faculty recommends that all students give serious consideration to the following introductory courses:

- CS 1101 Introduction to Program Design
 CS 1102 Accelerated Introduction to Program Design
 CS 2102 Object-Oriented Design Concepts
 CS 2301 Systems Programming for the Non-Major
 CS 2303 Systems Programming Concepts

Students with substantial programming background may wish to begin their Computer Science courses with CS 1102 instead of CS 1101. The three-course sequence CS 1101 or CS 1102, CS 2102, and CS 2303 provides the recommended background for the study of all advanced courses in Computer Science. The two course sequence CS 1101 or CS 1102, and CS 2301 provides the necessary background for certain advanced Computer Science courses. Students interested in advanced study in Computer Science should consult the catalog descriptions of the advanced courses they plan to take to see which sequence will prepare them for those courses.

COMPUTER SCIENCE MINOR

The Minor in Computer Science will consist of 2 units from Computer Science, with no more than one course at the 1000-level. The 2 units must conclude with one of the following, each of which provides an integrating capstone experience:

- CS 3013 Operating Systems
- CS 3041 Human-Computer Interaction
- CS 3133 Foundations of Computer Science
- CS 3431 Database Systems I
- CS 3733 Software Engineering
- CS 4120 Analysis of Algorithms
- CS 4123 Theory of Computation
- CS 4233 Object-Oriented Analysis and Design
- CS 4241 Webware: Computational Technology for Network Systems
- CS 4341 Introduction to Artificial Intelligence
- CS 4432 Database Systems II
- CS 4513 Distributed Computing Systems
- CS 4514 Computer Networks: Architecture and Implementation
- CS 4515 Computer Architecture
- CS 4533 Techniques of Programming Language Translation
- CS 4536 Programming Languages
- CS 4731 Computer Graphics
- CS 4732 Computer Animation

- any graduate-level CS course, except for CS501, CS505, CS507, CS552, or CS590
- 1/3 unit of another activity, for example an ISP, which is validated by a CS faculty member as a capstone.

Students interested in initiating work on a minor in CS are encouraged to ask the Computer Science Department to identify a faculty member to assist the student in structuring a minor. Prior to the initiation of a capstone experience students must inform the offering professor of their intent to use the experience as a capstone.

Majors in Computer Science and Computers with Applications do not qualify for a Minor in Computer Science.

ECE majors and Management Information Science majors should review the Operational Rules of the Minor at WPI to avoid problems with double counting CS courses. For general policy on the Minor, see the description on pages 25-26.

ELECTRICAL AND COMPUTER ENGINEERING

F. J. LOOFT, HEAD; H. HAKIM, ASSOCIATE HEAD

PROFESSORS: K. A. Clements, D. Cyganski, A. E. Emanuel, F. J. Looft, R. Ludwig, J. A. Orr, K. Pahlavan, P. C. Pedersen

ASSOCIATE PROFESSORS: E. A. Clancy, R. J. Duckworth, H. Hakim, S. Makarov, J. A. McNeill, W. R. Michalson, R. F. Vaz

ASSISTANT PROFESSORS: D. R. Brown, B. King, W. Lou, B. Sunar

PROFESSOR OF PRACTICE: R. Labonte

AFFILIATE PROFESSOR: R. H. Campbell

INSTRUCTORS: S. J. Bitar, S. M. Jarvis

EMERITUS PROFESSORS: J. S. Demetry, W. H.

Eggimann, W. R. Grogan, O. W. Kennedy, H. P. D.

Lanyon, A. K. McCurdy, G. H. Owyang, G. E. Stannard

INTRODUCTION

Since the invention of the transistor in 1947, the field of electrical and computer engineering (ECE) has seen tremendous and continuous growth. From its origins in electric power, the field now ranges from various analog and digital design disciplines to all forms of communication and signal processing systems. Working engineers design the components and systems that, for example: compose computers, computer networks and the Internet; control automobiles, aircraft and shipping vessels; monitor patient vital signs in medical critical care; provide secure and reliable wireless connectivity for telephones and electronic commerce; deliver electricity to our homes and work places; etc.

To be prepared for employment as a contributing engineer and/or for graduate-level education, students within the ECE Department receive instruction that is balanced between theory and practice. In fact, much of our curriculum integrates theory and practice within *each* course. It is common to study new devices and techniques, and then immediately work with these devices/techniques in a laboratory setting. In response to the breadth of ECE, all students work with their academic advisor to develop a broad-based program of study. As with most engineering curricula, ECE study includes a solid foundation of mathematics and science. Discipline-specific study in ECE usually begins early in a student's career — during the second half of the freshman year — with courses providing a broad overview of the entire field. During the sophomore and junior years, students learn the core analysis, design and laboratory skills necessary to a broad range of ECE sub-disciplines. When desired, specialization within ECE occurs during the junior and senior years. In addition, all students complete a major qualifying project (MQP). This project, typically completed in teams during the senior year, is an individualized design or research project that draws from much of the prior instruc-

tion. Utilizing the benefit of individualized instruction from one or more faculty members, students develop, implement and document the solution to a real engineering problem. Many of these projects are sponsored by industry, or are associated with ongoing faculty research. These projects form a unique bridge to the engineering profession.

EDUCATIONAL OBJECTIVES

The department educates future leaders of the electrical and computer engineering profession, with a program characterized by curricular flexibility, student project work, and active involvement of students in their learning. Through a balanced, integrated curriculum we provide an education which is strong both in the fundamentals and in state-of-the-art knowledge, appropriate for immediate professional practice as well as graduate study and lifelong learning. Such an education also prepares students broadly for their professional and personal lives, providing the basis for effective leadership and informed citizenship. The curriculum embraces WPI's philosophy of education, and takes advantage of key components such as the Interactive Qualifying Project to develop technical professionals who possess the ability to communicate, work in teams, and understand the broad implications of their work.

MAJOR OFFERED

In the electrical and computer engineering department we currently offer the Bachelor of Science degree in *Electrical and Computer Engineering* (ECE). The ECE major is new to the department, and was designed to offer greater breadth across the many subdisciplines of ECE.

Students must fulfill the general requirements set forth by WPI (such as the IQP and Sufficiency projects) as well as a set of department-specific "distribution requirements" in order to graduate. The requirements stipulated by the ECE department apply to 10 units of study (out of the 16 units total that a typical student spends at WPI). The following sections provide further description of the ECE major and its respective distribution requirements.

BACHELOR OF SCIENCE IN ELECTRICAL AND COMPUTER ENGINEERING

In recent years, the role of computers in electrical engineering has continued to grow. The use of computers has become an essential part of the analysis, design, and implementation of nearly all electrical engineering applications, and as a result, knowledge of computers and computer engineering has become a necessity for any successful electrical engineer. We believe that for any student to be skilled and successful in any area of ECE—whether entering the work force or continuing into graduate education—it is necessary that he or she possess a complete understanding of the fundamentals across the breadth of electrical and computer engineering. For these reasons, we recently created a new program that places greater emphasis on attaining a breadth of knowledge across the many sub-disciplines of ECE, particularly by incorporating a more complete balance between computer engineering and other areas of ECE.

Based on the department's educational objectives, students will achieve the following specific educational outcomes within a challenging and supportive environment:

1. Preparation for engineering practice, including the technical, professional, and ethical components
2. Preparation for future changes in electrical and computer engineering
3. A solid understanding of the basic principles of electrical engineering, computer engineering, and the relationship between hardware and software
4. An understanding of appropriate mathematical concepts, and an ability to apply them to ECE
5. An understanding of the engineering design process, and ability to perform engineering design, including the needed teamwork and communications skills.
6. Demonstration of in-depth understanding of at least one specialty within ECE
7. An ability to communicate effectively in written and oral form
8. An understanding of options for careers and further education, and the necessary educational preparation to pursue those options
9. An ability to learn independently
10. The broad education envisioned by the WPI Plan, and described by the Goal and Mission of WPI
11. An understanding of engineering and technology in a societal and global context.

Program Distribution Requirements for the Electrical and Computer Engineering Major

The normal period of residency at WPI is 16 terms. In addition to *WPI requirements applicable to all students*, students wishing to receive the major designated "Electrical and Computer Engineering" must satisfy certain distribution requirements. These requirements apply to 10 units of study in the areas of mathematics, basic science, and engineering science and design as follows:

Requirements	Minimum Units
1. Mathematics and Basic Science (Notes 1a-1d).	4
2. Engineering Science and Design (ES/D) (including the MQP) (Notes 2a-2g).	6

NOTES:

1. Mathematics and Basic Science:
 - 1a. Must include at least 7/3 units of math (prefix MA). Mathematics must include differential and integral calculus, differential equations, discrete mathematics, and probability and/or statistics.
 - 1b. Must include at least 2/3 units of physics (prefix PH).
 - 1c. Must include at least 1/3 units of chemistry (prefix CH) or 1/3 units biology (prefix BB).
 - 1d. Must include an additional 2/3 units of math or basic science (prefixes MA, PH, CH, BB, or GE).
2. Engineering Science and Design (including the MQP):
 - 2a. Must include at least 5 units within the Electrical and Computer Engineering area (including the MQP). All courses with prefix ECE (except ECE 3601) are applicable to these 5 units. Also, courses ES 3011, BME 4011, and BME 4201 are applicable to these 5 units.
 - 2b. The 5 units within the Electrical and Computer Engineering area must include at least 1 unit of courses from an approved list of Electrical Engineering courses (see the list on page 116).

2c. The 5 units within the Electrical and Computer Engineering area must include at least 2/3 unit of courses from an approved list of Computer Engineering courses (see the list below).

2d. The 5 units within the Electrical and Computer Engineering area must include 1/3 unit of Capstone Design Experience. (This requirement is typically fulfilled by the MQP.)

2e. Must include at least 1/3 unit of computer science (prefix CS), at the 2000 level or above (other than CS 2011, CS 2022, CS 3043 which cannot be applied to this requirement).

2f. Must include at least 1/3 unit of engineering science (prefix ES) at the 2000 level or above. This requirement may also be satisfied by ME 3601. ES 3011 cannot be applied to this requirement.

2g. Must include an additional 1/3 unit of engineering science and design at the 2000 level or above, selected from courses having the prefix BME, CE, CHE, CS (other than CS 2011, CS 2022, CS 3043), ECE (other than ECE 3601), ES, FP, or ME.

Electrical Engineering courses satisfying requirement

2b: ECE 2112, 2201, 2312, 3113, 3204, 3306, 3311, 3501, 3503, 3703, 3711, 3901, 4304, and 4902; BME 4011 and 4201; and ES 3011.

Computer Engineering courses satisfying requirement 2c: ECE 2801, 3801, 3803, 3810 and 4801.

OVERVIEW OF ECE PROGRAM COMPONENTS

The path toward a degree in the ECE Department varies greatly from student to student. To be successful, you must tailor your program to fit your academic needs, working within the boundaries of the major's distribution requirements and WPI's general degree requirements.

This section is intended as a guide to clarify the program components you will need to fulfill the distribution requirements for the ECE major. It also contains information about general WPI requirements, and advice on how to integrate these elements into your degree plan.

MAJOR QUALIFYING PROJECT (MQP)

In many cases, the pinnacle of a student's undergraduate work at WPI is the MQP, the senior-level design project. The ECE degree requires all students to complete an MQP worth 1 unit of study in the major area (the equivalent of 3 courses). Note that this 1 unit is part of the 6 total needed to fulfill the "Engineering Science and Design" distribution requirement. Of the remaining 5 units, 4 units (12 courses) are met by courses in the major area. The breakdown of courses needed is discussed further in the section titled "Overview of Other Program Components."

Also note that projects that lack a significant engineering design component are typically not approved. Thus, the 1/3 unit of "Capstone Design Experience" required for the ECE major is almost always a part of the MQP, and need not be fulfilled by a separate course.

The MQP is an extremely important part of your degree program: it is a single project that accounts for the equivalent of three ECE-related courses, and provides some of the most directly relevant preparation you will receive for graduate school or a job in industry. Your MQP can be very rewarding, exciting, and even fun. However, it can also be quite frustrating if you are not adequately prepared. Consequently, when planning your degree pro-

gram, a good deal of effort should be made to ensure you have developed a solid foundation in all areas of ECE before attempting to begin your project.

SUBDISCIPLINES WITHIN ECE

Given a solid foundation, the MQP will allow you to demonstrate an in-depth understanding of one or more of the subdisciplines that compose the field of electrical and computer engineering. As a guide to the areas of study that can be investigated in an MQP, the ECE Course Flowchart identifies eight subdisciplines as possible areas for in-depth study leading to an MQP. Note that students should not feel constrained by these area designations — this is only one of many possible ways to organize the diverse field of electrical and computer engineering. Many if not most MQPs will incorporate subject matter from several different subdisciplines. The purpose of this list is to guide students interested in a particular area to coursework within a subdiscipline (Area Courses), relevant courses to choose from outside the subdiscipline (Related Courses), and faculty whose research and MQP advising interests fall within the subdiscipline (Area Consultants).

Robotics

Area Consultants: Cyganski, Duckworth, Looft, Michalson, Orr

Area Courses

ECE 2022 Introduction to Digital Circuits and Computers
ECE 2801 Foundations of Embedded Computer Systems
ES 3011 Control Engineering I
ECE 3803 Microprocessor System Design

Related Courses

ES 2201 Introduction to Robotics
ECE 2201 Microelectronics I
ECE 3305 Aerospace Avionics Systems
ECE 3503 Power Electronics
CS 4341 Artificial Intelligence

Power Systems Engineering

Area Consultants: Clements, Emanuel, Hakim

Area Courses

ECE 3501 Electrical Energy Conversion
ECE 3503 Power Electronics
ECE 4502 Analysis of Large Scale Power Systems

Related Courses

ES 3001 Introduction to Thermodynamics
ES 3011 Control Engineering I
OIE 2850 Engineering Economics
ME 1800 Materials Selection and Manufacturing Processes

RF Circuits and Microwaves

Area Consultants: Ludwig, Makarov

Area Courses

ECE 2112 Electromagnetic Fields
ECE 3113 RF Circuit Design

Related Courses

MA 4451 Boundary Value Problems
PH 3301 Electromagnetic Theory
PH 3401 Quantum Mechanics I
PH 3504 Optics

Aerospace and Control Systems

Area Consultants: Labonte, Michalson

Area Courses

ECE 3305 Aerospace Avionics Systems
ES 3011 Control Engineering I

Related Courses

ECE 2312 Discrete-Time Signal and System Analysis
ECE 3204 Microelectronics II
ECE 3311 Principles of Communication Systems

ECE 3503 Power Electronics
 ECE 3801 Advanced Logic Design
 ECE 3803 Microprocessor System Design
 ECE 4304 Communication Systems Engineering

Communications and Signal Analysis

Area Consultants: Brown, Clancy, Cyganski, Hakim, King, Makarov, Orr, Pahlavan, Pedersen, Vaz

Area Courses

ECE 2312 Discrete-Time Signal and System Analysis
 ECE 3311 Principles of Communication Systems
 ECE 3703 Real-Time Digital Signal Processing
 ECE 3711 Introduction to Electro-Optics
 ECE 4304 Communication Systems Engineering

Related Courses

ES 3011 Control Engineering I
 MA 2071 Matrices and Linear Algebra I
 MA 2621 Probability for Applications
 MA 4291 Applicable Complex Variables

Biomedical Engineering

Area Consultants: Clancy, Pedersen

Area Courses

BME 4011 Biomedical Signal Analysis
 BME 4201 Biomedical Imaging

Related Courses

ECE 2312 Discrete-Time Signal and System Analysis
 BME 2204 Bioelectric Foundations
 BME 3011 Bioinstrumentation and Biosensors

Analog Microelectronics

Area Consultants: Aboud, Bitar, Campbell, Labonte, McNeill

Area Courses

ECE 2201 Microelectronics I
 ECE 3204 Microelectronics II
 ECE 3306 Audio Engineering
 ECE 3901 Semiconductor Devices
 ECE 4902 Analog Integrated Circuit Design

Related Courses

ES 3011 Control Engineering I
 ECE 3801 Advanced Logic Design

Computer Engineering

Area Consultants: Clancy, Cyganski, Duckworth, Hakim, Jarvis, King, Looft, Lou, Michalson

Area Courses

ECE 2801 Foundations of Embedded Computer Systems
 ECE 3801 Advanced Logic Design
 ECE 3803 Microprocessor System Design
 ECE 3810 Advanced Digital System Design
 ECE 4801 Advanced Computer System Design

Related Courses

ECE 2201 Microelectronics I
 CS 2223 Algorithms
 CS 3013 Operating Systems
 CS 3733 Software Engineering

OFF-CAMPUS MQP OPPORTUNITIES

The ECE Department offers off-campus MQP opportunities in the following locations: Limerick, Ireland; Silicon Valley, California; and MIT Lincoln Laboratory in Lexington, MA. These projects are performed as one-term, fulltime MQP experiences; some require a PQP or specific background preparation. Students can submit applications for these programs during A term of the academic year prior to their MQP (typically their junior year). For more information on these and other WPI off-campus programs, please visit the WPI Global Perspective Program website at <http://www.wpi.edu/Academics/Depts/IGSD/Projects>

ECE DESIGN COURSE

The most explicit educational background for the MQP is the course ECE 2799, Electrical and Computer Engineering Design. In ECE 2799, students spend the term working on a specific design project. The students not only gain experience in the design of a particular system, component, or process, but they also learn a great deal about the design process itself. Moreover, the course is a great opportunity to work on an exciting project with a team of students. (For more information please see the course description.)

Since ECE 2799 is direct preparation for the MQP, students are strongly encouraged to successfully complete the course before seeking a senior project. Most ECE faculty will not accept MQP students until they have passed ECE 2799.

Before you can pass ECE 2799 though, you need to be adequately prepared. As is true for most ECE applications, the projects in ECE 2799 require solid background in a variety of sub-disciplines, and thus it is necessary to learn these fundamentals before taking the course. As background for ECE 2799, we strongly recommend (1) all four courses in the "basic core", and (2) either ECE 2201 or ECE 2801 in the "advanced core". These two sets of core courses are explained further in the next section.

Given these recommendations, the best time to take ECE 2799 is at the end of your sophomore or beginning of your junior year, once the recommended background has been completed. For more on year-by-year planning, see the section titled "Planning a Program in ECE."

CORE COURSES

Although electrical and computer engineering is a vast and rapidly expanding field, there remains at its center a core of basic principles. These fundamental concepts, which have changed remarkably little throughout the rich history of electrical engineering, continue to serve as a basis for even the newest technologies. Accordingly, we consider developing a mastery of these fundamentals to be one of your most important tasks as an undergraduate student.

Core courses in the ECE department are divided into two groups: the "basic core" and the "advanced core". Together, these eight courses represent the bulk of ECE fundamentals, constituting much of what you will need to know as you prepare for ECE 2799 and your MQP. The basic core is composed of four courses:

- ECE 2011 – Intro to ECE
- ECE 2022 – Intro to Digital Circuits and Computer Engineering
- ECE 2111 – Physical Principles of ECE Applications
- ECE 2311 – Continuous-Time Signal and System Analysis

These courses provide a comprehensive introduction to the fundamentals of ECE. Although you should consult the individual descriptions for each course to obtain detailed information about all the topics covered, the basic core amounts to an overview of central topics in ECE, including basic analog and digital circuits, introductory computer engineering, continuous signals and systems, electric power applications, and basic electromagnetic field theory. Before you attempt ECE 2799, we strongly recommend that you take all four of these courses.

The advanced core is composed of another four courses, which are extensions of the material in the basic core:

- ECE 2201 – Microelectronic Circuits I
- ECE 2801 – Foundations of Embedded Computer Systems
- ECE 2112 – Electromagnetic Fields
- ECE 2312 – Discrete-Time Signal and System Analysis

Based on preference, you should take either ECE 2201 or ECE 2801 before attempting ECE 2799, so you can enter with a greater proficiency in at least the analog or digital sub-area of ECE. Note, though, that the material in the advanced core is considered fundamental to study in our department, and every student eventually should take all of the courses in the advanced core.

OVERVIEW OF OTHER PROGRAM COMPONENTS

ENGINEERING SCIENCE AND DESIGN

Because modern engineering practice is increasingly interdisciplinary, all students achieve some breadth of study outside of the ECE department by taking a minimum of one Computer Science and one Engineering Science course. Both courses must be at the 2000-level or higher, and certain courses with limited technical content are not credited towards this requirement. (See the formal requirements listed previously in the distribution requirements.) In the Computer Science area, most students will need to complete a CS course at the 1000-level before attempting requirements at the 2000-level or above. Many students find it advantageous to take more than the minimum CS course requirement.

The Engineering Science courses represent cross-disciplinary areas that are applicable to many engineering and science departments. Alternatively, a survey course in Mechanical Engineering (ME 3601) can be taken in place of this Engineering Science requirement, and provides an excellent overview of those Mechanical Engineering topics of interest to ECE students.

MATHEMATICS AND SCIENCE

To succeed in the study of electrical and computer engineering, the necessary foundation far exceeds what can be taught in a few introductory courses. In fact, if you even want to begin to understand what your ECE professors are talking about in lecture, you must begin with a firm basis in mathematics and the natural sciences. Moreover, whether applied to ECE or not, proficiency in mathematics and the sciences is a necessary quality for *any* educated engineer. Consequently, the ECE major requires a total of 4 units (12 courses) as the “Mathematics and Basic Science” distribution requirement.

The first part of this requirement is sufficient education in mathematics. At least 7 of the 12 required courses must be in this area, including coursework in differential calculus, integral calculus, differential equations, discrete mathematics, and probability and/or statistics. To see which specific courses fulfill these math requirements, please consult the mathematics course descriptions, the *Planning a Program in ECE* section, and your academic advisor.

The other part of the requirement is coursework in the sciences. A solid understanding of physics is essential to

any ECE student, being ultimately necessary for describing the behavior of electricity and magnetism as well as other physical phenomena. Knowledge of chemistry is useful as well, encompassing such topics as atomic and molecular behavior and the chemical properties of materials (such as silicon, which is quite useful in ECE). In recent years, knowledge of biology has also become important to electrical and computer engineers, particularly as biomedical-electrical technologies such as medical imaging continue to advance.

The ECE major requires at least 3 courses in the sciences, 2 of these courses must be in physics, and the remaining course may be in chemistry or biology depending on preference.

Finally, note that the total prescribed mathematics and science courses add up to 3 1/3 units (10 courses). To meet the distribution requirement, you then must take at least 2 more courses in any area of mathematics or science (that is, any other course with the prefix “MA”, “PH”, “CH”, “BB”, or “GE”).

PLANNING A PROGRAM IN ECE

The following section is intended to be a guide for planning your ECE degree program. Of course, it is by no means a *complete* guide—you should consult several other important sections of this catalog for further information. These sections include WPI’s general degree requirements, information regarding the three required projects (Sufficiency, IQP, MQP), and the specific descriptions for any courses we have mentioned. Also, be sure to consult your academic advisor in any matters related to the course scheduling and the fulfillment of degree requirements.

A NOTE ON ACADEMIC ADVISING

Our department—and WPI as a whole—offers you the opportunity of an education that is highly individualized. As no two students are identical in terms of their academic skills, interests, and aspirations, no two students should have identical academic programs. This chance to tailor a degree program to your individual needs is indeed a great opportunity, and the burden of seizing such an opportunity falls primarily on you, the student. However, adapting to WPI’s complex system of courses, projects, and other degree requirements is certainly not an easy task.

Fortunately, you possess a great set of resources to help you, including your peers, the faculty and staff of the ECE department—and most importantly—your academic advisor. As you proceed through your years of undergraduate education, always remember that your academic advisor can be of great assistance. He or she is a source of advice and information, helping you with decisions about what courses to take, what projects to pursue, your personal and professional development, and how ultimately to make the most of your WPI experience. Your academic advisor can even help you find a job or get accepted to a graduate program.

As you get to know your academic advisor, remember: though he or she may contribute as much guidance as possible, most of the effort in planning your program must come from you. If you simply cannot work well

with your academic advisor for any reason, it is your responsibility to find one with whom you are more comfortable.

FIRST YEAR

Planning your first year at WPI may appear confusing and difficult, especially since there are so many different options. This section will help you make sense of these options, and identify the courses that are most important to complete freshman year. Always remember, though, that there is no single “perfect” academic program.

As mentioned earlier, before you can begin coursework in the ECE Department, you need a proper foundation in mathematics. You should begin by completing differential and integral calculus as soon as possible. If you have insufficient background in pre-calculus topics, you may begin with the semester-long MA 1020 course. If not, then you should begin with MA 1021. In either case, you should definitely follow with MA 1022. Students with a background in high school calculus (such as an AP course) may skip ahead to begin with MA 1022, MA 1023, or even MA 1024. Consult your advisor to find out which starting point is right for you. Incidentally, note that MA 1020/1021 and MA 1022 fulfill the differential and integral calculus part of the “Mathematics and Basic Science” distribution requirement.

The next step in planning your first year is to address the science requirement. The physics courses most directly relevant to ECE are PH 1120 or PH 1121 (which deal with electricity and magnetism) and PH 1140 (which deals with oscillations and waves). When choosing physics classes, be sure to pay attention to any recommended background such as calculus. You may also consider taking a chemistry or biology course in your first year. We encourage students to investigate further any mathematics or science courses that they find interesting; as always, consult your academic advisor for help.

For many students—in particular those with little experience in programming—first year is the best time to address the computer science requirements of the ECE major. For students with a moderate background in computers, either CS 1101 or CS 1102 provides a suitable introduction to programming concepts. You may then continue on to more advanced computer science courses such as CS 2301.

If you have planned properly, you should be ready to begin coursework in ECE by the spring semester of your freshman year. The first course for all students should be ECE 2011, usually followed by ECE 2022. A majority of ECE students begin their major coursework with ECE 2011 in C-term of their first year, followed by ECE 2022 in D-term. If you feel that you are not ready to take ECE 2011 by C-term, you can wait until A-term of your sophomore year. Whenever you begin with your major coursework, be sure to complete the recommended background for ECE 2799 in time to take it in your sophomore or junior year.

In addition to all of your major coursework and its related background, do not forget that, at some point, you will need to complete a Sufficiency project! You may want to schedule some Sufficiency-related coursework for your first year, especially if you want to complete the project in

your sophomore year. Also, as social science courses, such as economics, are typically helpful for the IQP, you may want to take those courses as soon as possible (or at least at some point before your junior year). Finally, do not forget the physical education requirement.

In choosing your courses for first year, keep in mind that the WPI degree requirements call for three “free elective” courses; if you pass all of your classes at WPI, you will end up with a total of six courses which you can choose with no restrictions whatsoever. This flexibility can be used for a variety of purposes, such as pursuing another major or minor, delving deeper into your Sufficiency area, honing your skills within your major beyond the minimum courses required, or even just taking a few extra courses that interest you. In other words, do not be afraid early on to take a course simply because it may not be “worth credit” toward your degree. The first year is a great time to explore the wide array of topics a WPI education has to offer.

SOPHOMORE YEAR

As you plan for your sophomore year, one important task will be to continue progress in your major. This process is assisted by careful planning on your part, particularly if you want to take ECE 2799 by D-term of your second year.

The following tables display two examples of desirable course sequences for an ECE student. Both show series of courses that would allow a student to arrive at ECE 2799 in D-term with the proper recommended background (without considering such factors as recommended mathematics or science).

Example #1:

Term		Course
Freshman	C	ECE 2011
	D	ECE 2022
Sophomore	A	ECE 2111
	B	ECE 2311
	C	ECE 2201 or ECE 2801
	D	ECE 2799

Example #2:

Term		Course
Freshman	C	ECE 2011
	D	ECE 2022
Sophomore	A	ECE 2201 or ECE 2801
	B	ECE 2311
	C	ECE 2111
	D	ECE 2799

Of course, if you desire even greater flexibility in your schedule, there are many paths besides these two. For example, you may take two ECE courses concurrently in a term, provided that one is not recommended background for the other. Also, you may wait until B-term of your jun-

ior year to take ECE 2799; this decision may be helpful if you chose not to start your ECE classes until later, or if you want to have a stronger background in ECE, mathematics, or science before attempting the course. However, we do advise against waiting until the *end* of junior year (or later) to take ECE 2799, as it may hinder your ability to find an MQP on time.

By the end of sophomore year, you should have finished taking most of your mathematics and science classes, as these courses serve as background for further work in your major. Also, all ECE students should complete the computer science requirement in this year, if they have not yet done so.

Many students choose to complete their Sufficiency project in the sophomore year. If you have finished the 5 courses requirement for the Sufficiency, then you may consider this option. Before you schedule your project, be sure to find and approach an advisor with whom you would like to work. On the other hand, if you did not make much progress in completing humanities courses as a freshman, you should do so in this year. Do not feel rushed, though—you do not necessarily have to complete your Sufficiency requirement as a sophomore. Some of the best Sufficiency projects at WPI are completed by juniors and seniors, so feel free to schedule your work in the humanities in a way that best suits you.

Another important task in your second year is to investigate WPI's "Global Perspective Program". Many WPI students perform their IQP at an off-campus project site; this is especially true in the ECE Department. However, if you are planning to complete your IQP off-campus as a junior, the application process begins in your *sophomore* year. For more information about off-campus projects, see the "Projects" section of this catalog, or contact the Interdisciplinary and Global Studies Division (IGSD).

Finally, keep in mind that by the end of sophomore year, you should be sufficiently educated in ECE to attempt an internship in industry during the following summer, if you so desire. If you are interested, be sure to talk to your academic advisor, and investigate the resources available at WPI's Career Development Center.

JUNIOR YEAR

With all the freshman- and sophomore-level background finally completed, your third year of education in the ECE department offers you a chance for greater flexibility and control over your degree program. However, if you have yet to do so, your first priority is to complete ECE 2799. Also, once the design course is completed, you should finish the remaining courses in the advanced core as soon as possible.

After that, you will finally have a chance to branch out into the many other ECE courses we offer. When choosing major courses for the junior year, be sure to seek a balance between depth and breadth. On one hand, there is a wide selection of 3000-level courses from which to choose, extending the basic and advanced core into even more areas of ECE. These courses will allow you to explore more of the discipline, and gain even greater proficiency in any of the core areas you may have found interesting. On the other hand, if you are particularly interested in a single sub-discipline, you may be ready by the end of junior year to at-

tempt a 4000-level course (depending on course on the specific class and its recommended background).

Despite the opportunities available to you in ECE, the most substantial component of your work junior year will most certainly be your Interactive Qualifying Project. If you are planning to complete your IQP off-campus, be sure to take additional care in planning your courses around the term that you will be away. Also, in the term before you leave, off-campus projects typically require 1/3 unit or more of preparatory work. You should take this extra burden into account as part of the workload for that term.

Yet another key undertaking of the junior year is your responsibility to find an MQP. If you are planning to do the project off-campus as a senior, you will need to follow an application procedure similar to that of off-campus IQPs. If you are planning to complete the project on-campus, then the efforts needed to find a project may vary greatly. You may need to apply to and interview for certain industry-sponsored MQP programs, or you might contact a professor in the department who has advertised a specific project he or she wants to advise. Consult with your academic advisor about what types of projects interest you, and what approach is best to secure an MQP for the next year.

Finally, do not forget about your Sufficiency, your social science courses, the ES requirement, and your physical education classes.

SENIOR YEAR

Depending on how well you have done in developing your degree program in the previous three years, planning for senior year can be a breeze—or a disaster. However, even if you are new to the idea of taking academic planning seriously, there is still plenty you can do to ensure that you will be walking across the stage on graduation day.

By far, the most important part of your senior year is your MQP. The ways of scheduling your project are quite varied, depending on the type of project, location, students, and advisors. Off-campus MQPs last for about 1 term, and are offered at various locations (see "Off-Campus MQP Opportunities" in the "Overview of ECE Program Components" section). A typical on-campus MQP usually requires 1/3 unit of work in three consecutive terms—commonly A-term through C-term of the senior year. From time to time senior projects may run longer, extending into D-term. Any student wishing to graduate on time, however, must remember two things: (1) all MQP students must be ready to give their final presentations on the annual Project Presentation Day in April, and (2) the final MQP report, with the proper accompanying paperwork, must be submitted by the registrar's specified deadline.

If your MQP is on the right track, the next step is to choose your remaining ECE courses, which can be accomplished in many different ways. Some students select courses that will directly help them in an upcoming job or graduate program. Other students choose courses to supplement the topics they are covering in their MQP. Some use the remaining courses to expand their breadth of knowledge into an area where they are weak, while others use senior year to take those one or two 4000-level

ELECTRICAL AND COMPUTER ENGINEERING COURSE FLOW CHART

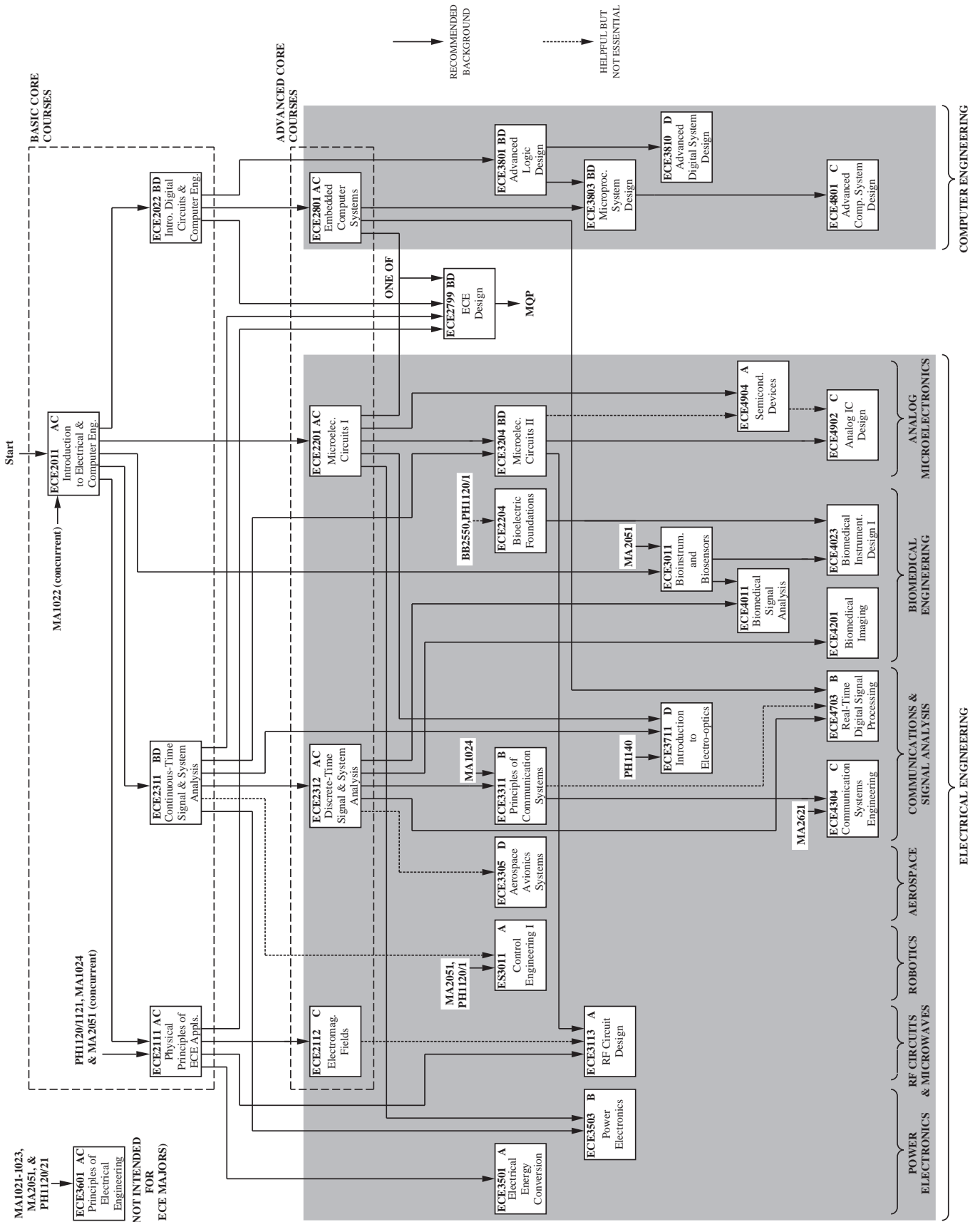

courses in areas where they desire more expertise. All of these approaches are valid; the important thing is to think critically about your academic goals, and choose a path that best fits your current academic program, while allowing you to explore courses that appear interesting.

Besides your remaining major coursework, your plan for senior year must include everything else you need to complete to graduate. For example, some students choose to do their Sufficiency project senior year. Also, do not forget the many other degree requirements that we have repeatedly mentioned—you certainly do not want to graduate late because you forgot 1/12-unit physical education class! Be sure to have your academic advisor check your course plan at the beginning of senior year, to verify that you have not overlooked anything.

GRADUATION AND BEYOND

There is one essential task of any senior year student that we failed to mention in the previous section. As the year progresses, seniors have to plan for the “next step”—their lives *after* graduation.

A common direction for students to choose upon graduation is full-time employment. The job-seeking process is not always easy, requiring mastery of many important life skills, such as writing a resume or participating in a job interview. Fortunately, there are many resources available to aid you in this process, including the Career Development Center, your academic advisor, other professors, and your peers. One of the best places to network with potential employers is at any of the regularly scheduled “career fairs”, when companies send representatives to WPI to search for qualified applicants. Also, do not forget to utilize the internet as a tool for publishing resumes and investigating potential employers. Since a thorough and comprehensive job search can last several months, be sure to start early.

Another option is to continue with a program of academic study—typically a graduate degree. If you wish to begin study in the fall semester, realize that most graduate schools set their application deadlines in December or January, and the deadlines for many fellowship competitions may occur even earlier. In any case, if you are interested in beginning a graduate program directly after graduation, you should be investigating potential schools, the programs they offer, and any fellowships or scholarships that may be available by the end of your junior year and during the following summer. Once again, the Internet can provide invaluable assistance during this effort. Note that many graduate school and fellowship applications require you to take certain standardized tests, such as the Graduate Record Examinations (GRE’s). Be sure to investigate thoroughly dates of preparation courses, test dates, and the delay time for receiving test results. You must allow time to prepare for and take all the necessary tests, and still receive the results in time to use with your graduate applications. Finally, do not forget that a degree in ECE is useful for far more than a future in engineering. The degrees we offer are excellent preparation for a wide array of graduate studies, including education, business, or law.

When choosing one of these routes, keep in mind that here in the ECE department, we expect from you a com-

mitment to lifelong learning. In other words, even if you choose not to continue immediately with your formal studies, it does not mean the end of your education! First of all, there is always the chance to learn within a job in industry, through projects, training programs, and other learning opportunities. Furthermore, many students decide to return to graduate school after a few years of working, often finding that such “real-world” experience is a great advantage upon returning to academia. Regardless of the path you choose after leaving the ECE department, always remember that your WPI degree (while extremely valuable) is certainly not the end of your education—it is only a foundation for years of learning yet to come.

STUDENT GROUPS IN ECE

A good way to ensure a commitment to lifelong learning is through membership in engineering-related organizations such as professional societies. Professional societies are a vital aid to the dissemination of technical knowledge, helping engineers in industry remain abreast of recent discoveries. Accordingly, we encourage you to include membership in these kinds of organizations as part of your cocurricular activities.

With more than 350,000 members, the Institute of Electrical and Electronics Engineers (IEEE) is the world’s largest technical professional society. The IEEE supports a number of student chapters, which are responsible for more than 50,000 of its active members. The IEEE student chapter at WPI is particularly active: in addition to managing the undergraduate lounge on the first floor of Atwater-Kent Laboratories, student members host department-wide events such as information sessions, guest speakers, and barbecues. Another student group is WECE (Women in Electrical and Computer Engineering), which offers women students a chance to meet and discuss academics, employment, and other opportunities in ECE.

Students in the ECE department are also eligible for nomination to various honor societies. Eta Kappa Nu (HKN) is the international honor society for students in electrical and computer engineering. In addition to honoring outstanding students in the department, HKN organizes a number of activities, awards, and scholarships. Exceptional students in the ECE department are also eligible to become elected members of Tau Beta Pi (TBP), the international honor society for all engineering students. For both societies, students exhibiting the necessary qualities of scholarship, leadership, and character are approached for membership in either their junior or senior year of study.

TRANSFER STUDENTS

Since the ECE department’s introductory curriculum is different from the traditional program offered at many other schools, transfer students must be sure to confer with their advisor to plan their WPI program. Transfer students with no previous ECE courses should begin the program in the same way as first-year students. Students with some transfer credit may be able to omit one or more of the introductory courses. Those with one or more courses in circuit theory and substantial laboratory experience should consider omitting ECE 2011, and possibly

one or more of the other basic core courses, but this should only be done after consultation with an academic advisor.

INFORMATION FOR NON-MAJORS

Students who wish to develop a background in electrical and computer engineering are advised to consult with a faculty member in the ECE Department. A basic foundation in electric circuits and electronics may be obtained by taking ECE 2011, ECE 2111, ECE 2201, and ECE 2311. A basic foundation in the elements of computer engineering may be obtained by taking ECE 2011, ECE 2022, ECE 2801, and ECE 3801. An overview of basic electric circuits can be obtained by taking ECE 3601.

Electrical and computer engineering may be coupled with other areas of study to define a unique interdisciplinary program. Students contemplating such an innovative program should contact the Interdisciplinary and Global Studies Division for guidance and approval, especially with regard to the selection of a suitable MQP and arrangements for program-specific distribution requirements; see *Interdisciplinary Programs* for more information.

MINOR IN COMPUTER ENGINEERING

This interdisciplinary minor requires students to develop competence in areas of computer engineering, including both hardware and software aspects of computer systems. This minor is not available to students majoring in Electrical and Computer Engineering.

Selected Rules for a Minor include the following:

1. Two or more units of thematically related activity.
2. Concluding 1/3 unit of the Minor must be a capstone experience.
3. A Minor may include any portion of the academic program, *excluding* the MQP.
4. At least one-unit of the Minor, including the capstone activity, must be free electives.
5. The Program Review Committee for a Minor area will consist of faculty members designated by the sponsoring faculty members.

In order to be eligible to receive the Computer Engineering Minor designation, at least six computer engineering related ECE and CS courses must be included in the distribution requirements, listed below. Other appropriate courses may be substituted with the approval of the Computer Engineering Minor Program Review Committee.

A. At least three of the following ECE courses must be included.

- ECE 2801* Foundations of Embedded Computer Systems
*(cannot be counted if CS 2011 is also selected)
- ECE 3801 Advanced Logic design
- ECE 3803 Microprocessor System Design
- ECE 3815 Digital System Design with VHDL
- ECE 3810* Advanced Digital System Design
*(cannot be counted if either ECE 3815 or ECE 3902 is also selected)
- ECE 3902 Introduction to VLSI Design
- ECE 4801 Advanced Computer System Design
- ECE 505 Computer Architecture

B. At least three of the following CS courses must be included.

- CS 2011* Introduction to Machine Organization and Assembly Language
*(cannot be counted if ECE 2801 is also selected)
- CS 3013 Operating Systems
- CS 3733 Software Engineering
- CS 4513 Distributed Computing Systems
- CS 4514 Computer Networks
- CS 4515* Computer Architecture
*(cannot be counted if ECE 505 is also selected)

C. Capstone Courses

The following courses may be used to satisfy the Computer Engineering minor capstone requirement: ECE 3803, ECE 3815, ECE 3810, ECE 3902, ECE 4801, CS 4513, CS 4514, CS 4515.

The Program Review Committee for the Computer Engineering Minor will be composed of Prof. W. R. Michalson (ECE) and Prof. M. J. Ciaraldi (CS). To apply for the Computer Engineering Minor designation, **fill out the application form and return the form to the Computer Engineering Minor Coordinator (W.R. Michalson, ECE Department).**

ENGINEERING SCIENCE COURSES

In the formation of a program of study for any engineering or science student, it is important to emphasize a significant number of interdisciplinary courses which form the fundamental building blocks of so many scientific and engineering activities.

In addition to those courses in science and mathematics which are an important part of every engineer's background at WPI, there are a number of courses containing subject matter common to a variety of disciplinary interests. These courses are known as the "engineering science group" and are often taught jointly by members of more than one department.

Every engineer, for example, needs to have some knowledge of graphics, the communications tool of engineering; of thermodynamics, the consideration of an important aspect of energy and its laws; of mechanics, solid and fluid, static and dynamic, the treatment of forces and their effects on producing motion. These and certain other courses of either basic knowledge or broad application are grouped in the engineering science series to provide special focus on them for all students interested in applied science or engineering. In developing programs to meet engineering science distribution requirements, students and advisors should give careful attention to these engineering science courses.

ENGINEERING PHYSICS

ADVISOR: J. W. NORBURY

Programs of study in Engineering Physics are listed under the Physics Department. These programs include specialization in such areas as computational techniques, optics, electromagnetism, materials science and engineering, nuclear science and engineering, and thermal physics.

ENVIRONMENTAL PROGRAMS

Our relationship to the environment poses many and often complex problems. Solving these problems may require knowledge of science, technology, engineering, law, social policy, philosophy, history, literature, and the arts. In addition to enabling students to become effective scientists and engineers, programs offered at WPI can prepare students to pursue interests and careers in environmental journalism, environmental law, the EPA or other government programs, international contexts of development and conservation, environmental education, and professional environmental activism.

Students should review these programs as listed below, and talk with their academic advisors and the respective program coordinators, to help make a good choice of environmental major at WPI. In every program, the WPI project requirements, both in the major field and the IQP, will provide unusually strong support for defining specific career directions. Students are also urged to make use of the "Global Perspective Program" to carry out one project abroad, and thus attain a sense of environmental studies at a global, cross-cultural level.

For information, please contact Prof. Lance Schachterle, les@wpi.edu or 508-831-5514.

ENVIRONMENTAL ENGINEERING

Civil/Environmental Engineering with Emphasis on Water Quality Control

Coordinators: Profs. O'Shaughnessy, Hart, Mathisen, Plummer, or Bergendahl, Civil Engineering

The Department of Civil Engineering at WPI provides courses leading to an ABET-accredited degree in Civil Engineering. Areas of concentration include the planning, design, construction, operation and regulation of water quality control systems related to water supply and waste treatment. Related issues include public health and solid waste management. The engineering focus is in the area of large systems associated with municipal and other public projects.

Students majoring in this program would follow a general curriculum in Civil Engineering, with emphasis on the environmental engineering subarea. Such preparation leads to a degree recognized by the professional accrediting organization, ABET (Accreditation Board for Engineering and Technology), and is an excellent start for entry-level professional placement or graduate study in environmental engineering.

For information, please contact Prof. Fred Hart, fhart@wpi.edu or 508-831-5421.

Chemical/Environmental Engineering with Emphasis on Pollution Prevention and Abatement Technology

Coordinators: Profs. Comesano, Thompson, Ma, Dixon, DiBiasio, Kazantsis, or Clark, Chemical Engineering

The Department of Chemical Engineering at WPI provides a general curriculum leading to an ABET-accredited degree in chemical engineering. Undergraduates can become involved in a specialty area of environmental engineering through their MQP or other independent projects, and are encouraged to work with faculty in their own areas of research in these fields. Today's chemical engineers are challenged to help maintain industrial competitiveness while ensuring a healthy environment. Chemical engineers with environmental emphasis design and develop environmentally benign chemical processes aimed at preventing pollution at its source by recycling or eliminating all hazardous components. Additionally, they are involved in developing environmentally friendly products like biodegradable packaging materials. Chemical engineers' understanding of the physical and chemical properties of pollutants makes them uniquely qualified to develop technical solutions to current environmental problems of soil, water, and air pollution.

Students majoring in this program would follow a general curriculum in Chemical Engineering, with elective coursework in environmental engineering and environmental related project work. Such preparation leads to a degree recognized by the professional accrediting organization, ABET (Accreditation Board for Engineering Technology), and is an excellent start for entry-level professional placement or graduate study in environmental engineering.

For information, please contact Prof. Robert Thompson, rwt@wpi.edu or 508-831-5525.

Manufacturing/Environmental Engineering with Emphasis on Environmentally-Conscious Manufacturing

Coordinator: Prof. Sisson, Manufacturing Engineering

The Manufacturing Engineering program at WPI provides a general curriculum leading to an ABET-accredited degree in manufacturing engineering. Undergraduates can become involved in a specialty area of environmental engineering through their MQP or other independent projects, and are encouraged to work with faculty in their own areas of research in these fields. One of the fastest growing research areas within manufacturing engineering is that of design for the environment and environmentally-conscious manufacturing. Since manufacturing engineering is multi-disciplinary by nature, students can join the program with interests in environmental engineering, computer science, management, and electrical or mechanical engineering, or with other interests.

Students majoring in this program would follow a general curriculum in Manufacturing Engineering, with emphasis on environmental engineering course and project

work. Such preparation leads to a degree recognized by the professional accrediting organization, ABET (Accreditation Board for Engineering and Technology), and is an excellent start for entry-level professional placement or graduate study in environmental engineering, manufacturing engineering, or management.

For information, please contact Prof. Richard Sisson, sisson@wpi.edu or 508-831-5335.

ENVIRONMENTAL SCIENCES

Biology-Biotechnology/Environmental Sciences

Coordinator: Prof. D. Gibson, Biology & Biotechnology

The department of Biology & Biotechnology offers a curriculum leading to a degree in Biology & Biotechnology with lab and field opportunities to focus on studies in Ecology and Environmental Biology. Relevant topics under investigation by the departmental faculty include bioremediation, conservation ecology, and micro environmental regulation of growth and development in bioreactors. Course work in marine ecology is also available off campus through a cooperative arrangement with the Marine Biological Laboratory in Woods Hole. Each fall the Marine Biological Laboratory in Woods Hole and a consortium of colleges and universities sponsor a semester of study in environmental sciences, explored through the perspective of ecosystems ecology. Students participating in the SES will be housed and study at the Marine Biological Laboratory for 15 weeks. Study will include core courses in terrestrial and aquatic ecosystems, seminar series in science and science writing, and elective courses in specific areas of ecology and ecosystems. Each student will also complete an independent research project. Entrance into the program is competitive. Prospective applicants will be prescreened by a selection committee at WPI. Final applications are reviewed by a committee appointed by the director of MBL which makes the final selection.

Students with Biology & Biotechnology degrees will be prepared for entry-level professional work, or for graduate studies leading to a master's or doctoral degree.

For information, please contact Prof. Daniel Gibson, dgibson@wpi.edu or 508-831-5144.

ENVIRONMENTAL ECONOMICS AND PUBLIC POLICY

Social Science and Policy Studies

Coordinators: Profs. Saeed or Rissmiller, Social Science and Policy Studies

The Department of Social Science and Policy Studies offers a degree program in Environmental Policy and Development that emphasizes sustainability. The program takes a multidisciplinary approach to environmental issues and includes coursework in economics, public policy, law, and psychology. Students can also pursue

degrees in Economic Science, Society, Technology, and Policy, and System Dynamics with an environmental emphasis.

Students majoring in one of these SSPS programs will be prepared for entry-level professional work, or for graduate study either for the MBA or a master's or doctoral research program.

For information, please contact Prof. Khalid Saeed, saeed@wpi.edu or 508-831-5563.

ENVIRONMENTAL STUDIES

Humanities/Environmental Studies

Coordinator: Prof. R. Gottlieb, Humanities & Arts Department

The Humanities Department at WPI offers a general curriculum leading to degrees with concentrations in literature, philosophy and religion, and history. Students interested in humanistically-oriented environmental studies could major in the humanities, and take a specifically designed program involving one or more of these areas. Career possibilities upon graduation would include law, business, government service, environmental activism, journalism, or graduate study in the humanities.

For information, please contact Prof. Roger Gottlieb, gottlieb@wpi.edu or 508-831-5439.

Interdisciplinary Environmental Studies

Coordinator: Prof. Davis, Interdisciplinary and Global Studies Division

Students wishing to design their own unique program in any field of environmental studies at WPI can do so through the Interdisciplinary and Global Studies Division (IGSD). Such a program might, for example, involve roughly equal areas of study in biology and biotechnology, chemical engineering, and social science and policy studies. Many other possible combinations also exist, with differing levels of study in both scientific and technological disciplines, and in social sciences, policy studies or humanities (ethics). Examples of areas for major study include (but are not limited to):

- identification and production of micro-organisms to remove heavy metals from the water supply, and
- technical writing for environmental organizations.

Interdisciplinary programs are coordinated through the IGSD, and advised by a panel of three faculty from different disciplines. Many students also explore the course offerings at Clark University and the College of the Holy Cross, which are available at no cost through the Worcester Consortium. Students with interdisciplinary programs will be prepared for entry-level professional employment or graduate study.

For information, please contact Prof. Paul Davis, pwdavis@wpi.edu or 508-831-5212.

FIRE PROTECTION ENGINEERING

KATHY A. NOTARIANNI, HEAD;

PROFESSORS: J. R. Barnett, R. E. Zalosh

ASSOCIATE PROFESSORS: , N.A. Dembsey,

F. Noonan, K. A. Notarianni, B. J. Savilonis

ASSISTANT PROFESSOR: J. P. Woycheese

AFFILIATE PROFESSORS: W. K. Kim, E. S. Yoon

EMERITUS PROFESSOR: R. W. Fitzgerald

DIRECTOR EMERITUS: D. A. Lucht

MISSION STATEMENT

To deliver a high quality fire protection engineering education program for both full-time students and practicing professionals, supported by fire research in selected areas of strength.

EDUCATIONAL GOALS

- To deliver a comprehensive fire protection engineering degree/certificate program that is consistent with changes in technology and the environment.
- To maximize the use of educational technology to deliver for-credit courses to both part time and full time students, on and off campus worldwide.

INTRODUCTION

Fire Protection engineering is one of the best kept secrets in research and education today.

Fire protection engineers apply science and engineering principles to save lives and property from fire. The best engineers in the world bring their skills and talents to bear on this international problem. Grounded in disciplines such as mechanical, civil, structural, electrical, and chemical engineering and the sciences, they often work in teams to apply cutting edge research tools to address the new challenges of the 21st century. The threats of terrorist attacks, the safe use of new composite materials, the impact of natural disasters are just some of the challenges facing today's fire protection engineers.

Good paying jobs abound in business, government and industry...including consulting engineering firms, petrochemical industries, insurance companies, federal agencies, health care facilities, code enforcement agencies...and the list goes on. The number of jobs consistently outweighs the number of engineers available to fill them.

Fire protection engineers do fire experimentation and research. They perform risk analyses of major industrial facilities and consult with architects on buildings ranging from high rise structures to hospitals, hotels and sports stadiums. They engineer safe buildings, ships, trains, and other facilities using the latest principles of performance based design. Fire protection engineers design egress systems based on human behavior and protective compo-

nents such as fire sprinkler and alarm systems, exit and smoke control systems. They investigate fires and explosions, and assure safety in diverse areas such as the NASA space program, and the US base in Antarctica.

And the good news is WPI offers one-of-a-kind degree programs for students pursuing degrees including a research based PhD and a master's degree in fire protection engineering with or without a thesis. There is a special program for high school graduates...to give them the best possible credentials for entering this interesting and lucrative job market. It's the five year program, ending with a BS in one of the traditional engineering disciplines (e.g. mechanical, electrical, civil, chemical engineering) and the master's degree in fire protection engineering. Our unique distance learning program can lead to a master's degree or a fire protection engineering graduate certificate. Contact Professor Kathy A. Notarianni at the department of Fire Protection Engineering to find out more.

COMBINED-DEGREE PROGRAM

A combined-degree program is available for those undergraduate students having a strong interest in fire protection. This program provides students with the opportunity to accelerate their graduate work by careful development of their undergraduate plan of study leading to a B.S. degree in a field of engineering and a master's degree in fire protection engineering. The combined-degree approach saves time and money since up to 40 percent of course credits counted towards the master's degree can also be counted toward the bachelor's degree. Holders of B.S. degrees in traditional engineering or science disciplines and the master's degree in fire protection engineering enjoy extremely good versatility in the job market.

FIRE PROTECTION ENGINEERING FIVE-YEAR PROGRAM

High school seniors can be admitted to the combined-degree program as freshmen, allowing them to complete both a bachelor's degree in a selected field of engineering and the master's degree in fire protection engineering in five years.

GRADUATE INTERNSHIPS

A unique graduate internship program is available, allowing students to gain important clinical experiences in practical fire protection engineering and research environments. Students are able to earn income, alternating work and on-campus classroom and laboratory activities.

HUMANITIES AND ARTS

P. J. M. QUINN, HEAD

PROFESSORS: F. Bianchi, J. J. Brattin, S. C. Bullock, D. B. Dollenmayer, R. S. Gottlieb, J. P. Hanlan, K. P. Ljungquist, J. Manfra, W. T. Mott, P. J. M. Quinn, L. E. Schachterle, J. Trimbur, S. Vick
 ASSOCIATE PROFESSORS: W. A. B. Addison, Jr., P. H. Hansen, L. D. Higgins, E. M. Parkinson, A. A. Rivera, M. D. Samson, R. L. Smith
 ASSISTANT PROFESSORS: M. K. Ephraim, H. J. Manzari, J. Rosenstock, J. Sanbonmatsu, E. Shim
 ADJUNCT FACULTY: W. A. Baller, M. A. Barroll, E. Y. Choi, J. Delorey, J. Dempsey, C. R. Dahm, S. Even, R. G. Falco, J. L. Forgeng, D. E. Gray, M. Manzari, I. E. Matos-Nin, B. L. McCarthy, F. McGarrell, S. Nikitina, R. J. Njoroge, D. O'Donnell, J. R. Policelli, D. A. Rawson, S. Runstrom, J. T. Sands, D. A. Shikiar, D. J. Spanagel, J. E. Watters, D. G. Weeks, J. Zinn
 PROFESSORS EMERITUS: L. Curran, E. Hayes, C. Heventhal, D. McKay, L. Menides, T. Shannon, M. Sokal, J. Zeugner

MISSION STATEMENT

We are committed to helping students develop both a knowledge of, and an ability to think critically about, the humanities and arts. We also seek to foster the skills and habits of inquiry necessary for such learning: analytical thought, clear communication, and creative expression. Such an education, we believe, provides a crucial foundation for responsible and effective participation in a complex world.

INTRODUCTION

The humanities and arts—art history and architecture, drama/theatre, foreign languages, history, literature, music, philosophy, religion, and writing/rhetoric—are central to WPI's vision of the new "liberal education." All WPI undergraduates devote a significant portion of their academic program to the humanities and arts either through a "Humanities and Arts Sufficiency Program" or through a major, double-major, or minor in the department.

The humanities and arts promote intellectual curiosity and maturity by developing the essential skills for further study and lifelong learning. These include the ability to think critically, to write and speak clearly and persuasively, to appreciate and cultivate the literary and aesthetic arts, and to understand the rich cultural diversity of the world in the past and present. Students in the humanities and arts grapple with fundamental questions of justice, value or meaning through reading, observation, creation, interpretation, and performance. These are, in fact, the activities of the highly productive Humanities and Arts faculty, which is well regarded for research, publication and creative work. Through the humanities and arts, the faculty enable students to gain self-knowledge and to broaden cultural horizons.

The Department of Humanities and Arts offers a variety of opportunities for students to pursue personal interests. The Department offers an interdisciplinary curriculum, in which students may investigate multifaceted topics using a variety of approaches. The major or double-major in Humanities and Arts is interdisciplinary in scope (see page 130). In addition, the Humanities and Arts Sufficiency Program may culminate in a thematic project that integrates previous courses from several areas of the humanities and arts. The Sufficiency Program also might result in a theatrical or musical performance or in proficiency in a foreign language. Students should also consider unique opportunities to complete a Sufficiency Project at a Global Project Center. (For details of the Sufficiency Program, see page 53.)

The close working relationship among students and faculty in the humanities and arts at WPI promotes academic excellence, innovative thinking, and mutual respect. In short, the Humanities and Arts Department is committed to helping students develop both a knowledge of, and the ability to think critically about, the humanities and arts. We also seek to foster the skills and habits of inquiry necessary for such learning—analytical thought, clear communication, and creative expression. Such an education provides a crucial foundation for responsible and effective participation in a complex world.

HUMANITIES AND ARTS MAJOR

The Humanities and Arts major requires six units of work, including the MQP. Students take courses from across the humanities and arts, but may choose to focus their program of study by completing a Concentration as described below.

The major or double-major in Humanities and Arts is excellent preparation for a variety of careers. Humanities and Arts graduates from WPI have gone to law, business, and medical schools, as well as to graduate programs in the discipline of their Humanities and Arts concentration. Some graduates have pursued careers as writers, teachers, engineers, or scientists. Other students have found work in the theatre as actors, technicians, or playwrights, or in music as composers or performers. The advantages our graduates find in their pursuit of further study and careers are the advantages of a rigorous study of the liberal arts: a good foundation in our cultural traditions and the cultural diversity of the world, and strong skills in research, analysis, writing, literary and musical composition or performance.

In addition, since each Humanities and Arts major completes either a "technical sufficiency" or a double major in a technical field, our graduates receive unique preparation as technological humanists. This educational experience gives them a distinct advantage in many fields in which a solid knowledge of engineering or science is increasingly valuable, such as environmental studies, drama/theatre, or business. The Humanities and Arts major equips students with vital general professional skills and with broad cultural and technical perspectives. Our many courses devoted to international issues or to foreign languages, and the active involvement of Human-

ities and Arts faculty in the university's global programs provides superb training for technological humanists interested in international issues. Whatever their specific area of concentration, majors in the Humanities and Arts gain an intellectual curiosity and openness to the diversity of human cultural achievements that will enrich their lives and enhance their careers.

Program Distribution Requirements for the Humanities and Arts Major

1. Humanities and Arts (including MQP) (Note 1)	6
2. Electives (Note 2)	4

NOTES:

- Humanities and Arts majors may choose to complete 2 units of work and an MQP in one of the following areas of Concentration: History, Literature, Music, Philosophy, Religion, Drama/Theatre, Writing and Rhetoric, Art History, German Studies, Hispanic Studies, American Studies, Environmental Studies, or Humanities Studies of Science and Technology.
- May be from any area except Aerospace Studies, Military Science, or Physical Education. Courses used to satisfy other degree requirements (i.e. the IQP and the Sufficiency) may not be used to fulfill this requirement.

CONCENTRATIONS FOR HUMANITIES AND ARTS MAJORS

Humanities and Arts majors may focus their studies by choosing a Concentration within a specific area of the Humanities and Arts, or within an interdisciplinary area closely related to the Humanities and Arts. Concentrations within the Humanities and Arts Department comply with WPI's requirements for Concentrations. Students must complete an MQP and two units of integrated study in the area of their Concentration. Concentrations within the Humanities and Arts (History, Literature, Music, Philosophy, Religion, Drama/Theatre, Writing and Rhetoric, Art History, German Studies, Hispanic Studies) require two units of work in an area designated by specific disciplinary course prefixes, as described below. For example, a Concentration in History requires two units of HI courses at the 2000 level or higher and an MQP in history. Concentrations that are interdisciplinary in nature (American Studies, Environmental Studies, and Humanities Studies of Science and Technology) each require that courses be selected from specific lists of designated courses.

All of these Concentrations are excellent preparation for a variety of careers. Graduates of the Humanities and Arts major have gone to law, business, and medical schools, as well as to graduate programs in the discipline of their Humanities and Arts concentration. Some graduates have pursued careers as writers, teachers, engineers, or scientists. Other students have found work in the theatre as actors, technicians, or playwrights, or in music as composers or performers. The advantages our graduates find in their pursuit of further study and careers are the advantages of a rigorous study of the liberal arts: a good

foundation in our cultural traditions and the cultural diversity of the world, and strong skills in research, analysis, writing, or performance.

In addition, since each Humanities and Arts major completes a "technical sufficiency" or a double major in a technical field, our graduates receive unique preparation as technological humanists. This educational experience gives them a distinct advantage in many fields in which a solid knowledge of engineering or science is increasingly valuable, such as environmental studies, drama/theatre, or business. The Humanities and Arts major equips students with vital general professional skills and with broad cultural and technical perspectives. Our many courses devoted to international issues or to foreign languages and the active involvement of Humanities and Arts faculty in the university's global programs provides superb training for technological humanists interested in international issues. Whatever their specific area of concentration, majors in the Humanities and Arts gain an intellectual curiosity and openness to the diversity of human cultural achievements that will enrich their lives and enhance their careers.

REQUIREMENTS

Humanities and Arts with History Concentration

2 units of HI (2000 level or higher) and MQP in History

Humanities and Arts with Literature Concentration

2 units of EN, TH, or RH (2000 level or higher) and MQP in Literature

Humanities and Arts with Music Concentration

2 units of MU (2000 level or higher) and MQP in Music

Humanities and Arts with Philosophy Concentration

2 units of PY (2000 level or higher) and MQP in Philosophy

Humanities and Arts with Religion Concentration

2 units of RE (2000 level or higher) and MQP in Religion

Humanities and Arts with Drama/Theatre Concentration

2 units of TH, EN, or RH (2000 level or higher) and MQP in Drama/Theatre

Humanities and Arts with Writing and Rhetoric Concentration

2 units of RH, EN/WR, or TH (2000 level or higher) and MQP in Writing and Rhetoric

Humanities and Arts with Art History Concentration

2 units of AR or HU and MQP in Art History

Humanities and Arts with German Studies Concentration

2 units of GN (2000 level or higher) and MQP in German Studies

Humanities and Arts with Hispanic Studies Concentration

2 units in SP (2000 level or higher) and MQP in Spanish

HUMANITIES AND ARTS WITH AMERICAN STUDIES CONCENTRATION

This interdisciplinary concentration examines American culture from the multiple perspectives of American history, literature, and politics. American Studies at WPI takes advantage of the unparalleled resources at the American Antiquarian Society.

1. 1/3 units: one of the following courses: HU 1411 Introduction to American Studies, EN 1231 Introduction to American Literature, EN 1257 Introduction to African American Literature and Culture, HI 1311 Introduction to American Urban History, HI 1312 Introduction to American Social History, or HI 1314 Introduction to Early American History.
2. 2/3 units from List 1 ("American History")
3. 2/3 units from List 2 ("American Literature")
4. 1/3 units from List 3 ("American Politics, Law, and Policy"). This may not include courses taken to fulfill the Social Science Requirement.
5. MQP in American Studies

List 1. American History:

- HI 2311 American Colonial History
- HI 2313 American History, 1789-1877
- HI 2314 American History, 1877-1920
- HI 2315 The Shaping of Post-1920 America
- HI 2316 American Foreign Policy from Woodrow Wilson to the Present
- HI 2317 Law and Society in America, 1865-1910
- HI 2331 American Science and Technology to 1859
- HI 2332 American Science and Technology from 1859
- HI 3311 American Labor History
- HI 3312 Topics in American Social History
- HI 3314 The American Revolution
- HI 3333 Topics in American Technological Development

List 2. American Literature:

- EN 2221 American Drama
- EN 2231 American Literature: The Raven, the Whale, and the Woodchuck
- EN 2232 American Literature: Twain to the Twentieth Century
- EN 2233 American Literature: Twentieth Century
- EN 2234 Modern American Novel
- EN 2235 The American Dream: Myth in Literature and the Popular Imagination
- EN 2237 American Literature and the Environment
- EN 2238 American Realism
- EN 3221 New England Supernaturalism
- EN 3232 The Concord Writers
- EN 3233 Worcester Between the Covers: Local Writers and Their Works
- EN 3224 Modern American Poetry
- EN 3237 Pursuing Moby-Dick

List 3. American Politics, Law, and Policy:

- GOV 1301 U.S. Government
- GOV 1303 American Public Policy
- GOV 1310 Law, Courts, and Politics
- STS 1207 Introduction to Psycho-sociology of Science
- STS 2302 Science-Technology Policy

- GOV 2304 Governmental Decision Making and Administrative Law
- GOV 2310 Constitutional Law
- STS 2311 Environmental Policy and Law

HUMANITIES AND ARTS WITH ENVIRONMENTAL STUDIES CONCENTRATION

This interdisciplinary concentration combines course work from the humanities and arts, social sciences, and other areas to examine environmental issues.

1. 3/3 units from List 1 ("Designated Environmental Courses in Humanities")
2. 2/3 units from List 2 ("Related Environmental Courses in Social Sciences"). These may not include courses taken to fulfill the Social Science Requirement.
3. 1/3 units from List 3 ("Environmental Courses in Other Areas")
4. MQP in Environmental Studies

List 1. Designated Environmental Courses in Humanities:

- AR 2113 Topics in 19th- and 20th-Century Architecture
- EN 2237 American Literature and the Environment
- HI 1311 Introduction to American Urban History
- HI 1341 Introduction to Global History
- HI 2334 European Technological Development
- HI 3331 Topics in Science, Technology, and Society
- HI 3333 American Technological Development
- PY 2712 Social and Political Philosophy
- PY 2713 Bioethics
- PY 2717 Philosophy and the Environment

List 2. Related Environmental Courses in Social Sciences:

- ECON 2117 Environmental Economics
- ECON 2125 Development Economics
- GOV 2311 Environmental Policy and Law
- GOV 2312 International Environmental Policy
- PSY 2405 The Psychological Study of Environmental Issues

List 3. Environmental Courses in Other Areas:

- BB 2040 Principles of Ecology
- CHE 3910 Chemical and Environmental Technology
- CHE 3920 Air Quality Management
- CE 3059 Environmental Engineering
- CE 3070 Urban and Environmental Planning
- CE 3074 Environmental Analysis
- ME 3422 Environmental Issues and Analysis

HUMANITIES AND ARTS WITH HUMANITIES STUDIES OF SCIENCE AND TECHNOLOGY CONCENTRATION

This interdisciplinary concentration enables students to apply to the methods of the humanities and social sciences to the study of science and technology.

1. 2/3 units from List 1 ("Designated HSST Courses")
2. 2/3 units from List 1 or List 2 ("Closely Related Courses in Humanities")
3. 2/3 units from List 3 ("Science-Technology-Studies Courses in Other Areas"). These may not include courses taken to fulfill the Social Science Requirement.
4. MQP in Humanities Studies of Science and Technology

List 1: Designated HSST Courses

- AR 2113 Topics in 19th- and 20th-Century Architecture
 EN 2252 Science and Scientists in Modern Literature
 EN 3215 Genres of Science Writing
 HI 1331 Introduction to the History of Science
 HI 1332 Introduction to the History of Technology
 HI 2331 American Science and Technology to 1859
 HI 2332 American Science and Technology from 1859
 HI 2333 History of Science from 1700
 HI 2334 European Technological Development
 HI 3331 Topics in Science, Technology, and Society
 PY 2713 Bioethics
 PY 2717 Philosophy and the Environment

List 2: Closely Related Courses in Humanities

- AR 3112 Modernism, Mass Culture, and the Avant-Garde
 HI 1311 Introduction to American Urban History
 HI 2324 Industry and Empire in British History
 HI 3311 American Labor History
 HI 3323 Topics in the Western Intellectual Tradition
 PY 2711 Philosophical Theories of Knowledge and Reality

List 3: Science-Technology-Studies Courses in Other Areas.

- ID 3150 Light, Vision and Understanding and the Scientific Community
 STS 2208 The Science-Technology Debate
 GOV 2302 Science-Technology Policy
 GOV 2304 Governmental Decision Making and Administrative Law
 GOV 2311 Environmental Policy and Law
 GOV 2312 International Environmental Policy

DOUBLE MAJOR IN HUMANITIES AND ARTS

Students may pursue a double major in Humanities and Arts and in an area of science, engineering, or management. To pursue the double major, a student must satisfy all of the degree requirements of the technical discipline including an MQP and Distribution Requirements. In addition, the double major in Humanities and Arts requires 6 units of studies in the Humanities and Arts, including the MQP. Students pursuing a double major, one of which is Humanities and Arts, are not required to complete a Sufficiency Program in Humanities and Arts, nor are they required to complete a second IQP. Students interested in pursuing this option should contact Prof. B. Addison, 39 Dean St., Room 260, for additional information.

The demand for graduates equipped with the background possessed by a WPI student with a double major in the Humanities and Arts is likely to increase. Many fields, including medicine, law, industry, theatre technology, commerce, and public service, will be open to those who have acquired both the skills of humanistic education and technical or managerial knowledge.

OTHER HUMANITIES AND ARTS MINORS

Minors can be arranged in areas other than the above. See Prof. Addison, 39 Dean Street, for further information about minors in other areas and interdisciplinary minors.

MINOR IN FOREIGN LANGUAGE (GERMAN OR SPANISH)

The minor in Foreign Language can be completed in either German or Spanish. It allows students who are well prepared to continue their study of the language and its culture well beyond the advanced level. The minor consists of a total of two units of work, distributed in the following way:

- 1 unit of intermediate and advanced language courses in Spanish or German chosen from the following:
 - SP 2522, SP 3521, SP 3522, or higher or
 - GN 2512, GN 3511, GN 3512, or higher.
 (This unit may be double-counted toward the Sufficiency. No more than one unit may be double-counted in this way.)
- 2/3 unit of advanced literature and culture courses chosen from the following:
 - SP 3523, SP 3524, SP 3525, SP 3526, or Consortium courses approved by a faculty member in Spanish or
 - GN 3513, GN 3514, or Consortium courses approved by a faculty member in German.
 - Any 3000-level experimental course in GN or SP may also be used.
- 1/3 unit capstone experience consisting of an IS/P written in the foreign language.

(If, in the future, there are enough German and Spanish minors combined, the capstone independent study will be a team-taught seminar in comparative civilization/literature.) Interested students should see the following professors in the Humanities and Arts Department: Prof. Dollenmayer (for German) or Prof. Rivera and Prof. Manzari (for Spanish).

MINOR IN MUSIC

The minor in Music is for students who choose to continue their studies in Music beyond the Sufficiency project requirement without majoring in Music. Students who, for personal or career purposes, wish to achieve official recognition of their achievements in Music, yet do not find the time to fulfill the requirements for the major, should consider the Music minor option. Interested students should speak with one of the music faculty in the Department of Humanities and Arts. Because performance is an integral component of music study with proposed minor will contain performance emphasis and consist of two units of work distributed as follows:

- 1/3 unit for participation in MU IS/P Ensembles.
- 1/3 unit Performance IS/P as the capstone experience. Student, with faculty guidance, will present a recital, original composition, or other musical performance that demonstrates the student's skill and knowledge.
- 1 1/3 units of music courses.
- If a student completes his/her Sufficiency project in music, 1 unit of that work may be applied to the minor except for the final IS/P.
- A student who is pursuing a major in Humanities and Arts with music as the major field cannot also receive a minor in music.

MINOR IN WRITING AND RHETORIC

The minor in Writing and Rhetoric offers students the opportunity to extend their study of writing and rhetoric beyond the Sufficiency requirement without majoring in either the Writing and Rhetoric concentration in Humanities and Arts or the Technical, Scientific, and Professional Communication program. The minor consists of two units of work, distributed in the following way:

1. 2/3 unit. Core courses in writing and rhetoric: RH 3111, RH 3112
2. 1 unit. Electives in writing and rhetoric, chosen from the following: EN/WR 2211, EN/WR 3214, EN/WR 3216, EN/WR 3217, EN/WR 3011, and RH 3211. If there is good reason and with the approval of the Program Review Committee, electives may also include courses in art history, literature (in English or other languages), and philosophy and religion.
3. 1/3 unit. Capstone IS/P.

No more than 1 unit of coursework may be double-counted toward the Sufficiency requirement.

INDUSTRIAL ENGINEERING

The Industrial Engineering major is a program of the Management Department. Please refer to page 137 for more information.

INTERACTIVE MEDIA AND GAME DEVELOPMENT

DIRECTOR: M. CLAYPOOL (CS)

CO-DIRECTOR: F. BIANCHI (HUA)

ASSOCIATED FACULTY: E. Agu (CS), F. Bianchi (HUA), M. Ciaraldi (CS), M. Claypool (CS), D. Cyganski (ECE), D. Finkel (CS), J. Forgeng (HUA), M. Gennert (CS), D. O'Donnell (HUA), P. Quinn (HUA), J. Rosenstock (HUA), J. Sanbonmatsu (HUA), M. Ward (CS)

INTRODUCTION

The Interactive Media and Game Development major is designed to provide an outstanding education to its undergraduates in the principles of interactive applications and computer-based game development.

Interactive media applications are characterized by responding to user actions. Examples of interactive media include digital whiteboard presentations, distributed virtual environments, and Shockwave(tm). Broader examples include interactive story-telling and dance. Interactive music applications are especially plentiful, including virtual orchestra applications, digital instruments, music conductor and dancer interfaces, video capture systems and more.

Computer games are a dynamic, rich, and popular type of interactive media. Computer games include the variety of games created for both entertainment and educational purposes, as well as serious games that help make decisions in public policy, education, corporate management, health care, and combat preparedness. Game development refers to all aspects of creating computer based games, including game design, content creation, programming, testing, and project management.

Interactive media and game development majors will receive a base education in both the technical and artistic aspects of game creation. There is particular emphasis on technical programmers and game artists working closely together, thus drawing on their base education skills, and providing invaluable experience for their post-graduate years. IMGD majors are also provided with a base of knowledge in mathematics and science, which serves as a foundation for IMGD professional activities or post-graduate studies.

To be contributors to society, IMGD majors must do more than design and build games or other applications. They must relate to and communicate with people, so they can apply their skills to improve real-life situations. Thus, in addition to the social and societal aspects of WPI's curriculum, IMGD majors receive additional education in social or philosophical issues related to games and related media.

Whether IMGD majors end up with careers in interactive media and game development or in more traditional areas, they will have a solid background that will be a good foundation for their careers.

EDUCATIONAL OUTCOMES

The specific outcomes for the WPI IMGD major are that all graduates will:

1. Understand Artistic and Technical areas related to IMGD.
2. Demonstrate an in-depth understanding of either the Artistic or Technical area related to IMGD.
3. Have a base of technical knowledge in Computer Science, Mathematics and Science.
4. Have a base of artistic knowledge in Art, Music and English.
5. Successfully complete a large-scale software project.
6. Successfully complete a group project with both Technical and Artistic IMGD majors.
7. Be able to creatively express and analyze artistic forms relative to IMGD.
8. Communicate effectively orally, in writing, and in visual media.
9. Be aware of social and philosophical issues pertaining to games and related media.

Distribution Requirements

Degree Requirements for the IMGD major:

IMGD	Minimum Units
Core IMGD (Note 1)	2/3
Math	1/3
Science	1/3
Computer Science	1/3
Social and Philosophical Issues (Note 2)	1/3
Computer Art	1/3
Computer Music	1/3
English (Note 3)	1/3
Advanced IMGD (Note 4)	2/3
Major Qualifying Project (Note 5)	3/3

In addition to the requirements listed above, students must satisfy one of the two area requirements, Technical (Computer Science) or Artistic (Humanities and Arts):

AREA	Minimum
Computer Science (Note 6)	10/3
Humanities and Arts (Notes 7, 8)	10/3

Students have electives that can be tailored to meet specific degree requirements and interests:

ELECTIVES	Minimum
Total Electives (Notes 9, 10)	6/3

NOTES:

1. Choose from: Critical Studies of Interactive Media and Games (IMGD 1000), The Game Development Process (IMGD 1001), Storytelling in Interactive Media and Games (IMGD 1002).
2. Choose from Social Issues in Interactive Media Games (IMGD 2000) or Philosophy and Ethics of Computer Games (IMGD 2001).
3. Courses with the prefix EN or WR.
4. Taken from 2 technical offerings (IMGD 3000 and IMGD 4000) or 2 artistic offerings (IMGD 3500 and IMGD 4500).
5. Students who double-major in IMGD with the Technical area requirement and a second major in Humanities and Arts or International Studies will be deemed to have satisfied the Sufficiency requirement. Students who double major in IMGD with the Artistic area requirement and a second major in a science, engineering, or mathematics discipline will be deemed to have satisfied the Sufficiency requirement. In these cases, the IMGD MQP advisor must certify that the content of the IMGD MQP matches the student's Artistic or Technical IMGD area requirement.
6. At least 4/3 from: Human-Computer Interaction (CS 3041), Software Engineering (CS 3733, CS 4233), Computer Architecture (CS 4732), Computer Networks (CS 4514), Graphics (CS 4731), Animation (CS 4732), or Artificial Intelligence (CS 4341).
7. At least 1/3 from each of the following areas: Art, Music and English.
8. At least 5/3 units at the 2000-level or higher.
9. Electives must be chosen from the following areas: Computer Science, Humanities and Arts, Interactive Media and Game Development, Mathematics, Science, Social Science, Management, or Engineering.
10. At least 3/3 units must be in a single one of the areas listed in Note 9.

Students completing the Technical area requirement must complete a Sufficiency in Humanities and Arts; students completing the Artistic area requirement must complete a Technical Sufficiency.

INTERDISCIPLINARY PROGRAMS

P. DAVIS, DEAN;
R. F. VAZ, ASSOCIATE DEAN;
N. MELLO, DIRECTOR OF GLOBAL OPERATIONS
S. VERNON-GERSTENFELD, DIRECTOR OF
ACADEMIC OPERATIONS
P. O'BRYANT, OPERATIONS AND EXCHANGE
PROGRAM ADMINISTRATOR
 ASSISTANT PROFESSORS: R. Krueger, S. Jiusto
 ADJUNCT ASSISTANT PROFESSORS: F. Carrera,
 C. Peet

The Provost Office, in conjunction with the Interdisciplinary and Global Studies Division (IGSD), operates those academic functions or programs which require an interdisciplinary administrative structure. In addition, the IGSD also provides the support structure for students who construct individually-designed (ID) majors which cannot readily be accommodated in traditional academic departments.

ID majors may be defined in any area of study where WPI's academic strengths can support a program of study, and in which career goals exist. Many combinations of technical and non-technical study are possible. Do not be limited by the example given here; if you have questions about what programs at WPI are possible, please see Prof. R. Vaz in the Project Center to discuss how WPI can assist you in reaching your goals.

Procedure For Establishing an Interdisciplinary (Individually-Designed) Major Program

Students who wish to pursue an individually-designed major program should first discuss their ideas with their academic advisor. The student should then consult with the dean of the IGSD, Prof. Paul Davis, who will determine, with the assistance of other members of the faculty, if the proposed program is feasible, and, if it is, arrange for its evaluation.

The following procedures will be followed for feasible programs:

1. The student must submit to the dean of the IGSD an educational program proposal, including a "definition of scope," and a concise statement of the educational goals of the proposed program. **Goals (such as graduate school or employment) should be specified very clearly.** The proposal must be detailed in terms of anticipated course and project work. The proposal must be submitted no later than one calendar year before the student's expected date of graduation, and normally before the student's third year.
2. The Dean of the Interdisciplinary and Global Studies Division will name a three-member faculty committee, representing those disciplines most involved in the goals of the program, to evaluate the proposal. The committee may request clarification or additional in-

formation for its evaluation. The proposal, as finally accepted by the committee and the student, will serve as an informal contract to enable the student to pursue the stated educational goals most effectively.

3. Upon acceptance of the proposal, the student will notify the Office of Academic Advising and the Projects and Registrar's Office of the choice of ID (individually-designed) as the designation of major. The IGSD then becomes the student's academic department for purposes of record-keeping.
4. The three-person faculty committee will serve as the student's program advisory committee, and will devise and certify the distribution requirements (up to a limit of 10 units including the MQP) appropriate to the student's program.

EXAMPLES OF INTERDISCIPLINARY PROGRAMS

In recent years, students have graduated in interdisciplinary programs in the following areas:

- Environmental (Water Pollution) - Civil Engineering
- Environmental (Air Pollution) - Chemical Engineering
- Urban and Environmental Planning - Civil Engineering

Courses for these programs are located *primarily in the departments listed above*. Students interested in these programs should read the appropriate departmental descriptions before consulting with the chair of the IGSD about developing an ID major.

The programs below are the established majors administered through IGSD.

PROFESSIONAL WRITING

CO-DIRECTORS: J. Trimbur (HUA), C. Demetry (ME)
ASSOCIATED FACULTY: M. Elmes (MG), L. Higgins (HUA), K. Lemone (CS), A. Rivera (HUA), R. Smith (HUA)

The program in Technical, Scientific, and Professional Communication (TC) is concerned with the theory, ethics, research, and practice of representing information in a variety of communication media—computer documentation, instruction manuals, hypertext, multimedia presentations, graphics, video, brochures, newsletters, public relations, scholarly writing, journalism, and literary non-fiction. The goal of the TC program is to prepare communication professionals who can bridge the gap between scientists and engineers and the public by presenting technical information in useful and accessible ways.

The TC program is an interdisciplinary major that combines work in written, oral, and visual communication with a strong concentration in a scientific or technical field. In consultation with a faculty program review committee, majors design a plan of study that fulfills the distribution requirements of the program and best suits their intellectual interests and career aspirations.

The TC major provides excellent preparation for students interested in careers in technical and scientific com-

munication, editing, journalism, public relations, education, and publishing and for students who intend to pursue graduate studies in fields such as communication, education, journalism, and rhetoric and composition.

MQP opportunities are available on campus and with local companies, newspapers, public agencies, and private foundations.

Distribution Requirements

PROFESSIONAL WRITING	Minimum Units
1. Scientific and/or technical concentration (Note 1)	6
2. Writing and Rhetoric concentration (Note 2)	3
3. MQP	1

NOTES:

1. The student's scientific and/or technical concentration must be a plan of study, approved by the student's program review committee, with a clear underlying rationale in mathematics, basic science, computer science, engineering, and/or management.
2. The Writing and Rhetoric concentration consists of 1 unit in each of the 3 following categories of courses. Courses taken to fulfill these distribution requirements will not include courses that fulfill other degree requirements, such as the Humanities and Arts Sufficiency and the Social Sciences requirement. Exceptions to this restriction, not to exceed 1 unit, must be approved by the student's program review committee, and will be granted only under unusual circumstances.

A. Written communication (1 unit)

Recommended courses:

- EN/WR 2211 Elements of Writing
- EN/WR 3011 Peer Tutoring in Writing
- EN/WR 3214 Writing About Disease and Public Health
- EN/WR 3216 Writing in the Professions or equivalent writing courses or ISPs

B. Rhetoric and communication studies (1 unit)

Recommended courses:

- RH 3111 The Study of Writing
 - RH 3112 Rhetorical Theory
 - RH 3211 Rhetoric of Visual Design
- or ISP or any of the courses listed in Category A not used to fulfill that requirement.

C. Electives (1 unit)

The 1 unit of electives must be coherently defined and approved by the student's program review committee. Students may draw on:

Courses in science, technology, and culture studies (such as AR/ID 3150, CS 3041, CS 3043, EN 2252, EN 3235, HI 2331, HI 2332, HI 2333, HI 2334, HI 3331, STS 2208, or GOV 2302);

Philosophy and ethics courses (such as PY 2711, PY 2713, PY 2714, PY 2716, PY 2717, PY/RE 2731, PY/RE 3731);

Foreign language courses;

Management courses.

TEACHER LICENSING

WPI students wishing to receive the Initial License as middle or high school teachers in Massachusetts or states with reciprocating agreements with MA in the areas of Biology, Chemistry, Mathematics or Physics can do so by passing the Massachusetts MTEL test, taking a Teaching Methods course (ID 3100), performing observation and practice teaching and developing an IQP based on this experience, and taking Psychology of Education (PSY 2401) and Cross-Cultural Psychology (PSY 2406). Also required are courses in the appropriate subject matter meeting State guidelines as defined in Massachusetts regulations (603 CMR 7.00). Students wishing to discuss or pursue this should see Professor John Goulet (MA) and/or see <http://users.wpi.edu/~goulet/teacherprep/teacherprep.htm>.

INTERNATIONAL STUDIES

P.H. HANSEN, DIRECTOR

ASSOCIATED FACULTY: W.A.B. Addison (HU), D.B. Dollenmayer (HU), S. Even (HU), L. Fontanella (HU), A. Gerstenfeld (MG), P.H. Hansen (HU), H. J. Manzari (HU), P. Quinn (HU), M.J. Radzicki (SSPS), K.J. Rissmiller (SSPS), A. Rivera (HU), K. Saeed (SSPS)

International Studies prepares men and women for future leadership roles in business and industry, government and public affairs. International Studies integrates WPI's international courses in the humanities and social sciences with its global projects and exchange programs. International Studies courses on-campus prepare students to go abroad. After an experience overseas, students integrate their experiences and explore their career options in a capstone seminar. International Studies at WPI offers a range of options including a minor, major, or double major in International Studies.

MINOR IN INTERNATIONAL STUDIES

The goals of WPI's minor in International Studies are to extend students' global horizons, enhance their disciplinary majors, and expand their career opportunities in the international arena. The program develops a familiarity with global or international issues, an appreciation of cultural differences, and the ability to complete tasks abroad. The minor achieves a basic level of competence in International Studies through a variety of courses, projects, and overseas experiences.

The minor requires a minimum of three units of work related to International Studies as described below. After course work at WPI, students complete their minor through either an international IQP or an international exchange program approved by the Program Review Committee. All students are required to have an international experience off-campus. The program's capstone experience is a Senior Seminar in International Studies. Both options receive the same designation of Minor in International Studies. A student in any major at WPI is eligible to pursue a Minor in International Studies.

Program Requirements for the International Studies Minor

INTERNATIONAL STUDIES IQP OPTION

	Minimum Units
International Core (Note 1)	1
International Electives (Note 2)	1
International IQP (Note 3)	1
International Experience (Note 4)	0
Total	3

INTERNATIONAL STUDIES EXCHANGE PROGRAM OPTION

	Minimum Units
International Core (Note 1)	1
International Electives (Note 2)	2
International Experience (Note 4)	0
Total	3

NOTES:

- International Core. Both options require the same one unit core of international courses. One course must be selected from each of these categories:
 - An introductory course in international history, such as HI 1341, HI 1321, HI 1322, HI 1323, or HI 1313.
 - A course in understanding cross-cultural differences, such as one of the following: HU 3411 Pro-Seminar in Global Perspectives, PSY 2406, Cross-Cultural Psychology; STS 1207 Introduction to Psycho-sociology of Science; PY 2716 Philosophy of Difference.
 - HU 4411 Senior Seminar in International Studies.

Courses in the core may not double-count towards other degree requirements such as the Humanities and Arts Sufficiency requirement or the two course requirement in the Social Sciences. If a student has already counted a course from a) or b) for another requirement, they will be required to take additional courses in International Studies so that at least one unit of their minor does not double-count. The capstone seminar should be the final element of a student's minor.

- International Electives may be selected from among international courses in the Humanities and Social Sciences. They may include any course in European or global history; any course at the intermediate level or above in German or Spanish; any international course in the social sciences; and international courses approved by the Program Review Committee in art history, literature, philosophy and religion. If approved by the Program Review Committee, PQPs for overseas projects may count towards the total. Students may count courses taken to fulfill other degree requirements towards these electives. These electives may not include the MQP or the final 1/3 unit Type 5 IS/P of the Sufficiency Program.
- International IQP: Students who choose the IQP Option must complete an International IQP. All IQPs completed outside of the United States meet this requirement. If approved by the Program Review Committee, IQPs completed on-campus or at Project Centers in the United States may meet this requirement if the IQP is devoted to an international subject and the student also completes a study abroad experience as described in note 4.
- International Experience: All International Studies minors are required to have a study abroad experience. Students who choose the Exchange Option must complete an international project, exchange, or internship approved by the Program Review Committee. The study abroad experience should be educational in nature and equivalent in length to at least one WPI term.

For general policy on the minor, see description on pages 25-26.

MAJOR IN INTERNATIONAL STUDIES

The International Studies Major is an interdisciplinary program that combines rigorous preparation in international studies with competence in an area of science, technology, or management. Under the broad umbrella of the International Studies distribution requirements, students will be able to create their own flexible programs to accommodate their interests and career goals. MQPs may be completed on campus or at one of WPI's global project centers. In consultation with the Program Review Committee, students plan a course of study that may focus on a region of the world, or a thematic issue, or an analytical approach to international studies. International Studies majors are well prepared for careers in business, government, and public affairs.

Distribution Requirements for the International Studies Major

REQUIREMENTS	Minimum Units
International Core (Note 1)	1
International Fields (Note 2)	4
International Experience (Note 3)	0
Electives (Note 4)	4
MQP	1
Total	10

NOTES:

- International Core: One course must be selected from each of these categories:
 - An introductory course in international history, such as HI 1341 or HI 1313, HI 1321, HI 1322, HI 1323.
 - A course in understanding cross-cultural differences, such as one of the following: HU 3411 Pro-Seminar in Global Perspectives, or PSY 2406 Cross-Cultural Psychology; or PY 2716 Philosophy of Difference.
 - HU 4411 Senior Seminar in International Studies.
- International Fields: Majors complete at least one unit of work in each of the following areas. They must also complete at least one additional unit of work in one of these areas, which will be considered their primary field.
 - Historical Analysis. These include any courses in European history, world history, or American foreign policy.
 - Language, Literature, and Culture. These include any course in foreign languages, civilization, and literature offered at WPI or in the Consortium with the prior approval of the Program Review Committee; also courses approved by the Program Review Committee in Art History (e.g. AR 1111, AR 2111), English Literature (e.g. EN 2243, EN 3222), Music History (e.g. MU 2615), or Philosophy and Religion (e.g. RE 2721, RE 2724). Majors who designate Language, Literature, and Culture (LLC) as their primary field may not take courses in a second foreign language unless they have achieved 3000-level proficiency in the first. LLC designees should take most of their courses in a single discipline or in a coherent program approved by the Program Review Committee.
 - Social Sciences. These include international courses in the social sciences (e.g. GOV 1320, ECON 2125, GOV 2312, PSY 2406). Students may count courses taken for the two-course requirement in Social Sciences.
- International Studies majors are required to have a study-abroad experience. (In very unusual cases exceptions may be made to this requirement but only with prior approval of the Director and Program Review Committee). This abroad experience may take the form of a project, exchange, or internship approved by the Program Review Committee. The study-abroad experience should be educational in nature and equivalent in length to at least one WPI term.

- Electives may be from any area except Aerospace Studies, Military Science or Physical Education. Double-majors may count as electives courses taken for their other major. Majors who are not completing a double-major are required to complete a two-unit technical sufficiency in an area of science, engineering, or mathematics apart from these electives.

DOUBLE MAJOR IN INTERNATIONAL STUDIES

Students may pursue a double major in International Studies and any area of study at WPI except a major in Humanities and Arts. To pursue the double major, a student must satisfy all of the degree requirements for both disciplines, including an MQP and Distribution Requirements. In addition, the double major in International Studies requires the same distribution of courses in the International Core and International Fields as the major in International Studies and a second MQP in International Studies. Double majors are also required to have an International Experience. Students pursuing the double major in International Studies are not required, however, to complete a Humanities and Arts Sufficiency program.

RECOMMENDATIONS FOR STUDENTS

Students planning an International Studies minor, major, or double major should take their International Core courses in international history and cross-cultural differences before they go abroad. Since many students go off-campus during their Junior year, students should plan to take these Core courses in their Freshman and Sophomore years. Students are also encouraged to take their International Electives before going abroad and on topics that relate to their international experience. The capstone course, HU 4411, Senior Seminar in International Studies, should be the final element of the minor. Therefore, students may enroll in HU 4411 after they have completed all of the other requirements for the International Studies minor. Students planning an International Studies minor may also wish to consider the possibility of completing a double major in International Studies.

INTERNATIONAL EXPERIENCES

An International Experience may take the form of an international IQP or exchange program. Students often plan their international experience in their Sophomore year. All students are advised to consult the list of projects offered at WPI's Global Project Centers. Each fall, the projects and exchange programs for the following year are widely advertised on campus. For information about student exchange programs, see page 255.

Award-winning projects at WPI are frequently on international topics. Recent examples include studies of a workshop for the blind in London, chemical accidents in Bangkok, the social impact of the building code in New Zealand, and the use of biogas in Botswana. International Studies offers the opportunity not only to complete some of the highest quality projects at WPI, but also to offer solutions to some of the most challenging problems in the world.

Students interested in International Studies may ask any member of the Associated Faculty for more information, or they may consult our page on the World Wide Web: <http://www.wpi.edu/+IN/>.

LAW AND TECHNOLOGY MINOR

As science and technology evolve, there are growing needs for professionals who both understand science and technology and who work within the institutions of the American legal system. At all levels, from federal courts to state regulatory agencies and local planning commissions, policy makers decide issues in an environment of legal rules and principles. Yet to be effective, they must also understand how science and technology can aid their decisions, the methods and conclusions of scientific research, and the social impact of decisions. Without science, environmental regulators cannot decide on measures for hazardous waste disposal, public health officials cannot evaluate new drug therapies, utility regulators cannot authorize new sources of electric power, judges cannot construe the meaning of medical testimony, and attorneys cannot cross examine an expert witness in a product failure case. Decision makers, and those who attempt to influence them, find that they need to understand science and technology.

The Law and Technology Program is an interdisciplinary minor that can be used to supplement a major, introduce students in science and engineering disciplines to legal studies and prepare students to enter law school upon graduation. Students in the program begin their studies with a foundation in legal institutions and analysis and continue with advanced courses that integrate law and technology. A course in professional communication is also required. Students complete their studies with a capstone research activity either in the sixth course or as a separate independent study.

To attain a Minor in Law and Technology, students must complete two units of study (6 courses) as follows:

- Two of the following courses in legal fundamentals:
 - HI 2317 Law and Society in America, 1865-1910
 - GOV 1310 Law, Courts and Politics
 - GOV 2310 Constitutional Law
 - BUS 2950 Business Law and Ethics
- Two of the following courses which integrate law and technology:
 - CE 3022 Legal Aspects in Design and Construction
 - CE 4071 Land Use Development and Controls
 - GOV 2302 Science-Technology Policy
 - GOV 2311 Environmental Policy and Law
 - GOV 2313 Intellectual Property Law
 - GOV/ID 2314 Cyberlaw and Policy
 - Independent study or experimental courses with the approval of the pre-law advisor
- One of the following courses in professional communication:
 - EN/WR 2211 Elements of Writing
 - EN/WR 3214 Writing About Disease and Public Health
 - EN/WR 3216 Writing in the Professions
 - RH 3112 Rhetorical Theory
- One of the following courses undertaken as a capstone experience:
 - GOV 2304 Governmental Decision Making and Administrative Law
 - GOV 2312 International Environmental Policy

If a student takes both GOV 2304 and GOV 2313, the first one taken will count among courses that integrate law and technology, point 2., above. Minors enrolled in either course for their capstone experience will be required to complete the usual

course requirements and an additional research paper. In the paper, the student will summarize existing law in an area of student interest, identify problems with the law, evaluate proposals for change and recommend legislative changes.

As an alternative, students may complete the capstone requirement as an independent study (IS/P) course with the approval and participation of one of the associated faculty.

Students should review their program of study with the associated faculty and/or pre-law advisor. Students are also encouraged to seek IQP opportunities in Division 52, Law and Technology. See page 46. Note: only one of the two units may be counted toward other college requirements.

For general policy on the Minor, see description on pages 25-26.

MANAGEMENT

M. C. BANKS, HEAD

S. A. JOHNSON, DIRECTOR IE PROGRAM

D. M. STRONG, DIRECTOR MIS PROGRAM

PROFESSORS: M. C. Banks, M. B. Elmes, A. Gerstenfeld, J. T. O'Connor, H. G. Vassallo

ASSOCIATE PROFESSORS: H. N. Higgins, S. A. Johnson, C. J. Kasouf, F. Noonan, D. M. Strong, A. Zeng, J. Zhu

ASSISTANT PROFESSORS: E. Danneels, S. Djamasbi, E. Loiacano, J. Mistry, K. Mukherjee, M. Nilsson, S. Taylor

VISITING FACULTY: A. Beerel, M. Chuang, R. DeRamus, J. Monat, J. Schaufeld

INTRODUCTION

The Department of Management provides undergraduate and graduate management education designed to help aspiring managers and executives understand how to use technology to help organizations and individuals succeed in their business endeavors. Our courses combine a practical component, which helps our students apply what they learn, and a theoretical component, which helps them understand why it works and how to use it in other settings. Many courses include a strong global component to help our students understand business beyond the borders of the United States. Additionally, most courses include a discussion of ethics and force students to wrestle with right and wrong. That our approach is successful is demonstrated in our strong placement record, the substantially above (national) average salaries of many of our graduates, and that within five years of graduation they earn, on average, more than any other WPI graduates in the same graduating class.

We provide a number of educational opportunities for our students. We offer undergraduate majors in Industrial Engineering (IE), Management (MG), Management Engineering (MGE), and Management Information Systems (MIS), and minors in Entrepreneurship, Management, Management Information Systems, and Organizational Leadership. At the graduate level we offer the MBA, MS in Operations Design and Leadership, MS in Information Technology, MS in Marketing and Technological Innova-

tion, our combined BS/MBA program, and our graduate certificates in Technology Marketing, Management of Technology, Information Technology, and Electronic Commerce.

ACCREDITATION

Accreditation is important to the Department and the University. Our IE major is accredited by ABET and our undergraduate and graduate business offerings are accredited by AACSB International, the Association to Advance Collegiate Schools of Business. Both ABET and AACSB International are the premier accrediting agencies for their respective disciplines.

OUR STRATEGIC INTENT

To be the premier provider of undergraduate and graduate education focused on the Management of Technology.

OUR MISSION

The Department of Management at WPI is committed to providing education, research, and outreach that focus on:

- leading and managing technology-based organizations;
- integrating technology into the workplace; and
- creating new processes, products, services, and organizations based on technology.

We emphasize:

- innovative and project-based education that integrates the theory and the practice of management, and prepares students to assume positions of leadership in an increasingly global business environment;
- basic scholarship, while also valuing the scholarship of application and the scholarship of instruction; and
- interaction with the business community focused primarily on technological entrepreneurship.

COURSE AREAS

The Department of Management has recently changed its course prefixes from either MG or MG/IE to prefixes that more accurately reflect the course area. They are:

- ACC** Accounting
- BUS** Business
- ETR** Entrepreneurship
- FIN** Finance
- MIS** Management Information Systems
- MKT** Marketing
- OIE** Operations & Industrial Engineering
- OBC** Organizational Behavior and Change

INDUSTRIAL ENGINEERING

Industrial engineers focus on process improvement. The process might be a manufacturing line, where each process step is a physical operation that creates a product, or might involve paper and information, such as the steps required to apply to a particular college for admission. Improvement can mean reducing cost, reducing the time required to complete the process, or reducing the number of errors. To be effective, industrial engineers must combine technical knowledge with concerns about how processes contribute to organizational success and how people fit into the systems they design. These are skills that organizations need a lot right now. Industrial engineers take a systems view, considering all the resources (people, technology, information) that are part of the process. Industrial engi-

neers find jobs in manufacturing firms, hospitals, transportation firms, and government agencies. An industrial engineer might be in charge of quality on a production line, develop computer models to improve service to patients in a hospital clinic, or work to reduce inventory costs. Many industrial engineers move into supervisory or management positions as their career progresses.

At WPI, the IE program is designed to provide students with the tools to spearhead process improvement efforts and the knowledge to implement and employ new technologies. Industrial engineering majors at WPI complete courses in three major categories: (1) the basic mathematics and science courses that are the foundation for all engineering disciplines, (2) core courses that address the tools that industrial engineers use to effect process improvements, such as computer simulation and theories of human behavior, and (3) elective courses that can be tailored to a student's career objectives.

The Major Qualifying Project (MQP) is an integral part of the education of our majors. In addition to satisfying a significant graduation requirement, the MQP must be focused on industrial engineering design. It is typically performed for a business organization. These two elements of our approach to MQPs result in a very valuable learning experience for all of our students. Examples of the MQP for industrial engineering majors include:

- Reducing Costs in Fulfillment Centers and Staples
- Process Improvements at Athena Diagnostics
- 200 E-mails: A Better Way to Staff (sponsored by JP Morgan Securities)
- The Design of Supermarket Inventory Systems for GE Aircraft Engines
- Optimizing Supply Chain Management Utilizing Models (sponsored by Teradyne)
- In-Process Inspection and Quality Control (sponsored by Bunzi Extrusion)

MISSION STATEMENT

The mission of the Industrial Engineering (IE) Program at WPI is to prepare undergraduate students for professional engineering practice, providing the foundation for careers of leadership in challenging global and technological environments. We strive to accomplish this through:

- An innovative, project-based curriculum
- An emphasis on core industrial engineering skills with modern applications
- A flexible curriculum responsive to student interests and changes in the competitive environment
- An environment that encourages faculty/student interaction
- A culture that encourages the active involvement of students in their learning.

EDUCATIONAL OBJECTIVES

Educational objectives describe the expected accomplishments of graduates during the first few years after graduation.

(1) *Industrial Engineering Knowledge and Design Skills.* Graduates should be able to support operational decision making and design solutions to address the complex and changing industrial engineering problems faced by organizations, using modern concepts and technology.

(2) **Communication Skills.** Graduates should be able to communicate effectively, both orally and in writing, using electronic tools and graphical information.

(3) **Teamwork and Leadership Skills.** Graduates should be able to serve as change agents in the organizations that employ them, based on strong interpersonal and teamwork skills, an understanding of professional and ethical responsibility and a willingness to take the initiative.

PROGRAM OUTCOMES

Program outcomes describe what students are expected to know and are able to do by the time of graduation, and are linked to the educational objectives described above.

(1) **Industrial Engineering Knowledge and Design Skills**

- An ability to identify, formulate, and solve industrial engineering problems.
- An ability to design and conduct experiments, as well as to analyze and interpret data.

- An ability to design and improve integrated systems of people, materials, information, facilities and technology.
- An ability to apply core industrial engineering concepts, using the updated techniques, skills and tools necessary for industrial engineering practice.
- The broad education necessary to understand the impact of engineering solutions in a societal context.
- An ability to apply knowledge of mathematics, including statistics as well as integral and differential calculus.
- An understanding of fundamental physical laws.

(2) **Communication Skills**

- An ability to communicate effectively.

INDUSTRIAL ENGINEERING PROGRAM CHART

Note: This chart summarizes recommendations regarding course selection, sequencing, and timing. Students are encouraged to read the Program Distribution Requirements and Curriculum Guidelines for IE for more complete information. Students are also encouraged to arrange their programs to take advantage of global and cooperative education opportunities.

	FRESHMAN/SOPHOMORE	JUNIOR	SENIOR
COURSE RECOMMENDATIONS	Calculus Sequence MA 1021, MA 1022, MA 1023, MA 1024, MA 2051	IQP	MQP
	Statistics Sequence MA 2611; MA 2612 or MA 2621	Complete IE Core: OIE 2850 OBC 2300 OIE 3401 OIE 3420 or OIE 3501 OIE 3460	1 IE Elective 2 Technical Electives At least 3 Free Electives
	H&A Sufficiency	Engineering Basics Outside IE	Complete any remaining degree requirements
	Physics/Chemistry Sequence PH 1110, PH 1120, CH 1010; or PH 1110, CH 1010, CH 1020	2 IE Electives: Choices: OIE 3405, OIE 3420, OIE 3450, OIE 3501, MIS 3720, OIE 4410, OIE 4460, MIS 4720, and OR courses in MA	
	CS 1101 or CS 1102	1 Technical Elective Any engineering/science design course (see page 139 for recommendations)	
	Start IE Core: OIE 2500 OIE 3400 CS 2118		
	Social Science		
	2 Math/Science Electives		
DEGREE REQUIREMENTS	H&A Sufficiency (2 units)		
		IQP (1 unit)	
	Math/Science (4 units)		
		Industrial Engineering Topics (5 units)	
			MQP (1 unit)
	Social Science (2/3 units)		
		Free Electives (1 unit)	
		Physical Education (1/3 unit)	

(3) Teamwork and Leadership Skills

- (i) An ability to work effectively on multi-disciplinary teams.
- (j) An understanding of professional and ethical responsibility.
- (k) A recognition of the need for and an ability to engage in life-long learning.
- (l) A knowledge of contemporary issues.
- (m) An understanding of global issues.
- (n) An understanding of change management in organizational settings.

Program Distribution Requirements for Industrial Engineering Major (IE)

The normal period of residency at WPI is 16 terms. In addition to the WPI requirements applicable to all students (see page 21), students wishing to receive the ABET accredited degree designated "Industrial Engineering" must complete a minimum of 10 units of study in the areas of mathematics, basic science, and engineering topics as follows:

Requirements	Minimum Units
1. Mathematics and Basic Science (Notes 1, 2)	4
2. Industrial Engineering Topics (including the MQP) (Notes 3,4)	6

NOTES:

1. Mathematics must include differential and integral calculus, ordinary differential equations, and 2/3 units in probability and statistics.
2. Basic Science must include both chemistry and physics, with a minimum of two courses in either.
3. Must include 1/3 unit of Capstone Design Experience.
4. Industrial Engineering Topics must include courses in the following three topic areas.
 - a. 3 units of industrial engineering core courses, including 1/3 unit in each of the following 9 areas: engineering basics outside industrial engineering, deterministic operations research methods, process design, production planning and control, simulation, stochastic methods in operations research, information systems design, financial modeling and organizational science.
 - b. 1 unit in Industrial Engineering electives. 3000/4000 level OIE courses, MIS 3720, MIS 4720, and Operations Research courses in Mathematics qualify. Courses in financial modeling and organizational science do not qualify.
 - c. 1 unit in technical electives. Industrial Engineering electives and any other Engineering Science/Design courses qualify.

Curriculum Guidelines for IE

Recommendations for complying with program distribution requirements (10 units) are described below. Students are encouraged to use a Program Tracking Sheet to plan their program and document their progress toward meeting degree requirements. Program tracking sheets are available on the IE web page or in the Management Department Office. To earn a Bachelor of Science (B.S.) degree in Industrial Engineering, students must complete 15 units of coursework. In addition to the requirements below, one must complete the Sufficiency requirement (2 units), the Interactive Qualifying Project (1 unit), free electives (1 unit), social sciences (2/3 unit), and physical education (1/3 unit). Students without prior program-

ming experience are encouraged to take CS 1101 or CS 1102 in their freshman or sophomore year.

(1) Mathematics and Basic Science (4 units)

Mathematics requirements include differential and integral calculus, ordinary differential equations, and 2/3 units probability and statistics. Mathematics requirements can be satisfied by taking MA 1021, MA 1022, MA 1023, MA 1024, MA 2051, MA 2611, and MA 2612. Other recommended courses include: MA 2071, courses in probability and statistics, and courses in numerical analysis.

Basic science courses can be elected in chemistry, physics, biology, or geology. Students must take both chemistry and physics, with a minimum two-course sequence in one of these areas.

(2) Industrial Engineering Topics (5 units)

Students must choose 1 course in each of nine core areas, then choose one unit of industrial engineering and one unit of technical electives. Students who plan to take the Engineering Fundamentals examination in their senior year or to pursue a graduate degree in an engineering field should select their additional unit of work from the engineering science courses suggested under *Technical Electives*.

Industrial Engineering Core (3 units)

Choose one course from each area of the following nine areas:

- *deterministic operations research methods*: OIE 2500 - Management Science I or MA 3231- Linear Programming
- *process design*: OIE 3400 - Production System Design or OIE 3405 - Work Systems and Facilities Planning
- *production planning and control*: OIE 3401 - Production Planning and Control
- *simulation*: OIE 3460 - Simulation Modeling and Analysis
- *stochastic methods*: OIE 3420 - Quality Planning, Design, and Control or OIE 3501 - Management Science II
- *information systems design*: CS 2118 Object-Oriented Design Concepts for Business Applications Application Development Tools
- *financial modeling*: OIE 2850 - Engineering Economics
- *organizational science*: OBC 2300 - Organizational Science Foundation or OBC 3351 - Organizational Science Management of Change
- *engineering basics outside IE*: the engineering basics course is designed to allow students to explore some of the fundamental engineering knowledge associated with either manufacturing or service systems. Depending on the systems that are most interesting to them, it is recommended that students select one course from the following lists:

Manufacturing: ES 1310 - Engineering Design Graphics, ME1800 - Manufacturing Processes, ES 2001 - Introduction to Materials Science, and ME 2820 - Materials Processing

Service systems: ECE 2011 - Introduction to Electrical and Computer Engineering, ECE 3601 - Principles of Electrical Engineering, CS 2011 - Introduction to Machine Organization and Assembly Language, and CS 4032/MA 3257 - Numerical Methods for Linear and Nonlinear Systems.

Industrial Engineering Electives (1 unit)

To achieve depth in their IE program, students are required to take one additional unit of advanced IE courses. Students may choose to focus in operations design and planning, information systems design, or operations research, or to elect a more general program by selecting courses from several areas. A course counted toward the IE core cannot be counted again as an elective. Industrial Engineering courses (listed with an OIE designation), MIS 3720 and MIS 4720, and Operations Research courses in Mathematics at the 3000/4000 level qualify.

Technical Electives (1 unit)

Industrial Engineering electives and other Engineering Science/Design courses qualify. Courses that can be counted as Engineering Science/Design are described on page 35.

For students planning on taking the Fundamentals of Engineering examination, the following courses are recommended:

ECE 3601 - Principles of Electrical Engineering
 ES 2001 - Introduction to Materials Science
 ES 2501 - Introduction to Static Systems

ES 2503 - Introduction to Dynamic Systems

ES 3004 - Fluid Mechanics

(3) Major Qualifying Project (1 unit)

The MQP is expected to provide a capstone design experience for industrial engineering majors. If the MQP does not fulfill this 1/3 unit requirement, the student should speak with the Industrial Engineering Program Director to determine an appropriate method for fulfilling this requirement.

MANAGEMENT (MG)

The Management major at WPI is what many colleges and universities would call "General Business." Our approach is to provide a broad understanding of business through what we refer to as Foundation Courses. These include such courses as Financial and Managerial Accounting, Marketing Management, and Operations Management. On top of the Foundation Courses, each student selects six related courses as the focus of their advanced work. These courses should be selected from the MG list found in the section, Curriculum Guidelines for MG,

DEPARTMENT OF MANAGEMENT**SAMPLE PROGRAM FOR MANAGEMENT, MANAGEMENT ENGINEERING, AND MIS****FIRST YEAR**

A TERM
 Science I
 MA 1021
 Sufficiency-1

B TERM
 Science II
 MA 1022
 Sufficiency-2

C TERM
 ACC 1100
 MA 2611
 Sufficiency-3

D TERM
 ACC 2101
 MA 2612
 Sufficiency-4

SECOND YEAR

A TERM
 ECON 1110
 OBC 2300
 Sufficiency-5

B TERM
 ECON 1120
 Elective
 Sufficiency-6

C TERM
 BUS 2950
 OIE 2500
 CS 1101

D TERM
 FIN 2200
 MIS 3700
 Elective or Major Course

THIRD YEAR

A TERM
 OIE 3400
 Major Course
 IQP-1

B TERM
 Elective
 Major Course
 IQP-2

C TERM
 MKT 3600
 Major Course
 IQP-3

D TERM
 Major Course
 Major Course
 Elective

FOURTH YEAR

A TERM
 Breadth Elective
 MQP-1
 Elective or Major Course

B TERM
 Breadth Elective
 MQP-2
 Elective

C TERM
 3000-4000 Elective
 MQP-3
 Elective

D TERM
 Electives or
 Make Up Work

MGE, MIS. Courses not on this list must be approved by your academic advisor and the Department's Undergraduate Policy & Curriculum Committee (UPCC). This latter option permits you to develop a plan of study that is tailored to your career objectives. Career opportunities for management students can be found in banking and finance, manufacturing management, marketing and sales, research and development, human resources, public or not-for-profit sector management, and many other occupations.

The Major Qualifying Project (MQP) is an integral part of the education of our MG majors. In addition to satisfying a significant graduation requirement, the MQP must be focused in the student's specific focus area. It is typically performed for a business organization. These two elements of our approach to MQPs result in a very valuable learning experience for all of our students. Examples of the MQP for Management majors include:

- Improving a city's permitting process,
- Developing an inventory control system for a university athletics department,
- Evaluating risk in mergers, and
- Reengineering human resources at a hospital.

PROGRAM OBJECTIVES

Objectives of the Management Major are:

To prepare students for management roles in technology based organizations.

Through a flexible curriculum, to provide a solid, broad base of business knowledge and the written communication, oral presentation, decision-making, and leadership skills necessary to succeed in a technology based environment.

To develop student abilities necessary for continued career growth including:

- the ability to integrate theory and practice;
- the ability to integrate technology and change into existing organizations;
- the ability to think critically and analytically, to define and solve business problems, work in teams, and think globally; and
- the ability to learn new skills in response to changing professional requirements.

MANAGEMENT ENGINEERING (MGE)

Management Engineering at WPI combines the best of a business degree with a technical focus. MGE majors develop a broad understanding of business through what we refer to as Foundation Courses. These include such courses as Financial and Managerial Accounting, Marketing Management, and Operations Management. On top of the Foundation Courses, each student selects six related courses as the focus of their advanced work. These courses should be selected from the MGE list found in the section, Curriculum Guidelines for MG, MGE, MIS. Courses not on this list must be approved by your academic advisor and the Department's Undergraduate Policy & Curriculum Committee (UPCC) and usually come from electives in the Department or from areas such as Engineering, Mathematics, or Science. Career opportunities for Management Engineering majors are quite varied. Some pur-

sue engineering opportunities in the focus area (Industrial Engineering, for example), while others join management training programs or accept sales positions with technological firms.

The Major Qualifying Project (MQP) is an integral part of the education of our MGE majors. In addition to satisfying a significant graduation requirement, the MQP must be focused in the student's specific focus area. It is typically performed for a business organization. These two elements of our approach to MQPs result in a very valuable learning experience for all of our students. Examples of the MQP for Management Engineering majors include:

- Evaluating Six Sigma,
- Quality function deployment in a healthcare setting,
- Ergonomic evaluation of a manufacturing work center, and
- Evaluation of leased lines and alternative solutions.

PROGRAM OBJECTIVES

Objectives of the Management Engineering Major are:

To prepare students for management challenges in key areas that increasingly require proficiency in the technical aspects of business such as production and service operations.

To provide the knowledge and skills necessary to succeed professionally, including literacy in a technical field, a broad understanding of management issues, written communication, oral presentation, decision-making, and leadership skills required to create new and improved products, processes and control systems.

To develop student abilities necessary for continued career growth including:

- the ability to integrate theory and practice and to apply knowledge of technical issues with the foundations of management;
- the ability to integrate technology and change into existing organizations;
- the ability to think critically and analytically, to define and solve business problems, work in teams, and think globally; and
- the ability to learn new skills in response to changing professional requirements.

MANAGEMENT INFORMATION SYSTEMS (MIS)

Like our other major programs in the Department of Management, the Management Information Systems program combines a broad understanding of business, through what we refer to as Foundation Courses, with specialized education in Information Systems. Foundation Courses include such areas as Financial and Managerial Accounting, Marketing Management, and Operations Management. On top of the Foundation Courses, each student selects six MIS courses as the focus of their advanced work. These courses should be selected from the MIS list found in the section, Curriculum Guidelines for MG, MGE, MIS. Courses not on this list must be approved by your academic advisor and the Department's Undergraduate Policy & Curriculum Committee (UPCC) and usually come from electives in the Department or from areas such as Computer Science or Electrical and Computer Engineering.

Based on the rigorous IS '02 Guidelines for MIS programs, our MIS courses cover such areas as business application development tools, data management, and telecommunications, among others. This program helps students develop strong analytical, problem solving, and communication skills, and a solid understanding of business and computing. Many of our MIS majors join international consulting firms upon graduation, while others take entry-level positions as programmer-analysts, business analysts, end-user support staff, and eventual management training positions in high-technology businesses.

The Major Qualifying Project (MQP) is an integral part of the education of our MIS majors. In addition to satisfying a significant graduation requirement, the MQP must be focused in the student's specific focus area. It is typically performed for a business organization. These two elements of our approach to MQPs result in a very valuable learning experience for all of our students. Typical MQPs for MIS majors include:

- Developing a kiosk system,
- A web-based archeological stratification tool,
- Creating a help desk system, and
- Measuring data quality.

Clients have included both small and large companies as well as manufacturing businesses, financial firms, consulting firms, public sector organizations, and university departments.

PROGRAM OBJECTIVES

The objectives of the Management Information Systems Major are:

To prepare students for positions involving the design and deployment of business applications using a wide variety of advanced information technologies, especially in high technology business, consulting, and service firms, in either start-up or established environments, and to prepare students for rapid advancement to project management and other management positions.

To provide the knowledge and skills consistent with the professionally accepted IS curriculum guidelines. Specifically, this includes providing knowledge and skills related to:

- business application development tools;
- database, web-based and networked applications;
- integrating IT into existing organizations through managing and leading systems analysis and design projects;
- communicating effectively via written and oral presentations.

To develop student abilities necessary for continued career growth including:

- the ability to integrate theory and practice and to apply knowledge of information technology issues with the foundations of management;
- the ability to integrate technology and change into existing organizations;
- the ability to think critically and analytically, to define and solve business problems, work in teams, and think globally; and
- the ability to learn new skills in response to changing professional requirements.

Program Distribution Requirements for the Management Major

Requirements (Note 1)	Minimum Units
1. Management Foundation (Note 2)	11/3
2. Mathematics (Note 3)	4/3
3. Basic Science	2/3
4. Management Major (Note 4)	6/3
5. Breadth Electives (Note 5)	3/3
6. Computer Science (Note 6)	1/3
7. MQP	3/3

NOTES:

1. Courses may not be counted more than once in meeting these distribution requirements. The total number of units taken in the Department of Management may not exceed 50% of the total number of units earned for the degree.
2. The Management Foundation must cover the foundation knowledge in the management functional areas, including at least 1/3 unit of financial accounting, managerial accounting, financial management, organizational science, deterministic management science, operations management, marketing management, information systems management, and business law and ethics. Microeconomics and Macroeconomics are required and also fulfill the WPI Social Science requirement.
3. Mathematics must include 2/3 units of calculus and 2/3 units of statistics.
4. Students selecting the Management Major must complete six courses from at most three (3) course clusters as specified in the WPI Undergraduate Catalog "For the MG Major" or work with their academic advisor to create a custom MG Program that includes courses in the specified clusters and/or other areas of Humanities & Arts and Social Sciences & Policy Studies. Such custom programs must be approved by the advisor and the Department of Management's Undergraduate Policy & Curriculum Committee.
5. Breadth Electives must include at least 1/3 unit from among the 3000- and 4000-level courses in the Department. The remaining 2/3 units specified in the requirement may be satisfied with courses from Mathematics, Basic Science, Computer Science, Social Science, or courses with any of the following prefixes: ACC, BUS, ETR, FIN, MIS, MKT, OBC, or OIE, but excluding courses FIN 1250 and OIE 2850.
6. A minimum of 1/3 unit of Computer Science (except CS 2022 and CS 3043). Either CS 1101 or CS 1102 is recommended.

Program Distribution Requirements for the Management Engineering Major

Requirements (Note 1)	Minimum Units
1. Management Foundation (Note 2)	11/3
2. Mathematics (Note 3)	4/3
3. Basic Science	2/3
4. Management Engineering Major (Note 4)	6/3
5. Breadth Electives (Note 5)	3/3
6. Computer Science (Note 6)	1/3
7. MIS MQP	3/3

NOTES:

1. Courses may not be counted more than once in meeting these distribution requirements. The total number of units taken in the Department of Management may not exceed 50% of the total number of units earned for the degree.
2. The Management Foundation must cover the foundation knowledge in the management functional areas, including at least 1/3 unit of financial accounting, managerial accounting, financial management, organizational science, deterministic management

science, operations management, marketing management, information systems management, and business law and ethics. Microeconomics and Macroeconomics are required and also fulfill the WPI Social Science requirement.

3. Mathematics must include 2/3 units of calculus and 2/3 units of statistics.
4. The Management Engineering Major must complete six courses from one of the concentrations as specified in the WPI Undergraduate Catalog "For the MGE Major" or work with their academic advisor to create a custom MGE Program. Such custom programs must be approved by the advisor and the Department of Management's Undergraduate Policy & Curriculum Committee.
5. Breadth Electives must include at least 1/3 unit from among the 3000- and 4000-level courses in the Department. The remaining 2/3 units specified in the requirement may be satisfied with courses from Mathematics, Basic Science, Computer Science, Social Science, or courses with any of the following prefixes: ACC, BUS, ETR, FIN, MIS, MKT, OBC, or OIE, but excluding courses FIN 1250 and OIE 2850.
6. A minimum of 1/3 unit of Computer Science (except CS 2022 and CS 3043). Either CS 1101 or CS 1102 is recommended.

Program Distribution Requirements for the Management Information Systems Major

Requirements (Note 1)	Minimum Units
1. Management Foundation (Note 2)	11/3
2. Mathematics (Note 3)	4/3
3. Basic Science	2/3
4. Management Information Systems Major (Note 4)	6/3
5. Breadth Electives (Note 5)	3/3
6. Computer Science (Note 6)	1/3
7. MIS MQP	3/3

NOTES:

1. Courses may not be counted more than once in meeting these distribution requirements. The total number of units taken in the Department of Management may not exceed 50% of the total number of units earned for the degree.
2. The Management Foundation must cover the foundation knowledge in the management functional areas, including at least 1/3 unit of financial accounting, managerial accounting, financial management, organizational science, deterministic management science, operations management, marketing management, information systems management, and business law and ethics. Microeconomics and Macroeconomics are required and also fulfill the WPI Social Science requirement.
3. Mathematics must include 2/3 units of calculus and 2/3 units of statistics.
4. The Management Information Systems Major must complete six courses from those specified in the WPI Undergraduate Catalog "For the MIS Major" or work with their academic advisor to create a custom MIS Program. Such custom programs must be approved by the advisor and the Department of Management's Undergraduate Policy & Curriculum Committee.
5. Breadth Electives must include at least 1/3 unit from among the 3000- and 4000-level courses in the Department. The remaining 2/3 units specified in the requirement may be satisfied with courses from Mathematics, Basic Science, Computer Science, Social Science, or courses with any of the following prefixes: ACC, BUS, ETR, FIN, MIS, MKT, OBC, or OIE, but excluding courses FIN 1250 and OIE 2850.
6. A minimum of 1/3 unit of Computer Science (except CS 2022 and CS 3043). Either CS 1101 or CS 1102 is recommended.

Curriculum Guidelines for MG, MGE, MIS

Specific course recommendations for complying with the distribution requirements are given below. These guidelines are intended to offer flexibility while meeting minimal standards in preparing for careers in MG, MGE, or MIS.

MATHEMATICS-minimum of 4/3 units is required, with 2/3 units in calculus and 2/3 units in statistics. For most students, MA 1021, MA 1022, MA 2611, and MA 2612 will be appropriate.

BASIC SCIENCE-minimum of 2/3 unit is required, where all courses with the prefix PH, CH, and BB, as well as GE 2341 qualify.

COMPUTER SCIENCE-minimum of 1/3 unit is required where all courses with the prefix CS qualify (except CS 3043). Either CS 1101 or CS 1102 is recommended.

MANAGEMENT-minimum of 4 units is required with 2/3 units in accounting and 2/3 units in economics, and 1/3 unit from each of the 8 remaining management categories designated below. Recommended courses are listed. These courses represent the basic courses in each functional area of Management. It is recommended that courses ECON 1100 and ECON 1120 be taken during the First Year.

Management Foundation Coursework

Accounting	ACC 1100 and ACC 2101
Economics	ECON 1110 and ECON 1120
Finance	FIN 2200
Organizational Science	OBC 2300
Quantitative Methods	OIE 2500
Business Law & Ethics	BUS 2950
Production	OIE 3400
Marketing	MKT 3600
Information Systems	MIS 3700

3000- or 4000-level MG elective from the department.

MAJOR-minimum of 2 units of integrated course work is required for students majoring in Management, MIS, or Management Engineering. Other courses may be used but must be approved by the student's academic advisor and the Department's Undergraduate Policy & Curriculum Committee early in the student's program.

For the MG Major

Complete six (6) courses from those listed below. The six courses may come from at most three (3) of the listed course clusters (e.g., Entrepreneurship with Accounting & Finance; Marketing with Organizational Behavior and Psychology; etc.) Students are urged to consult with their academic advisor about the specific portfolio of courses no later than the beginning of their third course. Custom MG majors are allowed but the students must first work with their academic advisor to create a custom MG Program that is approved by the advisor and the Department of Management's Undergraduate Policy & Curriculum Committee.

Accounting & Finance: ACC 4151, FIN 2250, FIN 2260
 Entrepreneurship: ETR 3910, ETR 3920, ETR 4930
 Marketing: MKT 3640, MKT 3651
 Organizational Behavior: OBC 3351, OBC 4364, OBC 4365
 Economics: ECON 1130, ECON 2110, ECON 2117,
 ECON 2120, ECON 2125
 Law: GOV 1310, GOV 2304, GOV 2310, GOV 2313,
 GOV 2314
 Psychology: PSY 1401, PSY 1402, SD 1504, PSY 2406

For the MGE Major

MGE majors must choose from one of the approved concentrations listed below or work with their academic advisor to create a Custom MGE Program that is approved by the advisor and the Department of Management's Undergraduate Policy & Curriculum Committee. Students are strongly encouraged to seek approval for a Custom MGE Program before B-term of their junior year.

Operations Management Concentration – 2 units

Complete the following four courses	OBC 3351 OIE 3401 OIE 3420 OIE 4460	and	Select two courses from among:	ACC 4151 CS 2118 MIS 3720 MKT 3640 OBC 4365 OIE 3501	and	The MQP must have a business focus related to Operations Management.
-------------------------------------	--	-----	--------------------------------	---	-----	--

Biomedical Engineering Concentration – 2 units

Complete at least one course from	BUS 1900 ETR 3910 ETR 3920 ETR 4930 MKT 3640 MKT 3651 OIE 3401 OIE 3420 OIE 3501 OBC 3351 OBC 4365	and	Select at least four courses from among:	BME 1001 BME 2204 BME 2504 BME 2604 BME 3101 BME 3102 BME 3300	and	The MQP must have a business focus related to Biomedical Engineering.
-----------------------------------	--	-----	--	--	-----	---

Civil Engineering Concentration – 2 units

Complete at least one course from	BUS 1900 ETR 3910 ETR 3920 ETR 4930 MKT 3640 MKT 3651 OIE 3401 OIE 3420 OIE 3501 OBC 3351 OBC 4365	and	Select at least four courses from among:	CE 1030 CE 2000 CE 2001 CE 2020 CE 3030 CE 3041 ES 3004	and	The MQP must have a business focus related to Civil Engineering.
-----------------------------------	--	-----	--	---	-----	--

Electrical and Computer Engineering Concentration – 2 units

Complete at least one course from	BUS 1900 ETR 3910 ETR 3920 ETR 4930 MKT 3640 MKT 3651 OIE 3401 OIE 3420 OIE 3501 OBC 3351 OBC 4365	and	Select at least four courses from among:	ECE 2011 ECE 2022 ECE 2111 ECE 2112 ECE 2311 ECE 2312 ECE 2799 ECE 2801	and	The MQP must have a business focus related to Electrical and Computer Engineering.
-----------------------------------	--	-----	--	--	-----	--

Mechanical Engineering Concentration – 2 units

Complete at least one course from	BUS 1900 ETR 3910 ETR 3920 ETR 4930 MKT 3640 MKT 3651 OIE 3401 OIE 3420 OIE 3501 OBC 3351 OBC 4365	and	Select at least four courses from among:	ES 2001 ES 2501 ES 2502 ES 2503 ES 3001 ES 3003 ES 3004 ME 1800 ME 2300 ME 2820 ME 3820 ME 3901 ME 4320 ME 4429 ME 4430	and	The MQP must have a business focus related to Mechanical Engineering.
-----------------------------------	--	-----	--	---	-----	---

Manufacturing Engineering Concentration – 2 units

Complete at least one course from	BUS 1900 ETR 3910 ETR 3920 ETR 4930 MKT 3640 MKT 3651 OIE 3401 OIE 3420 OIE 3501 OBC 3351 OBC 4365	and	Select at least four courses from among:	ES 2001 ME 1800 ME 2820 ME 3820 ME 3320 ME 4815 ME 487x ME 489x	and	The MQP must have a business focus related to Manufacturing Engineering.
-----------------------------------	--	-----	--	--	-----	--

For the MIS Major

Management Information Systems

CS 2118, MIS 3720, MIS 3740, MIS 4720, and two of the following: MIS 4740, MIS 4750, CS 2102, CS 2301 or CS 2303, CS 3041. Students wishing to use other courses as part of the MIS major should secure the approval of their MIS academic advisor and the Department of Management's Undergraduate Policy & Curriculum Committee (UPCC).

BREADTH-In addition to the guidelines listed above for Mathematics, Basic Science, Computer Science, and Management, the departmental distribution requirements call for an additional 2/3 units, which may be distributed across these categories as well as social science.

MANAGEMENT NONMAJOR INFORMATION

Often the courses of the Department will be used as a small portion of other degree programs. Since management knowledge is increasingly important regardless of one's major or career, many nonmajor students choose to take one or more courses in the Department. Areas for either exposure or focus for the non-management major include marketing, accounting, finance, entrepreneurship, operations, and organization science. Special topics or projects can be arranged on a limited basis. Care should be taken that courses from the Department of Management do not exceed 25 percent of the total units taken for a degree.

FIVE-YEAR DUAL DEGREE BS/MBA PROGRAM

The combination of a technical undergraduate degree and a graduate degree in business has been cited by many experts as the ideal educational preparation for a career in private industry. For that reason, the Department of Management offers the opportunity for obtaining dual de-

degrees (i.e., the B.S. degree in engineering or science and the Master of Business Administration, MBA). The dual-degree program can be completed within five years, however, the program is demanding, and curriculum planning with the student's advisor and the Department of Management should start by the beginning of the student's third year at WPI at the very latest.

Only registered WPI undergraduates majoring in an engineering (excluding Management Engineering) or science area may enter the Dual-Degree B.S./MBA Program. A separate and complete application to the MBA program must be submitted. Admission to the Dual-Degree B.S./MBA Program is determined by the faculty of the Department of Management. The student should begin the curriculum planning process as early as possible in his/her undergraduate program, but no later than the beginning of the third year, to ensure that all of the required undergraduate courses are completed within the student's four years of undergraduate study. It is recommended that the MBA application be submitted no later than the beginning of the student's Third Year of undergraduate study. A student in the Dual-Degree B.S./MBA Program continues to be registered as an undergraduate until the bachelor's degree is awarded.

Students wishing to do a combined B.S./MBA must complete the following courses while an undergraduate:

ACC 1100	<i>Financial Accounting</i>
FIN 2200	<i>Financial Management</i>
OBC 2300	<i>Organizational Science</i>
MA 2611	<i>Applied Statistics I</i>
MA 2612	<i>Applied Statistics II</i>
OIE 3400	<i>Production System Design</i>
MKT 3600	<i>Marketing Management</i>
MIS 3700	<i>Information Systems Management</i>
ECON 1110	<i>Introductory Microeconomics</i>
ECON 1120	<i>Introductory Macroeconomics</i>

To obtain a bachelor's degree via the Dual-Degree B.S./MBA Program, the student must satisfy all requirements for the bachelor's degree, including distribution and project requirements.

To obtain an MBA via the Dual-Degree B.S./MBA Program, the student must satisfy all MBA degree requirements. In addition to the prerequisite undergraduate courses listed above, the student must complete the following graduate courses:

OBC 511	<i>Interpersonal and Leadership Skills for Technological Managers</i>
MKT 512	<i>Creating and Implementing Strategy for Technological Organizations</i>
OIE 513	<i>Creating Processes in Technological Organizations</i>
ACC 514	<i>Business Analysis for Technological Managers</i>
BUS 515	<i>Legal and Ethical Context of Technological Organizations</i>
BUS 516	<i>Graduate Qualifying Project (GQP)</i>
12 Elective Credits	

A student in the Dual-Degree B.S./MBA Program may, with prior approval, apply the equivalent of a maximum of 12 graduate credits from the same courses toward both the bachelor's and MBA degrees. Students in the Dual-Degree B.S./MBA Program may not take graduate-level

management courses prior to their Fourth Year of undergraduate study, and then only provided the corresponding prerequisites have been satisfied. Students in the Dual-Degree B.S./MBA Program may use advanced undergraduate major or elective courses (generally classified as 4000-level courses) to satisfy graduate degree elective requirements. The Department of Management decides which courses may be used in this way. Faculty members teaching these advanced undergraduate courses may impose special requirements, appropriate to an undergraduate course being used for graduate credit, on Dual-Degree B.S./MBA Program students.

The Department of Management may make other requirements as it deems appropriate in any individual case. These requirements take the form of a written agreement between the student and the Department of Management, and must be filed with the registrar before the student may be matriculated in the Dual-Degree B.S./MBA Program.

The Dual-Degree B.S./MBA Program is a full-time program of study. Once admitted to the Dual-Degree B.S./MBA Program, a student must register every fall and spring semester until the MBA is completed. A student in the Dual-Degree B.S./MBA Program who has no registered activities during a given fall or spring semester is automatically terminated from the Dual-Degree B.S./MBA Program, and may only be readmitted to the Dual-Degree B.S./MBA Program by the Department of Management's Graduate Policy and Curriculum Committee and the Committee for Graduate Studies and Research via petition showing extenuating circumstances. Termination from the Dual-Degree B.S./MBA Program does not affect a student's ability to continue toward the bachelor's degree.

ENTREPRENEURSHIP MINOR

All around the world people are starting their own new business ventures. With its strong heritage of invention and entrepreneurship among students and faculty members, WPI is committed to encouraging its students to consider that career path. Our dream is that our students will earn a minor in Entrepreneurship, which will provide them with some basic business skills and an understanding of what it takes to start a business, then they will create a new and exciting technology as their MQP that they will then turn into a business upon graduation. Related opportunities include the Robert H. Grant Invention Awards, the Henry Strage Innovation Awards, the CEI @ WPI ALL-OUT Business Plan Competition, the WPI Dinner with Entrepreneurs Series, the WPI chapter of CEO (Collegiate Entrepreneurs Organization), several conferences, many workshops, the monthly WPI Venture Forum meetings, a variety of speakers and other events related to entrepreneurship, and access to a wide network of entrepreneurs from around the U.S. and abroad.

The Minor in Entrepreneurship is available to all students except those majoring in MG, MGE, or MIS, who may take the courses as part of their major or as Breadth or Free Electives.

The minor requires the completion of two units of coursework as noted below.

1. Complete the following course:
OIE 2850 Engineering Economics
2. Complete two (2) from the following list:
ACC 1100 Financial Accounting **OR**
ACC 2101 Management Accounting
BUS 2950 Business Law & Ethics
OIE 3400 Production System Design
MKT 3600 Marketing Management
MIS 3700 Information Systems Management
3. Complete the following three courses, preferably in order:
ETR 3910 Identifying & Evaluating New Venture Opportunities
ETR 3920 Planning & Launching New Ventures
ETR 4930 Growing and Managing New Ventures
As noted above, students majoring in MG, MGE, or MIS may not minor in Entrepreneurship.
For general policy on the Minor, see the description on pages 25-26.

MANAGEMENT MINOR

Everyone needs management skills. If engineers, scientists, and others hope to advance in their careers, they must learn how to lead projects and manage groups. The Management Minor offers students (other than MG, MGE, or MIS majors, who may take the courses as part of their major or as Breadth or Free Electives, as appropriate) the opportunity to learn some of the theory and practice of managing in organizations with material on management concepts and practices commonly encountered in the business world. This program will help students make a transition to the business world and will provide basic skills for operating effectively in business organizations.

To complete the Management Minor, a student must complete two units of work in the Management Area, typically through course work with the following distribution:

1. One course from the Social Science Economics area.
Any course with course designation SS#1## will qualify.
2. Three courses from the group of courses:
 - a. BUS 1900 Introduction to Business in an International Environment **OR** OBC 2300 Organizational Science
AND
 - b. ACC 1100 Financial Accounting **OR** ACC 2101 Management Accounting
AND
 - c. One 2000-level course from the Department of Management
3. One 3000 or 4000-level course from the Department of Management
4. Capstone Experience ETR 4930:
As noted above, students majoring in MG, MGE, or MIS may not minor in Management.
For general policy on the Minor, see the description on pages 25-26.

MIS MINOR

Information technology has been the driving force behind the new way of doing business. It has enabled companies to make tremendous strides in productivity, it has opened new markets and new channels, and it has created new product and service opportunities. While one part of the information revolution has been advances in hardware, and another has been advances in software, a third major advance has been in the systems-side of information, or how information is organized and used to make effective decisions. That is Management Information Systems (MIS). The Minor in MIS offers students (other than MG, MGE, or MIS majors, who may take the courses as part of their major or as Breadth or Free Electives, as appropriate) the opportunity to broaden their disciplinary program with material and skills widely useful in the business world. This program will help students to broaden their exposure to information technology and its use in business and industry.

To complete the Management Information Systems Minor, a student must complete two units of work with the following distribution:

1. One course from the group of courses:
BUS 1900 Introduction to Business in an International Environment **OR**
ACC 1100 Financial Accounting **OR**
ACC 2101 Management Accounting **OR**
OBC 2300 Organizational Science
2. Two courses, or their equivalents, from the following list:
CS 1101 Introduction to Program Design **OR**
CS 1102 Accelerated Introduction to Program Design
CS 2118 Object-Oriented Design Concepts for Business Applications
CS 2301 Systems Programming for Non-Majors **OR**
CS 2303 Systems Programming Concepts
3. Two courses from the group of courses:
MIS 3700 Information Systems Management
MIS 3720 Management of Data
MIS 3740 Organizational Application of Telecommunications
4. Capstone Experience
MIS 4720: Systems Analysis and Design
Course MIS 4720 is a project-oriented course designed to prepare MIS students and minors for actual information systems design work in business and industry. The course builds and uses MIS concepts for the sound and efficient design of information systems.
Students majoring in MG, MGE, or MIS may not take the MIS Minor.
For general policy of the Minor, see the description on pages 25-26.

ORGANIZATIONAL LEADERSHIP MINOR

One of the critical elements for any person who hopes to succeed in a formal organization is leadership. While some people come by their organizational leadership abilities instinctively or by learning from others at an early age, many others come late to their leadership talents and still others never realize their leadership abilities. It is the purpose of the Department of Management's Organizational Leadership minor to provide students with the theoretical underpinnings of leadership and, in keeping with a WPI education, the knowledge of how that theory applies to practice. Thus, through this minor students will be able to understand and apply leadership theories to their lives and, in the process, make themselves more marketable upon graduation.

The minor in Organizational Leadership consists of three primary components. These components are a choice of Management courses, a choice among three Social Science & Policy Studies courses, and a capstone course in Leadership.

1. Select four of the following:

- BUS 1900 Introduction to Business in an International Environment
- OBC 2300 Organizational Science - Foundation
- BUS 2950 Business Law & Ethics
- OBC 3351 Organizational Science - Management of Change
- OBC 4364 Human Resource Management

2. Select one of the following:

- PSY 1401 Introduction to Cognitive Psychology
- PSY 1402 Introduction to Social Psychology
- PSY 2406 Cross-Cultural Psychology: Human Behavior in Global Perspective

3. Required Capstone Experience

- OBC 4365 Leadership in Groups and Organizations

Note: The minor in Organizational Leadership may not be taken by students majoring in MG, MGE, or MIS.

These students may take the courses as part of their major or as Breadth or Free Electives, as appropriate.

For general policy on the Minor, see the description on pages 25-26.

MANUFACTURING ENGINEERING

DIRECTOR: R. D. SISSON

ASSOCIATE DIRECTOR: Y. RONG

PROFESSORS: D. Apelian, I. Bar-On, C. A. Brown, Y. Rong, R. D. Sisson, J. M. Sullivan, Jr.

ASSOCIATE PROFESSORS: M. Fofana, S. Johnson, M. M. Makhlof, F. Noonan

ASSISTANT PROFESSOR: Y-M. Moon

RESEARCH PROFESSOR: R. Katz

LECTURERS: P. D. Cotnoir, K. Stafford

INTRODUCTION

The Manufacturing Engineering Program is a multidisciplinary program, relying on faculty and equipment of the departments of Computer Science, Electrical and Computer Engineering, Management, and Mechanical Engineering. Manufacturing Engineering is home to the Robotics Lab, Computer-aided Manufacturing Lab, Machine Dynamics Lab, Surface Metrology Lab, and Haas Technical Center for Computer-controlled Machining.

Manufacturing Engineering integrates basic knowledge of materials, design, processes, computers, engineering analysis, and systems design. This knowledge is used to design, build, operate, and manage production systems. Manufacturing Engineering encompasses a wide range of areas from basic research to technical management. At WPI, Manufacturing Engineers may be involved through courses and MQPs in a wide range of topics including:

- Computer-aided Design (CAD)
- Computer-aided Manufacturing (CAM)
- Surface Metrology
- Manufacturing Processes (Casting, Welding, Machining, Grinding)
- Industrial Robotics
- Simultaneous/Concurrent Engineering
- Lean Manufacturing
- CNC Machining
- Fixturing
- Machine Dynamics
- Value Engineering
- Axiomatic Design
- Materials Programming
- Heat Treatment

A scientific "high technology" basis for Manufacturing Engineering is evolving. The MFE program is designed to lace WPI students at the leading edge of this evolution.

MISSION STATEMENT

The mission of WPI's Manufacturing Engineering Program:

Provide an outstanding Manufacturing Engineering education that realizes students' visions, fulfills industry needs, and produces future leaders.

MANUFACTURING ENGINEERING PROGRAM CHART

BACKGROUND

4 Units	
MATHEMATICS	**SCIENCE
*MA 1021	CH 1010
*MA 1022	CH 1020
*MA 1023	PH 1110
*MA 1024	PH 1120
*MA 2051	PH 1130
MA 2071	PH 1140
MA 2611	BB 1001
MA 2612	BB 1002
MA 2621	
MA 3831	
MA 3832	
MA 4631	

* Mathematics requirements include differential and integral calculus and ordinary differential equations. Additional work is strongly encouraged in one or more of the subjects of probability and statistics, linear algebra, and numerical analysis.
 ** Science requirements include chemistry and physics with at least a two course sequence in either.

2/3 Units
SOCIAL SCIENCE
see page 175

2 Units
H&A SUFFICIENCY
see page 53

1 Unit
INTERACTIVE QUALIFYING PROJECT (IQP)
see page 39

1 Unit
FREE ELECTIVE
Refer to catalog

1/3 Unit
PHYSICAL EDUCATION
see page 168

6 Units (Divided approximately 2:1 between Engineering Science: Design)

MANUFACTURING ENGINEERING

One unit per area required {
Electives {

1 Unit	1 Unit	1 Unit	1 Unit
MATERIALS & PROCESSES	PRODUCT ENGINEERING AND TOOL DESIGN	COMPUTER CONTROL & MANUFACTURING SYSTEMS	PRODUCTION SYSTEMS ENGINEERING
ES 2001	ES 2501	ECE 3601	OIE 2850
ME 1800	ES 2502	ES 3011	OIE 3400
ME 2820	ES 2503	ME 3820	OIE 3401
ME 4821	ME 3320	ME 4815	OIE 3420
ME 3023	ES 1310	ECE 2011	OIE 2500
ME 3811	ES 3323	CS 2301	OIE 3405
ME 4813	ME 3310	CS 3013	OIE 3450
ME/BME 4814	ME 3311	CS 3431	OIE 3460
ME 4816	ME 3321	CS 4032	OIE 3501
ME 4822	ME 4320	CS 4033	OIE 4460
MFE 520	MFE 540	MFE 510	
		MFE 530	
1 Unit Emphasizing Design			
MAJOR QUALIFYING PROJECT (MQP)			

EDUCATIONAL PROGRAM OBJECTIVES

- Graduates should have the knowledge and skills to design and enact solutions for complex, dynamic manufacturing engineering problems faced by industry and society, using current concepts and technology
- Graduates should be able to communicate effectively, both orally and in writing, using electronic tools and graphical representations
- Graduates should be able to serve and lead the organizations that employ them, with good interpersonal and teamwork skills and with an understanding of professional ethical responsibility, and national and global contemporary issues

BACHELOR OF SCIENCE IN MANUFACTURING ENGINEERING

Manufacturing Engineering students are highly sought by industry, earning more on the average than other engineers do. Manufacturing expertise is essential to all industrialized, developing and even post-industrialized societies.

Manufacturing Engineering studies give a solid understanding of the principles of production systems, processing, manufacturability, and quality that can be applied to a wide variety of products, traditional and non-traditional products, such as aircraft, cars, robots, e-business, software, service, and information.

BACKGROUND

Manufacturing Engineering was the first engineering discipline taught at WPI, supporting for well over a century the technological base of one of the most important manufacturing regions in the world. Central Massachusetts is one of the cradles of the Industrial Revolution.

Manufacturing in Massachusetts has been of critical strategic importance for America since the beginning of the boycott of British goods that preceded the War of Independence. The manufacturing industry in Massachusetts began what is known around the world as the American System for mass production.

New England, Massachusetts and Worcester County continue to lead the nation and world in many critical manufacturing technologies.

In the 1980's WPI appropriately became one of the first schools in the country to offer an ABET accredited BS degree in Manufacturing Engineering (at that time called "Advanced Manufacturing Systems Engineering").

WPI also was one of the first schools in the country to grant a Ph.D. degree in Manufacturing Engineering. Currently WPI offers three degrees in Manufacturing Engineering, including an M. S. Manufacturing Engineering is also one of the seven concentrations in Mechanical Engineering.

Program Distribution Requirements for the Manufacturing Engineering Major

The normal period of residency at WPI is 16 terms. In addition to WPI requirements applicable to all students, students wishing to receive the degree designated "Manufacturing Engineering" must satisfy certain distribution requirements:

Requirements	Minimum Units
1. Mathematics and Basic Science (Notes 1,2)	4
2. Engineering Science and Design (including the MQP) (Note 3,4)	6

Notes:

1. Mathematics must include differential and integral calculus and differential equations.
2. Science must include both chemistry and physics with a minimum of two courses in either.
3. At least one unit from each of the following areas is required:
 - A. Materials and Processes
 - B. Product Engineering
 - C. Computer Control and Manufacturing Systems
 - D. Production Systems Engineering
4. Must include 1/3 unit of Capstone Design Experience.

PLANNING A PROGRAM IN MANUFACTURING ENGINEERING

The MFE program is constructed in a manner similar to other engineering programs. Background and competence is developed in mathematics and the basic sciences. Other WPI requirements, including the Humanities and Arts Sufficiency, social science, and IQP, must be completed. Expertise in the four areas of Manufacturing Engineering is developed. Finally, the MQP, a capstone engineering design project that integrates previous WPI education, is completed.

The chart is intended to assist in student planning. The units listed indicate minimum units required. See page 148.

Although the courses listed are appropriate for most students, it is possible to develop programs using other WPI courses. Since the MFE program is multidisciplinary in nature and has a wide range of electives, student programs should be developed in consultation with their academic advisor and the director of the Manufacturing Engineering Program.

ADDING MINORS IN OTHER AREAS: COMPUTER SCIENCE, MANAGEMENT, MATERIALS ENGINEERING, STATISTICS

Adding one of these minors can be an excellent way to get more out of your college experience and make your resume stand out. Because Manufacturing Engineering is an integrating discipline, accessing course work from other departments and programs, it can be relatively easy for MFE majors to add a minor in Computer Science, Management, Materials Engineering, or Statistics. One unit of credit can be double counted for the MFE major and one of the minors. The other unit for the minor can come from the free electives. See the descriptions for the minors under their respective programs.

FOUR- OR FIVE-YEAR DUAL-DEGREE BS/MS PROGRAM

Outstanding undergraduate students in the B.S. program in Manufacturing Engineering and the other engineering and science programs at WPI are encouraged to apply for the four- or five-year BS/MS program in Manufacturing Engineering. This dual-degree program can be completed in five years; however, curriculum planning with the student's academic advisor and the Director of Manufacturing Engineering should start during the third year at WPI in order to meet both degree requirements. (See "Combined Bachelor's/Master's Program" on page 263, and contact the Director of Manufacturing Engineering for details.)

MINOR IN MANUFACTURING ENGINEERING

A minor in Manufacturing Engineering gives students from a variety of majors the opportunity to strengthen their academic preparation and attractiveness to industry, while better preparing them to solve many of the problems that will challenge them in their careers. Most engineers are involved directly or indirectly with manufacturing or manufacturing principles. Manufacturing expertise is essential to all industrialized, developing and even post-industrialized societies. The objective of the minor in manufacturing will be to give the students a solid understanding of the principles of production, processing, manufacturability, and quality that can be applied to a wide variety of products, including non-traditional products, such as software, service and information.

The minor requires the completion of **2 units** of work as follows.

I. 1 unit of required course work selected from the following list:

- ME 1800 Material Selection and Manufacturing Processes
- ME 2820 Materials Processing
- ME 3820 Computer-Aided Manufacturing
- ES 3011 Control Engineering I

II. 2/3 unit of electives, selected from the following list of courses:

____ any of the courses above, in I., can count if the other three are completed.

- CS 4032 Numerical Methods for Linear and Nonlinear Systems
- CS 4341 Introduction to Artificial Intelligence
- ES 3323 Advanced Computer Aided Design
- ME 3310 Kinematics of Mechanisms
- ME 4530 Computational Methods in Mechanical Engineering
- ME 4815 Industrial Robotics
- ME 4821 Chemistry, Properties and Processing of Plastic
- OIE 3400 Production System Design
- OIE 3420 Quality Planning, Design and Control
- MFE 510 Control and Monitoring of Manufacturing Processes

- MFE 511 Application of Industrial Robotics
- MFE 520 Design and Analysis of Manufacturing Processes
- MFE 530 Computer Integrated Manufacturing
- MFE 540 Design for Manufacturability

III. 1/3 unit of capstone experience:

- ME 4815 Industrial Robotics
- MFE xxxx Independent Study Project (this must be approved by the MFE minor program committee)
- MFE 510 Control and Monitoring of Manufacturing Processes
- MFE 511 Application of Industrial Robotics
- MFE 520 Design and Analysis of Manufacturing processes
- MFE 530 Computer Integrated Manufacturing
- MFE 540 Design for Manufacturability

MATERIALS ENGINEERING

Courses and programs of study in materials engineering are included in the Mechanical Engineering Department (page 160). For advisory information, consult that section of the Undergraduate Catalog or members of the materials section of Mechanical Engineering.

MINOR IN MATERIALS

Material properties, material processing issues, or material costs are the limiting factor in the design or performance of almost all systems around us. Engineers, scientists, and managers in all technological sectors often must make material selection decisions based on a variety of considerations, including properties, performance, environmental impact, and cost. A Minor in Materials, feasible within a 15 unit program of study, will benefit students who wish to enhance their disciplinary major with an additional degree designation in the area of materials.

REQUIREMENTS FOR THE MATERIALS MINOR:

The minor requires the completion of 2 units of work^a as described below:

1. ES 2001 Introduction to Material Science (1/3 unit)

2. 1 1/3 units of electives, selected from the following list of courses^{b,c}:

- CE 3026 Materials of Construction
- CH 3410 Principles of Inorganic Chemistry
- CH 2310 Organic Chemistry I
- CH 2320 Organic Chemistry II
- CH 2330 Organic Chemistry III
- CH 4330 Organic Synthesis
- CH 4550 Polymer Chemistry
- CHE 3601 Chemical Materials Engineering
- ECE 3901 Semiconductor Devices
- ME 2820 Materials Processing
- ME 3023 Mechanical Behavior and Modeling Properties of Engineering Materials
- ME 3811 Microstructure Analysis and Control
- ME 4813 Ceramics

- ME/BME 4814 Biomaterials
- ME 4816 Materials Optimization for Engineers
- ME 4821 Chemistry, Properties, and Processing of Plastics
- ME 4822 Solidification Processes
- ME 4832 Corrosion and Corrosion Control
- ME 4840 Physical Metallurgy
- ME 4850 Solid State Thermodynamics
- PH 3502 Solid State Physics

Students who are able to design their undergraduate program of study such that they have sufficient preparation may also use the following graduate courses toward a Materials Minor: all MTE graduate courses; CHE 508, Catalysis and Surface Science of Materials; CHE 510, Particulate Systems; CH 555, Advanced Topics/Polymer Chemistry and Advanced Topics/Nanotechnology.

3. Capstone Experience (1/3 unit)

The capstone experience requirement for the Minor in Materials must be satisfied by an upper level course or IS/P activity that integrates and synthesizes material processing, structure, and property relationships as they affect performance.

- i) Courses that satisfy the capstone experience requirement currently include ME 4816 and ME 4822. Other courses must be approved in advance by the Program Committee for the Minor in Materials.
- ii) Students may satisfy the capstone experience requirement by completing a 1/3 unit IS/P that receives prior approval from the Program Committee for the Minor in Materials. The IS/P may, for example, take the form of a laboratory experience or may augment the MQP or IQP, considering in depth the materials issues associated with the project topic (see Note d). An IS/P related to the MQP must be distinct from the core 1 unit of the MQP and in most cases would be advised by a faculty member other than the MQP advisor.

NOTES:

- a. In accordance with the Institute-wide policy on Minors, academic activities used in satisfying the regular degree requirements may be double-counted toward meeting all but one unit of the Minor requirements (see pages 25-26 of the Undergraduate Catalog.)
- b. Undergraduates in any major who are considering graduate study in Materials Science and Engineering are advised to include ME 3023, ME 3811, ME 4840, and ME 4850 among their electives.
- c. Physics IS/P courses in Superconductors, Photonics, and Lasers may also be counted toward the Materials Minor. In addition, other new or experimental course offerings in the materials area may be approved by the Materials Minor Program Review Committee.
- d. Examples: An ECE major designing an integrated circuit for her MQP might conduct a separate analysis of the materials issues related to heat management in the device as the capstone experience for the Minor in Materials; a ME major specifying a gear in a design MQP might conduct a separate analysis of the material processing, structure, and property issues affecting fatigue life of the gear.

e. In accordance with the Institute-wide policy on Minors, the Major Qualifying Project (MQP) cannot be counted toward activity for a Minor. Therefore, a ME, CHE, or any other major whose MQP is judged to be predominantly in the materials area by the Program Review Committee may not count an extra 1/3 unit augmentation of their MQP as their capstone experience in the Minor.

f. The following faculty serve as the Program Review Committee for the Minor in Materials and will serve as Minor Advisors: Richard Sisson (ME), Chrys Demetry (ME), Tahar El-Korchi (CEE).

PERMISSIBLE MAJOR-MINOR COMBINATIONS

The Materials Minor is available to students of all majors. Students can earn *either* a Materials Minor designation *or* a Materials Concentration, not both.

MATHEMATICAL SCIENCES

B. VERNESCU, HEAD; W. MARTIN, ASSOCIATE HEAD

PROFESSORS: P. R. Christopher, P. W. Davis, A. C. Heinricher, M. Humi, K. A. Lurie, R. Y. Lui, U. Mosco, B. Nandram, J. D. Petrucci, B. Servatius, D. Tang, B. Vernescu, H. F. Walker
 ASSOCIATE PROFESSORS: W. Farr, J. D. Fehribach, C. Larsen, W. J. Martin, M. Sarkis, D. Vermes, S. Weekes
 ASSISTANT PROFESSORS: I. Blank, D. Volkov, J. Wilbur
 VISITING FACULTY: M. Blais, C. Burgos, F. Catrina, L. Roman, A. Swift, J. Williford, V. Yakovlev
 ACADEMIC STAFF: J. Abraham, J. Goulet

MISSION STATEMENT

Recognizing the vital role of the mathematical sciences in today's society, the Mathematical Sciences Department provides leading-edge programs in education, research, and professional training in applied and computational mathematics and statistics. These programs are enhanced and distinguished by project-oriented education and collaborative involvement with industry, national research centers, and the international academic community.

PROGRAM OBJECTIVES

The department's major programs provide students with preparation for effective and successful professional careers in the mathematical sciences, whether in traditional academic pursuits or in the many new career areas available in today's technologically sophisticated, globally interdependent society. Through course work, students acquire a firm grounding in fundamental mathematics and selected areas of emphasis. Projects, which often involve interdisciplinary and industrial applications, offer further opportunities to gain mathematical depth and to develop skills in problem-solving, communication, teamwork, and self-directed learning, together with an understanding of the role of the mathematical sciences in the contemporary world.

EDUCATIONAL OUTCOMES

We expect graduates to:

1. have a solid knowledge of a broad range of mathematical principles and techniques and the ability to apply them.
2. be able to read, write, and communicate mathematics inside and outside the discipline.
3. have the ability to formulate mathematical statements and prove or disprove them.
4. be able to formulate and investigate mathematical questions and conjectures.
5. understand fundamental axiom systems and essential definitions and theorems.
6. be able to formulate and analyze mathematical or statistical models.
7. have the ability to apply appropriate computational technology to analyze and solve mathematical problems.
8. be able to learn independently and as part of a team, and to demonstrate a depth of knowledge in at least one area of the mathematical sciences.

INTRODUCTION

What is the best way to route data through a computer network? How can the safety and efficacy of a new AIDS drug be established? Is there a way to combine different materials to form a composite with maximum strength for a given weight? How much should be charged for the option to buy a stock at a certain price in one year's time? How does one put a price tag on the risk presented by a 17-year old male driver? These are just some of the exciting challenges encountered by professionals in the mathematical sciences.

Study in the mathematical sciences requires hard work and discipline to attain the clarity, precision, logic, and economy of thought that recruiters from business, industry and academia value so highly in our graduates. And the rewards are substantial: mathematical science careers such as actuary, statistician and mathematician consistently rank at the top of lists of the most desirable professions. If what we've said so far interests you, read on to learn more about what mathematical scientists do, and particularly about how our programs—Mathematical Sciences and Actuarial Mathematics—can prepare you for a challenging and rewarding career.

PROGRAM IN MATHEMATICAL SCIENCES

Study in the mathematical sciences offers a broad spectrum of opportunities to the prospective major. While filled with open problems and subject to intense research in well-established areas, the mathematical sciences are constantly undergoing renewal as new questions and challenges arise in applications. Indeed, whole new areas of mathematical sciences are continually being born and existing areas are reinvigorated as surprising connections are discovered to the physical, biological, and social sciences, to computer science, and to engineering, business, industry, and finance. Not surprisingly, many of our majors are double majors who seek to apply mathematics to problems in their other fields. Such students are trained in the modeling, analysis, and computation necessary for solving problems in their other fields of interest.

Career opportunities for majors are many and varied. Recent graduates have embarked on careers in business and industry (e.g., Microsoft Corporation, Raytheon Company, Polaroid Corporation, MITRE Corporation, Fidelity Investments, Aetna Insurance, and Sun Life Financial) or have entered graduate school (e.g., Purdue University, University of California at Berkeley, Harvard University, Stanford University, Northwestern University, WPI) in such diverse disciplines as mathematics, statistics, law, management, physics, nuclear engineering, civil engineering, and education. More on career and employment opportunities can be found at the web sites of the Mathematical Association of America <http://www.maa.org/students/career.html>, or the American Statistical Association <http://www.amstat.org/careers/index.cfm?fuseaction=main>.

PROJECTS/INDEPENDENT STUDIES

Some of the most active career directions in the mathematical sciences are reflected in the MQP areas around which the department's offerings are organized: Algebraic and Discrete Mathematics, Computational and Applied Analysis, Operations Research, and Probability and Statistics. As early as practical, and certainly no later than the sophomore year, the mathematical sciences major should begin exploring these different areas. The transition courses, MA 2073, 2271, 2273, 2431, and 2631, are specifically designed to introduce the four MQP areas while preparing the student for advanced courses and the MQP.

While most students choose MQPs in one of the four areas mentioned above, it is possible to design an MQP that does not fit into any one area. In these cases, students will want to take special care to plan their programs carefully with their advisors so that sufficient backgrounds are obtained by the time the students begin their MQPs.

Many MQPs involve the solution of real-world problems proposed by industrial sponsors. Details can be found at <http://www.wpi.edu/Academics/Depts/Math/CIMS>.

A current listing of specific available projects with their descriptions is available at <http://www.wpi.edu/Academics/Projects/available.html>.

Independent studies are a good way for students to learn topics that are not taught in regularly-scheduled courses. Interested students should approach faculty with requests for independent studies. Some independent study areas and faculty advisors are listed below. In what follows, you will find for each MQP area:

- A brief description of the area including the kinds of challenges likely to be encountered by MQP students and mathematical scientists working there.
- Courses of interest.
- MQP and independent study topics and advisors.
- Examples of recent MQPs.

ALGEBRAIC AND DISCRETE MATHEMATICS

Algebraic and discrete mathematics is recognized as an increasingly important and vital area of mathematics. Many of the fundamental ideas of discrete mathematics play an important role in formulating and solving problems in a variety of fields ranging from ecology to computer science. For instance, graph theory has been used to study competition of species in ecosystems, to schedule

traffic lights at an intersection, and to synchronize parallel processors in a computer. Coding theory has been applied to problems from the private and public sectors where encoding and decoding information securely is the goal. In turn, the problems to which discrete mathematics is applied often yield new and interesting mathematical questions. The goal of a project in discrete mathematics would be to experience this interaction between theory and application. To begin, a typical project team would assess the current state of a problem and the theory that is relevant. Once this is done, the project team's objective would be to make a contribution to solving the problem by developing new mathematical results.

In working in discrete mathematics, one may be writing algorithms, using the computer as a modeling tool, and using the computer to test conjectures. It is important that a student interested in this area have some computer proficiency. Depending on the project, an understanding of algorithm analysis and computational complexity may be helpful.

Courses of Interest

- MA 2271 Graph Theory
- MA 2273 Combinatorics
- MA 3231 Linear Programming
- MA 3233 Discrete Optimization
- MA 3823 Group Theory
- MA 3825 Rings and Fields
- MA 4891 Topics in Mathematics (when appropriate)
- CS 2301 Systems Programming for Non-Majors
- CS 4120 Analysis of Algorithms
- CS 4123 Theory of Computation

MQP AND INDEPENDENT STUDY TOPICS AND ADVISORS

Topic Area	Faculty Advisor(s)
Coding Theory and Cryptography	W. J. Martin, B. Servatius
Combinatorics	P. R. Christopher, W. J. Martin, B. Servatius
Discrete Optimization	W. J. Martin, B. Servatius
Finite Fields	W. J. Martin, B. Servatius
Graph Theory and Applications	P. R. Christopher, B. Servatius
Group Theory	P. R. Christopher, B. Servatius
Linear Algebra	P. R. Christopher, W. J. Martin, B. Servatius
Number Theory	W. J. Martin, B. Servatius

Some Recent Algebraic and Discrete Mathematics MQPs:

Combinatorial Structures in Cryptography

Student: Hardy, Seth Michael
Advisor: MARTIN, W. J. (MA)

Error correcting codes, such as Reed-Solomon codes, can be used to create authentication codes based on orthogonal arrays. These codes are provably secure up to a certain number of uses; however, as the number of desired uses goes up, so does the keylength. This project

researches the security of a code whose messages (which function as private keys) have specific form that allows them to be represented in a more compact fashion. Specifically, messages with low Hamming weight are considered.

Winkler Percolations

Students: Hajeski, John and Gronlund, Jason
Advisor: SERVATIUS B. (MA)

Winkler percolations, also known as coordinate percolations, are digraphs generated by random 0-1 sequences. The percolations nature is determined by the frequency of 1s in the sequences, governed by a fixed probability p of occurrence. An open question is at what p is the completeness of the percolation no longer ensured. We look into this question using a combinatorial study of small finite examples, and the self-similarity of this model is analyzed using methods of renormalization group theory.

COMPUTATIONAL AND APPLIED ANALYSIS

This area of mathematics concerns the modeling and analysis of continuous physical or biological processes that occur frequently in science and engineering. Students interested in this area should have a solid background in analysis which includes the ability to analyze ordinary and partial differential equations through both analytical and computational means.

In most circumstances, an applied mathematician does not work alone but is part of a team consisting of scientists and engineers. The mathematician's responsibility is to formulate a mathematical model from the problem, analyze the model, and then interpret the results in light of the experimental evidence. It is, therefore, important for students to have some experience in mathematical modeling and secure a background in one branch of science or engineering through a carefully planned sequence of courses outside of the department.

With the increase in computational power, many models previously too complicated to be solvable, can now be solved numerically. It is, therefore, recommended that students acquire enough computer proficiency to take advantage of this. Computational skill is growing in importance and should be a part of every applied mathematician's training. Students may learn these skills through various numerical analysis courses offered by the department. An MQP in this area will generally involve the modeling of a real-life problem, analyzing it, and solving it numerically.

Courses of Interest

- MA 2251 Vector and Tensor Calculus for Engineers
- MA 2431 Mathematical Modeling with Ordinary Differential Equations
- MA 3231 Linear Programming
- MA 3257 Numerical Methods for Linear and Nonlinear Systems
- MA 3457 Numerical Methods for Calculus and Differential Equations
- MA 3471 Advanced Ordinary Differential Equations
- MA 3475 Calculus of Variations
- MA 4235 Mathematical Optimization
- MA 4291 Applicable Complex Variables
- MA 4411 Numerical Analysis of Differential Equations
- MA 4451 Boundary Value Problems
- MA 4473 Partial Differential Equations

MQP AND INDEPENDENT STUDY TOPICS AND ADVISORS

Topic Area	Faculty Advisor(s)
Calculus of Variations	I. Blank, C. Larsen, K. Lurie, U. Mosco, M. Sarkis, B. Vernescu, D. Volkov
Chemical Reaction Models	P. W. Davis, W. Farr
Composite Materials	C. Larsen, K. Lurie, B. Vernescu
Fluid Mechanics	M. Humi, D. Tang, S. Weekes
Mathematical Biology	R. Lui, D. Tang
Mathematical Physics	M. Humi, C. Larsen, D. Volkov
Numerical Methods for Differential Equations/ Scientific Computation	W. Farr, J. D. Fehribach, M. Humi, M. Sarkis, D. Tang, H. Walker, S. Weekes
Optimal Control/Stochastic Control	A. C. Heinricher, D. Vermes

Some Recent Computational and Applied Analysis MQPs:***Numerical Methods for Neutral Coated Inclusions Conductivity***

Student: Murphy, Ethan K.

Advisor: SARKIS-MARTINS, M. (MA)

This project used finite element method to obtain neutral coated inclusions shapes for a thermal conductivity problem. Such an inclusion when inserted in a homogeneous matrix has the property that it does not disturb the uniform heat flow outside the inclusion. A free-boundary problem was formed and Newton's Method was used to handle the nonlinearity of the system. Dynamic mesh refinements were implemented to increase accuracy in certain areas. Iterations of the method yielded the desired neutrally coated shapes.

Modeling Glioblastoma Multiforme

Student: Voutila, David

Advisor: WEEKES, S. L. (MA)

Glioblastoma multiforme (GBM), a highly lethal brain cancer, accounts for over 30% of brain tumors in adult patients. Patients typically survive only 12-18 months after diagnosis. Our model describes the dynamics of GBM development via a system of conservation laws for tumor cell population, nutrients, and toxins. We also account for the effect of and changes in the mechanical resistance of surrounding brain matter. The governing system of equations is of mixed type and requires very careful numerical treatment. We use an Alternating Direction Implicit approach for the parabolic (diffusive) portions of the PDEs, an explicit, conservative method for the hyperbolic (convective) portion, and a semi-implicit approach for the growth terms. The numerical code is written in C for implementation on a parallel computer.

OPERATIONS RESEARCH

Operations research is an area of mathematics which seeks to solve complex problems that arise in conducting and coordinating the operations of modern industry and government. Typically, operations research looks for the

best or optimal solutions to a given problem. Problems within the scope of operations research methods are as diverse as finding the lowest cost school bus routing that still satisfies racial guidelines, deciding whether to build a small plant or a large plant when demand is uncertain, or determining how best to allocate timesharing access in a computer network.

Typically, these problems are solved by creating and then analyzing a mathematical model to determine an optimal strategy for the organization to follow. Often the problem requires a statistical model, and nearly always the analysis - whether optimizing through a set of equations or simulating the behavior of a process - involves the use of a computer. Finally, operations researchers must be able to interpret and apply the results of their analyses in an appropriate manner.

In addition to a solid background in calculus, probability and statistics, and the various operations research areas, prospective operations researchers should be familiar with computer programming and managerial techniques.

Courses of Interest

MA 2271	Graph Theory
MA 2273	Combinatorics
MA 3231	Linear Programming
MA 3233	Discrete Optimization
MA 3627	Applied Statistics III
MA 3631	Mathematical Statistics
MA 4235	Mathematical Optimization
MA 4237	Probabilistic Methods in Operations Research
MA 4631	Probability and Mathematical Statistics I
MA 4632	Probability and Mathematical Statistics II
OIE 2500	Management Science I: Deterministic Decision Models
OIE 3460	Simulation Modeling and Analysis
OIE 3501	Management Science II: Risk Analysis

MQP AND INDEPENDENT STUDY TOPICS AND ADVISORS

Topic Area	Faculty Advisor(s)
Control Theory	K. Lurie, A. C. Heinricher
Stochastic Controls	D. Vermes, A. C. Heinricher
Stochastic Differential Equations	A. C. Heinricher, D. Vermes

Some Recent Operations Research MQPs:***Stochastic Modeling of Real Time Queues***

Student: Morgan, Brittany Rose

Advisor: DOYTCHINOV, B. (MA)

This project looked at a simple queuing system with three different due date distributions. For each task generated, a deadline was assigned. The server then served the most urgent task first, for a time-step, then reassessed the most urgent, and continued until all tasks were served. We have numerically simulated the due dates with the exponential, random, and triangular distributions. generated lead time profiles, and have compared the data with theoretical predictions to determine the accuracy of our method.

Mathematical Models of Damage Spread in Networks

Student: St. Hilaire, Melissa April

Advisor: HEINRICHER, A. C. (MA)

This project describes mathematical models for how damage, measured in lost capacity, can spread through an organization. The model allows a company to simulate

MATHEMATICAL SCIENCES MAJOR PROGRAM CHART

UNIVERSITY REQUIREMENTS	
Minimum Academic Credit	15 Units
Residency	8 Units
Sufficiency	2 Units
Interactive Qualifying Project	1 Unit
Major Qualifying Project	1 Unit
Social Science	2/3 Unit
Physical Education	1/3 Unit

FOUNDATION COURSES

INTRODUCTORY COURSES	TRANSITION COURSES (1 Unit Required)	CORE COURSES (4/3 Unit Required)
MA 1021-1024 or MA 1031-1034 MA 2051 MA 2071 MA 2201 MA 2251 MA 2611	MA 2073 MA 2271* MA 2273* MA 2431 MA 2631	Both MA 3831 and MA 3832 One of MA 3257 or MA 3457 One of MA 3823* or MA 3825*

OTHER MA COURSES TO ATTAIN TOTAL OF 6 UNITS:

ACTUARIAL MATH	ANALYSIS	ALGEBRA	DISCRETE MATH	COMPUTATIONAL MATH	OPERATIONS RESEARCH	STATISTICS/PROBABILITY
MA 3211 MA 3212 MA 4213* MA 4214*	MA 2431 MA 3471* MA 3475* MA 4291 MA 4451 MA 4473*	MA 2073 MA 3823* MA 3825*	MA 2271* MA 2273* MA 3233*	MA 3257 MA 3457 MA 4411*	MA 3231 MA 3233* MA 4235* MA 4237*	MA 2612 MA 2621 MA 2631 MA 3627* MA 3631 MA 4214* MA 4631 MA 4632 MA 4658

OTHER REQUIREMENTS	
Computer Science Courses	2/3 Unit

* Category II courses, offered in alternating years.

damage spread and compare different strategies for allocating repair resources after the initial damage has occurred. This project was completed in collaboration with Lehman Brothers investment firm in the aftermath of the terrorist attacks in September 11, 2001.

PROBABILITY AND STATISTICS

In many areas of endeavor, decisions must be made using information which is known only partially or has a degree of uncertainty attached to it. One of the major tasks of the statistician is to provide effective strategies for obtaining the relevant information and for making decisions based on it. Probabilists and statisticians are also deeply involved in stochastic modeling - the development and application of mathematical models of random phenomena. Applications to such areas as medicine, engineering, and finance abound.

Students interested in becoming probabilists or mathematical statisticians should consider additional study in graduate school. While graduate study is an option for students whose goals are to be applied statisticians, there are also career opportunities in business, industry, and government for holders of a B.S. degree. More information about careers in statistics can be found at the American Statistical Association's web site <http://www.amstat.org/careers/index.cfm?fuseaction=main>.

Students planning on graduate studies in this area would be well advised to consider, in addition to the courses of interest listed below, additional independent study or PQP work in probability and statistics, or some of the department's statistics graduate offerings.

Courses of Interest

MA 2611	Applied Statistics I
MA 2612	Applied Statistics II
MA 2631	Probability
MA 3627	Applied Statistics III
MA 3631	Mathematical Statistics
MA 4237	Probabilistic Methods in Operations Research
MA 4631	Probability and Mathematical Statistics I
MA 4632	Probability and Mathematical Statistics II

MQP AND INDEPENDENT STUDY TOPICS AND ADVISORS

Topic Area	Faculty Advisor(s)
Applied Probability	A. C. Heinricher
Bayesian Statistics	B. Nandram
Industrial Applications	J. D. Petrucci
Multivariate Analysis	J. D. Wilbur
Non-Parametric Statistics	J. D. Wilbur
Statistical Computation	B. Nandram, J. D. Wilbur
Stochastic Models	B. Nandram, J. D. Petrucci
Survey Sampling Theory	B. Nandram
Time Series	J. D. Petrucci

Some Recent Probability and Statistics MQPs:

Hearing Data

Students: Barber, Gary Paul Kulasekaran, Nedunceluyan
Advisor: PETRUCCELLI, J. D. (MA)

Sonification, the representation of data in an auditory format, has already found use in Electrocardiograms and Geiger Counters, which suggests potential applications in realms dominated by visually-based analysis methods.

This project developed and studied three approaches to the sonification of time series data, using the Additive Classical Decomposition of time series as the starting point, with its own statistical analysis-and-mapping and sonification programs. Results of investigations by controlled experiment using human subjects suggest the sonification methods are effective.

Statistical Computations: Accuracy and Stability

Student: Legare, Jonathan

Advisor: PETRUCCELLI, J. D. (MA)

The accuracy and stability of the Ti-83+ graphing calculators and the

International Mathematical and Statistical Libraries were assessed in the areas of pseudo-random number generation, calculation of statistical distributions, and estimation. For each package: Random number generators were tested using Marsaglia's DIEHARD Battery of Randomness Tests; The NIST Statistical Reference Datasets were used to assess the accuracy of univariate summary statistics, analysis of variance, linear regression and nonlinear regression; Probability distribution functions were assessed with Knusel's ELV.

Program Distribution Requirements for the Mathematical Sciences Major

The normal period of residency at WPI is 16 terms. In addition to the WPI requirements applicable to all students, completion of a minimum of 10 units of study is required as follows:

Requirements	Minimum Units
1. Mathematics including MQP (See notes 1-4).	7
2. Courses from other departments that are related to the student's mathematical program. At least 2/3 unit in computer science must be included; the remaining courses are to be selected from science, engineering, computer science or management (except MG 1250) (see Note 5).	2
3. Additional courses or independent studies (except MS, PE courses, and other degree requirements) from any area.	1

NOTES:

1. Must include MA 3831-3832, or their equivalents, at least one of MA 3257, MA 3457, or equivalent, and at least one of MA 3823, MA 3825, or equivalent.
2. Must include at least three of the following: MA 2073, MA 2271, MA 2273, MA 2431, MA 2631, or their equivalents.
3. At least 7/3 units must consist of MA courses at the 3000 level or above.
4. May not include both MA 2631 and MA 2621.
5. May not include both CS 3043 and CS 2022.

PROGRAM IN ACTUARIAL MATHEMATICS

An actuary is a business professional who uses mathematical skills to define, analyze, and solve financial and social problems. Preparation for a career as an actuary requires mathematical aptitude, but actuarial work involves a practical type of mathematical ability mixed with business skills. An actuary deals with real-life problems rather than theoretical ones, must be curious, have sound judgment, and be able to think logically and creatively. The goal of the program in actuarial mathematics is to prepare

students for positions in life and health insurance companies, property and casualty insurance companies, consulting firms, or state or federal government agencies.

The most widely accepted standard of professional qualification to practice as an actuary in the United States is a Fellowship in either the Society of Actuaries (SoA) or the Casualty Actuarial Society (CAS). Each organization administers a series of examinations leading to Fellowship. The first few in this series are mathematical in nature covering topics in calculus and linear algebra, probability, mathematical and applied statistics. Students interested in the actuarial mathematics program should read the latest SoA Associateship Catalog for more information. This catalog may be obtained from the Department of Mathematical Sciences, or at <http://www.soa.org>.

The actuarial mathematics program at WPI provides the first steps in preparing for these examinations and an introduction to fundamentals in business and economics. Students with mathematical aptitude should be able to pass the first two SoA examinations before graduation.

After graduation, most actuarial training is through self-study combined with on-the-job experience. Many employers rotate their actuarial trainees through various assignments exposing them to different aspects of business operations. In addition, companies frequently maintain actuarial libraries, sponsor group study sessions, and give trainees study time during work hours.

Brief descriptions of the project opportunities, distribution requirements, and the actuarial examinations are given below.

PROJECTS/INDEPENDENT STUDIES

Off-campus qualifying projects are regularly done in collaboration with insurance companies, and have in the past been sponsored by Aetna, Allmerica Financial, Blue Cross Blue Shield of Massachusetts, John Hancock Mutual Insurance, Premier Insurance, and Travelers Property Casualty. These projects give real-world experience of the actuarial field by having students involved in solving problems faced by professional actuaries. Instead of choosing a project already posed by a company/advisor team, students may instead seek out industry-sponsored projects on their own (often through internship connections) and propose them to a potential faculty advisor. Alternatively, students may choose to complete any other project in mathematics.

Students should select MQP and independent study topics which are related to their areas of preparation and interest. Some project and independent study areas are given below. In addition, a current listing of specific available projects with their descriptions is available at the department office, and at <http://www.wpi.edu/Academics/Projects/available.html>.

MQP AND INDEPENDENT STUDY TOPICS AND ADVISORS

Topic Area	Faculty Advisor(s)
Actuarial Models (Stochastic and Deterministic)	J. Abraham
Asset/Liability Management	D. Vermes
Auto Insurance Cession Strategies	A. Heinricher, J. Abraham

Interest Rate Modeling	D. Vermes
Mathematical Finance	R. Lui
Pricing Insurance and Annuity Contracts	J. Abraham
Risk Classification	A. Heinricher
Survival Models	J. Abraham

Some Recent Actuarial Mathematics MQPs:

Estimating Disability Incidence

Students: D’Onofrio, Michael; Lescoe, James; Simone, Jeffrey; Twarog, Marek

Advisor: ABRAHAM, J. P. (MA)

Sponsor: John Hancock Life Insurance Company

This paper uses data from the 1999 NLTCs and NHIS surveys to compute Long Term Care (LTC) prevalence rates. We develop several triggers, evaluate a test of cognitive ability, and compute prevalence rates for each trigger. We develop a model to compute LTC incidence rates based on the prevalence data. We find that incidence is a strictly increasing function of age and that there is a sharp increase in incidence rates starting at age ninety.

Volatility Costs in Assigned Risk Plans

Students: Bui, Vonda Elizabeth and Yu, Ying Fang

Advisor: ABRAHAM, J. P. (MA) and

HEINRICHER, A.C. (MA)

This project studied the new assigned risk plan for Massachusetts automobile insurance. The current method is a simple lottery in which each company’s voluntary market share determines its probability of receiving the next high-risk driver. Results show that a dynamic method that adjusts assignment probabilities according to each company’s current residual market share can reduce volatility costs by 50% for all insurance companies in the state.

Program Distribution Requirements for the Actuarial Mathematics Major

The normal period of residency at WPI is 16 terms. In addition to the WPI requirements applicable to all students, completion of a minimum of 10 units of study is required as follows:

Requirements	Minimum Units
1. Mathematics (including MQP) (See notes 1-6).	7
2. Management (See note 7).	4/3
3. Additional courses or independent studies (except MS, PE courses, and other degree requirements) from any area (See note 8).	5/3

NOTES:

1. Must include MA 3831 and MA 3832, or their equivalents, at least one of MA 3257, MA 3457, or equivalent, and at least one of MA 3631, MA 4632, or equivalent.
2. Must include two of the following: MA 2073, MA 2271, MA 2273, MA 2431, MA 2631, or their equivalents.
3. Must include three of the following: MA 3211, MA 3212, MA 4213, MA 4214, or their equivalents.
4. May not include independent studies directed toward Society of Actuaries exams.
5. May not include either MA 2201 or MA 2210.
6. May not include both MA 2631 and MA 2621.
7. Must include ACC 2101 and FIN 2200 or their equivalents.
8. Must include 2/3 units of computer science.

ACTUARIAL MATHEMATICS MAJOR PROGRAM CHART

UNIVERSITY REQUIREMENTS	
Minimum Academic Credit	15 Units
Residency	8 Units
Sufficiency	2 Units
Interactive Qualifying Project	1 Unit
Major Qualifying Project	1 Unit
Social Science	2/3 Unit
Physical Education	1/3 Unit

FOUNDATION COURSES

INTRODUCTORY COURSES	TRANSITION COURSES (2/3 Unit Required)	CORE COURSES (4/3 Unit Required)	ACTUARIAL COURSES (1 Unit Required)
MA 1021-1024 or MA 1031-1034 MA 2051 MA 2071 MA 2251 MA 2611	MA 2073 MA 2271* MA 2273* MA 2431 MA 2631	Both MA 3831 and MA 3832 One of MA 3257 or MA 3457 One of MA 3631* or MA 4632*	MA 3211 MA 3212 MA 4213* MA4214*

OTHER MA COURSES TO ATTAIN TOTAL OF 6 UNITS:

ACTUARIAL MATH	ANALYSIS	ALGEBRA	DISCRETE MATH	COMPUTATIONAL MATH	OPERATIONS RESEARCH	STATISTICS/PROBABILITY
MA 3211 MA 3212 MA 4213* MA 4214*	MA 2431 MA 3471* MA 3475* MA 4291 MA 4451 MA 4473*	MA 2073 MA 3823* MA 3825*	MA 2271* MA 2273* MA 3233*	MA 3257 MA 3457 MA 4411*	MA 3231 MA 3233* MA 4235* MA 4237*	MA 2612 MA 2621 MA 2631 MA 3627* MA 3631 MA 4214* MA 4631 MA 4632 MA 4658

OTHER REQUIREMENTS

Computer Science (2/3 Unit Required)	Management (4/3 Unit Required)	
	Required ACC 2101 FIN 2200	Suggested ACC 1100 FIN 2250* FIN 2260 OBC 2300 OIE 2500 OIE 3460 OIE 3501

* Category II courses, offered in alternating years.

WPI COURSES AND THE SOCIETY OF ACTUARIES (SOA) EXAMINATIONS

The formulation of the distribution requirements for the program in actuarial mathematics was in large part motivated by the nature of the sequence of examinations that lead to Fellowship in the SOA or CAS. In particular, there are a number of WPI courses that cover fundamental topics that are included on the first few exams in this sequence.

Society of Actuaries

Examination	WPI Courses
1. Mathematical Foundations of Actuarial Science	MA 1021 to MA 1024, MA 2631
2. Interest Theory, Economics and Finance	MA 3211, ECON 1110, ECON 1120, ACC 1100, FIN 2200
3. Actuarial Models	MA 3212, MA 4213, MA 4214, MA 2431, MA 4237
4. Actuarial Modeling	In addition to topics in 3.: MA 2071, MA 2611, MA 2612, MA 3627

It must be emphasized that course work alone is not sufficient preparation for the examinations listed above; passing requires additional self-study. Several publications of the Society of Actuaries are available in the mathematics department office, and comprehensive information may be found at <http://www.soa.org> and <http://www.casact.org>. In addition, requests for information about the actuarial profession can be sent to the Society of Actuaries, 475 North Martingale Road, Suite 800, Schaumburg, IL 60173-2226.

STATISTICS MINOR

Statistical methods are widely used in science, engineering, business, and industry. The Statistics Minor is appropriate for all WPI students with interests in experimental design, data analysis, or statistical modeling. The minor is designed to enable a student to properly design studies and analyze the resulting data, and to evaluate statistical methods used in their field of study.

The statistics minor consists of completion of at least 2 units of work, which must consist of:

1. **At least 5/3 units of coursework**, which must be drawn from the following lists of Foundation and Upper-Level Courses, and which must include successful completion of at least 2/3 units from each list:

Courses for Statistics Minor (5/3 Unit Required)

Foundation Courses (2/3 Unit Required)

MA 2073	Matrices and Linear Algebra II
MA 2611	Applied Statistics I
MA 2612	Applied Statistics II
MA 2631	Probability, or
MA 2621	Probability for Applications

Upper-Level Courses (2/3 Unit Required)

MA 3627	Applied Statistics III
MA 3631	Mathematical Statistics
MA 4213	Risk Theory
MA 4214	Survival Models
MA 4237	Probabilistic Methods in Operations Research
MA 4631	Probability and Mathematical Statistics I
MA 4632	Probability and Mathematical Statistics II
Any statistics graduate course:	
MA 509 or any course numbered MA 540 through MA 559	

2. **Capstone Experience** The capstone experience usually consists of completion of MA 4658, Statistical Consulting. In this course, undergraduate students work with statistics faculty and graduate students to learn statistical practice and provide statistical advice to clients from the WPI community. Alternatively, students may arrange an independent study with one of the statistics faculty.

For information about the Statistics Minor, see any of the statistics faculty: Professors Joseph D. Petrucci, Balgobin Nandram, or Jayson D. Wilbur.

MATHEMATICS MINOR

The Minor in Mathematics consists of successful completion of at least 2 units of academic activities in mathematical sciences.

Students are encouraged to choose thematically-related courses toward their minor so as to gain in-depth knowledge in some sub field of mathematics. The course selection should be discussed in advance with a Mathematical Sciences Department faculty member. The following requirements must be satisfied.

1. At least 5/3 units must be coursework in the Mathematical Sciences Department at the 2000 level or above, of which at least 2/3 units must be upper-level courses, i.e. 3000-level, 4000-level, or graduate mathematics courses. Courses selected at the 2000 level, if any, must include at least one of the following courses:

MA 2073	Matrices and Linear Algebra II
MA 2251	Vector and Tensor Calculus
MA 2271	Graph Theory
MA 2273	Combinatorics
MA 2431	Mathematical Modeling with Ordinary Differential Equations
MA 2631	Probability
2. The final 1/3 unit Capstone Experience: The integrating capstone experience requires prior approval by the Mathematical Sciences Program Review Committee. The experience may be satisfied by certain 3000-level, 4000-level or graduate courses offered by the department (with instructor approval) or by a suitable independent study with a Mathematical Sciences faculty member. At the conclusion of the process, the student will fill out the Mathematics Minor Program Approval Form to be signed by the Capstone Experience instructor and the Program Review Committee.

Here are some examples of 5/3 units of coursework for four thematically-related minors. Other options are available.

Applied Analysis	Computational Analysis	Differential Equations	Discrete Mathematics	Operations Research
MA 2051	MA 2051	MA 2051	MA 2201	MA 2071
MA 2071	MA 2071	MA 2251	MA 2271	MA 2073
MA 2431	MA 2073	MA 3471	MA 2273	MA 3231
MA 3831	MA 3257	MA 4411	MA 3233	MA 3233
MA 3832	MA 3457	MA 4473	MA 533	MA 4235 or MA 4237

For more information about the Mathematics minor, see Professor Farr.

MECHANICAL ENGINEERING

G. TRYGGVASON, HEAD

PROFESSORS: D. Apelian, I. Bar-On, C. A. Brown, M. Dimentberg, W. W. Durgin, N. A. Gatsonis, A. H. Hoffman, Z. Hou, H. Johari, M. M. Makhlof, R. L. Norton, R. J. Pryputniewicz, Y. Rong, B. J. Sivilonis, S. Shivkumar, R. D. Sisson, Jr., J. M. Sullivan, Jr., G. Tryggvason

ASSOCIATE PROFESSORS: H. K. Ault, M. Demetriou, C. Demetry, M. Fofana, K. A. Notarianni, D. J. Olinger, M. W. Richman

ASSISTANT PROFESSORS: J. Blandino, C. Furlong, J. Liang, Y.-M. Moon

ADJUNCT ASSISTANT PROFESSOR: E. C. Cobb

EMERITUS PROFESSORS: R. Biederman, J. M. Boyd, H. T. Grandin, R. Hagglund, W. A. Kistler, J. A. Mayer, Jr., K. E. Scott, D. N. Zwiep

MISSION STATEMENT

The Mechanical Engineering program at WPI is designed to develop graduates who can deal with real world situations that involve technological and humanistic/societal issues. Students develop literacy and competency in utilizing scientific and engineering methods for devising useful products in an economical way, while considering the impacts on society. The Mechanical Engineering program is in harmony with the WPI Plan philosophy of education, in which each student develops competence, confidence and the skill of self-learning.

EDUCATIONAL PROGRAM OBJECTIVES

The Mechanical Engineering Program seeks to have alumni who:

- are successful professionals because of their mastery of the fundamental engineering sciences, and mechanical engineering and their understanding of the design process.
- are leaders in business and society due to a broad preparation in technology, communication, teamwork, globalization, ethics, business acumen and entrepreneurship.
- will use their understanding of the impact of technology on society for the betterment of humankind.

EDUCATIONAL OUTCOME

Graduating students should demonstrate the following at a level equivalent to an entry-level engineer or first year graduate student:

- an ability to apply knowledge of mathematics, science, and engineering
- an ability to design and conduct experiments, as well as to analyze and interpret data
- an ability to design a system, component, or process to meet desired needs
- an ability to function on multi-disciplinary teams
- an ability to identify, formulate, and solve engineering problems
- an understanding of professional and ethical responsibility
- an ability to communicate effectively
- the broad education necessary to understand the impact of engineering solutions in a global and societal context
- a recognition of the need for, and an ability to engage in life-long learning
- a knowledge of contemporary issues
- an ability to use the techniques, skills, and modern engineering tools necessary for engineering practice.

INTRODUCTION

Mechanical engineering uses the basic laws of the physical sciences, life sciences, the social science, and the humanities in their quest to serve mankind.

Airplanes, automobiles, trains, space vehicles, earth-moving equipment, nuclear reactors, plasma generators, heart-lung machines, miniature bearings, machines and machine tools are but a few examples of the products with which mechanical engineering is associated.

Compared with other fields of engineering, mechanical engineering is the broadest in application as well as the most basic. Mechanical engineers design products, supervise production, conduct research and development, and manage businesses or technical operations. In addition, mechanical engineering requires persons who can use the sciences to devise useful products in an economic manner while minimizing the loss of our natural resources.

Looking forward to this wide range of possible careers, mechanical engineering students should get a sound foundation in mathematics and science, plan a sequence of cultural and social studies, aim for a real understanding of the fundamentals of engineering, and achieve a proper balance between theory and application. A working knowledge of computers must be established through formal or informal learning processes. Inspection trips to industrial plants and cooperative education assignments are encouraged.

In this regard, the Mechanical Engineering Department offers extensive, modern, well-equipped facilities in the Higgins and Washburn Laboratories. These laboratories, covering the broad spectrum of mechanical engineering activities, are briefly described in the *Resources available to Undergraduate Students* section of this Catalog. They are widely used by the students enrolled in Mechanical Engineering and related programs.

MECHANICAL ENGINEERING PROGRAM CHART

STUDENTS EARNING A B.S. DEGREE IN MECHANICAL ENGINEERING MUST COMPLETE 15 UNITS OF STUDY, DISTRIBUTED AS FOLLOWS:

4 UNITS OF NON-TECHNICAL ACTIVITIES

2 UNITS H&A SUFFICIENCY	See WPI Requirements
1 UNIT INTERACTIVE QUALIFYING (IQP) PROJECT	See WPI Requirements
2/3 UNIT SOCIAL SCIENCE	See WPI Requirements
1/3 UNIT PHYSICAL EDUCATION	See WPI Requirements

1 UNIT FREE ELECTIVE

1 UNIT FREE ELECTIVE	See Catalog
----------------------	-------------

4 UNITS OF MATHEMATICS AND BASIC SCIENCE

4/3 Units
Student Selected Courses from the General Category of Mathematics and/or Basic Science

5/3 Units
Differential & Integral Calculus and Ordinary Differential Equations

3/3 Units
One Chemistry and Two Physics, OR One Physics and Two Chemistry

MATHEMATICS	
MA 1021	MA 1023
MA 1022	MA 1024
MA 2051	

SCIENCE	
CH 1010	CH 1020
PH 1110	PH 1120

6 UNITS OF MECHANICAL ENGINEERING (Notes 1 & 2)

1 unit required	1 unit required	1 unit required	1 unit required	2 units required
MECHANICAL SYSTEMS	THERMOFLUID SYSTEMS	OTHER COURSES	MAJOR QUALIFYING PROJECT (MQP)	ELECTIVES
ES 2501 ES 2502 ES 2503	ES 3001 ES 3003 ES 3004	ES 2001 ECE 3601 ME 3901		At least one unit must be chosen as ES or ME courses at the 4000-level or higher.

The courses listed above can be replaced by other equivalent courses, with approval by the ME Program Committee.

Note 1: A complete program must include an activity in each of the following six categories. Courses used to satisfy these activities can be multiple-counted. They can be used to simultaneously satisfy the mechanical engineering, mathematics and basic science, and free elective requirements.

OTHER ACTIVITIES					
Linear Algebra	Statistics	Mechanical System Design	Thermofluid System Design	Realization	Capstone Design
MA 2071 ME 3501 MA 2073 ME 4505 MA 4411 ME 4512 ME 3311 ME 4530 ME 3321 ME 4605	MA 2611 MA 2612 MA 2621 ME 3901	ME 3310 ME 4320 ME 3311 ME 4430 ME 3320 ME 4770 ME 3506 ME 4771 ME 4816 MQP (depending on topic)	ME 4429 ME 4430 ME 4770 ME 4771 MQP (depending on topic)	ES 3323 ME 1800 ME 2300 ME 3506 MQP (depending on topic)	ME 4320 ME 4429 ME 4430 ME 4770 ME 4810 MQP (depending on topic)

Note 2: Elective courses from other engineering disciplines may also be selected at the 2000, 3000 or 4000 levels.

Program Distribution Requirements for the Mechanical Engineering Major

The normal period of residency at WPI is 16 terms. In addition to WPI requirements applicable to all students (see page 21), students wishing to receive the ABET-accredited degree designated “Mechanical Engineering” must satisfy certain additional distribution requirements. These requirements apply to 10 units of study in the areas of mathematics, basic science, and engineering science and design as follows:

Requirements	Minimum Units
1. Mathematics and Basic Science (Notes 1, 2, 3).	4
2. Engineering Science and Design (includes MQP) (Notes 3, 4, 5, 6, 7, 8, 9).	6

NOTES:

- Must include a minimum of 5/3 units of mathematics, including differential and integral calculus and differential equations.
- Must include a minimum of 1/3 unit in chemistry and 2/3 unit in physics, or 1/3 unit in physics and 2/3 unit in chemistry.
- Must include an activity that involves basic matrix algebra and the solution of systems of linear equations, and an activity that involves data analysis and applied statistical methods.
- Must include 1/3 unit in each of the following: electrical engineering, materials science, and mechanical engineering experimentation.
- Must include at least one unit of ME courses at the 4000-level.
- May include 1000 level courses only if designated ES or ME.
- Must include two stems of coherent course and/or project offerings as noted below in a and b.
 - A minimum of one unit of work in thermofluid systems that includes the topics of thermodynamics, fluid mechanics and heat transfer, plus an activity that integrates thermofluid design.
 - A minimum of one unit of work in mechanical systems that includes the topics of statics, dynamics, and stress analysis, plus an activity that integrates mechanical design.
- Must include an activity which realizes (constructs) a device or system.
- Must include 1/3 unit of Capstone Design Experience. Items 3, 5, 7a integration, 7b integration, 8, 9 may all be “multiple-counted.”

Each Mechanical Engineering student must complete a Capstone Design experience requirement. This capstone design experience is partially or fully accomplished by completing a Major Qualifying Project which integrates the past course work and involves significant engineering design. At the time of registration for the MQP, the project advisor will determine whether the MQP will meet the Capstone Design requirement or not. If not, the advisor will identify an additional 1/3 unit of course work in the area of design (ME 4320, ME 4429, ME 4430, ME 4770, or ME 4810) to be taken in order to meet the ABET Capstone Design requirement.

FUNDAMENTALS IN THE MAJOR

The WPI philosophy of education emphasizes the development of competence in students’ abilities in self-learning. In the context of the flexible WPI degree requirements and the breadth of the mechanical engineering profession, it is not possible—or beneficial—to specify a rigid educational pattern. Rather, each student, with advice, should develop a program that best meets personal and professional goals.

It is clear that the profession of mechanical engineering rests on a deep understanding of the concepts of science and mathematics. The distribution requirements establish the minimum framework for meeting the student’s educational goals.

HUMANITIES/SOCIAL SCIENCES

It is difficult for mechanical engineers to design systems without being literate in the disciplines making up the social sciences, for the concerns of people and the flow of capital—economies—are central to technological development. The questions of values and mankind’s cultural experiences as exemplified in the humanities are critical to the study of modern technology. More and more engineering students recognize the need for literacy in the *humanities and social sciences*, and the Humanities and Arts Sufficiency and Social Sciences degree requirements are designed to meet this need. Mechanical engineering students are urged to work closely with their Sufficiency and Social Studies advisors as well as their academic advisor in the Mechanical Engineering Department to develop a program which meets their needs.

DISCIPLINARY LITERACY

In addition to disciplinary literacy, the process of design and problem solving is best met by multidisciplinary, problem-oriented experiences. At WPI, *projects and independent studies* are best suited to this educational experience. It may be difficult to generalize as to whether the student should develop literacy in a particular area by course or project experiences. *Courses* are sometimes the optimum mode in developing a disciplinary background, while *projects* are often effective in multidisciplinary, problem-centered studies. Mechanical engineering students should design programs that take full advantage of *both* of these learning modes.

The academic program of the student should be designed to provide for a continuous development in the scientific and engineering areas, including *analysis, design, and experimental studies*. Students are urged to take the Fundamentals of Engineering Examination, the first step toward becoming a registered professional engineer (P.E.), at the earliest opportunity.

MECHANICAL ENGINEERING DEPARTMENT CONCENTRATIONS

AEROSPACE ENGINEERING (GATSONIS)

Students are provided with ample opportunity to develop technical competence in low- and high-speed aerodynamics, propulsion systems, structures, and aerospace systems design. Experimental facilities available for course and projects in aerospace engineering include several wind tunnels, vacuum chambers, and controls instrumentation. Modern computational laboratories are also available.

Typical MQPs include: the design, construction, and testing of remotely piloted aircraft and micro aerial vehicles; aerodynamics; flow and structural control; gas dynamics; combustion; electric propulsion; micro-propulsion.

BIOMECHANICAL (HOFFMAN)

Students blend biology and biotechnology coursework with continuum mechanics, biomechanics, biofluids, and biomedical materials to support their individual interest. MQPs are usually developed jointly with off-campus medical facilities, including the University of Massachusetts Medical Center.

Typically MQP topics include: soft tissue mechanics, flow in constricted blood vessels, joint kinematics, prosthetic devices, sports biomechanics, biomaterials, tissue engineering and rehabilitation.

ENGINEERING MECHANICS (HOU)

Students select courses to develop the ability to construct models to analyze, predict, and test the performance of solid structures, fluids, and composite materials under various situations.

Typical MQP topics include: mechanical vibrations, stress and strain analysis, computer methods in engineering mechanics, finite element analysis, and vibration isolation. Departmental testing facilities and computer and software support are available.

Aerospace

2 Required

- ME 2713 Astronautics
- ME 3711 Subsonic Aerodynamics

Select 4

- ME 3410 Flow of Compressible Fluids
- ME 4712 Supersonic Aerodynamics
- ME 4713 Spacecraft Dynamics and Controls
- ME 4715 Aerospace Structures
- ME 4716 Air Breathing Propulsion
- ME 4717 Rocket and Spacecraft Propulsion
- ME 4724 High Speed Flow
- ME 4770 Aircraft Design
- ME 4771 Spacecraft and Mission Design

*Plus Aerospace MQP

Biomechanical

Two (2) Biology and Biotechnology (BB) Courses

Select 4

- ME 3501 Elementary Continuum Mechanics
- ME 3506 Rehabilitation Engineering
- ME 4504 Biomechanics
- ME 4606 Biofluids
- ME 4814 Biomedical Materials
- Any BME course at the 3000-level or higher

* Plus Biomechanical-related MQP

Engineering Mechanics

Select 6

- ME 3023 Mech. Behavior & Modeling Properties of Eng'g Mat'ls
- ME 3501 Elementary Continuum Mechanics
- ME 3506 Rehabilitation Engineering
- ME 3602 Intermediate Fluid Dynamics
- ME/BME 4504 Biomechanics
- ME 4505 Advanced Dynamics
- ME 4506 Mechanical Vibrations
- ME 4512 Introduction to the Finite Element Method

* Plus Engineering Mechanics MQP

MECHANICAL ENGINEERING DEPARTMENT CONCENTRATIONS

MECHANICAL DESIGN (NORTON)

Courses are available to support development of student interest in the design, analysis, and optimization of an assembly of components which produce a machine. Computer-based techniques are widely used in support of these activities.

Typical MQP topics are: optimum design of mechanical elements, stress analysis of machine components, evaluation and design of industrial machine components and systems, robotics, and computer-aided design and synthesis.

Mechanical Design

2 Required

- ME 3310 Kinematics of Mechanisms
- ME 3320 Design of Machine Elements

Select 4

- ES 1310 Engineering Design Graphics
- ES 3323 Introduction to CAD
- ME 2300 Introduction to Engineering Design
- ME 3311 Dynamics of Mechanisms and Machines
- ME 3321 Dynamic Modeling
- ME 3506 Rehabilitation Engineering
- ME 4320 Advanced Engineering Design
- ME 4322 Modeling and Analysis of Mechatronic Systems
- ME 4810 Automotive Materials and Process Design
- ME 4815 Industrial Robotics
- ME 4816 Materials Optimization for Engineers

* Plus Mechanical Design MQP

MANUFACTURING (R. D. SISSON)

Courses are available to support student interest in manufacturing engineering, computer-aided design, computer-aided manufacturing, robotics, vision systems, and a variety of manufacturing processes.

Typical MQPs include: robotics, composite materials, factory automation, materials processing, computer-controlled machining, surface metrology, fixturing, machine dynamics, grinding, precision engineering, prototype manufacturing.

See also the Manufacturing Engineering degree program.

Manufacturing

Select 2

- ME 1800 Materials Selection and Manufacturing Processes
- ME 2820 Materials Processing
- ME 3023 Mechanical Behavior and Modeling Properties of Engineering Materials

- ME 4810 Automotive Materials and Process Design
- ME 4821 Plastics

Select 2

- ES 3011 Control Engineering I
- ME 3820 Computer-Aided Manufacturing
- ME 4815 Industrial Robotics

Select 2

- OIE 2850 Engineering Economics
- OIE 3400 Production System Design
- OIE 3401 Production Planning and Control

* Plus Manufacturing MQP

MATERIALS SCIENCE AND ENGINEERING (SISSON)

Students interested in a strong materials science and engineering component can elect course and project activities in metals, ceramics, polymers, and composite materials with laboratory and project experience using facilities in Stoddard Laboratories.

Typical MQP topics include: X-ray diffraction, electron microscopy, computer modeling, mechanical testing and deformation mapping, plastic deformation, ceramic processing, friction, wear, corrosion, and materials processing.

Another option in the materials program is a Minor in Materials, which is described under Materials Engineering in this catalog.

Materials Science

Select 2

- ME 2820 Materials Processing
- ME 4810 Automotive Materials and Process Design

Select 2

- ME 3023 Mech. Behavior and Modeling Properties of Eng'g Mat'ls
- ME 4813 Ceramics
- ME 4814 Biomedical Materials
- ME 4821 Plastics
- ME 4832 Corrosion and Corrosion Control

Select 2

- ME 3801 Experimental Methods in Materials Science and Engineering
- ME 4840 Physical Metallurgy

Any 500-level MTE course

* Plus Materials Science MQP

MECHANICAL ENGINEERING DEPARTMENT CONCENTRATIONS

THERMAL-FLUID ENGINEERING (OLINGER)

Students study the theoretical and empirical bases of thermodynamics, heat transfer, mass transfer, and fluid flow, as well as the application of these fundamental engineering sciences to energy conversion, environmental control, and vehicular systems.

Typical MQPs include: biological fluid mechanics, laminar/turbulent separation, lifting bodies, heat pipes, electronic component cooling, power cycles, fluid component analysis and design, and energy storage.

Notes:

1. A Concentration area requires a 1 unit of MQP in that area.
2. After consultation with their academic advisor, students may petition the M.E. Dept. Curriculum Committee for approval of a Concentration plan at any time, preferably prior to the middle of their Junior Year.

Thermal-Fluids

Select 6

- ME 3410 Compressible Flow
- ME 3602 Intermediate Fluid Mechanics
- ME 3711 Subsonic Aerodynamics
- ME 4429 Thermodynamic Applications and Design
- ME 4606 Biofluids
- ME 4716 Airbreathing Propulsion
- ME 4724 High Speed Flow
- * Plus Thermal-Fluids MQP

AREAS IN WHICH COMPETENCE SHOULD BE DEVELOPED

The academic program of mechanical engineering students typically progresses from mathematics and basic science in the earliest years, through the engineering sciences, and then to analysis, design and experimentation. An operational capability in the use of computers must be acquired early in students' programs, as well as an overall skill in graphic, oral, and written communications. *Humanities and arts* and *social science* studies are essential in the program. When applicable, advanced placement from high schools will be given appropriate credit and noted on the WPI transcript.

MATHEMATICS AND BASIC SCIENCES

It is essential that mechanical engineering students establish a solid foundation in *mathematics*, the fundamental language of engineers. It is recommended that mechanical engineering students develop competence, as a minimum, in calculus and differential equations through such courses as: MA 1021, MA 1022, MA 1023, MA 1024, MA 2051. Additional courses are desirable and should be selected in consultation with the student's academic advisor as preparation for advanced-level course and project work.

An adequate background in the *basic sciences* is mandatory for mechanical engineering students and typically includes physics, chemistry, and other sciences. Programs should be planned so that topics related to mechanics, energy, heat, light, sound, optics, and electricity are covered in preparation for the material to be studied in the engineering sciences. Students, in consultation with their advisors, are urged to include in their programs courses from the following list which support their technical interest: PH 1110, PH 1120, PH 1130, CH 1010, CH 1020, CH 1030, BB 1001, BB 2002, GE 2341, GE 3050. Mathematics and basic sciences must include a minimum of four units, include both chemistry and physics with a minimum of two courses in either, and include differential and integral calculus and differential equations.

ENGINEERING SCIENCE AND DESIGN

For mechanical engineering students, the *engineering science and design* will normally require the equivalent of a year and a half of full-time study. In the engineering sciences, graphics; mechanics of solids, including stress analysis and dynamics; thermodynamics; fluid and continuum mechanics; materials science; and materials processing provide a background for the higher-level experiences. Students must also develop competence in closely-related engineering and science areas, such as electrical engineering, control engineering, computer science, and heat and mass transfer. A partial listing of engineering science courses of direct interest to the mechanical engineering student follows: ES 1310, ES 2001, ES 2501, ES 2503, ES 3001, ES 3003, ES 3004, ES 3011, ES 3323, ME 3501, ES 2502, ME 3502, ME 3505, ECE 2011, ECE 2022, ECE 3601, and ES 2011.

With mastery of the basic and engineering sciences, mechanical engineering students are in a strong position to utilize the tools of their profession for the gaining of new knowledge and the solution of significant real-world problems, often termed "design." Their MQP and IQP enable them to specialize in a given area of mechanical engineering in an interdisciplinary setting.

Engineering design is the decision-making experience of an engineer in which the combination of the basic sciences, engineering sciences and mathematics is applied, with judgment, to use resources economically to meet stated objectives. The development of literacy and skill in design may include the establishment of objectives, criteria, synthesis, analysis, construction, experimentation, evaluation, and communication. Students should consult their advisors in selecting appropriate courses, projects and independent studies to meet their design requirements. Programs include the equivalent of at least one-half year of a design experience and often involve courses such as ME 2300, ME 3310, ME 3311, ME 3320, ME 3321, ME 4320, and ES 3323 plus the Major and Interactive Qualifying Projects along with independent study. Advanced design courses are available if a student decides to do in-depth study in this area. A minimum of six units of

engineering science/design is required, and subdivided between engineering science and design on a 2:1 basis.

The one unit energy stem requirement is normally satisfied by taking courses such as ES 3001, ES 3003, and ES 3004. The one unit mechanical systems stem requirement is normally satisfied by taking courses such as ES 2501, ES 2502, and ES 2503.

Field trips and professional society activities are encouraged as they enhance overall professional perspectives.

MECHANICAL ENGINEERING DEPARTMENT CONCENTRATIONS

After developing competence in the basic engineering and science areas, mechanical engineering students are encouraged to select courses and projects in line with their personal and professional interests.

For those students having broad technical interests, and who wish to select wide-ranging upper-level courses (*see the Mechanical Engineering Program Chart*) and suitable MQP, early and continuing consultation with their academic advisors is encouraged to ensure that suitable preliminary work is completed on an appropriate schedule.

For those students that have an interest in pursuing upper-level activities within a narrow area of mechanical engineering, the Department offers seven specialty areas in which a "Concentration" may be earned. Each requires completion of six courses specified by that area, plus an MQP in that area. A brief description of each Concentration area, the name of a faculty member well versed in all phases of that area, and the particular course options and requirements are noted in the *Mechanical Engineering Concentrations chart*.

Students should note that they may utilize graduate courses if they are appropriate. The academic advisor must approve the course in advance. Integrated undergraduate-graduate programs are encouraged.

ENHANCED PROGRAMS

BS-MS PROGRAM IN MECHANICAL ENGINEERING

Outstanding students are encouraged to combine a master's degree with their undergraduate WPI studies. Details are found in the WPI GRADUATE PROGRAM section of this catalog, and interested students should initiate discussions with their advisor early in their junior year.

COOPERATIVE EDUCATION PROGRAM

The WPI Cooperative Education Program provides an opportunity to integrate "real-world" experience into an educational program. Details are found in the COOPERATIVE EDUCATION PROGRAM section on page 257.

MECHANICAL ENGINEERING MINOR (FOR NON-MAJORS)

Non-ME majors interested in developing a ME minor in conjunction with their major should consult with the Department Head or the lead faculty member in the specific ME sub-area of interest to define a program leading to recognition of the minor. Each individual student minor must then be approved by the Committee on Academic Operations.

MILITARY SCIENCE

MAJ N. A. GAUTHIER, HEAD

PROFESSORS: MAJ B. Crouse, MSG J. Veals, Jr., SFC P. B. Riddick

ASSISTANT PROFESSORS: MAJ F. Pagaduan, CPT T. Painter

INTRODUCTION

The Army Reserve Officer Training Corps (ROTC) is offered by WPI and is available to all male and female students within the Worcester Consortium. Physically qualified American citizens who complete the entire four-year program, concurrent with baccalaureate degree completion, may be commissioned in the United States Army, Army Reserve or Army National Guard. Emphasis throughout is on the development of individual leadership abilities and preparation of the student for a lifetime of service to the nation. The Military Science Department offers several concurrent programs designed to complement the WPI Plan. There are two variations of ROTC available to students who desire to participate:

The four-year program is an on-campus program during which students participate in required Military Science courses and activities. Students attend a five-week Leadership Development and Assessment Course (LDAC) (with pay) between the third and fourth year for practical application of classroom instruction.

The two-year ROTC program begins with a four-week Leader Training Course (with pay). Upon successful completion of LTC, the student enters the third year of ROTC and will attend LDAC during the following summer. If a student completed Basic and Advanced Individual Training with the U.S. Army, he/she can qualify for the two-year ROTC program.

All Military Science courses are open to any interested student without incurring any military obligation. Military Science courses are an excellent medium for personal enrichment and development of leadership abilities.

BASIC COURSE

The Basic Course includes classroom instruction and practical application opportunities which introduce the student to the Army and the Army to the student. Since all effective leaders must understand the organization in which they will function, initial instruction is intended to create a working knowledge of the Army. Subsequent instruction deals with the study of military leadership, management and technical proficiency.

ADVANCED COURSE

The Advanced Course includes classroom instruction and practical application opportunities taught during the third and fourth years. The objective is to develop leaders; to give the cadet experience in first organizing, then managing a project; to enable the cadet to take charge of any project and to bring it to a successful conclusion. This acquired ability is useful in every human endeavor; it is essential to the military leader. In conjunction with the theoretical approach to leadership studied in class, students are required to apply their knowledge during Leadership Laboratories. The Advanced Course is open to all

MILITARY SCIENCE COURSE FLOW CHART

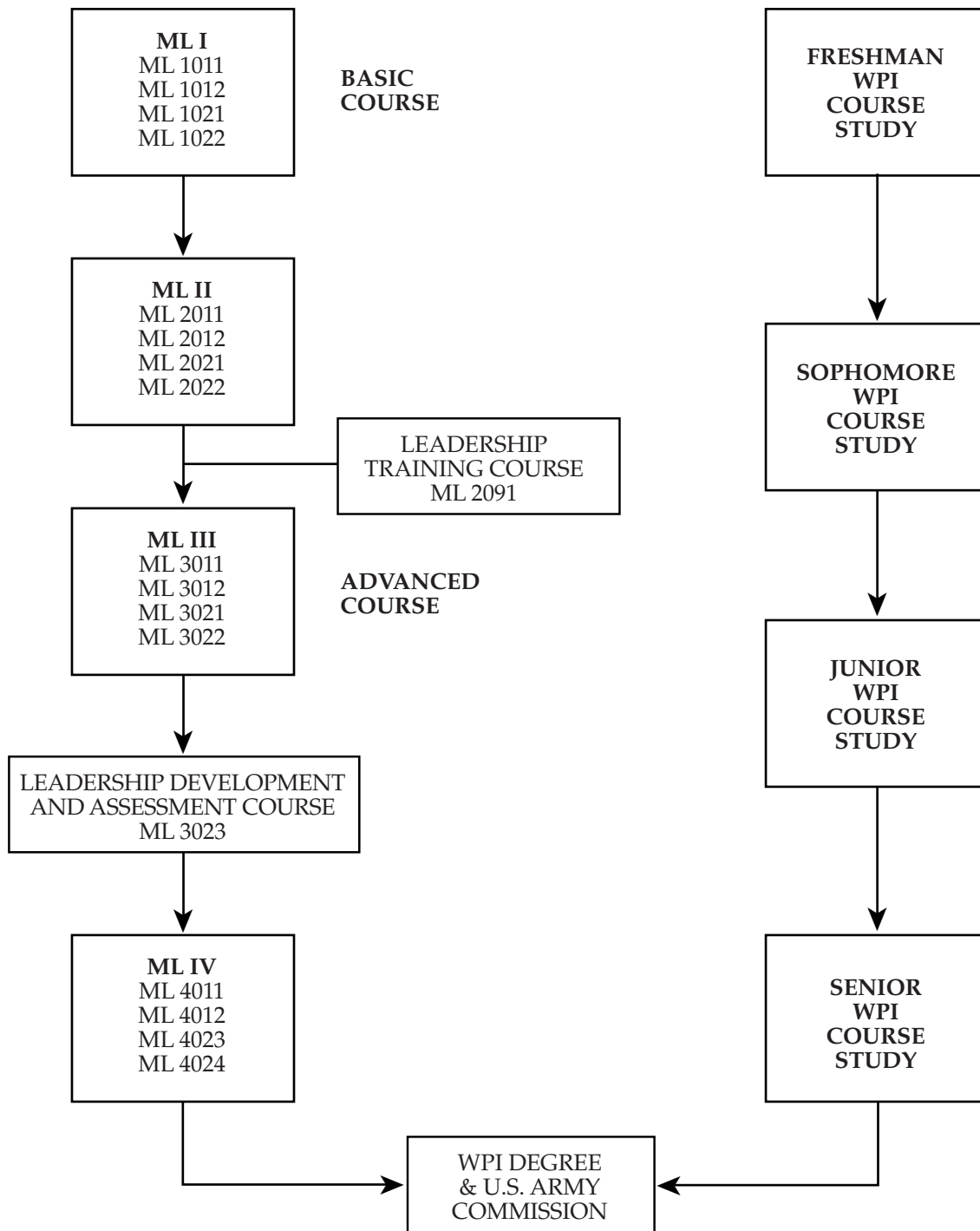

- (1) Required for 2 year ROTC program students.
- (2) Additional requirements: Professional Military Education.
Five Undergraduate Courses.
Leadership Laboratories, weekly.
Physical Training, weekly.
Weekend Field Training Exercise (2 each year).
Social Events.
- (3) Required attendance for all Juniors and Seniors.

students who have satisfactorily completed two years in the basic course or the equivalent.

Juniors enrolled in the advanced course receive a tax-free subsistence allowance of \$350 each month; seniors receive \$400 monthly. Pay during LDAC, is as set by Congressional legislation. To enroll in the Advanced Course, students must execute a contract stating they will continue the course of instruction for two years and accept the commission of Second Lieutenant in the United States Army, Army Reserve or Army National Guard upon graduation.

PROFESSIONAL MILITARY EDUCATION

The required professional military education component encompasses the full four years of study. It consists of two essential parts:

1. Completion of a baccalaureate degree;
2. Undergraduate certification in the areas of written communications, military history, and computer literacy.

LEADERSHIP LABORATORY

Leadership Laboratory consists of a monthly four-hour practical exercise in leadership or military skills. It is an integral part of the annual ROTC program. The purpose of Leadership Laboratory is to give each cadet the opportunity to apply practically the theory learned during formal class periods. The senior cadets conduct the laboratory period with underclass students filling subordinate roles; level of responsibility depends upon how far they have advanced in ROTC.

The Military Science Department encourages its cadets to participate in athletics and to join other extracurricular activities in order to practice leadership theories learned in military science.

PHYSICAL EDUCATION

D. L. HARMON, HEAD

ASSOCIATE PROFESSOR: P. J. Grebinar

INSTRUCTORS: C. Bartley, P. Bennett, S. Carver, M. DeSavage, J. DiCarlo, C. Galasso, P. Hickey, G. Lefort, E. Lorion, L. Noble, C. Robertson, G. Snoddy, J. Steele, E. Zaloom

REQUIREMENTS

Qualification in physical education shall be established by completing 1/3 unit of course work. *Students are urged to complete this requirement in their first two years of residency at WPI.* In addition to general PE course offerings, students may satisfy their PE requirement in the PE 1100-series courses noted below:

1. WPI approved varsity athletic team participation. Student must be **registered in advance of participation.**
2. Club Sports. Students must be members of a PE approved club prior to becoming eligible for physical education credit. Students must be **registered in advance of participation.**
3. Approved courses not offered at WPI; **advance approval** by the Physical Education Department is necessary.
4. Individualized program at WPI; **advance approval** by the Physical Education Department is necessary.

Students who wish to obtain PE credit by the above means must be enrolled in a course in the PE 1100 series.

Participation in certain ROTC programs may entitle students to a receive PE credit.

ATHLETIC PROGRAMS

THE INTERCOLLEGIATE PROGRAM

The intercollegiate athletics program offers competition in 20 varsity sports.

All full-time members of the physical education faculty and staff are involved in coaching, with assistance from other faculty members and part-time coaches from the community who have special skills in athletics.

WPI has excellent facilities and provides the best in protective equipment but, if an injury should occur, a team physician and full-time trainers are available, offering the latest treatment methods and facilities.

Practices are normally held daily, after 4 pm. Midweek contests involving travel are held to a minimum to avoid missing classes. Every effort is made to avoid conflicts with academic activities, and competitions are generally scheduled with schools with similar standards and objectives.

In recent years, teams and individuals have been sent to regional and national tournaments to allow them to compete at the highest possible level. All-America recognition has been attained recently in football, men's soccer, track and field, and wrestling.

The athletic program forms an important point of contact with other universities and colleges in the East and is an opportunity for our students to compete against conference and independent institutions.

Varsity Sports

Baseball	Soccer (men)
Basketball (men)	Soccer (women)
Basketball (women)	Softball
Crew (men)	Swimming & Diving (men)
Crew (women)	Swimming & Diving (women)
Cross Country (men)	Track (men) - Indoor/Outdoor
Cross Country (women)	Track (women) - Indoor/Outdoor
Field Hockey	Volleyball (women)
Football	Wrestling

THE CLUB SPORTS PROGRAM

The Club Sports Program offers a variety of competitive activities for student participation. Some of the current Club Sports include:

Club Sports

Alpine Skiing	Martial Arts (SOMA)
Cheerleaders	Rugby
Soccer	Sailing
Fencing	Scuba
Free Style Wrestling	Tennis
Golf	Ultimate Frisbee
Ice Hockey	Volleyball (men)
Lacrosse	Water Polo

Club Sports, Class II, are administered through the Department of Physical Education and Athletics and details regarding the activities listed above are available through the Coordinator of Club Sports in Alumni Gymnasium.

THE INTRAMURAL PROGRAM

The Intramural Program is designed as an opportunity for students to enjoy the benefits of recreation and athletic competition even though they may not have the time, talent or desire to compete on the higher intercollegiate level.

Entries are welcome not only from fraternities, sororities and other residential units but also from a variety of independent student groups and individuals, including faculty and staff. Approximately 50% of the student body participate in intramurals.

The program includes flag football, floor hockey, racquetball, volleyball, basketball, swimming, soccer, water polo, softball, bowling, and table tennis. The program is ever-expanding, and activities are added as needs arise and time and facilities permit.

The program is administered by the Department of Physical Education and Athletics, and all details regarding scheduling and eligibility are available on the department website.

PHYSICS

J. W. NORBURY, HEAD

PROFESSORS: P. K. Aravind, S. N. Jasperson,
T. H. Keil, J. W. Norbury, G. D. J. Phillies,
L. R. Ram-Mohan, A. A. Zozulya

ASSOCIATE PROFESSORS: N. A. Burnham,
G. S. Iannacchione, R. S. Quimby

ASSISTANT PROFESSORS: R. Garcia, C. A. Koleci

RESEARCH PROFESSOR: D. F. Nelson

MISSION STATEMENT

The Physics Department provides education in physics to both undergraduate and graduate students and contributes to the growth of human knowledge through scholarly work.

OBJECTIVES

The physics department educates students with a program characterized by curricular flexibility, student project work, and active involvement of students in their learning. Through a balanced, integrated curriculum stressing the widely applicable skills and knowledge of physics, we provide an education that is strong both in fundamentals and in applied knowledge, appropriate for immediate use in a variety of fields as well as graduate study and lifelong learning.

EDUCATIONAL OUTCOMES

We expect that physics graduates:

1. Know, understand, and use a broad range of basic physical principles.
2. Have an understanding of appropriate mathematical methods, and an ability to apply them to physics.
3. Have demonstrated oral and written communications skills.
4. Understand options for careers and further education, and have the necessary educational preparation to pursue those options.
5. Have an ability to learn independently.
6. Have acquired the broad education envisioned by the WPI Plan.

7. Are prepared for entry level careers in a variety of fields, and are aware of the technical, professional, and ethical components.
8. Are prepared for graduate study in physics and/or other fields.
9. Can find, read, and critically evaluate selected original scientific literature.

INTRODUCTION

Ask a physicist what physics has to do with, and you are likely to be told: "Everything!" Though oversimplified, this answer does contain a kernel of truth. In their study of nature, physicists concern themselves with interactions involving matter and energy of every form.

Physicists' interests range from the tiny world of subatomic particles to stars, galaxies and the vast cosmic sea of space and time in which they travel. They have developed intricate tools to assist the human senses in probing these remote extremes of our natural environment. They have distilled their understanding of nature into laws of great generality and elegance, from the mathematical patterns needed to interpret the perfect symmetry and the regularity of atoms and crystals, to the powerful mathematical treatment of chaos and disorder needed to deal with the concept of heat.

Of course, not all physicists work at the very limits of our knowledge of nature. Many use their understanding of physics to develop practical applications that solve more familiar human problems. The pioneering work on semiconductors in the 1940s led to the development of computers, transistor radios and a communication network that is bringing the peoples of the world ever closer together. The laser, invented in the 1960s, has been used in such varied applications as eye surgery and radar, and even in computerized cash registers. The list of problems solved is long; the list of future possibilities is endless. So there is some truth in the statement that "physics has to do with everything."

One of the distinguishing characteristics of the physicist's approach is a cyclical growth pattern. Systematic experiments provide new facts. New theory is developed to summarize these facts and make them manageable. The new theory has as its consequences practical applications and new questions, leading to new experimentation. Along the way, physicists are guided by certain fundamental principles such as symmetry, continuity and conservation laws.

Students come to the study of physics from many backgrounds and for many reasons. Two aspects in particular seem to attract them. The first is the opportunity to choose from a wide range of intriguing subjects of study, both theoretical and experimental, both fundamental and applied. The second is the combination of intuitive ideas and the penetrating style of logical and mathematical problem-solving which students come to realize physics "has to do with."

CAREER OPPORTUNITIES IN PHYSICS

Undergraduate physics programs were once formulated with the expectation that graduating students would enter postgraduate programs, where they would earn an advanced degree under the guidance of a practicing physicist. The long-term career objective was assumed to be a permanent position in an academic physics depart-

ment, with interests divided between scientific research and teaching. Although this traditional outlook is still valid for many students entering the study of physics today, the unprecedented worldwide growth of science-based industries has led to exciting new career opportunities involving pure physics mixed with engineering and applied science. Many technically oriented students have also a deep interests in pure science; they are attracted to applied physics because it allows them to satisfy their scientific curiosity while at the same time pursuing the practical objectives of an engineer. In recognition of this new career choice the physics department offers a degree in engineering physics in addition to the traditional physics program. As shown in the sample programs below, students for this degree have great freedom to shape their program to match their individual interests.

AREAS OF FACULTY INTEREST

(PROJECT AND INDEPENDENT STUDIES)

P. Aravind	Quantum optics, quantum mechanics, group theory.
N. Burnham	Atomic force microscopy, nanomechanics
R. Garcia	Condensed matter
G. Iannacchione	Calorimetry, liquid crystals
S. Jaspersen	Optical properties of solids, optical instruments.
T. Keil	Solid state physics, mathematical physics, fluid mechanics.
C. Koleci	Physics education research.
D. Nelson	Optical and transport properties, solid state physics, lattice dynamics.
J. Norbury	Theoretical Nuclear and Particle Physics
G. Phillis	Light scattering spectroscopy, complex fluids, biochemical physics.
R. Quimby	Optical properties of solids, laser spectroscopy.
L. Ram-Mohan	Field theory, many body problems, solid state physics, linear and non-linear optical properties of semiconductors, computational physics.
A. Zozulya	Non-linear optics, photo-refractive materials

Program Distribution Requirements for the Physics and Engineering Physics Majors

The normal period of residency at WPI is 16 terms. In addition to the WPI requirements applicable to all students (see page 21), completion of a minimum of 10 units of study is required in the areas of mathematics, physics, and related fields as follows:

PHYSICS

Requirements	Minimum Units
1. Mathematics (Note 1).	3
2. Physics (including the MQP) (Notes 2, 3).	5
3. Other subjects to be selected from mathematics, science, engineering, computer science, and management (Note 3).	2

NOTES:

1. Mathematics must include at least 2/3 unit of mathematics at the level of MA 3000 or higher.
2. ES 3001 and CH 3510 count as physics courses.
3. Either item 2 or 3 must include at least 1/3 unit from each of the five principal areas of physics: mechanics, experimental physics, electromagnetism, quantum mechanics, and thermal and statistical physics. This core distribution requirement is satisfied by successfully completing at least one course from each of the following five sets of courses: PH 2201 or 2202 (mechanics);

PH 2651 or 2601 (experimental physics); PH 2301 or 3301 (electromagnetism); PH 3401 or 3402 (quantum mechanics); ES 3001, CH 3510, or PH 4206 (thermal and statistical physics); or other courses approved by the department Program Review Committee following petition by the student.

ENGINEERING PHYSICS

1. Same requirements as PHYSICS, with the addition that the 10 units must include 2 units of coordinated engineering and other technical/scientific activities. The 2-unit program must be formulated prior to final year of study by the student in consultation with the academic advisor, and must be certified prior to the final year by the departmental Program Review Committee.

Curriculum Outline — Physics and Engineering-Physics

The programs of study described below are designed to fulfill the needs and interests of students over the range from “pure” to “applied,” or “engineering” science. They are designed to provide, first of all, a foundation in the indispensable principles and techniques of classical and modern physics. Such preparation is necessary and appropriate for any future in science and technology, including that of post-graduate study and research. Moreover, insofar as appropriate within an undergraduate curriculum, programs are offered which allow options of special experience in some of the active areas of applied or engineering physics.

All programs include a common group of recommended core courses which provide the foundation, beginning with the great themes of physics—matter, motion, forces, energy, and the nature and concepts of electricity and magnetism. They build on that basic knowledge and perspective together with progressively more sophisticated mathematical techniques. Beyond this essential core, a student may choose either a more traditional program of physics study or one relating to an area of individual interest with engineering applications. Illustrations of these options are outlined in the section below, “Physics and Engineering-Physics Programs.”

Guidance in the planning of students’ programs will be provided by academic advisors. A departmental engineering-physics coordinator is also available for consultation by students and academic advisors on questions pertaining to curriculum and project matters.

In addition to the courses, the Major Qualifying Project (MQP) has the potential to provide valuable experience and to broaden students’ perspectives in the chosen subject area—this is one of the exceptional opportunities uniquely associated with the WPI Plan. In the case of students concentrating in one of the engineering-physics fields, the project topic would be chosen for its relevance to that area of interest. Additional information about the MQP is presented in the section on page 172, “Project Opportunities in Physics and Engineering-Physics.”

Students who feel that their interests and objectives do not fit naturally into any of the illustrative programs presented here are invited to consult with their academic advisors and with representatives of the Physics Department. It is usually possible to adapt a program to their individual needs.

PHYSICS AND ENGINEERING-PHYSICS PROGRAMS

For a student entering the study of physics, there is a natural progression of subjects which provide a foundation for advanced work within physics and engineering-physics programs. This constitutes a core sequence which embodies the following indispensable basic areas of study: classical mechanics, electromagnetism, a survey of modern physics, statistical and quantum physics, and laboratory experimental methods. Because the language of the exact sciences is mathematics, there is a parallel core sequence of mathematics courses normally taken either as preparation for or concurrently with the physics courses with which they are paired in the list presented below. In the following table \rightarrow indicates that the mathematics course is strongly recommended; \leftrightarrow indicates that concurrent study is acceptable.

MA 1021 Calculus I	\leftrightarrow	PH 1110 Mechanics
MA 1022 Calculus II	\leftrightarrow	PH 1120 Electricity and Magnetism
MA 1023 Calculus III	\leftrightarrow	PH 1111 Mechanics
MA 1024 Calculus IV	\leftrightarrow	PH 1121 Electricity and Magnetism
MA 1023 Calculus III	\leftrightarrow	PH 1130 Introduction to 20th Century Physics
MA 1024 Calculus IV	\leftrightarrow	PH 1140 Oscillations and Waves
MA 2051 Differential Equations	\leftrightarrow	PH 2202 Intermediate Mechanics II
MA 2071 Linear Algebra		PH 2651 Physics Laboratory
MA 2251 Vector/Tensor Calculus	\rightarrow	PH 2301 Electromagnetic Fields I
MA 4451 Boundary Value Problems	\leftrightarrow	PH 3301 Electromagnetic Theory
	\rightarrow	PH 3401 Quantum Mechanics I
		PH 4206 Statistical Physics
(PH 1110, PH 1120)	} Students needing a somewhat more gradual introduction and an opportunity to gain mathematical skills concurrently are advised to substitute these courses for PH 1111 and PH 1121.	

Physics and engineering-physics students should also reserve part of their undergraduate experience for developing perspective in a range of other science and engineering disciplines. A few of the many possibilities are illustrated by the following examples.

- Chemistry (CH 1010, 1030); Material Science (ES 2001). Choosing appropriate materials is often crucial in the development of new experimental techniques that can further our knowledge of physical phenomena. Conversely, the studies of physicists have had profound effects on the development of new materials.
- Electronics, both analog (ECE 2201 and 3204, and digital (ECE 2022). Electronics pervades the modern laboratory. It is valuable to learn electronic principles and designs as they are applied in modern "on-line" experimental data collection and data reduction systems.
- Computer science (CS 1005 and CS 2005). Physics students will need to make skillful use of computers in present and future experimental data processing, theoretical analyses, and the storing, retrieving and displaying of scientific information.

- Engineering courses related to science. Some basic knowledge in areas such as heat transfer, control systems, fluid mechanics, stress analysis and similar topics will prove to be of great benefit to the physicist called upon to apply professional knowledge to practical engineering problems.

Building on this core and topical subject coverage, physics students are in a position to turn in any number of directions within the range of physics studies, depending on individual interests and career objectives. Six illustrative examples are outlined below. In each case the outline includes a list of recommended and related courses followed by a sampling of project opportunities in the respective areas. Selection of specific courses and projects should be determined by students' interests and the guidance of their academic advisors and the engineering-physics coordinator. For courses outside of the physics department, students are advised to discuss the prerequisites with the instructor.

1. Physics

Recommended Courses

PH 3402	Quantum Mechanics II
PH 4201	Advanced Classical Mechanics
PH (IS/P)	Selected Readings in Physics

Related Courses

ECE 2311	Continuous-Time Signal and System Analysis
ECE 2312	Discrete-Time Signal and System Analysis
ECE 3801	Advanced Logic Design
ECE 3901	Semiconductor Devices
ES 3011	Control Engineering I
PH 2510	Atomic Force Microscopy
PH 3501	Relativity
PH 3502	Solid State Physics
PH 3503	Nuclear Physics
PH 3504	Optics
PH (IS/P)	Modern Optics
PH 501 (Graduate)	Mathematical Methods of Physics I
PH 511 (Graduate)	Classical Mechanics
MA 4291	Applicable Complex Variables

2. Computational Physics.

Recommended Courses

MA 3257	Numerical Methods for Linear and Non-Linear Systems
MA 4411	Numerical Solutions of Differential Equations
PH (IS/P)	Numerical Techniques in Physics

Related Courses

PH 3402	Quantum Mechanics II
PH 3502	Solid State Physics
PH 501/2	(Graduate) Mathematical Physics
MA 3457/CS4033	Numerical Methods for Calculus and Differential Equations
MA 4291	Applicable Complex Variables
CS 1101	Introduction to Program Design
CS 2011	Introduction to Computer Organization and Assembly Language
CS 2301	Systems Programming for Non-Majors
CS 4731	Computer Graphics
ECE 2311	Continuous-Time Signal and System Analysis
ECE 2312	Discrete-Time Signal and System Analysis
ECE 3801	Advanced Logic Design
ES 3011	Control Engineering I

3. Optics

Recommended Courses

PH 3504	Optics
PH 2501	Photonics
PH 2502	Lasers

Related Courses

PH 3402	Quantum Mechanics II
PH 3502	Solid State Physics
PH 542/3	(Graduate) Modern Optics I and II
MA 4291	Applicable Complex Variables
AR/ID 3150	Light, Vision, and Understanding
ECE 2311	Continuous-Time Signal and System Analysis
ECE 2312	Discrete-Time Signal and System Analysis
ES 3011	Control Engineering I

4. Electromagnetism*Recommended Courses*

PH (IS/P)	Modern Optics
PH (IS/P)	Selected Readings in Electromagnetism

Related Courses

PH 3402	Quantum Mechanics II
PH 3502	Solid State Physics
PH 3503	Nuclear Physics
PH 3504	Optics
PH 533	(Graduate) Electromagnetic Theory
PH 514/5	(Graduate) Quantum Mechanics
MA 4291	Applicable Complex Variables
ECE 2311	Continuous-Time Signal and System Analysis
ECE 2312	Discrete-Time Signal and System Analysis
ES 3011	Control Engineering I

5. Nuclear Science And Engineering*Recommended Courses*

ES 2011	Introduction to Nuclear Technology
PH 3503	Nuclear Physics

Related Courses

PH 3402	Quantum Mechanics II
PH 3501	Relativity
PH 553	(Graduate) Nuclear Physics
ME 4832	Corrosion and Corrosion Control
ECE 3801	Advanced Logic Design
ES 3011	Control Engineering I

6. Thermal Physics*Recommended Courses*

ES 3001	The Statistical Development of Classical Thermodynamics
ES 3004	Fluid Mechanics
PH (IS/P)	Selected Readings in Thermal Physics

Related Courses

ES 3003	Heat Transfer
ES 3011	Control Engineering I
ME 3410	Compressible Flow
PH 3502	Solid State Physics
PH 3504	Optics
ME 4429	Thermodynamic Applications and Design
ME 4602	Intermediate Fluid Dynamics
PH 501/2	(Graduate) Mathematical Physics

Project Opportunities in Physics and Engineering-Physics

Opportunities for physics students to participate in theoretical, computer-aided or experimental research exist in numerous fields, including nuclear and particle physics, modern and classical optics, statistical and solid-state physics, electromagnetism, astrophysics, field theories, and in the great range of subfields within these categories.

In the engineering-physics programs, the MQP subject is generally chosen for its relevance to the particular area of concentration. Students usually obtain the assistance of their academic advisors and of the engineering-physics coordinator in arranging the project. It may also include the participation of a project coadvisor who is a member of the engineering faculty.

Information for the selection of a Major Qualifying Project (MQP) by physics and engineering-physics students can be obtained from physics faculty members at any time during the academic year, and especially during the Term C project planning period. A project resource booklet, available in the department office, provides MQP subject information, identification of participating faculty and their areas of interest, and data relating to past projects. Physics faculty serve as project advisors on MQPs in their own fields of research, and sometimes in other appropriate scientific areas of mutual student-advisor interest.

For all physics and engineering-physics students, there are opportunities for off-campus projects in industries, hospitals, research institutions, government and other resources in the Worcester vicinity and beyond. Information on these possibilities, which are constantly changing and expanding, is managed and made available to students and faculty on the Projects Program web site.

PHYSICS FOR NONPHYSICS MAJORS

Physics is the scientific underpinning for all engineering work and is therefore considered by prospective engineers, almost without exception, to be a subject which merits serious study. The elementary physics sequence at WPI encompasses the subject areas of classical mechanics (PH 1110/PH 1111), electricity and magnetism (PH 1120/PH 1121), 20th century physics (PH 1130), and oscillation and wave phenomena (PH 1140). The sequence is designed to be taken either in the pattern PH 1110, 1120, 1130, 1140, or PH 1111, 1121, 1130, 1140, although other orderings are possible, depending on special circumstances.

The first two courses in this sequence are offered in two versions because of the diversity of backgrounds and preparation of entering students. PH 1111 and PH 1121 are aimed primarily at freshmen with a solid background in the sciences and in mathematics, including calculus. In particular, students in PH 1111 and PH 1121 should be able to differentiate and integrate elementary trigonometric and polynomial functions, and to interpret these operations in graphical form. PH 1110 and PH 1120 are taught at a mathematically less demanding level and are designed for students concurrently beginning their study of calculus, having had little or no college-level calculus preparation in high school.

The courses in classical mechanics and electricity and magnetism are regarded as essential preparation for many fundamental engineering courses as well as for further work in physics. PH 1130 gives a first introduction to 20th century physics: the theory of relativity, quantum physics, nuclear physics and elementary particles. It is designed to provide a context for the appreciation of present-day advances in physics and high-technology applications. PH 1140 deals in depth with oscillations and waves. Engineering applications of this subject reach all the way from LC circuits and electromagnetic wave propagation in electrical engineering to the vibrations of large scale structures such as machinery and highway bridges in mechanical engineering and civil engineering.

There are several intermediate physics courses that may be of interest to nonphysics majors. PH 2201-2202 give a physicist's view of mechanics which to mechanical engineering majors may be an interesting and useful complement to the engineering courses in statics and dynamics. The physics courses in quantum mechanics, PH 3401-3402, and solid state physics, PH 3502, may be of great interest to electrical engineering students specializing in solid state electronics. The courses in electromagnetic field theory, PH 2301 and PH 3301, and optics, PH 3504, would provide a valuable background for students in many areas, such as modern communication systems, fiber optics and optical computing. These are just examples; other courses are also available. For specific information on individual courses, students may consult with the course instructor or with the Physics Department head.

PHYSICS MINOR

The Physics Minor offers non-Physics majors the opportunity to broaden their understanding of both the principles of physics and the application of those principles to modern day engineering problems. In these times of rapid technological change, knowledge of fundamental principles is a key to adaptability in a changing workforce.

Two units of coordinated physics activity are required for the Physics Minor, as follows (note that, in accordance with Institute policy, no more than 3/3 of these units may be double-counted toward other degree requirements):

1. Any or all of the following four introductory courses:

- PH 1110 or PH 1111
- PH 1120 or PH 1121
- PH 1130
- PH 1140

2. At least 2/3 unit of upper level physics courses (2000 level or higher), which may include IS/P courses or independent studies approved by the program review committee. Examples of courses of this type which might be selected are (but are not limited to):

- PH 2201 Intermediate Mechanics I
- PH 2301 Electromagnetic Fields
- PH 2651 Physics Laboratory
- PH 3401 Quantum Mechanics I
- PH 3504 Optics
- PH 2501 Photonics
- IS/P Quantum Engineering

Students who have taken the four course introductory sequence should have an adequate physics background for these courses; see, however, the individual course descriptions for the expected mathematical background. Other physics courses may be selected for the physics minor, but the recommended background for such courses often includes one or more of the courses listed above.

3. Capstone Experience

The capstone experience for the physics minor can be satisfied either by an independent study arranged for this purpose, or by one of the upper level courses. If the second option is chosen, the student must discuss this with the instructor prior to the start of the course. In either case, documentation of the capstone experience will consist of a paper, prepared in consultation with the instructor or in-

dependent study advisor, which incorporates and ties together concepts learned in the physics courses selected.

For more information, or assistance in selecting a minor advisor or an independent study advisor, see the Head of the Physics Department in Olin Hall 119.

Majors in Physics or Engineering Physics do not qualify for a Minor in Physics.

PRE-LAW PROGRAMS

ADVISORS: G. HEATON, K. RISSMILLER

Law schools do not require that undergraduates complete any particular course of study. Thus, students who complete degrees in engineering and science may wish to consider careers in law. Undergraduates interested in attending law school are encouraged to choose from among the many courses offered which explore legal topics. For those with greater interest, WPI offers a Minor in Law and Technology described on page 136. Courses with substantial legal content are listed among those courses fulfilling the requirements of the minor.

Enrolling in these courses will introduce students to the fundamentals of legal process and legal analysis. Students will study statutes, regulations and case law. These courses will, therefore, offer the student valuable exposure to the kind of material commonly studied in law schools and they may help demonstrate a student's interest to law school admission committees. IQPs in Division 52, Law and Technology, or other projects that involve library research and extensive writing may also be helpful.

A pre-law advising program in the Social Science Department maintains information on careers in law, law schools, and the law school admission test (LSAT), which is universally required. Students may examine this material independently or make an appointment. Students with an interest in law are also encouraged to join the Pre-Law Society. To do so, contact Professor Rissmiller.

PRE-MBA PROGRAM (DUAL DEGREE)

ADVISOR: N. WILKINSON

FIVE-YEAR DUAL DEGREE BS/MBA PROGRAM

The combination of a technical undergraduate degree and a graduate degree in business has been cited by many experts as the ideal educational preparation for a career in private industry. For that reason, the Department of Management offers the opportunity for obtaining dual degrees (i.e., the B.S. degree in engineering or science and the Master of Business Administration, MBA). The dual-degree program can be completed within five years, however, the program is demanding, and curriculum planning with the student's advisor and the Department of Management should start by the beginning of the student's third year at WPI at the very latest.

Only registered WPI undergraduates majoring in an engineering (excluding Management Engineering) or science area may enter the Dual-Degree B.S./MBA Pro-

gram. A separate and complete application to the MBA program must be submitted. Admission to the Dual-Degree B.S./MBA Program is determined by the faculty of the Department of Management. The student should begin the curriculum planning process as early as possible in his/her undergraduate program, but no later than the beginning of the third year, to ensure that all of the required undergraduate courses are completed within the student's four years of undergraduate study. It is recommended that the MBA application be submitted no later than the beginning of the student's Third Year of undergraduate study. A student in the Dual-Degree B.S./MBA Program continues to be registered as an undergraduate until the bachelor's degree is awarded.

Students wishing to do a combined B.S./MBA must complete the following courses while an undergraduate:

ACC 1100	<i>Financial Accounting</i>
FIN 2200	<i>Financial Management</i>
OBC 2300	<i>Organizational Science</i>
MA 2611	<i>Applied Statistics I</i>
MA 2612	<i>Applied Statistics II</i>
OIE 3400	<i>Production System Design</i>
MKT 3600	<i>Marketing Management</i>
MIS 3700	<i>Information Systems Management</i>
ECON 1110	<i>Introductory Microeconomics</i>
ECON 1120	<i>Introductory Macroeconomics</i>

To obtain a bachelor's degree via the Dual-Degree B.S./MBA Program, the student must satisfy all requirements for the bachelor's degree, including distribution and project requirements.

To obtain an MBA via the Dual-Degree B.S./MBA Program, the student must satisfy all MBA degree requirements. In addition to the prerequisite undergraduate courses listed above, the student must complete the following graduate courses:

OBC 511	<i>Interpersonal and Leadership Skills for Technological Managers</i>
MKT 512	<i>Creating and Implementing Strategy for Technological Organizations</i>
OIE 513	<i>Creating Processes in Technological Organizations</i>
ACC 514	<i>Business Analysis for Technological Managers</i>
BUS 515	<i>Legal and Ethical Context of Technological Organizations</i>
BUS 516	<i>Graduate Qualifying Project (GQP)</i>
12 Elective Credits	

A student in the Dual-Degree B.S./MBA Program may, with prior approval, apply the equivalent of a maximum of 12 graduate credits from the same courses toward both the bachelor's and MBA degrees. Students in the Dual-Degree B.S./MBA Program may not take graduate-level management courses prior to their Fourth Year of undergraduate study, and then only provided the corresponding prerequisites have been satisfied. Students in the Dual-Degree B.S./MBA Program may use advanced undergraduate major or elective courses (generally classified as 4000-level courses) to satisfy graduate degree elective requirements. The Department of Management decides which courses may be used in this way. Faculty members teaching these advanced undergraduate courses may impose special requirements, appropriate to an undergradu-

ate course being used for graduate credit, on Dual-Degree B.S./MBA Program students.

The Department of Management may make other requirements as it deems appropriate in any individual case. These requirements take the form of a written agreement between the student and the Department of Management, and must be filed with the registrar before the student may be matriculated in the Dual-Degree B.S./MBA Program.

The Dual-Degree B.S./MBA Program is a full-time program of study. Once admitted to the Dual-Degree B.S./MBA Program, a student must register every fall and spring semester until the MBA is completed. A student in the Dual-Degree B.S./MBA Program who has no registered activities during a given fall or spring semester is automatically terminated from the Dual-Degree B.S./MBA Program, and may only be readmitted to the Dual-Degree B.S./MBA Program by the Department of Management's Graduate Policy and Curriculum Committee and the Committee for Graduate Studies and Research via petition showing extenuating circumstances. Termination from the Dual-Degree B.S./MBA Program does not affect a student's ability to continue toward the bachelor's degree.

PRE-MEDICAL, PRE-DENTAL AND PRE-VETERINARY PROGRAMS

ADVISOR: J. RULFS

Students at WPI who wish to pursue careers in the medical professions should, in consultation with their academic advisors, plan their academic programs to include courses in biology, general and organic chemistry, and physics including laboratory experiences. Entry into medical or other health professions schools may be accomplished through any major program of study offered at WPI, although students majoring in some programs may have to use all of their electives to fulfill the required courses for medical school admission or may have to take some courses during summer sessions. It is important for students to work closely with their academic advisors as well as the pre-health advisor at WPI, to formulate an academic plan of study that will include the courses required for health professions schools. While each school may have specific and individual admissions requirements, typically these will include:

General chemistry*	3 courses
Organic chemistry*	3 courses
Biology*	3 courses
Physics*	3 courses
Calculus	2 courses
English composition**	2 courses

* These courses must include laboratory components.

** Check with the pre-health advisor for the use of course and project work to fulfill this requirement.

Students should consult catalogs of the individual health professions schools for specific requirements.

The WPI projects system offers a tremendous advantage to pre-health professions students. Medical, dental and veterinary schools value teamwork, as well as cross

cultural, research, and medically related experience, all of which can be demonstrated through project work. Opportunities for such projects can be found on campus or at one of the project center sites at the University of Massachusetts Medical Center or Tufts University School of Veterinary Medicine or through WPI's global projects program. These projects provide students with valuable and unique experiences that can strengthen their commitment to a health profession and their application for admission to health professions schools.

Because students will leave WPI with a degree in an academic discipline, they will have other career opportunities should they decide not to pursue a career in a health profession or should they choose to work for some time after graduation before continuing on to a health professions school. Students or alumni applying to health professions school should plan to meet with the pre-health advisor to discuss the application process as well as to plan for a letter of recommendation from the pre-health office to support their application. These meetings should happen no later than the spring of the junior year or as soon as the decision is made to pursue admission to a health profession school.

PROJECT-BASED LEARNING COMMUNITY OPTION (PLC)

See page 257 for detailed description.

ROBOTICS

Robotics is currently experiencing a tremendous upsurge in interest worldwide with increasing application in many fields, such as consumer products, transportation, security and defense, and elder care, in addition to traditional industrial robotics. The increase is facilitated by recent advances in robot mobility, dexterity, and intelligence, driven by more powerful and cheaper computation, sensors, and actuators. Robots are becoming recognized as timesaving devices, assistive aids, household pets, children's learning platforms, and toys. They are also well suited to meeting security threats and coping with hazardous environments that would imperil humans. There is every reason to expect these trends to continue.

We believe students interested in careers in Robotics are best served as undergraduates by acquiring a broad background with some specialization in Robotics, leading to more focused study and research in graduate school or on the job. Students should gain an understanding of sensors, computing devices, and circuit design (Electrical and Computer Engineering), artificial intelligence and software engineering (Computer Science) and large, small and micro machine design (Mechanical Engineering). They will need to learn enough about all these fields to be able to work on multi-disciplinary teams with other engineers and scientists.

WPI welcomes students with these interests, which often develop by participating in programs such as FIRST (For Inspiration and Recognition of Science and Technology). WPI staff mentor a large FIRST team and support

similar robotics projects at the undergraduate level, in, for example, autonomous vehicle design.

WPI students can pursue specializations involving Robotics in several departments and programs. The department of Electrical and Computer Engineering and the department of Computer Science both encourage a focus on robotics, as detailed in their departmental descriptions. The department of Mechanical Engineering is developing a similar focus which we anticipate will be available in fall 2006. All three of these departments have sponsored final capstone design projects involving the application of their disciplines to robotics.

The Robotics program is directed by Ken Stafford, Manager of Academic Initiatives and head of the WPI FIRST competitive program. He oversees an active lab where students design various robotics devices in the lower level of Higgins Laboratories. You may contact him for information at 508 831-6122 or Stafford@wpi.edu.

SOCIAL SCIENCE AND POLICY STUDIES

K. SAEED, HEAD

PROFESSORS: J. T. O'Connor, K. Saeed
ASSOCIATE PROFESSORS: J. K. Doyle, M. J. Radzicki,
K. J. Rissmiller, J. M. Wilkes

ASSISTANT PROFESSORS: O. Pavlov, E. A. Weaver
PROFESSOR OF PRACTICE: J. Lyneis

ADJUNCT FACULTY: W. Baller, R. Eberlein, A. Ford,
J. Gobert, G. Heaton, J. Hines, B. Karanian, M. Miller,
K. Warren

AFFILIATED FACULTY: D. Meadows

MISSION STATEMENT

SSPS programs are concerned with the substance and the process of socioeconomic problem solving especially as related to technological development, the environment, and public policy. Most socioeconomic problems - e.g., inflation, unemployment, urban deterioration, environmental pollution, income inequality, or infrastructure creation and maintenance - go beyond the boundaries of the traditional social science disciplines. Hence, the courses offered by the Department of Social Science and Policy Studies attempt to integrate knowledge and research techniques from multiple disciplines. Our curriculum covers system dynamics, economics, sociology, psychology, law and political science. System dynamics exclusively focuses on a computer modeling and experimental analysis approach to problem solving and policy analysis while other areas employ a variety of modeling and analysis methods including system dynamics. The department also encourages students to view social and economic problems, and the relationship of technology to society, from a variety of perspectives and to become acquainted with different methods of gathering and analyzing social data.

SSPS department offers undergraduate majors in several policy related disciplines. In addition, the department administers WPI's two-course requirement in the Social Sciences.

EDUCATIONAL OUTCOMES

Graduates of a social science major must have demonstrated through coursework and projects:

1. An ability to recognize patterns in real world data, qualitative and quantitative, in order to be able to define problems.
2. An ability to formulate hypotheses and models representing problems and understand their logic.
3. An ability to experiment with such models to establish their validity.
4. An ability to carry out exploratory analysis to arrive at remedial instruments addressing the defined problems.
5. Literacy in the technical aspects of a problem in the student's area of concentration.
6. An ability to effectively communicate the results of an analysis.
7. An ability to work in groups.
8. Computer literacy.

The teaching of the social sciences differs from engineering in that it must deal with a large variety of empirical manifestations in the face of unreliable and often local theoretical premises. Thus, while a bulk of engineering practice involves applying well-known physical principles to the design of physical systems, much time must be spent in social science analysis recognizing problems, understanding their underlying relationships and developing premises to deal with the stylized facts. Once a problem is recognized, a vehicle of analysis must be developed to understand it and develop a remedial process. The validation of social analysis draws on the well-known principles of the scientific method, although the mechanics of its implementation vary depending on the vehicle of analysis used.

SPPS course offerings attempt to address the above agenda by focusing on description and analysis rather than only on prescription. Methodology and its valid practice are covered extensively in the system dynamics courses, while in other offered courses, research methods are integrated with the discipline-related content. Many courses emphasize group work in one form or the other. Item 5 above is addressed through coursework in other departments offering relevant curricula. The Interactive Qualifying Project (IQP) and Major Qualifying Project (MQP) offer opportunities for learning the problem solving process in a real world context.

MAJOR PROGRAMS

The department offers majors in system dynamics, economic science, economics and technology, psychological science, environmental policy and development, and society-technology and policy. Please see the respective program coordinator for advice on the major you are interested in.

SYSTEM DYNAMICS

Coordinator: Prof. James M. Lyneis

The system dynamics major is aimed at developing the craftsmanship and the multi-disciplinary skills needed for computer modeling and experimental analysis of complex socioeconomic and technical problems encountered in private and public organizations. It prepares students for careers in public and private sector organizations

maintaining in-house planning and problem solving groups, as well as for careers in public and private sector consulting firms. The fundamental focus of the program is on system dynamics as a problem-solving methodology and on training students to apply system dynamics to a wide range of problems experienced in engineering, economic and societal systems. The application areas of the program are designed to create opportunities for students to apply computer modeling and experimental analysis to specific problems, so that they can develop both expertise in those areas and the methodological skills necessary for applying the technique to other application areas. The major responds to the need for integrating specialized skills to address multidisciplinary problems created by the interaction of society and technology.

ECONOMIC SCIENCE

Coordinators: Prof. Michael J. Radzicki, Prof. Oleg Pavlov

The Department of Social Science & Policy Studies offers a major in Economic Science that prepares students for careers in public administration, labor-management relations, or the economic, finance, international, marketing, and general management areas of industry. It also provides students with an excellent foundation for graduate study in economics, business, and law.

"Economic Science" is an established term often used to refer to scientifically rigorous analysis in economics. For example, the "Nobel Prize in Economics" is actually called "The Bank of Sweden Prize in Economic Sciences;" the NSF Directorate that funds economic research is the "Directorate for Social, Behavioral, and Economic Sciences;" the "Economic Science Association" is a professional organization for academic economists and other behavioral scientists who apply scientific methods to the study of economics.

The rationale for calling our major "economic science" is to emphasize that we approach the study of economics via the utilization of computational tools. WPI's particular use of computational tools to do economics is quite unique, somewhat path breaking, and is beginning to get significant attention from the economics profession. Integrated into teaching, it emphasizes adherence to rigorous methodological standards for economic experimentation and problem solving.

Students majoring in economic science will study microeconomic theory and macroeconomic theory at both the introductory and intermediate levels and also choose from several upper level courses and Independent Studies that cover the following subject areas: development economics, environmental economics, government and business, history of economic thought, information economics and policy, international economics, labor economics, managerial economics, public sector economics, economics of health care, regional economics, and money, credit, & banking. In addition, to develop a capability in an area of economic modeling, students majoring in economic science will study econometrics, system dynamics, or both. If desired, students may apply one of these two modeling techniques to concentration areas in Sustainable Economic Development and Computational Economics.

ENVIRONMENTAL POLICY AND DEVELOPMENT

Coordinators: Prof. Khalid Saeed and Prof. Kent Rissmiller

During the past decade, the daily news has become increasingly filled with stories of economic stagnation and environmental destruction. As a result, interest in the environment and its impact on households, firms, cities, regions, and nations has been rekindled among students, the public at large, and within private firms and the government.

At the university level, environmental issues can be studied in a number of ways. They can, for example, be studied from a technological perspective via the natural and engineering sciences, or from a policy perspective via the management and social sciences. Indeed, environmental programs at many universities examine environmental issues in precisely these ways. It is unusual, however, for an environmental program to offer a strong education from both the technical and policy perspectives. The Department of Social Science & Policy Studies at WPI fills this gap by offering a baccalaureate degree in the area of Environmental Policy and Development (EP&D). This degree program offers students substantial technical and policy education on environmental issues. An important feature of WPI's EP&D major is its focus on the interaction between the environment and the economy. On June 14, 1992, during the so-called "Earth Summit" in Rio de Janeiro, the United Nations Conference on Environment and Development adopted Agenda 21, a document that calls upon the nations of the world to "take a balanced and integrated approach to environment and development questions." The EP&D major has adopted sustainable economic development as one of its organizing themes. That is, many traditional environmental issues are examined through the lens of sustainable development.

The term sustainable development means choosing policies that balance environmental preservation and economic development so as to meet the needs of the present generation without compromising the needs of future generations. The global ecological-economic system is essentially "closed." This means that, except for the receipt of solar energy from outer space and the dispersion of heat to outer space, the system is self-contained. The people living in the global system use both nonrenewable and renewable resources (which are limited) to produce goods and services that sustain and enhance life on the planet. Unfortunately, the process of creating goods and services also generates pollution that must be dispersed into the land, sea, and air. The amount of pollution that these "sinks" can absorb is also limited.

For the global system to sustain itself indefinitely, renewable resources must not be used faster than the rate at which they can be regenerated, nonrenewable resources (taking recycling into account, which is also a limited process) must not be faster than the rate at which they can be substituted for, and pollution must not be generated faster than the rate at which the system can absorb it. WPI's program in EP & D examines the economic, psychological, social, political, legal, and technical issues surrounding the creation of policies aimed at establishing sustainable economic systems at the local, national, and international levels.

PSYCHOLOGICAL SCIENCE

Coordinator: Prof. James K. Doyle

Psychology is the study of human thought and behavior. Its goal is to contribute to human welfare by developing an understanding of why people do what they do. Psychologists study the entire range of human experience, from infancy until death, from the most abnormal behavior to the most mundane, from the behavior of neurons to the actions of societies and nations. The field of psychology is divided between experimental psychologists for whom science comes first and clinical/counseling psychologists who employ a wider variety of approaches to the study of the mind.

While clinical and counseling psychology comprise a large and important part of the field, there are also a large number of experimental psychologists who employ scientific methods to study basic cognitive, social, and developmental processes and their applications to a wide variety of fields such as public health and safety, law, business, education, public policy, criminal justice, and environmental issues. At WPI, teaching and research emphasizes the scientific approach to psychology.

The major in psychological science is appropriate for students who want to pursue graduate work in experimental psychology or prepare for careers in human services, public relations, advertising, marketing, management or teaching.

This major is also appropriate for students who are double majoring and expect to be employed in a technological field in which a second degree in psychology will give them a career advantage. For example: a computer science major interested in artificial intelligence or human-computer interaction; a mechanical engineering major interested in human factors design; a biomedical engineering major interested in neural imaging; or a management major interested in organizational behavior.

Students majoring in psychological science will study a core of courses giving them a broad overview of psychology and a specific understanding of cognitive psychology, social psychology, and experimental methods and design. Then, they will choose from a wider set of offerings to develop their personal plan of study, potentially focusing on psychological approaches to cognitive skill development, cross-cultural understanding, history of science, environmental problem solving, group processes, education, and behavior in work settings. Finally, they can use their core knowledge to specialize in neuroscience, artificial intelligence, animal behavior, human factors, organizational behavior, and philosophy, or a specialization of their own design.

The psychology research interests of SSPS faculty include judgment and decision making, psychological dynamics, creativity and innovation, risk perception and communication, stakeholder and policy maker interactions, individual differences in cognitive style, the psychology of environmental problems, security policy making, and the effect of computer simulation on learning. We will offer MQP opportunities in these and other areas of interest to students. The Psychology Major Program Review Committee consists of Professors Doyle, Weaver, and Wilkes.

SOCIETY, TECHNOLOGY AND POLICY*Coordinator: Prof. John M. Wilkes*

The Society Technology and Policy major at WPI is designed for those who wish to prepare for a career in which they will deal with our society's critical problems. Great challenges face our society and many of the major ones stem from the interplay of technology and society. Environment, energy, productivity, population, education, defense, and global competition are all recognized as policy areas in which technological change is playing an important role. To address such problems, policy makers and analysts must be technically literate and familiar with the tools of analysis in the social ills both as a cause and, potentially, as a cure. This is precisely the background and knowledge that the Society, Technology and Policy program seeks to provide. In the STP program students major in social science and minor in a science or engineering discipline of their choice. Over a dozen technological alternatives are available including: biotechnology, computer science, manufacturing engineering, and management. Students take courses in at least two social science disciplines: economics, political science, psychology, and sociology. The social science coursework will emphasize policy issues and the study of the ways in which science and technology shape society and, conversely, the ways in which social forces affect the development of technology.

As a major in this program, a student will benefit from WPI's project oriented approach to learning. Students use project opportunities to engage in in-depth research on social policy issues and the interactions between society and technology. They may carry out their projects on the WPI campus, at any number of local agencies or corporations, or at one of WPI's off campus project programs in the United States and abroad. Through this interdisciplinary program the student will acquire the social science background needed to understand contemporary public policy, to interpret technical materials produced by physical scientists, engineers and social scientists and to be able to synthesize these materials for policy considerations on the part of government and industry. Graduates of this program will be valuable additions to the administrative or research staffs of a variety of businesses, regulatory agencies, government departments or contract research organizations.

Program Distribution Requirements for the System Dynamics, Economic Science, Society Technology and Policy, Psychological Science, and Environmental Policy and Development Majors

The normal period of residency at WPI is 16 terms. In addition to the WPI requirements applicable to all students, completion of a minimum of 10 units of study is required in social science, basic science, and mathematics as follows:

SYSTEM DYNAMICS

Requirements	Minimum Units
1. System Dynamics (Note 1)	5/3
2. Other Social Science (Note 2)	5/3
3. Management (Note 3)	2/3
4. Mathematics/basic sciences/engineering (Note 4)	8/3
5. Computer Science (Note 5)	2/3
6. Application Area (Note 6)	5/3
7. MQP	1

NOTES:

1. Only social science courses with a "5" in the second digit of the course number count toward the system dynamics requirement.
2. Must include microeconomics or macroeconomics, cognitive or social psychology, and public policy.
3. Must include organizational science.
4. Must include differential and integral calculus, differential equations, and numerical or statistical analysis.
5. Courses on computer programming and programming languages are recommended.
6. This requirement is satisfied by a cohesive set of work from the fields of social science, management, science, mathematics, computer science, or engineering as specified in the curriculum guidelines for system dynamics major.

ECONOMIC SCIENCE

Requirements	Minimum Units
1. Economics (Note 1).	3
2. Economics and/or Management (Note 2)	2/3
3. Other Social Science	1
4. Modeling Techniques	2/3
5. Mathematics (Note 3)	2
6. Basic Science	1
7. Electives	2/3
8. MQP	1

NOTES:

1. Must include courses in both micro and macro economic theory at the intermediate level and in econometrics and international trade (available through the Consortium or independent study).
2. Must include financial accounting, ACC1100. May include other relevant management courses as approved by the Departmental Program Review Committee.
3. Must include differential equations, integral calculus, and statistics.

SOCIETY, TECHNOLOGY AND POLICY

Requirements	Minimum Units
1. Social Science (Notes 1, 2).	4
2. Minimum Basic Science background.	2/3
3. Minimum Mathematics background (Note 3).	1
4. Technical concentration (Note 4).	5/3
5. Electives (Note 5).	5/3
6. MQP	1

NOTES:

1. Students must obtain approval of their proposed program from the Departmental Program Review Committee. Course distribution will focus on a disciplinary specialty and either policy analysis or a society-technology specialization such as Social Impact Analysis or Technology Assessment.
2. Relevant Humanities or Management courses approved by the Departmental Review Committee may be counted for a maximum of 2/3 of a unit in fulfilling the 4-unit requirement.
3. One course in calculus-based statistics is required.
4. A series of courses in one field of science, engineering, or management or a combination of courses approved by the departmental review committee which focus on issues to be developed in the MQP.
5. These courses are to be approved by the Departmental Review Committee and are meant to broaden the technical concentration and tie it to social concerns.

PSYCHOLOGICAL SCIENCE

Requirements	Minimum Units
1. Psychological Science (Note 1)	3
2. Psychological Science and/or Related Courses (Note 2)	1
3. Other Social Science (Note 3)	1
4. Basic Science, Computer Science, and/or Engineering (Note 4)	5/3
5. Mathematics (Note 5)	4/3
6. Electives (Note 6)	1
7. MQP	1

NOTES:

1. Must include introductory psychology, social psychology, cognitive psychology, and research methods.
2. Related courses must be chosen from a list of psychology-related courses from other departments maintained by the Psychology Program Review Committee.
3. May include no more than two courses at the 1000-level.
4. Must include 1/3 unit of biology. Must include 1/3 unit of computer science (except CS 2022 and CS 3043).
5. Must include 2/3 units of calculus and 2/3 unit of statistics.
6. The 1 unit of electives must be coherently defined and approved by the Psychology Program Review Committee.

ENVIRONMENTAL POLICY AND DEVELOPMENT

Requirements	Minimum Units (Note 1)
1. SS & PS (Note 2).	12/3
2. Mathematics (Note 3).	5/3
3. Basic Science (Note 4).	2/3
4. Technical Concentration (Note 5).	2
5. Department Electives (Note 6).	2/3
6. MQP.	1

NOTES:

1. 1/3 unit = 1 course. 15 units are required for graduation.
2. Students must complete 5/3 units (5 courses) in one of three social science areas: (a) economics, (b) psychology/sociology, (c) political science (includes SS & PS courses in law and policy analysis) and 2/3 unit (2 courses) in each of the other two social science areas. The particular courses chosen must include six out of the following nine courses: Environmental Problems and Human Cognition, American Public Policy, Development Economics, Environmental Economics, International Environmental Policy, Introduction to System Dynamics Modeling, Environmental Policy and Law, Governmental Decision Making and Administrative Law, and the Society-Technology Debate. Students must also complete three other social science courses (1 unit) of their choosing.
3. Must include both calculus and statistics.
4. Basic science courses must be selected from the disciplines of Physics, Chemistry, or Biology.

5. The technical concentration must include at least six thematically related courses in science, engineering or management that have been approved by the Department's Program Review Committee.
6. Departmental electives must be selected from the areas of mathematics, basic science, social science, or the technical concentration.

THE SOCIAL SCIENCE REQUIREMENT

To satisfy WPI's two-course social science requirement, students may take courses in any of the traditional social sciences. They will normally begin by taking one of the introductory core courses listed below:

System Dynamics

SD 1510 Introduction to System Dynamics Modeling

Economics

ECON 1110 Introductory Microeconomics

ECON 1120 Introductory Macroeconomics

Sociology

SOC 1202 Introduction to Sociology and Cultural Diversity

Society/Technology Studies

STS 1207 Introduction to the Psycho-sociology of Science

Psychology

PSY 1400 Introduction to Psychological Science

PSY 1401 Introduction to Cognitive Psychology

PSY 1402 Introduction to Social Psychology

PSY 1403 The Psychology of Work

PSY 1504 Strategies for Improving Cognitive Skills

Political Science

GOV 1301 U.S. Government

GOV 1303 American Public Policy

GOV 1310 Law, Courts, and Politics

GOV 1320 Topics in International Politics

THE SECOND COURSE IN SOCIAL SCIENCE

In choosing their second course in social science, students confront a choice between taking a second introductory course in another social science discipline, or a more advanced course in the same social science discipline as the first. The department recommends the latter choice. At least two courses in a given field are essential to achieving a firm understanding of the nature of the discipline: its organization, its basic vocabulary, the way in which it approaches the solution of the problems that are its central focus, and how it seeks to explicate the phenomena with which it is concerned. Moreover, the advanced courses available at WPI have substantial theoretical and empirical components, which provide the student with an opportunity to see how social science is applied to the solution of specific public and private policy problems. These courses are listed below.

System Dynamics

SD 1520 System Dynamics Modeling

SD 2530 Advanced Topics in System Dynamics Modeling

SD 3550 System Dynamics Seminar

Economics

ECON 2110 Intermediate Microeconomics

ECON 2117 Environmental Economics

ECON 2120 Intermediate Macroeconomics

ECON 2125 Development Economics

Society/Technology Studies

STS 2208 The Society - Technology Debate

STS 2209 Conflict and Cooperation in Research and Development Settings

Political Science and Law

GOV 2302	Science-Technology Policy
GOV 2304	Governmental Decision Making and Administrative Law
GOV 2310	Constitutional Law
GOV 2311	Environmental Policy and Law
GOV 2312	International Environmental Policy
GOV 2313	Intellectual Property Law
GOV/ID 2314	Cyberlaw and Policy

Psychology

PSY 2401	The Psychology of Education
PSY 2405	Environmental Problems and Human Cognition
PSY 2406	Cross-Cultural Psychology: Human Behavior in Global Perspective

These advanced or depth courses deal with a wide variety of subjects: system dynamics modeling and experimental analysis, government regulation of business, environmental law and economics, educational psychology, technology assessment and environmental policy and decision making, among others. This element of application in the depth courses adds greatly to students' interests in the course and their understanding of the capabilities and usefulness of the subject.

Students are advised to take both of their social science courses in the same discipline so that they may take a depth course that will provide an opportunity to study social science of specific and direct relevance to their Interactive Qualifying Projects (IQPs). Some students prefer, however, to combine courses across disciplines. In particular, a course in social science methodology like SD 1520 System Dynamics Modeling would be suitable to be taken with an introductory course in economics, psychology, sociology and political science and law. The department believes that it is critical for students to forge as close and direct a link as possible between their social science preparation and IQP. The IQP relates science and technology to society. It aims to make students sensitive to general social problems, aware of societal-humanistic-technological interactions, able to analyze these interactions and to make better judgments and policy recommendations. Given the objective of the IQP, it is not surprising that many involve analysis of social problems and the evaluation of policy options. Typically, knowledge of both technology and social science are required for effective handling of such IQPs. But in many cases, the critical skills lie in the area of social science. Technology provides the base-line level of information required to assess an impact or to evaluate options. However, the manner in which society responds to technical change is a function of our economic and political systems, of individual perceptions, attitudes and values, and the interactions of individuals and groups. All of these are the subject matter of social science. Their understanding is essential for projects that analyze societal-technological interactions and examine social policy issues, whether directly linked to technological developments or not.

The most important contribution which the study of social science can make to the education of engineering and science students is to create an awareness that knowledge of social science is vital in analyzing a wide range of problems and in making many types of decisions. It is important that, in the future, engineers and scientists not approach social impact problems guided solely by their

background in technology, ignoring the previous contributions of the social sciences in these areas. The primary goal of the social science requirement is to leave engineering and science students with the recognition that social science knowledge is useful and accessible and that they are capable of mastering its tools, comprehending its approaches and applying these tools to practical problems.

If this goal is to be realized, it is highly advisable that students link their study in social science to their Interactive Qualifying Projects. The department recommends that students begin with an introductory course late in the freshman or early in the sophomore year, and follow that with an applied depth course in the sophomore or early in the junior year when the IQP topic has been identified.

COURSE SEQUENCES IN SOCIAL SCIENCE

To aid students in selecting appropriate sequences of introductory and applied courses to satisfy their social science requirement, the department has identified logical course sequences in the areas listed below.

SYSTEM DYNAMICS

Introduction to System Dynamics Modeling (SD 1510) followed by SD 1520 System Dynamics Modeling provides students with a sequence of two courses in system dynamics. The first course introduces the students to the systems thinking perspective and the techniques of modeling and experimental analysis using computer simulation. The second course deals with problem solving using system dynamics modeling. These two courses provide the basic skills for applying the system dynamics method to IQP or MQP projects. System Dynamics is an expanding process in K-12 education. This course sequence would also greatly help aspiring high school teachers to apply system dynamics in facilitating learning in their respective subject areas. For a more technical treatment of the subject, the two-course sequence may include System Dynamics Modeling (SD 1520) followed by Advanced Topics in System Dynamics Modeling (SD 2530).

ECONOMICS

Several combinations of course offerings in economics can be selected depending on the student's interest. Introductory Microeconomics (ECON 1110) followed by Intermediate Microeconomics (ECON 2110) would cover microeconomic theory as applied to a firm. Introductory Microeconomics (ECON 1110) followed by Environmental Economics (ECON 2117) would create a theoretical basis for dealing with environmental regulation and policy. Introductory Macroeconomics (ECON 1120) followed by Development Economics (ECON 2125) would make a succinct introduction to developmental agendas. Introductory Micro- or Macro- economics (ECON 1110 or ECON 1120) followed by System Dynamics Modeling (SD 1520) would create a good window to understanding economic dynamics and disequilibrium growth.

The tools of decision-making developed in these courses find application in a wide range of IQPs. Cost analysis, investment decisions, and the forecasting of trends in consumption, production and prices are required in many IQPs dealing with energy, risk analysis, and economic growth and development.

PSYCHOLOGY

A two-course sequence in Psychology is ideal preparation for IQPs that require an understanding of how individuals or groups think when faced with social and technological problems. PSY 1400 (Introduction to Psychological Science) is a broad introduction to the field of psychology suitable for students who have not previously studied psychology. PSY 1401 (Cognitive Psychology) and PSY 1402 (Social Psychology) are alternate introductions to experimental psychology. PSY 1401 emphasizes the mental processes that individuals apply to perception, memory, learning, judgment, and problem solving tasks and their implications for education and engineering design. PSY 1402 is concerned with how people think about, feel for, and act toward other people, and covers such topics as social influence, altruistic behavior, aggression, gender differences, stereotyping and prejudice, and small group decision making. Strategies for Improving Cognitive Skills (SD 1504) provides students an opportunity to improve many of the mental skills relevant to IQPs and MQPs, including memory, problem solving, reasoning, decision making, and intelligent criticism.

Either PSY 1401 or PSY 1402 followed by PSY 2401 (The Psychology of Education), provides a solid background for students who plan to conduct IQPs in educational settings, from pre-school through college. PSY 2401 covers such topics as student diversity, the learning process, motivation to learn, and techniques for evaluating student learning. Current issues in higher education (particularly technological education) are emphasized.

The two-course sequence PSY 1402 and PSY 2406 (Cross-Cultural Psychology: Human Behavior in Global Perspective) is especially designed for IQP students preparing to work at international project centers, International Scholars, and students interested in the global aspects of science and technology. PSY 2406 introduces students to the wide variety of social and cultural influences that shape human behavior in different parts of the world, with particular attention paid to cultural influences on technology development and transfer.

Students interested in new approaches to environmental problems should consider taking PSY 1400 or PSY 1401 followed by PSY 2405 (Environmental Problems and Human Cognition). PSY 2405 traces the root causes of environmental problems to basic human thought processes and explores the argument that successful environmental policies must be based on an understanding of how individuals think about the environment, how pro-environmental behavior is related to environmental attitudes, and how people respond to environmental information and policies. The course emphasizes the application of psychological knowledge to the development of innovative solutions to problems such as global warming, ozone depletion, species extinction, and energy and resource conservation.

SOCIOLOGY (SCIENCE, TECHNOLOGY, AND POLICY)

Many IQP projects center on issues of social impact, technology assessment, or addressing a social problem. Some address issues specifically in the society-technology debate regarding the cultural and social trends associated with the emergence of a “technological” or “post-industrial” society. The following courses have been developed as background material for such projects. Many are also core courses in the curriculum designed for Society-Technology Majors.

The typical entry level course for those interested in STS 2208 (The Technology-Society Debate) is SOC 1202 (Introduction to Sociology and Cultural Diversity). However, there is another course that is an acceptable alternative in preparing for STS 2208 (The Technology-Society Debate). This is STS 1207, The Psycho-Sociology of Science. PSY 1402 (Social Psychology) is also a good preparation for SOC 1207.

SOC 1202 (Introduction to Sociology and Cultural Diversity), STS 1207 (The Psycho-Sociology of Science) and STS 2209 (Conflict and Cooperation in R&D Settings) are appropriate for the students interested in global comparative analysis at the macro level of sociology, and psychosociological examination of innovation and creativity in science and engineering labs, respectively. The study of technology assessment and social impact analysis is no longer done in courses, but rather in project work and independent study classes.

POLITICAL SCIENCE/PUBLIC POLICY

Several courses introduce students to the analysis of public policy: GOV 1301, U.S. Government; GOV 1303, American Public Policy; GOV 2302, Science-Technology Policy, or GOV 2304, Governmental Decision Making and Administrative Law and GOV/ID 2314 Cyberlaw and Policy. This sequence is designed for students who want to obtain an understanding of American government, its institutions, and the factors affecting public policy. The courses would be especially useful for students whose IQPs will address a public policy issue or some problem that requires a response from government. In addition, the courses will impart an appreciation for our political heritage and the values, which shaped our constitutional structure.

The political environment for science and technology has become extremely complex during the last few decades. Government directly supports over half of the nation's research and development. It also regulates the use of many technologies, including nuclear power, biotechnology, and manufacturing processes, which potentially harm the environment. Moreover, scientists and engineers are frequently called upon to help government solve problems. They often find themselves uncomfortably in the midst of political controversies.

These courses would shed some light on the mysterious processes of government. By enabling students to critically assess the performance of government and to articulate their own policy preferences, the courses would eliminate one barrier preventing WPI students from contributing to the public process.

CURRICULUM GUIDELINES FOR SYSTEM DYNAMICS

Recommendations for complying with the program distribution requirements (10 units) are described below. To earn a Bachelor of Science (B.S.) degree in System Dynamics, students must complete 15 units of coursework. In addition to the requirements below, one must complete the Sufficiency (2 units), the Interactive Qualifying Project (1 unit), free electives (5/3), and physical education (1/3).

Specific course recommendations for complying with the program distribution requirements are given below. These recommendations are intended to offer flexibility while preparing students for careers in system dynamics.

System Dynamics (5/3)

Students can choose from among the following courses in system dynamics:

SD 1510	Introduction to System Dynamics Modeling
SD 1520	System Dynamics Modeling
SD 2530	Advanced Topics in System Dynamics Modeling
SD 3550	System Dynamics Seminar
SS 4000	Advanced ISP

They may also take a selection from the following graduate courses.

SD 550	System Dynamics Foundation: Managing Complexity
SD 551	Modeling and Experimental Analysis of Complex Problems
SD 552	System Dynamics for Insight
SD 553	Model Analysis and Evaluation Techniques
SD 554	Real World System Dynamics
SD 560	Strategy Dynamics
SD 561	Environmental Dynamics
SD 562	Project Dynamics
SD 565	Macroeconomic Dynamics
SS 590	Special Topics in Social Science and Policy Studies

Other Social Science (5/3)

It is recommended that the requirement for microeconomics or macroeconomics be satisfied with either ECON 1110 or ECON 1120, although higher level economics courses are also possible. It is recommended that the requirement for cognitive or social psychology be satisfied with PSY 1401 or PSY 1402, although higher level psychology courses are also possible. The public policy requirement can be met by taking one of the following courses: GOV 1301, GOV 1303, GOV 2302, GOV 2304, GOV 2312. The other two social science courses are free electives and students can take any additional four courses in economics, sociology, political science and law, psychology, and system dynamics.

Management (2/3)

The requirement for organizational science may be met by taking one of OBC 2300 or OBC 3351. The second management course is a free elective.

Mathematics and Basic/Engineering Science (8/3)

The requirement for differential and integral calculus may be met by completing the calculus sequence through MA 1024. Higher level math courses or other basic science or engineering courses may be substituted if students complete MA 1024 without taking the full sequence MA 1021-MA 1024. It is recommended that the requirement for differential equations be met by MA 2051 and the requirement for numerical analysis be met by MA 3457/CS 4033, and the requirement for statistical analysis by MA 2611 or SS 1130. Once the math require-

ments are met, students may take any combination of additional math, basic science, or engineering courses to complete the 8/3 unit requirement. Those pursuing computer science as an application area should take CS 2022 to be able to follow upper level courses in the application area. It is recommended, but not required, that students take PH 1110 and PH 1120 as preparation for ES 3011.

Computer Science (2/3)

CS 1101 and CS 2005 are recommended.

Application Area (5/3)

A minimum of 5/3 units of integrated coursework is required to satisfy this requirement. Often students focus their applied courses in a particular area such as those noted below. Other focus areas are possible but must be approved by the student's academic advisor and the Department's Undergraduate Committee early in the student's program. Suggested courses for 12 application areas are given below. There is some flexibility needed in the selection of these courses since system dynamics covers a wide range of policy agenda. The student must take 3 additional courses to get a minor in an application area. Requirements of the respective departments are to be met in the course selection for the minors.

Economics

Select 3

ECON 1110	Introductory Microeconomics
ECON 1120	Introductory Macroeconomics
ECON 2110	Intermediate Microeconomics
ECON 2120	Intermediate Macroeconomics

Select 2

ECON 2117	Environmental Economics
ECON 2125	Development Economics
OIE 2850	Engineering Economics

Project Dynamics

Required

CE 1030	Civil Engineering and Computer Fundamentals
---------	---

Select 3

ACC 2101	Management Accounting
CE 3020	Project Management
CE 3021	Cost Estimating, Scheduling and Control
CE 3022	Legal Aspects in Design and Construction
FIN 2200	Financial Management
	Independent Studies in Project Management

Engineering Systems

Required

ME 1800	Materials Selection and Manufacturing Process
---------	---

Select 4

ME 3311	Dynamics of Mechanisms and Machines
ME 3321	Dynamic Modeling
ME 3422	Environmental Issues and Analysis
ME 3820	Computer-Aided Manufacturing
OIE 3400	Production System Design
OIE 3460	Simulation Modeling and Analysis
MIS 3700	Information Systems Management

Public Policy

Select 2

GOV 1301	US Government
GOV 1303	American Public Policy
GOV 1310	Law Courts and Politics
GOV 1320	Topics in International Politics

Select 3

ECON 2117	Environmental Economics
ECON 2125	Development Economics
GOV 2302	Science-Technology Policy
GOV 2304	Government Decision Making and Administrative Law

GOV 2311 Environmental Policy and Law
 GOV 2312 International Environmental Policy
 GOV/ID 2314 Cyberlaw and Policy

Fire Protection Engineering

Required

FP 3070 Fundamentals of Fire Safety Analysis

Select 4

OIE 3501 Management Science II: Risk Analysis

Any other course and Independent Studies in
 Fire Protection Engineering

Environmental Policy

Select 2

BB 2040 Principles of Ecology

CE 3059 Environmental Engineering

CE 3070 Urban and Environmental Planning

CE 3074 Environmental Analysis

CHE 3910 Chemical and Environmental Technology

CHE 3920 Air Quality Management

ME 3422 Environmental Issues and Analysis

Select 3

PY 2717 Philosophy and Environment

ECON 2117 Environmental Economics

ECON 2125 Development Economics

GOV 2311 Environmental Policy and Law

GOV 2312 International Environmental Policy

PSY 2405 Environmental Problems and Human Cognition

Computer Science

Select 4 or more

CS 2223 Algorithms

CS 3041 Human Computer Interaction

CS 3431 Database Systems I

CS 3733 Software Engineering

CS 4241 Webware: Network Information Systems

CS 4341 Intro to Artificial Intelligence

Any other course and Independent Studies in Computer Science

Select 1 or more

MA 2210 Mathematical Methods in Decision Making

MA 3457 Numerical Methods for Calculus and
 Differential Equations

MA 4411 Numerical Solutions to Differential Equations

Infrastructure Planning

Select 2

ECON 1120 Introductory Macroeconomics

ECON 2120 Intermediate Macroeconomics

ECON 2125 Development Economics

CE 1030 Civil Engineering and Computer Fundamentals

Select 3

CE 3020 Project Management

CE 3021 Cost Estimating, Scheduling and Project Control

CE 3022 Legal Aspects in Design and Construction

CE 3070 Urban and Environmental Planning

CE 4024 Real Estate Development

Society-Technology Studies

Select 5

SOC 1202 Sociological Concepts and Comparative Analysis

PSY 1402 Introduction to Social Psychology

STS 2208 The Society - Technology Debate

GOV 2302 Science-Technology Policy

CS 3043 Social Implications of Information Processing

HI 2333 History of Science from 1700

HI 3331 Topics in Science, Technology and Society

Transportation Planning

Select 3

CE 3050 Highway Engineering and Planning

CE 3051 Transportation Systems

CE 3070 Urban and Environmental Planning

CE 3074 Environmental Analysis

CE 4071 Land Use Development and Controls

CE 3020 Project Management

Select 2

ECON 1110 Introductory Microeconomics

ECON 1120 Introductory Macroeconomics

ECON 2110 Intermediate Microeconomics

ECON 2117 Environmental Economics

ECON 2120 Intermediate Macroeconomics

ECON 2125 Development Economics

Electrical Power Systems Planning

Select 2

ECON 1110 Introductory Microeconomics

ECON 1120 Introductory Macroeconomics

ECON 2110 Intermediate Microeconomics

ECON 2120 Intermediate Macroeconomics

Select 3

ECE 3601 Principles of Electrical Engineering

ECE 4502 Analysis of Large Scale Electric Power Systems

CE 3070 Urban and Environmental Planning

Independent Studies on Electrical Power Systems Planning

Model Analysis

Select 5

ES 3011 Control Engineering I

MA 2210 Mathematical Methods in Decision Making

MA 3457 Numerical Methods for Calculus and
 Differential Equations

MA 4411 Numerical Analysis of Differential Equations

Independent studies in model analysis

Major Qualifying Project (3/3)

The MQP is expected to provide an integrative capstone experience in system dynamics. Students must complete an MQP that applies system dynamics modeling or methodology to the student's chosen application area.

CURRICULUM GUIDELINES FOR ECONOMIC SCIENCE

Recommendations for complying with the program distribution requirements are described below. Students earn a Bachelor of Science degree in Economic Science after completing 15 units of coursework. This coursework includes the program distribution requirement (10 units), the Sufficiency (2 units), the Interactive Qualifying Project (1 unit), free electives (5/3), and physical education (1/3).

Economics (3 units)

Students can choose from among the following courses in economic science (SS2110 and SS2120 are required):

ECON 1110 Introductory Microeconomics

ECON 1120 Introductory Macroeconomics

ECON 1130 Introduction to Econometric Modeling

ECON 2110 Intermediate Microeconomics

ECON 2120 Intermediate Macroeconomics

ECON 2125 Development Economics

ECON 2117 Environmental Economics

ECON 21XX Information Economics and Policy

In addition, students may arrange to take Economics courses at other Worcester Consortium schools. ISPs can also be arranged on a variety of economic topics.

Economics and/or Management (2/3 unit)

Students can take additional courses or ISPs in Economics or choose from among the following courses in management (ACC1100 is required):

ACC 1100 Financial Accounting

ACC 2101 Management Accounting

OIE 2850 Engineering Economics

FIN 2200 Financial Management

FIN 2250 Financial System of the United States

FIN 2260 Investment and Security Analysis

Other Social Science (1 unit)

Students fulfill this requirement by taking 3 courses in social science fields other than economics, including law, political science, psychology, public policy, sociology, and system dynamics.

Modeling Techniques (2/3 units)

Students may choose from among the following social science modeling courses:

SD 1510 Introduction to System Dynamics Modeling
SD 1520 System Dynamics Modeling
SD 2530 Advanced Topics in System Dynamics Modeling

ISPs in advanced econometrics may also be used to fulfill this requirement.

Mathematics (2 units)

Must include differential equations, integral calculus, and statistics. MA1021-24, MA2051, and MA2611 are recommended.

Basic Science (1 unit)

Students may take any combination of courses in the physical, chemical, or biological sciences.

Electives (2/3 unit)

Electives must be approved by the Economics Science Program Review Committee.

Major Qualifying Project (1 unit)

The MQP is expected to provide an integrative capstone experience in economic science.

DESCRIPTIONS OF CONCENTRATION AREAS AVAILABLE IN ECONOMIC SCIENCE

Economic Science majors may focus their studies by choosing a Concentration within one of the following two specific areas of Economics: Sustainable Economic Development and Computational Economics. These concentration areas reflect the growing importance of environmental issues and computation tools within the discipline of economics and are areas of strength in teaching and research in economic science at WPI. Concentrations within the Economics Science major comply with WPI's requirements for concentrations. Students must complete an MQP and two units of integrated study in the area of their Concentration.

Sustainable Economic Development. The term sustainable economic development means choosing policies that balance environmental preservation and economic development so as to meet the needs of the present generation without seriously compromising the needs of future generations. For the global system to sustain itself indefinitely, renewable resources must not be used faster than the rate at which they can be regenerated, nonrenewable resources (taking recycling into account, which is also a limited process) must not be used faster than the rate for which they can be substituted, and pollution must not be generated faster than the rate at which it can be absorbed. Additionally, the developmental agenda must not create social conflicts that limit further development and disrupt society. The sustainable development concentration examines the economic, psychological, social, political, legal, and technical issues surrounding the creation of policies aimed at establishing sustainable economic systems at the local, national, and international levels.

1. 1 unit from the following list of courses in economic development:

ECON 2125 Development Economics
ECON 2117 Environmental Economics
CE 3070 Urban Environmental Planning
CE 3074 Environmental Analysis
HI 3333 Topics in American Technological Development

2. 1 unit from the following list of environmental courses in other social science disciplines, humanities, and biology, or additional courses from list 1:

BB 1002 Environmental Biology
BB 4140 Ecological Management
GOV 2311 Legal Regulation of the Environment
GOV 2312 International Environmental Policy
PSY 2405 Environmental Problems and Human Cognition
PY 2717 Philosophy and the Environment

Computational Economics. Students in the computational economics concentration supplement their knowledge of traditional tools of economic analysis by studying modern computational techniques. The computational concentration allows students to investigate issues that are particularly challenging when tackled with analytical methods. Student projects may address problems of complex macroeconomic modeling, chaos, computational finance, design of automated Internet markets, and artificial life. This concentration draws on the expertise and talent of the faculty in various departments throughout the university.

1. 1 unit from the following list of courses in system dynamics:

SD 1510 Introduction to System Dynamics Modeling
SD 1520 System Dynamics Modeling
SD 2530 Advanced Topics in System Dynamics Modeling
SD 3550 System Dynamics Seminar

2. 1 unit from the following list of courses offered in other departments:

BB 4250 Ecological Simulation Modeling
CS 2022/MA2201 Discrete Mathematics
CS 4032/MA3257 Numerical Methods for Linear and Nonlinear Systems
CS 4033/MA3457 Numerical Methods for Calculus and Differential Equations
CS 4341 Introduction to Artificial Intelligence
ES 3011 Control Engineering I
OIE 3460 Simulation Modeling and Analysis
OIE 3501 Management Science II: Risk Analysis
MA 2210 Mathematical Methods in Decision Making
MA 2431 Mathematical Modeling with Ordinary Differential Equations
MA 3471 Advanced Ordinary Differential Equations
MA 4235 Mathematical Optimization
MA 4411 Numerical Analysis of Differential Equations

CURRICULUM GUIDELINES FOR PSYCHOLOGICAL SCIENCE

Recommendations for complying with the program distribution requirements (10 units) are described below. To earn a Bachelor of Science (B.S.) degree in Psychological Science, students must complete 15 units of coursework. In addition to the requirements below, one must complete the Sufficiency (2 units), the Interactive Qualifying Project (1 unit), free electives (5/3 unit), and physical education (1/3 unit).

Psychological Science (3 units)

Students can choose from among the following 12 courses in psychological science:

PSY 1400	Introduction to Psychological Science
PSY 1401	Cognitive Psychology
PSY 1402	Social Psychology
PSY 1403	The Psychology of Work
PSY 1504	Strategies for Improving Cognitive Skills
PSY 2401	The Psychology of Education
PSY 2405	Environmental Problems and Human Cognition
PSY 2406	Cross-Cultural Psychology: Human Behavior in Global Perspective
STS 2400	Methods, Modeling, and Analysis in Social Science
STS 1207	Introduction to the Psycho-Sociology of Science
STS 2209	Innovation, Teamwork, and the Process of Innovation

In addition, students may arrange to take Psychology Courses offered at other Worcester Consortium schools. ISPs can also be arranged on a variety of psychological topics.

Psychological Science and/or Related Courses (1 unit)

Students may choose to take additional psychological science courses from the above list or choose from among the following list of courses in other departments that are closely related to psychological science and/or have significant psychological content:

BB 3080	Neurobiology
BB 3160	Behavioral Ecology
CS 3041	Human-Computer Interaction
CS 4341	Introduction to Artificial Intelligence
ID/AR 3150	Light, Vision, and Understanding
MKT 3600	Marketing Management
OBC 2300	Organizational Science - Foundation
OBC 3351	Organizational Science - Management of Change
OBC 4365	Leadership in Groups and Organizations
PY 2711	Philosophical Theories of Knowledge and Reality
PY 2715	Philosophical Theories of the Self

Other Social Science (1 unit)

Students fulfill this requirement by taking 3 courses with an SS prefix that are not included in the Psychological Science course list. This includes courses in system dynamics, economics, sociology, political science, public policy, and law. No more than two of the courses may be at the 1000-level. Students are encouraged to focus their effort by taking multiple courses in a single social science discipline.

Basic Science, Computer Science, and/or Engineering (5/3 units)

Must include 1/3 unit in Biology and 1/3 unit in Computer Science. BB 1001 and CS 1101 or CS 1102 are recommended. Students may use the remaining 1 unit of work to complete additional courses in biology or computer science or to explore other science and engineering disciplines.

Mathematics (4/3 units)

Must include 2/3 of calculus and 2/3 unit of statistics. MA 1021, MA 1022, MA 2611, and MA 2612 are recommended.

Electives (1 unit)

Electives must be approved by the Psychological Science Program Review Committee. Students are encouraged to use these electives to obtain background for upper level courses on the Related Courses list.

Major Qualifying Project (1 unit)

The MQP is expected to provide an integrative capstone experience in psychological science.

DOUBLE MAJOR IN SOCIAL SCIENCE AND POLICY STUDIES

Any of the department majors programs outlined above may be taken as part of a double major in which the student majors in an area of science, engineering or management as well as social science. To obtain a double major, the student must satisfy all of the degree requirements of the technical discipline including an MQP and Distribution requirements. In addition, the double major in Social Science and Policy Studies requires four units of study in social science (inclusive of the normal two-course social science requirement) and the completion of a second qualifying project which combines the IQP and social science MQP into a single one-unit project. Unlike other double majors, the double major in Social Science and Policy Studies does not require three qualifying projects: two MQP's and an IQP. However, the combined social science MQP and IQP must meet the goals of both. It must be interactive in nature involving an aspect of technology as well as in application of social science knowledge and analytical techniques. The decision to pursue the social science double major should be made fairly early in the student's academic career, certainly early enough to ensure the selection of an appropriate IQP/MQP.

SOCIAL SCIENCE MINORS

A Social Science Minor is available in any of the following disciplines:

Economics
Sociology
Political Science and Law
Psychology
System Dynamics
Social Science

A minor in the Social Sciences consists of 2 units of academic activity satisfying the following conditions:

1. Foundations

Introductory level courses in any one or two social science disciplines taught at WPI: economics, sociology, political science (and law), psychology, and system dynamics. Introductory courses are identified by the first digit of the course number, which must be a 1. The second digit of the course number indicates the discipline (1–economics, 2–sociology, 3–political science and law, 4–psychology, and 5–system dynamics).

2. Applied Courses (At least 1 unit)

Three or more higher level courses in the same social science discipline as the foundation courses, which involve applications or extensions of the material covered in the introductory courses and list the introductory courses as recommended background. High level courses have either a 2, 3, or 4 as the first digit of the course number. The capstone experience will consist of a paper in the last applied course taken. The paper must draw upon and integrate material covered in the previous courses. An IQP may provide the capstone experience and substitute for the last applied course provided that the IQP was advised or co-advised by a member of the Social Science & Policy Studies department, and contains appropriate social science analysis.

3. If five or more of the six 1/3 units required for the minor are in a single social science discipline, the title of the minor will be “Minor” in that discipline.* Otherwise the title of the minor will be “Minor in Social Science.” Examples of minor programs in economics, sociology, political science (and law), psychology, system dynamics and interdisciplinary social science are available at the SS & PS department office. The course selected for an interdisciplinary social science minor should follow an identifiable theme, such as the relationship between technology and society or social, political, economic or environmental policies.

Students taking minors in the social sciences are expected to designate a member of the SS & PS department as their SS minor advisor, who will assist them in preparing a program that meets the requirements of the minor. Students can obtain assistance at the SS & PS departmental office in designating an advisor.

Students completing any major in the Social Science and Policy Studies Department may not also complete a minor in social sciences.

* In designating sociology the minor, the course PSY 1402, Social Psychology, can be counted as one of the five courses required in Sociology. In designating the economics minor, at least 3 of the 5 required courses must be chosen from among the following four theory courses:
ECON 1110 Introductory Microeconomics;
ECON 1120 Introductory Macroeconomics;
ECON 2210 Intermediate Microeconomics; and
ECON 2120 Intermediate Macroeconomics.

COURSE DESCRIPTIONS

S E C T I O N

three

Air Force Aerospace Studies	188
Basic Sciences	189
Biology and Biotechnology	189
Biomedical Engineering	193
Chemical Engineering	195
Chemistry and Biochemistry	197
Civil and Environmental Engineering	200
Computer Science	202
Electrical and Computer Engineering	205
Engineering Science Interdisciplinary	208
Fire Protection Engineering	209
Humanities and Art	210
Interactive Media and Game Development	220
Interdisciplinary	221
Management	222
Mathematical Sciences	225
Mechanical Engineering	229
Military Science	233
Physical Education	234
Physics	235
Social Science and Policy Studies	237

COURSE CATEGORIES

For purposes of planning programs of study, courses at WPI are divided into two categories.

Category I (Cat. I)

These courses cover core material of interest to large numbers of students. Category I courses are offered at least once a year.

Category II (Cat. II)

Category II courses are usually offered every other year.

BACKGROUND*Recommended*

The course will build on material in the recommended course. Instructors can assume that the student is knowledgeable of the material from the recommended course or from other experiences.

Suggested

The material from this course would be helpful to the student, but it is not assumed background.

CATALOG AND SCHEDULE ON THE WWW

The catalog and course schedule can be found on the world wide web at www.wpi.edu/+ugradcat and www.wpi.edu/+schedules.

COURSE NUMBERING

Each course at WPI is designated by a two-letter prefix identifying the subject area followed by a four digit number. The first digit is coded as follows:

- 1 — Courses for which first-year students will receive priority in registration. Upper class students may register on a space-available basis.
- 2 — Basic level courses.
- 3 — Advanced level undergraduate courses for which no graduate credit is given. (This restriction may be waived at the discretion of the degree department.)
- 4 — Advanced level undergraduate courses for which graduate credit may also be given.
- 5 — Graduate courses.

The last three digits may be used by the departments to indicate subject areas. Many graduate courses are also available to undergraduates.

COURSE CREDIT

Unless otherwise indicated, WPI courses usually carry credit of 1/3 unit. This level of activity suggests at least 17 hours of work per week, including class and laboratory time. The usual workload per term is 1 unit.

AIR FORCE AEROSPACE STUDIES

AS 1001. THE FOUNDATIONS OF THE UNITED STATES AIR FORCE I. *Cat. I (1/9 unit)*

The AS 1000 sequence of courses are designed to introduce students to the United State Air Force and Air Force Reserve Officer Training Corps. Featured topics include mission and organization of the Air Force, officership and professionalism, Air Force officer opportunities, military customs and courtesies, and an introduction to communication skills.

The first course focuses on the foundation of officership and customs and courtesies.

The course includes one hour of class work and two hours of mandatory leadership laboratory per week. The AS 1001 Leadership Laboratory includes a study of Air Force customs and courtesies, drill and ceremonies, and military commands.

AS 1002. THE FOUNDATIONS OF THE UNITED STATES AIR FORCE II. *Cat. I (1/9 unit)*

The AS 1000 sequence of courses are designed to introduce students to the United State Air Force and Air Force Reserve Officer Training Corps.

A continuation of AS 1001, the second course in this series emphasizes those communication skills needed in today's Air Force. It describes the communication systems, discusses common barriers and enhancements to effective communications. The course includes numerous speaking and written exercises using current Air Force topics.

The course includes one hour of class work and two hours of mandatory leadership laboratory per week. The AS 1002 Leadership Laboratory includes a study of Air Force customs and courtesies, drill and ceremonies, and military commands.

AS 1003. THE FOUNDATIONS OF THE UNITED STATES AIR FORCE III. *Cat. I (1/9 unit)*

The AS 1000 sequence of courses are designed to introduce students to the United State Air Force and Air Force Reserve Officer Training Corps.

A continuation of AS 1002, the course outlines the origin of the Air Force and the organizational structure of the Air Force with a focus on the missions of select military organizations. The basic history of the United States military is studied in order to appreciate how military history impacts the Air Force today. Written and oral communication skills are practiced.

The course includes one hour of class work and two hours of mandatory leadership laboratory per week. The AS 1003 Leadership Laboratory includes a study of Air Force customs and courtesies, drill and ceremonies, and military commands.

AS 1004. THE FOUNDATIONS OF THE UNITED STATES AIR FORCE IV. *Cat. I (1/9 unit)*

The AS 1000 sequence of courses are designed to introduce students to the United State Air Force and Air Force Reserve Officer Training Corps. The final course in the AS 1000 sequence, it introduces students to the Air Force installation and her sister services. Written and oral communication skills are practiced.

The course includes one hour of class work and two hours of mandatory leadership laboratory per week. The AS 1004 Leadership Laboratory includes a study of Air Force customs and courtesies, drill and ceremonies, and military commands.

AS 2001. THE EVOLUTION OF USAF AIR AND SPACE POWER I. *Cat. I (1/9 unit)*

The AS 2000 sequence of courses are designed to examine general aspects of air and space power through a historical perspective. Utilizing this perspective, the course covers a time period from the first balloons and dirigibles to the space-age global positioning systems of the Persian Gulf War. Historical examples are provided to extrapolate the development of Air Force capabilities (competencies), and missions (functions) to demonstrate the evolution of what has become today's USAF air and space power. As a whole, the AS 2000 sequence of courses provides the student with a knowledge level understanding for the general element and employment of air and space power.

The first course covers the factors leading to the early development of air power through the use of air power during World War II. The development of oral and written communication skills is continued from the AS 1000 classes.

The course includes one hour of class work and two hours of mandatory leadership laboratory per week. The AS 2001 Leadership Laboratory continues a study of Air Force customs and courtesies, drill and ceremonies, military commands, and preparation for Field Training.

AS 2002. THE EVOLUTION OF USAF AIR AND SPACE POWER II. *Cat. I (1/9 unit)*

The AS 2000 sequence of courses are designed to examine general aspects of air and space power through a historical perspective. The second course in the series continues with the development of air power from World War II through the development of the Intercontinental Ballistic Missile.

The course includes one hour of class work and two hours of mandatory leadership laboratory per week. The AS 2002 Leadership Laboratory continues a study of Air Force customs and courtesies, drill and ceremonies, military commands, and preparation for field training.

AS 2003. THE EVOLUTION OF USAF AIR AND SPACE POWER III. *Cat. I (1/9 unit)*

The AS 2000 sequence of courses are designed to examine general aspects of air and space power through a historical perspective. The third course in the series begins with a study of air power in the Vietnam war through the Gulf war. Oral and written communications skills will be practiced.

The course includes one hour of class work and two hours of mandatory leadership laboratory per week. The AS 2003 Leadership Laboratory continues a study of Air Force customs and courtesies, drill and ceremonies, military commands, and preparation for field training.

AS 2004. THE EVOLUTION OF USAF AIR AND SPACE POWER IV.

Cat. I (1/9 unit)

The AS 2000 sequence of courses are designed to examine general aspects of air and space power through a historical perspective. The course examines several fundamental truths associated with war in the third dimension: e.g. Principles of War and Tenets of Air and Space Power. As a whole, this course provides the students with a knowledge level understanding for the general element and employment of air and space power, from an institutional doctrinal and historical perspective. In addition, the students will continue to discuss the importance of the Air Force Core Values with the use of operational examples and historical Air Force leaders and will continue to develop their communication skills. The final course in the series explores the future of the Air Force through 2025.

The course includes one hour of class work and two hours of mandatory leadership laboratory per week. The AS 2004 Leadership Laboratory continues a study of Air Force customs and courtesies, drill and ceremonies, military commands, and preparation for field training.

AS 3001. AIR FORCE LEADERSHIP STUDIES I.

Cat. I (1/6 unit)

The AS 3000 sequence of courses is a study of leadership, management fundamentals, professional knowledge, Air Force personnel and evaluation systems, leadership ethics, and communication skills required of an Air Force junior officer. Throughout the courses, case studies are used to examine Air Force leadership and management situations as a means of demonstrating and exercising practical application of concepts being studied.

The first course explores different styles of leadership, followership, and management functions.

The course includes three hours of class work and three hours of mandatory leadership laboratory per week. The AS 3001 Leadership Laboratory complements the classroom work by providing advanced leadership experiences in officer-type activities and giving students the opportunity to apply leadership and management principles.

AS 3002. AIR FORCE LEADERSHIP STUDIES II.

Cat. I (1/6 unit)

The AS 3000 sequence of courses is a study of leadership, management fundamentals, professional knowledge, Air Force personnel and evaluation systems, leadership ethics, and communication skills required of an Air Force junior officer. The second course studies various aspects of leadership, conflict management, counseling, and supervision.

The course includes three hours of class work and three hours of mandatory leadership laboratory per week. The AS 3002 Leadership Laboratory complements the classroom work by providing advanced leadership experiences in officer-type activities and giving students the opportunity to apply leadership and management principles.

AS 3003. AIR FORCE LEADERSHIP STUDIES III.

Cat. I (1/6 unit)

The AS 3000 sequence of courses is a study of leadership, management fundamentals, professional knowledge, Air Force personnel and evaluation systems, leadership ethics, and communication skills required of an Air Force junior officer. The third course emphasizes teambuilding, improvement process, and military ethics.

The course includes three hours of class work and three hours of mandatory leadership laboratory per week. The AS 3003 Leadership Laboratory complements the classroom work by providing advanced leadership experiences in officer-type activities and giving students the opportunity to apply leadership and management principles.

AS 3004. AIR FORCE LEADERSHIP STUDIES IV.

Cat. I (1/6 unit)

The AS 3000 sequence of courses is a study of leadership, management fundamentals, professional knowledge, Air Force personnel and evaluation systems, leadership ethics, and communication skills required of an Air Force junior officer. The final course explores officer professional development, and personnel and evaluation systems including practical exercises.

The course includes three hours of class work and three hours of mandatory leadership laboratory per week. The AS 3004 Leadership Laboratory complements the classroom work by providing advanced leadership experiences in officer-type activities and giving students the opportunity to apply leadership and management principles.

AS 4101. NATIONAL SECURITY AFFAIRS I.

Cat. I (1/6 unit)

The AS 4000 sequence of courses examines the national security process, regional studies, advanced leadership ethics, and Air Force doctrine. Special topics of interest focus the military as a profession, officership, military justice, civilian control of the military, preparation for active duty and current issues affecting military professionalism. Throughout the AS 4000 sequence of courses, briefing and writing exercises will be accomplished with emphasis on refining communication skills.

The first course examines in depth the national security process, principles of war and the Air Force major commands.

The course includes three hours of class work and three hours of mandatory leadership laboratory each week. The AS 4101 Leadership Laboratory complements the classroom work by providing advanced leadership experiences in officer-like activities and giving the students the opportunity to apply leadership and management principles.

AS 4102. NATIONAL SECURITY AFFAIRS II.

Cat. I (1/6 unit)

The AS 4000 sequence of courses examines the national security process, regional studies, advanced leadership ethics, and Air Force doctrine. The second course provides a detailed examination of Air Force doctrine including a study of the joint doctrine and the roles of the other military services.

The course includes three hours of class work and three hours of mandatory leadership laboratory each week. The AS 4102 Leadership Laboratory complements the classroom work by providing advanced leadership experiences in officer-like activities and giving the students the opportunity to apply leadership and management principles.

AS 4103. NATIONAL SECURITY AFFAIRS III.

Cat. I (1/6 unit)

The AS 4000 sequence of courses examines the national security process, regional studies, advanced leadership ethics, and Air Force doctrine. The third course provides an extensive study of alliances and regional security issues, including international peacekeeping and terrorism. Continued attention is given to developing the research and communications skills required by junior officers.

The course includes three hours of class work and three hours of mandatory leadership laboratory each week. The AS 4103 Leadership Laboratory complements the classroom work by providing advanced leadership experiences in officer-like activities and giving the students the opportunity to apply leadership and management principles.

AS 4104. PREPARATION FOR ACTIVE DUTY.

Cat. I (1/6 unit)

The AS 4000 sequence of courses examines the national security process, regional studies, advanced leadership ethics, and Air Force doctrine. The final course in the series examines officership, the military justice system, social responsibilities, current issues affecting the military profession, and various factors that will facilitate a smooth transition from civilian to military life.

The course includes three hours of class work and three hours of mandatory leadership laboratory each week. The AS 4104 Leadership Laboratory complements the classroom work by providing advanced leadership experiences in officer-like activities and giving the students the opportunity to apply leadership and management principles.

BASIC SCIENCES

GEOSCIENCES (GE)

GE 2341. GEOLOGY.

Cat. I

Students of this course will examine the fundamental principles of physical geology including the materials, structures, and surface features of the earth and the processes which produced them. Emphasis will be placed on the interrelationship of people and environment and applications to various fields of technology. The course includes field trips and a significant laboratory component.

BIOLOGY AND BIOTECHNOLOGY

BB 1001. INTRODUCTION TO BIOLOGY.

Cat. I

This course consists of an overview of the major concepts of Biology, including: cell theory, bioenergetics, molecular biology, reproduction, nutrition, growth, development, homeostatic controls, and ecological issues. This course is intended for students seeking a broad overview of contemporary Biology with emphasis on human issues and current topics.

Recommended background: high school or introductory college level chemistry.

BB 1002. ENVIRONMENTAL BIOLOGY.

Cat. I

This course provides an introduction to natural ecosystems, population growth, and the interaction between human populations and our environment. Major areas of discussion include Ecosystems, Populations, Biodiversity, Pollution, and Environmental Economics. This course is designed for students seeking a broad overview of ecological systems and the effect of humans on the ecosystems.

Recommended background: High School biology.

BB 1035 INTRODUCTION TO BIOTECHNOLOGY*Cat. I*

Current topics and issues in Biotechnology will be investigated. Some examples of topics which may be investigated in detail include: cloning, DNA fingerprinting and molecular forensics, transgenic organisms, "green" engineering and bioremediation, bioprocess and metabolite engineering, bioinformatics, and mathematical modeling of biological systems.

Recommended background: high school biology and chemistry.

BB 1045 BIODIVERSITY*Cat. I*

This course is an integrated survey of the plant and animal kingdoms which stresses general concepts and economically important species. Particular attention will be paid to special structures and mechanisms evolved by selected representatives of major phyla of plants and animals for solving problems of life in various environments.

Recommended background: high school biology or equivalent.

BB 2002. MICROBIOLOGY.*Cat. I*

This course will focus on unicellular organisms with special reference to those of the kingdom Bacteria, and describe their taxonomy, morphology, and physiology. Special attention will be given to those organisms that are of ecological concern or serve a useful industrial purpose. The importance of microbes and viruses in public health will be presented. This course is designed for all biology majors and other students who seek a good general education in modern biology.

Recommended background: A basic understanding of cell biology and elementary biochemical processes is desired.

BB 2030. PLANT DIVERSITY.*Cat. I*

An introductory course stressing general concepts related to the vast array of plant species, taxonomic links, and uses of major plant phyla in both society and industry. Some emphasis will be given to economically important species chosen from agronomic and non-agronomic situations.

Recommended background: BB 1045.

Students may not receive credit for both BB 2030 and BB 1040.

BB 2040. PRINCIPLES OF ECOLOGY.*Cat. I*

This course is designed to give the student a basis for understanding the abundance and distribution of plants and animals from the level of the individual to that of the ecosystem. Topics may include population ecology, competition, community ecology, patterns of species diversity, and energy flow.

Recommended background: BB 1045, and MA 1021-1022.

BB 2550. CELL BIOLOGY.*Cat. I*

This entry level course, recommended for all BIO, BC, and pre-professional majors, presents the fundamental aspects of cell structure and function, and is the foundation of all fields of modern biology.

Topics include: cell complexity and organizational hierarchy, evolution of the cell, cell surface, plasma membrane, single and double cytoplasmic membrane systems, nuclear fusion and hybridomas, cytoskeleton, cell growth, and differentiation.

Recommended background: BB 1001, BB 1035, or equivalent.

BB 2920. GENETICS.*Cat. I*

This course presents the principles and experimental evidence leading to our understanding of the gene concept and the role of DNA as genetic material. Patterns of inheritance, the relationship between genotype and phenotype, and transmission, coding, and expression of genetic information are considered in a variety of organisms. A quantitative, problem-solving approach and the use of genetic analysis as a tool to study biological phenomena are emphasized throughout the course. The course is designed for all biology and pre-professional majors.

Recommended background: BB 1035.

BB 3040. EXPERIMENTAL DESIGN AND DATA ANALYSIS.*Cat. II*

This applied course introduces students to the design of experiments and analysis of data. We will cover a number of experimental situations occurring frequently in biology, including testing the fit of data to theoretical distributions, comparisons of groups, and regression analysis. Emphasis will be placed on formulating the hypothesis of interest, designing experiments so that the subsequent analysis will have enough power to test the hypothesis, and choosing the appropriate analysis to perform. We will discuss the importance of pilot studies, and some of the most common errors made in choosing and performing statistical tests. Both parametric and non-parametric tests will be discussed. Students will use computer packages to analyze data from the literature and/or their own experimental data.

Recommended background: MA 2611, and any 3000 or 4000 level BB course.

Offered in 2007-08 and in alternating years thereafter.

Note: Students who have credit for BB 4040 may not receive credit for BB 3040.

BB 3055. MICROBIAL PHYSIOLOGY.*Cat. I*

This course will focus on the metabolic (enzymatic) pathways by which microorganisms obtain, process, and store substances and energy used for synthesis; and on the synthetic pathways by which these substances and energy are utilized. The occurrence of biological reactions in the light of the particular organism and its environment will be emphasized, as will those organisms and metabolic schemes of current or potential usefulness in bioprocess technology.

Recommended background: BB 2002, BB 2550.

Students who have taken BB 4050 for credit will not receive credit for BB 3055.

BB 3080. NEUROBIOLOGY.*Cat. I*

An introduction to neurobiology, with emphasis on the cellular and molecular basis of neural development and function. Topics will range from electrical and biochemical signaling between neurons, to higher order functions of the nervous system, such as sensation, movement, and memory. Human neurological diseases and disorders will be discussed. Some guided reading of the primary literature will be included.

Recommended background: BB 2550, BB 2920, and BB 3101.

Students may not receive credit for both BB 4080 and BB 3080.

BB 3101. HUMAN ANATOMY & PHYSIOLOGY: MOVEMENT AND COMMUNICATION.*Cat. I*

The form and function of the systems that are responsible for the support, movement, internal communication, and interaction of the human body with its environment will be presented and discussed: Integumentary, Skeletal, Muscular, Nervous (including the senses), and Endocrine.

Recommended background: BB 2550 Cell Biology or BB 1001, Introduction to Biology. Suggested background: Concurrent Laboratory Module: BB 3511 (Nerve and Muscle Physiology). Students who have received credit for BB2130 (Human Anatomy) may not take BB3101 for credit.

BB 3102. HUMAN ANATOMY & PHYSIOLOGY: TRANSPORT AND MAINTENANCE.*Cat. I*

The form and function of the systems of the human body that provide for the intake, distribution, and processing of nutrients, water, and oxygen, and the systems that safeguard health by elimination of wastes, regulation of metabolism, and surveillance against disease will be presented and discussed. Digestive, Respiratory, Circulatory, Lymphatic, Endocrine, Urinary, and Reproductive.

Recommended Background: BB 2550 (Cell Biology); either BB 1001 (Introduction to Biology) or BB 1035 (Introduction to Biotechnology); CH 1010 and CH 1020 (General Chemistry). Suggested background: Concurrent Laboratory Module: BB 3514 (Circulatory and Respiratory Physiology). Students who have received credit for BB3110 (Animal Physiology) may not take BB 3102 for credit.

BB 3120. PLANT PHYSIOLOGY AND CELL CULTURE.*Cat. I*

The relationship of structure and function of multicellular plants will be examined at the biochemical level. Topics include (but are not limited to): water relations, mineral nutrition, intra- and inter-cellular transport, hormones, photosynthesis, in vitro culture of plant cells/tissues/organs, and environmental responses.

Recommended background: BB 1045, BB 2550, CH 1020.

BB 3140. EVOLUTION: PATTERN AND PROCESS.*Cat. II*

We will explore several theoretical constructs of evolutionary processes. Topics will range from microevolutionary patterns to global extinctions and speciation. We will examine the causes of evolutionary trends from the molecular to the group level. Readings from current research into the units and levels of selection will be included.

Recommended background: BB 2550, BB 2920, at least one of (BB 1045, BB 2040).

This course will be offered in 2007-08 and in alternating years thereafter.

BB 3160. BEHAVIORAL ECOLOGY.*Cat. I*

This course will deal with the interface among the fields of animal behavior, ecology, and evolution. Adaptive advantage (or disadvantage) conferred by behaviors at the individual and social level will be studied. Topics will include individual decision-making in response to the environment, cooperation and conflict among individuals, kin selection, parental investment theory, sexual and natural selection and the evolution of social behavior, and sensory systems and the design of signals.

Recommended background: BB 1045, BB 2040, BB 3140.

BB 3170. PLANT MORPHOLOGY AND DEVELOPMENT.*Cat. II*

This course will focus on the form and function of developing plant structures. Beginning with the unique aspects of plant cells, the course will progress to include tissue and organ anatomy and will cover the phenomena responsible for defining the gross morphology of the organism. Coverage of these topics will culminate in an understanding of the integrated development of the whole plant. Some guided reading of the primary literature will be included.

Recommended background: BB 2030 and BB 2550.

This course will be offered in 2007-08 and in alternating years thereafter.

BB 3620. DEVELOPMENTAL BIOLOGY.*Cat. II*

This advanced level course provides a detailed survey of the processes of animal development, including fertilization, cleavage, gastrulation, and organogenesis. These processes are examined in the context of concepts such as differentiation, determination, induction, intercellular signaling, morphogenesis, and pattern formation. Emphasis is placed on current techniques for studying development, such as genetic analysis of mutations, recombinant DNA technology, molecular probing of gene expression, and gene transfer. The experimental focus is on model organisms such as nematodes, fruit flies, frogs, and mice.

Offered in 2007-08 and in alternating years thereafter.
Recommended background: BB 2002, BB 2550, BB 2920.

BB 3920. IMMUNOLOGY.*Cat. I*

This is a survey course in immunology which assumes a background in cell biology, genetics and biochemistry. Topics to be covered will include cells of the immune system, antigen/antibody immunochemistry, immunogenetics and immune responses. Readings from research literature will be assigned.

Recommended background: BB 2550, BB 2920, CH 4110, and CH 4120.

BB 4008. CELL CULTURE THEORY AND APPLICATIONS.*Cat. I*

The use of cultured animal cell systems for research and production will be explored. Concepts, including media design, the effects of extracellular matrices, scaling up of cell cultures, and biochemical and morphologic assessment of cell function, will be discussed as a basis for readings from the literature.

Recommended background: BB 2550, BB 2920, CH 4110, and CH 4120.
Students who have received credit for BB 4007 may not take BB 4008 for credit.

BB 4010. ADVANCED MOLECULAR GENETICS.*Cat. I*

Topics in molecular genetics are presented using microbial systems as models. The structure, function and synthesis of DNA and the results of mutation, recombination and repair are emphasized. Simple bacteria and their plasmids, transposable elements and phages are discussed as experimental models.

Recommended background: BB 2002, BB 2550, BB 2920, BB 4910.

BB 4065. VIROLOGY.*Cat. I*

This advanced-level course uses a seminar format based on research articles to discuss current topics related to the molecular/cell biology of viral structure, function, and evolution. Particular emphasis is placed on pathological mechanisms of various human disorders, especially emerging diseases, and the use of viruses in research.

Recommended background: BB 2550.

BB 4070. SEPARATION OF BIOLOGICAL MOLECULES.*Cat. I*

This course provides a detailed survey of state-of-the-art methods employed by the biotechnology industry for the purification of products, proteins in particular, from fermentation processes. Focus is on methods which offer the best potential for scale-up. Included are the theory of the design as well as the operation of these methods at the laboratory scale. It is intended for biology/biotechnology majors, chemical engineering and biochemistry students.

Recommended background: knowledge of the topics in CH 4110 and CH 4120.
Students who have received credit for BB 4060 may not take BB 4070 for credit.

BB 4160. POPULATION GENETICS AND PHYLOGEOGRAPHY.*Cat. II*

In this course we will explore how evolutionary and geographic processes contribute to the diversity of organisms. Topics will include gene flow and population structure, empirical measures of genetic variation, the roles of genetic drift and natural selection in population genetics, theoretical modes of speciation, species concepts and definitions, and molecular phylogenetics. The course will be presented in a combination of lecture and seminar format, with readings from texts and the primary literature.

Recommended background: BB 2040, BB 2920, BB 3140, and MA 1021-1022.
This course will be offered in 2006-07 and in alternating years thereafter.

BB 4170. MOLECULAR ECOLOGY.*Cat. II*

This course will emphasize the application of molecular genetic techniques to basic and applied research in ecology. The format for this course will be primarily reading- and writing-intensive seminar, with student-led study and discussion of cutting-edge primary literature. A strong background in both molecular genetics and ecology is recommended. Topics may include the use of genetic markers for studies of social evolution, molecular population genetics and phylogeography, conservation genetics, and the ecological impacts of biotechnology.

Recommended background: BB 2040, BB 2920, BB 4010 and BB 4060.
This course will be offered in 2007-08 and in alternating years thereafter.

BB 4550. ADVANCED CELL BIOLOGY.*Cat. I*

This advanced-level course uses a seminar format based on research articles to discuss current topics related to the molecular biology of cellular function. Particular emphasis is placed on biological mechanisms of autoimmune disorders, cancer, Alzheimers disease, thrombosis, haemostasis, neurotropic factors, and gene therapy.

Recommended background: BB 2550.

BB 4910. ADVANCED MOLECULAR BIOLOGY.*Cat. I*

This advanced level course explores the molecular mechanisms by which cells use genetic information to produce RNAs and proteins. Mechanisms and regulation of transcription in both prokaryotes and eukaryotes will be studied with an emphasis on protein-protein and protein-DNA interactions. The structure, organization, evolution and expression of the eukaryotic genome will be emphasized. This course is intended for students who seek an in-depth understanding of gene function.

Recommended background: BB 2550, BB 2920, BB 4955, CH 4110, 4120 and 4130.

BB 4955. RECOMBINANT DNA PRINCIPLES AND APPLICATIONS.*Cat. I*

This course surveys both theory and applications in recombinant DNA methodology. Topics covered include enzymology of DNA manipulation; construction and isolation of recombinants; plasmid and bacteriophage vectors; structural analysis of cloned DNA.

Recommended background: prior knowledge of BB 2002, BB 2550, BB 2920, BB 4010, and basic molecular biology will be assumed.

IS4 BB. SPECIAL TOPICS.*Cat. I*

Experimental courses, special conferences and seminars are offered by advance arrangement only.

BIOLOGY AND BIOTECHNOLOGY LAB COURSES

BB 2901. MOLECULAR BIOLOGY, MICROBIOLOGY, AND GENETICS*Cat. I (1/6 unit)*

The lab exercises in this course are designed to provide foundation skills needed for the study of living organisms and systems at the both the organismal and molecular scales. Students will gain experience with procedures, equipment, techniques and skills common to all areas of biology. In particular this course will focus on:

The use and identification of bacteria in the laboratory
Handling- Restriction digestion- and visualization- of DNA
Plasmid purification and cloning
Examples of classic genetics

Recommended background: One or more 1000/2000 BB courses

BB 2902. ENZYMES, PROTEINS, AND PURIFICATION*Cat. I (1/6 unit)*

The lab exercises in this course are designed to provide foundation skills needed for the study of living organisms and systems at the both the organismal and molecular scales. Students will gain experience with procedures, equipment, techniques and skills common to all areas of biology. In particular this course will focus on:

The action and optima of enzyme action
Quantification and detection techniques for proteins
Extraction and purification of protein from biological material

Recommended background: One or more 1000/2000 BB courses

BB 2903. ANATOMY AND PHYSIOLOGY*Cat. I (1/6 unit)*

The lab exercises in this course are designed to provide foundation skills needed for the study of living organisms and systems at the both the organismal and molecular scales. Students will gain experience with procedures, equipment, techniques and skills common to all areas of biology. In particular this course will focus on:

Comparative and general anatomy of several organisms
Physiology and function of body systems, processes and organs.

Recommended background: One or more 1000/2000 BB courses

BB 2904. ECOLOGY, ENVIRONMENT, AND ANIMAL BEHAVIOR*Cat. I (1/6 unit)*

The lab exercises in this course are designed to provide foundation skills needed for the study of living organisms and systems at the both the organismal and molecular scales. Students will gain experience with procedures, equipment, techniques and skills common to all areas of biology. In particular this course will focus on:

Observing, recording, understanding, and analyzing animal behaviors
Environmental and Ecological assessment and sampling
Observations of population dynamics

Recommended background: One or more 1000/2000 BB courses

BB 3511. NERVE AND MUSCLE PHYSIOLOGY.*Cat. I (1/6 unit)*

Computer and laboratory studies of nerve and muscle function.

Recommended background: BB 2940, or BB 2903.

Concurrent or prior registration in BB 3101 is recommended.

BB 3512. MOLECULAR GENETICS LAB.*Cat. I (1/6 unit)*

The topic of gene therapy will be used to familiarize the student with computer manipulations of biological sequence information.

Recommended background: BB 2920, BB 2550 and BB 4910/CH 4130.

BB 3513. CELL CULTURE TECHNIQUES FOR ANIMAL CELLS.*Cat. I (1/6 unit)*

Basic laboratory skills in mammalian cell culture to include cell counting, freezing and thawing cell lines, culture of suspension and attached cells.

Recommended background: BB 2940 or BB 2901, BB 2550 and knowledge of aseptic techniques.

Concurrent or prior registration in BB 4008 is recommended.

BB 3514. CIRCULATORY AND RESPIRATORY PHYSIOLOGY.*Cat. I (1/6 unit)*

Computer and laboratory studies of circulatory and respiratory physiology.

Recommended background: BB 2940, or BB 2903.

Concurrent or prior registration in BB 3102 is recommended.

BB 3516. SEPARATION TECHNIQUES IN BIOTECHNOLOGY.*Cat. I (1/6 unit)*

A laboratory course in chromatographic and electrophoretic separation of proteins; plasmid isolation, restriction digestion and electrophoretic separation of DNA.

Recommended background: BB 2940, or BB 2902.

Concurrent or prior registration in Biochemistry (CH 4110) and BB 4910 is recommended.

BB 3517. FERMENTATION.*Cat. I (1/6 unit)*

An introductory laboratory course in basic fermentation techniques.

Recommended background: BB 2940 or BB 2901, BB 2002, or knowledge of aseptic techniques.

Concurrent or prior registration in BB 3055 is suggested.

BB 3518. MOLECULAR BIOLOGY.*Cat. I (1/6 unit)*

Laboratory investigations of select molecular characteristics of proteins and DNA.

Recommended background: BB 2940 or BB 2901, BB 2550, and CH 4110.

Concurrent, or prior registration in BB 4910 or CH 4130 is recommended.

BB 3519. PROTEIN PURIFICATION.*Cat. I (1/6 unit)*

A laboratory course in protein purification techniques.

Recommended background: BB 2940 or BB 2902, CH 4110.

Concurrent or prior registration in BB 4070 is recommended.

BB 3520. RECOMBINANT DNA TECHNOLOGY.*Cat. I (1/6 unit)*

A laboratory course in the construction, isolation and mapping of recombinants, and use of the polymerase chain reaction.

Recommended background: BB 2940 or BB 2901, BB 2550, CH 4110 and BB 4910.

Concurrent or prior registration in BB 4955 is recommended.

BB 3521. MICROSCOPY.*Cat. I (1/6 unit)*

A laboratory course in the theory and operation of light and electron microscopes, including specimen preparation, operation of equipment, and microphotography.

Recommended background: BB 2940 or BB 2901, and BB 2550.

BB 3522. TRANSMISSION ELECTRON MICROSCOPY.*Cat. I (1/6 unit)*

This laboratory module will provide the student with the basic theory and practice of transmission electron microscopy. The course will include sample handling and preparation methods, use of the TEM, and photographic recording of observations made with the instrument.

Recommended background: BB 1001 or BB 2550, and BB 2940 or BB 2950 or BB 2901 or BB 2903.

BB 3524. BIOINFORMATICS LAB.*Cat. I (1/6 unit)*

Laboratory course investigating some of the basic tools currently available for sequence data mining, comparison of nucleotide and/or protein sequences, and the analysis of nucleotide and protein sequences. Course will be primarily computer based, but may have a small wet lab component.

Recommended background: BB2920, BB2901, and CH4110.

Concurrent or prior registration in BB4910 or CH4130 is recommended. Students who have received credit for BB324X may not receive credit for BB3524.

BB 3525. PLANT PHYSIOLOGY.*Cat. I (1/6 unit)*

Basic studies in the biochemical and physical systems plants use to sustain life; includes an introduction to plant cell culture techniques.

Recommended background: BB1045 and BB2903.

Concurrent or prior registration in BB3120 is recommended. Students who have received credit for BB 325X may not receive credit for BB3525.

Graduate Biology and Biotechnology Courses of Interest to Undergraduates

The following courses are open to advanced undergraduates with special written permission of the course instructor and department head.

BB 501. SEMINAR.**BB 509. SCALE-UP OF BIOPROCESSING.**

Strategies for optimization of bioprocesses for scale-up applications. In addition to the theory of scaling up unit operations in bioprocessing, students will scale-up a bench scale bioprocess (5 liters) including fermentation and downstream processing to 55 liters. Specific topics include the effects of scaling-up on: mass transfer and bioreactor design, harvesting techniques including tangential flow filtration and centrifugation, and chromatography (open column and HPLC).

Recommended courses include BB 3055 Microbial Physiology and BB 4070/560 Separations of Biological Molecules, as a working knowledge of the bench scale processes will be assumed. Otherwise, instructor permission is required.

BB 542. ECOLOGICAL SIMULATION MODELING.

This course will cover computer simulation modeling of populations, bioenergetics, behavior of individuals, and ecosystem dynamics. Modeling techniques covered will range from simple linear models of populations and interactions between ecosystem components to individual-based models of populations in complex environments. Students successfully completing the course should be capable of understanding models used in today's study of populations and ecosystems and of developing original models. Knowledge of a programming language is assumed.

BB 560. SEPARATION OF BIOLOGICAL MOLECULES.

This course provides a detailed hands-on survey of state-of-the-art methods employed by the biotechnology industry for the purification of products, proteins in particular, from fermentation processes. Focus is on methods which offer the best potential for scale-up. Included are the theory of the design as well as the operation of these methods both at the laboratory scale as well as scaled up. It is intended for biology, biotechnology, chemical engineering, and biochemistry students. A knowledge of basic biochemistry is assumed.

BB 565. VIROLOGY.

This advanced-level course uses a seminar format based on research articles to discuss current topics related to the molecular/cell biology of viral structure, function, and evolution. Particular emphasis is placed on pathological mechanisms of various human disorders, especially emerging diseases, and the use of viruses in research.

BB 570. SPECIAL TOPICS.

Specialty subjects are offered using the research expertise of the department faculty. Content and format varies to suit the interest and needs of the faculty and students. This course may be repeated for different topics covered.

BB575 ADVANCED GENETICS & CELL BIOLOGY

Topics in this course focus on the basic building blocks of life; molecules, genes and cells. The course will address areas of the organization, structure, function and analysis, of the genome and of cells. Required Background: Students in the course should be familiar with the fundamentals of recombinant DNA and molecular biological techniques as well as cell biology.

BB576 ADVANCED INTEGRATIVE BIOSCIENCE

This course concentrates on the organization of cells into biological systems and into individual organisms. Discussion will center on the development and function of specific model systems such as the nervous and immune systems. Required background: Students in the course should be familiar with the fundamentals of developmental biology, genetics and cell biology.

BB577 ADVANCED ECOLOGICAL & EVOLUTIONARY BIOSCIENCE

This course will explore the organization of individuals into communities, and the evolution of individual traits and behaviors. Problems discussed will range from those of population harvesting and the effect humans have on the environment to the evolution of disadvantageous traits. Required background: Students should be familiar with fundamentals of population interactions, evolution and animal behavior.

BB578 ADVANCED APPLIED BIOTECHNOLOGY

This course examines the use of biotechnological advances towards solving real world problems. Students will discuss problem-solving strategies from the current literature in the areas of medicine, agriculture, environmental protection/restoration and industrial biotechnology. Required background: Students should be familiar with biochemistry, microbiology, and plant and animal physiology.

BIOMEDICAL ENGINEERING

The second digit for Biomedical Engineering course numbers is coded as follows:

- 0 — Bioinstrumentation, Biosignals, Introduction
- 1 — Physiology
- 2 — Bioelectric, Bioimaging
- 3 — Design
- 5 — Biomechanics, Biological Systems
- 6 — Biofluids
- 8 — Biomaterials

NOTE: Courses listed in previous catalogs with "BE" as the prefix and the same course number as below are considered to be the SAME COURSE.

BME 1001. INTRODUCTION TO BIOMEDICAL ENGINEERING.

Cat. I

Lectures, demonstrations, hands-on experimentation, and scientific literature readings in the major branches of biomedical engineering. A series of laboratory demonstration/experiments are utilized to complement key concepts covered in various lectures.

BME/ECE 2204. BIOELECTRIC FOUNDATIONS.

Cat. I

An introduction to the origins and characteristics of the electric and electromagnetic signals that arise in biological tissues. Topics include the behavior of excitable cells and tissues, the intrinsic electrical and magnetic properties of biological tissues, and the response of excitable cells to electric and magnetic field stimulation. Laboratory projects include the measurement of bioelectric signals (EMG, EKG, EEG, EOG, and evoked response) and the fundamentals of data acquisition, analysis, and statistics. The principles of writing and maintaining a laboratory notebook are also developed and used.

Recommended background: BB 2550 or equivalent, PH 1120 or PH 1121.

Students who have received credit for BME 4101 may not receive credit for BME 2204.

BME 2504. FOUNDATIONS IN BIOMECHANICS.

Cat. I

This course is an introduction to the analysis of the musculoskeletal systems using principles of engineering mechanics. Basic principles of mechanics, stress, strain and deformation in beams are presented and used to characterize the material properties of tissues such as skin, tendon, ligament, bone and cartilage. Principles of biomechanics are also applied to the design of medical devices and bioengineered tissues. Topics include forces, moments of forces, free body diagrams, principal stresses, transverse shear stresses and beam loading.

Recommended background: BB 2550 or equivalent, MA 2051, PH 1110 or PH 1111.

Students who have previously received credit for BME 4504 may not receive credit for BME 2504.

BME 2604. FOUNDATIONS IN BIOLOGICAL TRANSPORT PHENOMENA.

Cat. I

This course is an introduction to the analysis of complex biological systems using principles of transport phenomena. Basic theories of momentum transport, mass transport and energy transport are presented and applied to cellular and mammalian physiology. Principles of transport phenomena are also applied to the design of medical devices and bioengineered tissues. Topics include differential and integral balances, rheology of Newtonian and non-Newtonian fluids, diffusion in reacting systems and homogeneous vs. heterogeneous reaction systems.

Recommended background: BB 2550 or equivalent, MA 2051, PH 1110 or PH 1111.

Students who have received credit for BME 3101 may not receive credit for BME 2604.

BME/ECE 3011. BIOINSTRUMENTATION AND BIOSENSORS.

Cat. I

A study of the basic principles of biomedical electronics and measurement with emphasis on the operational performance and selection of transducers, instruments and systems for biomedical data acquisition and processing. Biopotential electrodes. Analysis and selection of physical, optical, electrical, mechanical, thermal transduction mechanisms which form the basis of the sensor design. Clinical laboratory instrumentation. Electrical safety problems in the clinical environment.

Recommended background: MA 2051, ECE 3601, or equivalent.

BME 3300. BIOMEDICAL ENGINEERING DESIGN.

Cat. I

Students are guided through the open-ended, real-world, design process starting with the project definition, specification development, management, team interactions and communication, failure and safety criteria, progress reporting, marketing concepts, documentation and technical presentation of the final project outcome. The course will include a significant writing component, will make use of computers, and hands-on design explorations.

Students who have previously received credit for BME 2300 may not receive credit for BME 3300.

BME/ECE 4011. BIOMEDICAL SIGNAL ANALYSIS.

Cat. II

Introduction to biomedical signal processing and analysis. Fundamental techniques to analyze and process signals that originate from biological sources: ECGs, EMGs, EEGs, blood pressure signals, etc. Course integrates physiological knowledge with the information useful for physiologic investigation and medical diagnosis and processing. Biomedical signal characterization, time domain analysis techniques (transfer functions, convolution, auto- and cross-correlation), frequency domain (Fourier analysis), continuous and discrete signals, deterministic and stochastic signal analysis methods. Analog and digital filtering.

Recommended background: ECE 2311, ECE 2312, BME 3011, or equivalent.

This course will be offered in 2006-07, and in alternating years thereafter.

BME/ECE 4023. BIOMEDICAL INSTRUMENTATION DESIGN I.

Cat. II

This course builds on the fundamental knowledge of bioinstrumentation and biosensors presented in BME 3011. Lectures and hands-on laboratory experiments cover the principles of designing, building and testing analog instruments to measure biological events. Design laboratories will include biopotential amplifiers and biosensor/bioinstrumentation systems for the measurement of physiological parameters.

Recommended background: BME 2204, and BME 3011.

This course will be offered in the 2006-07 academic year and in alternating years thereafter.

BME 4025. BIOMEDICAL INSTRUMENTATION DESIGN II.

Cat. II

This course builds on the fundamental knowledge of bioinstrumentation and biosensors presented in BME3011. Lectures and hands-on laboratory experiments cover the principles of biosensor interfacing, low-level measurements, analog-to-digital and digital-to-analog signal conversion, microprocessor and microcontroller based biomedical instrumentation, and programming.

Recommended background: BME 2204, and BME 3011.

This course will be offered in the 2007-08 academic year and in alternating years thereafter.

BME/ECE 4201. BIOMEDICAL IMAGING.

Cat. II

This course is a practical introduction to biomedical image processing using examples from various branches of medical imaging. Topics include: point operations, filtering in the image and Fourier domains, image reconstruction in computed tomography and magnetic resonance imaging, and data analysis using image segmentation. Review of linear-systems theory and the relevant principles of physics. Course work uses examples from microscopy, computed tomography, X-ray radiography, and magnetic resonance imaging. A working knowledge of undergraduate signal analysis and linear algebra is desirable. Facility with a high-level programming language is recommended.

The course will be offered in 2006-07, and in alternating years thereafter.

BME/ME 4504. BIOMECHANICS.

Cat. II

This course emphasizes the applications of mechanics to describe the material properties of living tissues. It is concerned with the description and measurements of these properties as related to their physiological functions. Emphasis on the interrelationship between biomechanics and physiology in medicine, surgery, body injury and prostheses.

Topics covered include: Review of basic mechanics, stress, strain, constitutive equations and the field equations, viscoelastic behavior, and models of material behavior. The measurement and characterization of properties of tendons, skin, muscles and bone. Biomechanics as related to body injury and the design of prosthetic devices.

Recommended background: Mechanics (ES 2501, ES 2502, ME 3501), Mathematics (MA 2051).

This course will be offered in 2007-08, and in alternating years thereafter.

BME 4541. BIOLOGICAL SYSTEMS.

Cat. II

Review of control theory with applications to biological control systems. Analysis and modeling of physiological systems. Physiological systems identification. Formulation of mathematical models of biological systems and the application of computer techniques in the simulation of these systems. Recommended background: Laplace transforms, transient response, frequency response and system stability analysis.

This course will be offered in 2007-08, and in alternating years thereafter.

BME/ME 4606. BIOFLUIDS.*Cat. II*

This course emphasizes the applications of fluid mechanics to biological problems. The course concentrates primarily on the human circulatory and respiratory systems. Topics covered include: blood flow in the heart, arteries, veins and microcirculation and air flow in the lungs and airways. Mass transfer across the walls of these systems is also presented.

Recommended background: ME 3501 and fluid mechanics equivalent to ES 3004. This course will be offered in 2006-07, and in alternating years thereafter.

BME/ME 4814. BIOMATERIALS.*Cat. I*

A course discusses various aspects pertaining to the selection, processing, testing (in vitro and in vivo) and performance of biomedical materials. The biocompatibility and surgical applicability of metallic, polymeric and ceramic implants and prosthetic devices are discussed. The physico-chemical interactions between the implant material and the physiological environment will be described. The use of biomaterials in maxillofacial, orthopedic, dental, ophthalmic and neuromuscular applications is presented.

Recommended background: BB 3130 or equivalent introduction to Human Anatomy, ES 2001 or equivalent introduction to Materials Science and Engineering.

BME 4828. BIOMATERIALS-TISSUE INTERACTIONS*Cat. I*

This course examines the principles of materials science and cell biology underlying the design of medical devices, artificial organs and scaffolds for tissue engineering. Molecular and cellular interactions with biomaterials are analyzed in terms of cellular processes such as matrix synthesis, degradation and contraction. Principles of wound healing and tissue remodeling are used to study biological responses to implanted materials and devices. Case studies will be analyzed to compare tissue responses to intact, bioresorbable and bioerodible biomaterials. Additionally, this course will examine criteria for restoring physiological function of tissue and organs and investigate strategies to design implants and prostheses based on control of biomaterial-tissue interactions.

Recommended background: BME 2604, BB 2550 or equivalent, ES 2001 or equivalent, PH 1110 or PH 1111.

Graduate Biomedical Engineering Courses of Interest to Undergraduates

BME 523. BIOMEDICAL INSTRUMENTATION.

Origins and characteristics of bioelectric signals, recording electrodes, amplifiers, chemical pressure and flow transducers, noninvasive monitoring techniques, and electrical safety. (Prerequisite: Circuits and electronics, control engineering or equivalent.)

BME 525. MICROPROCESSOR-BASED BIOMEDICAL INSTRUMENTATION.

This course provides hands-on laboratory experience with common biomedical transducers and instrumentation used in physiological and clinical evaluation. Lectures and laboratory experiments cover electronic circuit design and construction, analog/digital signal acquisition and processing, and microprocessor-based biomedical instrumentation. The basic principles of hardware and software designs for interfacing biomedical sensors to a general purpose IBM-PC are emphasized. (Prerequisite: Analog and digital electronics.)

BME 541. BIOLOGICAL SYSTEMS.

Review of control theory with applications to biological control systems. Development of mathematical models of selected biological control systems and the application of computer techniques in the simulation of these systems.

BME/ME 550. TISSUE ENGINEERING.

This biomaterials course focuses on the selection, processing, testing and performance of materials used in biomedical applications with special emphasis upon tissue engineering. Topics include: material selection and processing, mechanisms and kinetics of material degradation, cell-material interactions and interfaces; effect of construct architecture on tissue growth; and transport through engineered tissues. Examples of engineering tissues for replacing cartilage, bone, tendons, ligaments, skin and liver will be presented. (Recommended preparation: A first course in biomaterials equivalent to BME/ME 4814 and a basic understanding of physiology and cell biology.)

BME 551. BIOLOGICAL SIGNAL PROCESSING.

Basic principles of digital processing of biological signals, and its application on PC-compatible computers. The theoretical fundamentals and practical examples of signal processing. The major emphasis is on linking the theoretical knowledge with easy to comprehend practical examples. (Prerequisites: Basic signal analysis.)

BME/ME 552. TISSUE MECHANICS.

This biomechanical course focuses on advanced techniques for the characterization of the structure and function of hard and soft tissues and their relationship to physiologic processes. Applications include: tissue injury, wound healing, the effect of pathological conditions upon tissue properties and design of medical devices and prostheses. (Recommended preparation: A first course in biomechanics equivalent to BME/ME 4504.)

BME/ME 554. COMPOSITES WITH BIOMEDICAL AND MATERIALS APPLICATIONS.

Introduction to fiber/particulate reinforced, engineered and biologic materials. This course focuses on the elastic description and application of materials that are made up of a combination of submaterials, i.e., composites. Emphasis will be placed on the development of constitutive equations that define the mechanical behavior of a number of applications, including: biomaterial, tissue, and materials science. (Prerequisites: understanding of stress analysis and basic continuum mechanics.)

BME/ME 558. BIOFLUIDS AND BIOTRANSPORT.

The emphasis of this course is on modeling fluid flow within the cardiovascular and pulmonary systems and the transport processes that take place in these systems. Applications include artificial heart valves, atherosclerosis, arterial impedance matching, clinical diagnosis, respiration, aerosol and particle deposition. Depending upon class interest, additional topics may include: reproductive fluids, animal propulsion in air and water and viscoelastic testing. (Recommended preparation: A first course in biofluids equivalent to BME/ME 4606.)

BME 560. PHYSIOLOGY FOR ENGINEERS.

An introduction to fundamental principles in cell biology and physiology designed to provide the necessary background for advanced work in biomedical engineering. Quantitative methods of engineering and the physical sciences are stressed. Topics include cell biology, DNA technology, and the physiology of major organ systems.

NOTE: This course can be used to satisfy a life science requirement in the biomedical engineering program. It cannot be used to satisfy a biomedical engineering course requirement.

BME 562. LABORATORY ANIMAL SURGERY.

A study of anesthesia, surgical techniques, and postoperative care in small laboratory animals. Anatomy and physiology of species used included as needed. Class limited to 15 students. Approximately 15 surgical exercises are performed by each student.

NOTE: This course can be used to satisfy a life science requirement in the biomedical engineering program. It cannot be used to satisfy a biomedical engineering course requirement.

BME 570. ENGINEERING IN THE CLINICAL ENVIRONMENT.

Examines the responsibilities and functions of the biomedical engineer in the health care complex in the solution of the technical and engineering problems associated with patient care. Topics include equipment management, monitoring systems, electrical safety, prosthetics, technical education for medical personnel, hospital systems engineering, and administrative functions.

BME 581. MEDICAL IMAGING SYSTEMS.

Overview of the physics of medical image analysis. Topics covered include X-Ray tubes, fluoroscopic screens, image intensifiers; nuclear medicine; ultrasound; computer tomography; nuclear magnetic resonance imaging. Image quality of each modality is described mathematically, using linear systems theory (Fourier transforms, convolutions). (Prerequisite: Signal analysis course ECE 2312 or equivalent.)

BME 582. PRINCIPLES OF IN VIVO NUCLEAR MAGNETIC RESONANCE IMAGING.

This course emphasizes the applications of Fourier transform nuclear magnetic resonance (FTNMR) imaging and spectroscopy in medicine and biology. Course topics include: review of the basic physical concepts of NMR (including the Bloch equations), theoretical and experimental aspects of FTNMR, theory of relaxation and relaxation mechanisms in FTNMR, instrumentation for FTNMR, NMR imaging techniques (point, line, plane, and volume methods), and in vivo NMR spectroscopy (including volume localization techniques). (Prerequisites: Differential and integral calculus, ordinary differential equations; organic chemistry recommended.)

BME 585. PRINCIPLES OF IN VIVO NUCLEAR MAGNETIC RESONANCE SPECTROSCOPY.

This course emphasizes the applications of Fourier transform nuclear magnetic resonance (FTNMR) spectroscopy in medicine and biology. Course topics include: Review of the basic physical concepts of NMR, review of covalent chemical binding and its relationship to the NMR chemical shift, factors in biological systems that influence the NMR chemical shift, data acquisition and processing techniques in vivo NMR spectroscopy, and the application of NMR spectroscopy to clinical studies. (Prerequisites: BME 582, organic chemistry and biochemistry are strongly recommended.)

BME 595. SPECIAL TOPICS IN BIOMEDICAL ENGINEERING.

Topics in Biomedical Engineering. Presentations and discussions of the current literature in one or more of the following areas: medical imaging, neurosensory systems, bio-statics.

BME 595B. BIOMATERIALS IN THE DESIGN OF MEDICAL DEVICES.

Biomaterials are an integral part of medical devices, implants, controlled drug delivery systems, and tissue engineered constructs. Extensive research efforts have been expended on understanding how biologic systems interact with biomaterials. Meanwhile, controversy has revolved around biomaterials and their availability as a result of the backlash to the huge liability resulting from

controversies related to material and processing shortcomings of medical devices. This course specifically addresses the unique role of biomaterials in medical device design and the use of emerging biomaterials technology in medical devices. The need to understand design requirements of medical devices based on safety and efficacy will be addressed. Unexpected device failure can occur if testing fails to account for synergistic interactions from chronic loading, aqueous environments, and biologic interactions. Testing methodologies are readily available to assess accelerated effects of loading in physiologic-like environments. This combined with subchronic effects of animal implants is a potential tool in assessing durability. It is difficult to predict the chronic effects of the total biologic environment. The ultimate determination of safety comes not only from following the details of regulations, but with an understanding of potential failure modes and designs that lowers the risk of these failures. This course will evaluate biomaterials and their properties as related to the design and reliability of medical devices.

BME 595M. MEDICAL DEVICE REGULATION.

This course provides an overview of regulations that guide the Medical Devices industry. Primary focus is on the Food, Drug and Cosmetic Act and its associated regulations. The course covers the FD&C Act, including definitions, prohibited acts, penalties and general authority. The course also covers regulations, including establishment registration, premarket approval (PMA), and current good manufacturing practices. Requirements of other federal agencies (NRC, FCC, EPA) will also be discussed.

CHEMICAL ENGINEERING

NOTE: Courses listed in previous catalogs with "CM" as the prefix and the same course number as below are considered to be the SAME COURSE.

CHE 1011. INTRODUCTION TO CHEMICAL ENGINEERING.

Cat. I.

This course provides an introduction to the broad and vital discipline of chemical engineering including conventional and developing chemical technologies. An introduction is provided to the first principles of chemical engineering, as well as environmental, health, safety and ethical issues in chemical engineering practice. An overview is provided of the chemical engineering profession, career choices, the course of study, and a survey of the chemical industry, e.g., polymer, pharmaceutical, food processing, microelectronic, electrochemical, biotechnology, process control, energy, and petroleum refining. Course activities include guest speakers and plant trips.

Recommended for first-year students with a basic knowledge of chemistry.

CHE 2011. CHEMICAL ENGINEERING FUNDAMENTALS.

Cat. I.

This first course in chemical engineering is designed to give students the ability to use techniques and solve problems of interest to chemical engineers. Students will learn fundamental material by completing analysis, design, and/or laboratory projects. Topics covered include: material balances and stoichiometry, pressure, volume, and temperature behavior of pure fluids, 1st law of thermodynamics, vapor-liquid equilibria with ideal thermodynamics, and staged separation processes.

Recommended background: Elementary college chemistry and calculus.

Students may not receive credit towards CHE distribution requirements for both CHE 2011 and CM 2001.

CHE 2012. ELEMENTARY CHEMICAL PROCESSES.

Cat. I.

This course aims to build a strong foundation in analysis of chemical processes via a project-based approach. Topics covered include analysis and design of stagewise separation processes such as distillation, 1st and 2nd law (of thermodynamics) analysis of power and refrigeration cycles, and application of material and energy balances in industrial chemical processes, including those with recycle and non-ideal systems.

Recommended background: Elementary college chemistry and calculus and some familiarity with the topics listed in CHE 2011.

Students may not receive credit towards CHE distribution requirements for both CHE 2012 and ES 3000.

CHE 2013. APPLIED CHEMICAL ENGINEERING THERMODYNAMICS.

Cat. I.

This course uses a project-based approach to build confidence and competence in the use of chemical engineering thermodynamics for the analysis and design of chemical processes. Topics covered include extractive separation systems, solution thermodynamics and nonreacting multicomponent mixtures, phase equilibria and property changes on mixing.

Recommended background: Elementary college chemistry and calculus and some familiarity with the topics listed in CHE 2011 and CHE 2012.

Students may not receive credit towards CHE distribution requirements for both CHE 2013 and CM 2102.

CHE 2014. ADVANCED CHEMICAL PROCESSES.

Cat. I.

This course builds on prior work in material and energy balances, chemical engineering thermodynamics, and stagewise separation processes to facilitate student mastery and design of more complex processes. Topics covered include chemical reaction equilibria, material and energy balances for non-steady state systems, combined material and energy balances, humidification, and batch distillation.

Recommended background: Elementary college chemistry and calculus and some familiarity with the topics listed in CHE 2011, CHE 2012, and CHE 2013.

Students may not receive credit towards CHE distribution requirements for both CHE 2014 and CM 2002.

CHE 3201. KINETICS AND REACTOR DESIGN.

Cat. I.

Techniques for experimentally determining rate laws for simple and complex chemical reactions, the mechanisms and theories of chemical reactions, the function of catalysts, and the design of isothermal, adiabatic, batch and flow reactors. The course is intended to provide chemists and chemical engineers with the conceptual base needed to study reactions and perform in the design and analysis of reactors.

Recommended background: differential equations, thermodynamics and some organic chemistry.

CHE 3301. INTRODUCTION TO BIOLOGICAL ENGINEERING.

Cat. II.

This course is an introduction to the chemical engineering principles involved in modern applications of biological engineering. Topics may include: an introduction to biology, biochemistry, physiology, and genomics; biological process engineering including fermentation, mammalian cell culture, biocatalysis, and downstream bioseparations; drug discovery, development, and delivery; environmental biotechnology; and chemical engineering aspects of biomedical devices.

Recommended background: material and energy balances, thermodynamics, organic chemistry, and differential equations.

This course will be offered in 2007-08, and in alternating years thereafter.

CHE 3501. APPLIED MATHEMATICS IN CHEMICAL ENGINEERING.

Cat. I.

The consolidation of the methods of mathematics into a form that can be used for setting up and solving chemical engineering problems. Mathematical formulation of problems corresponding to specific physical situations such as momentum, energy and mass transfer, and chemical reactions. Analytical and numerical techniques for handling the resulting ordinary and partial differential equations and finite difference equations.

Recommended background: ordinary differential equations, partial derivatives and vectors, momentum heat and mass transfer.

CHE 3601. CHEMICAL MATERIALS ENGINEERING.

Cat. II.

This course is designed to provide a working knowledge in the solving of materials problems encountered by chemical engineers and in the engineering of new and improved materials used in chemical processes. The approach used is the correlation of engineering properties with atomic and microstructures, utilizing the diagnostic techniques of X-ray diffraction and spectroscopy, microscopy, and phase relationships.

Topics include surface active materials such as catalysts, sorbents, filtering and separation agents, corrosion resistant materials, metals, refractories and polymers used in construction materials, particularly for pollution control.

Recommended background: basic knowledge of chemistry.

This course will be offered in 2007-08, and in alternating years thereafter.

CHE 3910. CHEMICAL AND ENVIRONMENTAL TECHNOLOGY.

Cat. II.

Day trips to industrial plants provide an insight into the real world of the chemical industry. Advanced technologies for commercially producing major organic chemicals and the monomers and polymers derived from them are described. Petroleum refining, catalytic and thermal petrochemical processes, soaps and detergents, specialty chemicals, and antibiotic production processes are presented at the industrial level. Large scale unit operations and processes are seen on the plant trips. Students see how plant layout is integrated with process and product control and environmental protection at each facility.

Particular attention is paid to plant scale processes and equipment for control of chemical spills, hazards, and environmental pollution, for safety and accident prevention, and for compliance with local and national laws.

Recommended background: general understanding of Organic Chemistry and Material Balances is assumed.

This course will be offered in 2007-08, and in alternating years thereafter.

CHE 3920. AIR QUALITY MANAGEMENT.

Cat. II.

This course discusses the sources, sinks, ambient concentrations and effects of major gaseous and particulate air pollutants. The course is problem oriented and applied engineering methods to develop strategies for managing air quality on a local, regional and global scale. Topics include: indoor air quality, regional air

shed modelling, global atmospheric change and design and efficiencies of air pollution control devices.

Recommended background: knowledge of chemistry, mathematics and engineering principles.

This course will be offered in 2007-08, and in alternating years thereafter.

CHE 4401. UNIT OPERATIONS OF CHEMICAL ENGINEERING I.

Cat. I

Laboratory-application of fundamental theories to practical chemical engineering operations. Emphasis is on building the student's understanding and ability to approach the problems of design and operations of large scale chemical processing equipment.

The course is a combination of lectures and laboratory projects in the area of unit operations. Laboratory projects include experiments in fluid-flow phenomena through various media such as: friction in conduits, filtration, pressure drop in packed towers, fluidization of solids, and spray drying.

Students are expected to carry out the planning and execution of experimental work as well as the analysis and reporting of experimental results in both written and oral format.

Recommended background: knowledge of chemistry, mathematics and engineering principles.

CHE 4402. UNIT OPERATIONS OF CHEMICAL ENGINEERING II.

Cat. I

Overall format and procedure are essentially the same as in Unit Operations of Chemical Engineering I.

Laboratory projects include experiments in heat and mass transfer such as: heat transfer in two heaters and a cooler, climbing film evaporation, multiple effect evaporation, absorption, extraction, distillation and rotary drying of solids.

Recommended background: familiarity with techniques and procedures emphasized in CHE 4401.

CHE 4403. CHEMICAL ENGINEERING DESIGN.

Cat. I

Design of equipment, systems and plants; discussion of factors important in chemical plant design such as: economics, cost estimation, profitability, process selection, materials of construction, process control, plant location and safety. Introduction to optimization and computer-aided design. Principles are illustrated with short industrial-type problems.

Recommended background: thermodynamics; heat, mass and momentum transfer; inorganic and organic chemistry; chemical kinetics and reactor design.

CHE 4404. CHEMICAL PLANT DESIGN PROJECT.

Cat. I

Application of Chemical Engineering design principles to the design of a major chemical plant. Students work in groups to produce a preliminary practical process flowsheet, equipment and plant design, and economic analysis.

Recommended background: familiarity with techniques and procedures emphasized in CHE 4403.

CHE 4405. CHEMICAL PROCESS DYNAMICS AND CONTROL LABORATORY.

Cat. I

This course is intended to provide laboratory application of fundamental principles of chemical process dynamics and feedback control. This includes open-loop dynamics of typical chemical engineering processes such as distillation, fluid flow, chemical reactors and heated stirred tanks. Closed-loop experiments will involve control loop design, controller tuning, multivariable, and computer control.

Students will be required to design and execute their own experiments based on supplied objectives. Analysis and presentation of the results will be done through oral and written reports.

Recommended background: knowledge of fluid flow and heat transfer, mathematics and chemical engineering principles.

Graduate Chemical Engineering Courses of Interest to Undergraduates

CHE 504. MATHEMATICS ANALYSIS IN CHEMICAL ENGINEERING.

Methods of mathematical analysis selected from such topics as vector analysis, matrices, complex variables, Eigenvalue problems, Fourier analysis, Fourier transforms, Laplace transformation, solution of ordinary and partial differential equations, integral equations, calculus of variations, perturbation and asymptotic methods and numerical analysis. Emphasis on application to the solution of chemical engineering problems.

CHE 506. KINETICS AND CATALYSIS.

Theories of reaction kinetics and heterogeneous catalysis are developed for both simple and complex reactions. The kinetics and mechanisms of both catalyzed and uncatalyzed reactions are explored, as well as the effects of bulk and pore diffusion. Techniques for experimentation, reaction data treatment, and catalyst preparation and characterization are related to developing a sound approach to studying a chemical reaction.

CHE 507. CHEMICAL REACTOR DESIGN.

A review of the design of ideal reactors. Main course topics include: deviations from ideal reactor behavior; transport effects in reacting systems; steady state multiplicity and stability analysis; optimization of reactors; analysis of heterogeneous reactors.

CHE 508. CATALYSIS AND SURFACE SCIENCE OF MATERIALS.

The major factors which distinguished catalytic processes for chemicals and fuels from one another are the structure and composition of the materials used as catalysts.

This course examines the detailed structures and reactivities of solid catalysts like zeolites, solid state inorganics, supported metals and metal-support interactions, carbon catalysts, anchored catalysts and others. Several important spectroscopic techniques used in surface science such as X-ray photoelectron spectroscopy (ESCA), electron microprobe, AUGER, scanning electron microscopy, EXAFS, Mossbauer, Fourier-transform infrared, enhanced laser Raman spectroscopy and photoacoustics spectroscopy will be described for characterization of the catalytic surfaces.

The relationship between the structures and reactivities of important catalysts used in hydrocarbon oxidation and functionalization and syngas reactions will be examined to rationalize how they accomplish specific catalytic transformations.

CHE 510. DYNAMICS OF PARTICULATE SYSTEMS.

Systems of discrete particles which grow in size or some other characteristic variable (e.g., age, molecular weight, etc.) are analyzed. Both reaction engineering and population balance analyses are introduced for batch and continuous systems. Steady state and transient system dynamics are explored.

Depending on class interest, specific topics may include: crystallization, latex synthesis, polymer molecular weight distribution, fermentation/ecological systems and gas-solid systems.

CHE 521. BIOCHEMICAL ENGINEERING.

The course emphasizes the basic concepts of biological systems which are relevant to study by chemical engineers. Topics covered include ligand binding and membrane transport processes; growth kinetics of microorganisms; kinetics of interacting multiple populations; biological reactor design and analysis; soluble and immobilized enzyme kinetics; optimization and control of fermentation; and biological product recovery and separation.

CHE 531. FUEL CELL TECHNOLOGY

The course provides an overview of the various types of fuel cells followed by a detailed discussion of the proton-exchange membrane (PEM) fuel cell fundamentals: thermodynamics relations including cell equilibrium, standard potentials, and Nernst equation; transport and adsorption in proton-exchange membranes and supported liquid electrolytes; transport in gas-diffusion electrodes; kinetics and catalysis of electrocatalytic reactions including kinetics of elementary reactions, the Butler-Volmer equation, reaction routes and mechanisms; kinetics of overall anode and cathode reactions for hydrogen and direct methanol fuel cells; and overall design and performance characteristics of PEM fuel cells.

CHE 561. ADVANCED THERMODYNAMICS.

An examination of the fundamental concepts of classical thermodynamics and presentation of existence theorems for the thermodynamic properties with study of relations among them. The inequality of Clausius as a criterion for equilibrium in both chemical and physical systems. Examination of thermodynamic equilibrium for a variety of restraining conditions. Applications to fluid mechanics, process systems and chemical systems. Computation of complex equilibria.

CHE 571. INTERMEDIATE TRANSPORT PHENOMENA.

Mass, momentum and energy transport; analytic and approximate solutions of the equations of change. Special flow problems such as creeping, potential and laminar boundary-layer flows. Heat and mass transfer in multi-component systems. Estimation of heat and mass transfer rates. Transport with chemical reaction.

CHE 573. SEPARATION PROCESSES.

Thermodynamics of equilibrium separation processes such as distillation, absorption, adsorption and extraction. Multi-staged separations. Principles and processes of some of the less common separations.

CHE 574. FLUID MECHANICS.

Advanced treatment of fluid kinematics and dynamics. Stress and strain rate analysis using vectors and tensors as tools. Incompressible and compressible, one-dimensional flows in channels, ducts and nozzles. Nonviscous and viscous flow fields. Boundary layers and turbulence. Flow through porous media such as fixed and fluidized beds. Two-phase flows with drops, bubbles and/or boiling. Introduction to non-Newtonian flows.

CHE 580T. SPECIAL TOPICS: TRANSFORMATION AND TRANSPORT IN THE ENVIRONMENT.

This course will focus on the transformation and transport of pollutant chemicals, nutrients and colloids in natural and engineered environmental systems. The first part of the course deals with the transfer of chemicals between different

environments (water and air, water and solid phases). The second part of the course deals with processes by which a compound is chemically or biologically transformed into one or more products.
Research – as arranged

CHEMISTRY AND BIOCHEMISTRY

GENERAL CHEMISTRY SEQUENCE

The general chemistry sequence, CH 1010–1040, is a unified sequence of courses in which areas of major importance in chemistry are discussed in depth from both the empirical and theoretical viewpoints. Each of the four courses develops a theme, or core idea, of chemistry. The sequence is designed for biology, science and engineering majors.

The format of each course includes four 1-hour classroom meetings and one 3-hour laboratory meeting per week. For reasons of safety, contact lenses may not be worn in the chemical laboratories. Prescription glasses meeting the ANSI standard Z87.1 will be accepted as affording adequate eye protection in the laboratory. Otherwise, goggles meeting these standards must be worn at all times.

CH 1010. MOLECULARITY.

Cat. I

The theme of CH 1010 is the idea of molecularity: that all matter in the universe is composed of atoms bonded together in a limited number of ways. Molecularity is one of a small number of fundamental themes of chemistry (and of all science); it is important for us to address it immediately because it permeates all of chemistry.

Specific concepts that we will discuss are presented below.

Introduction to the Molecular View
Structures of Simple Molecules
Types of Compounds: The Periodic Table
Chemical Calculations
Types of Reactions
The Quantum Structure of the Atom

CH 1020. FORCES AND BONDING.

Cat. I

The theme of CH 1020 is forces and bonding. We will examine the origin and strength of electrical forces within molecules (covalent bonds), between positive and negative ions in a lattice (ionic bonds), and between atoms or molecules of a pure substance (intermolecular forces). Energy changes accompanying the rupture or formation of such bonds will be discussed.

Specific concepts that we will discuss are presented below.

Molecular Structure and Shape
Gases
Solids
Intra- and Intermolecular Forces
Liquids
Energy (First Law of Thermodynamics)

CH 1030. EQUILIBRIUM.

Cat. I

The theme of CH 1030 is equilibrium. We will examine the nature of dynamic equilibrium at the molecular level, and will develop an understanding of the mathematical aspects of equilibrium. Phase equilibrium, further aspects of thermodynamics (entropy, free energy), equilibrium of chemical reactions in the gas phase, and equilibrium of chemical reactions in solution will be discussed.

Specific concepts that we will discuss are presented below:

Phase Equilibrium
Chemical Equilibrium of Gas Phase Reactions
Solutions
Chemical Equilibrium of Reactions in Solution
Entropy and Free Energy

CH 1040. DYNAMICS.

Cat. I

The theme of CH 1040 is dynamics. We will examine the nature of molecular motions and their interaction with light, which provides us with all of our structural information about molecules. Various types of molecular spectroscopy will be discussed. Then we will turn to the dynamics of interactions between molecules, examining the rates of chemical reactions, and discussing the detailed molecular pathways by which they occur.

Specific concepts that we will discuss are presented below.

NMR Spectroscopy
Vibrational Spectroscopy
Electronic Spectroscopy
Dynamics of Physical Processes (Diffusion, phase changes, phase distribution)
Dynamics of Chemical Processes

ORGANIC CHEMISTRY COURSES

CH 2310. ORGANIC CHEMISTRY I.

Cat. I

A systematic survey of the major reaction types and functional groups in organic chemistry. The course will provide a representative collection of characteristic reactions and transformations of a variety of types of organic molecules. Most of the examples will be drawn from aliphatic chemistry. Some theoretical models will be introduced with a view toward establishing a general overview of the material.

The course is intended for chemists, chemical engineers, pre-medical students and all those interested in the biosciences. A familiarity with the material presented in the general chemistry courses is assumed.

CH 2320. ORGANIC CHEMISTRY II.

Cat. I

Modern theories of aromaticity, including a general assessment of delocalized bonding. The chemistry of some significant functional groups not surveyed in Organic Chemistry I, and the meaning of acidity and basicity in organic chemistry, will be more fully explored. The course will provide an introduction to the systematic synthesis of polyfunctional organic compounds.

Recommended background: CH 2310. The course is intended for chemists, chemical engineers and bio-science majors.

CH 2330. ORGANIC CHEMISTRY III.

Cat. I

The course will continue the coverage of aromatic chemistry. New topics to be introduced include the chemistry of heterocycles, carbohydrates, amino acids and lipids. Particular attention will be paid to naturally occurring polymers such as polysaccharides, proteins and nucleic acids, as well as to industrial polymers.

This course is concerned with the physical and chemical properties of biomolecules, but not their biochemical behavior. It is therefore a good preparation for but distinctively different from CH 4110.

Recommended background: CH 2310 and CH 2320 topics.

The course is intended for biochemists, chemists, chemical engineers and bio-science majors.

CH 2360. ORGANIC LABORATORY.

Cat. I

Laboratory experience in the preparation and characterization of organic substances. The course will also contain sufficient training in laboratory technique and data handling so that no previous laboratory experience beyond that of general chemistry will be assumed. (To be taken concurrently or following studies in organic chemistry.) Recommended for chemical engineers, pre-medical students, BB majors, and other nonchemists desiring chemical laboratory experience. One lecture and three three-hour labs.

CH 3310. ADVANCED ORGANIC CHEMISTRY

Cat. II

This course will review and further develop concepts introduced in CH2310, CH2320, and CH2330. These concepts will include oxidation states of organic compounds, acidity and basicity, and stereochemistry and conformational analysis. Chemical reactivity will be emphasized and will include functional group interconversion and ionic and free radical carbon-carbon bond formation.

Recommended background: CH2310, CH2320, and CH2330. This course is intended for students planning to take advanced courses in organic and/or medicinal chemistry and for chemists, biochemists, chemical engineers, and bio-science majors who desire a stronger background in organic chemistry.

Offered in 2006-07 and in alternating years thereafter.

EXPERIMENTAL CHEMISTRY SEQUENCE

The following four courses provide a full-year laboratory program. The purpose of this sequence is to train students in the most essential laboratory techniques, procedures and instrumentation of experimental chemistry. It aims to develop the skills needed for effective work on future chemical laboratory projects such as the Major Qualifying Project. The work of the year develops sequentially.

CH 2640. EXPERIMENTAL CHEMISTRY I: INSTRUMENTAL ANALYSIS.

Cat. I

This laboratory course focuses on the application of modern instrumental methods of analysis to chemical, biochemical and environmental problems. Practical experience is gained in quantitative ultraviolet-visible spectrophotometry, bioluminescence, high performance liquid chromatography, and capillary electrophoresis. Generally, after a set exercise to illustrate the capabilities and use of a particular instrument, student teams select a chemical, biochemical or environmental problem of interest to them, formulate an approach, conduct the analysis, and present their findings to the class.

Recommended background: CH 1010-CH 1040.

CH 2650. EXPERIMENTAL CHEMISTRY II.*Cat. I*

The experiments to be performed this term have been chosen to illustrate important principles and experimental techniques of physical chemistry. Students will gain experience with many of the instruments that they are likely to use in any chemical laboratory setting. These include optical spectrometers, vacuum lines, electrochemical cells and the bomb calorimeter.

Recommended background: CH 2640 and CH 3510.

CH 2660. EXPERIMENTAL CHEMISTRY III.*Cat. I*

The emphasis in CH 2660 is on basic techniques essential for the synthesis, isolation, and characterization of inorganic and organic compounds. These include isolation and purification by solvent extraction, crystallization, distillation, and chromatographic techniques, followed by the determination of physical properties and characterization by infrared and nuclear magnetic resonance spectroscopy. Micro-synthetic procedures are introduced. Mastery of the techniques and manipulations emphasized in CH 2640 and CH 2650 would be advantageous.

CH 2670. EXPERIMENTAL CHEMISTRY IV.*Cat. I*

The synthesis, isolation, and characterization of inorganic compounds are emphasized. Syntheses of main group compounds, classical transition metal complexes, and organotransition metal compounds are included. In addition to reinforcing and building on standard techniques of synthesis and characterization, several new techniques are introduced: synthesis under inert atmosphere, measurement of magnetic susceptibility by NMR, and cyclic voltammetry. Some exposure to ¹³C NMR is also provided. The final experiment of the course requires the student to design a synthesis for a compound selected from a list provided, based on strategies learned in the course.

INORGANIC AND PHYSICAL CHEMISTRY COURSES**CH 3410. PRINCIPLES OF INORGANIC CHEMISTRY.***Cat. I*

This course offers a unique approach to the descriptive chemistry of the elements. The Lewis acidity of positive centers is the starting point for the development of a series of ideas that includes Bronsted acidity, solubility, and the properties of the oxides of the elements. Redox properties are discussed in terms of Pourbaix diagrams. The often-complex structures of the oxides and halides of the elements are rationalized in terms of radius of the "cation" and "anion". The Lewis acid-base concept is extended in discussions of coordination compounds and the theory of hard and soft acids and bases. Finally, the descriptive chemistry of the compounds of the elements with halogens, sulfur, and nitrogen are discussed.

CH 3510. CHEMICAL THERMODYNAMICS.*Cat. I*

The content of this course will be the development of the principles of classical thermodynamics. The laws of thermodynamics will be developed by using a series of increasingly complex model systems and a universal equation of state is formulated which incorporates the relationships illustrated by these model systems. Using this equation it will be possible to appreciate that thermodynamic laws are applicable to all systems of matter, regardless of their complexity. Finally, the principles developed are applied to problems of a chemical nature, focusing on predicting the spontaneity of chemical reactions.

The material in this course will be of greatest interest to those students enrolled in the basic sciences including biology, chemistry, and physics, and in applied fields such as chemical engineering, materials science and biotechnology.

Recommended background: Students should be familiar with the material covered in the freshman general chemistry and math sequences. Familiarity with differential equations would be an asset.

CH 3530. QUANTUM CHEMISTRY.*Cat. I*

An introduction to quantum mechanics with applications to atomic and molecular species. The course will be developed systematically beginning with the postulates of quantum mechanics. The Schroedinger equation will be applied to systems such as the particle in a box, the rigid rotor, the harmonic oscillator and the hydrogen atom. Emphasis will be given to a quantum mechanical description of multielectron atoms, molecular bonding and spectroscopy.

Recommended background: a solid foundation in elementary physics and calculus.

This course is normally for students in their third year.

CH 3550. CHEMICAL DYNAMICS.*Cat. I*

This course deals in a general way with the interactions between energy and molecules, and considers how energetic and structural considerations affect the outcome of molecular interactions. The manipulation of kinetic data and results is stressed. Selected topics from both organic and inorganic chemistry are analyzed in terms of reaction thermodynamics, rates and mechanisms.

Students are expected to be familiar with thermodynamics, equilibria, reaction rates and the Periodic Table of the elements.

The following three courses, CH 4110, CH 4120, and CH 4130, are a three-term sequence intended to provide a strong emphasis in biochemistry. As background for this sequence, CH 1010, CH 1020, CH 1030, CH 1040, CH 2310, CH 2320, and CH 2330, or their equivalents, are recommended.

BIOCHEMISTRY COURSES**CH 4110. BIOCHEMISTRY I.***Cat. I*

The principles of protein structure are presented. Mechanisms of enzymatic catalysis, including those requiring coenzymes, are outlined in detail. The structures and biochemical properties of carbohydrates are reviewed. Bioenergetics, the role of ATP, and its production through glycolysis and the TCA cycle are fully considered.

Recommended background: CH 2310, CH 2320.

Suggested background: CH 2330.

CH 4120. BIOCHEMISTRY II.*Cat. I*

Oriented around biological membranes, this course begins with a discussion of electron transport and the aerobic production of ATP followed by a study of photosynthesis. The study of the biosynthesis of lipids and steroids leads to a discussion of the structure and function of biological membranes. Finally the membrane processes in neurotransmission are discussed.

Recommended background: CH 4110.

CH 4130. BIOCHEMISTRY III*Cat. I*

This course presents a thorough analysis of the biosynthesis of DNA (replication), RNA (transcription), and proteins (translation) and of their biochemical precursors. Proteins and RNAs have distinct lifetimes within the living cell; thus the destruction of these molecules is an important biochemical process that is also discussed. In addition to mechanistic studies, regulation of these processes is covered.

Students who have received credit for CH 4130 or BB 4910 prior to Term A 2000 may not receive credit for the other course.

CH 4150. EXPERIMENTAL BIOCHEMISTRY.*Cat. I*

The experiments in this laboratory course have been designed to acquaint the students with the basic skills necessary to perform biochemical studies. The course will cover, for instance, protein purification from different biological sources, subcellular fractionation, enzyme kinetics (Km, Vmax, Hill coefficient; specific activity, effector-protein interaction, etc.), exclusion and ion exchange chromatography, electrophoresis and immunodetection.

Recommended background: CH 4120.

CH 4160. MEMBRANE BIOPHYSICS.*Cat. II*

This course will focus on different areas of biophysics with special emphasis on membrane phenomena. The biomedical-biological importance of biophysical phenomena will be stressed. The course will begin with the introduction of the molecular forces relevant in biological media and subsequently develop the following topics: Membrane Structure and Function; Channels, Carriers and Pumps; Nerve Excitation and related topics; and Molecular Biophysics of Motility.

Recommended background: prior knowledge of Biochemistry (CH 4110, CH 4120), Mechanics (PH 1110) and Electricity (PH 1120).

This course will be offered in 2007-08 and in alternating years thereafter.

CH 4190. REGULATION OF GENE EXPRESSION*Cat. I*

This course will cover the biochemical mechanisms involved in regulation of gene expression, modifications of DNA structures that influence transcription rates, transcriptional regulation by protein binding, post-transcriptional modifications of RNA including splicing and editing, regulation of translation including ribosome binding and initiation of translation, and factors that control the half-lives of both mRNA and protein. During the course, common experimental methods will be explored, including a discussion of the information available from each method.

Recommended background CH 4110, CH 4120, CH 4130, BB 4010

ADVANCED CHEMISTRY COURSES**CH 4330. ORGANIC SYNTHESIS.***Cat. II*

A discussion of selected modern synthetic methods including additions, condensations and cyclizations. Emphasis is placed on the logic and strategy of organic synthesis. This course is intended to follow CH 2330.

Recommended background: CH 2310, CH 2320, and CH 2330.

This course will be offered in 2006-07 and in alternating years thereafter.

CH 4420. INORGANIC CHEMISTRY II.*Cat. II*

Complexes of the transition metals are discussed. Covered are the electronic structures of transition metal atoms and ions, and the topological and electronic structures of their complexes. Symmetry concepts are developed early in the course and used throughout to simplify treatments of electronic structure. The molecular orbital approach to bonding is emphasized. The pivotal area of organotransition metal chemistry is introduced, with focus on complexes of carbon monoxide, metal-metal interactions in clusters, and catalysis by metal complexes.

Recommended background: CH 1010 - CH 1040, CH 2640 - CH 2670, CH 3410, CH 3530, and CH 3550.

This course will be offered in 2006-07 and in alternating years thereafter.

CH 4520. CHEMICAL STATISTICAL MECHANICS.*Cat. II*

This course deals with how the electronic, translational, rotational and vibrational energy levels of individual molecules, or of macromolecular systems, are statistically related to the energy, entropy, and free energy of macroscopic systems, taking into account the quantum mechanical properties of the component particles. Ensembles, partition functions, and Boltzmann, Fermi-Dirac, and Bose-Einstein statistics are used. A wealth of physical chemical phenomena, including material related to solids, liquids, gases, spectroscopy and chemical reactions are made understandable by the concepts learned in this course.

Recommended background: CH 3510 and CH 3530, or equivalent, and mathematics through differential and integral calculus.

This course will be offered in 2007-08 and in alternating years thereafter.

CH 4550. POLYMER CHEMISTRY.*Cat. II*

Fundamentals of polymer science and technology based on organic polymers. The principal mechanisms of polymerization including radical, ionic and condensation, are covered in detail. Characterization of polymers by physical means. Mechanical behavior including bulk and solution properties of polymers. Polymer syntheses and modifications including block and graft copolymerization.

Structure, property and end use applications of plastic materials. Plastics processing, testing and technology. Survey of commodity plastics as well as engineering resins including their applications and economic considerations. Presentation of trade and technical literature in the field.

Recommended background: CH 2310 and CH 2320 or equivalent.

This course will be offered in 2006-07 and in alternating years thereafter.

GRADUATE CHEMISTRY COURSES OF INTEREST TO UNDERGRADUATES

CH 501. CHEMISTRY OF THE MAIN GROUP ELEMENTS.

An advanced course in recent developments in selected areas of the chemistry of the elements other than transition metals. Topics covered may include electron deficient compounds and main group organometallics; the preparation, reactions and physical properties of these compounds.

CH 502. BIOINORGANIC CHEMISTRY.

This graduate course addresses current topics in bioinorganic chemistry, with emphasis on the structure and function of metalloenzymes of d-block metal ions. Active site structures of myoglobin and hemoglobin, blue copper proteins and hemocyanin, iron-sulfur cluster proteins, and the nitrogenase enzyme are discussed. The applications of a variety of physical methods (including electronic absorption spectroscopy, FTIR, multinuclear NMR, EPR, Resonance Raman spectroscopy, EXAFS, and electrochemical methods) to the elucidation of metalloprotein structure/function are discussed.

Recommended background: Knowledge of the fundamental concepts and theories of d-metal chemistry and of various spectroscopic methods.

CH 516. CHEMICAL SPECTROSCOPY.

Advanced topics in identification of organic species and determination of molecular structure by spectroscopic methods.

Methods covered include ^1H - and ^{13}C -NMR, mass spectrometry and infrared and UV-visible spectroscopy. This course is concerned only with interpretation of spectra and does not cover techniques obtaining them; there is no laboratory.

CH 533. PHYSICAL ORGANIC CHEMISTRY.

Mechanics of representative organic reactions, and the methods used for their evaluation. Structural, electronic, and stereochemical influences on reaction mechanisms are explored. Emphasis is on the various techniques used to obtain insights into mechanisms, and on the interplay of data and interpretation.

CH 534. ORGANIC PHOTOCHEMISTRY.

Introduction to the photophysical and photochemical consequences of light absorption by molecules. Experimental techniques, excited state description, photochemical kinetics and energy transfer are among the topics discussed in relation to the primary photochemical reactions in simple and complex molecules.

CH 538. MEDICINAL CHEMISTRY.

This course will focus on the medicinal chemistry aspects of drug discovery from an industrial pharmaceutical Research and Development perspective. Topics will include Chemotherapeutic Agents (such as antibacterial, antiviral and antitumor agents) and Pharmacodynamic Agents (such as antihypertensive, antiallergic, antiulcer and CNS agents).

Recommended background: CH 2310, CH 2320, and CH 2330.

CH 536. THEORY AND APPLICATIONS OF NMR SPECTROSCOPY

This course emphasizes the fundamental aspects of 1D and 2D nuclear magnetic resonance spectroscopy (NMR). The theory of pulsed Fourier transform NMR is presented through the use of vector diagrams. A conceptual nonmathematical approach is employed in discussion of NMR theory. The course is geared toward an audience which seeks an understanding of NMR theory and an appreciation of the practical applications of NMR in chemical analysis. Students are exposed to hands-on NMR operation. Detailed instructions are provided and each student is expected to carry out his or her own NMR experiments on a Bruker AVANCE 400 MHz NMR spectrometer.

CH 539. MOLECULAR PHARMACOLOGY.

The course will begin with a review of human physiology emphasizing the endocrine, nervous, and lymphatic systems, and including a discussion of the psychoneuroimmunology controversy. Understanding communication between cells requires study of the variety of chemical messengers, their storage, release, action on their target receptors, and eventual fate. This study will include discussion of the location and nature of the variety of receptors. Understanding the effects of messengers necessitates a detailed study of the molecular structure and function of ion channels which will include an application to the nerve impulse. Intercellular and intracellular communication are brought together by a discussion of the molecular mechanisms of receptor-effector coupling. The molecular structures of the acetylcholine receptor and of rhodopsin will be used as illustrations. The concepts of agonist and antagonist will be reinforced by a discussion of selected drugs. Nonreceptor blocking will be illustrated in a study of local anesthesia. Study of the neuroactive peptides will lead to a discussion of drug addiction and alcoholism as receptor mediated pathologies. A segment on the role ion cotransport systems play in bodily regulation will include an analysis of the molecular action of the loop diuretics as another example of nonreceptor blockers. This course is designed to compliment the "Medicinal Chemistry" course and will emphasize general principles and the underlying molecular structures.

Recommended background: knowledge of the material covered in one of the following is recommended: (a) CH 4110 and CH 4120, or (b) CH 538 plus an understanding of protein and membrane structures.

CH 552. STATISTICAL MECHANICS.

Application of the results of the quantum theory to achieve an atomistic physical understanding of the common thermodynamic variables. Maxwell-Boltzmann, Fermi-Dirac, and Bose-Einstein distribution functions are defined using the concepts of phase space and the exclusion principle, and the thermodynamic functions are developed in terms of the distribution functions. Application of the partition function and the theory of fluctuations to common physical systems.

CH 554. MOLECULAR MODELING.

This course is intended to train students in the area of molecular modeling using a variety of quantum mechanical and force field methods. The approach will be towards practical chemists who want to answer specific questions about molecular geometry, transition states, reaction paths, and photoexcited states. No experience in programming is necessary; however, a background at the introductory level in quantum mechanics is highly desirable. Methods to be explored include Extended Huckel Theory, Molecular Mechanics, Semiempirical Molecular Orbital Methods, Ab initio and DFT Methods, Graphical Display of Molecules.

CH 555. ADVANCED TOPICS.

A course of advanced study in selected areas whose content and format to suit the interest and needs of faculty and students.

CH 556. EXPERIMENTAL PHOTOCHEMISTRY.

This course has been designed to illustrate how modern spectroscopic techniques can be used to learn more about the photo-induced chemistry of organic materials. The principles of time-resolved and steady-state spectroscopic methods will be described in lectures and then applied in the laboratory to a variety of chemical systems. The aim will be to show how it is possible to fully describe the ground and excited state photochemical behavior of a chemical system using these techniques. Aspects of the following techniques will be covered:

Fluorescence emission spectroscopy, including solvent effects, quantum yields, quenching behavior, singlet lifetime determinant, excited singlet state energies and the origin of temperature dependence.

Phosphorescence emission spectroscopy, including triplet state energies, distinguishing between $n\pi$ and π excited states.

Laser-flash photolysis, including generation, detection and identification of transient reaction intermediates, quenching, sensitization, triplet state lifetimes, properties of free radicals and other photochemically-generated reactive species, and the consequences of multiple photon excitation.

Steady-state irradiation coupled with end product analysis and how these studies compliment time-resolved measurement.

Students will gain hands-on experience with the use of UV-visible absorption and fluorescence emission spectrometers as well as the laser flash photolysis research facility. Also, as part of the course, students will submit a short research proposal based on one or more of the techniques used.

Although there is no formal requirement for this course, some background and an interest in photochemistry would be an asset.

CIVIL AND ENVIRONMENTAL ENGINEERING

CE 1030. CIVIL ENGINEERING AND COMPUTER FUNDAMENTALS.

Cat. I

This course introduces students to basic fundamentals of civil engineering, group dynamics, oral presentation skills, engineering report writing techniques, and uses of the computer. Basics of structural engineering, geotechnical engineering, environmental engineering, surveying, materials, and construction engineering and management are presented in this course through a collaborative group teaching approach. Background is provided to gain competence in operating systems, editors, and spreadsheets. Student groups complete weekly computer laboratory projects and develop oral presentations and written reports.

No previous computer use skills are required or assumed. This course is recommended for freshman or sophomore students.

CE 2000. ANALYTICAL MECHANICS I.

Cat. I

This fundamental civil engineering course provides an introduction to the analysis of structures in static equilibrium. The focus of this course is a classical analysis of concurrent and non-concurrent equilibrium. A variety of engineering problems including trusses, machines, beams, rigid frames, and hydraulic structures involving concentrated and distributed loading systems are analyzed for external reactions and internal forces.

CE 2001. ANALYTICAL MECHANICS II.

Cat. I

This course provides an introduction to the relationship between analysis, design, and the behavior of materials under load. Theory and applications are developed that utilize simple and combined stress-strain behavior of members subjected to axial, torsional, and flexural loadings, with applications to beams, trusses, rigid frames, shafts, and tension and compression structures.

Recommended background: CE 2000.

CE 2002. INTRODUCTION TO ANALYSIS AND DESIGN.

Cat. I

This course develops an understanding of classical and modern structural analysis. Topics include loading systems, and the analysis of statically determinate and statically indeterminate beams, frames, trusses, structural floor systems for buildings, bridges, and other structural assemblies.

Recommended background: CE 2000 and CE 2001.

Suggested background: CE 1030.

CE 2020. SURVEYING.

Cat. I

This course develops fundamental skills in the theoretical and practical aspects of plane surveying through the use and care of modern instruments and the associated computations. Topics include the classification of errors incurred in observed field data and necessary correction applications, the use and care of surveying equipment, traversing, differential leveling, stadia and mapping, and electronic data transfer. Computer applications are used where appropriate.

CE 3006. DESIGN OF STEEL STRUCTURES.

Cat. I

This course covers the theory and practice of structural steel design. The structural design process for beams, columns, trusses, frames, and connections is based on Load and Resistance Factor Design (LRFD) specifications of the American Institute of Steel Construction.

Recommended background: CE 2002 and CE 3010.

Suggested background: CE 1030.

CE 3008. DESIGN OF REINFORCED CONCRETE STRUCTURES.

Cat. I

This course covers the theory and practice of reinforced concrete design. The structural design process for beams, columns, slabs, frames, flat slabs, footings, and retaining walls uses the ultimate strength design codes of the American Concrete Institute.

Recommended background: CE 2002 and CE 3010.

Suggested background: CE 1030.

CE 3010. STRUCTURAL ENGINEERING.

Cat. I

This course provides an understanding of the practice of structural engineering. It builds upon the fundamental skills developed in CE 2000, CE 2001, and CE 2002 to present the principles of structures and their elements. The course

provides a perspective for dealing with the issues of strength, stiffness, and stability. Although wood is the principle material used to develop the study of the interrelationship between analysis and design of structural systems, structural steel and reinforced concrete systems are also discussed. It also introduces students to the use of building codes for design criteria. The role of the structural engineer in the design process and cost factors are also discussed.

Recommended background: CE 2000, CE 2001, and CE 2002.

Suggested background: CE 1030.

CE 3020. PROJECT MANAGEMENT.

Cat. I

This course presents the fundamental concepts and process of project management applied to public and private works. The principle focus of the course is the management of civil engineering projects including planning, scheduling, organization and control, as well as management concepts of leadership, motivation, trust, project team development, division of work, and conflict resolution. Ancillary engineering and construction practices involving financial practices, construction documents, contract negotiation and administration, quality and safety control, insurance and bonding are covered.

Recommended background: CE 1030.

CE 3021. COST ESTIMATING, SCHEDULING AND PROJECT CONTROL.

Cat. II

This course presents the fundamental concepts and processes by which the cost and time of execution of civil engineering projects are established. It emphasizes the importance of decisions made at the early stages of design on final project cost. The relationship between time and cost is examined in detail. Topics include: construction methods, quantity surveying, resource pricing, activity planning, resource allocation, financial analysis, bidding, job cost accounting and cost control with extensions to operating and maintenance costs. Commercial software for project scheduling, cost estimating, and cost control is used in this course.

Recommended background: CE 1030 and CE 3020.

Offered in 2006-07 and in alternating years thereafter.

CE 3022. LEGAL ASPECTS IN DESIGN AND CONSTRUCTION.

Cat. II

This course addresses legal aspects that underpin the planning, design and construction of a project. The principle focus is the contracts, laws, specifications, and design documents needed to conduct civil engineering practice in the United States. Labor, safety, and environmental laws are reviewed, as well as the role of ethics and professional relationships with the client, other professional organizations and groups, the public, and the regulatory system.

Recommended background: CE 3020.

Offered in 2007-08 and in alternating years thereafter.

CE 3023. ARCHITECTURAL ENGINEERING SYSTEMS.

Cat. I

This course introduces the fundamental concepts associated with the design and construction of a building. Major building components, such as foundations, structures, envelopes and environmental systems are presented as subsystems to be integrated. The systems approach is utilized to describe the functional interdependence of building components and the interdisciplinary nature of the design of contemporary buildings. Building components are analyzed in terms of design details and constructability implications. Graphic representation and building design exercises as well as case studies are used to illustrate the topic.

CE 3024. CONTROL SURVEYING.

Cat. II

This course presents the principles and field procedures required in the design of vertical and horizontal control networks for large building and construction projects.

Recommended background: CE 2020.

Offered in 2006-07 and in alternating years thereafter.

CE 3026. MATERIALS OF CONSTRUCTION.

Cat. I

This course provides an understanding of the use and acquisition of engineering properties of construction materials. Topics include relationships between the structure of materials, their engineering properties, and the selection of suitable materials for applications involving strength, durability, and serviceability. Experimental laboratory procedures including design of experiments, data collection, analysis, and representation, and report writing are an integral part of the work.

Recommended background: CE 1030 and CE 2001.

CE 3030. FUNDAMENTALS OF CIVIL ENGINEERING AUTOCAD.

Cat. I

This course introduces Civil Engineering students to fundamental uses of the AutoCAD software package. Basic two dimensional drawing techniques are covered. Advanced topics that may be covered include three dimensional drawing, rendering and animation. Students are required to become familiar with AutoCAD.

Knowledge of the subject matter in at least two civil engineering design courses is expected background for this course.

CE 3041. SOIL MECHANICS.*Cat. I*

This is an introductory course dealing with the science and technology of earth materials with an emphasis on fundamental concepts of particulate mechanics. The topics which are discussed include fluid flow through porous media, deformation and shear characteristics of soil, consolidation, lateral earth pressure, and slope stability.

Recommended background: CE 2000 and CE 2001.

Suggested background: GE 2341.

CE 3044. FOUNDATION ENGINEERING.*Cat. II*

Foundation engineering is a study of the applications of the principles of soil mechanics and structural theory to the analysis, design and construction of foundations for engineering works with the emphasis on the soil engineering aspects of soil structure interaction. Subsurface exploration techniques, design of rigid and flexible retaining structures, and design of, shallow and deep foundations are considered. Although the course deals mainly with aspects of the design of buildings and bridges, certain parts of the course (design of temporary trench bracing, for example) are very relevant to construction engineering.

Recommended background: CE 3041.

Suggested background: CE 3008.

Offered in 2006-07 and in alternating years thereafter.

CE 3050. INTRODUCTION TO TRANSPORTATION ENGINEERING.*Cat. I*

This course provides an introduction to the field of transportation engineering with particular emphasis on traffic engineering and highway design. Topics covered include a description of the transportation industry and transportation modes; characteristics of drivers, pedestrians, vehicles and the roadway; traffic engineering studies, highway safety, principles of traffic flow, intersection design and control, capacity analysis, level of service analysis; geometric design of highways; paving materials and pavement design.

Suggested background: CE 2020.

CE 3051. INTRODUCTION TO PAVEMENT MATERIALS, DESIGN AND MANAGEMENT.*Cat. I*

This course provides an introduction to concepts required for design construction and management of pavements. Topics include Highway Drainage, Soil Engineering for Highway Design, Bituminous Materials, Design of Flexible and Rigid Pavements and Pavement Management. Knowledge of the subject matter in CE 3050 is helpful but not required.

CE 3054. ASPHALT TECHNOLOGY.*Cat. I*

This laboratory-based course introduces the field of asphalt technology, provides an understanding of characterization tests for hot mix asphalt and understanding of production of hot mix asphalt, illustrates typical problems of hot mix asphalt pavements, and helps in developing an interest in asphalt technology. Instruction is provided through lecture, laboratory work and field trips. Students work in groups for preparation of laboratory reports and a term project.

Recommended background: CE 1030 and CE 2001.

CE 3059. ENVIRONMENTAL ENGINEERING.*Cat. I*

This is an introductory course in the area of environmental engineering. The course should also be of interest to students who require an overall understanding of environmental engineering problems. Topics covered include: environmental impact of population growth and energy demand, water resources, water chemistry, water quality standards, environmental microbiology, wastewater characteristics, receiving water quality and dissolved oxygen budgets, water pollution abatement, sludge management, solids and hazardous waste management, and an introduction of air and noise pollution.

Recommended background: CH 1010 and CH 1020 or equivalent.

CE 3060. WATER TREATMENT.*Cat. I*

This course provides in-depth coverage of processes used in water treatment. Topics include: review of water chemistry and drinking water standards, impurities in natural waters, aeration, water softening coagulation, flocculation, sedimentation, filtration, disinfection, taste and odor control, corrosion control, and iron and manganese removal.

Recommended background: CE 3059 and ES 3004.

CE 3061. WASTE WATER TREATMENT.*Cat. I*

This course provides in-depth coverage of processes used in wastewater treatment. Topics include: review of water quality standards, wastewater characteristics, application of biochemical oxygen demand, sources and effects of pollution, physical, chemical, and biological wastewater treatment processes, and waste sludge management.

Recommended background: CE 3059 and ES 3004.

CE 3062. HYDRAULICS IN CIVIL ENGINEERING.*Cat. I*

This course provides a basic background for designing hydraulic systems used in water supply and wastewater transport systems. It is a basic course for students in the sanitary engineering and water resources area. Topics include open channel flow, pipe flow, pumps, sewer design and water supply network design.

Recommended background: ES 3004.

CE 3070. URBAN AND ENVIRONMENTAL PLANNING.*Cat. I*

This course introduces to the student the social, economic, political, and environmental factors that affect the population growth and distribution patterns, and the impact of such patterns to the natural environment. By using the principles and procedures of planning, the optimal growth pattern may be examined, and the infrastructure (roads, water supply systems, waste-water treatment systems, shopping malls, etc.) necessary to support present and future growth patterns may be determined.

The information necessary in planning, which involves conscious procedures of analysis, formulation of alternative solutions, rational assessment and deliberate choice in accordance with evaluation criteria, is obtained through extensive reading. As such the course introduces a variety of topics of concern to engineers and environmentalists. The course is intended not only for civil engineering majors, but also for students preparing for an IQP in areas of urban or environmental concerns.

CE 3074. ENVIRONMENTAL ANALYSIS.*Cat. I*

This course provides a background in the principles and techniques of assessing areas of natural environment and the application of this assessment to evaluate the inherent suitability for urban and resource based uses and facilities. The techniques developed in this course will be useful for land use planning, site design, and the impact of engineering projects on the environment.

Suggested background: CE 3070.

CE 4007. MATRIX ANALYSIS OF STRUCTURES.*Cat. II*

This course presents the principles of matrix analysis of structural elements and systems; fundamentals of matrix algebra, solution of simultaneous equations, matrix inversion; analysis of plane trusses, method of joints; displacement method, principle of virtual work, analysis of continuous beams, analysis of plane frames, plane trusses, analysis of building frames and bridges; computer aided structural analysis and principles of software development.

Recommended background: CE 2002.

Offered in 2006-07 and in alternating years thereafter.

CE 4017. PRESTRESSED CONCRETE DESIGN.*Cat. II*

This course covers analysis and design aspects of prestressed concrete structural elements and systems: principles of prestressing, materials for prestressing, high strength steel, flexural analysis and design methods; allowable stress and strength design methods; design of beams, load balancing, partial prestressing and cracking moment; design for shear, partial loss of prestress; deflections of prestressed concrete and precast construction; connections.

Recommended background: CE 2002 and CE 3026.

Suggested background: CE 3008.

Offered in 2007-08 and in alternating years thereafter.

CE 4046. EXPERIMENTAL SOIL MECHANICS.*Cat. II*

The standard laboratory soil testing procedures generally encountered in civil engineering are introduced in this course. It further includes a limited discussion of soil behavior primarily based on the effect of soil's physical and chemical properties on laboratory test results. The tests which are performed include: grain size analysis, Atterberg limits, specific gravity, permeability, compaction, compression and consolidation, and direct and triaxial shear. The student's results of the various tests are integrated within an engineering problem.

Recommended background: CE 3041.

Offered in 2006-07 and in alternating years thereafter.

CE 4060. ENVIRONMENTAL ENGINEERING LABORATORY.*Cat. I*

This course familiarizes students with the laboratory studies used to obtain the design parameters for water and wastewater treatment systems. The topics include laboratory experiments dealing with physical, chemical, and biological treatment systems.

Recommended background: CE 3060 and CE 3061.

CE 4061. HYDROLOGY.*Cat. I*

This course provides a quantitative description of the rainfall and runoff process for use in design of water resource related projects. Topics include: the review of the hydrologic cycle, precipitation, evaporation, transpiration, infiltration, stream flow measurements, flow routing, runoff analysis, show hydrology and development of drainage estimates for development plans. The course involves a stream measurement laboratory and application of model for hydrological and hydraulic engineering applications.

Recommended background: ES 3004.

CE 4071. LAND USE DEVELOPMENT AND CONTROLS.*Cat. I*

The purpose of this course is to provide an understanding of how land use controls may be used to effectively shape our physical, social, and economic development. The quality of our environment depends upon the development which is permitted to take place and the controls which direct that development. Through this course, the student will learn the principles, methods, and techniques which a planner may use to plan the uses and development of land. In particular, the use and limits of zoning, special permits, hammerhead lots, subdivision control, comprehensive permits, and other tools with which a developer of planner board member should be familiar will be examined in detail.

COMPUTER SCIENCE

CS 1101. INTRODUCTION TO PROGRAM DESIGN.*Cat. I*

This course introduces principles of computation and programming with an emphasis on program design. Topics include design and implementation of programs that use a variety of data structures (such as records, lists, and trees), functions, conditionals, and recursion. Students will be expected to design, implement, and debug programs in a functional programming language.

Intended audience: students desiring an introduction to programming and program design.

Recommended background: none. Either CS 1101 or CS 1102 provide sufficient background for further courses in the CS department. Undergraduate credit may not be earned for both this course and CS 1102.

Undergraduate credit may not be earned both for this course and for CS 2135.

CS 1102. ACCELERATED INTRODUCTION TO PROGRAM DESIGN.*Cat. I*

This course provides an accelerated introduction to design and implementation of functional programs. The course presents the material from CS 1101 at a fast pace (so students can migrate their programming experience to functional languages), then covers several advanced topics in functional programming (potential topics include macros, lazy programming with streams, and programming with higher-order functions). Students will be expected to design, implement, and debug programs in a functional programming language.

Intended audience: students starting with substantial previous programming background.

Recommended background: prior programming background covering lists, trees, functions, and recursion.

Undergraduate credit may not be earned for both this course and CS 1101. Undergraduate credit may not be earned both for this course and for CS 2135.

CS 2011. INTRODUCTION TO MACHINE ORGANIZATION AND ASSEMBLY LANGUAGE.*Cat. I*

This course introduces students to the structure and behavior of digital computers at several levels of abstraction. Using a bottom-up approach, the course starts by examining logic gates and digital circuits. The student is then introduced to virtual machines at successively higher levels of abstraction, beginning with the Von Neumann model of execution, and progressing through machine language, assembly language, and high-level languages. Topics include the functional organization of computer hardware, the functions of assemblers, linkers, and loaders, representations of numbers in computers, basic assembly language instruction sets, addressing modes, stacks and procedures, low-level I/O, concepts and examples of microprogramming, and logic circuits.

Students will be expected to design, implement, and debug programs in an assembly language.

Intended audience: computer science students, and those desiring a deeper understanding of the low-level functionality of a computer.

Recommended background: CS 2303 or CS 2301.

CS 2022/MA 2201. DISCRETE MATHEMATICS.*Cat. I*

This course serves as an introduction to some of the more important concepts, techniques, and structures of discrete mathematics, providing a bridge between computer science and mathematics.

Topics include functions and relations, sets, countability, groups, graphs, propositional and predicate calculus, and permutations and combinations.

Students will be expected to develop simple proofs for problems drawn primarily from computer science and applied mathematics.

Intended audience: computer science and mathematical sciences majors.

Undergraduate credit may not be earned both for this course and for CS 501.

Recommended background: none.

CS 2102. OBJECT-ORIENTED DESIGN CONCEPTS.*Cat. I*

This course introduces students to an object-oriented model of programming. Building from the design methodology covered in CS 1101/CS 1102, this course shows how programs can be decomposed into classes and objects. By emphasizing design, this course shows how to implement small defect-free programs and evaluate design decisions to select an optimal design under specific assumptions. Topics include inheritance, exceptions, interface, design by contract, basic design patterns, and reuse. Students will be expected to design, implement, and debug object-oriented programs composed of multiple classes and over a variety of data structures.

Intended audience: students with prior program design experience who desire to learn object-oriented design.

Recommended background: CS 1101 or CS 1102.

Undergraduate credit may not be earned both for this course and for CS 2136.

CS 2118. OBJECT-ORIENTED DESIGN CONCEPTS FOR BUSINESS APPLICATIONS.*Cat. I*

This course introduces students to an object-oriented model of programming, with an emphasis on the programming approaches useful in creating business applications. Building from the design methodology covered in CS 1101/CS 1102, this course shows how programs can be decomposed into classes and objects.

Students will be expected to design, implement, and debug object-oriented programs in Visual Basic.

Topics include inheritance, building user interfaces, and database access.

Intended audience: non-CS majors with an interest in building business applications who have prior program design experience.

Recommended background: CS 1101 or CS 1102.

Students may receive credit for only one of the following: MG 2720, MIS 2720, or CS 2118.

CS 2223. ALGORITHMS.*Cat. I*

Building on a fundamental knowledge of data structures, data abstraction techniques, and mathematical tools, a number of examples of algorithm design and analysis, worst case and average case, will be developed.

Topics include greedy algorithms, divide-and-conquer, dynamic programming, heuristics, and probabilistic algorithms. Problems will be drawn from areas such as sorting, graph theory, and string processing. The influence of the computational model on algorithm design will be discussed.

Students will be expected to perform analysis on a variety of algorithms.

Intended audience: computer science and computer engineering students, and those desiring a deeper understanding of algorithm design and analysis.

Undergraduate credit may not be earned both for this course and for CS 507.

Recommended background: CS 2102 and CS 2022.

CS 2301. SYSTEMS PROGRAMMING FOR NON-MAJORS.*Cat. I*

This course helps students with prior program design experience migrate their skills to a model of programming where the programming language exposes details of how the hardware stores and executes software. Building from the design concepts covered in CS 1101/CS 1102, this course covers manual memory management, pointers, the machine stack, and input/output mechanisms. Students will be expected to design, implement, and debug programs in C.

Intended audience: non-computer science majors who wish to take upper-level courses in the systems area of the computer science curriculum.

Recommended background: CS 1101 or CS 1102. CS majors and other students wishing to prepare for upper-level CS courses in both systems and software engineering should take CS 2303 instead of CS 2301. Students who have credit for CS 2303 may not receive subsequent credit for CS 2301.

Undergraduate credit may not be earned both for this course and for CS 2005.

CS 2303. SYSTEMS PROGRAMMING CONCEPTS.*Cat. I*

This course introduces students to a model of programming where the programming language exposes details of how the hardware stores and executes software. Building from the design concepts covered in CS 2102, this course covers manual memory management, pointers, the machine stack, and input/output mechanisms. The course will involve large-scale programming exercises and will be designed to help students confront issues of safe programming with system-level constructs. The course will cover several tools that assist programmers in these tasks. Students will be expected to design, implement, and debug programs in C++ and C.

Intended audience: computer science and computer engineering students with substantial prior object-oriented programming experience.

Recommended background: CS 2102.

CS 3013. OPERATING SYSTEMS.*Cat. I*

This course provides the student with an understanding of the basic components of a general-purpose operating system.

Topics include processes, process management, synchronization, input/output devices and their programming, interrupts, memory management, resource allocation, and an introduction to file systems.

Students will be expected to design and implement a large piece of system software.

Intended audience: computer science majors and others interested in studying the software and hardware components of computer systems.

Undergraduate credit may not be earned both for this course and for CS 502.

Recommended background: CS 2303 or CS 2301, and CS 2011.

CS 3041. HUMAN-COMPUTER INTERACTION.*Cat. I*

This course develops in the student an understanding of the nature and importance of problems concerning the efficiency and effectiveness of human interaction with computer-based systems.

Topics include the design and evaluation of interactive computer systems, basic psychological considerations of interaction, interactive language design, interactive hardware design, and special input/output techniques.

Students will be expected to complete two projects. A project might be a software evaluation, interface development, or an experiment.

Intended audience: computer science majors, especially juniors.

Recommended background: CS 2102 or CS 2118.

CS 3043. SOCIAL IMPLICATIONS OF INFORMATION PROCESSING.*Cat. I*

This course makes the student aware of the social, moral, ethical, and philosophical impact of computers and computer-based systems on society, both now and in the future.

Topics include major computer-based applications and their impact, human-machine relationships, and the major problems of controlling the use of computers.

Students will be expected to contribute to classroom discussions and to complete a number of writing assignments.

Intended audience: students interested in the impact of a computer-oriented technology on his or her future way of life and well-being. This course is highly recommended for juniors.

Undergraduate credit may not be earned both for this course and for CS 505.

Recommended background: a general knowledge of computers and computer systems.

CS 3133. FOUNDATIONS OF COMPUTER SCIENCE.*Cat. I*

This course introduces the theoretical foundations of computer science. These form the basis for a more complete understanding of the proficiency in computer science.

Topics include computational models, formal languages, and an introduction to compatibility and complexity theory, including NP-completeness.

Students will be expected to complete a variety of exercises and proofs.

Intended audience: computer science majors and others desiring an understanding of the theoretical foundations of computer science.

Undergraduate credit may not be earned both for this course and for CS 503.

Recommended Background: CS 2022 and CS 2223.

Students who have credit for CS 4121 cannot receive credit for CS 3133.

Students graduating under the pre-1996 distribution requirements may satisfy the Theory area requirement by taking this course, although it does not count as a 4000-level course.

CS 3431. DATABASE SYSTEMS I.*Cat. I*

This course introduces the student to the design, use, and application of database management systems.

Topics include the relational data model, relational query languages, design theory, and conceptual data design and modeling for relational database design. Techniques that provide for data independence, and minimal redundancy will be discussed.

Outcome: Students will be expected to design and implement database system applications.

Intended audience: computer science majors and others interested in studying the development of software applications with large data management requirements.

Undergraduate credit may not be earned both for this course and for CS 4431 or CS 542.

Recommended background: CS 2022 and either CS 2102 or CS 2118.

CS 3733. SOFTWARE ENGINEERING.*Cat. I*

This course introduces the fundamental principles of software engineering. Modern software development techniques and life cycles are emphasized.

Topics include requirements analysis and specification, analysis and design, architecture, implementation, testing and quality, configuration management, and project management.

Students will be expected to complete a project that employs techniques from the topics studied.

Intended audience: computer science majors and others who expect to design software systems. This course should be taken before any course requiring a large programming project.

Undergraduate credit may not be earned both for this course and for CS 509.

Recommended background: CS 2102.

CS 4032/MA 3257. NUMERICAL METHODS FOR LINEAR AND NONLINEAR SYSTEMS.*Cat. I*

This course provides an introduction to modern computational methods for linear and nonlinear equations and systems and their applications.

Topics covered include: solution of nonlinear scalar equations, direct and iterative algorithms for the solution of systems of linear equations, solution of nonlinear systems, the eigenvalue problem for matrices. Error analysis will be emphasized throughout.

Recommended background: MA 2071. An ability to write computer programs in a scientific language is assumed.

CS 4033/MA 3457. NUMERICAL METHODS FOR CALCULUS AND DIFFERENTIAL EQUATIONS.*Cat. I*

This course provides an introduction to modern computational methods for differential and integral calculus and differential equations.

Topics covered include: interpolation and polynomial approximation, approximation theory, numerical differentiation and integration, numerical solutions of ordinary differential equations. Error analysis will be emphasized throughout.

Recommended background: MA 2051. An ability to write computer programs in a scientific language is assumed. Undergraduate credit may not be earned for both this course and for MA 3255/CS 4031.

CS 4120. ANALYSIS OF ALGORITHMS.*Cat. II*

This course develops the skill of analyzing the behavior of algorithms.

Topics include the analysis, with respect to average and worst case behavior and correctness, of algorithms for internal sorting, pattern matching on strings, graph algorithms, and methods such as recursion elimination, dynamic programming, and program profiling.

Students will be expected to write and analyze programs.

Intended audience: computer science majors.

Undergraduate credit may not be earned both for this course and for CS 504.

Recommended background: CS 2223 and some knowledge of probability.

This course will be offered in 2006-07 and in alternating years thereafter.

CS 4123. THEORY OF COMPUTATION.*Cat. II*

Building on the theoretical foundations from CS 3133, this course addresses the fundamental question of what it means to be "computable," including different characterizations of computable sets and functions.

Topics include the halting program, the Church-Turing thesis, primitive recursive functions, recursive sets, recursively enumerable sets, NP-completeness, and reducibilities.

Students will be expected to complete a variety of exercises and proofs.

Intended audience: computer science majors and others desiring an understanding of the nature of computation.

Undergraduate credit may not be earned both for this course and for CS 553.

Recommended Background: CS 3133.

This course will be offered in 2007-08 and in alternating years thereafter.

CS 4233. OBJECT-ORIENTED ANALYSIS AND DESIGN.*Cat. II*

This Software Engineering course will focus on the process of Object-Oriented Analysis and Design. Students will be expected to complete a large number of exercises in Domain Modeling, Use Case Analysis, and Object-Oriented Design. In addition, the course will investigate Design Patterns, which are elements of reusable object-oriented software designs. This course will survey a set of design patterns and consider how these patterns are described and used to solve design problems.

Recommended Background: CS 2303 and CS 3733.

This course will be offered in 2006-07 and in alternating years thereafter.

CS 4241. WEBWARE: COMPUTATIONAL TECHNOLOGY FOR NETWORK INFORMATION SYSTEMS.*Cat. I*

This course explores the computational aspects of network information systems as embodied by the World Wide Web (WWW). Topics include: languages for document design, programming languages for executable content, scripting languages, design of WWW based human/computer interfaces, client/server network architecture models, high level network protocols (e.g., http), WWW network resource discovery and network security issues.

Students in this course will be expected to complete a substantial software project (e.g., Java based user interface, HTML/CGI based information system, WWW search mechanisms, etc.).

Recommended background: CS 2102 and CS 3013.

CS 4341. INTRODUCTION TO ARTIFICIAL INTELLIGENCE.*Cat. I*

This course studies the problem of making computers act in ways which we call "intelligent".

Topics include major theories, tools and applications of artificial intelligence, aspects of knowledge representation, searching and planning, and natural language understanding.

Students will be expected to complete projects which express problems that require search in state spaces, and to propose appropriate methods for solving the problems.

Intended audience: computer science majors.

Undergraduate credit may not be earned both for this course and for CS 534.

Recommended background: CS 2102 and CS 2223.

Suggested background: CS 3133.

CS 4432. DATABASE SYSTEMS II.*Cat. II*

This course concentrates on the study of the internals of database management systems.

Topics include: principles and theories of physical storage management, advanced query languages, query processing and optimization, index structures for relational databases, transaction processing, concurrency control, distributed databases, and database recovery, security, client server and transaction processing systems.

Outcome: Students may be expected to design and implement software components that make up modern database systems.

Intended audience: computer science and computer engineering majors.

Undergraduate credit may not be earned both for this course and CS 542.

Recommended background: CS 3431 and CS 3733.

This course will be offered in 2007-08 and in alternating years thereafter.

CS 4445. DATA MINING AND KNOWLEDGE DISCOVERY IN DATABASES.*Cat. II*

This course provides an introduction to Knowledge Discovery in Databases (KDD) and Data Mining. KDD deals with data integration techniques and with the discovery, interpretation and visualization of patterns in large collections of data. Topics covered in this course include data warehousing and mediation techniques; data mining methods such as rule-based learning, decision trees, association rules and sequence mining; and data visualization. The work discussed originates in the fields of artificial intelligence, machine learning, statistical data analysis, data visualization, databases, and information retrieval. Several scientific and industrial applications of KDD will be studied.

Recommended background: CS 4341 Introduction to Artificial Intelligence, MA 2611 Applied Statistics I, and CS 3431 Database Systems I.

This course will be offered in 2006-07 and in alternating years thereafter.

CS 4513. DISTRIBUTED COMPUTING SYSTEMS.*Cat. I*

This course extends the study of the design and implementation of operating systems begun in CS 3013 to distributed and advanced computer systems.

Topics include principles and theories of resource allocation, file systems, protection schemes, and performance evaluation as they relate to distributed and advanced computer systems.

Students may be expected to design and implement programs that emphasize the concepts of file systems and distributed computing systems using current tools and languages.

Intended audience: computer science and computer engineering majors.

Undergraduate credit may not be earned both for this course and for CS 502.

Recommended background: CS 3013 and a knowledge of probability, such as provided by MA 2621.

CS 4514. COMPUTER NETWORKS: ARCHITECTURE AND IMPLEMENTATION.*Cat. I*

This course introduces principles and current trends in computer networks. The ISO Reference Model will be used as the framework with the course progressing through the physical, data link, network, transport, session, and presentation layers with specific examples and standards cited throughout for point-to-point, satellite, packet-radio, and local area networks.

Topics include motivation and objectives of computer networks, overview of network architectures, layered architectures, performance analysis, virtual circuits, datagrams, routing flow control, local area networks, internetworking, end-to-end communication, virtual terminal, file transfer protocols, and client-server programming.

Students will be expected to design and implement projects such as simulation of the network/transport layer functions, routing, congestion control, an Ethernet controller, applications using TCP/IP or remote procedure calls.

Intended audience: computer science and computer engineering majors.

Undergraduate credit may not be earned both for this course and for CS 513.

Recommended background: CS 3013 and some knowledge of probability.

CS 4515. COMPUTER ARCHITECTURE.*Cat. II*

This course explores modern computer architectures in terms of instruction sets and the organization of processors, controllers, memories, devices, and communication links.

Topics include an overview of computer systems, theoretical foundations, modern computer system components, pipelining of instruction sets, multifunction pipelines, parallel computer organization.

Students will be expected to design and implement programs which simulate significant components of modern computer architectures.

Intended audience: computer science and computer engineering majors.

Recommended background: CS 2011 or ECE 2801, and CS 3013.

This course will be offered in 2006-07 and in alternating years thereafter.

CS 4533. TECHNIQUES OF PROGRAMMING LANGUAGE TRANSLATION.*Cat. II*

This course studies the compiling process for high-level languages.

Topics include lexical analysis, syntax analysis, semantic analysis, symbol tables, intermediate languages, optimization, code generation and run-time systems.

Students will be expected to use compiler tools to implement the front end, and to write a program to implement the back end, of a compiler for a recursive programming language.

Intended Audience: computer science and computer engineering majors.

Undergraduate credit may not be earned for both this course and for CS 544.

Recommended Background: CS 2102 and CS 3133.

This course will be offered in 2006-07 and in alternating years thereafter.

CS 4536. PROGRAMMING LANGUAGES.*Cat. II*

This course covers the design and implementation of programming languages. Topics include data structures for representing programming languages, implementing control structures (such as functions, recursion, and exceptions), garbage collection, and type systems. Students will be expected to implement several small languages using a functional programming language.

Intended audience: CS majors and minors interested in understanding how programming languages work and how to implement their own small languages.

Recommended background: CS 2303, CS 3133, and experience programming in a functional language (as provided by CS 1101 or CS 1102).

Undergraduate credit may not be earned for both this course and CS 536.

This course will be offered in 2007-08 and in alternating years thereafter.

CS 4731. COMPUTER GRAPHICS.*Cat. I*

This course studies the use of the computer to model and graphically render two- and three-dimensional structures.

Topics include graphics devices and languages, 2- and 3-D object representations, and various aspects of rendering realistic images.

Students will be expected to implement programs which span all stages of the 3-D graphics pipeline, including clipping, projection, arbitrary viewing, hidden surface removal and shading.

Intended audience: computer science majors.

Undergraduate credit may not be earned both for this course and for CS 543.

Recommended background: CS 2223, CS 2303 and MA 2071.

CS 4732. COMPUTER ANIMATION.*Cat. II*

This course provides an in-depth examination of the algorithms, data structures, and techniques used in modeling and rendering dynamic scenes. Topics include animation hardware and software, parametric blending techniques, modeling physical and articulated objects, forward and inverse kinematics, key-frame, procedural, and behavioral animation, and free-form deformation.

Students will be expected to develop programs to implement low-level animation algorithms as well as use commercial animation tools to design and produce small to moderate sized animations.

Intended audience: computer science majors.

Recommended background: CS 4731.

This course will be offered in 2007-08 and in alternating years thereafter.

ELECTRICAL AND COMPUTER ENGINEERING

The second digit in electrical engineering course numbers is coded as follows:

- 0 — Circuits
- 1 — Fields
- 2 — Electronic Circuits and Systems
- 3 — Signals and Communication Systems
- 4 — Available for Future Use
- 5 — Machines, Power Systems
- 6 — Professional and Miscellaneous
- 7 — Projects, Laboratory, Independent Study
- 8 — Computers
- 9 — Electronic Devices

NOTE: Courses listed in previous catalogs with "EE" as the prefix and the same course number as below are considered to be the SAME COURSE.

ECE 2011. INTRODUCTION TO ELECTRICAL AND COMPUTER ENGINEERING.

Cat. I

The objective of this course is to expose new electrical engineering students (including first year students) to the broad field of electrical engineering, introducing basic concepts of circuits and systems and their applications. Experiments based on practical devices are used to reinforce basic concepts and develop laboratory skills, as well as to provide system-level understanding. The use of circuit simulation tools for analysis and design is introduced.

Topics: Basic concepts of electrical circuits, linear circuit analysis, op-amp circuits, simple transients, phasor analysis, amplifiers, frequency response, filters.

Recommended background: high school physics, and MA 1022 (concurrent).

ECE 2022. INTRODUCTION TO DIGITAL CIRCUITS AND COMPUTER ENGINEERING.

Cat. I

The objective of this course is to expose students (including first year students) to basic electrical and mathematical concepts that underlie computer engineering while continuing an introduction to basic concepts of circuits and systems in a hands-on environment. Experiments representing practical devices introduce basic electrical engineering concepts and skills which typify the study and practice of electrical and computer engineering. In the laboratory, the students construct, troubleshoot, and test analog and digital circuits that they have designed. They will also be introduced to the nature of the interface between hardware and software in a typical microprocessor based computer.

Topics: Sets, functions, Boolean algebra, digital switching logic, the transistor as switch, circuit design of logic gates, design of combinational logic circuits, software and hardware interfacing including analog/digital and digital/analog conversion.

Recommended background: ECE 2011 and MA 1022.

ECE 2111. PHYSICAL PRINCIPLES OF ECE APPLICATIONS.

Cat. I

In this course students will learn the practical aspects of electromagnetics and their relation to basic DC and AC circuit theory.

The meaning of the electric and magnetic field concepts is explained and placed in context with capacitive and inductive circuits. Exploiting those concepts leads to a host of practical devices such as transformers, motors, and generators. In addition, measures to minimize the influence of stray electric and magnetic fields are analyzed as part of various shielding and grounding strategies.

The electric and magnetic circuit aspects are then presented as linear first order systems in the time and frequency domains. Issues such as time constants, impedance, and superposition are explained in detail. Building upon these basic concepts, second order systems consisting of mixed capacitive and inductive systems are analyzed in terms of their resonance effects. The second order system description will then be applied to develop the basic transmission line theory as required in high-speed digital design.

Recommended background: ECE 2011, introductory physics courses such as PH 1120 or PH 1121, MA 1024, MA 2051 (concurrent).

ECE 2112. ELECTROMAGNETIC FIELDS.

Cat. I

The object of this course is a comprehensive treatment of electromagnetic engineering principles covering the entire application spectrum from static to dynamic field phenomena.

The starting point will be the basic electric and magnetic field definitions of Coulomb and Biot-Savart leading to Gauss's and Ampere's laws. They form the foundation of electro- and magnetostatics fields. Students will examine capacitive and inductive systems and relate them to lumped element circuit models. By introducing temporal and spatial magnetic flux variations, Faraday's law is established. The engineering implications of this law are investigated in terms of transformer and motor actions. Incorporation of the displacement current density into Ampere's law and combining it with Faraday's law will then culminate in the complete set of Maxwell's field equa-

tions. As a result of these equations, students will develop the concept of wave propagation in the time and frequency domain with practical applications such as wireless communication, radar, Global Positioning Systems, and microwave circuits.

Recommended background: ECE 2111.

ECE 2201. MICROELECTRONIC CIRCUITS I.

Cat. I

This course is the first of a two-course sequence in electronic circuit design. It begins with a substantive treatment of the fundamental behavior of semiconductor materials and moves on to the semiconductor diode, the bipolar transistor, and the field-effect transistor. Laboratory exercises are provided to reinforce the theory of operation of these devices. Numerous circuit applications are considered, including: power supplies, transistor amplifiers, and FET switches.

Topics include: the pn junction, diode operation, transducers, rectification, voltage regulation, limiting and clamping circuits, transistor operation, biasing, small-signal and large-signal models, transistors amplifiers, and switching applications.

Recommended background: ECE2011.

ECE/BME 2204. BIOELECTRIC FOUNDATIONS.

Cat. I

An introduction to the origins and characteristics of the electric and electromagnetic signals that arise in biological tissues. Topics include the behavior of excitable cells and tissues, the intrinsic electrical and magnetic properties of biological tissues, and the response of excitable cells to electric and magnetic field stimulation. Laboratory projects include the measurement of bioelectric signals (EMG, EKG, EEG, EOG, and evoked response) and the fundamentals of data acquisition, analysis, and statistics. The principles of writing and maintaining a laboratory notebook are also developed and used.

Recommended background: BB 2550 or equivalent, PH 1120 or PH 1121.

Students who have received credit for BME 4101 may not receive credit for BME 2204.

ECE 2311. CONTINUOUS-TIME SIGNAL AND SYSTEM ANALYSIS.

Cat. I

This course provides an introduction to time and frequency domain analysis of continuous time signals and linear systems. Topics include signal characterization and operations; singularity functions; impulse response and convolution; Fourier series; the Fourier transform and its applications; frequency-domain characterization of linear, time-invariant systems such as filters; and the Laplace transform and its applications.

Recommended background: ECE 2011, MA 1022.

Suggested background: MA 2051.

ECE 2312. DISCRETE-TIME SIGNAL AND SYSTEM ANALYSIS.

Cat. I

This course provides an introduction to the time and frequency domain analysis of discrete-time signals and linear systems. Topics include sampling and quantization, characterization of discrete-time sequences, the discrete-time Fourier transform, the discrete Fourier transform and its applications, the Z transform and its applications, linear and circular convolution, characterization of FIR and IIR discrete-time systems, and the analysis and design of discrete-time filters. Projects include topics such as sampling and quantization; application of the DFT to signal and system analysis and design; and digital filter design and simulation.

Recommended background: ECE 2311.

ECE 2799. ELECTRICAL AND COMPUTER ENGINEERING DESIGN.

Cat. I

The goal of this course is to provide experience with the design of a system, component, or process. Basic sciences, mathematics, and engineering sciences are applied to convert resources to meet a stated objective. Fundamental steps of the design process are practiced, including the establishment of objectives and criteria, synthesis, analysis, manufacturability, testing, and evaluation. Student work in small teams and are encouraged to use creativity to solve specific but open-ended problems, and then present their results.

ECE 2799 is strongly recommended for all students as a preparation for the design element of the MQP. It is anticipated that ECE 2799 will be of most benefit to students when taken well in advance of the MQP (late sophomore year or early junior year).

Recommended background: ECE 2022, ECE 2111, and ECE 2311; and either ECE 2201 or ECE 2801.

ECE 2801 FOUNDATIONS OF EMBEDDED COMPUTER SYSTEMS.

Cat. I

This course introduces the assembly language programming concepts that are needed to develop microprocessor and microcontroller-based computer systems. Beginning with the fundamentals of computer architecture and organization, students learn assembly language and how assembly language programs running on microprocessors are used to solve problems that require interactions between a computer and the physical world. Students in this course will also learn about the hardware and software structure of a modern computer system and how hardware, software, and the passage of time must be managed in an embedded system design. Other issues that will be addressed as appropriate include overall embedded system development, software maintenance, programming for reliability, and product safety.

Topics: Number systems, software flow diagrams, models for system state and state transitions, microprocessor and microcontroller architecture and assembly language programming, program development and test tools, operating system interfaces, hardware/software dependencies, and time and resource management.

Lab exercises: Introductory assembly language exercises and more advanced problems which explore topics such as logic flow, real time programming, maintainability and software maintenance cycles. Exercises will be performed on microcontroller and/or microprocessor based embedded systems using cross platform development tools appropriate to the target platform.

Recommended background: ECE 2022 (for ECE students) or CS 2011.

ECE/BME 3011. BIOINSTRUMENTATION AND BIOSENSORS.

Cat. I

A study of the basic principles of biomedical electronics and measurement with emphasis on the operational performance and selection of transducers, instruments and systems for biomedical data acquisition and processing. Biopotential electrodes. Analysis and selection of physical, optical, electrical, mechanical, thermal transduction mechanisms which form the basis of the sensor design. Clinical laboratory instrumentation. Electrical safety problems in the clinical environment.

Recommended background: MA 2051, ECE 3601, or equivalent.

ECE 3113. INTRODUCTION TO RF CIRCUIT DESIGN.

Cat. I

This course is designed to provide students with the basic principles of radio frequency (RF) circuit design. It concentrates on topics such as designing tuning and matching networks for analog and digital communication, satellite navigation, and radar systems.

After reviewing equivalent circuit representations for RF diodes, transistors, FETs, and their input/output impedance behavior, the course examines the difference between lumped and distributed parameter systems. Characteristics impedance, standing waves, reflection coefficients, insertion loss, and group delay of RF circuits will be explained.

Within the context of Maxwell's theory the course will then focus on the graphical display of the reflection coefficient (Smith Chart) and its importance in designing matching circuits. Students will learn the difference between SPICE and monolithic and microwave integrated circuit analysis, and design (MMICAD) modeling. Biasing and matching networks for single and multistage amplifiers in the 900 to 2,000 MHz range are analyzed and optimized in terms of input/output impedance matching, insertion loss, and group delays.

Recommended background: ECE 2111, ECE 3204.

Suggested background: ECE 2112.

ECE 3204. MICROELECTRONIC CIRCUITS II.

Cat. I

This course is the second of a two-course sequence in electronic circuit design. More complex circuits are analyzed and the effects of frequency and feedback are considered in detail. The course provides a comprehensive treatment of operational amplifier operation and limitations. The use of Bode plots to describe the amplitude and phase performance of circuits as a function of operating frequency is also presented. In addition, the concepts of analog signal sampling, analog-to-digital conversion and digital-to-analog conversion are presented along with techniques for interfacing analog and digital circuitry. Laboratory exercises are provided to reinforce student facility with the application of these concepts to the design of practical circuits.

Topics include: transducers; differential amplifiers, inverting/non-inverting amplifiers, summers, differentiators, integrators, passive and active filters, the Schmitt trigger, monostable and a-stable oscillators, timers, sample-and-hold circuits, A/D converters, and D/A converters.

Recommended background: Introductory electronic-circuit design and analog-signal analysis as found in ECE 2201 and ECE 2311.

ECE 3305. AEROSPACE AVIONICS SYSTEMS.

Cat. I

This course is intended for students interested in obtaining a systems-level perspective of modern aerospace communications, navigation, and radar systems. The fundamental theory of operation of these systems is presented along with current-day applications of them.

Topics: The functional operating principles and techniques of communications, navigation (including GPS) and radar systems; performance expectations for antenna, transmitter, receiver, and transmission-line components; error sources and their effect in combination on both individual component and aggregated system performance; earth-shape approximations and their influence on system design and operation; tropospheric and ionospheric effects of radio-wave propagation; and achievable overall system accuracies.

Recommended background: MA 1022 and PH 1120 or equivalent. With extra work, this course can be successfully completed by non-ECE students. The basic concepts of electromagnetic-wave propagation and antennas will be introduced as needed.

Suggested background: ECE 2312

ECE 3311. PRINCIPLES OF COMMUNICATION SYSTEMS.

Cat. I

This course provides an introduction to analog and digital communications systems. The bandpass transmission of analog data is motivated and typical systems are analyzed with respect to bandwidth considerations and implementation techniques. Baseband and passband digital transmission systems are introduced and investigated. Pulse shaping and intersymbol interference criteria are developed in relation to the pulse rate transmission limits of bandlimited channels. Finally, digital carrier systems and line coding are introduced in conjunction with applications to modern modem transmission schemes.

Recommended background: MA 1024, ECE 2311 and ECE 2312.

ECE 3501. ELECTRICAL ENERGY CONVERSION.

Cat. I

This course is designed to provide a cohesive presentation of the principles of electric energy conversion for industrial applications and design. The generation, transmission and conversion of electric energy, as well as basic instrumentation and equipment associated with electric energy flow and conversion are analyzed.

Topics: Review of poly-phase circuits. Transducers and instrumentation for power and energy measurements. Rotating machines. Electromechanical transients and stability. Switchgear equipment. Selected laboratory experiments.

Recommended background: ECE 2111.

ECE 3503. POWER ELECTRONICS.

Cat. I

This course is an introduction to analysis and design of power semiconductor circuits used in electric motor drives, control systems, robotics and power supply.

Topics: characteristics of thyristors and power transistors. Steady-state performance and operating characteristics, device rating and protection, commutation, gating circuits, ac voltage controllers, controlled rectifiers, dc/dc converters and dc/ac inverters. Laboratory exercises.

Recommended background: ECE 2201, ECE 2311 or equivalent.

ECE 3601. PRINCIPLES OF ELECTRICAL ENGINEERING.

Cat. I

Intended for students other than electrical engineers, this course is oriented towards developing competence in electrical engineering concepts on the level that the technology interfaces directly with their own discipline. The course is designed specifically to help students meet that challenge through the development of a broad systems perspective and an understanding of the principal elements of electrical engineering technology. The expectation is that students completing the course will be able to handle adequately the electrical aspects of a broad range of application topics. In addition, and most important, they will be prepared to work effectively with electrical engineers on the joint solution of complex problems.

Topics covered during the course include: direct current (DC) circuit analysis and design, alternating current (AC) circuit analysis and design, circuit design using operational amplifiers, and electric machines and power systems. Selected laboratory projects are included to emphasize the direct application of the information presented in lectures.

Recommended background: MA 1021-1023, MA 2051, PH 1120/1121 or equivalent.

ECE 3711. INTRODUCTION TO ELECTRO-OPTICS.

Cat. I

The aim of this course is to give students the opportunity to acquire a fundamental understanding of optoelectronics and principles of optoelectronic device operation.

At the completion of this course the students should achieve an understanding of wave phenomena and an appreciation of basic optical components. The students will obtain a background in modulation of light and a working knowledge of display devices based on photoluminescence and cathodoluminescence, and will gain insight into light emitting diodes, LED materials and liquid crystal display. A review of the concept of lasers will be presented, leading to an appreciation of the different laser types, especially the semiconductor laser. The students will be given a working knowledge of the optical fiber categories and operation as well as critical aspects of fiber optical communication systems. Additional applications may be covered in student projects.

Recommended background: PH 1140, ECE 2311, ECE 2201.

ECE 3801. ADVANCED LOGIC DESIGN.

Cat. I

This course introduces students to the design of the complex logic systems underlying or supporting the operation of computer systems and interfaces. Students learn how to use advanced computer-aided design tools to develop and simulate logic systems consisting of MSI components such as adders, multiplexers, latches, and counters. The concept of synchronous logic is introduced through the design and implementation of Mealy and Moore machines. Hardware description languages are introduced and used to describe and implement combinational circuits. Students will also learn how to use programmable logic devices to implement customized designs.

Topics: Review of logic gates and design and simplification of combinational circuits. Arithmetic circuits, MSI devices, analysis and design of sequential circuits, synchronous state machines and programmable logic. Introduction to hardware description languages.

Lab exercises: Design, analysis and construction of combinational and sequential circuits, use of computer-aided engineering software for schematic entry and digital analysis, introduction to hardware description languages and programmable logic devices.

Recommended background: ECE 2022 (for ECE students) or CS 2011.

Suggested background: MA 2201/CS 2022.

ECE 3803. MICROPROCESSOR SYSTEM DESIGN.

Cat. I

This course builds on the computer system material presented in ECE 2801. It covers the architecture, organization and instruction set of microprocessors. The interface to memory (RAM and EPROM) and I/O peripherals is described with reference to bus cycles, bus timing, and address decoding. Emphasis is placed on the design, programming and implementation of interfaces to microprocessor systems using a mixture of C and assembly language.

Topics: bus timing analysis, memory devices and systems, IO and control signaling, bi-directional bus interfaces, instruction execution cycles, interrupts and polling, addressing, programmable peripheral devices, interface design issues including analog/digital and digital/analog conversion. Mixed language (C and Assembler) programming.

Laboratory exercises: Use of standard buses for advanced IO design and programming, mixed language programming, standard bus timing, and interface design and implementation. Development of a complete standalone embedded computer system.

Recommended background: ECE 2801 and ECE 3801 or an equivalent background in advanced logic design, and microprocessor architecture. CS2005, CS 2301 or CS 2303 or an equivalent background in C programming.

ECE 3810. ADVANCED DIGITAL SYSTEM DESIGN

Cat. I

This is an introductory course addressing the systematic design of advanced digital logic systems. The emphasis is on top-down design starting with high level models using VHDL as a tool for the design, synthesis, modeling, and testing of VLSI devices. The emphasis will be on understanding functional design, layout, floor planning, designing for speed and power objectives, and testing. Finally, the integration of tools and design methodologies will be addressed through a discussion of system on a chip (SOC) integration, methodologies, design for performance, and design for test/testing.

Topics: 1. hardware description languages, VHDL, system modeling, synthesis, simulation and testing of digital circuits; 2. VLSI design tools, transistor level design and behavior, layout, routing, clocking and testing. 3. design integration to achieve specific SOC goals including architecture, planning and integration, and testing.

Laboratory exercises: VHDL models of combinational and sequential circuits, synthesizing these models to programmable logic devices, simulating the design, test-benches, transistor level IC design, IC design methodologies, circuit extraction and modeling, and high level SOC design methodologies.

Recommended background: ECE 3801 and experience with programming in a high-level language such as C or Pascal. Suggested background: ECE 3901 and ECE 3803.

Students may not receive credit for ECE 3810 if they have received credit for either ECE 3815 or ECE 3902.

ECE/BME 4011. BIOMEDICAL SIGNAL ANALYSIS.

Cat. II

Introduction to biomedical signal processing and analysis. Fundamental techniques to analyze and process signals that originate from biological sources: ECGs, EMGs, EEGs, blood pressure signals, etc. Course integrates physiological knowledge with the information useful for physiologic investigation and medical diagnosis and processing. Biomedical signal characterization, time domain analysis techniques (transfer functions, convolution, auto- and cross-correlation), frequency domain (Fourier analysis), continuous and discrete signals, deterministic and stochastic signal analysis methods. Analog and digital filtering.

Recommended background: ECE 2311, ECE 2312, BME 3011, or equivalent.

This course will be offered in 2006-07, and in alternating years thereafter.

ECE/BME 4023. BIOMEDICAL INSTRUMENTATION DESIGN I.

Cat. II

This course builds on the fundamental knowledge of bioinstrumentation and biosensors presented in BME 3011. Lectures and hands-on laboratory experiments cover the principles of designing, building and testing analog instruments to measure biological events. Design laboratories will include biopotential amplifiers and biosensor/bioinstrumentation systems for the measurement of physiological parameters.

Recommended background: BME 2204, and BME 3011.

This course will be offered in the 2006-07 academic year and in alternating years thereafter.

ECE/BME 4201. BIOMEDICAL IMAGING.

Cat. II

This course is a practical introduction to biomedical image processing using examples from various branches of medical imaging. Topics include: point operations, filtering in the image and Fourier domains, image reconstruction in computed tomography and magnetic resonance imaging, and data analysis using image segmentation. Review of linear-systems theory and the relevant principles of physics. Course work uses examples from microscopy, computed tomography, X-ray radiography, and magnetic resonance imaging. A working knowledge of undergraduate signal analysis and linear algebra is desirable. Facility with a high-level programming language is recommended.

The course will be offered in 2006-07, and in alternating years thereafter.

ECE 4304. COMMUNICATION SYSTEMS ENGINEERING.

Cat. I

This course introduces the theory and performance analysis of communication in noise. The mathematical treatment of noise as a random process is developed in the context of baseband and passband transmission systems. The performance of analog transmission systems is developed and the tradeoff between bandwidth and performance is exposed. The optimum PCM receiver is derived and introduced the general concept of decision theory and signal space representation of decision systems. A treatment of coding theory for error detection, correction and compression leads to the development of Shannon's information theory and the ultimate performance of digital transmission systems. Finally, concepts that underly modern digital data computer network systems are introduced.

Recommended background: ECE 3311 and MA 2621.

ECE 4703. REAL-TIME DIGITAL SIGNAL PROCESSING.

Cat. I

This course provides an introduction to the principles of real-time digital signal processing (DSP). Topics include: design of real-time DSP architectures, sampling and quantization of continuous time signals, design and implementation of FIR and IIR digital filters, and theory and application of the Fast Fourier Transform (FFT). The emphasis of the course is on the design and implementation of DSP algorithms. The algorithms are implemented on personal, portable DSP boards that the students can either program in the lab or purchase for use on their home computers. This course features an interactive studio format with mini-lectures and labs integrated into three-hour sessions. This format allows the students to try out the algorithms and methods shown in class immediately, with the instructor nearby to lend assistance and advice.

Recommended background: ECE 2312, ECE 2801, experience in C programming.

Suggested background: ECE 3311 (helpful but not necessary).

Students may not receive credit for ECE 4703 if they have received credit for ECE 3703.

ECE 4801. ADVANCED COMPUTER SYSTEM DESIGN

Cat. I

This course continues the development of advanced computer systems and focuses on the architectural design of standalone embedded and high-performance microprocessor systems.

Topics: advanced microprocessor architecture, embedded systems, RISC and CISC, interrupts, pipelining, DMA, cache and memory system design, high-performance system issues.

Recommended background: ECE 3803 or equivalent.

ECE 4902. ANALOG INTEGRATED CIRCUIT DESIGN.

Cat. I

This course introduces students to the design and analysis of analog integrated circuits such as operational amplifiers, phase-locked loops, and analog multipliers.

Topics: integrated circuit building blocks: current mirrors and sources, differential amplifiers, voltage references and multipliers, output circuits. Computer-aided simulation of circuits. Layout of integrated circuits. Design and analysis of such circuits as operational amplifiers, phase-locked loops, FM detectors, and analog multipliers. Laboratory exercises.

Recommended background: familiarity with the analysis of linear circuits and with the theory of bipolar and MOSFET transistors. Such skills are typically acquired in ECE 3204.

Suggested background: ECE 3901.

ECE 4904. SEMICONDUCTOR DEVICES.

Cat. I

The purpose of this course is to introduce students to the physics of semiconductor devices and to show how semiconductor devices operate in typical linear and nonlinear circuit applications. This material complements the electronics sequence of courses and will draw illustrative examples of electronic circuit applications from other courses. Topics: carrier transport processes in semiconductor materials. Carrier lifetime. Theory of p-n junctions. Bipolar transistors internal theory, dc characteristics, charge control, Ebers-Moll relations; high frequency and switching characteristics, hybrid- π model; n- and p-channel MOSFETS, CMOS.

Recommended background: ECE 2201. Suggested background: ECE 3204 (helpful but not necessary).

Students may not receive credit for ECE 4901 if they have received credit for ECE 3901.

ENGINEERING SCIENCE INTERDISCIPLINARY

ES 1020. INTRODUCTION TO ENGINEERING.

Cat. I

This course is for first year students with an interest in engineering. The course focuses on the design process. Students are introduced to engineering through case studies and reverse engineering activities. Students will learn the steps in the design process and how engineers use this process to create new devices. Teams of students are then assigned a design project that culminates in building and evaluating a prototype in their design. Results of the design project are presented in both oral and written reports. This course does not require any prior engineering background.

Note: This course can be used towards the Engineering Science and Design distribution requirement in IE, ME, and MFE.

ES 1310. INTRODUCTION TO COMPUTER AIDED DESIGN.

Cat. I

This basic course in engineering graphical communications provides a background for all engineering disciplines. The ability to create and interpret standard, well-integrated detail and assembly drawings is a necessity for engineers to communicate ideas. Computer Aided Design software will be used as a tool for creating these engineering design drawings. Multiview and pictorial graphics techniques are integrated with standards for dimensioning, sectioning, and generating detailed engineering drawings. Emphasis is placed on relating drawings to the required manufacturing processes. The design process and aids to creativity are combined with graphics procedures to incorporate functional design requirements in the geometric model.

No prior engineering graphics or software knowledge is assumed.

ES 2001. INTRODUCTION TO MATERIAL SCIENCE.

Cat. I

A beginning course in understanding the structures and properties of metals, ceramics and plastics, in the selection and in the working and heat treated of materials. A course of interest to any engineer, scientist or person involved with materials.

The underlying fundamental theme of materials science is structure-property relationship. Structures covered range from the subatomic, or nuclear level, through the microscopic world to the macroscopic, or gross point of view. Properties investigated may be chemical, mechanical, thermal, nuclear, electrical or optical. The selection, working and thermal treatments of materials are also related to structural changes and thus property alterations.

No formal laboratory, but ample opportunity exists for the student to experiment with the fundamentals presented on a voluntary basis.

Recommended background: prior knowledge of college-level chemistry.

ES 2501. INTRODUCTION TO STATIC SYSTEMS.

Cat. I

This is an introductory course in the engineering mechanics sequence that serves as a foundation for other courses in mechanical engineering. In this course, students will learn to solve for forces and couples in systems that are not accelerating and which are statically determinate. They will also learn to draw shear and bending moment diagrams for beams and how to calculate the centroid and the moment of inertia for areas.

This course qualifies as one of the three courses that mechanical engineering students must complete in the mechanical systems stem.

Topics normally covered include: forces, moments of forces and couples; free body diagrams; equilibrium; friction; distributed loadings; pin trusses; beams and beam loading; suspended cables; first and second moment of area. Force analysis of submerged bodies is addressed in this course.

Recommended background: Differential and Integral Calculus (MA 1022) and elementary vector algebra.

ES 2502. STRESS ANALYSIS.

Cat. I

The first course in engineering mechanics that addresses stress analysis of mechanical and structural elements.

Topics covered include: stresses, strains and deformations in bars, beams, and torsional elements; principal stresses, transverse shear stresses, buckling.

Recommended background: Statics (ES 2501) and elementary vector algebra.

ES 2503. INTRODUCTION TO DYNAMIC SYSTEMS.

Cat. I

Engineers should be able to formulate and solve problems that involve forces that act on bodies which are moving. This course deals with the kinematics and dynamics of particles and rigid bodies which move in a plane.

Topics covered will include: kinematics of particles and rigid bodies, equations of motion, work-energy methods, and impulse and momentum. In this course a basic introduction to mechanical vibration is also discussed. Basic equations will be developed with respect to translating and rotating coordinate systems.

Recommended background: Statics (ES 2501 or CE 2000).

ES 3001. INTRODUCTION TO THERMODYNAMICS.

Cat. I

This course emphasizes system and control volume modeling using the First and Second Laws of Thermodynamics.

Topics include: properties of simple substances, an introduction to availability, cycle analysis.

ES 3002. MASS TRANSFER.

Cat. I

This course introduces the student to the phenomena of diffusion and mass transfer. These occur in processes during which a change in chemical composition of one or more phases occurs. Diffusion and mass transfer can take place in living systems, in the environment, and in chemical processes. This course will show how to handle quantitative calculations involving diffusion and/or mass transfer, including design of process equipment.

Topics may include: fundamentals of diffusional transport, diffusion in thin films; unsteady diffusion; diffusion in solids; convective mass transfer; dispersion; transport in membranes; diffusion with chemical reaction; simultaneous heat and mass transfer; selected mass transfer operations such as absorption, drying, humidification, extraction, crystallization, adsorption, etc.

Recommended background: fundamentals of chemical thermodynamics, fluid flow and heat transfer; ordinary differential equations (MA 2051 or equivalent).

ES 3003. HEAT TRANSFER.

Cat. I

To provide an understanding of fundamental concepts of heat fluxes, to develop understanding of the coupling of fluid mechanics and thermodynamics, and to provide experience in modeling engineering systems and predicting their behavior.

Topics covered include: steady-state and transient conduction exemplified by heat transfer to and from buried pipes, heat losses through furnace walls, response of thermocouple devices, and the effect of adding fins to increase heat transfer rates. Contact resistance. Natural and forced convection. Heat exchanger analysis and design. Convection accompanied by boiling and condensation. Blackbody radiation. Thermal radiation within an enclosure including diffuse and gray surfaces. Radiation accompanied by conduction and with motion.

Recommended background: Ordinary Differential Equations (MA 2051).

ES 3004. FLUID MECHANICS.

Cat. I

A study of the fundamental laws of statics, kinematics and dynamics applied to fluid mechanics. The course will include fluid properties, conservation of mass, momentum and energy as applied to real and ideal fluids. Laminar and turbulent flows, fluid resistance and basic boundary layer theory will also be considered.

Recommended background: basic physics, basic differential equations and vectors; third year students.

ES 3011. CONTROL ENGINEERING I.

Cat. I

Characteristics of control systems. Mathematical representation of control components and systems. Laplace transforms, transfer functions, block and signal flow diagrams. Transient response analysis. Introduction to the root-locus method and stability analysis. Frequency response techniques including Bode, polar, and Nichols plots.

This sequence of courses in the field of control engineering (ES 3011) is generally available to all juniors and seniors regardless of department. A good background in mathematics is required; familiarity with Laplace transforms, complex variables and matrices is desirable but not mandatory. All students taking Control Engineering I should have an understanding of ordinary differential equations (MA 2051 or equivalent) and basic physics through electricity and magnetism (PH 1120/1121). Control Engineering I may be considered a terminal course, or it may be the first course for those students wishing to do extensive work in this field. Students taking the sequence of two courses will be prepared for graduate work in the field.

Recommended background: Ordinary Differential Equations (MA 2051) and Electricity and Magnetism (PH 1120, PH 1121).

ES 3323. ADVANCED COMPUTER AIDED DESIGN.

Cat. I

This course exposes the student to computer aided engineering design and geometric modeling using Unix based graphic workstations. The use of geometric models for applications in computer aided mechanical design, engineering analysis and manufacturing is emphasized. Topics may include mechanical design, solid and feature based modeling, variational and parametric design, physical properties, assembly modeling, numerical control, mechanisms, and other analytical methods in engineering design.

Recommended background: familiarity with drafting standards (ES 1310), mechanical systems (ES 2501 or CE 2000, ES 2503) and kinematics (ME 3310) is assumed. Additional background in strength of materials (ES 2502 or CE 2001), machine design (ME 2300, ME 3320), machining and manufacturing methods (ME 1800) and higher level programming capability (CS 1101 or CS 1102) is helpful.

FIRE PROTECTION ENGINEERING

FP 3070. FUNDAMENTALS OF FIRESAFETY ANALYSIS.

Cat. I

This course introduces students of different technical disciplines to analytical methods and techniques to address problems of fire, explosions, or hazardous incidents. Emphasis will be placed on understanding the physical concepts of the problem and their interactions. Quantification will adapt existing procedures to appropriate levels of theoretical and empirical methods in the field of fire science and engineering. Computer applications will be incorporated.

Recommended background: mathematics through differential equations; engineering science; fluid mechanics.

Graduate Fire Protection Engineering Courses of Interest to Undergraduates

FPE 520. FIRE MODELING.

Cat. II

(Prerequisite: FPE 521 or special permission of the instructor.) Advanced topics in fire dynamics, combustion and compartment fire behavior will be discussed within a framework of modeling fire and its effects. Topics include computer modeling of pre-flashover and post-flashover compartment fires, burning characteristics of polymers and other fuels, the effect of fire retardants, products of combustion generation, flame spread models, plume and ceiling jet models and overall toxicity assessment. Some familiarity with computer programming is recommended.

Offered 2007-08 and alternating years thereafter.

FPE 521. FIRE DYNAMICS I.

Cat. I

(Prerequisites: Undergraduate chemistry, thermodynamics [or physical chemistry], fluid mechanics and heat transfer.) This course introduces students to fundamentals of fire and combustion and is intended to serve as the first exposure to fire dynamics phenomena. The course includes fundamental topics in fire and combustion such as thermodynamics of combustion, fire chemistry, premixed and diffusion flames, solid and liquid burning, ignition, plumes and ceiling jets. These topics are then used to develop the basic for introducing compartment fire behavior, pre and post-flashover conditions and smoke movement.

FPE 553. FIRE PROTECTION SYSTEMS.

Cat. I

(Prerequisites: Undergraduate courses in chemistry, fluid mechanics and either thermodynamics or physical chemistry.) This course provides an introduction to automatically activated fire suppression and detection systems. A general overview is presented of relevant physical and chemical phenomena and commonly used hardware in automatic sprinkler, gaseous agent, foam and dry chemical systems. Typical contemporary installations and current installation and approval standards are reviewed.

FPE 554. ADVANCED FIRE SUPPRESSION.

Cat. II

(Prerequisite: FPE 553 or special permission of instructor.) Advanced topics in suppression systems analysis and design are discussed with an aim toward developing a performance based understanding of suppression technology. Automatic sprinkler systems are covered from the standpoint of predicting actuation times, reviewing numerical methods for hydraulic analyses of pipe flow networks and understanding the phenomenology involved in water spray suppression. Special suppression systems are covered from the standpoint of two phase and non-Newtonian pipe flow and simulations of suppression agent discharge and mixing in an enclosure.

Offered 2006-07 and alternating years thereafter.

FPE 555. DETECTION, ALARM AND SMOKE CONTROL.

Cat. II

(Prerequisites: FPE 553. Also FPE 521 and FPE 571 which can be taken concurrently.) Principles of fire detection and using flame, heat and smoke detector technology are described. Fire alarm technology and the electrical interface with fire/smoke detectors are reviewed in the context of contemporary equipment and installation standards. Smoke control systems based on buoyancy and HVAC principles are studied in the context of building smoke control for survivability and safe egress.

Offered 2006-07 and alternating years thereafter.

FPE 563 (OIE 541). OPERATIONS RISK MANAGEMENT.

Cat. I

Risk Management is highly interdisciplinary drawing upon systems engineering and managerial decision making and finance. The basics of risk management including hazard analysis, risk assessment, risk control and risk financing are covered. The course is self-contained and includes material from engineering economy, risk assessment and decision analysis. Group projects can draw from fire protection engineering, hazardous waste management and product liability. The projects serve to emphasize important techniques for quantifying risk and the challenge of integrating risk assessment with managerial decision making.

FPE 565. FIRESAFETY ENGINEERING EVALUATION.

Cat. II

(Prerequisites: FPE 521, FPE 553 and FPE 570.) This course develops techniques to evaluate the firesafety performance of a variety of facilities of the built environment and to produce management plans for decision making. The framework for this course is a firesafety engineering method which decomposes the firesafety system into discrete elements that can be used for quantitative evaluation using a variety of fire protection engineering and fire science materials.

Offered 2006-07 and alternating years thereafter.

FPE 570. BUILDING FIRESAFETY I.

Cat. I

This course focuses on the presentation of qualitative and quantitative means for firesafety analysis in buildings. Fire test methods, fire and building codes and standards of practice are reviewed in the context of a systematic review of firesafety in proposed and existing structures.

FPE 571. PERFORMANCE-BASED DESIGN.

Cat. I

(Prerequisites: FPE 553, FPE 521 and FPE 570 or special permission of instructor.) This course covers practical applications of fire protection engineering principles to the design of buildings. Both compartmented and non-compartmented buildings will be designed for criteria of life safety, property protection, continuity of operations, operational management and cost. Modern analytical tools as well as traditional codes and standards are utilized. Interaction with architects, code officials and an awareness of other factors in the building design process are incorporated through exercises and a design studio.

FPE 572. FAILURE ANALYSIS.

Cat. I

(Prerequisites: FPE 570, FPE 521 and FPE 553 or special permission of the instructor.) Development of fire investigation and reconstruction as a basis for evaluating, and improving firesafety design. Accident investigation theory and failure analysis techniques such as fault trees and event sequences are presented. Fire dynamics and computer modeling are applied to assess possible fire scenarios and the effectiveness of fire protection measures. The products liability aspects of failure analysis are presented. Topics include products liability law, use of standard test methods, warnings and safe product design. Application of course materials is developed through projects involving actual case studies.

FPE 573. INDUSTRIAL FIRE PROTECTION.

Cat. I

(Prerequisites: FPE 553, FPE 521 or special permission of instructor.) Principles of fire dynamics, heat transfer and thermodynamics are combined with a general knowledge of automatic detection and suppression systems to analyze fire protection requirements for generic industrial hazards. Topics covered include safe separation distances, plant layout, hazard isolation, smoke control, warehouse storage and flammable liquid processing and storage. Historical industrial fires influencing current practice on these topics are also discussed.

FPE 574 (CHE 594). PROCESS SAFETY MANAGEMENT.

Cat. I

(Prerequisite: An undergraduate engineering or physical science background.) This course provides basic skills in state-of-the-art process safety management and hazard analysis techniques including Hazard and Operability Studies (HAZOP), Logic Trees, Failure Modes and Effects Analysis (FMEA) and Consequence Analysis. Both qualitative and quantitative evaluation methods will be utilized. Following a case study format, these techniques along with current regulatory requirements will be applied through class projects addressing environmental health, industrial hygiene, hazardous materials, fire or explosion hazard scenarios.

FPE 575. EXPLOSION PROTECTION.

Cat. II

Principles of combustion explosions are taught along with explosion hazard and protection applications. Topics include a review of flammability limit concentrations for flammable gases and dusts; thermochemical equilibrium calculations of adiabatic closed vessel deflagration pressures and detonation pressures and velocities; pressures development as a function of time for closed vessels and vented enclosures; the current status of explosion suppression technology; and vapor cloud explosion hazards.

Offered 2007-08 and alternating years thereafter.

FPE 580. SPECIAL PROBLEMS.

Individual or group studies on any topic relating to fire protection may be selected by the student and approved by the faculty member who supervises the work.

FPE 581. SEMINAR.

Reports on current advances in the various branches of fire protection.

FPE 587. FIRE SCIENCE LABORATORY.

Cat. II

(Prerequisite: FPE 521.) This course provides overall instruction and hands-on experience with fire science related experimental measurement techniques. The objective is to expose students to laboratory-scale fire experiments, standard fire tests and state-of-the-art measurement techniques. The Lateral Ignition and Flame Transport (LIFT) apparatus, state-of-the-art smoke detection systems, closed-up flashpoint tests and gas analyzers are among the existing laboratory apparatus. Fire related measurement techniques for temperature, pressure, flow and velocity, gas species and heat fluxes, infrared thermometry, Laser Doppler Velocimetry (LVD) and Laser Induced Fluorescence (LIF) will be reviewed.

Offered 2006-07 and alternating years thereafter.

FPE 590. M. S. THESIS.**FPE 690. PH.D. DISSERTATION.**

HUMANITIES AND ARTS

ART HISTORY/ARCHITECTURE (AR)

AR 1100. ESSENTIALS OF ART.

Cat. I

This course provides an introduction to the basic principles of two and three-dimensional visual organization. The course focuses on graphic expression, idea development, and visual literacy. Students will be expected to master basic rendering skills, perspective drawing, concept art, and storyboarding through traditional and/or computer-based tools.

AR 1101. DIGITAL IMAGING AND COMPUTER ART.

Cat. I

This course focuses on the methods, procedures and techniques of creating and manipulating images through electronic and digital means. Students will develop an understanding of image alteration. Topics may include color theory, displays, modeling, shading, and visual perception.

Recommended background: AR 1100.

AR 1111. INTRODUCTION TO ART HISTORY.

Cat. I

How do we understand a work of art? Through readings and the study of objects at the Worcester Art Museum, the student will survey the major developments in world art and be introduced to various critical perspectives in art history. Students will learn how art historians work with primary materials and formulate arguments. No previous knowledge of art is required. (Formerly HU 1014.)

AR 2111. MODERN ART.

Cat. I

The successive phases of modern art, especially painting, are examined in light of the late-19th-century break with the 600-year old tradition of representation.

Topics covered include: non-objective art and abstraction—theory and practice, primitivism in modern art, surrealism and the irrational, the impact of photography on modern painting, cubism and collage, regionalism and abstract expressionism as American art forms, Pop art and popular culture, and the problem of concept versus representation in art. (Formerly AR 2300.)

AR 2113. TOPICS IN 19TH- AND 20TH-CENTURY ARCHITECTURE.

Cat. I

This course considers the built environment in a non-technical way. It explores changes in architectural style as responses to the industrial transformation of Europe and America and to changing ideas about the purpose of art. The focus will vary from year to year and may concentrate on new uses of past styles, the architecture and planning of the industrial city, the careers of the great modern architects from Wright to Mies, or current topics in design. The central topic will remain the development of the Modern Movement in architecture. Students will use local buildings to learn the methods of architectural history and explore the aesthetic effects of architecture.

AR 3000. THE ART OF ANIMATION.

Cat. I

This course examines the fundamentals of computer generated 2D and 3D modeling and animation as they apply to creating believable characters and environments. Students will learn skeletal animation and traditional polygonal animation, giving weight and personality to characters through movement, environmental lighting, and changing mood and emotion. Students will be expected to master the tools of 3D modeling and skinning, and scripting of behaviors.

Recommended background: AR 1101.

AR 3112. MODERNISM, MASS CULTURE, AND THE AVANT-GARDE.

Cat. I

What is the role of art to be in the modern world? Can art be a vehicle for social change, or should art be a self-critical discipline that pursues primarily aesthetic ends? What is the relationship between art and mass culture? Using primary sources, this course focuses on some of the theorists and artistic trends since the mid-nineteenth century that have sought to resolve this dilemma. These include: Ruskin, Morris and the Arts and Crafts Movement; Art For Art's Sake; the German Werkbund and the Bauhaus; American industrial design.

AR/ID 3150. LIGHT, VISION AND UNDERSTANDING.

Cat. II

By using material from the sciences and the humanities, this course examines the ways in which ideas of knowledge and of human nature have been fashioned.

The specific topics include physical theories about light, biological and psychological theories of visual perception, and artistic theories and practices concerned with representation. The mixing of material from different academic disciplines is deliberate, and meant to counter the notion that human pursuits are “naturally” arranged in the neat packages found in the modern university. The course draws upon the physical and social sciences, and the humanities, to examine how those fields relate to one another, and how they produce knowledge and self-knowledge. Cultural as well as disciplinary factors are assessed in this process.

Light, Vision and Understanding is conducted as a seminar. The diverse collection of reading materials includes a number of primary texts in different fields. In addition, the students keep a journal in which they record the results of numerous individual observations and experiments concerning light and visual perception. The course can fit into several Sufficiency areas as well as serve as a starting point for an IQP. There are no specific requirements for this course, although some knowledge of college-level physics, as well as an acquaintance with the visual arts, is helpful.

This course will be offered in 2006-07 and in alternating years thereafter.

ENGLISH (EN)

EN 1221. INTRODUCTION TO DRAMA: THEATRE ON THE PAGE AND ON THE STAGE.

Cat. I

The plays studied will give the student an understanding of the forms of drama, the styles of theatre performance and production, and the emergence of new forms and styles. Types of drama studied could include Greek Tragedy and Comedy, Roman Comedy, Cycles and Pageants of the Middle Ages, Shakespeare, Restoration, Romanticism, Neo-Classicism, French Comedy, Realism, Naturalism, and the eclectic forms in the Twentieth Century. Discussions, research and writing projects, and performance activities will offer the student experience in the theory and practice studied in the course.

EN 1222. SHAKESPEARE IN THE AGE OF ELIZABETH.

Cat. I

This course is an introduction to Shakespeare, his theatre, and some important concepts of his world. Students will have the opportunity to sample representative Shakespearean tragedies, comedies, and histories. In addition to class discussions and scene work, students will be able to enhance their readings by analyzing video recordings of the plays.

EN 1231. AMERICAN LITERATURE: BEGINNINGS THROUGH HAWTHORNE.

Cat. I

This survey course covers American literature from its beginnings in the colonial period through the works of Nathaniel Hawthorne in the early nineteenth century. Students will read literary works in a variety of genres (narratives, poems, sermons, plays, stories, and novels) that reflect the emerging nation's struggle for cultural self-definition. Topics will include the literature of travel and discovery, the faith of the colonial founders, the quest for a distinctive national literature, and the rise of early American fiction.

EN 1242. INTRODUCTION TO ENGLISH POETRY.

Cat. I

This course surveys the poems of our language. From the Anglo-Saxon poems to the popular verse of Tennyson, the songs and the poets are legion: Chaucer, Raleigh, Spenser, Marlowe, Shakespeare, Jonson, Donne, Herrick, Milton, Blake, Wordsworth, Coleridge, Byron, Keats, Tennyson, Browning, and Hopkins. The England that nourished these writers will be viewed through their ballads,

lyrics, sonnets, epigrams, and epics. "Not marble nor the gilded monuments of princes shall outlive this powerful rhyme."

EN 1251. INTRODUCTION TO LITERATURE.

Cat. I

This course introduces the student to a variety of critical perspectives necessary to an understanding and appreciation of the major forms, or genres, of literary expression (e.g., novel, short story, poetry, drama, and essay). Writing and class discussion will be integral parts of this course.

EN 1257. INTRODUCTION TO AFRICAN AMERICAN LITERATURE AND CULTURE.

Cat. II

This course examines the formation and history of the African American literary tradition from slave narratives to contemporary forms in black popular culture. The course will explore some genres of African American writing and their relation to American literature and to black cultural expression.

This course will be offered in 2006-07 and in alternating years thereafter.

EN/WR 2211. ELEMENTS OF WRITING.

Cat. I

This course is designed for students who wish to work intensively on their writing. The course will emphasize the processes of composing and revising, the rhetorical strategies of expository prose, and the interaction between writer and audience. In a workshop setting, students will write a sequence of short papers and complete one longer writing project, learn to read critically and respond helpfully to each other's writing, and make oral presentations from written texts.

EN 2221. AMERICAN DRAMA.

Cat. I

An investigation into the development of American drama from its beginnings to the present. The history of the emergence of the legitimate theatre in this country will be followed by reading important plays, including the works of O'Neill, Williams, Mamet, Norman, Henley, and others. Discussion of the growth of regional theatres and their importance to the continuation of theatre as a serious and non-profit art form will be included in the course. The student will investigate the importance of theatre practice in the evolution of the dramatic literature of the country.

EN 2222. THEATRE WORKSHOP.

Cat. I

A workshop course which offers the student the opportunity to explore theatre through creative involvement with playwriting, design, performance, production, and criticism. Students will work in a laboratory situation functioning as a micro-professional theatre which could develop a production that would be staffed and dramaturged from the group.

EN 2224. SHAKESPEARE: NOTHING BUT LOVE.

Cat. II

The course focuses on conflicts between personal desire and societal responsibility in such plays as *As You Like It*, *Antony and Cleopatra*, and *The Winter's Tale*. Through written work and in-class performances, students will examine how Shakespeare both maintains and subverts traditional ideas about marriage and sexual practice. These analyses will take into account contemporary views on gender roles and identity including the early modern cultural "ideal" of the "chaste, silent, and obedient" woman. Students will study Shakespeare's work as literature and also through performance and film adaptations. The WPI library of video recordings will be available for such work.

This course will be offered in 2006-07 and in alternate years thereafter.

EN 2225. THE LITERATURE OF SIN

Cat. II

This course begins with selections from John Milton's provocative version of Adam and Eve's original sin in *Paradise Lost*. Focusing on Milton, John Donne and others, we will examine the theme of sin—political, religious, and sexual—in early modern literature. The events of the English Reformation profoundly influenced these writers, and their personal struggles against societal institutions have greatly influenced subsequent literary expressions of rage and rebellion. Students will also be reading texts by contemporary writers such as David Mamet which address the theme of sin in the modern city.

This course will be offered in 2007-08 and in alternate years thereafter.

EN 2231. AMERICAN LITERATURE: THE RAVEN, THE WHALE, AND THE WOODCHUCK.

Cat. I

Emerson challenged the young nation in "The American Scholar" (1837): If our writers were "free and brave," with words "loaded with life," they would usher in a "new age." The incredibly rich literature that soon followed created an "American Renaissance." This was the Age of Reform (1836-65) in more than literature. Writers were caught up in such burning issues as abolitionism, Union vs. secession, and women's rights. Authors studied may include Emerson, Thoreau, Poe, Fuller, Douglass, Melville, Whitman, and Dickinson.

EN 2232. AMERICAN LITERATURE: TWAIN TO WORLD WAR I.

Cat. I

This survey course covers developments in American literature, particularly the movement towards Realism, during the period of turbulent change between the end of the Civil War and the early years of the twentieth century. Topics will include the rebellion against post bellum sentimentalism, the rise of regional writing, the emerging literature of social protest, and literary responses to advances in science, industry, and urban life. Attention will be given to the works of Mark Twain, a prime exponent of turn-of-the-century literary trends, as well as to other pioneer realists (Wharton and Crane).

EN 2233. AMERICAN LITERATURE: MODERNISM TO THE PRESENT.

Cat. I

This final survey course in American literature covers the modern and contemporary periods, from World War I to the present. The wide-ranging material represents the literary response to the broad intellectual, social, and cultural changes that mark the history of those years of ferment in the United States. The course includes selected works of fiction, drama, poetry, and essays by such writers as William Faulkner, Toni Morrison, Thornton Wilder, Sylvia Plath, Allen Ginsberg, Joy Harjo, and Michael Harper.

EN 2234. MODERN AMERICAN NOVEL.

Cat. II

Selected works of fiction which appeared after World War I will be the focus of this course. F. Scott Fitzgerald, Ernest Hemingway, William Faulkner, or other authors of the early modern period will be studied, but significant attention will also be given to contemporary novelists, such as Alice Walker and Kurt Vonnegut. The cultural context and philosophical assumptions of the novels will be studied as well as their form and technique.

This course will be offered in 2007-08 and in alternating years thereafter.

EN 2235. THE AMERICAN DREAM: MYTH IN LITERATURE AND THE POPULAR IMAGINATION.

Cat. I

American writers from our beginnings have been preoccupied with "The American Dream" as a benchmark for measuring the attainment of our highest ideals as a people. The course examines the political, economic, religious, and rhetorical roots of the concept, assesses its popular and commercial manifestations, and explores the ironies, paradoxes, and continuities that have shaped this national self-image for almost 400 years. Readings include works by Puritan and Revolutionary writers, Native American leaders, Horatio Alger, Jr., William Dean Howells, F. Scott Fitzgerald, Martin Luther King, Jr., Adrienne Rich, Studs Terkel, and Archibald MacLeish.

EN 2237. AMERICAN LITERATURE AND THE ENVIRONMENT.

Cat. II

This course will examine the many ways in which American essayists, novelists, dramatists, and poets have responded to the natural world, and especially to ecological concerns voiced in contemporary times. Among the topics to be discussed in class and in papers are the changing attitudes towards the wilderness, the effects of technology on the environment, and the presence of the spiritual in nature. Readings may include works by such authors as Ernest Hemingway, Wendell Berry, Mary Oliver, Loren Eiseley, and Gary Snyder.

This course will be offered in 2006-07 and in alternating years thereafter.

EN 2238. AMERICAN REALISM.

Cat. I

By examining authors who reacted against the so-called "genteel tradition," this course attempts to show how various subjects (death, sex, war, slum life and racial prejudice) were treated more honestly in short stories and novels after the Civil War. Authors may include Mark Twain, Stephen Crane, W. D. Howells, Edith Wharton, Kate Chopin, Theodore Dreiser, and twentieth century realists.

(Formerly EN 3236. Students who have received credit for this course may not receive credit for EN 2238.)

EN 2241. ENGLISH LITERATURE AFTER SHAKESPEARE.

Cat. II

Participants in this course will examine outstanding works of eighteenth- and nineteenth-century English literature as these works raise the question: Who is man, and what is his relationship to God, nature, and to his fellow creatures? Writers covered may include Swift, Pope, Keats, Browning, and Dickens.

This course will be offered in 2006-07 and in alternating years thereafter.

EN 2242. POPULAR FICTION: READING IN INSTALLMENTS.

Cat. I

Students in this course will have the opportunity to read two major masterpieces of English fiction the way they should be read: slowly, carefully, and with relish. Victorian novels are long and the term is short, but by reading novels in the way in which they were read by their original readers—serially—we can experience masterworks by Charles Dickens and George Eliot at comparative leisure, examining one serial installment per class session.

EN 2243. MODERN BRITISH LITERATURE.*Cat. II*

A survey of major modern British authors. The works of many of these writers reflect the political, religious, and social issues of the twentieth century. New psychological insights run parallel with experiments in the use of myth, stream of consciousness, and symbolism. Authors studied may include Hardy, Conrad, Owen, Joyce, Lawrence, Woolf, Eliot, Yeats, and Orwell.

This course will be offered in 2007-08 and in alternating years thereafter.

EN 2251. MORAL ISSUES IN THE MODERN NOVEL.*Cat. I*

This course focuses on the problem of how to live in the modern world. Emphasis will be placed on the way moral issues evolve within the complications of individual lives, as depicted in fiction. Such authors as Conrad, Kesey, Camus and Ellison show characters struggling with the questions of moral responsibility raised by love, religion, death, money, conformity.

EN 2252. SCIENCE AND SCIENTISTS IN MODERN LITERATURE.*Cat. I*

This course surveys the ways in which modern literature has represented science and scientists. Beginning with Mary Shelley's *Frankenstein*, the origin of what Isaac Asimov calls the "damned Frankenstein complex" is examined. More complex presentations of science and scientists occur in twentieth-century works like Brecht's *Galileo*, Huxley's *Brave New World*, and Dick's *Do Androids Dream of Electric Sheep?*

The course covers major modern works of fiction and drama, including such literary forms as the play, the novel of ideas, and the utopian novel. Attention is focused on the themes (ideas) in, and the structure of, these works.

EN/WR 3011. PEER TUTORING IN WRITING.*Cat. I*

Peer Tutoring in Writing introduced students to the theory and practice of composition. In this course, students research, read, and write about their own and others' literacy practices. Through reading and writing assignments, peer reviews, interviews, presentations, and a tutoring internship in the CCAC, students hone their communication skills while increasing their ability to examine critically the role of communication in the production of knowledge.

EN/WR 3214. WRITING ABOUT DISEASE AND PUBLIC HEALTH.*Cat. I*

This writing workshop focuses on the purposed and genres of writing about disease and public health. We will consider how biomedical writers communicate technical information about disease and public health to general audiences; how writers capture the human experience of disease and health care; how writers treat the public policy implications of disease; and how writers design publicity to promote public health. We will examine such genres as the experimental article, news reports, medical advice, profiles, commentary, and public health messages.

Recommended background: EN 2211 or equivalent writing courses.

Students who have taken EN 3215 may not receive credit also for EN/WR 3214.

EN/WR 3216. WRITING IN THE PROFESSIONS.*Cat. I*

Studies show that engineers spend 80-90% of their professional time engaged in various kinds of communication. This course emphasizes the management contexts of writing in the professions. Focus is on making informed decisions about approaches, styles, problems, issues, sources, strategies, and human-relations aspects of writing in business, industry, and other institutional settings. Special attention is given to business editing and proposal and grant writing.

Recommended background: EN 2211 or equivalent writing course.

EN/WR 3217. CREATIVE WRITING.*Cat. I*

The purpose of this course is to help students develop or improve the skills of written expression. Small groups are formed in which participants present and discuss their original work in either fiction or poetry.

EN 3222. FORMS IN WORLD DRAMA.*Cat. II*

The study of the major forms of world drama beginning with the Greeks and ending with contemporary forms. The student will develop the skills to analyze form and structure through dramatic content. The course may include the works of Sophocles, Euripedes, Aristophanes, the Renaissance, the Restoration, Moliere, Ibsen, Strindberg, Shaw, Pirandello, and others.

This course will be offered in 2007-08 and in alternating years thereafter.

EN 3223. FORMS IN MODERN DRAMA.*Cat. II*

The study of the forms in modern drama and their development from the forms of world drama. Contemporary playwrights studied could include Brecht, Bond, Schaeffer, Handke, and others, and the course will devote some concentration to theatre movements of the twentieth century that have operated with textual revision, minimal text, or no texts. Thus, theatre companies studied might include the work of the Living Theatre, the Open Theatre, and the theatre of Grotowski and Brook.

This course will be offered in 2006-07 and in alternating years thereafter.

EN 3224. SHAKESPEARE SEMINAR.*Cat. II*

This course would allow for the study of various Shakespearean topics in different years. Some representative subjects could include: "Shakespeare and the Arts," "Shakespeare's Contemporaries," "Shakespeare and Science," "Shakespearean Tragedy," "Shakespeare's Roman Plays," "Shakespeare's Histories," "Shakespeare on Film." The topics will be announced before the seminar meets.

This course will be offered in 2007-08 and in alternating years thereafter.

EN 3231. NEW ENGLAND SUPERNATURALISM.*Cat. II*

From the colonial period to the 20th century, New England writers have endowed the region's people and its settings (fields, forests, buildings, factories, cities) with shapes of fear. This course will explore New England's fascination with the supernatural from Puritan writings to the contemporary tale of terror. A primary focus of the course will be the genre of New England Gothicism and its literary conventions. Authors studied may include Hawthorne, Longfellow, Whittier, Freeman, Wharton, Jackson, Lovecraft, and King.

This course will be offered in 2007-08 and in alternating years thereafter.

EN 3232. THE CONCORD WRITERS.*Cat. II*

Rural, mid-19th-century Concord, Massachusetts, witnessed an unprecedented flowering of important and influential American literature. Why Concord? We sample writings of Ralph Waldo Emerson, Henry D. Thoreau, Nathaniel Hawthorne, Bronson Alcott, and Louisa May Alcott to explore matters of cultural background, biography, contemporary events, uses of the past, literary vocation, and sense of place. Emphasis is on these writers' friendships and their creative responses to intellectual and social forces of the day—factors that made Concord a community of highly individualistic writers.

This course will be offered in 2007-08 and in alternating years thereafter.

Students who have received credit for EN 2236 (New England Writers: Concord) may not receive credit for EN 3232.

EN 3233. WORCESTER BETWEEN THE COVERS: LOCAL WRITERS AND THEIR WORKS.*Cat. II*

Worcester has had a rich and varied literary history from Isaiah Thomas's founding of the American Antiquarian Society in the early 1800s to the works of S. N. Behrman, Robert Benchley, Elizabeth Bishop, Esther Forbes, Stanley Kunitz, and Charles Olson in the 20th century. This course will examine selections from Worcester area writers in a number of genres (e.g., fiction, drama, poetry, essay, nonfiction memoir). Attention will be given to the local contexts of these writings as well as to each writer's contributions to the larger continuum of American Literature.

This course will be offered in 2006-07 and in alternating years thereafter.

Students who have received credit for EN 2236 (New England Writers: Worcester) may not receive credit for EN 3233.

EN 3234. MODERN AMERICAN POETRY.*Cat. II*

This course is a study of selected American poets and their reactions to the ferment of the modern period. A thematic approach to poetry will be emphasized. Included in the course are modern poets such as Robert Frost, T. S. Eliot, E. E. Cummings, and Marianne Moore, as well as contemporary poets such as Rita Dove, Li-Young Lee, and Robert Pinsky.

This course will be offered in 2006-07 and in alternating years thereafter.

EN 3237. PURSUING MOBY-DICK.*Cat. II*

Since 1851, readers of Herman Melville's masterpiece have joined in the chase for the "meaning" of the White Whale. After briefly examining the philosophical context of Emersonian idealism and the literary example of Hawthorne, the course is devoted solely to a close reading of *Moby-Dick*—one of the most innovative and mysterious novels in the English language. "Whose" book is it, anyway? Captain Ahab's? Ishmael's? The Whale's? The reader's? We conclude by surveying major critical approaches to the novel.

This course will be offered in 2006-07 and in alternating years thereafter.

EN 3248. THE ENGLISH NOVEL.*Cat. I*

Participants in this seminar will examine the English novel from its origins in the eighteenth century to its twentieth-century forms, exploring the rich variety of ways a writer may communicate a personal and social vision. The novels treat love, travel, humor, work, adventure, madness, and self-discovery; the novelists may include Fielding, Austen, Dickens, Eliot, Wodehouse, and Woolf.

EN ----. DRAMA/THEATRE PERFORMANCES.*TH: IS/P*

One-sixth unit of credit will be awarded at the conclusion of two successive terms of participation. Performance activities currently receiving credit are:

- TH 1225 Theatre Production Practicum
- TH 2225 Acting
- TH 2227 Advanced Acting
- TH 2229 Advanced Theatre Production Practicum
- TH 3225 Directing
- TH 3227 Advanced Directing
- TH 3229 Dramaturgy
- TH 4225 Theatre Technology Design
- TH 4227 Advanced Theatre Technology Design
- TH 4229 Advanced Dramaturgy

Credit would be given on the condition that the performance takes place in a WPI performance directed or advised by a part- or full-time WPI instructor.

Note: A maximum of two one-sixth credits, or a total of one-third unit, may be applied toward the five courses, or five one-third units, taken prior to the final sufficiency term.

IS 1811. WRITING FOR NON-NATIVE SPEAKERS OF ENGLISH.*Cat. I*

This course offers, through conferences, tutorial sessions and extensive writing practice, a review of English composition principles for international students.

The following topics are included: the motivation of the writer; basic grammar; organization of the paragraph, sentence, and overall essay or report; vocabulary and word choice; spelling hints; and style. Much emphasis is given to the development of effective revising techniques. This is a course for those electing the "Basic Sufficiency for International Students."

IS 1812. SPEECH FOR NON-NATIVE SPEAKERS OF ENGLISH.*Cat. I*

This course focuses on developing international students' ability to speak effectively, organize ideas logically, improve voice and diction, and use visual aids. Television and audiotapes are used to record competence and poise. This is a course for those electing the "Basic Sufficiency for International Students."

GERMAN (GN)

GN 1511. ELEMENTARY GERMAN I.*Cat. I*

An intensive language course designed to teach concise expression of ideas in writing and speaking. Basic grammar and significant cultural aspects are introduced through the aid of readings, audio-recordings, video, and oral group interaction. (Formerly GN 2616.)

GN 1512. ELEMENTARY GERMAN II.*Cat. I*

A continuation of Elementary German I.
Recommended background: GN 1511.

GN 2511. INTERMEDIATE GERMAN I.*Cat. I*

A continuation of Elementary German II, with increased emphasis on oral and written expression. Basic textbook is supplemented by a collection of simple literary texts by the Grimm brothers, Brecht, and Bichsel.

Recommended background: Elementary German II.

GN 2512. INTERMEDIATE GERMAN II.*Cat. I*

A continuation of Intermediate German I.
Recommended background: GN 2511.

GN 3511. ADVANCED GERMAN I.*Cat. I*

Reading and in-class discussion of a wide variety of contemporary nonfictional and fictional texts. Some video viewing. Weekly brief writing assignments and continued expansion of vocabulary. Weekly vocabulary quiz. Review of grammar and introduction to advanced stylistic problems.

Recommended background: Intermediate German II.

GN 3512. ADVANCED GERMAN II.*Cat. I*

A continuation of Advanced German I.
Recommended background: GN 3511.

GN 3513. SURVEY OF GERMAN CIVILIZATION AND CULTURE FROM 1871 TO THE PRESENT.*Cat. II*

Conducted entirely in German, the course presents an overview of the development of modern Germany and its culture since the founding of the Second Empire. Background readings in German and English provide the basis for in-class discussion of selected authentic German texts of various kinds: literary works, official documents, political manifestos, letters, and diaries. At least one film will be shown. A number of recurring themes in German culture will inform the content of the course: authoritarianism versus liberalism, idealism versus practicality, private versus public life.

This course will be offered in 2006-07 and in alternating years thereafter.

Recommended background: GN 3511 (Advanced German I) and GN 3512 (Advanced German II) or equivalent.

GN 3514. SEMINAR ON SELECTED TOPICS IN GERMAN LITERATURE.*Cat. II*

The content of the seminar will change from time to time. The course will focus either on an author (e.g., Goethe, Heine, Kafka, Gunter Grass, Christa Wolf), a genre (e.g., lyric poetry, drama, narrative prose), a literary movement (e.g., Romanticism, expressionism), or a particular literary problem (e.g., literature and technology, writing and the Holocaust, writing and the city). The seminar will be conducted entirely in German.

The course will be offered in 2007-08 and in alternating years thereafter.

Recommended background: GN 3511 (Advanced German I) and GN 3512 (Advanced German II) or equivalent.

GN/ID 3515. TECHNICAL TOPICS IN GERMAN.*Cat. II*

Technical topics are addressed and discussed entirely in German. German-speaking faculty from several WPI science and engineering departments, as well as lecturers from outside the university, present a range of topics at an introductory level. The focus of the course is on the use and development of German language skills in a technical context, which will include lectures, presentations, discussions, problem solving, and writing on technical topics. The course can be counted towards a Sufficiency or a minor in German. As the course is to be conducted entirely in German, knowledge of German sufficient for advanced conversations and detailed writing (such as students acquire in GN 3512, Advanced German II, or equivalent) is strongly recommended.

This course will be offered in 2006-07, and in alternating years thereafter.

HISTORY (HI)

HI 1311. INTRODUCTION TO AMERICAN URBAN HISTORY.*Cat. I*

An introduction to the history of the American city as an important phenomenon in itself and as a reflection of national history. The course will take an interdisciplinary approach to study the political, economic, social, and technological patterns that have shaped the growth of urbanization. In addition to reading historical approaches to the study of American urban history, students may also examine appropriate works by sociologists, economists, political scientists and city planners who provide historical perspective.

HI 1312. INTRODUCTION TO AMERICAN SOCIAL HISTORY.*Cat. I*

An introduction to the historical study of American society. It addresses two questions: What is social history? And how do social historians work?

HI 1313. INTRODUCTION TO THE STUDY OF FOREIGN POLICY AND DIPLOMATIC HISTORY.*Cat. I*

An introduction to the various components of U.S. foreign policy decision-making and the basic techniques of diplomatic history. The course will focus on one or two topics in the history of American foreign relations, using a variety of primary documents and secondary sources.

HI 1314. INTRODUCTION TO EARLY AMERICAN HISTORY.*Cat. I*

An introduction to historical analysis through selected periods or themes in the history of America before the Civil War. A variety of readings will reflect the various ways that historians have attempted to understand the development of America.

HI 1321. INTRODUCTION TO EUROPEAN SOCIAL HISTORY.*Cat. I*

An introduction to the study of modern European social history since the Industrial Revolution. Topics will include industrialization in Britain and Europe, class formation, gender and the condition of women, technology and economy, culture and society. Students will learn to work with historical sources, to formulate arguments, to read critically, and to write clearly.

No prior knowledge of European history is required.

HI 1322. INTRODUCTION TO EUROPEAN CULTURAL HISTORY.*Cat. I*

In this course students think through some of the major intellectual currents that have defined modern Western Civilization. Topics include the philosophical impact of science on modern thought, the development of liberalism and socialism, the crisis of culture in the twentieth century. Students read selections from major thinkers in the Western tradition and develop their skills at critical thinking, analysis, oral and written argument.

No prior knowledge of European history is required.

HI 1331. INTRODUCTION TO THE HISTORY OF SCIENCE.*Cat. I*

An introduction to the methods and source material historians use to study science. Topics covered will range from early Greek science to Newton and the Scientific Revolution in the 17th-century.

Suggested background: elementary knowledge of science.

HI 1332. INTRODUCTION TO THE HISTORY OF TECHNOLOGY.*Cat. I*

An introduction to concepts of historical analysis — i.e., the nature and methodology of scholarly inquiry about the past — through the concentrated examination of selected case studies in the history of technology. Possible topics include: the influence of slavery on the development of technology in the ancient world and the middle ages; the power revolution of the middle ages; the causes of the Industrial Revolution in 18th-century Britain; and the emergence of science-based technology in 19th-century America.

HI 1341. INTRODUCTION TO GLOBAL HISTORY.*Cat. I*

An introduction to the study of global history since 1500. Topics include global expansion, the Columbian exchange, and the slave trade; Renaissance, Reformation, and revolution in Europe; global industrialization, imperialism, and nation building; the world wars and revolutionary movements; decolonization and the Cold War. The course will also discuss case studies of developing nations of interest to students. Especially appropriate as background for students interested in International Studies or any of WPI's global Project Centers.

HI 2311. AMERICAN COLONIAL HISTORY.*Cat. I*

This course surveys early American history up to the ratification of the Constitution. It considers the tragic interactions among Europeans, Indians, and Africans on the North American continent, the growth and development of English colonies, and the revolt against the Empire that culminated in the creation of the United States of America.

HI 2313. AMERICAN HISTORY, 1789-1877.*Cat. I*

This course surveys American history from the Presidency of George Washington to the Civil War and its aftermath. Topics include the rise of American democracy, the emergence of middle-class culture, and the forces that pulled apart the Union and struggled to put it back together.

HI 2314. AMERICAN HISTORY, 1877-1920.*Cat. I*

This course surveys the transformation of the United States into an urban and industrial nation. Topics will include changes in the organization of business and labor, immigration and the development of cities, the peripheral role of the South and West in the industrial economy, politics and government in the age of "laissez-faire," and the diverse sources and nature of late 19th- and early 20th-century reform movements.

HI 2315. THE SHAPING OF POST-1920 AMERICA.*Cat. I*

This course surveys the major political, social, and economic changes of American history from 1920 to the present. Emphasis will be placed on the Great Depression, the New Deal, suburbanization, McCarthyism, the persistence of poverty, the domestic effects of the Vietnam war, and recent demographic trends.

HI 2316. AMERICAN FOREIGN POLICY FROM WOODROW WILSON TO THE PRESENT.*Cat. I*

This survey of American diplomatic history begins with the legacy of Woodrow Wilson, continues through our apparent isolation in the 1920's, American neutrality in the 1930's, World War II, the early and later Cold War periods, and concludes with an overview of the current global involvement of the United States.

HI 2317. LAW AND SOCIETY IN AMERICA, 1865-1910.*Cat. I*

This survey course explores the dramatic expansion of government's role in American life between the Civil War and World War I. It does so by examining the response of constitutional, common, and statutory law to the social, economic, and political change associated with this pivotal period in the nation's history.

HI 2321. EUROPE FROM THE OLD REGIME TO WORLD WAR I.*Cat. I*

A survey of the major socio-economic, political, and cultural developments in European history from the Old Regime to World War I. The course will focus upon those factors and events that led to the formation of modern European society: Nation-State building, The French Revolution, industrialization; liberalism, democracy, and socialism; national unification of Italy and Germany; the coming of World War I.

No prior knowledge of European history is required.

HI 2322. EUROPE SINCE WORLD WAR I.*Cat. I*

A survey of the major political, socio-economic, and cultural developments in European history since World War I. The course will focus upon those factors and events that have led to the current world situation: the World Wars, fascism and communism, the Holocaust, the Cold War, the welfare state, decolonization, post-industrial society, popular culture, the collapse of communism, contemporary Europe.

No prior knowledge of European history is required.

HI 2324. INDUSTRY AND EMPIRE IN BRITISH HISTORY.*Cat. I*

A survey of modern Britain from the 18th century to the present. Topics include the British state and national identity, the industrial revolution, political and social reform, the status of women, sport and society, Ireland, the British Empire, the World Wars, the welfare state, economic decline. Especially appropriate as background for students planning IQP's or Sufficiency Projects in London.

No prior knowledge of British history is required.

HI 2325. MODERN FRANCE.*Cat. II*

This course examines the historical origins of modern France and the distinguishing features of French society and culture. Some of the topics covered include: Bourbon absolutism; the cause and effects of the French Revolution; the struggle for democratic liberalism in the 19th century; class and ideological conflict in the Third Republic; Vichy fascism, and present-day politics in the Fifth Republic.

No prior knowledge of French history is required.

This course will be offered in 2006-07 and in alternating years thereafter.

HI 2328. HISTORY OF REVOLUTIONS IN THE TWENTIETH CENTURY*Cat. II*

A survey of some of the most important revolutionary movements of the twentieth century. We may consider topics such as racial, nationalist, feminist and non-violent revolutionary ideologies, communist revolution, the "green" revolution and cultural revolution. No prior knowledge of the history of revolutions is expected.

This course will be offered in 2007-08 and in alternate years thereafter.

HI 2331. AMERICAN SCIENCE AND TECHNOLOGY TO 1859.*Cat. I*

A survey, stressing the development of a scientific community, of the content and character of American science (and, to some degree, American technology) from the first European explorations until just before the publication of *The Origin of Species*. Topics include: medieval science in the new world; the Scientific Revolution and its influence in America; the American Industrial Revolution; the rise of science as a profession; the interplay of science and technology with the state and federal governments.

HI 2332. AMERICAN SCIENCE AND TECHNOLOGY FROM 1859.*Cat. I*

A survey of the content and character of American science (and, to some degree, American technology and medicine) from the publication of *The Origin of Species* through the present. Topics include: Darwinism and Social Darwinism in America; scientific agriculture and the federal government; scientific technology and the rise of an industrial society; scientific education and the new universities; positivism and the growth of the physical sciences; the new biology and medicine; conservation, scientific management, the gospel of efficiency and progressivism; science, World War I and the 1920's; the intellectual migration and its influence; science, technology and World War II; Big Science and the Military-Industrial-Scientific Complex; attacks on Big Science.

HI 2333. HISTORY OF SCIENCE FROM 1700.*Cat. I*

A survey of major developments in science since Newton. Topics may include: 18th century physical science within the context of the Enlightenment; the revolution in biological thought in the 19th century; relativity and the quantum theory; key concepts such as the conservation of energy and the electromagnetic field; the changing structure of the scientific community.

A knowledge of advanced science is not required but would be advantageous.

HI 2334. EUROPEAN TECHNOLOGICAL DEVELOPMENT.*Cat. I*

A survey of the development of technology in Europe from the late medieval period to World War I. Emphasis will be placed on understanding the evolution of technology within its cultural, social, and political contexts. Topics may include the military, mechanical, maritime, and building technologies of the medieval and Renaissance periods; the commonly misunderstood figure of Leonardo da Vinci; the causes and nature of the Industrial Revolution; the effects of the British Industrial Revolution in France and Germany in the 19th century; the transition from craft-based industries to those that are science based such as the dyestuffs and electrical power industries; World War I as a technological conflict.

HI 2341. CONTEMPORARY WORLD ISSUES IN HISTORICAL PERSPECTIVE.*Cat. II*

This course examines the historical origins of contemporary global crises and political transformations. Students keep abreast of on-going current events through periodical literature and explore the underlying long-term causes of these events as analyzed by scholarly historical texts. Topics will vary each time the course is taught but may include such topics as: The Israeli-Palestinian Conflict, Democratization in Africa, The Developing World and Globalization. No prior knowledge of world history is required.

This course will be offered in 2007-08 and in alternating years thereafter.

HI 2342. CULTURES IN CONTACT: THE WORLD TO 1650.*Cat. I*

This course surveys global history from the adoption of agriculture to the initial stage of global colonialism, focusing on major and informative instances of intercultural contact. The course is organized around case studies that may include the agricultural revolution; the diffusion of religious traditions; Rome as multicultural empire; the Silk Road; exchanges around the Indian Ocean; the expansion of Islam; The Crusades; European encounters with the New World; and Japanese contact with the West.

This course will be offered in 2006-07 and in alternating years thereafter.

HI 2343. EAST ASIA: CHINA AT THE CENTER*Cat. II*

This course will explore two thousand years of Asian participation in an international system, in Asia and with the rest of the world. Whether ruled by Chinese, Turks, Mongols or Manchus, China has been the political and cultural center of East Asia. Understanding the role of this superpower is critical to Asian and world history. The course will focus on themes such as the cosmopolitan experience, the early development and application of 'modern' ideas such as bureaucracy, market economy, and paper currency, and the centrality of religious ideology as a tool in statecraft. No prior knowledge of Asian history is required.

This course will be offered in 2006-07, and in alternate years thereafter.

HI 3311. AMERICAN LABOR HISTORY.*Cat. I*

This seminar course will deal with the history of organized labor in America as well as with the historic contributions of working people, whether unionized or not, to the growth and development of American ideas, politics, culture, and society.

Among the topics to be covered will be: the origins, growth, and expansion of trade and industrial unionism; the roots and development of working class consciousness; the underlying causes and eventual resolution of labor disturbances; the philosophical and ideological perspectives of the labor movement. Students will explore topics raised by common readings via written papers, seminar presentations, and work with primary source materials.

Suggested background: HI 2314, American History, 1877-1920; or HI 2315, The Shaping of Post-1920 America.

HI 3312. TOPICS IN AMERICAN SOCIAL HISTORY.*Cat. I*

A seminar course on analysis of selected aspects of social organization in American history, with emphasis on the composition and changing societal character of various groups over time, and their relationship to larger social, economic, and political developments. Typical topics include: communities, families, minorities, and women.

Suggested background: Some college-level American history.

HI 3314. THE AMERICAN REVOLUTION.*Cat. I*

This seminar course considers the social, political, and intellectual history of the years surrounding American independence, paying particular attention to the changes in society and ideas that shaped the revolt against Great Britain, the winning of independence, and the creation of new political structures that led to the Constitution.

HI 3321. TOPICS IN MODERN EUROPEAN HISTORY.*Cat. II*

This seminar course examines topics in the cultural, socio-economic and political history of modern Europe, with a focus on Great Britain. Topics may vary each year among the following: nationalism, class and gender, political economy, environmental history, sport and society, film and history. Readings will include primary and secondary sources.

This course will be offered in 2007-08 and in alternating years thereafter.

HI 3323. TOPICS IN THE WESTERN INTELLECTUAL TRADITION.*Cat. II*

This seminar course in the history of ideas focuses each year on a different theme within the intellectual-cultural traditions of Western Civilization. Some topics are the following: The Impact of the New Physics on 20th Century Philosophy; The Social History of Ideas; The Enlightenment and the French Revolution; Sexuality, Psycho-analysis, and Revolution. The course is structured around classroom discussion of major texts on the topic under study and a related research paper.

This course will be offered in 2007-08 and in alternating years thereafter.

HI 3331. TOPICS IN SCIENCE, TECHNOLOGY, AND SOCIETY.*Cat. I*

A seminar course on the relationships among science, technology, and society in Europe through a series of case studies. Topics from which the case studies might be drawn include: the harnessing of science for industrial purposes; the role of the chemical industry in war; the function of the science advisor in government; the military-industrial complex in Nazi Germany; the political views and activities of major scientists such as Einstein.

Suggested background: Courses in European history and the history of science and technology.

HI 3333. TOPICS IN AMERICAN TECHNOLOGICAL DEVELOPMENT.*Cat. I*

A seminar course examining selected examples of technological change in the United States. Topics from which these case studies might be chosen include: colonial technology; mechanization of ante-bellum industry; the impact of science on Gilded-Age technology; 20th-century behavioral technologies; the evolution of the military-industrial complex; the Manhattan Project; the exploitation of space; computers and post-World-War-II technology; and the emergence of biotechnology. In addressing these cases, this seminar will employ and seek to evaluate one or more significant historical theses about the nature of technological change.

Suggested background: Some familiarity with the basic outlines and concerns of both American history and the history of American technology.

HI 3341. TOPICS IN IMPERIAL AND POSTCOLONIAL HISTORY.*Cat. II*

This seminar course examines topics in the history of European imperialism, colonialism, and the postcolonial aftermath. Topics vary each year among the following: culture and imperialism, the expansion of Europe, the economics of empire, travel and exploration narratives, imperialism in literature and anthropology, decolonization in Asia and Africa, postcolonial studies. Readings will include primary and secondary sources.

This course will be offered in 2006-07 and in alternating years thereafter.

HI 3342. TOPICS IN COMPARATIVE CIVILIZATIONS.*Cat. II*

This seminar course compares and contrasts major religious, philosophical, social, and political themes in different civilizations. Comparisons will vary each year but may be drawn from Asia, the Indian subcontinent, the Middle East, Africa, and indigenous cultures of the Americas. It examines the historical foundations of these civilizational differences and draws comparisons with common features of Western civilization. One important goal of the course is to enhance student appreciation of non-Western values and traditions.

This course will be offered in 2006-07 and in alternating years thereafter.

HI 3343. TOPICS IN ASIAN HISTORY.*Cat. I*

This seminar course examines topics in the cultural, socio-economic, religious and political history of East Asia. Topics vary each year and may include the following: nationalism and the writing of history, travel and exploration narratives, cross-cultural contact, the role of religion and ideology in political history, development and the environment in Asia, film and history, and the place of minorities and women in Asian societies. Suggested background: previous courses on Asia such as HU 1412, HI 2328, HI 2343, or RE 2724.

IS 1813. AMERICAN HISTORY FOR INTERNATIONAL STUDENTS.*Cat. I*

An introduction to American history designed to provide international students with a basic understanding of the history and culture of the United States. Written and oral assignments will also help these students gain a more effective command of the English language.

HUMANITIES (HU)

The courses listed below are general humanities courses and are intended to provide conceptual introductions to the major disciplines within the humanities. Students will encounter the basic methods of critical analysis and discussion required for the future investigation of the specific area they choose for their humanities and arts Sufficiencies. These courses emphasize patterns of thought, methods of inquiry, appropriate vocabulary, and critical attitudes needed to appreciate most fully various areas in the humanities; they are not intended as surveys or historical overviews. Consequently, in each course the subject matter used to develop and illustrate key concepts and approaches will change regularly. Practice in analytic thinking and writing will be a significant part of each course. The skills generated by these courses will greatly aid students in developing their themes and will be essential for the completion of the Sufficiency in the final IS/P seminar.

HU 1401. INTRODUCTION TO HUMANITIES & ARTS, I.*Cat. I*

This course is open to students enrolled in the Project-based Learning Community. The course focuses on developing basic skills of humanistic inquiry: careful analysis of complex arguments and evidence; accurate description and assessment of texts; and appreciation of the diversity of opinions and interpretations of materials. Students examine core readings in history, literature, or philosophy, and participate in team-oriented projects concerning real-world problems that cross the boundaries of the humanities, sciences, mathematics and technology. Projects vary and may include areas such as the history of science, contemporary affairs, international relations, and quantitative analysis of social issues.

HU 1402. INTRODUCTION TO HUMANITIES & ARTS, II.*Cat. I*

This course is open to students enrolled in the Project-based Learning Community and is a continuation of HU 1401. Students continue to read, analyze and write about core readings in history, literature, and philosophy, and complete team-oriented projects that examine real-world problems at the intersection of the humanities, sciences, mathematics, and technology.
Recommended Background: HU1401, Introduction to Humanities and Arts I.

HU 1411. INTRODUCTION TO AMERICAN STUDIES.*Cat. II*

This interdisciplinary course introduces students to three or four basic American Studies methodologies. Emphasis will vary according to the instructor, but usually the course will cover the following: the particular historical, cultural context (at the community and/or national level) of a few literary texts; the relationship of American art to literature in a specific time period; analysis of popular culture entertainments in market-and-message terms of production and reception. This course provides a beginning for a Sufficiency in American Studies. For a description of the American Studies sequence and offerings, see the Sufficiency section of the Undergraduate Catalog.

Suggested background: an interest in American history and American expression.

This course will be offered in 2007-08 and in alternating years thereafter.

HU 1412. INTRODUCTION TO ASIA*Cat. I*

This course will explore Asia through an interdisciplinary approach. We will examine tradition and modernity in some or all of four cultural regions—South Asia (India), East Asia (China), Southeast Asia (Vietnam or Thailand), Inner Asia (Tibet)—and globalization in Japan and/or Hong Kong. We will explore the cultural traditions of these various regions, paying special attention to history, religion, society. We will also consider modern developments in these same regions. The impact of colonialism, nationalism, revolution, industrialization and urbanization on the lives of Asian peoples will be illustrated through films and readings. No prior knowledge of Asian history or culture is expected.

HU 2441. AFRICAN HISTORY AND CULTURE.*Cat. II*

This survey course uses an interdisciplinary approach to examine fundamental issues in African political, social, and cultural history. The course may include various topics, such as ancient African kingdoms, the influence of Islam, the Atlantic slave trade, imperialism and decolonization, contemporary democratization, or African literature and art.

Suggested background: HI 1341 Introduction to Global History.

This course will be offered in 2007-08 and in alternating years thereafter.

HU 3411. PRO-SEMINAR IN GLOBAL PERSPECTIVES.*Cat. II*

This course examines the fundamentals of intercultural communication to prepare students to live and work with people from other cultures. It explores how different patterns of thinking and behavior, assumptions and values, have arisen from different cultural traditions and divergent histories in the world. Racism, prejudice, and bigotry—often the result of cultural, social, and technological differences in human experience—are among the concerns of the class.

This course cannot teach students how to behave and think in all parts of the world, but it raises questions about ethnocentric assumptions often taken for granted by those working or studying in another culture. It is excellent preparation for an international IQP or educational exchange.

Suggested background: Previous courses in Humanities.

This course will be offered in 2007-08 and in alternating years thereafter.

HU 3421. TOPICS IN MEDIEVAL AND RENAISSANCE STUDIES.*Cat. II*

This seminar course examines interdisciplinary topics in the study of the medieval and renaissance world. The course emphasizes various types of primary source material. Topics may include the Roman, Judeo-Christian, and Germanic heritage; warfare and social structure; the emergence of the modern town; folk and popular culture; encounters with the new world; and change and continuity in early modern society. It is appropriate for students with preparation any of several areas of the humanities, including history, literature, history of science and technology, and art history.

This course will be offered in 2007-08 and in alternating years thereafter.

Suggested background: previous courses in humanities such as AR 1111, GN 1222, GN 2223, GN 2224, HI 1322, HI 1331, HI 1341, HI 2334, MU 2612, RE 2723 or equivalent.

HU 4411. SENIOR SEMINAR IN INTERNATIONAL STUDIES.*Cat. I*

This course is designed to integrate each student's international courses, projects, and experiences in a capstone seminar in International Studies. Students will reflect on what they have learned in their previous courses and international experiences. They will assess what happened to them overseas, why it happened, and how it might be understood. They will also prepare a paper with an instructor in their area of international studies that integrates their previous academic courses. Students will also explore how they might translate their courses and experiences into future personal and professional opportunities.

Recommended background: previous courses in international studies, such as HI 1341 and HU 3411, and completion of an international IQP or an international educational exchange.

HU—AAS-50. AMERICAN ANTIQUARIAN SEMINAR.*ISP*

Each fall the American Antiquarian Society and five Worcester colleges sponsor a research seminar at the Antiquarian Society library. The seminar is conducted by a scholar familiar with the Society's holdings in early American history, and the seminar topic is related to his or her field of research.

Selection is highly competitive. The ten participating students are chosen by a screening committee made up of representatives of the five participating colleges: Assumption College, Clark University, College of the Holy Cross, WPI, and Worcester State College.

The seminar topic and research methods combine several disciplines, and students from a wide variety of majors have participated successfully in this unique undergraduate opportunity.

MUSIC (MU)

MU 1611. FUNDAMENTALS OF MUSIC I.*Cat. I*

This course concentrates on basic music theory of the common practice period. If time permits, instruction includes ear training, sight singing, and work on scales and intervals.

Recommended background: basic knowledge of reading music.

MU 2611. FUNDAMENTALS OF MUSIC II.*Cat. I*

Fundamentals II is a course on music theory at the advanced level beginning with secondary dominants and modulations and working through 19th-century chromatic harmony.

MU 2719. JAZZ HISTORY.*Cat. II*

Through an introduction to the musical contributions of Louis Armstrong, Duke Ellington, Charlie Parker, Miles Davis and others, students are exposed to the chronological development of the language of jazz. Each jazz era is examined in detail including the musical and social contexts which helped define it. Participants are expected to build aural skills with the goal of identifying specific historical periods through the recognition of particular musical characteristics. Students examine in depth one artist of their choice.

This course will be offered in 2006-07 and alternating years thereafter.

[This replaces MU 4623. Credit is not allowed for both MU 4623 and MU 2719.]

MU 2720. MUSIC HISTORY I: MEDIEVAL THROUGH THE BAROQUE.*Cat. II*

This course provides a historical survey of Western music from Medieval through Baroque periods with an emphasis on understanding stylistic traits and theoretical concepts of the eras. Topics include Gregorian chant and secular monophony; evolution of musical notation; development of polyphonic music; and vocal and instrumental genres such as mass, motet, madrigal, opera, cantata, sonata, and concerto, among others.

No prior background in music is necessary.

This course will be offered in 2006-07 and alternating years thereafter.

MU 2721. MUSIC HISTORY II: CLASSICAL TO THE PRESENT.*Cat. I*

This course provides a historical survey of Western music from the Classical period to the present with an emphasis on understanding stylistic traits and theoretical concepts of the eras. Topics include the development of genres such as sonata, string quartet, concerto, symphony, symphonic poem, character piece, Lied, and opera; and 20th century trends of impressionism, primitivism, atonality, serialism, minimalism, aleatory music, and electronic music.

No prior background in music is necessary.

MU 2722. HISTORY OF AMERICAN POPULAR MUSIC.*Cat. I*

This course will explore the uniqueness of America's popular music and its origins in the music of Africa and the folk music of Europe. Particular emphasis will be given to the origins and history of rock 'n' roll examining its roots in blues and early American popular music. [This replaces MU 4625. Credit is not allowed for both MU 4625 and MU 2722.]

MU 2730. JAZZ THEORY.*Cat. I*

This course examines harmonic and melodic relationships as applied to jazz and popular music composition. Students are introduced to a wide range of jazz improvisational performance practices. Topics include compositional forms, harmonic structures, major and minor keys, blues, modal jazz, and re-harmonization techniques. Students are expected to have a basic knowledge of reading music. [This replaces MU 4624. Credit is not allowed for both MU 4624 and MU 2730.]

MU 3001. WORLD MUSIC.*Cat. II*

This course introduces students to selected musical cultures of the world, e.g., Africa, Asia, the Middle East, and Latin America, from the ethnomusicological perspective by examining their musical styles as well as cultural and social contexts. Students will be expected to read materials in interdisciplinary areas, including musical ethnographies.

No prior background in music is necessary.

This course will be offered in 2007-08 and alternating years thereafter.

MU 3611. COMPUTER TECHNIQUES IN MUSIC.*Cat. I*

This course concentrates on both the technical and artistic aspects of computer music. Topics covered include the MIDI protocol and specification, sequencer design, voice editing, synthesizer architecture, and literature.

MU 3612. COMPUTERS AND SYNTHESIZERS IN MUSIC.*Cat. I*

This course focuses on technical and aesthetic problem solving in computer music. Using programming languages, students propose and design creative solutions to contemporary problems which currently have no commercial solutions. Students work with sequencers, signal processors, synthesizers, MIDI controllers, editors, and programming languages.

MU 3613. DIGITAL SOUND DESIGN.*Cat. I*

This course introduces the student to the theory and practice of digital sound design. It focuses on creative problem-solving in applications where digital audio production is a key component. Topics include digital sound recording and editing, creation and synchronization of digital sound tracks for video, theatrical sound design, and multimedia production.

MU 4621. INDEPENDENT INSTRUCTION (LESSONS) IN MUSIC.*IS/P*

Students electing to take their humanities and arts Sufficiency in music may, for one of their five courses, undertake 1/3 unit (normally at 1/12 unit per term) of private vocal or instrumental instruction. (Supplemental ensemble work is also strongly recommended.) The student must receive prior approval by a member of the WPI music faculty, and the instruction must be beyond the elementary level. Lessons involve a separate fee. Note that the maximum of 1/3 unit credit for lessons may be earned in addition to 1/3 unit credit for performance (see condition A or B below). Additional work, either in performance or lessons, may be acknowledged on the WPI transcript but will carry no WPI credit. Private lessons: voice, piano, organ, winds, brass, strings, and percussion.

MU 4628. PERFORMANCE SUFFICIENCY.*IS/P*

A final (sixth term) Sufficiency in music may be fulfilled by a recital performance in addition to a related paper, provided the music faculty determines that the student's capabilities be of a high order. During this term, the student usually is under private instruction, the cost of which is borne by the student.

NOTE: Two 1/3 units credit remain the maximum allowed for all lessons and performance credit.

MUSIC ENSEMBLES (MU)

Students who sing or play a traditional band or orchestra instrument at the intermediate level or better may enroll for any of the ensembles listed below. Students will register at the beginning of A term and receive 1/6 unit at the end of B term for participation in both terms. Students may also register at the beginning of C term and receive 1/6 unit at the end of D term for participation in both terms. Students may apply up to 1/3 unit of performing ensembles to the Humanities and Arts Sufficiency course requirement.

MU 2631. MEN'S GLEE CLUB.*Cat. I*

The Glee Club is the men's choral ensemble and the oldest student organization on campus. Glee Club performs many styles and periods of the vast repertoire of music for men's ensembles. Several times each year the Glee Club and Alden Voices (Women's Chorale) join forces as the WPI Festival Chorus to perform major works of the repertoire. The Glee Club tours Europe and also performs on tour. Rehearsals are held weekly. Prior singing or music experience is encouraged but not required. Open to all men.

MU 2632. ALDEN VOICES.*Cat. I*

Alden Voices is the women's choral ensemble. Alden Voices performs many styles and periods of the vast repertoire of music for women's ensembles. Several times each year Alden Voices and the Men's Glee Club join forces as the WPI Festival Chorus to perform major works of the repertoire. Alden Voices performs on tour as well as performing on campus. Rehearsals are held weekly. Prior singing or music experience is encouraged but not required. Open to all women.

MU 2633. BRASS ENSEMBLE.*Cat. I*

The Brass Ensemble performs frequently on campus and on tour and is open to students who perform on trumpet, trombone, euphonium, French horn, tuba, or tympani. Renaissance antiphonal music is included in the repertoire. Rehearsals are held weekly. Students are expected to perform with the ensemble and to know how to read music. Permission of the instructor is necessary to register.

MU 2634. JAZZ ENSEMBLE.*Cat. I*

The Jazz Ensemble performs frequently on campus and on tour and plays jazz arrangements written for a small ensemble with major emphasis on improvisation. Rehearsals are held weekly. Students are expected to perform with the ensemble and to know how to read music. Permission of the instructor is necessary to register.

MU 2635. STAGE BAND.*Cat. I*

The Stage Band performs traditional and contemporary big band literature with an emphasis on stylistically appropriate interpretation and performance practice. The ensemble performs frequently on campus and on tour. Rehearsals are held weekly. Students are expected to perform with the ensemble and to know how to read music. Permission of the instructor is necessary to register.

MU 2636. CONCERT BAND.*Cat. I*

The Concert Band is a large ensemble that performs several concerts a year as well as on tour. Membership is open to those who play traditional wind, brass or percussion instruments. Rehearsals are held weekly. Students are expected to perform with the ensemble and to know how to read music.

MU 2637. STRING ENSEMBLE.*Cat. I*

The String Ensemble performs music for string orchestra both on campus and on tour. Members of the string ensemble also comprise the string section for the full orchestra. Rehearsals are held weekly. Students are expected to perform with the ensemble and to know how to read music.

MU 2638. VOCAL PERFORMANCE LAB.*Cat. I*

The Vocal Performance Lab is a performance practice oriented chamber vocal ensemble. This ensemble explores specific stylistic techniques as pertains to the music of the Renaissance, Baroque, twentieth century, jazz, and extended vocal techniques (electronic, digital and experimental). The ensemble meets weekly.

Students are expected to be of the highest vocal caliber and should possess advanced sight-reading techniques. Open to both men and women. Permission of the instructor is necessary to register.

PHILOSOPHY (PY)

PY/RE 1731. INTRODUCTION TO PHILOSOPHY AND RELIGION.

Cat. I

This course provides an overview of key concepts, methods and authors in both fields. These introduce the student to the types of reasoning required for the pursuit of in-depth analysis in each discipline.

Emphasis on topics and authors varies with the particular instructor.

PY 2711. PHILOSOPHICAL THEORIES OF KNOWLEDGE AND REALITY.

Cat. I

This course introduces students to methods of philosophical analysis relating to the classification and conceptualization of entities and the nature of knowledge. The course will focus on a related set of problems or on the elaboration of a philosophical issue of knowledge or reality in the history of philosophy. Among themes and problems considered might be: How has the being of nature and knowledge of nature been represented in Western philosophy and science? What kind of a phenomenon is mind or thought and can entities in addition to human beings, such as computers, be said to have this attribute? What are reliable methods of arriving at and evaluating scientific knowledge, and are these methods identical for the natural and human sciences? Readings might include excerpts from the works of Plato, Aristotle, Bacon, Descartes, Kant, James, Dewey and Heidegger, as well as numerous contemporary philosophers.

Suggested background: familiarity with basic philosophical concepts and terms (as in PY/RE 1731).

PY 2712. SOCIAL AND POLITICAL PHILOSOPHY.

Cat. II

This course examines metaphysical and moral questions that philosophers have raised about social and political life. Among questions treated might be: What are the grounds, if any, of the obligation of a citizen to obey a sovereign? Are there basic principles of justice by which societies, institutions and practices are rightly evaluated? What is democracy, and how can we tell if an institution or practice is democratic? To what degree do economic institutions put limits on the realization of freedom, democracy and self-determination? Readings might include excerpts from the works of Plato, Hobbes, Locke, Rousseau and Marx, as well as numerous contemporary philosophers.

Suggested background: familiarity with basic concepts in philosophy (as in PY/RE 1731).

This course will be offered in 2007-08 and in alternative years thereafter.

PY 2713. BIOETHICS.

Cat. II

The purpose of this course is to evaluate the social impact of technology in the areas of biology/biotechnology, biomedical engineering and chemistry. The focus of the course will be on the human values in these areas and how they are affected by new technological developments. The course will deal with problems such as human experimentation, behavior control, death, genetic engineering and counseling, abortion, and the allocation of scarce medical resources. These problems will be examined through lectures, discussions and papers.

Suggested background: knowledge of key terms and concepts as given in PY/RE 1731 and PY/RE 2731.

This course will be offered in 2007-08 and in alternating years thereafter.

PY 2714. ETHICS AND THE PROFESSIONS: PERSONAL, PROFESSIONAL, AND SOCIAL DILEMMAS.

Cat. II

This course will present a framework by which various ethical dilemmas that arise in the professions, especially the science-related professions, can be identified, examined, and evaluated on the level of personal morality, professional codes of ethics, and social values. The goal is to study the solutions of these dilemmas in each of the three levels to determine what relation there may be between them, and whether or not resolutions of a dilemma on one level are appropriate for another level. Ethical concepts, professional codes of ethics, and policy positions will be used to analyze and evaluate these issues in a case study format. Representatives of appropriate professions will be invited to address specific issues pertaining to ethical dilemmas in their field.

This course will be offered in 2006-07 and in alternating years thereafter.

PY 2715. PHILOSOPHICAL THEORIES OF THE SELF.

Cat. II

This course will focus on philosophical questions concerning the nature of human identity. It will examine arguments from various philosophical traditions on topics such as the nature of personhood, self-deception, the importance or unimportance of everyday concerns, the comparative role of individual decisions and social norms, and the differences between secular and religious, Western and Eastern, political and apolitical approaches to all these issues. Authors may include some of the following: Thoreau, Kierkegaard, Hegel, Camus, Buddha, Plato, Marx, Freud and de Beauvoir.

Suggested background: familiarity with basic ethical concepts and terms (as in PY/RE 1731) and PY/RE 2731 or PY 2712.

This course will be offered in 2007-08 and in alternating years thereafter.

PY 2716. PHILOSOPHY OF DIFFERENCE.

Cat. II

This course examines philosophical presuppositions and questions of value underlying and expressed in the construction of masculinity and femininity in modern society. The course may also examine social identities rooted in race, ethnicity, sexual preference, and ability/disability. Possible topics include: changing conceptions of love, sex, marriage, and parenting; how our conceptions of masculinity and femininity are influenced by and influence (for example) religion, science, politics, work, and art; and the relations between feminist theory and other critical social theories.

This course will be offered in 2006-07 and in alternating years thereafter.

PY 2717. PHILOSOPHY AND THE ENVIRONMENT.

Cat. I

This course will focus on the following questions:

What is the scope of the current environmental crisis? What does this crisis reveal about the philosophical presuppositions and dominant values of our intellectual worldviews and social institutions? How can existing social theories help explain the environmental crisis? What implications does the crisis have for our sense of personal identity? What moral and spiritual resources can help us respond to it?

Readings will be taken from contemporary and historical philosophers and naturalists.

Suggested background: familiarity with basic concepts in philosophy (as in PY/RE 1731).

PY/RE 2731. INTRODUCTORY ETHICS.

Cat. I

This course will review at an introductory level theories of ethics, individual figures in the history of ethics, and selected problems in ethics. The emphasis will be on philosophical or religious ethics depending on the instructor.

PY 3711. TOPICS IN PHILOSOPHY.

Cat. I

The purpose of this course is to expose students to somewhat more advanced and specialized study in philosophy. Its focus will vary, but will typically be one of the following types: a particular philosopher (e.g., Plato, Kant, Mill); a particular philosophical tradition (e.g., Pragmatism, Ordinary Language philosophy, Empiricism); a particular philosophical problem (free will, knowledge of other minds, historical explanation); or a particular philosophical classic (Hegel's *Phenomenology of Mind*, Aristotle's *Ethics*).

Suggested background: three other philosophy courses.

PY 3712. PHILOSOPHY OF RELIGION.

Cat. II

This course will focus on philosophical questions concerning the following topics: the existence and nature of God; the compatibility of God and evil; the nature of religious faith and the relationship between religion, science and ethics; interpretations of the nature of religious language; the philosophically interesting differences between Western and Eastern religions; philosophical critiques of the role of religion in social life. Authors may include: Hume, Kant, Kierkegaard, Buber, Tillich, Daly, Nietzsche and Buddha.

Suggested background: familiarity with basic religious concepts and terms (as in PY/RE 1731).

This course will be offered in 2006-07 and in alternating years thereafter.

PY/RE 3731. PROBLEMS IN ETHICS AND SOCIAL PHILOSOPHY.

Cat. I

This course will examine in depth selected problems in ethical theory and social philosophy. The specific content or emphasis will be determined by the instructor.

Suggested background: knowledge of either PY/RE 2731 or PY 2712.

RELIGION (RE)

RE/PY 1731. INTRODUCTION TO PHILOSOPHY AND RELIGION.

Cat. I

This course provides an overview of key concepts, methods and authors in both fields. These introduce the student to the types of reasoning required for the pursuit of in-depth analysis in each discipline.

Emphasis on topics and authors varies with the particular instructor.

RE 2721. RELIGION AND CULTURE.

Cat. I

The purpose of this course is to examine how the two institutions of religion and culture interact and mutually influence one another. To do this a variety of definitions of religion and culture will be presented as well as an analysis of how religion interacts with such cultural phenomena as economics, politics, the state, war and the basic problem of social change. The purpose of this is to obtain a variety of perspectives on both religion and culture so that one can

begin to articulate more clearly the different influences that occur in the development of one's own personal history and the culture in which one lives.

Suggested background: knowledge of key terms and concepts as given in PY/RE 1731.

RE 2722. THE PROBLEM OF EVIL.

Cat. I

Notions of good and evil shape many of our day to day religious and philosophical claims and arguments. This course concerns questions and approaches to what is often called "evil," through a study of classical and contemporary texts and problems. The focus of the course will vary, but will include metaphysical, moral, and political ideas about kinds and relations of goods and evils from different religious and philosophical perspectives. This study takes into account notions of error, ignorance, wrong-doing, freedom and responsibility evident in contemporary religious and philosophical debate.

RE 2723. RELIGIONS OF THE WEST.

Cat. II

The purpose of this course is to examine, from an historical, doctrinal, scriptural and philosophical perspective, major Western religions. The course will focus primarily on Judaism, Christianity and Islam. Other religions will be examined. The course will attend to the social context in which these religions developed and will examine their continuing influence on Western society.

Suggested background: RE/PY 1731 and RE 2721.

This course will be offered in 2006-07 and in alternating years thereafter.

RE 2724. RELIGIONS OF THE EAST.

Cat. II

The purpose of this course is to examine, from the perspectives of history text, practice, and philosophy, some or all of the following religions: Hinduism, Buddhism, Taoism, Confucianism, and Shinto. The course will attend to the social context in which these religions began, their relations with their culture, their rituals and their continuing influences in the East and West.

Suggested background: PY/RE 1731 and RE 2721.

This course will be offered in 2007-08 and in alternating years thereafter.

RE/PY 2731. INTRODUCTORY ETHICS.

Cat. I

This course will review at an introductory level theories of ethics, individual figures in the history of ethics, and selected problems in ethics. The emphasis will be on philosophical or religious ethics depending on the instructor.

RE 3721. TOPICS IN RELIGION.

Cat. I

The purpose of this course is to expose students to somewhat more advanced or specialized study in religion. The focus will vary, but the material will be drawn from a particular religious thinker, a particular religious tradition or a particular historical or contemporary problem.

Suggested background: three other courses in religion.

RE/PY 3731. PROBLEMS IN ETHICS AND SOCIAL PHILOSOPHY.

Cat. I

This course will examine in depth selected problems in ethical theory and social philosophy. The specific content or emphasis will be determined by the instructor.

Suggested background: knowledge of either RE/PY 2731 or PY 2712.

SPANISH (SP)

SP 1523. ELEMENTARY SPANISH I.

Cat. I

A very intensive course that will introduce the student to the basic grammar of Spanish, emphasizing the four language skills: listening, speaking, reading and writing. It will also introduce the student to different aspects of Hispanic cultures in the U.S. and in Spanish-speaking countries. Students who have taken Spanish in high school are urged to take a placement exam before enrolling in either level of Elementary Spanish. See the instructor.

SP 1524. ELEMENTARY SPANISH II.

Cat. I

A continuation of Elementary Spanish I.
Recommended background: SP 1523.

SP 2521. INTERMEDIATE SPANISH I.

Cat. I

A course designed to allow students to improve their written and oral skills, expand their vocabulary and review some important grammatical structures. Students will also read short stories and poems by some of the most representative Spanish American and Spanish authors, such as Horacio Quiroga, Jorge Luis Borges, Gabriela Mistral and Ana María Matute.

Recommended background: Elementary Spanish II.

SP 2522. INTERMEDIATE SPANISH II.

Cat. I

A continuation of Intermediate Spanish I.
Recommended background: SP 2521.

SP 3521. ADVANCED SPANISH I.

Cat. I

A course that continues to improve student's language skills while deepening their understanding of Hispanic cultures. Some of the topics studied are: the origins of Hispanic cultures in Spain and Spanish America; family; men and women in Hispanic societies; education; religion.

Recommended background: Intermediate Spanish II.

SP 3522. ADVANCED SPANISH II.

Cat. I

A continuation of Advanced Spanish I.
Recommended background: SP 3521.

SP 3523. TOPICS IN LATIN AMERICAN CULTURE.

Cat. II

An introduction to various aspects of life in Latin American countries from early times to the present. Focusing on the social and political development of Latin America, the course will reveal the unity and diversity that characterize contemporary Latin American culture. Typical topics for study include: the precolombian civilizations and their cultural legacy; the conquistadores and the colonial period; the independence movements; the search for and the definition of an American identity; the twentieth-century dictatorships; and the move toward democracy.

Recommended background: SP 3521 (Advanced Spanish I) and SP 3522 (Advanced Spanish II) or equivalent.

This course will be offered in 2006-07 and in alternating years thereafter.

SP 3524. SPANISH-AMERICAN LITERATURE IN THE TWENTIETH CENTURY.

Cat. II

This course, taught in the Spanish language, focuses on the major literary movements in Spanish America, from the "Modernista" movement at the turn of the century to the Latin American "Boom" of the 1960s to the political literature of the '70s and '80s. The work of representative authors, such as Rubén Darío, Julio Cortázar, Rosario Castellanos, Elena Poniatowska, will be discussed.

Recommended background: SP 3521 (Advanced Spanish I) and SP 3522 (Advanced Spanish II) or equivalent.

This course will be offered in 2007-08 and in alternating years thereafter.

SP/ID 3525. SPANISH AMERICAN FILM/MEDIA: CULTURAL ISSUES.

Cat. II

Through Latin American and Caribbean films, and other media sources, this course studies images, topics, and cultural and historical issues related to modern Latin American and the Caribbean. Within the context and influence of the New Latin American Cinema and/or within the context of the World Wide Web, radio, newspapers, and television the course teaches students to recognize cinematographic or media strategies of persuasion, and to understand the images and symbols utilized in the development of a national/regional identity. Among the topics to be studied are: immigration, gender issues, national identity, political issues, and cultural hegemonies.

Taught in advanced level Spanish. May be used toward foreign language Sufficiency, Minor, or Major.

Recommended Background: SP 2521 and SP 2522, and SP 3523.

This course will be offered in 2007-08 and in alternating years thereafter.

SP/ID 3526. COMPARATIVE BUSINESS ENVIRONMENTS.

Cat. II

The basis of this course is a comparative study and analysis of specific Latin American and Caribbean business practices and environments, and the customs informing those practices. SP/ID 3526 focuses on countries such as Mexico, Argentina, Chile, Puerto Rico, and Costa Rica. The course's main objective is to study communication strategies, business protocol, and negotiation practices in the countries mentioned above. Through oral presentations and written essays, students will have the opportunity to explore other countries in Latin America and the Caribbean.

Taught in advanced level Spanish. May be used toward foreign language Sufficiency, Minor, or Major.

Recommended Background: SP 2521 and SP 2522.

This course will be offered in 2006-07 and in alternating years thereafter.

SP/ID 3527. TECHNICAL AND BUSINESS SPANISH.

Cat. II

The course focuses on the linguistic concepts, terminology, and grammar involved in business and technical Spanish. Students will be required to produce and edit business documents such as letters, job applications, formal oral and written reports, etc. The objective of this course is to help students develop the basic written and oral communication skills to function in a business environment in Latin America and the Caribbean.

Recommended background: SP 2521 and SP 2522.

This course will be offered in 2007-08 and in alternating years thereafter.

SP 3528. SPANISH CULTURE AND CIVILIZATION.*Cat II*

This course is an introduction to various aspects of life in Spain, from early times to the present. The main focus is on Spain's social, political, and cultural development and its experience of diversity within its European context. Typical topics for study include: The Reconquista and the Arab influence in Spanish culture, the Spanish monarchy, its evolution into a democracy, the development of modern politics, the importance of the Spanish Civil war, and the influence of writers (such as Federico García Lorca), painters (such as Pablo Picasso), and art in general in modern Spanish culture. This course is taught in Spanish.

Recommended background: SP3521 (Advanced Spanish I) and SP 3522 (Advanced Spanish II) or equivalent.

This course will be offered in 2007-08 and in alternating years thereafter.

SP/ID 3529. CARIBBEANNESS: VOICES OF THE SPANISH CARIBBEAN.*Cat II*

A survey of Caribbean literature and arts that takes a multimedia approach to examining the different voices that resonate from the Spanish Caribbean and what appears to be a constant search for identity. By studying the works of major authors, films, music and the plastic arts, we will examine the socio-cultural context and traditions of this region in constant search for self-definition. Special attention will be given to the influential role ethnicity, colonialism, gender and socio-economic development play in the interpretation of works from Puerto Rico, Cuba, the Dominican Republic, Colombia and Venezuela as well as those of the Caribbean diaspora. This course is taught in Spanish.

Recommended background: SP3521 (Advanced Spanish I) and SP 3522 (Advanced Spanish II) or equivalent.

This course will be offered in 2006-07 and in alternating years thereafter.

SP 3530. SPANISH FILM/MEDIA: CULTURAL ISSUES.*Cat II*

Through Spanish films, and other media sources, this course studies images, topics, and cultural and historical issues that have had an impact in the creation of a modern Spanish nation. This course focuses on current political and ideological issues (after 1936), the importance of Spanish Civil war, gender identity, and class, cultural and power relationships. This course is taught in Spanish. This course will be offered in 2006-07 and in alternating years thereafter.

SP 3531. CONTEMPORARY US LATINO LITERATURE & CULTURE.*Cat II*

This course introduces students to the field of Latino studies, paying particular attention to the cultural productions of U.S. Latinos in film, theater, music, fiction writing and cultural criticism. At the same time that this course reflects upon a transnational framework for understanding the continuum between U.S. Latinos and Latin American/Caribbean communities, we closely examine more U.S. based arguments supporting and contesting the use of Latino as an ethnic-racial term uniting all U.S. Latino communities. We examine the ways in which U.S. Latinos have manufactured identities within dominant as well as counter cultural registers. In this course, special attention is given to the aesthetics of autobiography and to how Latino writers experiment with this genre in order to address changing constructions of immigration, language, exile, and identity. This course is taught in English.

This course will be taught in 2006-07 and in alternating years thereafter.

RHETORIC (RH) AND WRITING (WR)**RH 3111. THE STUDY OF WRITING.***Cat. I*

This course introduces students to issues in the study of writing such as the history and uses of literacy, the relationship of thought to language, the role of writing in producing knowledge, and research on composing. The focus of the course will be on professional and academic writing. The course will be organized around a series of interrelated research questions: How do writers in professional and academic settings know when they have something to write about? How do they define a problem to investigate? How do they define or construct an audience to address? How do they locate their work in relation to others' work? How do they know which forms of writing to use? Why do they write in the first place? What functions does writing perform?

RH 3112. RHETORICAL THEORY.*Cat. I*

Rhetoric concerns both the art of mastering the available means of persuasion and the study of how oral, written, and visual communication projects the intentions of individuals and groups, makes meanings, and affects audiences. The purpose of this course therefore is two-fold. It is intended to help students become more effective communicators by learning about the rhetorical situation and various rhetorical techniques. And it is designed to help them understand how various forms of communication work by learning some of the strategies of rhetorical analysis.

RH 3211. RHETORIC OF VISUAL DESIGN.*Cat. I*

This course explores how visual design is used for purposes of identification, information, and persuasion. It looks at many modes of visual communication, such as icons, logos, trademarks, signs, product packaging, infographics, posters, billboards, ads, exhibits, graffiti, page layout, films, television, videogames, and web sites. The course provides an overview of the history of graphic design movements, as well as analytical tools to understand how visual design encodes messages and the role visual communication plays in contemporary culture.

WR/EN 2211. ELEMENTS OF WRITING.*Cat. I*

This course is designed for students who wish to work intensively on their writing. The course will emphasize the processes of composing and revising, the rhetorical strategies of expository prose, and the interaction between writer and audience. In a workshop setting, students will write a sequence of short papers and complete one longer writing project, learn to read critically and respond helpfully to each other's writing, and make oral presentations from written texts.

WR/EN 3011. PEER TUTORING IN WRITING.*Cat. I*

Peer Tutoring in Writing introduced students to the theory and practice of composition. In this course, students research, read, and write about their own and others' literacy practices. Through reading and writing assignments, peer reviews, interviews, presentations, and a tutoring internship in the CCAC, students hone their communication skills while increasing their ability to examine critically the role of communication in the production of knowledge.

WR/EN 3214. WRITING ABOUT DISEASE AND PUBLIC HEALTH.*Cat. I*

This writing workshop focuses on the purposed and genres of writing about disease and public health. We will consider how biomedical writers communicate technical information about disease and public health to general audiences; how writers capture the human experience of disease and health care; how writers treat the public policy implications of disease; and how writers design publicity to promote public health. We will examine such genres as the experimental article, news reports, medical advice, profiles, commentary, and public health messages.

Recommended background: EN 2211 or equivalent writing courses.

Students who have taken EN 3215 may not receive credit also for WR/EN 3214.

WR/EN 3216. WRITING IN THE PROFESSIONS.*Cat. I*

Studies show that engineers spend 80-90% of their professional time engaged in various kinds of communication. This course emphasizes the management contexts of writing in the professions. Focus is on making informed decisions about approaches, styles, problems, issues, sources, strategies, and human-relations aspects of writing in business, industry, and other institutional settings. Special attention is given to business editing and proposal and grant writing.

Recommended background: EN 2211 or equivalent writing course.

WR/EN 3217. CREATIVE WRITING.*Cat. I*

The purpose of this course is to help students develop or improve the skills of written expression. Small groups are formed in which participants present and discuss their original work in either fiction or poetry.

INTERACTIVE MEDIA AND GAME DEVELOPMENT**IMGD 1000. CRITICAL STUDIES OF INTERACTIVE MEDIA AND GAMES.***Cat. I*

This course introduces non-technical studies of computer-based interactive media and games. The course develops a vocabulary for discussing games and other interactive media, and tools for analyzing them. Students are expected to provide written critiques using the critical approaches presented in the course. The games and other interactive media critiqued may be commercially available or under development.

IMGD 1001. THE GAME DEVELOPMENT PROCESS.*Cat. I*

This course discusses the process of game development. It examines the roles of different participants in the development process and how the technical development and the artistic development proceed in tandem. Group work is emphasized, especially the importance of collaboration between technical and artistic efforts. Students are expected to participate in game development using appropriate game development tools.

IMGD 1002. STORYTELLING IN INTERACTIVE MEDIA AND GAMES.*Cat. I*

This course explores different types of story within gaming and other interactive media. It delineates between linear, branching, and emergent storytelling, identifies hybrids, and finds new modes of making compelling narrative. A variety of games are discussed, including early text-based adventures, role-playing games, shooters, and strategy games. Students will construct characters, situations, and narratives through game play and scripted cut scenes. Students will explore and use visual storytelling techniques.

IMGD 2000. SOCIAL ISSUES IN INTERACTIVE MEDIA AND GAMES.*Cat. II*

This course provides students with a realistic assessment of the potential and problems related to interactive media and games, especially computer games, and their effects on society. Topics include individual and group behavior, diversity, human responsibility, ethical and legal issues, and intellectual property. The course examines the issues from various points of view, and discover the political, social, and economic agendas of the people or groups championing those points of view. Students will write papers, participate in discussions, and research related topics.

Recommended background: IMGD 1000.

Offered in 2007-08 and in alternating years thereafter.

IMGD 2001. PHILOSOPHY AND ETHICS OF COMPUTER GAMES.*Cat. II*

This course introduces students to some of the political and ethical dimensions of the new entertainment modalities. Students will explore such issues as representation and power (e.g., gaming and disability, and race stereotyping in games), the phenomenology of virtual reality, capitalism and the commodification of leisure, gender and sexual violence, and cyberspace and democracy. Students will also develop critical tools for evaluating the ethical and social content of their own and others' games. In addition to writing several analytical papers on the critical theory of technology, students will be encouraged to work on game designs exploring philosophical or social themes.

Recommended background: IMGD 1000.

Offered in 2007-08 and in alternating years thereafter.

IMGD 3000. TECHNICAL GAME DEVELOPMENT I.*Cat. II*

This course teaches technical Computer Science aspects of game development, with the focus of the course on low-level programming of a computer games. Topics include 2D and 3D game engines, simulation-type games, analog and digital controllers and other forms of tertiary input. Students will implement games or parts of games, including exploration of graphics, sound, and music as it affects game implementation.

Recommended background: CS 2303.

Offered in 2007-08 and in alternating years thereafter.

IMGD 3500. ARTISTIC GAME DEVELOPMENT I.*Cat. II*

This course focuses on the unique problems presented to the artist when working in game development. Students learn to work with 2D sprite-based art, including tiling and simple animation. They then explore 3D architecture, level design, texturing, and environmental animation. Students will use art to create compelling game experiences through environments by designing their own levels in both 2D and 3D games.

Recommended background: AR 3000.

Offered in 2007-08 and in alternating years thereafter.

IMGD 4000. TECHNICAL GAME DEVELOPMENT II.*Cat. II*

This course focuses on the application of advanced Computer Science topics as they impact game development. Networking and distributed systems issues are addressed, including scalability and latency compensation techniques, for designing games for an online multi-player environments. AI, graphics and physics techniques specific to game development are discussed. Students will implement games or parts of games that apply advanced Computer Science topics.

Recommended background: IMGD 3000.

Offered in 2006-07 and in alternating years thereafter.

IMGD 4500. ARTISTIC GAME DEVELOPMENT II.*Cat. II*

This course focuses on the integration and organization of the various artistic elements used in game development. The course examines user interaction, interface design, and existing paradigms in current games. Students will combine elements of level design, animation, music, sound, and writing to create an aesthetically appealing game.

Recommended background: IMGD 1002, IMGD 3500, MU 1611.

Offered in 2006-07 and in alternating years thereafter.

INTERDISCIPLINARY**ID/SS 2050. SOCIAL SCIENCE RESEARCH FOR THE IQP.***Cat. I*

This course is open to students accepted to off-campus IQP centers and programs. The course introduces students to research design, methods for social science research, and analysis. It also provides practice in specific research and field skills using the project topics students have selected in conjunction with sponsoring agencies. Students learn to develop social science hypotheses based upon literature reviews in their topic areas and apply concepts drawn from social psychology, anthropology, sociology, economics and other areas as appropriate. Students make presentations, write an organized project proposal, and develop a communication model for reporting their project findings.

ID 3100. TEACHING METHODS IN MATHEMATICS AND SCIENCE.*Cat. II*

Within the context of contemporary secondary education in mathematics and science (biology, chemistry, physics), ID 3100 introduces and demonstrates effective teaching methods as they relate to curriculum goals and current methods of assessment. These methods take into account diverse learning styles as well as various technological resources. Topics to be covered include: a brief history of education; curriculum and course guidelines (Massachusetts Education Reform and regulations 603 CMR 7.00, state curricular frameworks, national standards); legal issues; developing a course syllabus; and the issue of breadth versus depth in course planning and delivery. The course also covers practical questions of organizing, delivering and assessing a course. This course is intended primarily for students interested in completing the Massachusetts requirements for teacher licensing. (See www.wpi.edu/~goulet/teacher_prep). This program is aimed primarily at majors in mathematics, physics, chemistry and biology wishing to be licensed to teach in middle or high school in one of those disciplines. A portion of the course requires the observation of master teachers at the Massachusetts Academy of Mathematics and Science, who will work with all students in the course to assist them in beginning to acquire the appropriate skills to conduct their own classes in mathematics or science at the secondary school level.

Recommended background: SS 2401, Psychology of Education.

This course will be offered in 2006-07 and in alternating years thereafter.

ID/AR 3150. LIGHT, VISION AND UNDERSTANDING.*Cat. II*

By using material from the sciences and the humanities this course examines the ways in which ideas of knowledge and of human nature have been fashioned. The specific topics include physical theories about light, biological and psychological theories of visual perception, and artistic theories and practices concerned with representation. The mixing of material from different academic disciplines is deliberate, and meant to counter the notion that human pursuits are "naturally" arranged in the neat packages found in the modern university. The course draws upon the physical and social sciences, and the humanities, to examine how those fields relate to one another, and how they produce knowledge and self-knowledge. Cultural as well as disciplinary factors are assessed in this process.

Light, Vision and Understanding is conducted as a seminar. The diverse collection of reading materials includes a number of primary texts in different fields. In addition, the students keep a journal in which they record the results of numerous individual observations and experiments concerning light and visual perception. The course can fit into several Sufficiency areas as well as serve as a starting point for an IQP. There are no specific requirements for this course, although some knowledge of college-level physics, as well as an acquaintance with the visual arts, is helpful.

This course will be offered in 2006-07 and in alternating years thereafter.

ID/GN 3515. TECHNICAL TOPICS IN GERMAN.*Cat. II*

Technical topics are addressed and discussed entirely in German. German-speaking faculty from several WPI science and engineering departments, as well as lecturers from outside the university, present a range of topics at an introductory level. The focus of the course is on the use and development of German language skills in a technical context, which will include lectures, presentations, discussions, problem solving, and writing on technical topics. The course can be counted towards a Sufficiency or a minor in German. As the course is to be conducted entirely in German, knowledge of German sufficient for advanced conversations and detailed writing (such as students acquire in GN 3512, Advanced German II, or equivalent) is strongly recommended.

This course will be offered in 2006-07 and in alternating years thereafter.

ID/SP 3525. SPANISH AMERICAN FILM/MEDIA: CULTURAL ISSUES.*Cat. II*

Through Latin American and Caribbean films, and other media sources, this course studies images, topics, and cultural and historical issues related to modern Latin American and the Caribbean. Within the context and influence of the New Latin American Cinema and/or within the context of the World Wide Web, radio, newspapers, and television the course teaches students to recognize cinematographic or media strategies of persuasion, and to understand the

images and symbols utilized in the development of a national/regional identity. Among the topics to be studied are: immigration, gender issues, national identity, political issues, and cultural hegemonies.

Taught in advanced level Spanish. May be used toward foreign language Sufficiency, Minor, or Major.

Recommended Background: SP 2521 and SP 2522, and SP 3523.

This course will be offered in 2007-08 and in alternating years thereafter.

ID/SP 3526. COMPARATIVE BUSINESS ENVIRONMENTS.

Cat. II

The basis of this course is a comparative study and analysis of specific Latin American and Caribbean business practices and environments, and the customs informing those practices. ID/SP 3526 focuses on countries such as Mexico, Argentina, Chile, Puerto Rico, and Costa Rica. The course's main objective is to study communication strategies, business protocol, and negotiation practices in the countries mentioned above. Through oral presentations and written essays, students will have the opportunity to explore other countries in Latin America and the Caribbean.

Taught in advanced level Spanish. May be used toward foreign language Sufficiency, Minor, or Major.

Recommended Background: SP 2521 and SP 2522.

This course will be offered in 2006-07 and in alternating years thereafter.

ID/SP 3527. TECHNICAL AND BUSINESS SPANISH.

Cat. II

The course focuses on the linguistic concepts, terminology, and grammar involved in business and technical Spanish. Students will be required to produce and edit business documents such as letters, job applications, formal oral and written reports, etc. The objective of this course is to help students develop the basic written and oral communication skills to function in a business environment in Latin America and the Caribbean.

Recommended background: SP 2521 and SP 2522.

This course will be offered in 2006-07 and in alternating years thereafter.

ID/SP 3529. CARIBBEANNESS: VOICES OF THE SPANISH CARIBBEAN.

Cat. II

A survey of Caribbean literature and arts that takes a multimedia approach to examining the different voices that resonate from the Spanish Caribbean and what appears to be a constant search for identity. By studying the works of major authors, films, music and the plastic arts, we will examine the socio-cultural context and traditions of this region in constant search for self-definition. Special attention will be given to the influential role ethnicity, colonialism, gender and socio-economic development play in the interpretation of works from Puerto Rico, Cuba, the Dominican Republic, Colombia and Venezuela as well as those of the Caribbean diaspora. This course is taught in Spanish.

Recommended background: SP3521 (Advanced Spanish I) and SP 3522 (Advanced Spanish II) or equivalent.

This course will be offered in 2006-07 and in alternating years thereafter.

MANAGEMENT

ACCOUNTING (ACC)

ACC 1100. FINANCIAL ACCOUNTING.

(formerly MG 1100)

Cat. I

This course provides a tool for business communication, as accounting is an important language of business. Students are introduced to the accounting process, its underlying concepts, and the techniques of preparing and analyzing financial statements. Students are also introduced to issues in accounting for assets, liabilities, and stockholders' equity. The course demonstrates the employment of accounting data by users outside the firm, and the application of accounting numbers in financial analyses and market decisions.

Students may not receive credit for both MG 1100 and ACC 1100.

ACC 2101. MANAGEMENT ACCOUNTING.

(formerly MG 2101)

Cat. I

This course is intended to familiarize the student with the wide variety of ways in which accounting data are used by management as a tool for the attainment of predetermined organizational objectives. The emphasis of the course is on the application of accounting data, rather than on its preparation, and particular attention is given to the use of financial data both in controlling day-to-day activities and planning future operations. Principal topics include: master budgets, cost analysis and classification systems, cost-volume-profit analysis, standard cost accounting and an introduction to capital budgeting.

Recommended background: ACC 1100.

Students may not receive credit for both MG 2101 and ACC 2101

ACC 4151. COST ACCOUNTING.

(formerly MG 4151)

Cat. II

This course is designed to give basic understanding and skill in the area of cost accumulation to anyone concerned with recording the expenses associated with a given activity or project. Cost accounting provides data for three major purposes: 1) planning and controlling routine operations, 2) making non-routine decisions, and 3) inventory valuation and income determination. All three are important, but the course stresses the first two as they relate to project activity. The goal of the course is to put cost accounting in focus as a highly useful technique in any decision-making situation where expense levels are important. While some attention is directed toward accounting systems and procedures for data accumulation, stress is given to the theme that cost accounting is a vital and dynamic tool for problem-solving.

Recommended background: ACC 1100.

Students may not receive credit for both MG 4151 and ACC 4151.

This course will be offered in 2007-08 and in alternating years thereafter.

BUSINESS (BUS)

BUS 1900. INTRODUCTION TO BUSINESS IN AN INTERNATIONAL ENVIRONMENT.

(formerly MG 1900)

Cat. I

This course focuses on the operation of a company conducting business in an international environment. It addresses cultural differences and their importance in international trade and in such business functions as operations, human resources, marketing and accounting. BUS 1900 is an appropriate course for all WPI students regardless of a major.

Students may receive credit for only one of the following: MG 1050, MG 1900 and BUS 1900.

BUS 2950. BUSINESS LAW AND ETHICS.

(formerly MG 2950)

Cat. I

Imparts an understanding of how law, ethics, and public policy affect modern business. Approximately two thirds of the term is devoted to coverage of fundamental substantive areas of business law (torts, contracts, property, business organizations), public policies (regulatory and promotional), and approaches to ethical analysis for decision-making. Particular attention is paid to technology-based enterprises (e.g. intellectual property, environmental regulation). The concluding portion of the course involves all students in examination of current cases in which law, ethics and human, societal and global concerns intersect with business decision-making today.

Students may not receive credit for both MG 2950 and BUS 2950.

ENTREPRENEURSHIP (ETR)

ETR 3910. RECOGNIZING AND EVALUATING NEW VENTURE OPPORTUNITIES.

(formerly MG 3910)

Cat. I

This course focuses on identifying ideas for new businesses and learning how to evaluate those ideas to determine if they are feasible. Using various opportunity recognition models, students will be expected to come up with a business idea and conduct an analysis of the feasibility of the venture and its fit with the founder.

Recommended background for this course consists of OIE 2850 and two of the following: ACC 1100, BUS 2950, OIE 3400, MKT 3600, or MIS 3700.

Students may receive credit for only one of the following: MG 391X, MG 3910 or ETR 3910.

ETR 3920. PLANNING AND LAUNCHING NEW VENTURES.

(formerly MG 3920)

Cat. I

This course focuses on business plan development, especially the financial aspects of the plan. The intent is that students will use a feasibility analysis, such as the one completed in ETR 3910, and turn that into a complete business plan. Additionally, students will learn about seed capital, venture, and other means of financing new ventures.

Recommended background for this course consists of ETR 3910, OIE 2850 and two of the following: ACC 1100, BUS 2950, OIE 3400, MKT 3600, or MIS 3700.

Students may receive credit for only one of the following: ID 1050, MG 3920, or ETR 3920.

ETR 4930. GROWING AND MANAGING NEW VENTURES.

(formerly MG 4930)

Cat. I

One of the most troublesome aspects of entrepreneurship is running the business once it is started. This course focuses on techniques to grow the new venture and how to manage both the growth and operations. Considerable emphasis will be placed on expanding existing markets, finding new markets,

anticipating the next generation of products, and managing cash flow. This course is the capstone course for both the Entrepreneurship Minor and the Management Minor.

Recommended background for this course consists of five of the following: ACC 1100, ACC 2101, BUS 1900, BUS 2950, ETR 3910, ETR 3920, MIS 3700, MKT 3600, OBC 2300, OIE 2850, OIE 3400.

Students may receive credit for only one of the following: MG 3960, MG 4930, or ETR 4930.

FINANCE (FIN)

FIN 1250. PERSONAL FINANCE.

(formerly MG 1250)

Cat. I

This course is designed to help the student make well-informed judgments when faced with personal financial decisions. Such decisions are growing in number and complexity, and both individuals and families need a considerable degree of financial expertise in order to utilize optimally their limited incomes. Principal topics include: insurance (medical, life, automobile and disability), consumer credit, estate planning, taxation, personal investments (real estate, securities, etc.), social security legislation and personal financial planning.

Students may not receive credit for both MG 1250 and FIN 1250. Students may not receive credit for both FIN 1250 and FIN 2200.

FIN 2200. FINANCIAL MANAGEMENT.

(formerly MG 2200)

Cat. I

The financial and competitive status of a company at any given point in time can usually be attributed to prior management decisions. In this course, the student will learn how to use several financial models that together, serve as a sound theoretical framework for analyzing the three types of financial decisions faced by the financial manager. These are 1. investing decisions, 2. financing decisions, and 3. working capital management decisions. The impact of managerial decisions on the financial statements is emphasized. In addition, ethical conduct and global issues relating to the core concepts in the course are explored.

Recommended background: ACC 1100 and MA 2611.

Students may receive credit for only one of the following: MG/IE 2200, MG 2200, or FIN 2200.

FIN 2250. FINANCIAL SYSTEM OF THE UNITED STATES.

(formerly MG 2250)

Cat. I

An analysis of how the financial system of the United States has developed and contributes to the achievement of broad national economic goals as high national income, satisfactory economic growth, stable prices, and equilibrium in balance of payments with other countries. Emphasis is placed on the theory of the supply and demand for short-term money and long-term capital, and the resultant effect on interest rates. Primary concentration on the sources and uses of funds of the major non-bank financial institutions, such as insurance companies, pension funds, mutual funds, finance companies, savings and loan banks and mutual savings banks. A discussion of the reforms of financial institutions, and of money and capital markets to more efficiently allocate the scarce resources of the country. This course is intended to serve the business major and other students interested in understanding the role of financial intermediaries in the United States economy.

Suggested background: some knowledge of accounting and economics will be helpful in taking this course.

Students may not receive credit for both MG 2250 and FIN 2250.

FIN 2260. INVESTMENT AND SECURITY ANALYSIS.

(formerly MG 2260)

Cat. I

This course is designed to provide an introduction to the language and methodology of security analysis. It is intended to serve two different groups of students: those interested in the subject from the viewpoint of intelligent management of their own portfolios, and those students who have a possible career interest in some facet of the securities industry. Principal topics include: institutional structure and language of the securities market; investment research; alternative investment opportunities; financial statement analysis; fundamental evaluation of common stocks, preferred stocks and bonds; technical analysis; and business cycle analysis.

Recommended background: ACC 1100 and SS 1120.

Students may not receive credit for both MG 2260 and FIN 2260.

MANAGEMENT INFORMATION SYSTEMS (MIS)

MIS 3700. INFORMATION SYSTEMS MANAGEMENT.

(formerly MG 3700)

Cat. I

This course introduces students to the management of information technology within complex organizations. It covers the range of information technologies employed by business organizations and the manner in which they are deployed. The course places special emphasis on the management of information resources from a user and manager point of view and will help students understand how particular technological arrangements can facilitate achievement of organizational goals. The impact of information technology on management control, organizational structure, individual workers, relationships between organizations, and business transformational will be discussed.

Recommended background: ACC 2101 and OBC 2300 or equivalent business background.

Students may receive credit for only one of the following: MG 2700, MG 3700, or MIS 3700.

MIS 3720. BUSINESS DATA MANAGEMENT.

(formerly MG/IE 3720)

Cat. I

This course introduces students to the theory and practice of database management and the application of database software to implement business information systems that support managerial and operational decision making. Special topics covered include relational data models, query languages, normalization, locking, concurrency control and recovery. The course covers data administration and the design of data tables for computerized databases. Students will use a commercial database package to design and implement a small business database application.

Recommended background: CS 2118 or equivalent knowledge.

Students may receive credit for only one of the following: MG 4700, MG 3720, or MIS 3720.

MIS 3740. ORGANIZATIONAL APPLICATIONS OF TELECOMMUNICATIONS.

(formerly MG 3740)

Cat. I

Students taking this course will develop an understanding of how organizations can effectively use telecommunications technology to enhance business functionality. Students will analyze the development of organizational communications infrastructures and their use for the development of "virtual" organizational structures and to support globally-distributed organizations. The course will begin with a survey of the concepts and technologies which form the basis of a business telecommunications system and which allow the merging of voice, data and video in an integrated multimedia communications structures.

Recommended background: MIS 3700.

Students may receive credit for only one of the following: MG 4701, MG 3740, MG/IE 3740, or MIS 3740.

MIS 4720. SYSTEMS ANALYSIS AND DESIGN.

(formerly MG/IE 4720)

Cat. I

This course integrates students' background in MIS in a one-term project focusing on development of creative solutions to open-ended business and manufacturing problems. The project will utilize systems analysis and design tools such as systems development life cycle, feasibility study, cost-benefit analysis, structured analysis and design. Students will acquire the skills necessary to analyze, develop, implement, and document real-life information systems. Students must be able to organize themselves and the project to complete their work within a seven week term. It is recommended that MIS majors take this course in preparation for their MQP.

Recommended background: MIS 3720.

Students may receive credit for only one of the following: MG 3750, MG 4720, or MIS 4720.

MIS 4740. E-BUSINESS STRATEGY, ARCHITECTURE AND DESIGN.

(formerly MG/IE 4740)

Cat. II

The course focuses on the linkage between organizational strategy and networked information techniques to implement a rich variety of business models in the national and global contexts connecting individuals, businesses, governments, and other organizations to each other. It provides an introduction to e-business strategy and the development and architecture of e-business solutions and their technical components. The course will cover how businesses and consumers use the Internet to exchange information and initiate transactions. Both theoretical concepts and practical skills with appropriate development tools will be addressed within the scope of the class. Students will develop a business plan and put that plan into action through development of an e-business website using commercially available development tools.

Recommended background: CS 1101, CS 1102 or CS 2118 or ability to program in a higher level programming language.

This course will be offered 2006-07 and in alternating years thereafter.

MIS 4750. MANAGEMENT OF THE IS FUNCTION.*(formerly MG 4750)**Cat. II*

This course integrates students' background in management policy and business analysis and addresses the practical problems of developing and running an IS organization. It focuses on the planning and management required to assure systems performance and monitoring, systems reliability and quality change management, backup and recovery, security, new technology assessment and implementation, staffing and staff development. Through case studies and mini-projects students will analyze existing structures in industry IS organizations.

Recommended background: MIS 3700.

Students may not receive credit for both MG 4750 and MIS 4750.

This course will be offered 2007-08 and in alternating years thereafter.

MARKETING (MKT)**MKT 3600. MARKETING MANAGEMENT.***(formerly MG/IE 3600)**Cat. I*

This class is designed to give students a broad overview of diverse topics in marketing management. After this class, students should have a solid understanding of the main concepts and principles of marketing, and be able to apply them to actual business situations. The course demonstrates the application of various social science concepts and methodologies in the marketing context. Topics include: The Marketing Environment, International Marketing, Market Research, Consumer Behavior, Business-to-Business Marketing, Services Marketing, Market Segmentation, New Product Development, Channels, Marketing Communications, Personal Selling, and Pricing.

Students may not receive credit for both MG 3600 and MKT 3600.

MKT 3640. MANAGEMENT OF PROCESS AND PRODUCT INNOVATION.*(formerly MG/IE 3640)**Cat. I*

This course is based on the hypothesis that high performance firms depend on a sustainable pattern of new and innovative processes and products. Successful companies are examined in regard to their strategies for innovation and technology transfer. Technology alliances among industry, universities, and government are considered in order to increase the leverage of the individual firm. Benchmarking and commercialization from research to actualization is discussed through cases and examples.

Recommended background: FIN 2200 or OIE 2850.

Students may receive credit for only one of the following: MG 3440, MG 3640, or MKT 3640.

MKT 3651. INDUSTRIAL MARKETING.*(formerly MG/IE 3651)**Cat. II*

Provides an understanding of the industrial marketing process and practices. It presents the latest concepts, tools and techniques for marketing complex products and services to industrial and institutional users. Topics include: product innovation strategies; purchasing management and buyer behavior; major intelligence; pricing strategies and tactics; developing markets for new industrial products; bid proposals; industrial distribution; managing the industrial sales force; marketing controls.

Students may not receive credit for both MG 3651 and MKT 3651.

This course will be offered in 2006-07 and in alternating years thereafter.

OPERATIONS AND INDUSTRIAL ENGINEERING (OIE)**OIE 2500. MANAGEMENT SCIENCE I: DETERMINISTIC DECISION MODELS.***(formerly MG/IE 2500)**Cat. I*

This course is designed to provide an introduction to a variety of tools and techniques found useful by modern industrial engineers, operations researchers and managers. These tools are oriented toward the creation and use of mathematical models to assist in managerial decision making in business and other organizations. The models discussed in this course deal with deterministic decision-making problems where there are constraints on available actions. Discussion centers on "classical" methods of optimization and basic methods of linear programming. It is expected that the student will develop an ability to recognize situations in which a given technique is appropriate.

Recommended background: knowledge of calculus.

Students may receive credit for only one of the following: MG 2500, IE 2500, or OIE 2500.

OIE 2850. ENGINEERING ECONOMICS.*(formerly MG/IE 2850)**Cat. I*

To aid all engineering students in understanding economics and business constraints on engineering decision making. Topics include evaluation of alternative; the six time-value-of-money factors; present worth, annual cash flow and rate-of-return analysis; incremental analysis; depreciation and income taxes; replacement analysis; inflation; handling probabilistic events; public economy; break-even and minimum cost points; and foreign exchange.

Students may receive credit for only one of the following: MG 2850, IE 2850, or OIE 2850. Students may not receive credit for both OIE 2850 and FIN 2200.

OIE 3400. PRODUCTION SYSTEM DESIGN.*(formerly MG/IE 3400)**Cat. I*

This course is an introduction to the planning, analysis and design of production systems. It is designed for students in engineering or management who may wish to assume responsibilities in the production of goods or services. Topics to be covered will include: operations strategy, project management, quality management, process analysis, capacity management, and just-in-time and lean systems.

Recommended background: Differential and integral calculus.

Students may receive credit for only one of the following: MG 3400, IE 3400, or OIE 3400.

OIE 3401. PRODUCTION PLANNING AND CONTROL.*(formerly MG/IE 3401)**Cat. I*

This course is an introduction to the planning and control of production systems. Topics include: forecasting, scheduling, material management, and statistical process control.

Recommended background: OIE 3400, MA 2611, and differential and integral calculus.

Students may receive credit for only one of the following: MG 3401, IE 3401, or OIE 3401.

OIE 3405. WORK SYSTEMS AND FACILITIES PLANNING.*(formerly MG/IE 3405)**Cat. I*

This course covers the fundamentals of developing efficient layouts for production and service facilities. Methods analysis, work measurement, material handling and material flow analysis are also covered. Mathematical models and computer tools are used to assist decision-making.

Recommended background: OIE 2500 and OIE 3400.

OIE 3420. QUALITY PLANNING, DESIGN AND CONTROL.*(formerly MG/IE 3420)**Cat. I*

This course focuses on the quality aspects of product design and manufacturing. Topics include: the quality/cost relationship, statistical process control, process capability studies, and design of experiments.

Recommended background: OIE 3400 and MA 2612 or consent of the instructor.

Students may receive credit for only one of the following: MG 3420, IE 3420, or OIE 3420.

OIE 3450. HUMAN FACTORS ENGINEERING.*(formerly MG/IE 3450)**Cat. I*

This course examines the human-machine interface in the workplace, concentrating on how workplace design can influence effectiveness and enhance health, safety, and satisfaction. Human sensory, motor, and decision systems are studied, as well as principles for designing visual and auditory displays, control devices and tools, and work spaces. Problems with repetitive and high physical effort tasks, illumination, noise, and atmospheric conditions, along with relevant governmental regulations, are also considered.

Students may receive credit for only one of the following: MG 3450, IE 3450, or OIE 3450.

OIE 3460. SIMULATION MODELING AND ANALYSIS.*(formerly MG/IE 3460)**Cat. I*

This course covers the application of simulation to a variety of managerial problems with examples from operations management, industrial engineering and manufacturing engineering. It introduces the student to the concepts of computer simulation, with an emphasis on the design of a simulation experiment and statistical interpretation of its results. It will discuss simulation of queueing models, inventory and industrial dynamics, and gaming situations.

The role and use of computers for the execution of simulations will also be highlighted. A commercial simulation language such as SIMAN will be used to solve problems from the manufacturing and service industries.

Recommended background: CS 1101, or CS 1102, and MA 2612.

Students may receive credit for only one of the following: MG 3460, IE 3460, MG 3760, or OIE 3460.

OIE 3501. MANAGEMENT SCIENCE II: RISK ANALYSIS.

(formerly MG/IE 3501)

Cat. I

This course provides coverage in decision analysis. Decision analysis is a technology that assists decision makers in quantifying consideration of complexity and uncertainty in problems of choice. The course applies decision analysis to problems in risk assessment and risk evaluation. Decision making in risk analysis is examined across a wide set of management engineering problems including case studies in environmental risk, product liability, facilities design, and R and D management. The course is intended to be highly integrative with respect to risk analysis including issues such as business ethics and risk communication.

Suggested background: knowledge of calculus and introductory probability and statistics.

Students may receive credit for only one of the following: MG 3501, IE 3501, or OIE 3501.

OIE 4410. CASE STUDIES IN INDUSTRIAL ENGINEERING.

(formerly MG/IE 4410)

Cat. I

A number of in-depth case studies in operations and industrial engineering are analyzed. The cases will cover both manufacturing and service systems ranging from production system design to operations planning and control.

Recommended background: OIE 3400, OIE 3401, OIE 2500 and OIE 3501.

Students may receive credit for only one of the following: MG 3410, IE 3410, MG 4410, IE 4410, or OIE 4410.

OIE 4460. GLOBAL PLANNING AND LOGISTICS.

(formerly MG/IE 4460)

Cat. II

This case-based course will examine methods and strategies for managing and controlling material movement, with particular emphasis on international operations, from the purchase of production materials to the control of work in process to the distribution of the finished product. Strategies that will be discussed include the design of international distribution networks, the use of third-party logistics providers, and the creation of links between logistic systems and marketing to create competitive advantage. The course will also explore tactical issues that must be managed to pursue a logistics strategy successfully, including choices regarding means of transportation, packaging, and inventory policies. Underlying themes of the course will be the use of information technologies (such as electronic data interchange and bar coding) and mathematical models to support logistics decision-making.

Recommended background: OIE 3400 and either FIN 2200 or OIE 2850 or consent of professor.

Students may receive credit for only one of the following: MG 4460, IE 4460, or OIE 4460.

This course will be offered 2007-08 and in alternating years thereafter.

ORGANIZATIONAL BEHAVIOR AND CHANGE (OBC)

OBC 2300. ORGANIZATIONAL SCIENCE—FOUNDATION.

(formerly MG/IE 2300)

Cat. I

This first course in organizational science provides the foundation for an understanding of organization and management. It is a survey of the social science of work, describing the basic knowledge and processes required of managers, including: motivation, communication, supervision, leadership, the group processes of decision making, conflict, work and organizational design, and reconciliation of the goals of individuals and organizations. Lecture, video presentation, group discussion and group mini-projects will be employed to introduce and illustrate the basic elements of management.

Students may receive credit for only one of the following: MG 2300, IE 2300, or OBC 2300.

OBC 3351. ORGANIZATIONAL SCIENCE—MANAGEMENT OF CHANGE.

(formerly MG/IE 3351)

Cat. I

This second course in organizational science provides experience in applying theories of organization and management to the analysis and implementation of organizational change. The course utilizes readings, experiential activities, and case studies of change management in technology-based organizations to provide a conceptual understanding as well as practical knowledge of the change management process. The course is designed as a seminar and workshop.

Recommended background: OBC 2300 or consent of the professor. Students may receive credit for only one of the following: MG 3351, IE 3351, or OBC 3351.

OBC 4364. HUMAN RESOURCE MANAGEMENT.

(formerly MG 4364)

Cat. II

This course in applied organizational sciences introduces concepts and techniques of human resource management. It provides experience in the solution of a variety of human resource problems through classroom exercises and organizational cases, introducing and building upon the basic concepts and techniques of industrial and organizational psychology. The course focuses on changing

labor markets, employee recruitment and selection, performance appraisal and compensation, job evaluation, training and development, job design, labor relations, diversity and gender issues in the workplace, government involvement in human resource issues, job satisfaction, and motivation to work.

Recommended background: OBC 2300 or agreement of the professor.

Students may not receive credit for both MG 4364 and OBC 4364. This course will be offered in 2006-07 and in alternating years thereafter.

OBC 4365. LEADERSHIP IN GROUPS AND ORGANIZATIONS.

(formerly MG 4365)

Cat. I

This course considers the essence of leadership in groups and organizations. Specifically, it examines the personal, interpersonal, group, and contextual factors which affect formal and emergent leadership in groups and organizations. It also examines the effectiveness of various leadership approaches and styles under various conditions. Using case studies, simulations, group projects, and selected readings on leadership in groups and organizations, this course will give students an opportunity to assess and develop their own leadership talents.

Recommended background: OBC 2300 or consent of the professor.

Students may not receive credit for both MG 4365 and OBC 4365.

IS4-MANAGEMENT SEMINAR*:

Current developments in management seminars will be organized periodically and announced in the *Undergraduate Catalog*. No more than 1/3 unit credit will be available for this type #4 IS/P.

*Initials of instructors in charge will appear in *Undergraduate Catalog* in addition to a description of seminar to be offered.

MATHEMATICAL SCIENCES

The second digit in mathematical sciences course numbers is coded as follows:

- 0 — Basic
- 2 — Applied mathematics (general)
- 4 — Applied mathematics (differential equations)
- 6 — Statistics and probability
- 8 — Mathematics (general)

MA 1020. CALCULUS I WITH PRELIMINARY TOPICS.

Cat. I (14-week course)

This course includes the topics of MA 1021 and also presents selected topics from algebra, trigonometry, and analytic geometry.

This course, which extends for 14 weeks and offers 1/3 unit of credit, is designed for students whose precalculus mathematics is not adequate for MA 1021.

Although the course will make use of computers, no programming experience is assumed.

Students many not receive credit for both MA 1020 and MA 1021.

MA 1021. CALCULUS I.

Cat. I

This course provides an introduction to differentiation and its applications.

Topics covered include: functions and their graphs, limits, continuity, differentiation, linear approximation, chain rule, min/max problems, and applications of derivatives.

Recommended background: Algebra, trigonometry and analytic geometry.

Although the course will make use of computers, no programming experience is assumed.

Students many not receive credit for both MA 1021 and MA 1020.

MA 1022. CALCULUS II.

Cat. I

This course provides an introduction to integration and its applications.

Topics covered include: inverse trigonometric functions, Riemann sums, fundamental theorem of calculus, basic techniques of integration, volumes of revolution, arc length, exponential and logarithmic functions, and applications.

Recommended background: MA 1021. Although the course will make use of computers, no programming experience is assumed.

MA 1023. CALCULUS III.

Cat. I

This course provides an introduction to series, parametric curves and vector algebra.

Topics covered include: numerical methods, indeterminate forms, improper integrals, sequences, Taylor's theorem with remainder, convergence of series and power series, polar coordinates, parametric curves and vector algebra.

Recommended background: MA 1022. Although the course will make use of computers, no programming experience is assumed.

MA 1024. CALCULUS IV.*Cat. I*

This course provides an introduction to multivariable calculus.

Topics covered include: vector functions, partial derivatives and gradient, multivariable optimization, double and triple integrals, polar coordinates, other coordinate systems and applications.

Recommended background: MA 1023. Although the course will make use of computers, no programming experience is assumed.

MA 1031. INTRODUCTION TO ANALYSIS I.*Cat. I*

This course provides the fundamentals of mathematical thinking and writing for mathematical proof in analysis. Topics covered include mathematical logic, set theory, functions, cardinality, topology of the real line, limits of sequences.

MA 1032. INTRODUCTION TO ANALYSIS II.*Cat. I*

This course uses the tools developed in MA 1031 to explore the theory of differentiability and introduces the Riemann integral. Topics covered include limits and continuity of functions, the intermediate value theorem, differentiation, mean value theorems, l'Hopital's rule, antiderivatives, the Riemann integral, Riemann integrability.

Recommended background: MA 1031

MA 1033. INTRODUCTION TO ANALYSIS III.*Cat. I*

This course develops the theory of integration and provides an introduction to series of numbers and series of functions. Topics covered include the Fundamental Theorem of Calculus, integration by parts, change of variable, series, convergence tests, rearrangements of series, sequences and series of functions, power series, Taylor series.

Recommended background: MA 1032

MA 1034. INTRODUCTION TO ANALYSIS IV.*Cat. I*

The course provides a rigorous introduction to multivariable analysis. Topics covered include vector algebra, functions of several variables, partial derivatives, gradient, multiple integrals, Green's theorem, Stokes' theorem, divergence theorem. Recommended background: MA 1033

MA 2051. ORDINARY DIFFERENTIAL EQUATIONS.*Cat. I*

This course develops techniques for solving ordinary differential equations. Topics covered include: introduction to modeling using first-order differential equations, solution methods for linear higher-order equations, qualitative behavior of nonlinear first-order equations, oscillatory phenomena including spring-mass system and RLC-circuits and Laplace transform. Additional topics may be chosen from power series method, methods for solving systems of equations and numerical methods for solving ordinary differential equations.

Recommended background: MA 1024.

MA 2071. MATRICES AND LINEAR ALGEBRA I.*Cat. I*

This course provides a study of computational techniques of matrix algebra and an introduction to vector spaces.

Topics covered include: matrix algebra, systems of linear equations, eigenvalues and eigenvectors, least squares, vector spaces, inner products, and introduction to numerical techniques, and applications of linear algebra.

Recommended background: None.

MA 2073. MATRICES AND LINEAR ALGEBRA II.*Cat. I*

This course provides a deeper understanding of topics introduced in MA 2071 and also continues the development of those topics. Topics covered include: abstract vector spaces, linear transformations, matrix representations of a linear transformation, characteristics and minimal polynomials, diagonalization, eigenvalues and eigenvectors, inner product spaces.

This course is design primarily for Mathematical Science majors and those interested in the deeper mathematical issues underlying linear algebra.

Undergraduate credit may not be earned both for this course and for MA 3071. Recommended background: MA 2071.

MA 2201/CS 2022. DISCRETE MATHEMATICS.*Cat. I.*

This course serves as an introduction to some of the more important concepts, techniques, and structures of discrete mathematics providing a bridge between computer science and mathematics.

Topics include functions and relations, sets, countability, groups, graphs, propositional and predicate calculus, and permutations and combinations.

Students will be expected to develop simple proofs for problems drawn primarily from computer science and applied mathematics.

Intended audience: computer science and mathematical sciences majors. Recommended background: None.

MA 2210. MATHEMATICAL METHODS IN DECISION MAKING.*Cat. I*

This course introduces students to the principles of decision theory as applied to the planning, design and management of complex projects. It will be useful to students in all areas of engineering, actuarial mathematics as well as those in such interdisciplinary areas as environmental studies. It emphasizes quantitative, analytic approaches to decision making using the tools of applied mathematics, operations research, probability and computations. Topics covered include: the systems approach, mathematical modeling, optimization and decision analyses. Case studies from various areas of engineering or actuarial mathematics are used to illustrate applications of the materials covered in this course.

Recommended background: MA 1024. Suggested background: Familiarity with vectors and matrices. Although the course makes use of computers, no programming experience is assumed. Students who have received credit for CE 2010 may not receive credit for MA 2210.

MA 2251. VECTOR AND TENSOR CALCULUS.*Cat. I*

This course provides an introduction to tensor and vector calculus, an essential tool for applied mathematicians, scientists, and engineers.

Topics covered include: scalar and vector functions and fields, tensors, basic differential operations for vectors and tensors, line and surface integrals, change of variable theorem in integration, integral theorems of vector and tensor calculus. The theory will be illustrated by applications to areas such as electrostatics, theory of heat, electromagnetics, elasticity and fluid mechanics.

Recommended background: MA 1024.

MA 2271. GRAPH THEORY.*Cat. II*

This course introduces the concepts and techniques of graph theory—a part of mathematics finding increasing application to diverse areas such as management, computer science and electrical engineering. Topics covered include: graphs and digraphs, paths and circuits, graph and digraph algorithms, trees, cliques, planarity, duality and colorability.

This course is designed primarily for Mathematical Science majors and those interested in the deeper mathematical issues underlying graph theory.

Undergraduate credit may not be earned both for this course and for MA 3271. Recommended background: MA 2071.

This course will be offered in 2006-07 and in alternating years thereafter.

MA 2273. COMBINATORICS.*Cat. II*

This course introduces the concepts and techniques of combinatorics—a part of mathematics with applications in computer science and in the social, biological, and physical sciences. Emphasis will be given to problem solving. Topics will be selected from: basic counting methods, inclusion-exclusion principle, generating functions, recurrence relations, systems of distinct representatives, combinatorial designs, combinatorial algorithms and applications of combinatorics.

This course is designed primarily for Mathematical Sciences majors and those interested in the deeper mathematical issues underlying combinatorics.

Undergraduate credit may not be earned both for this course and for MA 3273. Recommended background: MA 2071.

This course will be offered in 2007-08 and in alternating years thereafter.

MA 2431. MATHEMATICAL MODELING WITH ORDINARY DIFFERENTIAL EQUATIONS.*Cat. I*

This course focuses on the theoretical foundations of ordinary equations while building models for physical and biological systems. Mathematical topics may include methods for solving systems of ordinary differential equations, existence and uniqueness theory, stability theory, phase-plane analysis and limit cycles. Examples will be chosen from electrical and mechanical oscillations, control theory, ecological models and reaction kinetics. Students will learn how to turn a real-life physical or biological problem into a mathematical one and to interpret the mathematical results.

This course is designed primarily for Mathematical Sciences majors and those interested in the deeper mathematical issues underlying mathematical modeling.

Undergraduate credit may not be earned both for this course and for MA 3431. Recommended background: MA 1024, MA 2051 and MA 2071.

MA 2611. APPLIED STATISTICS I.*Cat. I*

This course is designed to introduce the student to data analytic and applied statistical methods commonly used in industrial and scientific applications as well as in course and project work at WPI. Emphasis will be on the practical aspects of statistics with students analyzing real data sets on an interactive computer package.

Topics covered include analytic and graphical representation of data, exploratory data analysis, basic issues in the design and conduct of experimental and observational studies, discrete and continuous probability models, the central limit theorem, and one and two sample point and interval estimation.

Recommended background: MA 1022.

MA 2612. APPLIED STATISTICS II.
Cat. I

This course is a continuation of MA 2611.

Topics covered include tests of hypotheses, simple and multiple regression, one and two-way tables for categorical data, and design and analysis of one factor experiments.

Recommended background: MA 2611.

MA 2621. PROBABILITY FOR APPLICATIONS.
Cat. I

This course is designed to introduce the student to probability.

Topics to be covered are: basic probability theory including Bayes theorem; discrete and continuous random variables; special distributions including the Bernoulli, Binomial, Geometric, Poisson, Uniform, Normal, Exponential, Chi-square, Gamma, Weibull, and Beta distributions; multivariate distributions; conditional and marginal distributions; independence; expectation; transformations of univariate random variables.

Recommended background: MA 1024.

MA 2631. PROBABILITY.
Cat. I

The purpose of this course is twofold:

- To introduce the student to probability. Topics to be covered will be chosen from: axiomatic development of probability; independence; Bayes theorem; discrete and continuous random variables; expectation; special distributions including the binomial and normal; moment generating functions; multivariate distributions; conditional and marginal distributions; independence of random variables; transformations of random variables; limit theorems.
- To introduce fundamental ideas and methods of mathematics using the study of probability as the vehicle. These ideas and methods may include systematic theorem-proof development starting with basic axioms; mathematical induction; set theory; applications of univariate and multivariate calculus.

This course is designed primarily for Mathematical Sciences majors and those interested in the deeper mathematical issues underlying probability theory.

Recommended background: MA 1024.

Undergraduate credit may not be earned both for this course and for MA 2621.

MA 3211. THEORY OF INTEREST.
Cat. I

An introduction to actuarial mathematics is provided for those who may be interested in the actuarial profession.

Topics usually included are: measurement of interest, including accumulated and present value factors; annuities certain; amortization schedules and sinking funds; and bonds.

Recommended background: MA 1024 and the ability to write computer programs.

MA 3212. LIFE CONTINGENCIES.
Cat. I

A continuation of a study of actuarial mathematics with emphasis on the theory and application of contingency mathematics in the areas of life insurance and annuities.

Topics usually included are: survival functions and life tables; life insurance; life annuities; net premiums; and premium reserves.

Recommended background: MA 3211 and either MA 2621 or MA 2631.

MA 3231. LINEAR PROGRAMMING.
Cat. I

This course considers the formulation of real-world optimization problems as linear programs, the most important algorithms for their solution, and techniques for their analysis.

Topics covered include: the primal and dual simplex algorithms, duality theory, parametric analysis, network flow models and, as time permits, bounded variable linear programs or interior methods.

Recommended background: MA 2071.

MA 3233. DISCRETE OPTIMIZATION.
Cat. II

Discrete optimization is a lively field of applied mathematics in which techniques from combinatorics, linear programming, and the theory of algorithms are used to solve optimization problems over discrete structures, such as networks or graphs.

The course will emphasize algorithmic solutions to general problems, their complexity, and their application to real-world problems drawn from such areas as VLSI design, telecommunications, airline crew scheduling, and product distribution.

Topics will be selected from: Network flow, optimal matching, integrality of polyhedra, matroids, and NP-completeness.

Undergraduate credit may not be earned both for this course and for MA 4233.

Recommended background: At least one of MA 2271, MA 2273 or MA 3231.

This course will be offered in 2006-07 and in alternating years thereafter.

MA 3257/CS 4032. NUMERICAL METHODS FOR LINEAR AND NONLINEAR SYSTEMS.
Cat. I

This course provides an introduction to modern computational methods for linear and nonlinear equations and systems and their applications.

Topics covered include: solution of nonlinear scalar equations, direct and iterative algorithms for the solution of systems of linear equations, solution of nonlinear systems, the eigenvalue problem for matrices. Error analysis will be emphasized throughout.

Recommended background: MA 2071. An ability to write computer programs in a scientific language is assumed.

MA 3457/CS 4033. NUMERICAL METHODS FOR CALCULUS AND DIFFERENTIAL EQUATIONS.
Cat. I

This course provides an introduction to modern computational methods for differential and integral calculus and differential equations.

Topics covered include: interpolation and polynomial approximation, approximation theory, numerical differentiation and integration, numerical solutions of ordinary differential equations. Error analysis will be emphasized throughout.

Recommended background: MA 2051. An ability to write computer programs in a scientific language is assumed. Undergraduate credit may not be earned for both this course and for MA 3255/CS 4031.

MA 3471. ADVANCED ORDINARY DIFFERENTIAL EQUATIONS.
Cat. II

The first part of the course will cover existence and uniqueness of solutions, continuous dependence of solutions on parameters and initial conditions, maximal interval of existence of solutions, Gronwall's inequality, linear systems and the variation of constants formula, Floquet theory, stability of linear and perturbed linear systems. The second part of the course will cover material selected by the instructor. Possible topics include: Introduction to dynamical systems, stability by Lyapunov's direct method, study of periodic solutions, singular perturbation theory and nonlinear oscillation theory.

Recommended background: MA 2431 and MA 3832.

This course will be offered in 2007-08 and in alternating years thereafter.

MA 3475. CALCULUS OF VARIATIONS.
Cat. II.

This course covers the calculus of variations and select topics from optimal control theory. The purpose of the course is to expose students to mathematical concepts and techniques needed to handle various problems of design encountered in many fields, e. g. electrical engineering, structural mechanics and manufacturing.

Topics covered will include: derivation of the necessary conditions of a minimum for simple variational problems and problems with constraints, variational principles of mechanics and physics, direct methods of minimization of functions, Pontryagin's maximum principle in the theory of optimal control and elements of dynamic programming.

Recommended background: MA 2051.

This course will be offered in 2006-07 and in alternating years thereafter.

MA 3627. APPLIED STATISTICS III.
Cat. II

This course continues the exploration of statistics for scientific and industrial applications, begun in MA 2611 and MA 2612. Topics will be chosen from distribution-free methods, the design and analysis of general factorial experiments, two-level factorial and fractional factorial experiments, Taguchi methods, response surface analysis, and statistical quality control.

Recommended background: MA 2612.

This course will be offered in 2007-08, and in alternating years thereafter.

MA 3631. MATHEMATICAL STATISTICS.
Cat. I

This course introduces students to the mathematical principles of statistics. Topics will be chosen from: Sampling distributions, limit theorems, point and interval estimation, sufficiency, completeness, efficiency, consistency; the Rao-Blackwell theorem and the Cramer-Rao bound; minimum variance unbiased estimators and maximum likelihood estimators; tests of hypotheses including the Neyman-Pearson lemma, uniformly most powerful and likelihood ratio tests.

Recommended background: MA 2631.

MA 3823. GROUP THEORY.
Cat. II

This course provides an introduction to one of the major areas of modern algebra. Topics covered include: groups, subgroups, permutation groups, normal subgroups, factor groups, homomorphisms, isomorphisms and the fundamental homomorphism theorem. Recommended background: MA 2073.

This course will be offered in 2006-07 and in alternating years thereafter.

MA 3825. RINGS AND FIELDS.*Cat. II*

This course provides an introduction to one of the major areas of modern algebra. Topics covered include: rings, integral domains, ideals, quotient rings, ring homomorphisms, polynomial rings, polynomial factorization, extension fields and properties of finite fields. Recommended background: MA 2073.

This course will be offered in 2007-08 and in alternating years thereafter.

Undergraduate credit may not be earned both for this course and for MA 3821.

MA 3831. ADVANCED CALCULUS I.*Cat. I*

Advanced Calculus is a two-part course giving a rigorous presentation of the important concepts of classical real analysis.

Topics covered in the two-course sequence include: basic set theory, elementary topology of Euclidean spaces, limits and continuity, differentiation Riemann-Stieltjes integration, infinite series, sequences of functions, and topics in multivariate calculus.

Recommended background: MA 2051 and MA 2071.

MA 3832. ADVANCED CALCULUS II.*Cat. I*

MA 3832 is a continuation of MA 3831.

For the contents of this course, see the description given for MA 3831.

Recommended background: MA 3831.

MA 4213. RISK THEORY.*Cat. II*

This course covers topics in risk theory as it is applied, under specified assumptions, to insurance.

Topics covered include: economics of insurance, short term individual risk models, single period and extended period collective risk models, and applications.

Recommended background: MA 2631.

This course will be offered in 2007-08 and in alternating years thereafter.

MA 4214. SURVIVAL MODELS.*Cat. II*

Survival models are statistical models of times to occurrence of some event. They are widely used in areas such as the life sciences and actuarial science (where they model such events as time to death, or to the development or recurrence of a disease), and engineering (where they model the reliability or useful life of products or processes). This course introduces the nature and properties of survival models, and considers techniques for estimation and testing of such models using realistic data.

Topics covered will be chosen from: parametric and nonparametric survival models, censoring and truncation, nonparametric estimation (including confidence intervals and hypothesis testing) using right-, left-, and otherwise censored or truncated data.

Recommended background: MA 3631.

This course will be offered in 2006-07, and in alternating years thereafter.

MA 4235. MATHEMATICAL OPTIMIZATION.*Cat. II*

This course explores theoretical conditions for the existence of solutions and effective computational procedures to find these solutions for optimization problems involving nonlinear functions.

Topics covered include: classical optimization techniques, Lagrange multipliers and Kuhn-Tucker theory, duality in nonlinear programming, and algorithms for constrained and unconstrained problems.

Recommended background: Vector calculus at the level of MA 2251.

This course will be offered in 2007-08 and in alternating years thereafter.

MA 4237. PROBABILISTIC METHODS IN OPERATIONS RESEARCH.*Cat. II*

This course develops probabilistic methods useful to planners and decision makers in such areas as strategic planning, service facilities design, and failure of complex systems.

Topics covered include: decisions theory, inventory theory, queuing theory, reliability theory, and simulation.

Recommended background: Probability theory at the level of MA 2621 or MA 2631.

This course will be offered in 2007-08 and in alternating years thereafter.

MA 4291. APPLICABLE COMPLEX VARIABLES.*Cat. I*

This course provides an introduction to the ideas and techniques of complex analysis that are frequently used by scientists and engineers. The presentation will follow a middle ground between rigor and intuition.

Topics covered include: complex numbers, analytic functions, Taylor and Laurent expansions, Cauchy integral theorem, residue theory, and conformal mappings.

Recommended background: MA 1024 and MA 2051.

MA 4411. NUMERICAL ANALYSIS OF DIFFERENTIAL EQUATIONS.*Cat. II*

This course is concerned with the development and analysis of numerical methods for differential equations.

Topics covered include: well-posedness of initial value problems, analysis of Euler's method, local and global truncation error, Runge-Kutta methods, higher order equations and systems of equations, convergence and stability analysis of one-step methods, multistep methods, methods for stiff differential equations and absolute stability, introduction to methods for partial differential equations.

Recommended background: MA 2071 and MA 3457/CS 4033. An ability to write computer programs in a scientific language is assumed.

This course will be offered in 2006-07, and in alternating years thereafter.

MA 4451. BOUNDARY VALUE PROBLEMS.*Cat. I*

Science and engineering majors often encounter partial differential equations in the study of heat flow, vibrations, electric circuits and similar areas. Solution techniques for these types of problems will be emphasized in this course.

Topics covered include: derivation of partial differential equations as models of prototype problems in the areas mentioned above, Fourier Series, solution of linear partial differential equations by separation of variables, Fourier integrals and a study of Bessel functions.

Recommended background: MA 1024 or and MA 2051.

MA 4473. PARTIAL DIFFERENTIAL EQUATIONS.*Cat. II*

The first part of the course will cover the following topics: classification of partial differential equations, solving single first order equations by the method of characteristics, solutions of Laplace's and Poisson's equations including the construction of Green's function, solutions of the heat equation including the construction of the fundamental solution, maximum principles for elliptic and parabolic equations. For the second part of the course, the instructor may choose to expand on any one of the above topics.

Recommended background: MA 2251 and MA 3832.

This course will be offered in 2006-07 and in alternating years thereafter.

MA 4631. PROBABILITY AND MATHEMATICAL STATISTICS I.*Cat. I (14 week course)*

Intended for advanced undergraduates and beginning graduate students in the mathematical sciences and for others intending to pursue the mathematical study of probability and statistics, this course begins by covering the material of MA 3613 at a more advanced level. Additional topics covered are: one-to-one and many-to-one transformations of random variables; sampling distributions; order statistics, limit theorems.

Recommended background: MA 2631 or MA 3613, MA 3831 - MA 3832.

MA 4632. PROBABILITY AND MATHEMATICAL STATISTICS II.*Cat. I (14 week course)*

This course is designed to complement MA 4631 and provide background in principles of statistics.

Topics covered include: point and interval estimation; sufficiency, completeness, efficiency, consistency; the Rao-Blackwell theorem and the Cramer-Rao bound; minimum variance unbiased estimators, maximum likelihood estimators and Bayes estimators; tests of hypothesis including uniformly most powerful, likelihood ratio, minimax and bayesian tests.

Recommended background: MA 3631 or MA 4631.

MA 4658. STATISTICAL CONSULTING.*Cat. I (14 week course)*

After suitable preparation through readings and discussion, undergraduate students will learn about statistical practice as part of a statistical consulting team consisting of undergraduate and graduate students. The team will provide statistical expertise to clients from the WPI community under faculty supervision. There are no formal prerequisites, but knowledge of a range of statistical methodology, such as that supplied by MA 2611-12 and MA 3627, is strongly recommended.

MA 4891. TOPICS IN MATHEMATICS.*Cat. I*

MECHANICAL ENGINEERING

For a detailed description of each of these courses, check the video tape index at the Gordon Library.

The second digit in mechanical engineering course numbers is coded as follows:

- 0 — General mechanical engineering
- 1 —
- 2 —
- 3 — Design
- 4 — Thermal—fluids
- 5 — Engineering mechanics
- 6 — Fluid mechanics—hydraulics
- 7 — Aerospace
- 8 — Materials
- 9 — Engineering experimentation

ME 1520. THE TECHNOLOGY OF ALPINE SKIING.

Cat. II

This course explores science and engineering issues associated with equipment and technique for alpine skiing, particularly racing. A diverse group of technical subjects related to engineering mechanics are discussed: tribology, beams, rigid body motion, material science, machining and biomechanics. Specifically we will examine: ski-snow interactions, technique for gliding, turning and stepping, selection of line in racing; equipment design, testing and performance; and ski injuries. We will also address issues in the epidemiology of skiing injuries, the calculation of the cost of ski injuries to society, the impact of ski equipment technology on litigation and the impact of litigation on equipment and trail design.

This course will be offered in 2006-07 and in alternating years thereafter.

ME 1800. MATERIALS SELECTION AND MANUFACTURING PROCESSES.

Cat. I

This course is designed to introduce the student to the engineering fundamentals of the most commonly encountered manufacturing processes. A thorough treatment of manufacturing processes including forging, rolling, drawing, EDM, PM, welding, casting, and machining are developed through a combination of class work and manufacturing laboratory experience. The laboratory experience includes an experimental component measuring and analyzing a manufacturing process and system. Each student is required to fabricate and assemble his/her own Stirling engine.

This course is recommended for all majors, for students who plan to utilize the manufacturing laboratory facilities as part of their MQP work, or for those students who wish a fundamental background in materials processing.

ME 2300. INTRODUCTION TO ENGINEERING DESIGN.

Cat. I

Real world engineering design problems usually have more than one correct solution. This course utilizes a realistic design process to introduce students to the methods and techniques for solving engineering problems. Lectures will support the design projects and may cover engineering economics, fluid dynamics, heat transfer, mechanics, statistics, and basic circuits. No prior knowledge of fluids, heat transfer, economics, statistics or electrical circuits is required. Laboratory sessions will be used to build, test and demonstrate various designs.

This course is designed for sophomores and juniors to provide a broad overview of engineering design.

The course includes a significant writing component and makes extensive use of PCs for word processing, spread sheet calculations and programming.

Recommended background: Ordinary Differential Equations (MA 2051), mechanics (PH 1110), statics (ES 2501), any programming language.

ME 2713. ASTRONAUTICS.

Cat. I

Topics studied: Orbital mechanics including spacecraft maneuvering and station keeping, transfer orbits, and interplanetary transfers; space environment including characteristics of low earth highly elliptical and geosynchronous orbits; ascent and reentry trajectories.

Recommended background: Dynamics (ES 2503).

ME 2820. MATERIALS PROCESSING.

Cat. I

An introduction to material processing in manufacturing. This course provides important background for anyone interested in manufacturing, design engineering design, sales, or management.

Processing of polymers, ceramics, metals and composites is discussed. Processes covered include: rolling, injection molding, forging, powder metallurgy, joining and machining. The relationships between materials, processes, processing parameters and the properties of manufactured parts are developed. During the course the students should develop the ability to choose materials, processes, and processing parameters for designing manufacturing procedures to take a prototype part to production.

Recommended background: ME 1800 Materials Selection and Manufacturing Processes, and ES 2001 Introduction to Materials Science.

ME 3023. MECHANICAL BEHAVIOR AND MODELING PROPERTIES OF ENGINEERING MATERIALS.

Cat. II

This course is concerned with different types of material response to mechanical loads. The course studies the constitutive equations that are used to model the properties of engineering materials. The behavior of elastic, plastic, composite and visco-elastic materials is considered. Experiments describing materials behaviors will be conducted and the behavior will be modeled.

Topics include: descriptions of material behavior, methods of determining the material parameters from experimental tests, behavior of different types of materials under simple states of loading and deformation such as tensile stress-strain response (elastic and plastic), and time-dependent behavior at room and elevated temperature (viscoelasticity and creep) are studied. Theories of failure and failure modes under monotonic and cyclic loading, fracture and fracture mechanics, and methods of modifying material behavior are discussed. These topics will be integrated in several material selection projects.

Recommended background: statics (ES 2501), stress analysis (ES 2502), continuum mechanics (ES 3501), materials (ES 2001).

This course will be offered in 2006-07 and in alternating years thereafter.

ME 3310. KINEMATICS OF MECHANISMS.

Cat. I

An introduction to the synthesis and analysis of linkages, cams and gear trains is presented. The design process is introduced and used to solve unstructured design problems in linkage and cam design. Algebraic and graphical techniques to analyze the displacement, velocity and acceleration of linkages and cams are developed. Computer programs for the design and analysis of linkages are used by students. Results of student design projects are presented in professional engineering reports.

Recommended background: Ordinary Differential Equations (MA 2051), statics (ES 2501), dynamics (ES 2503).

ME 3311. DYNAMICS OF MECHANISMS AND MACHINES.

Cat. II

This course provides an in-depth study of forces in dynamic systems. Dynamic force analysis is developed using matrix methods. Computer programs are used to solve the sets of simultaneous equations derived by students for realistic, unstructured design problems. Inertial and shaking forces, elementary mechanical vibrations, torque-time functions, rotational and reciprocating balance and cam dynamics are covered using the internal combustion engine as a design example. Students execute unstructured design projects and prepare professional engineering reports on the results. Computers are used extensively to solve the dynamic equations.

Recommended background: Ordinary Differential Equations (MA 2051), statics (ES 2501), dynamics (ES 2503), kinematics (ME 3310), linear algebra.

This course will be offered in 2007-08 and in alternating years thereafter.

ME 3320. DESIGN OF MACHINE ELEMENTS.

Cat. I

This is an introductory course in mechanical design analysis, and it examines stress and fatigue in many machine elements. Common machine elements are studied and methods of selection and design are related to the associated hardware.

Topics covered include: combined stresses, fatigue analysis, design of shafts, springs, gears, bearings and miscellaneous machine elements.

Recommended background: mechanics (ES 2501, ES 2502, ES 2503), materials (ME 1800, ME 2820), computer programming (CS 1001).

ME 3321. DYNAMIC MODELING.

Cat. II

This course introduces students to the modeling and analysis of dynamic systems. A unified treatment of mechanical, electrical, fluid and thermal systems is presented using the bond graph modeling language. The creation of dynamic models and the analysis of model response is emphasized.

Lecture topics include energy storage and dissipation elements, transducers, transformers, formulation of equations for a dynamic system and time response of linear systems. Computers are used extensively for both system modeling and analysis.

Recommended background: mathematics (MA 2051, MA 2071), fluids (ES 3004), mechanics (ES 2501, ES 2503).

This course will be offered in 2006-07 and in alternating years thereafter.

ME 3410. COMPRESSIBLE FLOW.

Cat. I

The application of basic thermodynamics and fluid mechanics to model the flow phenomena of compressible fluids. The assumptions leading to various flow models and the limits of these models are emphasized. The approach is, in the main, a one-dimensional control volume analysis, and the course is designed for engineering students.

Topics covered include: reversible flow, flow with heat transfer, flow with friction, normal and oblique shock waves, flow with chemical reaction, and flow with applied electric and magnetic fields.

Recommended background: thermodynamics (ES 3001), fluids (ES 3004).

ME 3501. ELEMENTARY CONTINUUM MECHANICS.*Cat. II*

In typical mathematics courses, students learn principles and techniques by solving many short and specially prepared problems. They rarely gain experience in formulating and solving mathematical equations that apply to real life engineering problems. This course will give students this type of applied mathematical experience.

The course emphasizes the application of basic laws of nature as they apply to differential elements which lead to differential equations that need to be solved; all of these ideas are used in higher level engineering science courses such as fluid mechanics, heat transfer, elasticity, etc. Emphasis will be placed on understanding the physical concepts in a problem, selecting appropriate differential elements, developing differential equations, and finding ways to solve these equations. Limitations on the mathematical solutions due to assumptions made will be considered.

Recommended background: Ordinary Differential Equations (MA 2051), statics (ES 2501), dynamics (ES 2503).

This course will be offered in 2006-07 and in alternating years thereafter.

ME 3506. REHABILITATION ENGINEERING.*Cat. I*

The course exposes the students to the use of technology to design devices to ameliorate the handicaps of individuals with disabilities. This course focuses on the design process for assistive devices including defining the problem, setting design criteria, developing preliminary designs, selecting, analyzing and testing a final design. Human factors are integrated into all phases of the design process.

Topics include: ergonomics, physical and cognitive parameters that effect the user interface, safety, economics, reliability and esthetics. Design and analysis of devices used for mobility and in daily activities in residential, educational and vocational settings. Laboratory sessions will be used to develop conceptual designs that solve real problems.

Recommended background: mechanics (ES 2501, ES 2502, ES 2503), kinematics (ME 3310), design (ME 2300), materials (ME 1800, ME 2820), electrical engineering (ECE 3601).

ME 3601. PRINCIPLES OF MECHANICAL ENGINEERING*Cat. I*

Intended for students other than mechanical or manufacturing engineering students, this course is oriented towards developing competence in mechanical engineering concepts on the level that the technology interfaces directly with their own discipline. The course is designed specifically to help students meet that challenge through the development of a broad systems perspective and an understanding of the principal elements of mechanical engineering technology. The expectation is that students completing this course will be able to handle adequately the mechanical aspects of a broad range of application topics. In addition, and most important, they will be prepared to work effectively with mechanical engineers on the joint solution of complex problems.

Topics covered during the course include, but are not limited to, the fundamentals of: statics, dynamics, kinematics, kinetics, materials, heat transfer, fluid dynamics, thermodynamics, stress analysis, vibrations, error and uncertainty analysis, as well as current trends and future directions in solution methodologies, and will be illustrated with representative applications, such as, electro-thermo-mechanical and viscoelastic systems, electronic packaging, and MEMS. Selected projects are included to emphasize the direct application of the information presented in lectures.

Intended for non-Mechanical Engineering or non-Manufacturing Engineering majors.

Recommended background: MA 1021-1024, MA 2051, CH 1010, PH 1110/1111-PH1120/1121, or equivalent. Intended audience, non-mechanical and manufacturing majors.

ME 3602. INTERMEDIATE FLUID DYNAMICS.*Cat. I*

A second course in fluid mechanics concerned with the application of basic principles. Applications include velocity potentials and stream functions, fluid machinery, pipe networks and unsteady flow. The equations of viscous flow are developed with applications including exact solutions, energy, dissipation and introductory boundary layer theory.

Recommended background: fluids (ES 3004).

ME 3711. SUBSONIC AERODYNAMICS.*Cat. I*

This course provides an introductory study of aerodynamics in the low speed, incompressible flight regime. Topics covered include: prediction of aerodynamic forces (lift, drag) and moments, dynamic similarity, experimental techniques in aerodynamics, potential flow theory, Kutta-Joukowski theorem, circulation, thin airfoil theory, panel methods, finite wing theory and induced drag, viscous flow over airfoils, and aircraft performance.

Recommended background: Fluid Mechanics (ES 3004), Intermediate Fluid Mechanics (ME 3602) or equivalent.

ME 3801. EXPERIMENTAL METHODS IN MATERIALS SCIENCE AND ENGINEERING.*Cat. I*

This course is designed to meet the experimental design requirement for ME students.

A course designed to develop analytical and experimental skills in modern engineering measurement methods, based on electronic instrumentation and computer-based data acquisition systems. The lectures are concerned with the engineering analysis and design as well as the principles of instrumentation, whereas the laboratory periods afford the student an opportunity to use modern devices in materials engineering experiments. Lecture topics include: review of materials and mechanical engineering fundamentals, and, among others, discussions of standards, measurement, and sensing devices, experiment planning, data acquisition, analysis of experimental data, and report writing. Laboratory experiments address both mechanical and thermal systems and instrumentation in materials engineering (temperature and pressure measurements in materials processing, measurement of strain and position in mechanical testing of materials).

Recommended background: mathematics (MA 2051), thermo-fluids (ES 3001, ES 3003, ES 3004), mechanics (ES 2501, ES 2502, ES 2503), materials (ES 2001).

ME 3820. COMPUTER-AIDED MANUFACTURING.*Cat. I*

This introductory course in modern control systems will give students an understanding of the basic techniques, and the range of equipment used in most computer controlled manufacturing operations. The class work is reinforced by hands-on laboratories in the Robotics/CAM lab. Modeling and analysis of machining processes, and applications of PLC (programmable logic control) are included.

Class topics include: Manufacturing Automation, Microcomputers for Process Monitoring and Control, Computer Numerical Control, Switching Theory and Ladder Logic, Transducers and Signal Conditioning, and Closed Loop Digital Control. The laboratories allow students to program and implement several types of the controllers, and will provide an introduction to the topic of industrial robotics.

Recommended background: manufacturing (ME 1800), materials processing (ME 2820), elementary computer/logic device programming.

ME 3901. ENGINEERING EXPERIMENTATION.*Cat. I*

A course designed to develop analytical and experimental skills in modern engineering measurement methods, based on electronic instrumentation and computer-based data acquisition systems. The lectures are concerned with the engineering analysis and design as well as the principles of instrumentation, whereas the laboratory periods afford the student an opportunity to use modern devices in actual experiments.

Lecture topics include: review of engineering fundamentals and, among others, discussions of standards, measurement and sensing devices, experiment planning, data acquisition, analysis of experimental data, and report writing.

Laboratory experiments address both mechanical and thermal systems and instrumentation in either traditional mechanical engineering (heat transfer, flow measurement/visualization, force/torque/strain measurement, motion/vibration measurement) or materials engineering (temperature and pressure measurements in materials processing, measurement of strain and position in mechanical testing of materials). Each year students will be notified which type of experiments will be used in each term offering. Students may also consult with their academic advisor or the Mechanical Engineering department office.

Recommended background: mathematics (MA 2051), thermo-fluids (ES 3001, ES 3003, ES 3004), mechanics (ES 2501, ES 2502, ES 2503), materials (ES 2001).

ME 4320. ADVANCED ENGINEERING DESIGN.*Cat. I*

This course integrates students' background in ME in a one-term design project that is usually taken from a local company. Students must organize themselves and the project to successfully realize a product that meets customer needs. Activities include problem definition, design analysis, mathematical modelling, CAD modelling, manufacturing, testing, liaison to vendors, customer relations, marketing, technical management, purchasing, report writing, and oral presentations.

Recommended background: mechanisms (ME 3310, ME 3311), stress analysis (ES 3502), design (ME 3320), thermo-fluids (ES 3001, ES 3003, ES 3004), materials (ES 2001), manufacturing (ME 1800).

ME 4429. THERMOFLUID APPLICATION AND DESIGN.*Cat. I*

This course integrates thermodynamics, fluid mechanics and heat transfer through the use of design projects involving modern technologies, such as electronic cooling, vapor compression power cycles, and turbines. Activities include problem definition, design creation and analysis, mathematical modeling, cost analysis and optimization.

Recommended background: thermofluids (ES 3001, ES 3003, ES 3004) and an introduction to design.

ME 4430. INTEGRATED THERMOMECHANICAL DESIGN AND ANALYSIS.*Cat. II*

Current state-of-the-art computer based methodologies used in the design and analysis of thermomechanical systems will be presented and illustrated by selected laboratory demonstrations, and used in projects. Projects will include thermal, mechanical, electronic, and photonic loads of steady state and dynamic nature and will integrate design, analysis, and testing. Students will prepare a technical report and present their results. Topics will include, but not be limited to, thermomechanics of fiber optic telecommunication cables, high-energy beam interactions with materials, shape memory alloys, microelectronics, MEMS and mechatronics.

Recommended background: MA 2051, ES 2001, ES 2502, ES 3003, ECE 3601, ME 3901, and an introduction to design.

This course will be offered in 2007-08 and in alternating years thereafter.

ME/BME 4504. BIOMECHANICS.*Cat. II*

This course emphasizes the applications of mechanics to describe the material properties of living tissues. It is concerned with the description and measurements of these properties as related to their physiological functions. Emphasis on the interrelationship between biomechanics and physiology in medicine, surgery, body injury and prostheses.

Topics covered include: review of basic mechanics, stress, strain, constitutive equations and the field equations, viscoelastic behavior, and models of material behavior. The measurement and characterization of properties of tendons, skin, muscles and bone. Biomechanics as related to body injury and the design of prosthetic devices.

Recommended background: mechanics (ES 2501, ES 2502, ES 2503, ME 3501), mathematics (MA 2051).

This course will be offered in 2007-08 and in alternating years thereafter.

ME 4505. ADVANCED DYNAMICS.*Cat. II*

This course completes a sequence of sophomore, junior and senior courses in Dynamic Systems, i.e., ES 2503, ME 3505, and ME 4505, which are essential in an undergraduate Mechanical Engineering curriculum. An advanced course intended to emphasize the development and applications of dynamics in three-dimensional space. Problem solutions emphasize the use of vector algebra, matrix methods and differential equations with a goal of developing the student's ability to translate physical problems into mathematical models.

Topics covered include: three-dimensional kinematics using rotating and stationary frames of reference, development of force, energy and momentum equations governing general particle and rigid body systems. Applications of equations to rigid, elastic, and fluid problems.

Recommended background: dynamics (ES 2503).

This course will be offered in 2006-07 and in alternating years thereafter.

ME 4506. MECHANICAL VIBRATIONS.*Cat. I*

This course is an introduction to the fundamental concepts of mechanical vibrations, which are important for design and analysis of mechanical and structural systems subjected to time-varying loads. The objective of the course is to expose the students to mathematical modeling and analysis of such systems

Topics covered include: formulation of the equations of motion using Newton's Laws, D'Alembert's Principle and energy methods; prediction of natural frequency for single-degree-of-freedom systems; modeling stiffness characteristics, damping and other vibrational properties of mechanical systems; basic solution techniques by frequency response analysis and convolution integral methods. Examples may include analysis and design for transient passage through resonance; analysis and design of vibration measurement devices; introductory rotordynamics. The course is mainly focused on analysis of single-degree-of-freedom systems, however a basic introduction into multidegree-of-freedom systems is also presented. Computer-based project may be suggested.

Recommended background: Ordinary Differential Equations (MA 2501), Statics (ES 2501), Dynamics (ES 2503).

ME 4512. INTRODUCTION TO THE FINITE ELEMENT METHOD.*Cat. I*

This course serves as an introduction to finite element analysis (FEA) for stress analysis problems. Finite element equations are developed for several element types from stiffness and energy approaches and used to solve simple problems. Element types considered include spring, truss, beam, two-dimensional (plane stress/strain and axisymmetric solid), three-dimensional and plates. Stress concentrations, static failures, and fatigue failures are considered for each element type. Emphasis will be placed on knowing the behavior and usage of each element type, being able to select a suitable finite element model for a given problem, and being able to interpret and evaluate the solution quality. A commercial, general-purpose finite element computer program is used to solve problems that are more complex. Projects are used to introduce the use of FEA in the iterative design process.

Recommended background: Mathematics (MA 2051, MA 2071), Mechanics (ES2501 & ES 2502 or CE2000 & CE2001).

ME/BME 4606. BIOFLUIDS.*Cat. II*

This course emphasizes the applications of fluid mechanics to biological problems. The course concentrates primarily on the human circulatory and respiratory systems. Topics covered include: blood flow in the heart, arteries, veins and microcirculation and air flow in the lungs and airways. Mass transfer across the walls of these systems is also presented.

Recommended background: continuum mechanics (ME 3501), fluids (ES 3004).

This course will be offered in 2006-07 and in alternating years thereafter.

ME 4712. SUPERSONIC AERODYNAMICS.*Cat. II*

This course introduces the study of performance and dynamic behavior of vehicles moving through fluids.

Topics covered include: subsonic and supersonic performance of aircraft and rockets, external flow fields, aerodynamic heating, shock and expansion patterns, control surface interaction, and real gas effects, aerodynamic stability including interaction with structural dynamics. Applications to flutter, dynamic stability, and control system performance.

Recommended background: subsonic aerodynamics (ME 3711).

This course will be offered in 2006-07 and in alternating years thereafter.

ME 4713. SPACECRAFT DYNAMICS AND CONTROL.*Cat. I*

The course covers broad topics in spacecraft attitude dynamics, stability and control. The course includes a review of particle and two-body dynamics and introduction to rigid body dynamics. Orbital and attitude maneuvers are presented. Attitude control devices and momentum exchange techniques such as spinners, dual spinners, gravity gradient, and geomagnetic torques are presented. Attitude sensors/actuators are presented and the attitude control problem is introduced. Gyroscopic instruments are introduced and demonstrated in the laboratory. Open-loop stability analysis for a variety of equilibrium conditions is discussed. Control using momentum exchange and mass expulsion (thrusters) devices is discussed.

Recommended background: Astronautics (ME 2713). Suggested background includes concepts of control theory as covered in Control Engineering I (ES 3011), and concepts of particle dynamics as covered in Intermediate Mechanics (PH 2201) or Introduction to Dynamic Systems (ES 2503).

ME 4715. AEROSPACE STRUCTURES.*Cat. I*

Aircraft and space vehicle structural design including finite element analysis, modal analysis, and thermal loading along with traditional and composite material characteristics and selection for atmospheric and space environment are studied. Flutter, transient response, and large structure dynamics are typical examples used.

Recommended background: mechanics (ES 2501, ES 2502, ES 2503), subsonic aerodynamics (ME 3711).

ME 4716. AIRBREATHING PROPULSION.*Cat. II*

This course provides a study of air breathing engines for aircraft and ground-based applications. Topics covered include: Thermodynamic cycles and fluid dynamics of aero engines, including gas turbines (turbojets, turbofans, turboprops), ramjets, and scramjets. Performance of specific engine components such as inlets, combustors, nozzles, as well as axial compressors and turbines will be addressed.

Recommended preparation: Fluid Mechanics (3004), Subsonic Aerodynamics (3711), Compressible Flow (3410) or equivalent.

This course will be offered in 2006-07 and in alternating years thereafter.

ME 4717. ROCKET AND SPACECRAFT PROPULSION.*Cat. II*

This course provides a study of propulsion systems for launch vehicles and spacecraft. Rocket propulsion systems discussed include solid, liquid-bipropellant and hybrid. Spacecraft propulsion and micropropulsion systems discussed include cold gas, solid, liquid and electric. Advanced propulsion and micropropulsion concepts are introduced. Additional topics may include combustor, nozzle, propellant storage and feed systems.

Recommended preparation: Fluid Dynamics (3004), Astronautics (2713), Intermediate Fluid Mechanics (3602), Compressible Flow (3401) or equivalent.

This course will be offered in 2007-08 and in alternating years thereafter.

ME 4718. ADVANCED MATERIALS WITH AEROSPACE APPLICATIONS*Cat. I*

This course covers topics on the design, fabrication and behavior of advanced materials used in structural and propulsion components of aerospace vehicles. The design, fabrication, and properties of polymer, metal and ceramic matrix composites used in aerospace structures are presented. The fabrication and behavior of aluminum and titanium alloys used in propulsion components as well as the processing and performance of Nickel-based superalloys are also presented. The fundamentals of coatings for high temperature oxidation, hot corrosion, and thermal protection are introduced.

Recommended background: Introduction to Materials Science (ES 2001), Stress Analysis (ES 2502) or equivalent.

ME 4724. HIGH SPEED FLOW.*Cat. II*

This course will introduce the students to the physical phenomena associated with flows at supersonic/hypersonic speeds. Emphasis will be placed on the hypersonic limit and various models developed to treat the continuum flow at this limit.

Topics covered include: characterization of hypersonic flow, normal shock relations, the piston analogy and shock tube equations, oblique shock waves and expansion fans at the hypersonic limit, similarity methods, the Newtonian model, Mach number independence of the inviscid equations, small disturbance theory for planar and axially symmetric bodies, lift and drag coefficients, dynamics of the viscous portion of the flow, and real gas effects.

Recommended background: thermodynamics (ES 3001), compressible flow (ME 3410), fluid dynamics (ES 3004, ME 3602), subsonic aerodynamics (ME 3711).

This course will be offered in 2007-08 and in alternating years thereafter.

ME 4770. AIRCRAFT DESIGN.*Cat. II*

This course introduces students to design of aircraft systems. Students complete a conceptual design of an aircraft in a term-long project. Students must establish design specifications, develop and analyze alternative designs, and justify their design in a written report. The design project incorporates fundamentals of aerodynamics, structures, aircraft performance, aircraft stability, and propulsion into a capstone design experience. The design project culminates in a Conceptual Design Review with oral presentations and a written final report. Design teams, software tools, and technical communication are emphasized.

Recommended background: intermediate fluid mechanics (ME 3602), subsonic aerodynamics (ME 3711), air breathing propulsion (ME 3716), aerospace structures (ME 4715).

This course will be offered in 2007-08 and in alternating years thereafter.

ME 4771. SPACECRAFT AND MISSION DESIGN.*Cat. II*

This course introduces students to design of spacecraft, spacecraft subsystem and space missions. Topics covered in lectures address mission classification and the space environment, the design of subsystems that include spacecraft power and propulsion, attitude dynamics and control, structural, thermal, and communication. Lectures are in parallel with a term-long conceptual design of a spacecraft, spacecraft subsystem or space mission. The design project culminates in a Conceptual Design Review with oral presentations and a written final report. Design teams, software tools, and technical communication are emphasized.

Recommended background: fluid mechanics (ES 3004), heat transfer (ES 3003), control engineering (ES 3011), astronautics (ME 2713), rocket and spacecraft propulsion (ME 3715), aerospace structures (ME 4715).

This course will be offered in 2006-07 and in alternating years thereafter.

ME 4810. AUTOMOTIVE MATERIALS AND PROCESS DESIGN*Cat. II*

This course focuses on materials used in the automotive industry. Students complete a term-long project that integrates design, materials selection and processing considerations. Activities include: problem definition, development of design specifications, development and analysis of alternative designs, conceptual designs and materials and process selection. Students will consider cost, and environmental impact of alternative material choices. Students will present their results in intermediate and final design reviews.

Recommended background: materials science (ES 2001), stress analysis (ES 2502), or equivalent.

This course will be offered in 2007-08 and in alternating years thereafter.

ME 4813. CERAMICS AND GLASSES FOR ENGINEERING APPLICATIONS.*Cat. II*

This course develops an understanding of the processing, structure, property, performance relationships in crystalline and vitreous ceramics. The topics covered include crystal structure, glassy structure, phase diagrams, microstructures, mechanical properties, optical properties, thermal properties, and materials selection for ceramic materials. In addition the methods for processing ceramics for a variety of products will be included.

Recommended Background: ES 2001 or equivalent.

This course will be offered in 2006-07 and in alternating years thereafter.

ME/BME 4814. BIOMATERIALS.*Cat. I*

A course specializing in material selection and special problems associated with biomedical engineering.

Topics covered include: fundamentals of metals, plastics, and ceramics and how they can be applied to biomedical applications. Case histories of successful and unsuccessful material selections. Current literature is the primary source of material.

Recommended background: materials (ES 2001).

ME 4821. PLASTICS.*Cat. II*

This course develops the processing, structure, property, performance relationships in plastic materials. The topics covered include polymerization processes, chain structure and configuration, molecular weights and distributions, amorphous and crystalline states and glass-rubber transition. The principles of various processing techniques including injection molding, extrusion, blow molding, thermoforming and calendaring will be discussed. The physical and mechanical properties of polymers and polymer melts will be described with specific attention to rheology and viscoelasticity. Pertinent issues related to environmental degradation and recyclability will be highlighted.

Recommended Background: ES2001 or equivalent.

This course will be offered in 2007-08 and in alternating years thereafter.

ME 4832. CORROSION AND CORROSION CONTROL.*Cat. II*

An introductory course designed to acquaint the student with the different forms of corrosion and the fundamentals of oxidation and electro-chemical corrosion.

Topics covered include: corrosion principles, environmental effects, metallurgical aspects, galvanic corrosion, crevice corrosion, pitting, intergranular corrosion, erosion corrosion, stress corrosion, cracking and hydrogen embrittlement, corrosion testing, corrosion prevention, oxidation and other high-temperature metal-gas reactions.

Recommended background: materials (ES 2001).

This course will be offered in 2006-07 and in alternating years thereafter.

ME 4840. PHYSICAL METALLURGY.*Cat. I*

Fundamental relationships between the structure and properties of engineering materials are studied. Principles of diffusion and phase transformation are applied to the strengthening of commercial alloy systems. Role of crystal lattice defects on material properties and fracture are presented.

Strongly recommended as a senior-graduate level course for students interested in pursuing a graduate program in materials or materials engineering at WPI, or other schools.

Recommended background: materials (ES 2001, ME 2820, ME 3811).

ME 4860. FOOD ENGINEERING.*Cat. II*

An introductory course on the structure, processing, and properties of food. Topics covered include: food structure and rheology, plant and animal tissues, texture, glass transition, gels, emulsions, micelles, food additives, food coloring, starches, baked goods, mechanical properties, elasticity, viscoelastic nature of food products, characteristics of food powders, fat eutectics, freezing and cooking of food, manufacturing processes, cereal processing, chocolate manufacture, microbial growth, fermentation, transport phenomena in food processing, kinetics, preserving and packaging of food, testing of food.

Recommended Background: ES2001 or equivalent.

This course will be offered in 2007-08 and in alternating years thereafter.

ME 4922. THEORY AND PRACTICE OF LASER INSTRUMENTATION.*Cat. II*

This course introduces and analyzes the fundamentals of optical and image processing techniques applicable to engineering measurements. Optical instrumentation is widely used in high precision position, vibration, and inspection applications in the industrial environment. The goal of this course is to provide a rigorous background in the basic principles preparing the student for the more advanced courses on laser instrumentation. The course will include both in-class lectures and laboratories. Topics to be covered include: accelerated review of light, waves, and polarization; basic building blocks including lenses, detectors, optical components, and fiber optics; interferometry and coherence; basic holography and speckle; infrared temperature measurement; stress birefringence; basic video, imaging, and digital image processing.

Recommended background: mathematics (MA 2051), experimentation (ME 3901).

Suggested background: physics (PH 1140).

This course will be offered in 2006-07 and in alternating years thereafter.

IS/P. SPECIAL TOPICS.*Cat. I*

For students who wish to pursue in depth various mechanical engineering topics.

Topics covered include: theoretical or experimental studies in subjects of interest to mechanical engineers.

Registration as a junior or senior is assumed.

MILITARY SCIENCE

The intent of the Military Science program of courses is that they be taken in sequential order. Any student who wishes to depart from this recommendation must consult with the Military Science department head.

ML 1011 and ML 1021 will appear on the WPI transcript as a zero credit course with a grade. Successful completion of ML 1011 and ML 1012 earns 1/9 unit in ML 1012. Successful completion of ML 1021 and ML 1022 earns 1/9 unit in ML 1022.

ML 1011. FOUNDATIONS OF OFFICERSHIP I.

Cat. I (0 units w/grade)

Introduction to issues and competencies that are central to a commissioned officer's responsibilities. Establishes a framework for understanding officership, leadership, and Army values. Additionally, the semester addresses "life skills" including fitness and time management.

Participation in leadership laboratories and participation in off-campus training sessions (field training exercise) is also required.

ML 1012. FOUNDATIONS OF OFFICERSHIP II.

Cat. I (1/9 unit after completion of 1011 and 1012)

This course continues the studies begun in ML 1011. Students make oral presentations on the elements of leadership, enhancing effective communication. Students begin to develop leadership potential by instilling self-confidence and fostering teamwork through basic survival techniques (e.g., water survival).

Participation in leadership laboratories and participation in off-campus training sessions (field training exercise) is also required.

ML 1021. BASIC LEADERSHIP I.

Cat. I (0 units w/grade)

ML 1021 expands upon the fundamentals introduced in the previous term by focusing on communications, leadership, and problem solving. "Life skills" lessons in this semester include: problem solving, goal setting, interpersonal communication skills, and assertiveness skills.

Participation in leadership laboratories and participation in off-campus training sessions (field training exercise) is also required.

ML 1022. BASIC LEADERSHIP II.

Cat. I (1/9 unit after completion of 1021 and 1022)

ML 1022 continues by providing cadets with interesting lessons yielding immediately useful skills. The course also gives accurate information about life in the Army, including the organization of the Army, employment benefits, and work experiences of junior officers.

ML 2011. INDIVIDUAL LEADERSHIP STUDIES I

Cat. I (1/12 unit)

Introduces students to team building techniques. Students build upon the basic leader principals and leadership development methodologies to refine their understanding of leadership. How to build teams, how to influence, how to communicate, how and when to make decision, and creative problem-solving.

Participation in leadership laboratories and participation in off-campus training session (field training exercise) is also required

Recommended background: ML1022

ML 2012. INDIVIDUAL LEADERSHIP STUDIES II.

Cat. I (1/12 unit)

The curriculum focuses on building character. Where years one, three and four focus on mastering definitions, concepts, ideas and principles, year two focuses on direct, physical experiences. Year two centers on giving cadets the opportunity to apply, practice and experience leadership principles. Cadets are asked to reflect upon their actions and those of others.

Participation in leadership laboratories and participation in off-campus training session (field training exercise) is also required.

Recommended background: ML 2011

ML 2021. LEADERSHIP AND TEAMWORK I.

Cat. I (1/12 unit)

Students continue the study of leader principals and are introduced to formal policies such as equal opportunity, ethics, and values. Military communication skills are trained along with the principles of camouflage. Complex cases of risk management are studied. Students will submit a written information paper.

Participation in leadership laboratories and participation in off-campus training session (field training exercise) is also required.

Recommended background: ML2012

ML 2022. LEADERSHIP AND TEAMWORK II.

Cat. I (1/12 unit)

This course covers small unit movement and military tactics. It combines previous study in weapons, movement and communications to teach the combination of firepower and maneuver to the student. This course also teaches the student the elements of how the military trains its personnel. A written decision paper

and practical exercise in conducting training is included in this course.

Participation in leadership laboratories and participation in off-campus training session (field training exercise) is also required.

Recommended background: ML 2021

ML 2091. LEADERSHIP TRAINING COURSE.

Cat. I (1/6 unit)

LTC puts each cadet through 24 days of pushing themselves to the mental and physical limits, while enhancing leadership, problem solving and teamwork skills. Cadets are put through extensive leadership training, which includes leadership reaction scenarios; Land Navigation exercises, first aid training. Cadets must pass the Army Fitness Test (APFT) in order to graduate.

ML 3011. LEADERSHIP AND PROBLEM SOLVING I.

Cat. I (1/6 unit)

This course focuses on development of individual leadership abilities. This course reviews leadership styles, management strategies and training techniques for leaders of small units. Promoting and developing communication skills and teamwork are addressed. Examines leadership of small units conducting conventional combat operations and tactical employment of weapon systems. Development of oral communication skills through military briefings and issuance of operations orders. Special attention is placed on evaluations through practical exercises

Participation in leadership labs and participation in an off-campus training session (field training exercise) is also required.

Recommended background: Students must have completed the basic course or ROTC Leadership Training course and have signed a personal contract with the US Army. Department Head approval is required.

ML 3012. LEADERSHIP AND PROBLEM SOLVING II.

Cat. I (1/6 unit)

Student learns how to conduct crisis planning and management. Discussion of roles and functions of combat arms, combat support, and combat service support branches. Case studies of small-unit operations are studied. Introduction to Army special operations, military operations other than war, and trends in the military. Students write self-evaluations throughout this course. Students are graded on their performance during leadership practical exercises.

Attendance at monthly labs and formal social functions is required. Students write self-evaluations through this course. Students are graded on their performance during leadership practical exercises.

Recommended background: ML 3011

ML 3021. LEADERSHIP AND ETHICS I.

Cat. I (1/6 unit)

ML 3021 is designed to continue the development as leaders by presenting instruction in the three foundational areas of leadership, interpersonal communication, and values and ethics. The leadership module contains an examination of Army leadership doctrine followed by expansion on key leadership concepts and provide feedback for cadet leadership self-development efforts.

ML 3022. LEADERSHIP AND ETHICS II.

Cat. I (1/6 unit)

The main thrust of the communication module is the opportunity for cadets to present an information briefing and receive feedback from both instructor and fellow students. The last module of the term contains lessons that focus on values, ethics, ethical decision-making, consideration of others, and spiritual needs.

Attendance at monthly labs, attendance at formal social functions and an off-campus weekend leadership exercise is required.

Recommended background: ML 3021

ML 3023. LEADERSHIP DEVELOPMENT AND ASSESSMENT COURSE.

Cat. I (1/6 unit)

LDAC puts each cadet through 32 days of intensive individual, squad and platoon-level training to assess his/her leadership potential. Each cadet is measured against 23 leadership dimensions in such subjects as physical stamina, technical competence, delegation, decisiveness, problem analysis and the several Army values, among others. Instruction and evaluation at LDAC is progressive, building skills in individual subjects like the Army Physical Fitness Test, basic military skills and land navigation, followed by such skill-building exercises as Individual Tactical Training.

ML 4011. LEADERSHIP AND MANAGEMENT I.

Cat. I (1/6 unit)

ML 4011 begins with a series of lessons designed to enable the cadets to make informed career decisions as they prepare their accessions documents. Lessons concentrate on Army operations and training management, communications and leadership skills and support the beginning of the final transition from cadet to lieutenant. The course focuses cadets, early in the year, on attaining knowledge and proficiency in several critical areas they will need to operate effectively as Army officers. These areas include: the Army's training management system, coordinating activities with staffs, and counseling skills. While the proficiency attained in each of these areas will initially be at the apprentice level,

cadets will continue to sharpen these skills as they perform their roles as cadet officers in the ROTC battalion and as new lieutenants after commissioning. At the end of this semester cadets should possess the fundamental skills, attributes, and abilities to operate as competent leaders in the cadet battalion and confidently shoulder the responsibilities entrusted to them.

ML 4022. LEADERSHIP AND MANAGEMENT II.

Cat. I (1/6 unit)

This Course focuses on completing the transition from cadet to lieutenant. As an expansion of the Ethics instruction in ML 3021, the course starts with an examination of unit ethical climate and the commander's role as the moral anchor of the unit. This is followed by a module addressing military law and leadership. The next module reinforces previous instruction on the organization of the Army and introduces how the Army organizes for operations from the tactical to strategic level. This is followed by instruction on administrative and logistical management that focuses on the fundamentals of soldier and unit level support. Next is a short module that focuses on preparing cadets for their forthcoming commissioning and military service. At the core of this semester is the Advanced Course's Capstone Exercise. This twelve-lesson exercise directly reinforces all modules from this term, and also incorporates and reinforces many learning objectives from modules throughout the entire curriculum. The Capstone Exercise requires cadets, both individually and collectively, to apply their knowledge to solve problems and confront situations commonly faced by junior officers. Upon completion of this course the cadets will be prepared to shoulder the responsibility of being a commissioned officer in the United States Army.

Three lab exercises and participation in the military staff ride is required.

ML 4023. OFFICERSHIP.

Cat. I (1/6 unit)

This course is a continuation of ML 4022.

ML 4024. TRANSITION TO LIEUTENANT.

Cat. I (1/6 unit)

Cadets organize and lead all the junior cadets. This course covers the military legal system, personnel actions and personal finances. It certifies fundamental competencies in land navigation, tactics, counseling, and interpersonal communications.

This course requires three hours of class work and three hours of physical fitness per week. Three lab exercises and a formal military ball are required.

Recommended background: ML4023

PHYSICAL EDUCATION

PE 1001. INTRO TO GOLF & TENNIS.

Cat. I (1/12 unit)

Introduction to the sports through skill development and play.

PE 1002. INTRO TO VOLLEYBALL & SQUASH.

Cat. I (1/12 unit)

Introduction to the sports through skill development and play.

PE 1003. INTRO TO BOWLING & BADMINTON.

Cat. I (1/12 unit)

Introduction to the sports through skill development and play.

PE 1004. INTRO TO TABLE TENNIS, GOLF, & TENNIS.

Cat. I (1/12 unit)

Introduction to the sports through skill development and play.

PE 1005. INTRO TO RECREATIONAL SPORTS.

Cat. I (1/12 unit)

This summer course introduces students to various sports through skill development and play. Possible sports taught include badminton, bowling, golf, racquetball, squash, swimming, table tennis, tennis, and volleyball.

PE 1006. WELLNESS.

Cat. I (1/12 unit)

Introductory course designed to acquaint students with knowledge and skills necessary to make choices that foster health and well-being.

PE 1007. BASIC WATER SAFETY.

Cat. I (1/12 unit)

For the beginner and intermediate swimmer. Students will learn about water recreational activities and how to remain safe while participating in them. Opportunity to learn the necessary means for safety in/near water and basic rescue techniques. Fee required.

PE 1011. TOUCH FOOTBALL.

Cat. I (1/12 unit)

Introduction to basic rules and individual/team skill development with practical application through game competition.

PE 1012. BASKETBALL.

Cat. I (1/12 unit)

Introduction to basic rules and individual/team skill development with practical application through game competition.

PE 1013. SOFTBALL.

Cat. I (1/12 unit)

Introduction to basic rules and individual/team skill development with practical application through game competition.

PE 1014. BEGINNING TENNIS.

Cat. I (1/12 unit)

Instruction will focus on basic strokes and techniques. Rules, strategy and play will be integrated as students' skills develop.

PE 1015. BADMINTON & TABLE TENNIS.

Cat. I (1/12 unit)

Instruction will focus on basic strokes and techniques. Rules, strategy and play will be integrated as students' skills develop.

PE 1016. SQUASH & RACQUETBALL.

Cat. I (1/12 unit)

Instruction will focus on basic strokes and techniques. Rules, strategy and play will be integrated as students' skills develop.

PE 1017. BEGINNING SWIMMING.

Cat. I (1/12 unit)

For the non-swimmer to intermediate swimmer. Instruction in the basic stroke techniques to learn to swim, improve skills and develop survival skills.

PE 1018. CO-ED VOLLEYBALL.

Cat. I (1/12 unit)

Introduction to basic rules and individual/team skill development with practical application through game competition.

PE 1021. BOWLING.

Cat. I (1/12 unit)

Introductory course designed to acquaint students with the basic skills, knowledge and practical experience.

PE 1024. INTERMEDIATE TENNIS.

Cat. I (1/12 unit)

Designed for the student with basic skills in tennis. In-depth instruction in skill development and strategy with game competition.

PE 1055. PHYSICAL CONDITIONING.

Cat. I (1/12 unit)

This course will teach basic strength training principles and techniques. Students will develop and implement an individualized conditioning program.

PE 1056. LIFEGUARDING I.

Cat. I (1/12 unit)

PE 1057. LIFEGUARDING II.

Cat. I (1/12 unit)

This class is based on the Red Cross Manual for Lifeguarding. Red Cross fee and books are required. The Lifeguard I course is the first part of a two course requirement (Lifeguarding I and II) for a student to be certified in CPR for the Professional Rescuer, First Aid, AED, Oxygen Administration and Lifeguarding. Recommended background: PE 1007

PE 1059. WEIGHT TRAINING PROGRAM FOR WOMEN.

Cat. I (1/12 unit)

This introductory course is designed to acquaint women with circuit training and free weight programs.

PE 1070. LEISURE EDUCATION: REDEFINING SOCIAL NORMS.

Cat. I (1/12 unit)

Introductory course designed to explore various leisure education alternatives.

PE 1077. SWIMMING FOR FITNESS.

Cat. I (1/12 unit)

For the intermediate to advanced swimmer. This class is geared toward swimming for fitness purposes. Workouts will be administered each class period with students developing the knowledge to create workouts for themselves.

PE 1100. SERIES.

Cat. I (1/12 unit)

Credit for activity in one of five categories: 1) WPI athletic team participation, 2) club sports, 3) approved courses not offered at WPI, 4) individualized program at WPI, 5) Proficiency testing. Approval in advance by the Physical Education Department is necessary.

PHYSICS

The second digit in physics course numbers is coded as follows.

- 1 — General physics
- 2 — Theoretical mechanics, statistical physics, kinetic theory, etc.
- 3 — Electricity and magnetism, electromagnetic theory
- 4 — Quantum mechanics
- 5 — Particular topics
- 6 — Laboratory

INTRODUCTORY PHYSICS SEQUENCE

There are four course topics in the introductory physics sequence. The four topics are Classical Mechanics (PH 1110/PH 1111), Electricity and Magnetism (PH 1120/PH 1121), 20th Century Physics (PH 1130), and Oscillations and Waves (PH 1140). Each course includes a laboratory component.

Students should take either PH 1110 or PH 1111, but not both; similarly, either PH 1120 or PH 1121, but not both. The primary difference between the PH 1110-PH 1120 option and PH 1111-PH 1121 is that the material in PH 1111-PH 1121 is treated somewhat more formally and rigorously than in PH 1110-PH 1120, thus presuming a better-than-average mathematics background. The recommended mathematics background for each course is indicated in the respective course description and should be considered carefully in each case.

Because the topics covered in the two mechanics and in the two electricity and magnetism courses are the same, it is possible to cross over from one sequence to the other. For example, PH 1120 could be taken after PH 1111, or, upon consulting with the course instructor, PH 1121 could be taken after successful completion of PH 1110. Finally, it should be noted that any combination of the first two introductory courses provides adequate preparation for both of the remaining courses in 20th Century Physics (PH 1130), and Oscillations and Waves (PH 1140).

The courses in classical mechanics and electricity and magnetism are regarded as essential preparation for many fundamental engineering courses as well as for further work in physics. PH 1130 gives a first introduction to 20th century physics and is designed to provide a context for the appreciation of present-day advances in physics and high-technology applications. PH 1140 deals in depth with oscillating systems, a topic area of fundamental importance in physics, and whose engineering applications span the range from electromagnetic oscillations to the mechanical vibrations of machinery and structures.

PH 1110. GENERAL PHYSICS—MECHANICS.

Cat. I

Introductory course in Newtonian mechanics.

Topics include: kinematics of motion, vectors, Newton's laws, friction, work-energy, impulse-momentum, for both translational and rotational motion.

Recommended background: concurrent study of MA 1021.

Students many not receive credit for both PH 1110 and PH 1111.

PH 1111. PRINCIPLES OF PHYSICS—MECHANICS.

Cat. I

An introductory course in Newtonian mechanics that stresses invariance principles and the associated conservation laws.

Topics include: kinematics of motion, vectors and their application to physical problems, dynamics of particles and rigid bodies, energy and momentum conservation, rotational motion.

Recommended background: concurrent study of MA 1023 (or higher).

Students with limited prior college-level calculus preparation are advised to take PH 1110.

Students many not receive credit for both PH 1111 and PH 1110.

PH 1120. GENERAL PHYSICS—ELECTRICITY AND MAGNETISM.

Cat. I

An introduction to the theory of electricity and magnetism.

Topics include: Coulomb's law, electric and magnetic fields, capacitance, electrical current and resistance, and electromagnetic induction.

Recommended background: working knowledge of the material presented in PH 1110 or PH 1111 and concurrent study of MA 1022.

Students many not receive credit for both PH 1120 and PH 1121.

PH 1121. PRINCIPLES OF PHYSICS—ELECTRICITY AND MAGNETISM.

Cat. I

An introduction to electricity and magnetism, at a somewhat higher mathematical level than PH 1120.

Topics include: Coulomb's Law, electric fields and potentials, capacitance, electric current and resistance, magnetism, and electromagnetic induction.

Recommended background: working knowledge of material covered in PH 1111 and concurrent study of MA 1024 (or higher). Students concurrently taking MA 1022 or MA 1023 are advised to take PH 1120.

Students many not receive credit for both PH 1121 and PH 1120.

PH 1130. INTRODUCTION TO 20TH CENTURY PHYSICS.

Cat. I

An introduction to the pivotal ideas and developments of twentieth-century physics.

Topics include: special relativity, photoelectric effect, X-rays, Compton scattering, blackbody radiation, DeBroglie waves, uncertainty principle, Bohr theory of the atom, atomic nuclei, radioactivity, and elementary particles.

Recommended background: familiarity with material covered in PH 1110 and PH 1120 (or PH 1111 and PH 1121) and completion of MA 1021 and MA 1022.

PH 1140. OSCILLATIONS, AND WAVES.

Cat. I

An introduction to oscillating systems and waves.

Topics include: free, clamped forced, and coupled oscillations of physical systems, traveling waves and wave packets, reflection, and interference phenomena.

Recommended background: working knowledge of the material covered in PH 1110 and PH 1120 (or PH 1111 and PH 1121) and completion of MA 1021, MA 1022 and MA 1023.

PH 2201. INTERMEDIATE MECHANICS I.

Cat. I

This course emphasizes a systematic approach to the mathematical formulation of mechanics problems and to the physical interpretation of the mathematical solutions.

Topics covered include: Newton's laws of motion, kinematics and dynamics of a single particle, vector analysis, motion of particles, rigid body rotation about an axis.

Recommended background: PH 1110, PH 1120, PH 1130, PH 1140, MA 1021, MA 1022, MA 1023, MA 1024 and concurrent registration in or completion of MA 2051.

PH 2202. INTERMEDIATE MECHANICS II.

Cat. I

This course is a continuation of the treatment of mechanics started in PH 2201.

Topics covered include: rigid-body dynamics, rotating coordinate systems, Newton's law of gravitation, central-force problem, driven harmonic oscillator, an introduction to generalized coordinates, and the Lagrangian and Hamiltonian formulation of mechanics.

PH 2301. ELECTROMAGNETIC FIELDS.

Cat. I

Introduction to the theory and application of electromagnetic fields, appropriate as a basis for further study in electromagnetism, optics, and solid-state physics.

Topics: electric field produced by charge distributions, electrostatic potential, electrostatic energy, magnetic force and field produced by currents and by magnetic dipoles, introduction to Maxwell's equations and electromagnetic waves.

Recommended background: introductory electricity and magnetism, vector algebra, integral theorems of vector calculus as covered in MA 2251.

PH 2501. PHOTONICS.

Cat. II

An introduction to the use of optics for transmission and processing of information. The emphasis is on understanding principles underlying practical photonic devices. Topics include lasers, light emitting diodes, optical fiber communications, fiber lasers and fiber amplifiers, planar optical waveguides, light modulators and photodetectors. Recommended background is PH 1110, PH 1120, PH 1130 and PH 1140 (or their equivalents).

This course will be offered in 2006-07 and in alternating years thereafter.

PH 2502. LASERS.

Cat. II

An introduction to the physical principles underlying lasers and their applications. Topics will include the coherent nature of laser light, optical cavities, beam optics, atomic radiation, conditions for laser oscillation, optical amplifiers (including fiber amplifiers), pulsed lasers (Q switching and mode locking), laser excitation (optical and electrical), and selected laser applications. Recommended background is PH 1110, PH 1120, PH 1130 and PH 1140 (or their equivalents).

This course will be offered in 2007-08 and in alternating years thereafter.

PH 2510. ATOMIC FORCE MICROSCOPY.

Cat. II

Atomic force microscopes (AFMs) are instruments that allow three-dimensional imaging of surfaces with nanometer resolution and are important enabling tools for nanoscience and technology. The student who successfully completes this course will understand the functional principles of AFMs, be able to run one, and interpret the data that are collected.

Recommended background: PH 1110 and 1120. Suggested background: PH 1130 and PH 1140.

This course will be offered in 2007-08 and in alternating years thereafter

PH 2601. PHOTONICS LABORATORY.*Cat. II*

This course provides an experimental approach to concepts covered in Photonics (PH 2501), Lasers (PH 2502), and Optics (PH 3504). Through a series of individually tailored experiments, students will reinforce their knowledge in one or more of these areas, while at the same time gaining exposure to modern photonics laboratory equipment. Experiments available include properties of optical fibers, optical fiber diagnostics, optical communications systems, properties of photodetectors, mode structure and threshold behavior of lasers, coherence properties of laser light, characterization of fiber amplifiers, diffraction of light, polarization of light, interferometry.

Recommended background: PH 1110/1111, PH 1120/1121, PH 1130, PH 1140, and one or more of the courses PH 2501, PH 2502, or PH 3504. No prior laboratory background is expected.

This course will be offered in 2006-07 and in alternating years thereafter.

PH 2651. INTERMEDIATE PHYSICS LABORATORY.*Cat. I*

This course offers experience in experimentation and observation for students of the sciences and others. In a series of subject units, students learn or review the physical principles underlying the phenomena to be observed and the basis for the measurement techniques employed. Principles and uses of laboratory instruments including the cathode-ray oscilloscope, meters for frequency, time, electrical and other quantities are stressed. In addition to systematic measurement procedures and data recording, strong emphasis is placed on processing of the data, preparation and interpretation of graphical presentations, and analysis of precision and accuracy, including determination and interpretation of best value, measures of error and uncertainty, linear best fit to data, and identification of systematic and random errors. Preparation of high-quality experiment reports is also emphasized. Representative experiment subjects are: mechanical motions and vibrations; free and driven electrical oscillations; electric fields and potential; magnetic materials and fields; electron beam dynamics; optics; diffraction-grating spectroscopy; radioactive decay and nuclear energy measurements.

Recommended background: the Introductory Physics course sequence or equivalent. No prior laboratory background beyond that experience is required.

Students who have received credit for PH 2600 or PH 3600 may not receive credit for PH 2651.

PH 3301. ELECTROMAGNETIC THEORY.*Cat. I*

A continuation of PH 2301, this course deals with more advanced subjects in electromagnetism, as well as study of basic subjects with a more advanced level of mathematical analysis. Fundamentals of electric and magnetic fields, dielectric and magnetic properties of matter, quasi-static time-dependent phenomena, and generation and propagation of electromagnetic waves are investigated from the point of view of the classical Maxwell's equations.

PH 3401. QUANTUM MECHANICS I.*Cat. I*

This course includes a study of the basic postulates of quantum mechanics, its mathematical language and applications to one-dimensional problems. The course is recommended for physics majors and other students whose future work will involve the application of quantum mechanics.

Topics include wave packets, the uncertainty principle, introduction to operator algebra, application of the Schrodinger equation to the simple harmonic oscillator, barrier penetration and potential wells.

Recommended background: Junior standing, MA 4451, and completion of the introductory physics sequence, including the introduction to the 20th century physics.

Suggested background: knowledge (or concurrent study) of linear algebra, Fourier series, and Fourier transforms.

PH 3402. QUANTUM MECHANICS II.*Cat. I*

This course represents a continuation of PH 3401 and includes a study of three-dimensional systems and the application of quantum mechanics in selected fields.

Topics include: the hydrogen atom, angular momentum, spin, perturbation theory and examples of the application of quantum mechanics in fields such as atomic and molecular physics, solid state physics, optics, and nuclear physics.

Recommended background: PH 3401.

PH 3501. RELATIVITY.*Cat. II*

This course is designed to help the student acquire an understanding of the formalism and concepts of relativity as well as its application to physical problems.

Topics include the Lorentz transformation, 4-vectors and tensors, covariance of the equations of physics, transformation of electromagnetic fields, particle kinematics and dynamics.

Recommended background: knowledge of mechanics and electrodynamics at the intermediate level.

This course will be offered in 2006-07 and in alternating years thereafter.

PH 3502. SOLID STATE PHYSICS.*Cat. II*

An introduction to solid state physics.

Topics include: crystallography, lattice vibrations, electron band structure, metals, semiconductors, dielectric and magnetic properties.

Recommended background: prior knowledge of quantum mechanics at an intermediate level.

Suggested background: knowledge of statistical physics is helpful.

This course will be offered in 2006-07 and in alternating years thereafter.

PH 3503. NUCLEAR PHYSICS.*Cat. II*

This course is intended to acquaint the student with the measurable properties of nuclei and the principles necessary to perform these measurements. The major part of the course will be an introduction to the theory of nuclei.

The principal topics will include binding energy, nuclear models and nuclear reactions. The deuteron will be discussed in detail and the nuclear shell model will be treated as well as the nuclear optical model.

Recommended background: some knowledge of the phenomena of modern physics at the level of an introductory physics course and knowledge of intermediate level quantum mechanics.

This course will be offered in 2007-08 and in alternating years thereafter.

PH 3504. OPTICS.*Cat. II*

This course provides an introduction to classical physical optics, in particular interference, diffraction and polarization, and to the elementary theory of lenses. The theory covered will be applied in the analysis of one or more modern optical instruments.

Recommended background: knowledge of introductory electricity and magnetism and of differential equations.

Suggested background: PH 2301.

This course will be offered in 2007-08 and in alternating years thereafter.

PH 4201. ADVANCED CLASSICAL MECHANICS.*Cat. I*

A review of the basic principles and introduction to advanced methods of mechanics, emphasizing the relationship between dynamical symmetries and conserved quantities, as well as classical mechanics as a background to quantum mechanics.

Topics include: Lagrangian mechanics and the variational principle, central force motion, theory of small oscillations, Hamiltonian mechanics, canonical transformations, Hamilton-Jacobi Theory, rigid body motion, and continuous systems.

Recommended background: PH 2201 and PH 2202.

This is a 14-week course.

PH 4206. STATISTICAL PHYSICS.*Cat. I*

An introduction to the basic principles of thermodynamics and statistical physics.

Topics covered include: basic ideas of probability theory, statistical description of systems of particles, thermodynamic laws, entropy, microcanonical and canonical ensembles, ideal and real gases, ensembles of weakly interacting spin 1/2 systems.

Recommended background: knowledge of quantum mechanics at the level of PH 3401-3402 and of thermodynamics at the level of ES 3001.

Graduate Physics Courses of Interest to Undergraduates

PH 511/PH 4201. CLASSICAL MECHANICS.

Lagrangian and Hamiltonian formulations. Central force motion. Rigid body dynamics. Theory of small oscillations. Poisson brackets, Hamilton-Jacobi theory. Continuous systems.

PH 514. QUANTUM MECHANICS I.

Schrodinger wave equation. Harmonic oscillator, hydrogen atom, potential wells, approximation methods.

PH 515. QUANTUM MECHANICS II.

Perturbation theory. Angular momentum. Spin. Scattering theory. Dirac equation.

PH 522. THERMODYNAMICS AND STATISTICAL MECHANICS.

Quantum concepts applied to thermodynamics. Bose-Einstein and Fermi-Dirac statistics.

PH 533. ADVANCED ELECTROMAGNETIC THEORY.

Classical electrodynamics and radiation theory.

SOCIAL SCIENCE AND POLICY STUDIES

ECON	Economics
GOV	Political Science, Government and Law
PSY	Psychology
SD	System Dynamics
SOC	Sociology
SS	General Social Science
STS	Society/Technology Studies

ECONOMICS (ECON)

ECON 1110. INTRODUCTORY MICROECONOMICS.

Cat. I

The course focuses upon the implications of reliance upon markets for the allocation of resources in a society, at the household, firm, and community level. Outcomes of current market systems are examined in terms of the efficient use of natural and other economic resources, as well as their impact upon the environment, fairness, and social welfare. Of special interest in these analyses is the role of prices in the determination of what commodities are produced, their means of production, and distribution among households. In cases where current market outcomes have features subject to widespread criticism, such as the presence of excessive pollution, risk, discrimination, and poverty, the analysis is extended to suggest economic solutions. There are no prerequisites for the course.

ECON 1120. INTRODUCTORY MACROECONOMICS.

Cat. I

This course is designed to acquaint students with the ways in which macroeconomic variables such as national income, employment and the general level of prices are determined in an economic system. It also includes a study of how the techniques of monetary policy and fiscal policy attempt to achieve stability in the general price level and growth in national income and employment. The problems of achieving these national goals (simultaneously) are also analyzed. The latter half of the course stresses economic issues in public policy and international trade.

ECON 1130. INTRODUCTION TO ECONOMETRIC MODELING.

Cat. II

The purpose of this course is to provide students with an introduction to econometric modeling as it is applied in economics and to illustrate how it can be used in harmony with, or as an alternative to, system dynamics modeling. The first quarter of the course is devoted to discussing the methodological similarities and differences between econometric and system dynamics modeling, acquainting students with both the primary (survey instruments and controlled experiments) and secondary (government agencies and NGOs) sources of economic and social science data, and reviewing the basics of descriptive and inferential statistics. The remaining three quarters of the course are devoted to an examination of the assumptions that underlie the ordinary least squares model, the problems that occur when these assumptions are violated, and the methods that are available for correcting these problems. Throughout this process, the use of socioeconomic data, and the roles of economic theory and econometric software in modeling are emphasized. The course concludes with a presentation of how the econometric modeling can be used to complement system dynamics modeling.

This course will be offered in 2007-08 and in alternating years thereafter.

ECON 2110. INTERMEDIATE MICROECONOMICS.

Cat. II

The topics addressed in this course are similar to those covered in ECON 1110 (Introductory Microeconomics) but the treatment proceeds in a more rigorous and theoretical fashion to provide a firm platform for students majoring in Economics or Management, or those having a strong interest in economics. Mathematics at a level comparable to that taught in MA 1021-MA 1024 is frequently applied to lend precision to the analysis. The course rigorously develops the microeconomic foundations of the theory of the firm, the theory of the consumer, the theory of markets, and the conditions required for efficiency in economic systems. Recommended background: ECON 1110.

This course will be offered in 2007-08 and in alternating years thereafter.

ECON 2117. ENVIRONMENTAL ECONOMICS.

Cat. II

This course investigates the effect of human activity upon the environment as well as the effect of the environment on human well-being. It pays special attention to the impact of production and consumption of material goods upon the quantity and quality of environmental goods. The analysis focuses on the challenges presented in mixed economies where markets are combined with

government intervention to manage pollution and scarcity. The course reviews efforts to measure the costs and benefits of improving environmental conditions and evaluates current and potential policies in terms of the costs of the environmental improvements they may yield. Attention is also paid to the special difficulties which arise when the impacts of pollution spill across traditional political boundaries. Recommended background: ECON 1110.

This course will be offered in 2006-07 and in alternating years thereafter.

ECON 2120. INTERMEDIATE MACROECONOMICS.

Cat. II

This course is an advanced treatment of macroeconomic theory well suited for students majoring in Economics or Management, or others with a strong interest in economics. The topics addressed in ECON 2120 are similar to those covered in ECON 1120, however the presentation of the material will proceed in a more rigorous and theoretical fashion.

Recommended background: ECON 1110.

This course will be offered in 2006-07 and in alternating years thereafter.

ECON 2125. DEVELOPMENT ECONOMICS.

Cat. II

This course is a general introduction to the field of development economics. The focus is on ways in which a developing country can increase its productive capacity, both agricultural and industrial, in order to achieve sustained economic growth. The course proceeds by first examining how economic growth and economic development are measured and how the various nations of the world compare according to well-known social and economic indicators. Theories of economic growth and theories of economic development are then examined, as are the various social and cultural structures that are thought to influence economic progress. The inputs to economic growth and development (land, labor, capital, entrepreneurial ability, education, technical change), and the possible distributions of income and levels of employment that result from their use, is considered next. Domestic economic problems and policies such as development planning, the choice of sectorial policies, the choice of monetary and fiscal policies, rapid population growth, and urbanization and urban economic development are then examined. The course concludes with a consideration of international problems and policies such as import substitution and export promotion, foreign debt, foreign investment, and the role of international firms. In conjunction with a traditional presentation of the above topics, the course curriculum will include the use of computer simulation models and games. These materials have been formulated with a simulation technique, system dynamics, that has its origins in control engineering and the theory of servomechanisms. As a result, students will find them complementary to their work in engineering and science. In addition, the various development theories and simulation and gaming results will be related, where possible, to specific developing nations where WPI has on-going project activities (e.g., Costa Rica and Thailand). This course is recommended for those students wishing to do an IQP or MQP in a developing nation.

Recommended background: ECON 1120.

This course will be offered in 2007-08 and in alternating years thereafter.

POLITICAL SCIENCE, GOVERNMENT AND LAW (GOV)

GOV 1301. U.S. GOVERNMENT.

Cat. I

This course is an introduction to the fundamental principles, institutions, and processes of the constitutional democracy of the United States. It examines the formal structure of the Federal system of government, including Congress, the presidency, the judiciary, and the various departments, agencies, and commissions which comprise the executive branch. Emphasis is placed on the relationships among Federal, state and local governments in the formulation and administration of domestic policies, and on the interactions among interest groups, elected officials and the public at large with administrators in the policy process. The various topics covered in the survey are linked by consideration of fiscal and budgetary issues, executive management, legislative oversight, administrative discretion, policy analysis and evaluation and democratic accountability. May be included in certain Humanities and Arts Sufficiency programs. See page 53.

GOV 1303. AMERICAN PUBLIC POLICY.

Cat. I

American Public Policy focuses on the outcomes or products of political institutions and political controversy. The course first addresses the dynamics of policy formations and stalemate, the identification of policy goals, success and failure in implementation, and techniques of policy analysis. Students are then encouraged to apply these concepts in the study of a specific policy area of their choosing, such as foreign, social, urban, energy or environmental policy. This course is an important first step for students wishing to complete IQPs in public policy research. Students are encouraged to complete GOV 1303 prior to enrolling in upper level policy courses such as GOV 2303, GOV 2304 or GOV 2311. There is no specific preparation for this course, but a basic understanding of American political institutions is assumed.

GOV 1310. LAW, COURTS, AND POLITICS.*Cat. II*

This course is an introduction to law and the role courts play in society. The course examines the structure of judicial systems, the nature of civil and criminal law, police practice in the enforcement of criminal law, and the responsibilities of judges, attorneys and prosecutors. Additional topics for discussion include the interpretation of precedent and statute in a common law system and how judicial discretion enables interest groups to use courts for social change. The student is expected to complete the course with an understanding of how courts exercise and thereby control the power of the state. As such, courts function as political actors in a complex system of governance. It is recommended that students complete this course before enrolling in GOV 2310, Constitutional Law.

This course will be offered in 2007-08 and in alternating years thereafter.

GOV 1320. TOPICS IN INTERNATIONAL POLITICS.*Cat. II*

GOV 1320 is a survey course designed to introduce students to the basic concepts of international relations: power and influence, nations and states, sovereignty and law. These concepts will be explored through the study of issues such as diplomacy and its uses, theories of collective security and conflict, and international order and development. The study of international organizations such as the UN, the European Union or the Organization of American States will also supplement the students' understanding of the basic concepts. The course may also include comparative political analysis of states or regions. It is designed to provide the basic background materials for students who wish to complete IQPs on topics that involve international relations or comparative political systems.

This course will be offered in 2006-07, and in alternating years thereafter.

GOV 2302. SCIENCE-TECHNOLOGY POLICY.*Cat. II*

This course is an examination of the relationship between science-technology and government. It reviews the history of public policy for science and technology, theories and opinions about the proper role of government and several current issues on the national political agenda. Examples of these issues include genetic engineering, the environment and engineering education. It also examines the formation of science policy, the politics of science and technology, the science bureaucracy, enduring controversies such as public participation in scientific debates, the most effective means for supporting research, and the regulation of technology. Throughout the course we will pay particular attention to the fundamental theme: the tension between government demands for accountability and the scientific community's commitment to autonomy and self-regulation.

Recommended background: GOV 1301 or GOV 1303.

This course will be offered in 2006-07 and in alternating years thereafter.

GOV 2304. GOVERNMENTAL DECISION MAKING AND ADMINISTRATIVE LAW.*Cat. II*

The course addresses the role of technical expertise in political decision making. Politicians and public administrators rely on the expert knowledge of scientists and engineers to "bring reason" to otherwise political decisions. The course specifically addresses decision making in the administrative context including the value of expert knowledge, circumstances of inadequate information and the need to accommodate the political agenda. The context for the discussion will be the problems of regulated industries (for example, energy or those industries subject to environmental regulation). Legal review of administrative decision making will also be addressed.

Recommended background: GOV 1301 or GOV 1303 or GOV 2310.

This course will be offered in 2007-08 and in alternating years thereafter.

GOV 2310. CONSTITUTIONAL LAW.*Cat. II*

Constitutional Law is a study of those Supreme Court decisions which interpret the foundation of American governance, the U.S. Constitution. These decisions address a wide variety of questions of historic and contemporary significance. For example: What are the limits on the powers of the President? How are the powers of the Congress restricted? How are legislative powers to be shared with the state and local governments? Other questions focus on the rights of individuals. What is the right to privacy and where is it found in law? Does the Constitution protect women who desire abortions, prevent discrimination against homosexuals, provide support for affirmative action programs? These and many other questions of great social and political importance are answered by the Supreme Court as it interprets the words of the founders. It is only through the decisions of the Court that we can come to have a complete understanding of the "living Constitution."

Recommended background: GOV 1310. (Formerly Dynamics and Limits of Law.)

This course will be offered in 2006-07 and in alternating years thereafter.

GOV 2311. ENVIRONMENTAL POLICY AND LAW.*Cat. I*

This course deals with environmental law as it relates to people, pollution and land use in our society. A case method approach will be used to illustrate how the courts and legislators have dealt with these social-legal problems. The course is designed to have the student consider: 1) the legal framework within which environmental law operates; 2) the governmental institutions involved in the formulation, interpretation and application of environmental law; 3) the nature of the legal procedures and substantive principles currently being invoked to resolve environmental problems; 4) the types of hazards to the environment presently subject to legal constraints; 5) the impact that the mandates of environmental law have had, and will have, on personal liberties and property rights; 6) the role individuals and groups can play within the context of our legal system to protect and improve man's terrestrial habitat and the earth's atmosphere; and 7) some methods and sources for legal research that they may use on their own.

Recommended background: GOV 1303 or GOV 1310.

GOV 2312. INTERNATIONAL ENVIRONMENTAL POLICY.*Cat. II*

Environmental issues present some of the major international problems and opportunities facing the world today. Worst-case scenarios envision irrevocable degradation of the earth's natural systems, but virtually every analysis sees the need for major change worldwide to cope with problems such as global warming, deforestation, ozone layer depletion, loss of biodiversity, and population growth, not to mention exponential increases in "conventional" pollutants in newly industrialized countries. The global environment issues represent a "second-generation" of environmental policy in which the focus of concern has moved from national regulations to international law and institutions. In addition, the environment has emerged as a major aspect of international trade, conditioning corporate investment and accounting for some \$200 billion in sales of pollution control equipment in 1991. Exploration of the genesis and implications of these phenomena is the essence of the course. Typically, the material begins with the nature of global environmental problems, drawing on literature from large-scale global modeling as well as particular analyses of the problems mentioned above. Approximately half the course focuses on international laws and institutions, including multilateral treaties (e.g., the Montreal Protocol limiting CFC use, ocean dumping, biodiversity), international institutions (UNEP, the Rio Convention, the OECD) and private initiatives (international standards organizations, ICOLP (Industry Committee for Ozone Layer Protection), etc.) In addition, US policy toward global environmental issues will be compared with that in Japan, Europe and developing countries, from which it differs significantly. Students will design and undertake term projects that address particular issues in detail in an interdisciplinary manner.

Recommended background: GOV 1303.

This course will be offered in 2007-08 and in alternating years thereafter.

GOV 2313. INTELLECTUAL PROPERTY LAW.*Cat. II*

Intellectual property includes ideas, and the works of inventors, authors, composers and other creative people. Patents, copyrights and trademarks establish legal rights in intellectual property. Alternatively, control over the use of an idea might be maintained by treating it as a trade secret. In these ways, the ideas of inventors and creators are protected and others are prohibited from appropriating the ideas and creative works of others. This course addresses the concept of intellectual property and the public policies that support the law of patent, copyright and trademark. Subjects include the process of obtaining patents, trademarks and copyrights; requirements of originality and, for patents, utility; infringement issues; and the problems posed by international trade and efforts to address them through the World Intellectual Property Organization.

Recommended background: GOV 1310 or GOV 2310.

This course will be offered in 2007-08 and in alternating years thereafter.

GOV /ID 2314. CYBERLAW AND POLICY.*Cat. II*

Rapidly developing technologies for computing, information management and communications have been quickly adopted in schools, businesses and homes. The growth of the Internet and of e-commerce, in particular, have given rise to an entirely new set of legal issues as the courts, Congress and international bodies struggle to keep pace with changing technology. This course addresses the government's role in the development of these technologies and the legal issues that result including questions regarding privacy rights, speech and defamation, and the application of patent and copyright law. Policy questions such as surveillance of e-mail, regulation of content, mandates on the use of filters, and the responsibilities and liability of internet service providers are also discussed. Additional policies studied include attempts to control Internet content and enforce international judgments (resulting from e-commerce or cyber-crime) by foreign states and/or international organizations. Students are expected to integrate knowledge of technology with law, politics, economics and international affairs.

This course will be offered in 2006-07, and in alternating years thereafter.

PSYCHOLOGY (PSY)

PSY 1400. INTRODUCTION TO PSYCHOLOGICAL SCIENCE.

Cat. I

Psychological science is the experimental study of human thought and behavior. Its goal is to contribute to human welfare by developing an understanding of why people do what they do. Experimental psychologists study the entire range of human experience, from infancy until death, from the most abnormal behavior to the most mundane, from the behavior of neurons to the actions of nations. This course offers a broad introduction to important theories, empirical findings, and applications of research in psychological science. Topics will include: use of the scientific method in psychology, evolutionary psychology, behavioral genetics, the anatomy and function of the brain and nervous system, learning, sensation and perception, memory, consciousness, language, intelligence and thinking, life-span development, social cognition and behavior, motivation and emotion, and the nature and treatment of psychological disorders.

PSY 1401. COGNITIVE PSYCHOLOGY.

Cat. I

This course is concerned with understanding and explaining the mental processes and strategies underlying human behavior. The ways in which sensory input is transformed, reduced, elaborated, stored, and recovered will be examined in order to develop a picture of the human mind as an active processor of information. Topics will include perception, memory, problem-solving, judgment and decision making, human-computer interaction, and artificial intelligence. Special attention will be paid to defining the limitations of the human cognitive system. Students will undertake a project which employs one of the experimental techniques of cognitive psychology to collect and analyze data on a topic of their own choosing.

Suggested background: PSY 1400.

PSY 1402. SOCIAL PSYCHOLOGY.

Cat. I

Social psychology is concerned with how people think about, feel for, and act toward other people. Social psychologists study how people interact by focusing on the individual (not society as a whole) as the unit of analysis, by emphasizing the effect on the individual of the situation or circumstances in which behavior occurs, and by acquiring knowledge through empirical scientific investigation. This course will examine the cause of human behavior in a variety of domains of social life. Topics will include, but not be limited to, person perception, attitude formation and change, interpersonal attraction, stereotyping and prejudice, and small group behavior. Special attention will be given to applied topics: How can the research methods of social psychology be used to help solve social problems? Students will work together in small groups to explore in depth topics in social psychology of their own choosing. May be included in certain Humanities and Arts Sufficiency programs. See page 53.

Suggested background: PSY 1400.

PSY 1403. THE PSYCHOLOGY OF WORK

Cat. I

This course enables the undergraduate student to develop a conceptual framework, using cognitive and social psychological principles for understanding technology and workplace environments. Topics covered are designed to demonstrate the relationship among the individual, group and organizational effectiveness, job satisfaction and quality of work life. Emphasis is placed on variables related to the employee (for example, engineer) in the workplace. Issues of leadership, communication, organizational culture, risk-taking, job satisfaction, stress, motivation and group dynamics are discussed in the context of technology, science and workplace environments. Students will have the opportunity to learn by practicing skills through experiential linked exercises such as group discussions, presentations, and role-playing.

Suggested background: PSY 1400.

PSY 2401. THE PSYCHOLOGY OF EDUCATION.

Cat. II

This course is concerned with the learning of persons in educational settings from pre-school through college. Material in the course will be organized into five units covering a wide range of topics: Unit 1: Understanding Student Characteristics - Cognitive, Personality, Social, and Moral Development; Unit 2: Understanding the Learning Process - Behavioral, Humanistic, and Cognitive Theories of Learning; Unit 3: Understanding Motivation to Learn; Unit 4: Understanding Student Diversity - Cultural, Economic, and Gender Effects upon Learning; Unit 5: Evaluating Student Learning - Standardized Tests, Intelligence, Grades, and other Assessment Issues. Students planning IQPs in educational settings will find this course particularly useful. Instructional methods will include: lecture, discussion, demonstration, and project work. Course will also focus on current issues in technological education and international higher education.

Recommended background: PSY 1400 or PSY 1401.

This course will be offered in 2007-08, and in alternating years thereafter.

PSY 2405. ENVIRONMENTAL PROBLEMS AND HUMAN COGNITION.

Cat. II

This course examines how people think about the environment. Any environmental problem, whether local, regional, or global, can ultimately be attributed to the environmental decisions and actions of human beings. These behaviors can in turn be understood as resulting from the nature and limitations of the human mind. Knowledge of the root psychological causes of environmentally harmful behavior is essential for designing effective solutions to environmental problems. The goals of the course are (1) to provide students with the basic psychological knowledge needed to understand and evaluate the behavioral aspects of such important environmental problems as air and water pollution, global warming, ozone depletion, preserving biological diversity, and hazardous waste and (2) to help students identify and improve shortcomings in their personal knowledge and daily life decisions related to the environment. Topics will include, but not be limited to: environmental problems as "tragedies of the commons"; public understanding of global warming and global climate modeling; folk biology; risk perception; intelligent criticism of environmental claims; making effective personal environmental choices; strategies for promoting pro-environmental behavior; systems thinking; use of computer simulation to learn about environmental issues; and human ability to model and manage the global environmental future.

Recommended background: PSY 1400, PSY 1401 or PSY 1402.

This course will be offered in 2007-08 and in alternate years thereafter.

PSY 2406. CROSS-CULTURAL PSYCHOLOGY: HUMAN BEHAVIOR IN GLOBAL PERSPECTIVE.

Cat. II

This course is an introduction to the study of the ways in which social and cultural forces shape human behavior. Cross-Cultural psychology takes a global perspective of human behavior that acknowledges both the uniqueness and interdependence of peoples of the world. Traditional topics of psychology (learning, cognition, personality development) as well as topics central to social psychology, such as intergroup relations and the impact of changing cultural settings, will be explored. Cultural influences on technology development and transfer, as they relate to and impact upon individual behavior, will also be investigated. Students preparing to work at international project centers, International Scholars, and students interested in the global aspects of science and technology will find the material presented in this course especially useful.

Recommended background: PSY 1400 or PSY 1402.

This course will be offered in 2006-07 and in alternating years thereafter.

SYSTEM DYNAMICS (SD)

SD 1504. STRATEGIES FOR IMPROVING COGNITIVE SKILLS.

Cat. I

Life experience provides us with little insight into the basic workings of our own minds. As a result, we tend to approach many of the important problems and decisions of our professional and personal lives with only a dim awareness of the limitations and capabilities of the human cognitive system and how its performance can be improved. The purpose of this course is (1) to provide students with the basic psychological knowledge needed to understand and evaluate such important cognitive skills as memory, problem solving, decision making, and reasoning and (2) to provide students the practical skills and experience necessary to improve and assess their cognitive performance. Topics will include but not be limited to memory improvement, study skills, effective problem solving techniques, creativity, numeracy, making effective choices, risky decision making, dynamic decision making, intelligent criticism of assumptions and arguments, and evaluating claims about the mind.

Suggested background: PSY 1400.

SD 1510. INTRODUCTION TO SYSTEM DYNAMICS MODELING.

Cat. I

The goal of this course is to provide students with an introduction to the field of system dynamics computer simulation modeling. The course begins with the history of system dynamics and the study of why policy makers can benefit from its use. Next, students systematically examine the various types of dynamic behavior that socioeconomic systems exhibit and learn to identify and model the underlying nonlinear stock-flow-feedback loop structures that cause them. The course concludes with an examination of a set of well-known system dynamics models that have been created to address a variety of socioeconomic problems. Emphasis is placed on how the system dynamics modeling process is used to test proposed policy changes and how the implementation of model-based results can improve the behavior of socioeconomic systems.

SD 1520. SYSTEM DYNAMICS MODELING.

Cat. I

The purpose of this course is to prepare students to produce original system dynamics computer simulation models of economic and social systems. Models of this type can be used to examine the possible impacts of policy changes and technological innovations on socioeconomic systems. The curriculum in this course is divided into three distinct parts. First, a detailed examination of the

steps of the system dynamics modeling process: problem identification (including data collection), feedback structure conceptualization, model formulation, model testing and analysis, model documentation and presentation, and policy implementation. Second, a survey of the "nuts and bolts" of continuous simulation modeling: information and material delays, time constants, the use of noise and numerical integration techniques, control theory heuristics, and software details (both simulation and model presentation and documentation software). Third, a step-by-step, in-class production of a model, involving the construction, testing, and assembly of subsectors. Students will be required to complete modeling assignments working in groups and take in-class quizzes on modeling issues.

Recommended background: SD1510, or permission of instructor.

SD 2530. ADVANCED TOPICS IN SYSTEM DYNAMICS MODELING.

Cat. II

This course will focus on advanced issues and topics in system dynamics computer simulation modeling. A variety of options for dealing with complexity through the development of models of large-scale systems and the partitioning complex problems will be discussed. Topics will include an extended discussion of model analysis, the use of summary statistics and sensitivity measures, the model validation process, and policy design. The application of system Dynamics to theory building and social policy are also reviewed. Complex nonlinear dynamics and the chaotic behavior of systems will be discussed. Students will be assigned group exercises centering on model analysis and policy design.

Recommended background: SD 1520.

This course will be offered in 2007-08 and in alternating years thereafter.

SD 3550. SYSTEM DYNAMICS SEMINAR.

Cat. II

This special topics course is designed primarily for system dynamics majors and students presently engaged in planning system dynamics projects. The course will be conducted as a research seminar, with many sessions being reserved for student presentations. Classical system dynamics models will be replicated and discussed. Students will read, evaluate, and report on research papers representing the latest developments in the field of system dynamics. They will also complete a term project that addresses a specific problem using the system dynamics method.

Recommended background: SD 1520 and SD 2530.

This course will be offered in 2007-08 and in alternating years thereafter.

SOCIOLOGY (SOC)

SOC 1202. INTRODUCTION TO SOCIOLOGY AND CULTURAL DIVERSITY.

Cat. I

The aim of this course is to provide a useful perspective on both the group level social phenomena studied by the field of sociology, and the anthropological study of culture. The major concepts that define social structures and major institutions will be covered as well. An important theme of the course is the interaction of technology and society; for example, the process of modernization as it has been experienced in Europe or America and in former colonies of England such as Nigeria. To examine cultural diversity in the context of other factors that shape the development of technology, the course will also address the international competition between nations with space agencies. The course culminates in a Live Role Playing Game in which the class simulates an international negotiation between space faring nations brokered by the UN, as it tries to take space technology in a different direction and involve more nations in its development. Students will be briefed in detail on the cultures, nations and agencies they are expected to represent in this activity, and will teach each other about their assigned nations through their actions as well as their worlds.

GENERAL SOCIAL SCIENCE (SS)

SS/ID 2050. SOCIAL SCIENCE RESEARCH FOR THE IQP.

Cat. I

This course is open to students accepted to off-campus IQP centers and programs. The course introduces students to research design, methods for social science research, and analysis. It also provides practice in specific research and field skills using the project topics students have selected in conjunction with sponsoring agencies. Students learn to develop social science hypotheses based upon literature reviews in their topic areas and apply concepts drawn from social psychology, anthropology, sociology, economics and other areas as appropriate. Students make presentations, write an organized project proposal, and develop a communication model for reporting their project findings.

SS 2400. METHODS, MODELING, AND ANALYSIS IN SOCIAL SCIENCE.

Cat. II

What is the process by which a hypothesis about human behavior gets supported or rejected? This course represents a review of the methodological tools of social and behavioral science. Topics to be covered include experimental design and ethical issues specific to behavioral research with human subjects, the use of statistical and simulation modeling in the interpretation of behavioral phenomena, and methods for statistical inference in compiling evidence for or against a hypothesis.

Recommended background: PSY 1400 and either PSY 1401 or PSY 1402.

This course will be offered in 2007-08 and in alternate years thereafter.

SOCIETY/TECHNOLOGY STUDIES (STS)

STS 1207. INTRODUCTION TO THE PSYCHO-SOCIOLOGY OF SCIENCE.

Cat. II

This course will describe how traditional issues addressed in the Sociology of Science dealing with science as an institution, social controversies involving science, priority disputes within science and process of scientific discovery are illuminated by studies using measures borrowed from psychology. Examples will involve measures of cognitive style, personality and openness to innovation. The scientific pipeline that runs through the science programs in the educational system and the experience of women as students and as practicing scientists will be addressed as a science and society equity issue. Problems balancing the roles of the scientist as expert and concerned citizen in a democratic but technological society will also be addressed. This course works equally well as a second course after PSY 1402, Social Psychology, or a first course in Social Science. It is recommended background for STS 2209, Conflict and Cooperation in Research and Development Settings.

This course will be offered in 2006-07 and in alternating years thereafter.

STS 2208. THE SOCIETY - TECHNOLOGY DEBATE.

Cat. II

A course which considers what one means when they say that we live in a technological society, focusing on the characteristics of technology that humanistic critics find problematic or objectionable. In the course of the analysis, the nature of technology, its connection to scientific advance, as well as its relationship to the state, and the social role of scientists and technologists will be considered. Special attention is given to the behavior of experts in scientific and technological controversies, and to the debate about the "technological mentality" said to pervade western societies. Utopian, Dystopian and Marxist interpretations of where technological development is taking us will be examined in an effort to understand the major themes in the larger debate about the social impact of technology. Computer science majors can take this course in place of CS 3043 if they write a term paper on a computer-related topic.

Recommended background: SOC 1202.

This course will be offered in 2007-08 and in alternating years thereafter. May be included in certain Humanities and Arts Sufficiency programs. See page 53.

STS 2209. CONFLICT AND COOPERATION IN RESEARCH AND DEVELOPMENT SETTINGS.

Cat. II

This course operates on two levels. It is a study of great innovations teams and R and D organizations in the field of aerospace, and great entrepreneurs who created their own companies around their inventions. China Lake, the Navy lab that invented the Sidewinder heat seeking air to air missile, Lockheed's "Skunkworks" which produced the U2 spy plane and Stealth technology, and Korolev, the great Russian "chief designer" who shaped the Soviet missile and space program are featured. Edwin Land was the inventor-entrepreneur who created Polaroid Corporation and worked for the US government on projects such as camera optics for spy planes and satellites. Aspects of the technological context in which Carnegie, Edison and Bell emerged to prominence and the nature of their contributions will be discussed. On another level, the class is an R and D unit composed of teams in a startup company with two different product lines, trying to get its first contract from an established aerospace conglomerate. The client company, its mission and CEO are described in Michael Flynn's novel, Firestar. The home company has a new information project, ISIS, the Integrated Staff/Student Information System, which it claims can improve the effectiveness of innovation and production teams through the use of psychological instruments. Your unit is to research the great R and D units of the past, show how the client's organization can be reconfigured to approximate them, and assess the case that teams unusually likely to function well in their assigned roles can actually be formed using the ISIS cognitive styles database.

This course will be offered 2006-07, and in alternating years thereafter.

Graduate System Dynamics Courses of Interest to Undergraduates

SD 550. SYSTEM DYNAMICS FOUNDATION: MANAGING COMPLEXITY.

Why do some businesses grow while others stagnate or decline? What causes oscillation and amplification - the so called "bullwhip" — in supply chains? Why do large scale projects so commonly over overrun their budgets and schedules? This course explores the counter-intuitive dynamics of complex organizations and how managers can make the difference between success and failure. Students learn how even small changes in organizational structure can produce dramatic changes in organizational behavior. Real cases and computer simulation modeling combine for an in-depth examination of the feedback concept in complex systems. Topics include: Supply chain dynamics, project dynamics, commodity cycles, new product diffusion, and business growth and decline. The emphasis throughout is on the unifying concepts of system dynamics. Pre-requisites: None

SD 551. MODELING AND EXPERIMENTAL ANALYSIS OF COMPLEX PROBLEMS.

This course deals with the hands on detail related to analysis of complex problems and design of policy for change through building models and experimenting with them. Topics covered include: slicing complex problems and constructing reference modes; going from a dynamic hypothesis to a formal model and organization of complex models; specification of parameters and graphical functions; experimentations for model understanding, confidence building, policy design and policy implementation. Modeling examples will draw largely from public policy agendas. Pre-requisites: SD 550

SD 552. SYSTEM DYNAMICS FOR INSIGHT.

The objective of this course is to help students appreciate and master system dynamics' unique way of using of computer simulation models. The course provides tools and approaches for building and learning from models. The course covers the use of molecules of system dynamics structure to increase model building speed and reliability. In addition, the course covers recently developed eigenvalue-based techniques for analyzing models as well as more traditional approaches. Pre-requisites: SD 550 and SD 551

SD 553. MODEL ANALYSIS AND EVALUATION TECHNIQUES.

This course focuses on analysis of models rather than conceptualization and model development. It provides techniques for exercising models, improving their quality and gaining added insights into what models have to say about a problem. Five major topics are covered: Use of subscripts, achieving and testing for robustness, use of numerical data, sensitivity analysis, and optimization/calibration of models. The Subscripts discussion provides techniques for dealing with detail complexity by changing model equations but not adding additional feedback structure. Robust models are achieved by using good individual equation formulations and making sure that they work together well though automated behavioral experiments. Data, especially time series data, are fundamental to finding and fixing shortcomings in model formulations. Sensitivity simulations expose the full range of behavior that a model can exhibit. Finally, the biggest section, dealing with optimization and calibration of models develops techniques for both testing models against data and developing policies to achieve specified goals. Though a number of statistical issues are touched upon during the course, only a basic knowledge of statistics and statistical hypothesis testing is required. Pre-requisites: SD 550 and SD 551, or permission of the instructor

SD 554. REAL WORLD SYSTEM DYNAMICS.

In this course students tackle real-world issues working with real managers on their most pressing concerns. Many students choose to work on issues in their own organizations. Other students have select from a number of proposals put forward by managers from a variety of companies seeking a system dynamics approach to important issues. Students experience the joys (and frustrations) of helping people figure out how to better manage their organizations via system dynamics. Accordingly the course covers two important areas: Consulting (i.e. helping managers) and the system dynamics standard method - a sequence of steps leading from a fuzzy "issue area" through increasing clarity and ultimately to solution recommendations. The course provides clear project pacing and lots of support from the instructors and fellow students. It is recommend that students take this course toward the end of their system dynamics coursework as it provides a natural transition from course work to system dynamics practice. Pre-requisites: SD 550 and SD 551

SD 560. STRATEGY DYNAMICS.

This course provides a rigorous set of frameworks for designing a practical path to improve performance, both in business and non-commercial organisations. The method builds on existing strategy concepts, but moves substantially beyond them, by using the system dynamics method to understand and direct performance through time. Topics covered include: Strategy, performance and resources; Resources and accumulation; The 'Strategic Architecture'; Resource Development; Rivalry and the Dynamics of Competition; Strategy, Policy and Information Feedback; Resource Attributes; Intangible Resources; Strategy, Capabilities and Organization; Industry Dynamics and Scenarios. Case studies and models are assigned to students for analysis. Pre-requisites: SD 550 or permission of the instructor

SD 561. ENVIRONMENTAL DYNAMICS.

Environmental Dynamics introduces the system dynamics students to the application in environmental systems. The course materials include the book Modeling the Environment, a supporting website, lectures and the corresponding power point files. Students learn system dynamics with examples implemented with the Stella software. The course includes a variety of small models and case applications to water shed management, salmon restoration, and incentives for electric vehicles to reduce urban air pollution. The students conclude the course with a class project to improve one of the models from the book Modeling the Environment. The improvements may be implemented with either the Stella or the Vensim software. Pre-requisites: SD 550

SD 562. PROJECT DYNAMICS.

This course will introduce students to the fundamental dynamics that drive project performance, including the rework cycle, feedback effects, and inter-phase "knock-on" effects. Topics covered include dynamic project problems and their causes: the rework cycle and feedback effects, knock-on effects between project phases; Modeling the dynamics: feedback effects, schedule pressure and staffing, schedule changes, inter-phase dependencies and precedence; Strategic Project management: Project Planning, Project Preparation, Risk management, Project adaptation and execution Cross project learning; Multi-project issues. A simple project model will be created, and used in assignments to illustrate the principles of "strategic project management." Case examples of different applications will be discussed. Pre-requisites: SD 550

SD 565. MACROECONOMIC DYNAMICS.

There are three parts to this course. The first acquaints a student with dynamic macroeconomic data and the stylized facts seen in most macroeconomic systems. Characteristics of the data related to economic growth, economic cycles, and the interactions between economic growth and economic cycles that are seen as particularly important when viewed through the lens of system dynamics, will be emphasized. The second acquaints a student with the basics of macroeconomic growth and business cycle theory. This is accomplished by presenting well-known models of economic growth and instability, from both the orthodox and heterodox perspectives, via system dynamics. The third part attempts to enhance a student's ability to build and critique dynamic macroeconomic models by addressing such topics as the translation of difference and differential equation models into their equivalent system dynamics representation, fitting system dynamics models to macroeconomic data, and evaluating (formally and informally) a model's validity for the purpose of theory selection. Pre-requisites: SD 550

SS 590. SPECIAL TOPICS IN SYSTEM DYNAMICS.

(credit as specified)

Individual or group studies on any topic relating to social science and policy studies selected by the student and approved by the faculty member who supervises the work.

ACADEMIC POLICIES AND PROCEDURES

S E C T I O N

four

Academic Policies and Procedures	243
Grades	243
Grade Appeal and Grade Change Policy	245
Transfer Students	246
Transcript Fees	246
Degree Audits	246
Designation of Major Area of Study	247
Double Major	247
Designation of Class Year	247
Guidelines for the Determination of Satisfactory Academic Progress, Academic Warning, Academic Probation and Academic Suspension	247
Administrative Obligations	248
Directory Information and Release of Information	248
Registration	249
Project and Independent Study Registration .	249
Registration Policy for Degree Requirements .	250
Special Students	250
Project Registration Topic Codes	251
Coding of Project Advisors	252

GRADES

DISTRIBUTION OF GRADES

Academic grades may be released legally to the parents of dependent students. In accordance with affirming legal opinion, effective August 1, 1986, WPI assumes that all undergraduates have dependent status unless they inform the Projects and Registrar's Office in writing that they are independent. Petition forms are available in the Projects and Registrar's Office. Such a declaration may be filed by a student at any time. After receipt of such notice, the Registrar will not release grades to parents unless legal evidence of dependency is presented to the contrary.

(The listing of a student as a dependent on the parent's IRS 1040 Form is the accepted legal evidence of dependency under the Privacy Act or Buckley Amendment. Information on file with the Financial Aid Office will remain confidential within that office and will not be used in any manner relative to this issue).

GRADE SYSTEM SELECTION

The PLAN grading system applies only to admitted, degree-seeking undergraduate students. All other students such as Consortium (CO), nondegree-seeking Special Students (SX), and Graduate students will receive traditional A, B, C, D, F, Withdrawal and Pass/Fail grades.

The AD, AC grading system applies to all degree candidates who matriculated prior to May 1, 1986, and who have not exercised the one-time option to change to the A, B, C system.

PLAN (Current system)

Projects: The following term grades are possible: A, B, C, SP (Satisfactory Progress), NAC (Not Acceptable) and NR (No record).

Courses: The following grades are possible: A, B, C, NR, and I (Incomplete). An instructor may also assign an "I" in an Independent Study course. AT (attended) is used to denote participation in seminars or college-sponsored programs.

TRADITIONAL (System before mid-1970's)

Courses: The following grades are possible: A, B, C, D, F, Withdrawal, and I (Incomplete).

GRADES FOR COMPLETION OF DEGREE REQUIREMENTS

The overall evaluation of degree requirements (for the MQP, the IQP and the Sufficiency) will be graded in the student's respective grade system. The transcript will contain an abstract describing the content of the completed project.

NO RECORD (NR)

The NR (No Record) grade is assigned by a faculty member for course or project work for which credit has not been earned. This grade applies to PLAN students (admitted, degree-seeking) only. The NR grade does not appear on the students' transcripts or grade reports, nor is it used in the calculation of satisfactory academic progress.

INCOMPLETE (I)

An I grade, when assigned, will be changed to NR after one term unless extended in writing by the instructor to the Registrar's Office. The I grade is not assigned for Qualifying Projects or the Sufficiency.

SATISFACTORY PROGRESS (SP)

In project work (IQP, MQP only) extending beyond one term for which a grade is not yet assigned, an interim grade of SP (Satisfactory Progress) may be used on grade sheets. In such cases, the SP evaluation will count as units earned toward meeting the 15-unit rule, the distribution requirements, and the minimum standards for satisfactory academic progress. SP grades remain on the transcript until changed to the final grade as submitted on the Completion of Degree Requirement Form or through the grade change form procedure.

OTHER GRADES

A ? or Q signifies a grade that has not been submitted.

PROJECT GRADING

The Faculty of WPI have endorsed the following grading guidelines for project activity:

1. Each term a student is registered for a project, the student receives a grade reflecting judgment of accomplishments for that term.
2. Upon completion of the project, students will receive an overall project grade. It is important to note that this grade reflects not only the final products of the project (e.g., results, reports, etc.), but also the **process** by which they were attained. No amount of last-minute effort should turn a mediocre project effort into an A.
3. The available grades and their interpretations are as follows:
 - **A:** a grade denoting a consistently excellent effort, and attaining the stated project goals.
 - **B:** a grade denoting a consistently good effort, and attaining the stated project goals.
 - **C:** a grade denoting an acceptable effort, and partially attaining the stated project goals.
 - **SP:** a grade denoting an effort sufficient for the granting of the credit for which the student is registered. This grade provides students with no feedback, and its use is discouraged except for circumstances in which the faculty member is unable to judge the quality of the work (yet can still determine that the granting of credit is appropriate).
 - **NAC:** a grade denoting an effort unacceptable for the credit for which the student is registered. Note that this grade is entered into the student's transcript.
 - **NR:** a grade denoting an effort insufficient for the credit for which the student is registered. This grade is appropriate when the project has not proceeded due to circumstances beyond the control of the student, or for project extensions which do not represent the full amount of credit for which the student is registered.
4. The results of a project should be such that an outside reviewer would reasonably deem the project as being worthy of the credit and grade given, based on evidence such as the project report.
5. In light of the above grading criteria, it is strongly suggested that a formal project proposal or contract be developed early in the project activity, so that all participants in the activity have a clear understanding of the project goals, and advisor and student expectations.

CUMULATIVE POINT AVERAGE

WPI does not maintain a Cumulative Grade Point Average for undergraduate students. A student who needs a cumulative point average for external use may apply to the Registrar and receive a *numerical equivalent*. This information is usually provided only for students applying to graduate or professional schools when the application process requires a translation. Cumulative point averages will *not* be printed on student's transcripts nor shall class rankings be developed from them.

When requested by the student, the numerical equivalent of the cumulative point average will be based on a point assignment of A = 4.0, B = 3.0, C = 2.0 while DIST and AC grades will be 4.0 and 2.75 respectively.

TRANSFER CREDIT

Any course considered for transfer credit must be relevant to WPI's educational mission. Elective credit, either free elective and department elective credit, may be awarded for courses with no WPI equivalent. Vocational, correspondence, pre-college or review courses are not transferable. Also, noncredit CEU courses, adult enrichment or refresher courses, and CLEP examinations are not recognized for transfer credit.

The decision to award transfer credit is made by the WPI department offering the most comparable courses. Transfer credit evaluation is coordinated by the Office of Academic Advising and the Registrar's Office according to the following procedures. Students may petition the Committee on Academic Operations (CAO) for cases involving procedural irregularities.

TRANSFER STUDENTS

After a student has been accepted and final transcripts received, the Office of Admissions coordinates the formal evaluation of credit accepted toward a WPI degree. Courses taken at regionally accredited post-secondary institutions that are comparable to courses offered at WPI will be reviewed for course content and level by the WPI department offering the comparable course. Only those courses in which the transfer student received a grade of C or better will be evaluated for possible transfer credit.

TRANSFERRING CONSORTIUM COURSES

Courses taken through the consortium do not need to be transferred into WPI. Courses will automatically be part of the WPI transcript. However, if you are taking the course through the consortium to fulfill a WPI distribution requirement, you should check with the Registrar's Office to see if the course has been pre-approved to satisfy the requirement. If not, you will need approval from the relevant department head before taking the course.

To apply for approval of a consortium course to satisfy a specific WPI distribution requirement, a student must obtain a WPI Transfer Credit Authorization form from the Registrar's Office. This form and the course description must be taken to the WPI department head for approval before the course is taken. The WPI department head decides whether the proposed course meets the department distribution requirement. If it does, the department head specifies on the form a minimum grade for satisfying the distribution requirement. This minimum grade depends on the institution at which the course is taken and how

critical the course is the department. Courses that have not been pre-approved may receive WPI elective credit. The complete form must be filed in the Registrar's Office before taking the course.

TRANSFERRING IN CREDIT

If you are currently a WPI student who wishes to take courses at a regionally accredited post-secondary institution, you must obtain a WPI Transfer Credit Authorization form from the Registrar's Office. This form and the course description must be taken to the WPI department head and academic advisor for approval before the course is taken. On the form, the department head specifies a minimum grade for transfer. This minimum grade depends on the institution at which the course is taken and how critical the course is to the department. Courses that have not been pre-approved may not receive transfer credit.

The completed form must be filed in the Registrar's Office before taking the course. After successful completion of the course, an official transcript should be sent to WPI. Students can check the web for posting of credit.

GRADUATION WITH HONORS

For all degree candidate students graduating from WPI after May 1, 1986, graduation honors will be determined as follows:

Graduation With High Distinction

An *A* or *DIST* grade on any *four* of the following:

- MQP
- IQP
- Sufficiency
- Six units of work registered at WPI (exclusive of PE and of the MQP, IQP or the SUFF/Independent Study component of the Sufficiency)

Graduation With Distinction

An *A* or *DIST* grade on any *three* of the above.

COMMENCEMENT POLICY

The policy for allowing certain undergraduate students who have not completed all degree requirements to participate in Commencement exercises is:

1. Undergraduate students who have not met all degree requirements will be eligible to participate in Commencement exercises only if all of the following are true:
 - a. The student was registered for all remaining requirements for graduation in the D term immediately preceding Commencement Day.
 - b. At the end of D term, the student is within 1/3 unit of meeting all requirements for graduation.
 - c. The student has completed at least 2 of the 3 WPI Project Requirements (Sufficiency, IQP, and MQP).
 - d. The student has registered for any remaining course or project work no later than 10 days before Commencement Day.
2. Undergraduate students who meet these conditions will be permitted to participate in Commencement exercises but will not receive their diploma. The names of such students will not be included in the Commencement program. The actual degree will be conferred only after all degree requirements have been completed.
3. All WPI undergraduate students will be notified of these policies and procedures each B term.

4. Undergraduate students seeking an exception to this policy have the right to petition the Committee on Academic Operations for a waiver for extenuating circumstances. Petitions must be received no later than 10 days before Commencement Day.

CREDIT OVERLAP FOR DEGREE DESIGNATIONS AND REQUIREMENTS

If a student wishes to complete two Interdisciplinary (individually designed) Majors Programs, the double major must be proposed in a single Educational Program Proposal, which must be approved by the student's Program Advisory Committee for each major. The Committees shall ensure that the majors are substantially nonoverlapping.

If a student's double major includes an Interdisciplinary (individually designed) Major Program, the double majors must be described in the Educational Program Proposal for the Interdisciplinary Major.

HONORS FOR DOUBLE MAJORS

If a student completes two majors, the student is awarded a degree with "Distinction" or "High Distinction" if the student meets the criteria above in either or both majors; if both awards are received, the degree is awarded with "High Distinction."

GRADE APPEAL AND GRADE CHANGE POLICY

The purpose of the Grade Appeal Policy is to provide the student with a safeguard against receiving an unfair final grade, while respecting the academic responsibility of the instructor. Thus, this procedure recognizes that,

- Every student has a right to receive a grade assigned upon a fair and unprejudiced evaluation based on a method that is neither arbitrary nor capricious; and,
- Instructors have the right to assign a grade based on any method that is professionally acceptable, submitted in writing to all students, and applied equally.

Instructors have the responsibility to provide careful evaluation and timely assignment of appropriate grades. Course and project grading methods should be explained to students at the beginning of the term. WPI presumes that the judgment of the instructor of record is authoritative, and the final grades assigned are correct.

A grade appeal shall be confined to charges of unfair action toward an individual student and may not involve a challenge of an instructor's grading standard. A student has a right to expect thoughtful and clearly defined approaches to course and project grading, but it must be recognized that varied standards and individual approaches to grading are valid. The grade appeal considers whether a grade was determined in a fair and appropriate manner; it does not attempt to grade or re-grade individual assignments or projects. It is incumbent on the student to substantiate the claim that his or her final grade represents unfair treatment, compared to the standard applied to other students. Only the final grade in a course or project may be appealed. In the absence of compelling reasons, such as clerical error, prejudice, or capriciousness, the grade assigned by the instructor of record is to be considered final.

In a grade appeal, *only arbitrariness, prejudice, and/or error* will be considered as legitimate grounds for an appeal.

Arbitrariness: The grade awarded represents such a substantial departure from accepted academic norms as to demonstrate that the instructor did not actually exercise professional judgment.

Prejudice: The grade awarded was motivated by ill will, and is not indicative of the student's academic performance.

Error: The instructor made a mistake in fact.

This grade appeal procedure applies only when a student initiates a grade appeal and not when the instructor decides to change a grade on his or her own initiative. This procedure does not cover instances where students have been assigned grades based on academic dishonesty or academic misconduct, which are included in WPI's Academic Honesty Policy. Also excluded from this procedure are grade appeals alleging discrimination, harassment or retaliation in violation of WPI's Sexual Harassment Policy, which shall be referred to the appropriate office at WPI as required by law and by WPI policy.

The Grade Appeal Procedure strives to resolve a disagreement between student and instructor concerning the assignment of a grade in a collegial manner. The intent is to provide a mechanism for the informal discussion of differences of opinion, and for the formal adjudication by faculty only when necessary. In all instances, students who believe that an appropriate grade has not been assigned must first seek to resolve the matter informally with the instructor of record. If the matter cannot be resolved informally, the student must present his or her case in a timely fashion in the procedure outlined below. Under normal circumstances, the grade appeal process must be started near the beginning of the next regular academic term after the disputed grade is received.

STUDENT GRADE APPEAL PROCEDURE

1. A student who wishes to question a grade must discuss the matter first with the instructor of record as soon as possible, preferably no later than one week after the start of the next regular academic term after receiving the grade. In most cases, the discussion between the student and the instructor should suffice and the matter will not need to be carried further. The student should be aware that the only valid basis for grade appeal beyond Step One is to establish that an instructor assigned a grade that was arbitrary, prejudiced, or in error.
2. If the student's concerns remain unresolved after the discussion with the instructor, the student may submit a written request to meet with the appropriate Department Head, within one week of speaking with the instructor. For a grade in a course, independent study, Sufficiency Project, or Major Qualifying Project (MQP), the appropriate person is the instructor's Department Head. For a grade in an Interactive Qualifying Project (IQP), the appropriate person is the Dean of the Interdisciplinary and Global Studies Division (IGSD). If the instructor of record is a Department Head or the Dean of the IGSD, then the student should request to meet with the Associate Provost, who will serve as the appropriate Department Head in this step. The appropriate Department Head will meet within one week with the

student, and, if he or she believes that the complaint may have merit, with the instructor. After consultation with the Department Head, the instructor may choose to let the grade remain, to change a course grade, or to petition the Committee on Academic Operations to change a grade for a Degree Requirement (MQP, IQP, or Sufficiency). The Department Head will communicate the result of these discussions to the student.

3. If the matter remains unresolved after Step Two, the student should submit a written request within one week to the Provost's Office to request an *ad hoc* Faculty Committee for Appeal of a Grade. The Associate Provost will meet with the student, and will ask the Faculty Review Committee to appoint the *ad hoc* Committee for Appeal of a Grade. The FRC, in consultation with the Associate Provost, will select the members of the *ad hoc* committee. The Chair of the FRC will convene the *ad hoc* committee and serve as its non-voting chair. The *ad hoc* committee for appeal of a grade in a course, independent study, Sufficiency Project, or MQP will be composed of three faculty members chosen in the instructor's department or in closely allied fields. The *ad hoc* committee for appeal of a grade in an IQP will be composed of the instructor of record's Department Head and two faculty members who are experienced advisors of IQPs chosen from any department. Appointees to the *ad hoc* committee must not have any apparent conflicts of interest with the instructor of record (which might include but are not limited to frequent co-advising or research collaboration). The committee would examine available written information on the dispute, would be available for meetings with the student and with the instructor, and would meet with others as it sees fit.
4. Through its inquiries and deliberations, the *ad hoc* committee is charged to determine whether the grade was assigned in a fair and appropriate manner, or whether clear and convincing evidence of unfair treatment such as arbitrariness, prejudice, and/or error might justify changing the grade. The *ad hoc* committee will make its decisions based on a majority vote. If the committee concludes that the grade was assigned in a fair and appropriate manner, the *ad hoc* committee will report its conclusion in writing to the student and instructor and the matter will be considered closed. If the *ad hoc* faculty committee determines that compelling reasons exist for changing the grade, it would request that the instructor make the change, providing the instructor with a written explanation of its reasons. Should the instructor decline, he or she must provide a written explanation for refusing.
5. The *ad hoc* faculty committee, after considering the instructor's explanation and upon again concluding that it would be unjust to allow the original grade to stand, will then determine what grade is to be assigned. The new grade may be higher than, the same as, or lower than the original grade. Having made this determination, the three members of the committee will sign the grade change form and transmit it to the Registrar.

The instructor and student will be advised of the new grade. Under no circumstances may persons other than the original faculty member or the review committee change a grade. Should the *ad hoc* faculty committee feel that the instructor's written explanation justifies the original grade, the *ad hoc* committee will report this in writing to the student and instructor and the matter will be closed.

FACULTY GRADE CHANGE PROCEDURE

The Student Grade Appeal Procedure affirms the principle that grades should be considered final. The principle that grades for courses or projects should be considered final does not excuse an instructor from the responsibility to explain his or her grading standards to students and to assign grades in a fair and appropriate manner. The appeal procedure also provides an instructor with the opportunity to change a grade for a course or project on his or her own initiative. The appeal procedure recognizes that errors can be made and that an instructor who decides that it would be unfair to allow a final grade to stand due to error, prejudice or arbitrariness may request a change of grade for a course or project without the formation of an *ad hoc* committee. An instructor may request a grade change in one of two ways. First, for courses, an instructor may submit a course grade change in writing to the Registrar at any time prior to a student's graduation. Second, for Degree Requirements (MQP, IQP, and Sufficiency), an instructor must submit a petition to the Committee on Academic Operations (CAO) to change the grade.

TRANSFER STUDENTS

Transfer students should check with the Registrar's Office to determine whether their course grades would qualify for WPI honors.

TRANSCRIPT FEES

Transcripts are furnished upon written request to the Registrar's Office. Each student is allowed one free transcript. Each additional transcript is subject to a fee established by the college administration. Official transcripts cannot be faxed.

The college reserves the right to withhold the release of transcript information for students with administrative obligations.

DEGREE AUDITS

WPI has developed a computerized degree evaluation which lists students' courses as they apply to the respective department distribution requirements. The degree evaluation is available online.

Any course substitutions or exceptions to the degree evaluation must be forwarded to the Registrar IN WRITING from the Department Program Review Committee.

DESIGNATION OF MAJOR AREA OF STUDY

Designation of a student's major area of study on the transcript is determined by his or her completion of published academic activity distribution requirements, as well as by the Major Qualifying Project. The authority and responsibility of certification of the disciplinary or interdisciplinary area will lie with the appropriate departmental or IGSD Program Review Committee (PRC) in consultation with the student and his or her academic advisor.

For examples of major areas of study, please see page 24.

DOUBLE MAJOR

DISTRIBUTION REQUIREMENTS

The distribution requirements of each major must be met, but requirements common to both majors may have to be met only once. A minimum of three units of qualifying project work is thus required for fulfillment of the project portion of the double major requirements: one unit in each of the two major areas of study, and one unit of an IQP. It is the intent of this policy that the three units of project activity requirement be interpreted to mean three *distinct* project activities, each bearing *at least* one unit of credit.

For students wishing to pursue double majors not involving social science, the program audit for each intended major must be completed and certified by the review committee of each department involved. Academic activities appropriate to both majors may be counted in both majors.

The number of majors associated with a single WPI Bachelor of Science degree shall be **limited to two**.

For the policy in the special situation of double majors involving the social sciences, see page 185.

DESIGNATION OF CLASS YEAR

Class year will normally be designated as year of matriculation plus four with the additional requirement that the accumulation of 30/3 units is necessary for fourth-year status, 19/3 units for third-year status, and 8/3 units for second-year status. The class year of transfer students will be determined on an individual basis. Class year designations will be reviewed at the end of Term E each year and changed if the credit accumulation does not meet the above specifications. After Term E, students may petition to be redesignated in their original class if they meet the minimum unit requirements.

GUIDELINES FOR THE DETERMINATION OF SATISFACTORY ACADEMIC PROGRESS, ACADEMIC WARNING, ACADEMIC PROBATION AND ACADEMIC SUSPENSION

SATISFACTORY ACADEMIC PROGRESS

In order to assist both the student, parents and the academic advisor in determining whether a student is making academic progress, WPI has adopted both of the following guidelines, effective Term A, 1989.

1. The student must complete at least 4/3 units of work in two successive terms, including Military Science, Physical Education and Consortium courses.

2. The student must complete at least 8/3 units of work in four successive terms, including Military Science, Physical Education and Consortium courses.

Note: Term E (Summer School) will be included if the student is registered full time.

ACADEMIC WARNING

Each student's academic record will be reviewed at the conclusion of terms B and D according to the guidelines above. If a student's performance falls short of either guideline 1 or 2, the student, parent and academic advisor will be notified that the student is not making satisfactory progress. The notification will place the student on *Academic Warning*. At this time, the student is urged, with the help of his/her advisor, to identify the nature of the academic difficulty and to formulate a course of action for overcoming the difficulty.

ACADEMIC PROBATION

During the next review of academic progress, should the student fail, once again, to maintain satisfactory academic progress, the student, parent and academic advisor will be notified. This notification will place the student on *Academic Probation* for two terms. Academic Probation will prevent the student from receiving financial aid, will result in loss of eligibility for team sports, will prevent the student from obtaining undergraduate employment in the Co-op Program and will prevent participation in the Global Perspectives Program.

Students who obtain no academic credit (exclusive of Physical Education or ROTC-related courses) in either Term A or Term C shall be sent a letter by the Director of Academic Advising informing them of the following change of academic status if they earn no academic credit for the next term for which they are registered.

Students who fail to obtain credit for two consecutive terms shall:

- a) be placed on Academic Probation if currently they are classified as making satisfactory progress, or
- b) be placed on Academic Suspension if currently they are on the list of students on Academic Warning or on Academic Probation.

Subsequent academic review shall follow the rules for all students.

This amendment shall be incorporated in the Undergraduate Catalog and shall be implemented as of the Fall semester of 1994. Students affected by this rule retain the right to petition the Committee on Academic Operations for a waiver for extenuating circumstances.

ACADEMIC SUSPENSION

Should a student on Academic Probation fail to make satisfactory academic progress during the next review period, the student will be *suspended* from WPI. The notification will prevent the student from enrolling as a full-time student *or* a special student for at least the next two terms. Subsequent readmission is subject to approval (with possible conditions) of a petition through the Registrar to the Committee on Academic Operations (CAO). As a general rule, a student readmitted after suspension will be placed on an Academic Probation status.

New students (first year or transfer) who fail to obtain academic credit for the first two terms shall be placed on Academic Suspension and not allowed to enroll for the following terms. Readmission is subject to approval by the Committee on Academic Operations.

IMPROVEMENT IN STATUS

Students on Academic Warning or Academic Probation have the opportunity to improve their status by progressing through the levels in reverse order. If a student on Academic Probation satisfactorily meets the guidelines at the end of the next review period, he or she will be moved to the list of students on Academic Warning. A student on Academic Warning would be moved back to Satisfactory Academic Progress status.

TERM E REVIEW PERIOD

An exception to the guidelines stated above can occur when a student registers full time for Term E. At the conclusion of Term E, a review will be conducted which will include the previous five terms. If the student has completed 10/3 units acceptable work, the student's academic progress status will improve. Thus, a student on Warning status after the Term D review will start terms A and B on Satisfactory Academic Progress. A student placed on Academic Probation after the Term D review will be on Warning status for terms A and B. A student on Suspension status after the Term D review will be able to register for terms A and B on Academic Probation.

SUMMER BRIDGE PROGRAM

Students who finish the academic year on Academic Warning or Academic Probation status, but who have passed at least 2 units of academic work during the previous four terms, are eligible to participate in the Summer Bridge Program. Students who participate in the program enroll in Term E for two courses and also take a four-week study skills program. Successful completion of the courses and the study skills program will result in the academic status rising one level (Academic Probation to Academic Warning, or Academic Warning to Satisfactory Academic Progress). The Office of Academic Advising coordinates the Summer Bridge Program.

SPECIAL STUDENTS

Students pursuing the bachelor's degree as special students will be subject to the same review schedule and standards as full-time students except that, during any review period, the student's academic record from the *four* most recent terms will be checked to ensure the student has satisfactorily completed at least two-thirds of the academic activities for which he/she has registered.

PETITIONS

Students may petition through the Registrar's Office to the Committee on Academic Operations (CAO) for reconsideration of the status of any of the following:

- Academic Warning
- Academic Probation
- Academic Suspension
- Readmission after Suspension
- Other unusual situations

Students who petition for reconsideration of status must accomplish the following:

1. Go to the Registrar's Office and obtain a petition form.
2. Complete form with advisor and obtain advisor's approval and signature.
3. Submit form to the Registrar's Office within *three* weeks of the issuance of grades for B, D, or E term reviews except for readmission after suspension. For readmission after suspension, petitions must be submitted to the Registrar's Office at least three weeks prior to the start of classes.

READMISSION AFTER SUSPENSION

Deadlines for petitions:

July 15 for Term A

November 15 for Term C

ADMINISTRATIVE OBLIGATIONS

The college reserves the right to hold grades, transcripts, registration and/or diploma for any student who has an outstanding administrative obligation with the college.

DIRECTORY INFORMATION AND RELEASE OF INFORMATION

The items listed below are designated as Directory Information and may be released at the discretion of the institution. Under the provisions of the Family Educational Rights and Privacy Act of 1974, as amended, students have the right to withhold the disclosure of any or all of the categories of Directory Information. Written notification to withhold directory information must be received by the Registrar's Office during the first week of the fall semester. Forms are available in the Registrar's Office. A request to withhold directory information in no way restricts internal use of the material by the college.

Directory information will include the student's campus mailbox, full name, year, major codes, advisor code, e-mail address, home address, local address, local phone, date and place of birth, dates of attendance, degrees and awards received, and most recent or previous educational agency or institution.

Unless a student notifies the Registrar's Office in writing to the contrary, the college considers all undergraduate students to be dependents of their parents. In compliance with the Family Educational Rights and Privacy Act, the college reserves the right to disclose information about the status of dependent students to their parents without the students' written consent. Petition forms for Declaration of Independent Status are available in the Registrar's Office upon request (see information under Distribution of Grades, page 243).

A calendar is published by the Registrar prior to the enrollment course-change period which specifies the time periods and fees for late changes. Students are responsible for the dates and should contact the Registrar's Office if they need information to avoid late fees. Requests for exceptions to published deadlines must be submitted in writing and approved by the Registrar prior to Enrollment Day, and will be granted based on documented extenuating circumstances, i.e., medical, military obligations.

REGISTRATION

During the spring, students will receive information regarding course offerings for the following academic year. After consulting with academic advisors, students will make course selections via the online registration system. Students with holds may be prevented from registering until the obligation is met.

ENROLLMENT

At the beginning of terms A and C, students will receive enrollment information. **All students must enroll whether or not course changes are to be made.**

COURSE CHANGES

Course changes can be made online (<http://registrar.wpi.edu>) until 4 p.m. on the second day of classes for each term.

APPLICATION FOR DEGREE

Each student must file an application for degree with the Registrar's Office in accordance with the following schedule:

To graduate in:

May	Beginning of preceding Term B
October	Beginning of preceding Term D
February	Beginning of preceding Term A

WAIT LISTS

When a seat in a class becomes available to a student on the wait list, he or she will be notified via e-mail. The e-mail contains instructions on how to claim the available seat.

If a student does not receive an e-mail, it means no seat is available for him/her in the wait-listed class. Wait lists for an upcoming term are abolished on the first day of classes for that term. Students are automatically removed from the list at that time.

OVERLOADS OF COURSES

The standard course load for WPI students is one unit per term (exclusive of courses for ROTC, and Physical Education, which do not count towards overloads). Students may register in advance for a maximum of one unit in any term.

Registration for courses which will result in an overload may take place, on a space-available basis, as of the first day of the term in which that course is offered.

A student may not include any portion of qualifying work (project or Sufficiency) as part of an overload without the approval of both the academic and project advisors. Written approval will be requested before registration can be completed in such cases.

Overload charges will be computed each semester based on the course and project load included in the student's final term registration.

To compute overload charges, see Expenses, page 269.

WITHDRAWAL FROM COURSES

Students on the WPI Plan who wish to withdraw from a course or project will be assigned a grade of NR (No Record) by the instructor. The student should contact the instructor and indicate that he/she will not be continuing in the class.

WITHDRAWAL FROM WPI

Students wishing to withdraw from WPI should initiate that procedure by consulting the Registrar's Office. Any reduction in tuition charges is directly dependent on the date the student officially withdraws and formally files his/her paperwork with the Registrar's Office.

PROJECT AND INDEPENDENT STUDY REGISTRATION

PLANNING

During the academic planning period, which starts in February, students who intend to conduct project work during the following year should set aside time to plan their projects, meet with faculty, and form project teams. The faculty will list project opportunities on the Projects Program web page in February. (Some Project Centers and special programs may have an application process before that.) Each academic department typically will hold a projects information meeting for students in their major. Students are also encouraged to meet with faculty individually.

The most important and difficult part of a project is the planning which precedes the execution. The planning phase of your project will involve developing a background, talking to people in the field, finding out what has already been done in the area, and determining what your goals are and what you need to do to accomplish them. If any special equipment, financing, or resources will be needed for execution of the project, it is especially important to make this known early to ensure that it will be available to you. In addition, most faculty members require a project proposal before registration of the project.

REGISTRATION

Students who intend to do project work next year should complete a registration form during the Project Registration Period. During other times of the year, registration for project or independent study work must be completed within the course-change period of any term. The Project Registration Form is available at the Registrar's Office.

For registration, the following information is needed: project title, advisor(s), discipline(s), name and address of off-campus organization (if any), and type (major qualifying, interactive qualifying or pre/postqualifying project). Projects involving an off-campus organization carry the

further obligation of compliance with the rules and regulations of the organization. Often, these are specified in a formal contract between the organization and WPI and are legally binding. At the time of registration, students will be required to review the legal documents in the Registrar's Office and sign an agreement and release form.

Students may not receive pay from an off-campus organization and project credit for the same work.

Students must note that where the major area of study is a recognized disciplinary area of the college, either the MQP advisor or an associate advisor must be a member of the faculty in that discipline.

Additional information regarding project registration will be available through the Registrar's Office prior to the registration period.

CHANGE OF REGISTRATION INFORMATION

For all changes in projects, use the Project Registration Form. Students may change the title, the type or the discipline of the project with the approval of the project advisor but without having to secure the approval of the academic advisor. The student must obtain the project advisor's written approval and the academic advisor's approval before changing the number of units in the current or future terms.

All project changes are to be made only during the course-change period of each term.

CHANGING PROJECT ADVISOR

To change the project advisor for a degree-required project, students must obtain the authorizing signatures of both the existing and new project advisors and of the academic advisor and submit the form during a course change period.

PROJECT CONFERENCES

Students should report to their project advisor's office at the beginning of the term to make arrangements for subsequent meetings.

OVERLOADS

If a part of the work in a given term involves qualifying project work, students may not register for an overload without the written approval of both the academic and project advisors on a project overload petition form. This form is available at the Registrar's Office.

PROJECT COMPLETION

During the final term of registration for the project and sufficiently prior to the deadline for submittal of Completion of Degree Requirement Forms, students must submit their completed project report to the project advisors. Students are also required to submit a copy of the document to the participating off-campus organization sufficiently prior to the end of the term so that proprietary and confidential information in the report can be identified and removed. Most off-campus organizations require 30 days for this review, and the grade and final report cannot be submitted to the Registrar by the project advisor until this review has been done.

The project report must contain a title page similar in format to that specified on the Projects Program web page, in the area entitled, "Finishing Up." The report itself can be submitted in a hard binding equivalent to the pressboard binders available in the WPI Bookstore. (See Documentation and Final Report Procedures on page 36.)

REGISTRATION POLICY FOR DEGREE REQUIREMENTS

The completion of a degree requirement (MQP, IQP or Sufficiency) will *not* be recorded in the Registrar's Office on or after the first day of classes of a term unless the student is registered for a minimum of 1/6 unit *of the same activity* in that term. The deadline for receipt of the Completion Form (and reports for projects) is the last working day *prior to* the first day of classes for the next term. *Any* exceptions to this policy must be handled by written petition from the project advisor.

NOTE: Candidates for degrees must meet graduation deadlines if they differ from the above. Deadlines for degree candidates will be strictly enforced!

Only Completion of Degree Requirement (CDR) forms which are complete, correct and consistent with the student's registration records will be accepted by the Registrar's Office. The CDR must be accompanied by the written report or other appropriate documentation. (See PROJECTS section, page 35.)

SPECIAL STUDENTS

The status of Special Student during the regular academic year is granted only to those who meet one or more of the following qualifications:

1. Persons holding a baccalaureate degree before the start of a semester.
2. Persons wishing to take a specific course and who are not pursuing a degree program at WPI.
3. Persons pursuing a degree program over an extended period of time and who have a planned program which involves a *maximum* of one unit per semester (August through December; January through May) *throughout* the academic year.
4. Students who have completed four full years of undergraduate work, satisfied the residency requirement, and must complete a limited amount of additional work to complete their degree requirements.

Special students pay tuition on the basis of \$2,463 (2004-05 figure) per 1/3 unit at the start of each term. All other undergraduate students will pay full tuition (\$29,550 for the 2004-05 academic year) and will be considered regular students with full resident privileges. (Special students may not engage in varsity/club sports, may not participate in any extracurricular activities, may be required to register for courses on a space-available basis, and *are not eligible for financial aid or any form of on-campus student employment.*)

The following registration procedures apply:

- Students who wish to enroll as special students must apply for such status before Enrollment Day, Term A. Such status will allow a maximum of one unit per each semester of the academic year. Students who enroll as regular students in the fall may *not transfer to or from* special student status until the following fall or until all degree requirements have been certified with the Projects and Registrar's Office as having been satisfactorily completed.
- Reduction from full-time to part-time status is not allowed at midsemester.
- Special students wishing to return as full-time students must be readmitted according to the procedures specified under Readmission in the Admissions section of this catalog, page 267.

For the Guidelines for Determination of Satisfactory Progress for Special Students, see page 247.

PROJECT REGISTRATION TOPIC CODES

MQP Majors and Coordinators

	Majors	Coordinators
BIO	Biology and Biotechnology	J. Rulfs
BBC	Biology and Biotechnology with Concentration	J. Rulfs
BC	Biochemistry	J. Pavlik
BME	Biomedical Engineering	R. Peura
CA	Computers with Applications	D. Finkel
CE	Civil Engineering	F. Hart
CH	Chemistry	W. McGimpsey
CHE	Chemical Engineering	W. Clark
CS	Computer Science	D. Finkel
EC	Economics	K. Saeed
ECE	Electrical and Computer Engineering	R. Labonte
EP	Environmental Policy and Development	K. Saeed
ET	Economics & Technology	K. Saeed
EV	Environmental Engineering	L. Schachterle
HU	Humanities	M. Parkinson
ID	Interdisciplinary	P. Davis
IE	Industrial Engineering	S. Johnson
IS	International Studies	P. Hansen
MA	Mathematical Sciences	W. Martin
MAC	Actuarial Mathematics	A. Heinricher
ME	Mechanical Engineering	B. Savilonis
MFE	Manufacturing Engineering	M. Demetriou
MG	Management	M. Banks
MGE	Management Engineering	M. Banks
MIS	Management Information Systems	M. Banks
PH	Physics	T. Keil
PHE	Engineering Physics	T. Keil
SD	System Dynamics	K. Saeed
ST	Society, Technology & Policy	K. Saeed
TC	Technical, Scientific & Professional Communication	J. Trimbur

Humanities and Arts Sufficiency

Topics	Project Advisor
Topics in American Studies	S. Bullock (SCB), J. Hanlan (JPH), K. Ljungquist (KPL), J. Manfra (JM), W. Mott (WTM), J. Trimbur (JOT)
Topics in Art	M. D. Samson (MDS), J. Rosenstock (JR1)
Topics in Drama/Theatre	J. Sands (JTS), S. Vick (SV), J. Zinn
Topics in Foreign Language (German)	D. Dollenmayer (DZD)
Topics in Foreign Language (Other)	A. Rivera (AAR)
Topics in Foreign Language (Spanish)	H. J. Manzari (HJM), A. Rivera (AAR)
Topics in Global Studies	W. Addison (WAA), E. Choi (EYC), P. Hansen (PHH)
Topics in History (American)	W. Baller (WXB), M. Barroll, S. Bullock (SCB), D. Gray (DEG), J. Hanlan (JPH), J. Manfra (JM), D. Rawson (DZR), J. Watters (JEW)
Topics in History (European)	W. Addison (WAA), W. Baller (WXB), J. Forgens (JLS), P. Hansen (PHH)
Topics in History (Science and Technology)	M. Barroll, J. Forgens (JLS), E. Parkinson (EMP), D. Spanagel (DIS)
Topics in International Studies–Humanities (Interrelated)	B. Addison (WAA), P. Hansen (PHH)
Topics in Literature (American)	J. Dempsey (JD4), K. Ljungquist (KPL), W. Mott (WTM), S. Nikitina (SNZ)
Topics in Literature (Contemporary)	J. Trimbur (JOT)
Topics in Literature (English)	J. Brattin (JYB), M. Ephraim (MKE), P. Quinn (PJQ)
Topics in Music	F. Bianchi (FB), J. Delorey (JD2), R. Falco (RGF), E. Shim (ES1), D. Weeks (DGW)
Topics in Philosophy	R. Gottlieb (RSG), J. Sanbonmatsu (JS6)
Topics in Religion	D. Shikiar (DAS), R. Smith (RLS)
Topics in Writing, Rhetoric, and Communications	J. Trimbur (JOT), L. Higgins (LDH)
International Students	J. Forgens (JLS)
IMGD	D. O'Donnell (DMO), J. Rosenstock (JR1)

CODING OF PROJECT ADVISORS

Code	Advisor	Department	Code	Advisor	Department
DSA	Adams, D. S.	BB	RGF	Falco, R. G.	HUA
WAA	Addison, W. A. B.	HUA	WWF	Farr, W. W.	MA
EOA	Agu, E. O.	CS	JDF	Fehribach, J. D.	MA
LDA	Albano, L. D.	CE	DXF	Finkel, D.	CS
DA	Apelian, D.	ME	KXF	Fisler, K.	CS
PKA	Aravind, P. K.	PH	MSF	FitzPatrick, M. S.	CE
JMA	Arguello, J. M.	CH	MQF	Fofana, M.	ME
HXA	Ault, H. K.	ME/BME	JLS	Forgeng, J.	HUA
			CF	Furlong-Vazquez, C.	ME
JCB	Bagshaw, J. C.	BB	RG1	Garcia, R.	PH
WXB	Baller, W. A.	HUA	NAG	Gatsonis, N.	ME
MCB	Banks, M. C.	MG	MXG	Gennert, M. A.	CS/BME
JRB	Barnett, J. R.	FPE/ME	AG	Gerstenfeld, A.	MG
IB	Bar-On, I.	ME	DVG	Gibson, D. G.	BB/BME
JIB	Bergendahl, J.	CE	RSG	Gottlieb, R. S.	HUA
FB	Bianchi, F.	HUA	DEG	Gray, D. E.	HUA
KLB	Billiar, K. L.	BME	PJG	Grebinar, P. J.	PE
JB3	Blandino, J. J.	ME			
IZB	Blank, I.	MA	HH	Hakim, H.	ECE
JYB	Brattin, J. J.	HUA	JPH	Hanlan, J. P.	HUA
CAB	Brown, C. A.	ME	PHH	Hansen, P. H.	HUA
DCB	Brown, D. C.	CS	FLH	Hart, F. L.	CE
DRB	Brown, D. R.	ECE	GZH	Heaton, G. R.	MG/SSPS
SCB	Bullock, S. C.	HUA	NTH	Heffernan, N.	CS
NAB	Burnham, N. A.	PH	GTH	Heineman, G. T.	CS
			ACH	Heinricher, A. C.	MA
TAC	Camesano, T. A.	CHE	HNH	Higgins, H. N.	MG
FC	Carrera, F.	IGSD	LDH	Higgins, L. D.	HUA
RDC	Cheatham, R. D.	BB	AHH	Hoffman, A. H.	ME
PRC	Christopher, P. R.	MA	MKH	Hofri, M.	CS
MXC	Ciaraldi, M. J.	CS	ZWH	Hou, Z.	ME
EXC	Clancy, E. A.	ECE	MH	Humi, M.	MA
WMC	Clark, W. M.	CHE/BME	GSI	Iannacchione, G. S.	PH
MLC	Claypool, M.	CS			
KAC	Clements, K. A.	ECE	SNJ	Jaspersen, S. N.	PH
ECE	Cobb, E. C.	ME	PJ	Jayachandran, P.	CE
REC	Connors, R. E.	CH	JSJ	Jiusto, J. S.	IGSD
TCC	Crusberg, T. C.	BB/BME	HJ	Johari, H.	ME
DC	Cyganski, D.	ECE/BME	SAJ	Johnson, S. A.	MG
MNC	Cyr, M.	ME			
ED	Danneels, E.	MG	CJK	Kasouf, C. J.	MG
RYD	Datta, R.	CHE	NKK	Kazantzis, N.	CHE
PWD	Davis, P. W.	MA/IGSD	THK	Keil, T. H.	PH
JD2	Delorey, J. F.	HUA	BYK	King, B. M.	ECE
NAD	Dembsey, N. A.	FPE	REK	Kinicki, R. E.	CS
JD4	Dempsey, J.	HUA	CK	Koleci, C.	PH
MAD	Demetriou, M.	ME	JRK	Krueger, J. R.	IGSD
CXD	Demetry, C.	ME			
DDB	DiBiasio, D.	CHE/BME	RQL	Labonte, R. C.	ECE
MFD	Dimentberg, M.	ME	CJL	Larsen, C. J.	MA
JPD	Dittami, J. P.	CH	KAL	Lemone, K. A.	CS
AGD	Dixon, A. G.	CHE	JNL	Liang, J.	ME
SZD	Djamasbi, S.	MG	RL1	Lindeman, R. W.	CS
DZD	Dollenmayer, D. B.	HUA	KPL	Ljungquist, K. P.	HUA
DJD	Dougherty, D. J.	CS	ETL	Loiacono, E. T.	MG
JKD	Doyle, J. K.	SSPS	FJL	Looft, F. J.	ECE
RJD	Duckworth, R. J.	ECE	WJL	Lou, W.	ECE
WWD	Durgin, W. W.	ME/BME	REL	Ludwig, R.	ECE
			RYL	Lui, R. Y. M.	MA
TEL	El-Korchi, T.	CE	KKL	Lurie, K. A.	MA
MBE	Elmes, M. B.	MG	JML	Lyneis, J. M.	SSPS
AEE	Emanuel, A. E.	ECE			
MKE	Ephraim, M. K.	HUA			

Code	Advisor	Department	Code	Advisor	Department
YHM	Ma, Y. H.	CHE	KQS	Saeed, K.	SSPS
JM8	MacDonald, J. C.	CH	GFS	Salazar, G. F.	CE
SNM	Makarov, S. N.	ECE	MDS	Samson, M. D.	HUA
MVM	Makhlouf, M. M.	ME	JS6	Sanbonmatsu, J.	HUA
RBM	Mallick, R. B.	CE	JTS	Sands, J. T.	HUA
JM	Manfra, J.	HUA	MOS	Sarkis, M.	MA
MMX	Mani, M.	CS	BJS	Savilonis, B. J.	ME/BME
HJM	Manzari, H. J.	HUA	AAS	Scala, A. A.	CH
WJM	Martin, W. J.	MA	LES	Schachterle, L. E.	HUA
PPM	Mathisen, P. P.	CE	SMS	Selkow, S. M.	CS
LM1	Mathews, L. M.	BB	BZS	Servatius, B. I.	MA
BLM	McCarthy, B. L.	HUA	DAS	Shikar, D. A.	HUA
WGM	McGimpsey, W. G.	CH	ES1	Shim, E.	HUA
JKM	McNeill, J.	ECE	SYS	Shivkumar, S.	ME/BME
YXM	Mendelson, Y.	BME	RDS	Sisson, R. D.	ME
WZM	Michalson, W. R.	ECE	RLS	Smith, R. L.	HUA
JGM	Mistry, J. J.	MG	CYS	Sotak, C. H.	BME
YMM	Moon, Y.-M.	ME	MS	Strong, D. M.	MG
UXM	Mosco, U.	MA	JMS	Sullivan, J. M.	ME/BME
WTM	Mott, W. T.	HUA	BS2	Sunar, B.	ECE
KM	Mukherjee, K.	MG			
BN	Nandram, B.	MA	DZT	Tang, D.	MA
SNZ	Nikitina, S.	HUA	SST	Taylor, S. S.	MG
MN	Nilsson, M.	MG	VRT	Thalladi, V. R.	CH
FN	Noonan, F.	MG	RWT	Thompson, R. W.	CHE
JWN	Norbury, J. W.	PH	JOT	Trimbur, J. M.	HUA
RLN	Norton, R. L.	ME	GT	Tryggvason, G.	ME
KZN	Notarianni, K. A.	FPE/ME			
JTO	O'Connor, J. T.	SSPS/MG	HGV	Vassallo, H. G.	MG
DMO	O'Donnell, D. M.	HUA	RXV	Vaz, R. F.	ECE
DJO	Olinger, D. J.	ME	DV	Vermes, D.	MA
JAO	Orr, J. A.	ECE	BMV	Vernescu, B. M.	MA
JCO	O'Shaughnessy, J. C.	CE	ZSG	Vernon-Gerstenfeld, S.	IGSD
EWO	Overström, E. W.	BB	SV	Vick, S.	HUA
			DZV	Volkov, D.	MA
KZP	Pahlavan, K.	ECE	HFV	Walker, H. F.	MA
EMP	Parkinson, E. M.	HUA	MOW	Ward, M. O.	CS/BME
JWP	Pavlik, J. W.	CH	PZW	Weathers, P. J.	BB
OVP	Pavlov, O. V.	SSPS	EAW	Weaver, E. A.	SSPS
PCP	Pedersen, P.	ECE	SW	Weekes, S. L.	MA
CXP	Peet, R. C.	ID	DGW	Weeks, D. G.	HUA
JP	Petrucelli, J. D.	MA	JDW	Wilbur, J. D.	MA
RAP	Peura, R. A.	BME	JW1	Wilcox, J.	CHE
GDP	Phillies, G. D. J.	PH	JMW	Wilkes, J. M.	SSPS
RP	Pietroforte, R.	CE	CEW	Wills, C. E.	CS
GXP	Pins, G.D.	BME	KNW	Wobbe, K. N.	CH
JYP	Plummer, J. D.	CE	JPW	Woycheese, J. P.	FPE
SMP	Politz, S. M.	BB			
GFP	Pollice, G. F.	CS	VVY	Yakovlev, V.	MA
RP1	Prusty, R.	BB	RZ	Zalosh, R. G.	FP
RJP	Pryputniewicz, R. J.	ME	ZAZ	Zeng, Z. A.	MG
RSQ	Quimby, R. S.	PH/BME	HSZ	Zhou, H. S.	CHE
PJQ	Quinn, P. J. M.	HUA	JZ	Zhu, J.	MG
			AZ	Zozulya, A.	PH
MJR	Radzicki, M. J.	SSPS			
LRR	Ram-Mohan, L. R.	PH/ECE			
MHR	Ray, M. H.	CE			
MWR	Richman, M. W.	ME			
KJR	Rissmiller, K. J.	SSPS			
AR	Rivera, A.	HUA			
YR	Rong, Y.	ME			
JR1	Rosenstock, J.	HUA			
CR	Ruiz, C.	CS			
JXR	Rulfs, J.	BB			
EAR	Rundensteiner, E. A.	CS			
EFR	Ryder, E. F.	BB			

UNIQUE OPPORTUNITIES AT WPI

S E C T I O N

five

Entrepreneurship	255
Student Exchanges	255
Project-Based Learning Community Option (PLC)	257
Worcester Consortium Course Cross-Registration	257
Cooperative Education Program	257
Summer Session (Term E)	258
Societies, Registration and Licensing	259

ENTREPRENEURSHIP

Today, it would be hard to find a high school student in the U.S. (and many other nations) who is not aware of the possibilities of starting and owning a business. Everyday, the newspaper, radio, television, and Worldwide Web are full of stories about people who have started their own businesses and become wildly successful. Considerably less attention is paid to the point that virtually every one of those successful businesses was founded through innovation, the act of commercializing an invention.

At WPI, we know that most inventions come from the engineers and scientists of the world. Of course, we want to attract students and faculty members who want to be inventors. But we want more for them, too. We want them to understand the innovation process so they can turn their inventions into businesses. That is why we developed the COLLABORATIVE FOR ENTREPRENEURSHIP & INNOVATION.

The Collaborative for Entrepreneurship and Innovation (CEI) at WPI is part of the Department of Management. It coordinates opportunities for undergraduate and graduate students within WPI, such as the WPI chapter of the international organization, Collegiate Entrepreneurs Organization (CEO), and is available for consultation on Intellectual Property issues and concerns that students and faculty members might have related to projects. The other major component of the CEI, the WPI VENTURE FORUM, coordinates the outreach opportunities for WPI students and faculty members, as well as those outside of WPI.

Everything we do in the CEI is driven by our mission and goals, which you will find below. That is because we are providing our students with an integrated experience that will help them become the very best entrepreneurs in the world.

OUR MISSION

The Collaborative for Entrepreneurship and Innovation inspires and nurtures people to discover, create, and commercialize new technological products and services, and to create new organizations based on those products and services, thereby advancing economic development and improving society.

OUR GOALS

We will:

- Attract students and faculty members to WPI who are interested in using inventions and technology to foster new businesses;
- Foster informed risk-taking among our undergraduate and graduate students and others wishing to pursue the dream of entrepreneurship;
- Build bridges between WPI students, staff, faculty, and alumni, and the wider entrepreneurial business community;
- Encourage corporations to develop an environment that celebrates entrepreneurship as a combined act of discovery, creativity, and innovation; and
- Achieve a leadership role among the preeminent entrepreneurship programs in the U.S.

Currently the CEI offers a number of opportunities to WPI students. These include:

- A minor in Entrepreneurship through our parent organization, the Department of Management.
- Courses in Entrepreneurship for those who do not wish to take a minor.
- MQP and IQP opportunities in Entrepreneurship.
- An Entrepreneur-in-Residence, a rotating position staffed by an entrepreneur who offers a course in entrepreneurship once a year.
- An external advising team of entrepreneurs and investors who are available to mentor aspiring entrepreneurs among our students.
- The New England Collegiate Entrepreneur Award, which students can apply for if they have their own business while still undergraduates. Even though it is a region-wide competition, it has thus far been won only by WPI students.
- Networking opportunities through activities with our community outreach arm, the WPI Venture Forum.
- A student organization, the Collegiate Entrepreneurs Organization (CEO) at WPI, part of a nationwide organization that supports and fosters entrepreneurial intentions among college students.

The CEI@WPI ALL-OUT Business Plan Challenge. All WPI students are eligible to compete for cash and in-kind prizes and the opportunity to advance to other competitions.

For more information on the Collaborative for Entrepreneurship and Innovation, please contact Gina Betti, Associate Director, CEI, 226 Washburn at 508-831-5761; gbetti@wpi.edu.

STUDENT EXCHANGES

As technology and commerce become increasingly international in outlook, students in engineering, science and management must learn about countries and cultures other than their own. To respond to this need, WPI offers its students an extensive range of opportunities to broaden their academic and cultural perspectives through study in a foreign country. Unlike many other exchanges, the WPI program is structured to allow students to work directly with foreign students, faculty, and professionals, and to live in residences with the students of the host institution. For WPI students on these exchanges, time is usually available for additional travel, before or after the formal academic period.

WPI presently offers undergraduate exchanges with universities in Canada, Germany, Mexico and Sweden as described in detail below.

These exchange programs typically involve third-year students, though qualified sophomores and seniors have been accepted. Students could go on these exchanges for a semester or a full year. Where perfecting a foreign language is part of the program in Germany or Sweden, a

full year abroad is more common. **The principal academic emphasis in all exchanges is upon course work.** In such programs, students must work closely with their advisor, the academic advisor of the exchange program, and the program coordinator at the site to design an individual program of study. **Students have the responsibility of obtaining prior tentative approval from their department that courses taken abroad will count towards departmental distribution requirements. For final transfer credit evaluation, students must provide upon return the necessary detailed information on the content of courses taken abroad and the satisfactory completion of all work.** In some exchanges, opportunities exist to complete project work (IQP, MQP, and Sufficiency). The exchanges offer exceptional possibilities for projects comparing American and overseas applications of technology and the impact of technology on society.

For more information on these programs, consult with Pamela O'Bryant in the Project Center or the academic advisor listed for each program.

LANGUAGE REQUIREMENTS

The usual language of instruction at most of the exchange institutions is the official language of the host country. While these institutions may offer a few courses taught in English, most lectures will be given in a foreign language. Thus, exchange students who intend to complete substantial course work must acquire the necessary language background. In some cases intensive language instruction can be arranged on site. In other cases, students acquire the language background through courses taught at WPI or other collages, or by self study. A few exceptions exist at some technical universities where the official language of instruction may be English. For information about language requirements, inquire with the academic advisor listed for each program or Pam O'Bryant in the Project Center.

ECOLE POLYTECHNIQUE; MONTREAL, QUEBEC, CANADA; EXCHANGE

Coordinator: Pam O'Bryant, Project Center
Academic Advisor: Prof. W. A. Bland Addison, Salisbury Labs 02

The Ecole Polytechnique de Montréal provides WPI students with the opportunity to study in French without incurring the cost of transatlantic travel. The École Polytechnique is located in the beautiful cosmopolitan city of Montreal, known for a rich variety of cultural activities, night life, and easy access to winter sports. This program offers a unique opportunity for an inside look at francophone culture within Canada today. Students study and socialize with French-speaking students at Poly and can take French language courses at the University of Montreal. In coordination with the academic advisor of the program, students can complete French language or French-Canadian Studies sufficiencies or IQPs through the exchange.

MONTERREY INSTITUTE OF TECHNOLOGY; MONTERREY, MEXICO; EXCHANGE

Coordinator: Pam O'Bryant, Project Center

WPI has established an exchange agreement with Monterrey Institute of Technology (The Instituto Tecnológico y de Estudios Superiores de Monterrey, ITESM). ITESM was founded in 1943 and is the foremost private technological and management university in Mexico, with programs available in Spanish at the main campus in Monterrey in northern Mexico. Some opportunities also exist for study at selected ITESM satellite campuses at 25 other locations in Mexico, by special arrangement in advance. WPI students have excellent opportunities to study engineering, science, and management in this leading Spanish-speaking university. In addition, ITESM offers special courses for North Americans wanting to learn how to do business in Latin America, and a full program of residential and academic study for English-speaking students seeking to increase their knowledge of Spanish language and culture.

ROYAL INSTITUTE OF TECHNOLOGY; STOCKHOLM, SWEDEN; EXCHANGE

Coordinator: Pam O'Bryant, Project Center
Academic Advisor: Holly Ault, Higgins Labs 207

WPI and the Kungliga Tekniska Hogskolan (Royal Institute of Technology, KTH) in Stockholm, Sweden, have arranged an exchange for WPI students learning Swedish. KTH is a four-year technical university which is divided into ten different schools of engineering which are relatively independent of each other and control their own admissions.

The academic year, approximately August 25 to May 31, is divided into eight periods of four weeks (three weeks of classes and one week of unscheduled activities). Most courses last three to four periods; others may be shorter or longer. Final examinations for courses are normally given three to four times a year and can be taken repeatedly without having to repeat a course. There are some courses with regular examinations. Many students live in rooms and apartments in the city of Stockholm; some live in accommodations provided by the student union. Some scholarship aid is available, and students may fulfill their Sufficiency requirement through the exchange.

TECHNICAL UNIVERSITY; DARMSTADT, GERMANY; EXCHANGE

Coordinator: Pam O'Bryant, Project Center
Academic Advisor: Prof. David Dollenmayer, Alden 209

WPI established a student exchange program with the Technische Hochschule in Darmstadt (THD) in 1989. The THD, one of the oldest in Germany, is located in central Germany, close to the main financial and transportation center of Frankfurt. In addition to providing WPI students with the opportunity to perfect their German and to study in their major fields, THD provides support for IQPs through the faculty of its Zentrum fuer Interdisziplinare Technikforschung (Center for Interdisciplinary Study of Technology).

PROJECT-BASED LEARNING COMMUNITY OPTION (PLC)

WPI offers a program that blends Physics, Math, and Humanities together in a unified learning experience constructed around group projects and intensively utilizing educational technology. The students involved are provided with a special opportunity to explore the relationship between mathematics and science and to appreciate their place in history and society.

First Year Students who take math and physics courses and a humanities course in history of science or technology, history, literature, or philosophy during A and B Terms, are eligible for the Project-Based Learning Community option (PLC).

Benefits of the PLC include an outstanding student-to-teacher ratio (about 25 to 3); emphasis on group interaction over multiple projects; a new social community and meeting place to form lasting relationships with other students.

Each term the PLC participants take calculus, physics, and a broad humanities course designed to interrelate the three disciplines. All of these classes are held in the same room that is equipped with computers, white boards, and an ample amount of space. The environment is notably different from conventional lectures.

WPI's Project-based Learning Community (PLC) is committed to experimenting with ways of learning through the structure of small group projects and study communities.

Enrollment is limited.

WORCESTER CONSORTIUM COURSE CROSS-REGISTRATION

The Worcester Consortium for Higher Education consists of the following institutions: Anna Maria College, Assumption College, Atlantic Union College, Becker College, Clark University, College of the Holy Cross, Nichols College, Quinsigamond Community College, Massachusetts College of Pharmacy, Tufts School of Veterinary Medicine, University of Massachusetts Medical School, Worcester State College and WPI. Full-time WPI students who cross-register for courses at other Worcester Consortium colleges pay no extra fees. Students are limited to one course per semester. The no-charge plan does not include evening colleges or summer school. The Consortium provides buses which make frequent trips every day to all participating institutions.

Students interested in registering for Worcester Consortium courses should discuss their program with their advisors, and then obtain regulations and registration forms from the Director of Academic Advising or the Projects and Registrar's Office. Worcester Consortium college catalogs are available at the Gordon Library.

COOPERATIVE EDUCATION PROGRAM

THE CO-OP PROGRAM

A Division of the Career Development Center

The WPI Cooperative Education Program provides an opportunity for students to alternate time in the classroom with extended periods of paid, full-time, career-related work experience in industry or private and government agencies. The program, which is optional at WPI, entails work assignments from six to eight months in duration which begin in either January or May.

Most students elect to participate in one co-op placement, though students may choose to work for more than one assignment. Students who participate in the co-op program can graduate on time especially when they have advance placement course work. It is recommended that students pre-plan during their first or second year at school. Preparation of a total college plan with the student's academic advisor is required to ensure a compatible scheduling of work periods and academic courses.

In order to qualify for the co-op program, students must meet the following requirements:

1. they must have completed two years of study but may not participate once they have started their senior year,
2. they must be in good academic standing (students cannot be on academic warning or probation),
3. they are only permitted to register for project credit during the co-op assignment with the approval of their academic and project advisors, co-op supervisor and co-op program coordinator, and
4. they must be full-time students.

Exceptions to any of these requirements are made by submitting a written petition to the Coordinator of Cooperative Education who consults with the WPI Registrar for a final decision.

ADVANTAGES TO STUDENTS AND EMPLOYERS

Co-op offers several advantages to students:

1. Participating in co-op helps students make career-related decisions.
2. Students can test classroom learning in the real world.
3. Co-op earnings enable students to pay a significant portion of their college expenses.
4. Students improve their after-graduation job prospects by gaining valuable work experience. In fact, more and more companies are using their co-op program to identify candidates for full-time permanent positions when the students graduate and/or seek candidates with co-op experience from other companies.

Employers also benefit in a number of ways:

1. Co-op students can handle assignments that may be difficult for untrained personnel, but that do not require the talents of full-time professionals.
2. The program gives employers the chance to judge the actual on-the-job performance of potential permanent employees.

3. Retention rates for permanent employees recruited through a co-op program are higher than for those hired through other routes.

THE PLACEMENT PROCESS

Students who are interested in participating in the co-op program must register with the Career Development Center (CDC) several months before the start date of the work assignment. Registration deadlines are announced at the mandatory Co-op Orientation meeting which is held throughout the year.

Once students complete the training in resume writing and interviewing skills that the CDC provides, the placement process begins. Employers seeking to fill a co-op position provide the CDC with a brief job description. Students decide which jobs they are interested in applying for and the CDC forwards their resume to the appropriate companies. Some employers interview candidates on campus; others review resumes and then invite selected students for on-site interviews. The final hiring decision is left to the employer. The student is free to interview with more than one employer and to choose among the employment offers received. It often takes several months before the student is placed in a co-op assignment.

A co-op position is not guaranteed, but every effort is made to locate appropriate work assignments for qualified students. More than 300 employers have provided co-op opportunities to over 2000 students since the program began in 1976. The search for additional employers is an on-going activity.

OTHER CONSIDERATIONS

The employment experiences gained through the Cooperative Education Program do not substitute for, nor qualify as Major Qualifying Project (MQP) or Interactive Qualifying Project (IQP) requirements. These experiences, however, often generate ideas for qualifying projects with the cooperating companies.

For some students, the co-op orientation and registration period overlaps with an off campus activity, usually involvement with an IQP at one of our project centers. Students should not think that this prevents them from applying for co-op positions since our office has developed systems for dealing with their absence. Students who will be off campus during the orientation and registration period should contact the co-op program coordinator **before** their departure to complete the registration process in advance.

INFORMATION AND REGISTRATION

Students interested in exploring the possibility of participating in the program should contact:

Career Development Center
Coordinator, Cooperative Education Program
Project Center, Lower Level
(508) 831-5260

SUMMER SESSION (TERM E)

During the summer, many courses central to planning major programs of study are offered at a time when all facilities are easily accessible. This is a great time to

- Make up a missing course
- Lighten the load for the next year
- Speed up your time to degree completion

This term also offers an exceptional opportunity to participate in certain types of project activity on a convenient basis since classrooms and laboratories will be less crowded and outside field work unlimited due to weather conditions. The use of the independent study has made it possible to present more individually-oriented course work during this term where class sizes are generally smaller. Many courses offered during Term E are included in the supplement to the catalog which is distributed to all students in March. A special summer

study website is available at www.wpi.edu/+Summer, in March. Students planning to participate in Term E should register at the regular spring registration period.

Term E also offers an excellent opportunity to complete a qualifying project or Sufficiency through a full-time effort during a single term. Students from other campuses are also invited to participate in the work of this term.

Admission to the summer session does not imply admission to regular academic year programs. Students desiring to continue their work at WPI following the summer session should seek admission following standard WPI admissions procedures issued through the Admissions Office.

For more information on the summer session, contact the Summer Session Office at (508) 831-5999.

ENGINEERING SOCIETIES

All engineers are professionals in accordance with the definition of engineering, one of which states that “engineering is the profession in which a knowledge of the mathematical and natural sciences gained by study, experience and practice is applied with judgment to develop ways to utilize, economically, the materials and forces of nature for the benefit of mankind.” Professional engineers also observe a code of ethics, exercise judgment and discretion while providing their services, and are involved in a confidential relationship with their clients. Professional engineers enjoy legal status, use professional titles, and associate together through professional societies.

An excellent way to begin learning about the status of the professional engineer is to join the student branch of a professional society relevant to your interests. At WPI, students are encouraged to join the student branches of such societies as the American Society for Metals (ASM), American Society of Mechanical Engineers (ASME), the Institute of Electrical and Electronic Engineers (IEEE), the American Society of Civil Engineers (ASCE), the American Institute of Chemical Engineers (AIChE), the American Institute of Aeronautics and Astronautics (AIAA), the Association of Computing Machinery (ACM), the American Nuclear Society (ANS), the Society of Automotive Engineers (SAE), the Society of Manufacturing Engineers (SME), the Society of Fire Protection Engineers (SFPE), the Society of Women Engineers (SWE), the American Chemical Society, (ACS), and the Society of Hispanic Professional Engineers (SHPE). For information on these organizations, see the appropriate department head.

Undergraduate students should begin the process of becoming professionally registered and licensed by following the steps detailed in the next section.

ENGINEERING REGISTRATION AND LICENSING

In order to become a “Professional Engineer” (P.E.) and enjoy the legal status which affords certain rights, privileges and responsibilities, engineers must qualify through the formal procedures of registration and licensing. Procedures vary from state to state, but in most cases, the applicant must pass a Fundamentals of Engineering Examination.

FUNDAMENTALS OF ENGINEERING EXAMINATION

To become legally registered as a professional engineer (P.E.), candidates must submit data regarding formal education and technical ability to the appropriate state Board of Registration for Professional Engineers. Two major examinations, The Fundamentals of Engineering Examination (also called Engineering-in-Training, E.I.T.) and the Professional Practice Examination (P.P.E.), must be successfully completed as a measure of technical ability. The Fundamentals Examination must be taken first; the Professional Practice Examination must then be taken

after a designated period of substantial professional experience, usually a minimum of four years. File applications for E.I.T. by January 1. The E.I.T. Examination will be given in mid-April and late-October. File applications for Professional Practice Examinations (P.P.E.) six months in advance.

There are several possible qualification paths to registration as a P.E. The quickest and most common route is to obtain a degree from an ABET (Accreditation Board for Engineering and Technology—formerly ECPD) accredited curriculum, and to acquire the specified amount of suitable professional level experience in addition to passing the two examinations mentioned above. There are seven ABET accredited curricula at WPI—biomedical engineering, civil engineering, chemical engineering, electrical and computer engineering, manufacturing engineering, industrial engineering, and mechanical engineering. Persons with an unaccredited degree can still become registered in most, but not all, states by submitting evidence of a longer “apprenticeship” period (variable by states) before taking the two examinations. Students should strive, if at all possible, to pursue a program which is accredited by ABET and should work closely with their advisors and appropriate major departments to assure that the total program qualifies for accreditation, since this will greatly facilitate the achievement of registration in the future.

ALL SENIOR ENGINEERING MAJORS IN BME, CE, CHE, ECE, ME AND MFE ARE URGED TO TAKE THE FUNDAMENTALS OF ENGINEERING EXAMINATION WHICH IS GIVEN ON CAMPUS EACH FALL AND SPRING. There will never be a better time!

Refresher courses for students, alumni and practicing engineers are available. Successful completion of this examination is normally the first step in eventually obtaining the right to use the initials “P.E.”

WPI’s Office of Continuing Education sponsors an eleven session EIT Refresher course from mid-January through mid-April on the WPI Campus. The course, which is taught by WPI faculty, includes reviews of the major topics covered on the exam. For further information, call 508-831-5517.

DESCRIPTION OF FUNDAMENTALS OF ENGINEERING EXAMINATION (F.E.E.)

Typical Date Given: Last Saturday in October (also in April).

Typical Application Deadline: First week in September (also in January).

Duration: Eight hours.

Type: Multiple choice, open book.

Sample Questions: A set of typical questions asked on the Fundamentals of Engineering Examination may be obtained by applicants from the reserve section of Gordon Library.

CAREER DEVELOPMENT AND GRADUATE SCHOOL

S E C T I O N

Six

Career Development	261
Graduate Studies	261
Graduate Program	262

The Career Development Center (CDC) at WPI is here to assist students in the development of life-long skills related to careers and the job search process. CDC serves not only undergraduate students but graduate students and alumni as well. Information and guidance is provided in the areas of full-time employment, graduate school, part-time employment, Cooperative Education and summer positions.

The Career Development Center (CDC) provides a variety of services to students including the following;

1. **INDIVIDUAL CAREER COUNSELING-** Students can arrange to meet a Career Counselor by appointment or on a drop-in basis. Help is provided in many areas including making career choices, resumes, devising a job search plan, interviewing, and graduate school.
2. **MAJOR SELECTION PROGRAM-** This program offers a variety of services to students trying to choose the major that's best for them.
3. **CAREER RESOURCE CENTER-** CDC maintains a large library of literature and information about various companies that recruit on campus so that students will be well prepared for their interviews and have a reasonably good idea whether they would be interested in a particular company. CDC also provides vocational resources for students researching and exploring various careers. For those students considering graduate schools, the center provides information of graduate education at WPI and elsewhere. The center also houses standard examinations required by many graduate schools such as Graduate Record Exam (GRE), Graduate Management Admissions Test (GMAT), Medical College Admission Test (MCAT, and Law School Admission Test (LSAT).
4. **CAREER FAIRS-** Each year the CDC organizes job fairs for students to obtain information of full-time, part-time, summer, and co-op opportunities.
5. **CAREER WORKSHOPS-** Throughout the year a variety of workshops are offered to students. Topics have included: Resume/Cover Letters, Job Search Strategies, Summer Job Search, Alternatives to On-Campus Recruitment, Plant Interviews, Job Offer Decision Making, and Graduate School.
6. **COMPANY PRESENTATIONS-** Information sessions are provided by recruiters so that students have an opportunity to evaluate and learn more about the companies interviewing on campus.
7. **JOB OPPORTUNITIES-** The CDC posts full-time, co-op, part-time, and summer opportunities. In fact the current students and alumni can be updated on professional full-time opportunities through the offices WEB JOB LISTING SYSTEM. This service is available 24 hours a day, 7 days a week.

8. **ON-CAMPUS RECRUITMENT-** The CDC office coordinates a busy schedule of interviews by recruiters from over 200 private, government, civic, and professional companies and organizations. To give you an idea, here are just a few organizations which have employed WPI graduates in recent years:

Analog Devices	National Grid
BAE Systems	Naval Undersea Warfare Center
General Dynamics-Electric Boat	Pratt & Whitney
General Electric	Raytheon
IBM	Saint Gobain
Kiewit Construction	Teradyne, Inc.
MIT/Lincoln Labs	U.S Govt/Naval Underwater System Center

9. **COMPUTERIZED RESUME DATABASE-** All students that register with the CDC office for on campus interviews or off campus referral will submit their resume via the web to the office. Employers access the resumes through various Web Resume Books which the CDC maintains.

Even after students graduate from WPI, the CDC office provides assistance to alumni seeking new employment or facing a change in career goals.

Location: The Career Development Center is located in the Lower Level of the Project Center. The Phone number is (508)831-5260. The website is www.wpi.edu/+CDC

GRADUATE STUDIES

Many students enroll in graduate school on a full- or part-time basis, realizing that a graduate degree can open the door to job opportunities such as advanced research or development, college teaching, upper level management, law or medicine. Graduate study is another step in the self-learning process begun at WPI, a process that will last a lifetime.

Most graduate schools require applicants to take a standard examination such as the Graduate Record Examination (GRE) or Graduate Management Admission (GMAT). Information on such examinations is available from the Office of Graduate Studies & Enrollment or CDC.

The Office of Graduate Studies and Enrollment and the Career Development Center (CDC) can provide information on graduate education at WPI or elsewhere.

INTRODUCTION

For students who wish to continue their education after receiving the bachelor's degree in the same or a related field, the WPI graduate program offers the opportunity either to specialize or to broaden one's preparation. The M.S. degree is typically a 30-36 credit program. Many programs include options for thesis or directed research. Several graduate departments offer the Master of Engineering, a non-thesis option to the M.S. degree. The M.B.A. degree provides preparation for careers in the management of technological enterprises. In addition to master's programs, graduate-level certificates are offered by select departments.

Graduate study represents a natural extension of education beyond the WPI undergraduate Plan. With proper planning, WPI students may shorten the time required to earn the master's degree as described in the "Combined Bachelor's/Master's Program" section, page 263.

The Ph.D. represents recognized original and independent professional work in the form of research for a dissertation and peer-recognized competence in the technical aspects of the profession.

ADMISSION

Admission decisions to a graduate program of any department is made by the faculty of that department with a formal letter issued by the Office of Graduate Studies & Enrollment. Students generally may enroll in a maximum of two to four graduate courses without formal admission to a degree program. Because numerous exceptions to this rule do exist, students are asked to check with their specific program head and the graduate catalog for exceptions to this rule.

Prospective students who desire an advanced degree should contact the Graduate Studies and Enrollment Office specifying the department in which they intend to do their major work. In general, a complete application, transcripts of all college work, and three letters of recommendation are needed for admission to a graduate program. The Graduate Record Examination (GRE) is required in some programs and, for others, is highly recommended; for all Management programs, the GMAT is required. The required \$70 application fee is waived for WPI alumni and current undergraduate students.

REGISTRATION AND TUITION PAYMENT

Registration for graduate courses opens several months in advance of the start of each semester. Students are encouraged to register early in the cycle.

Tuition for courses taken by graduate students is \$941 per credit hour for the year 2005-2006. (Undergraduate courses listed as "one-third unit" are equivalent to three credit hours.)

Tuition and fees (including health insurance) must be paid before the start of classes.

FINANCIAL AID

GRADUATE ASSISTANTSHIPS

Assistantships are of two types—teaching and research. Generally, teaching assistants are assigned duties supporting faculty in the grading of papers and the supervision of laboratory sections. Research assistants usually are involved in sponsored-research projects that become a part of their theses or dissertations.

The annual stipend for all assistants is between \$14,400-\$25,000 for the 2005-2006 academic year. In some cases this may be supplemented by a summer stipend or by special funds for the academic year.

Most assistantships also provide tuition for up to 10 credits for each of two semesters.

FELLOWSHIPS

Several fellowships are available for students in particular departments and through endowed funds.

The Backlin Fund, administered by the Associate Provost for Academic Affairs provides assistance for students nearing completion of their degree requirements who are recommended by a faculty member and their department chairman.

Competition for the prestigious Goddard Research Fellowship is open to U. S. citizens. Preference is given to doctoral candidates.

Information is available online at <http://www.grad.wpi.edu/Financial/fellowships.html> or by contacting the Graduate Studies and Enrollment Office.

APPLICATION DEADLINES

Although applications for financial aid are considered at any time, the major distribution of aid is based upon complete admission applications submitted by February 1 for the fall semester. For further information on the above programs, please contact the Graduate Admissions Office.

LOANS

Additional assistance in the form of federal and private student loan funds is available to graduate students through the Office of Financial Aid. In order to apply for these loans, students need to complete the FAFSA and Graduate Studies and Enrollment Office. For information on these forms, please visit the Office of Financial Aid website at <http://www.wpi.edu/Admin/FA/Grad/>.

SCHOLARSHIPS AND GRANTS FOR GRADUATE STUDY ABROAD

RHODES SCHOLARSHIPS

Rhodes Scholarships, covering tuition, fees and a stipend for two years of study in selected fields of science and engineering at Oxford University, are assigned through state and regional competitions. Students interested in applying for the Rhodes Scholarships should begin to assemble documentation during the junior year. Applicants should have achieved academic standing sufficiently advanced to assure completion of a bachelor's degree before their projected matriculation at Oxford.

For information, see Prof. Peter Hansen, 39 Dean St., Room 254.

FULBRIGHT GRANTS

A wide variety of grants for graduate study abroad, usually for research toward the doctorate, is available through the federally-funded Fulbright Grants Program. Contact the Office of Graduate Studies & Enrollment for more information.

DEGREES AND REQUIREMENTS

WPI offers master's degrees in applied math, applied statistics, biology and biotechnology, biomedical sciences, chemistry and biochemistry, computer and communications networks, computer science, management, mathematics for educators, and physics, biomedical/clinical, chemical, civil and environmental, electrical and computer, financial math, industrial math, fire protection, interdisciplinary studies, manufacturing, materials science, and mechanical engineering.

The doctorate is offered in biotechnology, computer science, chemistry, physics, materials science and engineering, mathematical sciences, and in biomedical/clinical, chemical, civil and environmental, electrical and computer, manufacturing, mechanical engineering, and fire protection.

Further information and specific requirements for these advanced degrees may be found in the *Graduate Catalog*.

PART-TIME GRADUATE PROGRAM

The part-time graduate programs provides the opportunity to engage in part-time study leading to the master's degree. The evening program is operated by WPI to serve the educational needs of technical and management professionals in central New England.

Master of science degrees for part-time students are offered in applied math, applied statistics, chemistry and biochemistry, computer and communications networks, computer science, financial math, industrial math, marketing and technological innovation, manufacturing management, and physics, biomedical/clinical, civil and environmental, electrical and computer, fire protection, manufacturing, materials science, and mechanical engineering. The master of engineering for part-time students is offered in biomedical, civil and environmental engineering. The master of business administration (M.B.A.) is also offered.

Although the number of courses in each discipline may be limited in any given year, the schedule of courses is such that students taking two courses per semester are generally able to complete the course requirements for the master of science or master of engineering degree in about three years or the M.B.A. in four years.

Students may enroll in individual evening graduate courses without being admitted to a graduate degree program. Those who wish to obtain a degree must apply for formal admission prior to completing two to four courses. Exceptions to the rule exist, therefore, interested students should verify the actual number of courses allowed prior to matriculation with the specific program department.

Graduate-level certificate programs are also available in some departments (see Graduate Catalog for details).

A more detailed description of the program and specific course offerings is available in the Graduate Catalog. Questions relating to the program should be referred to the discipline department heads or to the Office of Graduate Studies & Enrollment.

COMBINED BACHELOR'S/ MASTER'S PROGRAM

The Combined Bachelor's/Master's Program is a unitary program leading a student to a bachelor of science degree and to a master of business administration, master of engineering, or master of science degree. The purpose of the Combined Bachelor's/ Master's Program is to give WPI undergraduates an opportunity to earn a bachelor's and a master's degree from WPI concurrently in less time than would be required if the student were to complete work on the bachelor's degree before beginning work on the master's degree. To gain the full benefit of this program, a student should apply for the Combined Program well before the bachelor's degree is completed. Application at the beginning of the junior year is recommended.

For the master of science and master of engineering degrees, the Combined Program typically allows a student to complete requirements for both degrees in about one more year of full-time study than would be required to earn the bachelor's degree. With careful planning, a student can obtain a similar reduction in the amount of time required to earn an M.B.A.

PROGRAM REQUIREMENTS

Only registered WPI undergraduates may enter the Combined Program. To enter, a student must apply to the WPI Graduate Program. Admission to the Combined Program is made by the faculty of the program that awards the graduate degree. A student in the Combined Program continues to be registered as an undergraduate until the bachelor's degree is awarded.

While in the Combined Program, a student may continue to take courses or projects toward the undergraduate degree; the student may also register for graduate courses, projects, directed research or thesis credits toward the master's degree.

To obtain a master's degree via the Combined Program, the student must satisfy all requirements for that master's degree, including any requirements of the graduate degree-awarding program for satisfactory completion of specified courses or a master's thesis. To obtain a bachelor's degree via the Combined Program, the student must satisfy all the requirements for that bachelor's degree, including distribution and project requirements.

A student in the Combined Program, may, within the program limit and with prior approval, use the same courses toward the bachelor's and master's degrees. The limitation is computed from the graduate credit hours for each course. Courses, whose credit hours total no more than 40% of the credit hours required for the master's degree, and which meet all other requirements for each degree, may be used to satisfy requirements for both

degrees. Such courses are recorded on the transcript using the credit hours/units and grades appropriate at the graduate or undergraduate levels. For students in the Combined Program, approved undergraduate courses are assigned graduate credit with a conversion rate of 1/3 WPI undergraduate unit = 3 credit hours, while graduate courses applied toward the undergraduate degree are awarded undergraduate credit with a conversion rate of 1 credit hour = 1/9 undergraduate unit. There are some academic departments that allow only 30% or 3 course double counting of credit. Check the graduate catalog for rules pertaining to your program.

Students in the Combined Program may use advanced undergraduate courses to satisfy graduate degree requirements. The department decides which courses may be used in this way. Faculty members teaching these advanced undergraduate courses may impose special requirements, appropriate to an undergraduate course being used for graduate credit, on Combined Program Students.

In many cases, including if the programs awarding the bachelor's and master's degrees are not the same, the program awarding the graduate degree may require that the student's Major Qualifying Project relate in some way to the graduate program's discipline. The graduate program may also make other requirements as it deems appropriate in any individual case. These requirements take the form of a written agreement (obtain Course Selection Form from the Office of Graduate Studies & Enrollment or at www.wpi.edu/+GAO) between the student and the graduate program, which must be completed and filed with the registrar before the student may be matriculated in the Combined Program.

The Combined Program is a full-time program of study. Once admitted to the Combined Program, a student must register every fall and spring semester until the graduate degree is completed. A student in the Combined Program who, during the fall or spring semester, has no registered activities is automatically terminated from the Combined Program, and may only be readmitted to the Combined Program by the Committee for Graduate Studies and Research via petition showing extenuating circumstances. Termination from the Combined Program does not affect a student's ability to continue toward the bachelor's degree.

Some graduate-degree-awarding programs impose additional restrictions on students in the Combined Program. Consult the degree requirements of individual programs for details.

Questions relating to the program should be referred to the discipline department heads or to the Office of Graduate Studies & Enrollment.

FIVE YEAR PROGRAMS

WPI offers unique five year programs in Fire Protection Engineering, Industrial Mathematics and Financial Mathematics. Each program begins with admission to the freshman year at WPI and ends with both a bachelors and masters degree. The master's degree is limited to one of these three programs.

High school students interested in any one of these programs must apply for admission to WPI and indicate on the application which of the 5-year programs they would like. Applicants accepted to the program will receive a letter of admission to both the undergraduate and graduate program at WPI. During the first four years, it is highly recommended that students major in a field closely related to the graduate degree program. For example, most students choosing the Fire Protection Engineering program will have an undergraduate major in Mechanical or Civil Engineering. An academic advisor will assist students in course selection. Admission to the fifth/graduate year is conditional on completion of an undergraduate degree at WPI and in good academic standing.

Particulars about each of the programs are available in the department of Mathematics and Fire Protection Engineering, as well as the Office of Graduate Studies & Enrollment.

OFF-CAMPUS GRADUATE STUDY

In response to the changing needs of technical professional people, WPI offers a growing number of graduate courses at the Westborough and Waltham campus. Off-campus graduate courses can be used in fulfilling degree requirements and residence requirements at WPI.

GRADUATE COURSE LISTINGS

Graduate courses of interest to undergraduate students are listed by title in the "Course Descriptions" section of this catalog. A complete list is included in the graduate catalog. Most courses meet once per week in a fourteen-week format. The credits applied in either case are as shown to the right of the course title. Undergraduate students taking graduate courses may use the conversion factor: 3 credit hours = 1/3 unit. Registration for research or projects is accomplished using an individual program number rather than a course designation.

For more information about WPI's Graduate Programs, please contact:

Office of Graduate Studies & Enrollment

Voice: 508-831-5301

Fax: 508-831-5717

gse@wpi.edu

www.grad.wpi.edu

The complete Graduate Catalog and application form are available on-line through our website.

ADMISSION, EXPENSES, FINANCIAL AID AND HOUSING

S E C T I O N

seven

Admission to WPI	266
Expenses	269
Financial Aid	271
Housing	276

INTRODUCTION

Selection for admission to the college is based upon such factors as candidates' secondary school record; recommendations by counselors and teachers; standardized test scores; out-of-class activities; work experience; and leadership endeavors. All candidates are invited to submit any supplementary material which they believe will aid the Admissions Committee in evaluating their application.

VISITING THE CAMPUS

Through research and reading, you can learn a lot about a college. But the best way to determine if WPI is a good match for you is by visiting the campus. Group Information Sessions and Open Houses are the very best ways to get to know WPI.

The Group Sessions, for which no appointment is needed, are held Monday-Friday at 10:00 a.m., and 2:00 p.m. in the Admissions Office and are followed by a tour of the campus. Group Sessions are also available on selected Saturdays. Please call the Admissions Office for specific dates and times. WPI also sponsors several Open Houses throughout the fall and spring. Campus tours, presentations by academic departments, and sessions on such topics as placement, financial aid and admissions are highlights. All students on our mailing list will receive an invitation to our Open Houses and should register in advance to attend.

Student-led tours of the campus are offered Monday through Friday at 9:00 a.m., 11:00 a.m., 1:00 p.m. and 3:00 p.m. (although tours run on a limited schedule during WPI's term breaks and in the summer). Lunch with a WPI student is also available from 12:00-1:00 p.m., Monday through Friday, while classes are in session. In addition, we will try to accommodate any requests to sit in on classes, meet privately with a faculty member or shadow a current student. A personal interview is one of the best ways to learn more about WPI. It also gives us the opportunity to learn more about you. Interviews are available on campus by appointment only. We schedule interviews between April 1 and December 15. If you would like to schedule a time to meet with one of our Admissions Office members, please contact the office directly. Whatever option you choose, you can arrange for a campus visit by calling the Admissions Office at (508) 831-5286, and our receptionist will be happy to assist you.

QUALIFICATIONS

In order to qualify for admission, candidates must have completed a full secondary school course of study including the following secondary school units:

ENGLISH	4	
MATHEMATICS	4	(including pre-calculus)
LAB SCIENCES	2	

Completion of the required mathematics and science courses in less than four years of study may qualify a student for early admission.

APPLYING TO WPI

Although the vast majority of entering freshmen matriculate in September, WPI will admit freshmen in January. Candidates for the September term should file their application by February 1. Freshman candidates for admission

to the January term should file their applications by November 15.

In our efforts to make applying to WPI as easy as possible, we offer a variety of application options. You can use the traditional paper application form or you can apply on-line via admissions.wpi.edu. The \$60 application fee is required for all applicants. We also accept the Common Application and applications submitted through College View, CollegeLink and ExPAN. For more information on these options, please call the Office of Admissions at (508) 831-5286.

STANDARDIZED TESTS

All candidates are required to take either the College Board tests or the American College Testing Service (ACT) test. If the College Board tests are selected, candidates should take the Scholastic Aptitude Test I (SAT I). These tests should be taken by a date early enough to insure that the scores reach the Office of Admissions by mid-February of your senior year. Candidates should arrange to have their scores submitted directly to the college by either the College Board or ACT. The WPI code number is 3969 for the College Board tests and 1942 for the ACT test.

FINANCIAL AID

Students applying for financial aid should check the appropriate box on the application for admission. Financial aid candidates should submit the College Scholarship Service (CSS) PROFILE Application and the Free Application for Federal Student Aid (FAFSA), which are available online at www.collegeboard.com and www.fafsa.ed.gov. For regular admission applicants, these forms should reach the WPI Office of Financial Aid by February 1. Students applying for Early Action should submit the completed PROFILE to the College Scholarship Service beginning November 15. All financial aid candidates are required to send directly to our office, signed copies of their own and their parents' Federal Income Tax Returns and W-2 Forms from the prior year. Financial Aid is available for U.S. citizens and/or permanent residents of the U.S. A limited amount of need-based financial aid is available for International Students which is administered through the WPI Admissions Office. In order to apply for need based assistance, international students need to complete the College Scholarship Service (CSS) PROFILE Application (www.collegeboard.com) or the Foreign Student Financial Aid Application which may be obtained in the WPI Admissions Office or online at <http://www.wpi.edu/Admin/FA/International/>.

APPLICATION FEE

A \$60 application fee is required for all applicants. WPI endorses the fee waiver policy of the College Entrance Examination Board.

NOTIFICATION

All candidates for admission will receive an acknowledgment of the receipt of their application. Should applicants fail to receive this acknowledgment within four weeks, they are encouraged to check with their high school guidance office or the Office of Admissions at WPI. Admissions decisions will be mailed to all applicants no later than April 1.

DECISION TO MATRICULATE

Accepted candidates must inform the college by May 1, the candidates' common reply date, of their decision to matriculate by returning a \$500 non-refundable tuition deposit along with the Acceptance of Admission Form.

EARLY ACTION

Students may apply to WPI early and receive early notification of their admissions decision under the Early Action plan. The plan is as follows:

1. Candidates should check the early action box on the application.
2. The completed application for admission must be submitted by November 15 for Round 1, or by January 1 for Round 2.
3. The Admissions Committee will review all early action applications and notify all candidates of their decisions by December 15 for Round 1 or by February 1 for Round 2. Early action is a non-binding admissions plan. Accepted students have until May 1 to submit a \$500 non-refundable tuition deposit.
4. Admitted early action candidates who are applying for financial aid will receive notification regarding eligibility for aid soon after their financial aid forms are submitted and complete.

ADVANCED PLACEMENT

WPI awards credit to students who score a score a "4" or "5" on the Advanced Placement Examinations. The Director of Academic Advising will notify such students of their earned credit by mailing an AP letter to the home address during early August. You can visit the Academic Advising web site for a complete list of AP credits for exams taken or call 508-831-5381.

Humanities

For students who do take the examination in one or more of the WPI humanities areas and score a "4" or "5," the university will award advanced placement credit for one course per examination toward the humanities requirement. Soon after arriving on campus, students receiving such credit must speak with an appropriate humanities department advisor about how this credit may be integrated into a thematic program of studies leading to fulfillment of the WPI humanities requirement.

Computer Science

Advanced placement in computer science can be earned by scoring a "4" or "5" on the CS exam. Credit for CS 1000 is granted for the A computer science exam; credit for an additional 1000-level course is granted for a score of "4" or "5" on the AB exam.

Natural Sciences

Students who pass the advanced placement test in Biology, Chemistry or Physics B with a "4 or 5" will be awarded 1/3 unit of advanced placement credit. This credit will show on the transcript as "L". For students who score "4 or 5" in Physics C (Mechanics) will be awarded 1/3 credit in Physics 1110/ 1111. Students who score "4 or 5" in Physics C (Electricity and Magnetism) will be awarded 1/3 advanced placement credit for Physics 1120/1121. For those students who pass Physics B will

be awarded 1/3 credit in Physics 1000. Students who score "4" or "5" in Chemistry will be awarded 1/3 unit for CH 1010. In addition, students are eligible to earn credit for other general chemistry courses, CH 1020-1040, by achieving scores of 70 or better on course-specific examinations offered by the Department of Chemistry and Biochemistry. General Chemistry Credit exams will be given before the start of each term. Please contact the Chemistry Department at 508-831-5371 for information on when the exams will be offered. Note this policy applies only to WPI students.

Mathematics

Students who pass the AB mathematics examination with a "4" or "5" will be awarded 2/3 unit of advanced placement credit for MA 1021 and MA 1022. Students with a "4" or "5" on the advanced placement BC exam will be awarded 1 unit advanced placement credit for MA 1021, MA 1022 and MA 1023.

In the four-course 1021-1024 mathematics sequence, students who arrive at WPI with a one-year high school calculus course, prepared to start with the second (or third) course in the WPI sequence, and who successfully pass that course and the one that follows it in sequence, will be considered to have established advanced placement credit for the first one (or two) courses. To qualify for the credit, the advanced WPI courses must be passed the first time they are available in sequence to the student after matriculation. The courses credited retroactively will be listed by number without an assigned grade and will count toward the distribution requirement in mathematics.

NEW STUDENT ORIENTATION

During the week prior to classes, the Student Activities Office coordinates a comprehensive new student orientation program for all first-year and transfer students. New student orientation provides an introduction to the WPI experience, ranging from academic work and expectations and project-based education, to student life and campus activities. Led by upperclass student team leaders and faculty consultants, new students to WPI attend team meetings that are designed to familiarize them with the overall campus environment.

READMISSION

Students who were formerly at WPI but left before completing undergraduate study, and now wish to apply for readmission, should contact the Registrar's Office for information and forms. Completed readmission forms must be received by WPI no later than the following due dates in order to be acted upon for entrance in the indicated term:

July 15 for Term A	November 15 for Term C
--------------------	------------------------

If possible, candidates should also plan on an interview with the Director of Academic Advising and with a departmental consultant in their intended major area of study prior to filing the readmission form.

TRANSFER STUDENTS

The WPI Plan provides some advantages that are particularly attractive for transfer students. Transfer applicants should furnish an autobiographical statement and Math/Science teacher recommendations in addition to the appli-

cation for admission. The deadline for receipt of applications for entrance in September is April 15. The deadline for admission for January entrance is November 15. Applicants are encouraged to submit their applications as early as possible.

All transfer students are required to spend at least two years as full-time registered students. For more details on transfer admission, see WPI's web site under Admissions.

TRANSFER AGREEMENT

WPI currently holds formal articulation agreements with specified programs of study at both Bristol Community College and Quinsigamond Community College. However, WPI will grant appropriate transfer credit on a case-by-case basis from any properly-accredited two-year or four-year institution.

HUMANITIES AND ARTS REQUIREMENT FOR TRANSFER AND 3-2 STUDENTS

All transfer and 3-2 students should review their humanities and arts record and plan with the Humanities and Arts Department's coordinator for transfer students (J. Hanlan - SL23), who will determine for students the transfer credit applicable towards the Sufficiency.

All transfer and 3-2 students entering WPI with fewer than two units of humanities and arts credit must complete thematically related work in humanities and arts at WPI, including a Sufficiency evaluation (Independent Study/Project) to the extent that the overall humanities and arts credit totals two units. The humanities and arts requirement is considered fulfilled for transfer students who have completed the equivalent of two units of humanities and arts work prior to their matriculation at WPI or 3-2 students who have or will complete the equivalent as part of their degree program at the cooperating college. Please refer to the section "Transfer Students and the Sufficiency Requirement" for a description of how Sufficiency grading is determined for transfer students who believe they have completed requirements.

A Completion of Degree Requirement form must be submitted in order for the Sufficiency to be recorded. The student must be registered for at least 1/6 of a unit in the same activity in the term in which the Completion of Degree Requirement form is submitted, or the student will be required to pay the usual recording fee. (This registration is in addition to any transfer credit awarded. As the Completion of Degree Requirement form is usually submitted during a term in which the student is full time, normally no extra charges are incurred.)

The following exception to this policy exists: Transfer and 3-2 students who receive a grade for the Sufficiency based on work completed at another school and who submit the Sufficiency Completion of Degree Requirement form as part of the transfer-credit posting process will have the Sufficiency Completion of Degree Requirement form and grade recorded without a fee. This process will normally take place prior to or during the first term of full-time enrollment at WPI.

INTERNATIONAL STUDENTS

The presence of international students serves as a means of strengthening the knowledge and understanding of foreign countries and cultures and is highly encouraged and supported at WPI. Programs and support services for international students and exchange programs are given high priority. As an institution of higher learning, WPI is dedicated to international education.

In addition to the standardized tests listed above, international applicants must provide proof of English language proficiency. English language proficiency may be demonstrated by the official results of:

- TOEFL (Test of English as a Second Language)–
Minimum score: 550 (213 electronic form or 79 internet based)
- IELTS (International English Language Testing System) 6.5 or higher with no band below 6.0.

International students whose score results are less than those above may still be conditionally admitted, with required attendance at WPI's English as a Second Language Program during the summer prior to enrollment.

THE ENGLISH AS A SECOND LANGUAGE (ESL) PROGRAM

The **ESL Summer Institute** is an intensive five-week non-credit course of study in English for specific purposes for conditionally-admitted international students and others whose first language is not English. This ESL program is designed to help prepare these international students for regular courses in engineering, science and technology before the regular academic year begins. A second intake is available for international students who desire only a head-start in preparation for such courses before the academic year begins.

For students who need additional support during the regular academic year, the **ESL Seminar**, a tutorial course designed to help the student further strengthen linguistic skills is offered.

During the regular academic year, *ESL for Spouses* is a non-credit course offered to interested partners accompanying WPI students and professors.

A TOEFL Preparation course is also offered during Terms C and D.

ESTIMATED EXPENSES

The expenses for a year at WPI will vary with each student. Expenses for the 2005-06 year are as follows:

Tuition	\$30,990
Social Fee	200
Health Fee	200
<hr/>	
Total Tuition and Fees	\$31,390
Room (Typical Freshman Double)	5,500
Board (7-Day, 19-Meal Plan)	4,200
Books and Supplies (Estimated)	735
New Student Fee	200
<hr/>	
	\$42,025

Health insurance is required for all students. If coverage is not through a parental plan, student health insurance is available at a projected cost of \$864 for the 2005-06 academic year. The health insurance plan is *mandatory* for international students.

Basic tuition entitles full-time students to full academic and student services including counseling, placement and recreational facilities. Other costs must be anticipated, such as laundry, clothing, travel expenses, entertainment and personal expenses.

SPECIAL STUDENT

1/3 unit	\$2,583.00
1/6 unit	\$1,291.50
1/12 unit	\$ 645.75

PAYMENT OF TUITION DEPOSIT

ENTERING STUDENTS

Payment of a nonrefundable \$500 deposit is required upon acceptance of admission to WPI. The \$500 will be credited as follows: \$250 to the student's tuition in the first term and \$250 toward the bill for housing. If housing is not needed, then the full \$500 is credited to the tuition bill for the first term.

Information about deferred tuition payment plans offered by commercial firms is available from the WPI Accounting Office.

ENROLLMENT AND TUITION DUE DATES

Enrollment for students pursuing a baccalaureate degree will occur three times per year:

1. Fall semester—at the beginning of Term A.
2. Spring semester—at the beginning of Term C.
3. Summer session—at the beginning of Term E.

There will be no enrollment at the start of Terms B and D, although a course change period will be available for students continuing from the previous term.

Special tuition features relative to Term E enrollment will be described in the Summer Session catalog.

Dates upon which semester tuition fees are due are listed in the WPI Chronology of Academic Schedule and Events on the inside front cover of this catalog.

OVERLOAD CHARGES

1. There will be a tuition surcharge on registration which contains academic overloads in excess of 2 1/2 unit per semester.
2. Neither physical education or military science will be included in the determination of overloads.
3. The overload charge will be based upon the total registration credit held by the student at the close of the initial change period each of the two terms of that semester. Students will be subject to the appropriate overload charge in effect at the time. (Please consult the Projects and Registrar's Office or the Accounting Office for current fees.)
4. Fall overload billing will take place during Term A and spring overload billing during Term C.
5. The current Term E charge system will not be affected.

FULL-TIME STUDENTS TUITION CHARGES UPON WITHDRAWAL OR SUSPENSION

Charges upon formal withdrawal from the college during each semester are:

	Charge
1. Withdrawal after enrollment but prior to first day of classes of the first term of a semester.	\$100.00
2. Withdrawal within one week following first day of classes of the above term.	20% of tuition
3. Withdrawal within two weeks following first day of classes of the above term.	40% of tuition
4. Withdrawal within three weeks following first day of classes of the above term.	60% of tuition
5. Withdrawal prior to Course Change Day of the second term of a semester.	80% of tuition
6. Withdrawal on or after Course Change Day of the second term of a semester.	100% of tuition

To qualify for a reduction in charges, students must submit a formal withdrawal application via the Projects and Registrar's Office. The date this application is received in the Projects and Registrar's Office will determine the charge.

There is no reduction in charges in the case of withdrawal from individual courses.

Students who have paid full tuition for eight semesters may be allowed to enroll as special (part-time) students on a per-course basis and be charged tuition accordingly. (Two summer terms enrolled as a full-time student may be counted as a semester.) Application forms for Special Student status are available at the Projects and Registrar's Office.

A late fee ranging from \$25 to \$50 is assessed for payment of bills and registration after the specified dates.

SPECIAL (SU, SX) STUDENTS TUITION CHARGES UPON WITHDRAWAL

During the regular academic year (Terms A, B, C and D), withdrawal will result in charges being reduced in the following manner for special students in seven-week courses:

	Charge
1. Withdrawal before the third scheduled class.	\$25.00
2. Withdrawal after the third class but during the first week of class.	25% of tuition
3. Withdrawal during the second week of class.	50% of tuition
4. Withdrawal during the third week of class.	75% of tuition
5. Withdrawal after the third week of class.	100% of tuition

Withdrawal of SU and SX students from 14-week courses will follow the current policies of the Projects and Registrar's Office.

ROOM CHARGES UPON WITHDRAWAL OR SUSPENSION

	Charge
1. Withdrawal after enrollment, but prior to the first day of classes. (Forfeiture of advance payment.)	\$100.00
2. Withdrawal after the first day of classes.	100% charge of room fee

BOARD CHARGES UPON WITHDRAWAL OR SUSPENSION

	Charge
1. Withdrawal after enrollment, but prior to the first day of classes.	No Charges
2. Withdrawal within four weeks following the first day of classes.	25% of board fee
3. Withdrawal within eight weeks following the first day of classes.	50% of board fee
4. Withdrawal within twelve weeks following the first day of classes.	75% of board fee
5. Withdrawal after twelve weeks following the first day of classes.	100% of board fee

FINANCIAL AID UPON WITHDRAWAL/ SUSPENSION

Federal regulations for a student receiving federal financial aid funds require repayments to the fund from excess credit when a student withdraws or is suspended during a semester. Health insurance, health fee, and social fee are neither prorated nor refunded. Federal funds are returned in the following order based on federal guidelines: Unsubsidized Federal Stafford Loan, Subsidized Federal Stafford Loan, Perkins Loan, Federal PLUS Loan, Federal Pell Grant, and Federal Supplemental Educational Opportunity Grant. WPI scholarships and institute loans are reduced up to the amount of remaining credit sources.

WPI is committed to assisting students and their parents in finding ways to finance the cost of a WPI education through financial aid assistance and private financing options. Central to WPI's program is the concept of financial need; based on the assumption that parents and students together accept the responsibility for educational expenses to the extent they are able. Over 81% of WPI undergraduates are receiving financial help from federal, state, and institutional resources. A combination of grants, loans and work study assistance from federal, state and WPI funding are allocated to students who demonstrate financial need. The proportion of grant, or "gift" assistance, versus loan and work, may be determined by the college on the following criteria: the magnitude of the financial need, the student's academic performance, and the availability of funds.

APPLICATION PROCEDURES

Students are required to file the Free Application for Federal Student Aid (FAFSA) and the CSS (College Scholarship Service) PROFILE Application. Students need to list WPI's Code # under the section on each form where you designate which schools are to receive the form. In addition, students and their parents need to send to the WPI Office of Financial Aid a signed copy of their federal income tax forms (or a statement signed by the student/parent indicating he/she will not file a return), schedules, and W-2 statements from the prior year. In the case of separation or divorce, the student's noncustodial parent must complete the Noncustodial PROFILE.

EARLY ACTION APPLICATION FOR FINANCIAL AID

You must indicate on your admission application that you are applying for financial aid. For those students applying for early action admission, the CSS PROFILE Application and Noncustodial PROFILE (if applicable) can be submitted between November 15th - February 1st.

The FAFSA and the CSS PROFILE Application are available online at www.fafsa.ed.gov and www.collegeboard.com. All federal income tax return forms, as outlined above, are required as soon after January 1 as possible, as well as completion of the FAFSA. No award decision is final until all material is received and reviewed.

Successful candidates for early action admission will be notified of financial aid eligibility on a rolling basis. You will then have from the date of your aid eligibility letter until the candidates' common reply date, May 1, to either accept or decline the aid offered.

REGULAR DECISION APPLICATION FOR FINANCIAL AID

You must indicate on your admission application that you are applying for financial aid. Successful candidates for admission will be notified of a financial aid decision in early April. You will then have from the date of your aid decision until the candidates' common reply date, May 1, to either accept or decline the aid offered.

To ensure a complete review, we must receive the FAFSA and the CSS PROFILE Application by February 1. Applications completed after this date will be reviewed subject to funds available. We suggest you complete the FAFSA and the CSS PROFILE Application and Noncustodial PROFILE (if applicable), by the beginning of January to ensure you meet WPI's filing deadline of February 1.

UPPERCLASS APPLICATION FOR FINANCIAL AID

Upperclass students who received need based financial aid must reapply for financial aid every year by completing the FAFSA and the WPI Upperclass Application. In a few cases, some upperclass students will also be required to submit the CSS PROFILE Application in addition to the FAFSA and WPI Upperclass Application. Typically, upperclass students who will need to complete the CSS PROFILE Application are those whose parents are recently separated or divorced, students who are re-admitted to WPI, students whose custodial and noncustodial parents have changed since the prior academic year, and students who did not apply for need based financial aid in the prior academic year. The WPI Office of Financial Aid reserves the right to request that a CSS PROFILE Application be completed by any upperclass student applying for need based financial aid.

The WPI Upperclass Application and filing information on the FAFSA and CSS PROFILE Application will be available at the beginning of Term C and are due by the beginning of Term D. The complete application packet covers grants, scholarships, loans and on-campus employment for the following academic year. Students and their parent(s) are expected to obtain and submit all requested forms in a timely manner for each year of planned enrollment. If any of the required forms are submitted late, the student may see a reduction in his/her grant or scholarship eligibility for the year in which he/she is applying for need based financial assistance. The amount of financial aid upperclass students receive will depend on their family's demonstrated financial need which is determined from the FAFSA, the WPI Upperclass Application and the CSS PROFILE Application (if required).

TRANSFER STUDENTS

Transfer students may apply for financial aid eligibility beginning with their first term of matriculation, and must indicate interest in financial aid on the admission application. Transfer aid applications will be reviewed based on the same documentation required for first year applicants and are packaged on a funds available basis.

FORMS OF AID

FEDERAL PELL GRANTS

Federal Pell Grants are awarded to high need students from low and lower middle-income families. These grants range from \$400 to \$4,050 per academic year. A Student Aid Report (SAR) is sent to all students who file a Free Application for Federal Student Aid (FAFSA). The WPI Financial Aid Office will verify the data on the form, and make corrections if necessary. In 2004-05, WPI administered over \$1.0 million in Federal Pell Grant funds to eligible full and part time students.

FEDERAL SUPPLEMENTAL EDUCATIONAL OPPORTUNITY GRANTS (FSEOG)

Federal SEOG funds are allocated to institutions by the Federal government. These funds, which are awarded to students as campus based grants, are awarded to high need students who are also eligible for the Federal Pell Grant. WPI students received over \$700,000 in Federal SEOG funds in the 2004-05 academic year.

FEDERAL STAFFORD STUDENT LOAN

Student Federal Stafford Loans are federally subsidized student loans; interest accrued is paid by the federal government while the student is enrolled at least half time. Repayment of both principal and interest begins at the end of the 6 month "grace period" following the last day of enrollment or withdrawal from school. The repayment period is ten years and the interest rate is set at the bond equivalent rate of 91 day Treasury bills (as of the preceding June) plus 2.3%, capped at 8.25%. Approximately 3%-4% in origination and guarantee fees are deducted by the bank before the proceeds are disbursed to the school.

Students must file a FAFSA so that WPI can determine need-based eligibility for the Federal Stafford Loan. The Federal government sets annual borrowing limits according to the student's year in school or grade level. First year students may borrow up to \$2,625, second year students up to \$3,500 and third and fourth year students up to \$5,500. Students cannot borrow in excess of \$23,000 over the life of their undergraduate education.

Students not eligible for the subsidized Stafford Loan may borrow through the unsubsidized Federal Stafford Loan Program. In the unsubsidized Stafford Loan Program, the federal government does not pay the interest accrued while the student is enrolled. The student has the option to capitalize the interest and postpone repayment of principal and interest until after graduation or withdrawal from school.

The WPI Office of Financial Aid recommends and approves the amount a student may borrow for the subsidized and unsubsidized Federal Stafford Loan. For all new borrowers, the WPI Office of Financial Aid will obtain a Master promissory note and forward it to the student. The student must complete, sign and return the promissory note to our office. The Master promissory note only needs to be signed once during the student's undergraduate time at WPI (if you continue on to gradu-

ate school at WPI, you do not need to sign a new MPN). If you are a previous borrower with an out-of-state lender and you have not completed a Master Promissory Note, you must obtain and complete a Master Promissory Note from the lender you borrowed from last year and forward it to the WPI Office of Financial Aid for processing.

All new WPI students (first year, transfer & graduate) must complete a Master Promissory Note at WPI.

FEDERAL PERKINS LOAN

Federal Perkins Loans are also federally subsidized loans awarded directly to students by colleges. Students are awarded based on funds available. Repayment of both principal and interest, currently 5% fixed, begins nine months after the recipient's last day of enrollment or withdrawal from college. Perkins Loan promissory notes are signed at the beginning of each semester. In 2004-05 WPI administered over \$2.0 million in Federal Perkins Loans.

FEDERAL WORK STUDY PROGRAM

Federal Work Study funds are allocated annually to colleges who offer federally funded work opportunities to high need financial aid applicants. Federal Work Study is included in the financial aid eligibility letter to students. If you accept a Federal Work Study offer, you may work a maximum of 10 hours per week at the current wage of \$8.00 per hour. Federal Work Study earnings are paid by check on a bi-weekly basis directly to the student employee.

Work is available in a variety of academic and administrative settings on campus. The amount offered indicates maximum earnings allowed, but is not a guarantee. The best procedure is to take an available position at the start of the academic year and work as much as your schedule allows up to the maximum 10 hours per week. If you decline an offer of work, it will not affect the other components of your award package. However, please note that due to limited funding, if you decline your Federal Work Study job, you will not be offer these funds in future academic years.

Students are prohibited from Federal Work Study employment if one of the following situations occurs: if the student falls below the WPI established satisfactory progress levels for retention of aid; or the student enrolls on a less than full time basis; or the student registers as a "Special Student."

STATE SCHOLARSHIP PROGRAMS

WPI administered over \$200,000 from the MASSGrant Program during the 2004-05 academic year. The MASSGrant is awarded to Massachusetts residents whose combined family contribution falls within state-determined parameters. Students must file the FAFSA by the state-designated deadline and follow all state program procedures to apply.

Massachusetts has reciprocity agreements with six other states: Connecticut, Maine, New Hampshire, Pennsylvania, Rhode Island and Vermont. These states allow their residents attending institutions in Massachusetts to "carry" need-based state grants into Massachusetts.

Grants from all reciprocal states to WPI students last year totaled \$135,000. Awarding from other state scholarship programs depends on annual state funding levels. The Massachusetts Gilbert Matching Grants Program is allocated annually to WPI. These funds are awarded to Massachusetts residents who fall within a certain financial need. WPI students received over \$740,000 in the Massachusetts Gilbert Matching Grant during 2004-05.

STATE FUNDED STUDENT LOAN PROGRAMS

The Commonwealth of Massachusetts provides the Massachusetts No Interest Loan (MA NIL) Program through annual allocations to participating colleges and universities. Students who file the FAFSA and meet state eligibility criteria are eligible for the Massachusetts No Interest Loan on a funds available basis. WPI administered \$162,500 in the MA NIL program in 2004-05.

WPI COLLEGE SCHOLARSHIP

WPI awards College Scholarships and other restricted or endowed "gift" assistance, to students who have a demonstrated financial need based on review of the complete financial aid application, including the FAFSA, the CSS PROFILE Application, IRS tax returns, W-2 forms, and the WPI Upperclass Application. WPI gift aid may be combined with federal and state grants to make up a student's total portion of "gift" assistance, before loans and work are packaged. Grants and scholarships funded directly by WPI exceeded \$28 million in 2004-05.

WPI INSTITUTE STUDENT LOAN PROGRAM

WPI offers a need-based loan similar to the Federally subsidized Stafford and Perkins loans. Students do not begin repayment of the principal and interest accrued until 9 months after the last day of enrollment or withdrawal from college. WPI students borrowed \$1.5 million in Institute Loans during 2004-05. The Institute Loan terms and eligibility criteria are similar to the Federal Perkins Loan Program.

WPI DEPARTMENT-FUNDED WORK PROGRAM

Students who are not eligible for Federal Work Study funds may seek employment opportunities through departments or offices on campus that set aside funds for hiring undergraduate employees. These employment funds vary from year to year in terms of monies available or the number of students allowed per department/office. Students may also inquire about department-funded summer positions on campus.

RESERVE OFFICER TRAINING CORPS (ROTC) SCHOLARSHIPS

ARMY ROTC SCHOLARSHIP PROGRAM

The Army ROTC scholarship program offers financial assistance to outstanding students who meet the rigid standards of the Scholar, Athlete, Leader attributes and have a strong desire and commitment to serve their country as commissioned Army officers. Scholarships are awarded based upon student merit, not financial need.

Potential college freshmen may apply for 4-yr scholarships early in the college search process on-line through

the U.S. Army Cadet Command website, www.armyrotc.com or by contacting the Army ROTC office at WPI. In many instances high-quality students who enter the program after their freshmen year may earn 3-yr scholarships based upon their academic, athletic and leadership potentiality.

NAVAL ROTC SCHOLARSHIP PROGRAM

Programs leading to a commission in the United States Navy or Marine Corps are available for all qualified WPI students through cross-enrollment at the College of the Holy Cross.

WPI students may participate in the four-year or two-year national Naval ROTC Scholarship Program.

Students interested in Navy ROTC should either write to the Naval ROTC Unit, College of the Holy Cross, Worcester, Massachusetts 01602, or call (508)793-2433.

AIR FORCE ROTC SCHOLARSHIP PROGRAM

WPI students may participate in the four- or two-year Air Force ROTC programs conducted at WPI where the AFROTC offices are located. The AFROTC programs, which are voluntary and open to all students, lead to a commission as a Second Lieutenant in the U.S. Air Force.

Students interested in AFROTC should write to the Department of Aerospace Studies, AFROTC Detachment No. 340, WPI, Worcester, Massachusetts 01609-2280. Offices are located at 35-37 Institute Road.

FINANCIAL AID POLICIES

Financial aid is awarded one year at a time. Aid applicants are required to reapply annually by the beginning of Term D. An annual review of each applicant's financial need is assessed to assure that aid is renewed equitably as different circumstances cause needs to change. The WPI Office of Financial Aid determines a student's financial need through a review of the complete financial aid application and appropriate IRS forms. Financial aid eligibility letters are mailed to upperclass students in early July for the following academic year.

STUDENT CONTRIBUTION

It is expected that the student's family will contribute its maximum financial effort and that the student will also make a maximum effort through savings from annual earnings and by accepting a proportion of financial aid in the form of loans and/or in-school employment, if eligible. Students at WPI are expected to contribute a minimum \$2,000 each academic year, from summer or other annual earnings. While this minimum student contribution is used, the WPI Office of Financial Aid must review previous calendar year student earnings and student savings/ assets as the basis for determining the annual student contribution.

INDEPENDENT/DEPENDENT STUDENT STATUS

WPI believes that the primary responsibility for an undergraduate education lies with the student and parent, to whatever extent possible. Therefore, all undergraduates applying for WPI institutional funds are required to provide parental information regardless of federal dependency status.

Although you may meet federal guidelines to be considered an independent student, and therefore receive federal funds as an independent student, the ability of parents to assist their children, regardless of age and dependency status, is a factor WPI considers in determining eligibility for institutional need-based grants. Because of this, the WPI Office of Financial Aid will require parental information (including federal income tax returns, schedules, and W-2 statements) from all students applying for need based institutional aid.

AID RETENTION / PROGRESS TOWARD A DEGREE

There are four key elements to the retention of eligibility for financial aid as it relates to academics:

1. All full time students are expected to take twelve 1/3 unit classes per academic year. The more classes a student successfully completes (up to a maximum of twelve courses) during terms A-D, the more the student's grant/scholarship eligibility is assured for the next academic year. Attempting but not successfully completing courses and project work will reduce financial aid. Please note that incompletes, advanced placement, or other transfer credit cannot be counted in the determination of units completed. The student is responsible for resolution of incompletes with the faculty member assigning the grade.

Please also note that need based WPI scholarships awarded to students will not increase in future academic years; regardless of increases in financial need. Conversely, students' need based WPI scholarships can decrease based on a lower family financial need and/or poor academic performance in the prior academic year. Because of this, it is extremely important that students monitor the number of classes they pass each academic year.

2. Eligibility for consideration for all types of aid* for the following academic year is lost if a student is on Academic Probation at the end of Term D (Spring Semester); first year students who fail to earn any academic credit during their first two terms (Fall semester) will lose eligibility for all types of financial aid beginning with their next semester (Spring semester).

*Includes all of the following:

- State Scholarship/Grants
- Federal Pell Grant
- Massachusetts No Interest Loan
- Federal Supplemental Opportunity Grant
- WPI Scholarships, Grants, & Loans
- Federal Perkins Loan
- WPI ROTC Room Credit
- Federal Subsidized/Unsubsidized Stafford Loan
- WPI ROTC Board Credit
- All Parental & Auxiliary Loan Programs
- All on-campus employment

Petitions: A student failing to meet the eligibility requirements may, in cases which involve unusual and extenuating circumstances such as documented medical problems, file a petition with the Office of Financial Aid. The petition will be reviewed by the Financial Aid Appeal Committee, which is comprised of academic administrators (not members of the Office of Financial Aid). Determination will be made concerning eligibility on a case by case basis.

3. Regardless of academic progress status, eligibility for financial assistance (with the exception of Federal Stafford Loans), is available for the shorter of the two following periods: 16 terms (4 years) of enrollment or completion of your Bachelor Degree requirements at WPI.
4. If you receive grants/scholarships, loans of all forms and work study, you must be registered as full-time. You are charged tuition based upon full time status, and that serves as the basis for annual financial aid eligibility determinations.

You are responsible for knowing your status and working with an academic advisor to register for the necessary units to maintain eligibility for financial aid.

PLEASE NOTE: With the exception of Federal Stafford Loans, financial aid is not available for enrollment during Term E (Summer School) at WPI. This includes all forms of assistance including merit-based scholarships. Note also, that if you attend Term E and borrow from the Federal Stafford Loan Program, the amount you borrow for your next academic year is reduced by the amount borrowed during Term E.

GRADUATE

The Federal Stafford Loan is the only source of need-based aid administered by the WPI Office of Financial Aid to graduate students. In order to apply for this loan, graduate students must complete the FAFSA (www.fafsa.ed.gov) and a Graduate Student Application which can be obtained at <http://www.wpi.edu/Admin/FA/Grad/gsa.html>.

INTERNATIONAL STUDENTS

International students, who do not have official documentation of Permanent Residence in the United States, are ineligible for all sources of financial aid administered by the WPI Office of Financial Aid. Limited scholarships are available for entering international students through the WPI Admissions Office.

ALTERNATIVE FINANCIAL PROGRAMS

Alternate financing programs are available to many families who do not apply for aid or who need additional resources beyond federal, state, and institutional financial aid offered. Several payment plans are available, which allow families to pay their annual charges over several months, rather than in two semester payments. You can contact the WPI Accounting Office for further information about payment plan brochures and applications. The following three long-term financing programs assist families in spreading educational costs over 10 to 20 years. The three loans below allow families to borrow the difference between the cost of attendance determined by the college and total financial aid for the year. Please contact the WPI Office of Financial Aid for additional information about the loans explained below, as well as other financing options.

FEDERAL PLUS LOANS

Federal PLUS Loans are available annually to parents of dependent undergraduates. Repayment begins when the funds are advanced, and parents have 10 years maximum to repay. The interest is calculated on a variable rate based on the average 52 week Treasury bill rate plus 3.1%, capped at 9%. Parents should apply for the PLUS loan online at American Student Assistance www.amsa.com. The parent can choose a lender and electronically sign their Master Promissory Note. The process requires approximately four to five weeks to complete before funds are disbursed to the school for payment.

THE MASSACHUSETTS EDUCATIONAL FINANCING AUTHORITY (MEFA)

WPI is a participant in MEFA, a not-for-profit, state authority serving students enrolled in the Commonwealth's accredited institutions. The Authority, in cooperation with WPI and other participating colleges and universities, offers a number of loans, under which parents and students can borrow up to cost less aid and repay it in low monthly payments. Parents have an option of a variable or fixed rate. Parents may be eligible to secure the loan with the Home Mortgage Option, using either interest

rate option. The variable rate option carries a 10 year repayment limit, and the fixed rate has a 15 year limit. Borrowers must be citizens of the United States. The MEFA Loan programs outlined above are described on MEFA's website www.mefa.org. Families can apply online or contact MEFA directly at 1-800-449-MEFA. Processing can take several weeks from approval to final disbursement. A credit check is performed to determine whether the borrowers' debt-to-income ratio lies within the approved limit.

CITIBANK'S CITIASSIST LOAN

The Citiassist Loan is offered to students with creditworthy cosigners. Eligible students may borrow a maximum loan of no more than cost of attendance less financial aid awarded. While students do not have to be U.S. citizens or permanent residents of the U.S., cosigners must be. The interest rate of the Citiassist Loan is equal to the current prime rate plus .25%. Borrowers have the option of deferring both principal and interest while enrolled in school. Interest will accrue under this option. The repayment period for a Citiassist Loan is 12 years. Applications may be obtained from the WPI Office of Financial Aid or students can apply online at www.studentloan.com.

SALLIEMAE'S SIGNATURE LOAN

The Signature Loan is offered to students with creditworthy cosigners. Eligible students may borrow a maximum loan of no more than cost of attendance less financial aid awarded. While students do not have to be U.S. citizens or permanent residents of the U.S., cosigners must be. The interest rate of the Signature Loan is equal to the current prime rate minus .5% - prime plus 4.5% (depending on credit). Borrowers have the option of deferring both principal and interest while enrolled in school. Interest will accrue under this option. The repayment period for a Signature Loan is 15-25 years. Applications may be obtained from the WPI Office of Financial Aid or students can apply online at www.salliemae.com.

RESIDENCE HALLS

WPI provides its undergraduate students with a variety of housing options, both on and off campus. The WPI residence halls offer students a choice of single, double, and triple occupancy rooms as well as suites designed for four and six persons, and two- to seven- person apartments. In addition, WPI owns and staffs four houses located just a short walk from the campus. Off-campus housing alternatives include rooms in homes, apartments, fraternity/sorority living, and commuting from home.

Residence hall living at WPI offers opportunities that can be a valuable part of higher education. For this reason, on-campus housing is guaranteed to all first-year students who request it by June 1 as stated in their admission letter. First-year students admitted for Term A are guaranteed housing in the residence halls for that entire academic year.

Upperclass students may apply for those residence hall spaces not reserved for incoming first-year students. The Housing and Food Service Contract is a legally binding contract which extends from the beginning of Term A through Term D as long as the student is enrolled at WPI.

RESIDENCE HALL STAFF

Student Hall Directors (SHDs) and Resident Advisors (RAs) are the core of the residential life staff in the residence halls. RAs serve as a source of assistance in resolving students' academic, personal, and social concerns. They plan and implement social and educational programs in the halls, and enforce all WPI policies and regulations in an effort to develop an effective living-learning environment in the residence halls.

The administrative responsibility for the operation of the residence halls rests with the professional staff in Residential Services. They counsel and advise students, work with maintenance and dining hall staffs, and handle many administrative processes for students living on campus.

OCCUPANCY

Residence halls *normally* open at 9:00 a.m. four days before Term A begins and close at 12:00 noon on the day following the last day of classes for Term D. Housing and food service privileges are not transferable, nor may any person take up *de facto* residence without paying rent. The residence halls will be closed during the December recess period.

FURNISHINGS AND FACILITIES

Students are responsible for the neatness and cleanliness of their rooms. Residence halls are furnished with a twin-size bed, a desk and chair, closet space, and drawer space for each student. All residence halls are smoke free environments and all buildings have complete sprinkler systems in all student bedrooms and common areas. Data network services, telephone, and cable television are included in room rates. Residents provide their own pillows, linens, blankets, and other personal furnishings. Coin-operated laundry facilities are available at four locations on the campus.

The following are not permitted in the residence halls:

- Sale, use or possession of illegal drugs
- Pets, except small fish
- Refrigerators larger than 4.3 cubic feet in size
- Gambling
- Use of alcoholic beverages in violation of Massachusetts State Laws
- Firearms, weapons, explosives, incendiary or toxic chemicals, starting pistols, paint ball guns
- Cooking, except in kitchen areas provided
- Candles or other flame-emitting devices
- Lofts
- Smoking

Mail and express packages should be addressed to the student by name, and box number, WPI, 100 Institute Road, Worcester, MA 01609-2280.

ROOMMATES

One of the most memorable aspects of campus life can be the relationship you will build with your roommate(s). Roommates often find that a meaningful relationship is developed through the sharing of thoughts and feelings; in other words, communication. We encourage you to be as open as possible so that you and your roommate can begin early to create a relationship based on respect and understanding. This relationship can help make residence hall living one of the most enjoyable part of your college career.

ROOM CHARGES

Since room and board rates for 2005-2006 were not established at the time of this publication, they will be announced separately.

Room rental rates for 2004-2005 were as follows:

	Double Occupancy Triple Occupancy	Single Occupancy
Morgan Hall	\$5,288	\$5,810
Daniels Hall	5,288	—
Institute Hall	5,288	5,810
Sanford-Riley	5,288	5,810
Stoddard Complex	5,288	5,810
25 Trowbridge House	5,288	—
22 Schussler	5,288	—
26 Hackfeld House	5,288	5,810
16 Elbridge	5,288	5,810

Ellsworth/Fuller Apartments	Two- Person	Three- Person	Five- Person	Seven- Person
	\$5,886	\$5,554	\$5,258	\$4,780

Founders Hall

All Double	\$5,650
All Single	6,116

Note: Each apartment is equipped with basic furnishings including stove and refrigerator.

Payment for housing and food service fees are made in two installments, one each at the beginning of Terms A and C. Reduced charges, if applicable, will be processed according to the established withdrawal policy of the college. Students entering the residence halls other than at the beginning of Term A or C will be issued a prorated billing for the period. This bill must be paid in full prior to occupancy.

As part of the room charges for the first term of residency, the student is assessed a \$150 damage deposit. Students are expected to care for the physical facilities of the residence halls. Damage to the facilities beyond the normal wear and tear shall be the financial responsibility of the residents. The security deposit, less any outstanding charges, will be credited to the students account and appear as a credit on their next bill.

First-year students can expect to receive a Housing and Food Service Contract in early May, after their \$500 tuition deposit is received by the Office of Admissions. On this contract, they will indicate their room preference for the residence halls.

All students wishing to live in the residence halls must submit a signed WPI Housing and Food Service Contract.

MEALS

All residence hall students (with the exception of Fuller / Ellsworth apartment residents) are required to participate in one of the four meal plans. The MEALS PLUS PLANS are a combination of traditional meal plans plus additional funds to be utilized at the students discretion.

Once a student has contracted for food service, the commitment remains in effect through the remainder of the year. This is a legally-binding agreement, and students are obligated to assume financial responsibility for the entire academic year.

Rates for the 2004-05 academic year were:

19-Meal PLUS	\$4,120
14-Meal PLUS	\$4,120
The 190	\$3,880
The VIP Pass	\$4,800

OFF-CAMPUS LIVING

After the first year, on-campus housing may be at a premium; so if you decide to look for an off-campus apartment, make plans well in advance. Residential Services, located in Ellsworth 16, can be a valuable resource for you as you begin your search for off-campus housing. Residential Services maintains a listing of available housing in the Worcester area, as well as an on-line apartment finder system which can be accessed through the department's web page. In addition, information is available for you to research questions about small claims court, housing codes, leases, tenants rights, etc. The following are a few hints for you as you begin your search for off-campus housing.

Leases: Contract periods for off-campus housing vary in length, from twelve-month and nine-month to summer only and three-month leases. As you consider various places, find out what types of leases are available.

Looking: Check bulletin boards around campus for apartment ads. Also watch *Tech News* classifieds. In addition, the Residential Services Office maintains a listing of available off-campus housing.

Be Prepared: You'll want to plan realistically for expenses such as utilities, transportation, repairs, laundry, and food. Also, try to pick your roommates carefully and ahead of time.

TRUSTEES, ADMINISTRATION AND FACULTY

S E C T I O N
eight

Trustees	279
Administration	282
Faculty	291
Faculty Emeriti	301
Index	305
Accreditation	309
Policies & Practices	309
Currency of Information	310
Directions	310
Campus Map	IBC

TRUSTEES

The administration of the college is entrusted to a Corporation consisting of not less than 12 members, consisting of life, ex-officio, at-large and alumni members. Emeriti members are elected by the Corporation in an advisory capacity. (Dates in parentheses following each name indicate year of election to membership.)

OFFICERS OF THE CORPORATION

DONALD K. PETERSON '71.
Chairman

STEPHEN E. RUBIN '74
Vice Chairman

DENNIS D. BERKEY
President and CEO

JEFFREY S. SOLOMON
*Vice President for Finance and CFO, and
Secretary and Treasurer of the Corporation*

DANIELLE L. COVE
Associate Treasurer

FRANK P. CONTI
Assistant Secretary

AT LARGE MEMBERS

PAUL W. BAYLISS '60 (1989)
Topsham, ME

CURTIS R. CARLSON '67 (2002)
President and CEO
SRI International
Menlo Park, CA

RICHARD F. CONNOLLY, JR. (2005)
Senior Vice President, Investments
UBS Financial Services
Boston, MA

WARNER S. FLETCHER (1994)
Fletcher, Tilton & Whipple, P.C.
Worcester, MA

ROBERT A. FOISIE '56 (1993)
West Hartford, CT

JOHN J. GABARRO '61 (1987)
UPS Foundation Professor
Harvard Business School
Boston, MA

CLAIRE L. GAUDIANI (2001)
Heyman Center for Philanthropy
New York University
New York, NY

PETER H. HORSTMANN '55 (1984)
Retired
New York Times Co.
Worcester, MA

M HOWARD JACOBSON (1977)
Westborough, MA

JOHN L. LaMATTINA (2001)
Vice President, Pfizer Inc.
President, Pfizer Global Research & Development
New London, CT

PETER H. LEVINE, M.D. (1990)
Health Care Consultant
BDC Advisors, LLC
Worcester, MA

F. WILLIAM MARSHALL, JR. (1986)
Retired Consultant
Chebeague Island, ME

LUENY MORELL, P.E. (2003)
Director
University Relations, Latin America
Hewlett-Packard Company
Aguadilla, PR

PHILIP R. MORGAN (1994)
President and CEO
Morgan Construction Company
Worcester, MA

JUDITH NITSCH '75 (1989)
President
Judith Nitsch Engineering, Inc.
Boston, MA

WINDLE B. PRIEM '59 (1991)
Retired President and CEO
Korn/Ferry International
Boston, MA

LEONARD E. REDON '73 (1992)
Vice President, Western Operations
Paychex, Inc.
Penfield, NY

STEPHEN E. RUBIN '74 (1995)
Founder
Intellution, Inc.
Norwood, MA

JOHN J. SHIELDS (SIM '69) (1990)
General Partner
Boston Capital Ventures
Boston, MA

GLENN YEE '74 (1999)
CEO
Pacific Can Co., Ltd.
Wanchai, Hong Kong

EX-OFFICIO MEMBER

DENNIS D. BERKEY (2004)
President of the Institute

ALUMNI MEMBERS

To June 30, 2005

DAVID K. HEEBNER '67 (1997)
President
General Dynamics Land Systems
Sterling Heights, MI

DONALD K. PETERSON '71 (1997)
Chairman and CEO
Avaya Inc.
Basking Ridge, NJ

To June 30, 2006

PAUL S. KENNEDY '67 (1998)
President
Kennedy Die Casting, Inc.
Worcester, MA

CARLETON F. KILMER '64 (1998)
Management Consultant
Electronics and High Technology
Wellesley, MA

To June 30, 2007

PHILIP B. RYAN '65 (1999)
CEO
Merchants Automotive Group
Hooksett, NH

MICHAEL P. ZARRILLI '71 (1999)
Chief Operating Officer
Spectrum Investment Group
New York, NY

To June 30, 2008

KAREN L. BEAN '86 (2000)
Mortgage Consultant/Loan Officer
Secure Mortgage Corporation
Shrewsbury, MA

STEVEN C. HALSTEDT '68 (2003)
Managing Director
Centennial Ventures
Denver, CO

To June 30, 2009

FREDERICK D. RUCKER '81 (1996)
Managing Partner
Capital Management Partners
Oakton, VA

DONALD P. ZERESKI (SIM '74) (2002)
Retired President and CEO
Silicon Dimensions
Marlborough, MA

To June 30, 2010

ORVILLE A. BAILEY '85 (2003)
Silver Spring, MD

To June 30, 2011

ROGER J. HEINEN, JR. '73 (2003)
Partner
Flagship Ventures
Cambridge, MA

PAUL A. LACOUTURE '72 (2003)
President
Network Services Group
Verizon Communications, Inc.
New York, NY

To June 30, 2012

WILLIAM N. GIUDICE '76 (2004)
Vice President and General Manager
Micromachined Products Division
Analog Devices
Cambridge, MA

SCOTT W. RAMSAY '68 (2004)
Former CFO and Exec VP
Shaw's Supermarkets

EMERITI TRUSTEES

GEORGE T. ABDOW '53 (1993)
Longmeadow, MA

PAUL A. ALLAIRE '60 (2002)
Rowayton, CT

WALTER J. BANK '46 (1986)
Bethesda, MD

ROBERT H. BECKETT '57 (2004)
Blue Bell, PA

JOHN LOTT BROWN '46 (1983)
Oberlin, OH

DANIEL I. COIFMAN '67 (2003)
Santurce, PR

THOMAS A. CORCORAN (2003)
Potomac, MD

RICHARD A. DAVIS '53 (1987)
Quechee, VT

WILLIAM A. DELPHOS '74 (1992)
McLean, VA

WILLIAM P. DENSMORE '45 (1995)
Worcester, MA

MICHAEL A. DIPIERRO '68 (2002)
Shrewsbury, MA

RAYMOND J. FORKEY '40 (1989)
Tequesta, FL

JOHN C. S. FRAY (1999)
Worcester, MA

HOWARD G. FREEMAN '40 (1994)
Worcester, MA

ANSON C. FYLER '45 (1982)
Waynesville, NC

BARBARA J. B. GATISON '74 (2000)
Blue Bell, PA

CALEB D. HAMMOND '37 (1988)
Maplewood, NJ

WILLIAM E. HANSON '32 (1972)
Shelton, WA

FRANCIS S. HARVEY '37 (1976)
Worcester, MA

JAMES N. HEALD, II (1967)
Worcester, MA

JOHN E. HOSSACK '46 (1994)
New Canaan, CT

WILFRID J. HOUDE '59 (1998)
Los Gatos, CA

PAUL J. KEATING, II '64 (2000)
Leominster, MA

GORDON P. LANKTON (1980)
Clinton, MA

C. JOHN LINDEGREN, JR. '39 (1991)
Westboro, MA

ARTHUR J. LOVETERE '60 (1993)
Atlanta, MI

CLAUDE P. MANCEL '71 (1997)
Belgium

MYLES McDONOUGH (1999)
Worcester, MA

JOHN C. METZGER, JR. '46 (1989)
Vero Beach, FL

CHARLES R. MICHEL '37 (1972)
Audubon, PA

ALFRED A. MOLINARI, JR. '63 (2004)
Marlboro, MA

JOHN M. NELSON (1986)
Boston, MA

DAVID P. NORTON '62 (2000)
Concord, MA

JOHN F. O'BRIEN (1996)
Needham, MA

STANLEY C. OLSEN (1985)
Lecanto, FL

HILLIARD W. PAIGE '41 (1984)
Williamsburg, VA

CAROL L. REINISCH (2001)
Falmouth, MA

DONALD E. ROSS '54 (1993)
Newbury, NH

GEORGE E. SALTUS '51 (1991)
Boulder, CO

GORDON H. SIGMAN, JR. '59 (1996)
Port St. Lucie, FL

DOROTHY M. SIMON (1988)
Pittsboro, NC

H. KERNER SMITH (2003)
Falmouth, MA

ROBERT C. STEMPEL '55 (1994)
Oxford, MI

DONALD TAYLOR '49 (2000)
North Hampton, NH

HOWARD C. WARREN '42 (1982)
Chicago, IL

LEONARD H. WHITE '41 (1992)
Worcester, MA

ADMINISTRATION

Numerals following name indicate year(s) of initial appointment.

OFFICE OF THE PRESIDENT

DENNIS D. BERKEY (2004)

President of the Institute

B.A., Muskingum College, 1969;

M.A., Miami University of Ohio, 1971;

Ph.D., University of Cincinnati, 1974.

STEPHANIE PASHA (2004)

Director of Operations

B.S.B.A., Boston University, 1993; Ed.M., 1997.

OFFICE OF THE PROVOST AND SENIOR VICE PRESIDENT

CAROL SIMPSON (2005)

Provost and Senior Vice President;

Professor, Civil and Environmental Engineering

B.Sc., University of Wales, 1975;

M.Sc., University of Witwatersrand in South Africa, 1977;

Ph.D., ETH Zurich in Switzerland, 1981.

JONATHAN P. ABRAHAM (2004)

Actuarial Program Coordinator/Adjunct Instructor

B.S. University of Iowa 1980;

F.S.A., Society of Actuaries 1991.

CHELSEA ADAMS (2004)

Assistant Director of Financial Aid

B.A., Trinity College, 2001.

KATHLEEN T. ADAMS (2005)

Program Manager, Extended Education

SHEILA BAILEY (1978)

Production Manager, Extended Education

B.S., University of Massachusetts, 1977.

McRAE C. BANKS (1995)

Director, Collaborative for Entrepreneurship & Innovation;

Professor of Management and Head of Department

B.A., Virginia Tech, 1972;

M.A., Northwestern University, 1973;

Ph.D., Virginia Tech, 1987.

ELIZABETH BARR (1993)

Seminar Manager, Extended Education

B.A., St. Michael's College, 1985.

JAMES A. BARYS (2000)

Master Teacher of Mathematics, Massachusetts Academy of Mathematics and Science

A.B., Colby College, 1969;

M.A., Clark University, 1977.

GINA M. BETTI (2000)

Associate Director, Collaborative for Entrepreneurship & Innovation

B.S., Eastern Michigan University, 1980; M.B.A., 1983.

MONICA M. LUCEY BLONDIN (1995)

Director of Financial Aid

B.A., University of Massachusetts, 1990;

M.S., Northeastern University, 1994.

JACKLYN BONNEAU (1996)

Master Teacher of Science, Massachusetts Academy of Mathematics and Science

B.S., Fitchburg State College, 1971;

M.A., University of Connecticut, 1975.

MICHAEL A. BUCKHOLT (2001)

Biology Laboratory Instructor/Adjunct Assistant Professor/ IACUC Committee Chair

B.S., The Pennsylvania State University, 1987;

Ph.D., Worcester Polytechnic Institute, 1992.

TIANA D. CARRASQUILLO (2005)

Assistant Director of Admissions,

Coordinator of Multicultural Recruitment

B.A., University of Connecticut, 2002;

M.Ed., University of Massachusetts/Amherst, 2005.

FABIO CARRERA (1991)

Director of Boston and Venice Project Centers;

Adjunct Assistant Professor, Interdisciplinary and Global Studies Division

B.S., Worcester Polytechnic Institute, 1984; M.S., 1996;

Ph.D., Massachusetts Institute of Technology, 2004.

JULIE CHAPMAN (2001)

Senior Assistant Director of Admissions

B.A., University of New Hampshire, 1997.

JENNIFER A. CLUETT (1998)

Senior Associate Director of Admissions, and Coordinator of Counselor Relations

A.B., Bowdoin College, 1996.

EDWARD J. CONNOR (2000)

Director of Admissions

B.S., Worcester Polytechnic Institute, 1992;

M.S., Boston College, 1999.

MICHAEL J. CURLEY (1979)

University Compliance Officer

B.S., University of Massachusetts, 1973;

M.S., Bridgewater State College, 1976.

MARTHA N. CYR (2003)

Director, K-12 Outreach

B.S., University of New Hampshire, 1982;

M.S., Worcester Polytechnic Institute, 1987; Ph.D., 1997.

LISA D. DAVENOCK (2000)

Assistant Director, Graduate Management Programs

B.A., University of Victoria, 1991; M.B.A., 2000.

- JOAN DEAL (1999)
*Assistant Program Manager,
Division of Extended Education*
- SHARON DEFFELY (1978)
Director, Corporate Training, Extended Education
A.S. Grahm Junior College, 1969.
- BRIAN DEGON (2001)
*Senior Program Manager and Recruiter,
Extended Education*
B.S., Worcester Polytechnic Institute, 1995.
- JOHN F. DELOREY (2001)
*Director of Choral Music/ Adjunct Instructor,
Humanities and Arts*
B.A., Vassar College, 1981;
M.M., The Boston Conservatory, 2003.
- JOSEPH J. DiCARLO (2005)
Assistant Director of Admissions
B.A., Assumption College, 2003.
- MICHAEL J. DIRUZZA, JR. (2000)
Associate Director of Financial Aid
A.S., Becker College, 1991;
B.S., New Hampshire College, 1992;
M.B.A., Anna Maria College, 1998.
- WILLIAM W. DURGIN (1971)
*Associate Provost for Academic Affairs and
Vice President for Research;
Professor of Mechanical Engineering*
B.S., Brown University, 1964;
M.S., University of Rhode Island, 1966;
PhD., Brown University, 1970.
- ROBYN ESPOSITO (2005)
Assistant Director of Financial Aid
B.A., Castleton State College, 1998.
- RICHARD G. FALCO (1979)
Director of Jazz Studies; Humanities and Arts
B.A., University of Massachusetts, 1989;
M.A., Clark University, 1992.
- ALEKSANDRA V. FEDOROVICH (2005)
*Assistant Director of Admissions,
International Coordinator*
B.S., Worcester Polytechnic Institute, 2002.
- STEPHEN P. FLAVIN (2005)
Associate Provost and Dean, Extended Education
B.S., Suffolk University, 1990; J.D., 1994.
- CAROL GAROFOLI (1982)
Director of Operations, Metal Processing Institute
A.S., Becker Junior College, 1972;
B.S., Worcester State College, 1982;
M.B.A., Assumption College, 1998.
- KAREN GOUDEY (2005)
Assistant Director, Graduate Studies and Enrollment
B.A., Smith College, 1989;
M.A., Lesley College, 1998.
- JOHN GOULET (1993)
*Coordinator, Masters in Mathematics for Educators
Program/Adjunct Assistant Professor*
B.S., Worcester Polytechnic Institute, 1973;
M.S., RPI, 1974; Ph.D., 1976.
- BONNIE HALL (2003)
Assistant Director of Admissions
B.A., Clark University, 2001; M.A., 2002.
- GLYNIS M. HAMEL (1991)
*Teaching Assistant Coordinator/Adjunct Instructor,
Computer Science*
B.S., University of Lowell, 1977;
M.S., Worcester Polytechnic Institute, 1986.
- SUSAN HICKS (2002)
Assistant Program Manager, Extended Education
B.S., Indiana University of Pennsylvania, 1988.
- ELIZABETH KEEFE (2003)
Program Manager, Division of Extended Education
B.S., Gordon College, 1999.
- CHARLES J. KORNIK (1989)
Administrator of Academic Programs
B.S., Fitchburg State College, 1966; M.Ed., 1975.
- KAREN M. LANG (2003)
Master Teacher of Computer Science
B.A., College of New Rochelle, 1980;
M.A.T., Tufts University, 1991.
- MELISSA M. LEAHY (1997)
Enrollment Analyst
B.S., Worcester Polytechnic Institute, 1997.
- FRANCOIS D. LEMIRE (2000)
Director of Research Administration
B.S., University of Rhode Island, 1977.
- HAILAN LI (2003)
Accounting and Information Systems Administrator
B.S., Sichuan Technology Institute, 1991;
M.S., Worcester Polytechnic Institute, 2003.
- ARLENE R. LOWENSTEIN (1980)
Dean of Special Academic Programs
B.A., Boston University, 1971;
M.S., Boston College, 1976.
- DAVID E. LUDT (2005)
Visiting Scholar in Humanities
B.A., College of the Holy Cross, 1969;
M.A., Rhode Island College, 1974.
- ANTHONY J. MANGANO, JR. (2003)
Director, Extended Education
B.S., Worcester Polytechnic Institute, 1972; M.S., 1976,
- MICHAEL B. MANNING (2003)
Director, Technology Transfer
B.S., Tufts University, 1974;
M.S., University of Maryland, 1977;
Ph.D., Brown University, 1985.

- JAMES W. MATTHEWS (2002)
Research Scientist
B.S., Lehigh University, 1963;
M.S., Polytechnic Institute of Brooklyn, 1967; Ph.D., 1971.
- W. GRANT MCGIMPSEY (1989)
Director, Bioengineering Institute;
Professor, Chemistry and Biochemistry
B.S., Brock University (Canada), 1978; M.S., 1981;
Ph.D., Queen's University (Canada), 1985.
- CAROLINE E. McHUGH (2002)
Assistant Director of Admissions
B.S., Case Western Reserve University, 1992.
- NATALIE MELLO (1993)
Director of Global Operations, Interdisciplinary and
Global Studies Division
B.A., Connecticut College, 1984;
M.A., Clark University, 1995.
- JEAN-FRANCOIS MENARD (1995)
Master Teacher of Word Language, Massachusetts
Academy of Mathematics and Science
B.A., Stonehill College, 1964;
M.A., Boston College, 1973;
D.E.A., Universite de Haute Bretagne, 1979.
- PAMELA A. O'BRYANT (1993)
Operations and Exchange Program Administrator
- LEOLYN OSBORN (1980)
Senior Associate Director of Financial Aid
B.A., Southeastern Massachusetts University, 1976.
- KATHLEEN PIERCE (2000)
Special Projects Coordinator, Office of the Registrar
B.A., Assumption College, 1980;
A.L.M., Harvard University, 1994.
- CREIGHTON PEET (2000)
Director of the Hong Kong Project Center; Co-Director of the
Namibia Project Center; Adjunct Assistant Professor,
Interdisciplinary and Global Studies Division
B.A., Harvard College, 1966;
M.Phil., Columbia University, 1978; Ph.D., 1978.
- WENDELIN RANSOM (1999)
Operations Manager, Admissions
B.S., Worcester State College, 1992.
- TED RUSSO (2005)
Associate Director, Pre-Award Services;
Office of Research Administration
A.L.B., Harvard University Extension School, 1993;
M.P.A., Suffolk University, 1998.
- ROBERT A. SALVATELLI (1999)
Director of the Massachusetts Academy of Mathematics
and Science
B.S., University of Bridgeport, 1964;
M.S., Fitchburg State College, 1969.
- LANCE E. SCHACHTERLE (1970)
Associate Provost for Academic Affairs;
Professor of English, Humanities and Arts
A.B., Haverford College, 1966;
A.M., University of Pennsylvania, 1968; Ph.D., 1970.
- LAURIE A. SMITH (1990)
Director of Academic Operations, Provost's Office
- MICHAEL P. SMITH (1992)
Associate Director of Admissions and Transfer Affairs
A.B., Bowdoin College, 1989;
M.S., Clark University, 1999.
- DALE E. SNYDER (1999)
Director of Academic Advising
B.S., Plymouth State College, 1976;
M.S., Old Dominion University, 1986.
- PAMELA K. ST. LOUIS (1996)
Operations Manager, Mechanical Engineering
and Academic Affairs
- KENNETH A. STAFFORD (1999)
Manager of Academic Initiatives, Adjunct Professor
of Mechanical Engineering
B.S., Oregon State University, 1973;
M.S., Air Force Institute of Technology, 1980.
- KRISTIN R. TICHENOR (2000)
Associate Vice President of Enrollment Management
B.A., Carleton College, 1985;
M.A., Clark University, 1994.
- ROBERT W. TRAVER (2003)
Principal, Massachusetts Academy of Mathematics
and Science
A.B., Dartmouth College 1975;
M.S., Purdue University, 1980;
Grad Diploma, University of Canterbury, NZ, 1981;
Ed.D., Harvard University, 1991.
- JOANN VAN DYKE (1973)
Director, Academic Resource Center/Disability Services
R.N. Framingham Union Hospital School of Nursing,
1967; Certified College Health Nurse, American Nurses
Credentialing Center, 1994.
- RICHARD F. VAZ (1983)
Associate Dean, Interdisciplinary and Global Studies
Division; Associate Professor, Electrical and
Computer Engineering
B.S.E.E., Worcester Polytechnic Institute, 1979;
M.S.E.E., 1984; Ph.D., 1987.
- SUSAN VERNON-GERSTENFELD (1987)
Director of the Puerto Rico and Costa Rica Project Centers;
Adjunct Professor; Director of Academic Programs and
Planning, Interdisciplinary and Global Studies Division
B.A., Boston University, 1962, M.S.W., 1974;
Ph. D., Boston College, 1987.

DOUGLAS G. WEEKS (1980)

Administrator of Applied Music

B.S., University of New Hampshire, 1964;

M.S., Gorham State, 1968;

M.M., University of Massachusetts., 1970;

Ed.D., Boston University, 1987.

JOANN WHITEFLEET-SMITH (1995)

*Senior Laboratory Instructor; Adjunct Assistant Professor,
Biology and Biotechnology*

B.A., Hope College, 1976;

M.S., Purdue University, 1979;

Ph.D., University of Wisconsin-Madison, 1984.

NORMAN D. WILKINSON (1995)

Director, Graduate Management Programs

B.A., University of Maine, 1983;

M.A., Syracuse University, 1986;

J.D., University of Connecticut School of Law, 1992.

OFFICE OF VICE PRESIDENT FOR STUDENT AFFAIRS AND CAMPUS LIFE

JANET BEGIN RICHARDSON (1980)

Vice President for Student Affairs and Campus Life

B.A., Salem State College, 1975;

Ed. S., SUNY at Albany, 1977; M.S., 1977

CHRISTOPHER J. BARTLEY (2001)

Head Men's Varsity Basketball Coach

B.A., University of Massachusetts/Lowell, 1994.

RODERICK J. BEATON

Assistant Director of Public Safety

B.S., Boston College, 1976;

M.A., Clark University, 1980

PAUL A. BENNETT (2004)

Head Swimming and Diving Coach

B.A., University of Wyoming, 2000.

SHARON E. CAHILL (1990)

Nurse

St. Vincent Hospital, 1966.

DOROTHY A. CAMPANIELLO (1994)

Recruiting Coordinator, Career Development Center

NAOMI B. CARTON (2001)

Director of Residential Services

B.A., Regis College, 1999;

M.A., University of Connecticut, 2001.

SARAH CARVER (2001)

Assistant Athletic Trainer

B.S., Ithaca College; 1999

PHILLIP N. CLAY (1993)

Dean of Students

B.A., St. Lawrence University, 1982;

M.A., University Center at Binghamton, 1986.

KRISTIN CONTI (2005)

Assistant Director of Residential Services

B.S., Bridgewater State College, 2001;

M.Ed., Suffolk University, 2005.

MICHAEL J. DeSAVAGE (2002)

Head Athletic Trainer

B.S., Keene State College, 1992;

M.Ed., Temple University, 2000.

JOHANNA DiCARLO (2002)

Head Field Hockey/Softball Coach

B.S., Bentley College, 1999; M.S.A., 2000.

JEANETTE M. DOYLE (2002)

Associate Director, Career Services

B.S., Framingham State College, 1989;

M.Ed., Springfield College, 1994.

JOHN E. DYLEWICZ

Police Officer, Campus Police

MICHAEL W. ELLSWORTH (1999)

Sergeant, Campus Police

CHERISE GALASSO (2000)

Assistant Director of Athletics/Senior Women's

Administrator/Head Women's Basketball Coach

B.A., The University of Rochester, 1992;

M.S., Nazareth College, 1994.

SHERRY A. GIBSON

Police Officer, Campus Police

CASSIE GLASRUD (2003)

Assistant Women's Basketball Coach

B.A., Carleton College, 2003.

PHILIP J. GREBINAR (1972)

Associate Professor of Physical Education

B.S., State University College at Cortland, 1971;

M.S., 1972.

EDWIN R. GUZMAN (2005)

Police Officer, Campus Police

DANA L. HARMON (2002)

Director of Physical Education, Recreation & Athletics

B.A., Bellarmine College, 1987;

M.S., Umass / Amherst, 1994.

YVONNE V. HARRISON (1992)

Director, Career Development Center and

Cooperative Education

B.S., Lincoln University, 1973;

M.Ed., Temple University, 1984.

PATRICK K. HICKEY (1999)

Assistant Football Coach/Fitness Center Director

B.S., Assumption College, 1999.

CALVIN R. HILL (2003)

Assistant Dean of Students and

Director of Diversity Programs

B.A., Bethany College, 1993;

M.S., Emporia State University, 1997.

- CONSTANCE H. HORWITZ (2003)
Assistant Director, Employer Relations
B.S., Northeastern University, 1972; M.B.A., 1979.
- SONJA L. KORUM (2004)
Area Coordinator, Residential Services
B.A., St. Martin's College, 1996;
M.Ed, Azusa Pacific University, 2000.
- BRIAN F. LAVALLEE
Police Officer, Campus Police
- EDMOND W. LORION (2002)
Manager, Bowling Center
- CHERYL A. MARTUNAS (2005)
Director of Public Safety
B.S., Anna Maria College
- SHAWN McAVEY (1990)
Athletic Department Equipment Manager
- BILLY D. McGOWAN (1997)
Director, ESL
B.A., University of New Orleans, 1972;
M.A., Troy State University, 1982;
Graduate Certificate in ESL, Clark University, 1996.
- JAMES H. McLAUGHLIN (2000)
Director of Campus Center
B.A., Bridgewater State College, 1975;
M.A., Fairfield University, 1977.
- CHARLES C. MORSE (1993)
Director, Student Development and Counseling Center
B.A., University of Massachusetts, Amherst, 1981;
M.A., Assumption College, 1993.
- MICHELLE E. NICHOLSON (2005)
Director of Women's Programs
B.A., Roger Williams University, 1994; M.S., 1998.
- LAWRENCE NOBLE (1999)
*Director of Rowing, Director of Intramurals,
and P.E. Instructor*
B.A., Columbia College, 1984;
M.A., University of Virginia, 1994.
- FRANKLIN S. PAGE
Police Officer, Campus Police
- CONNIE PEPPE (2005)
Assistant Director of Student Activities
B.A., St. John Fisher College, 2003;
M.S., Central Connecticut State University, 2005.
- EMILY PERLOW (2005)
*Assistant Director of Student Activities
and Greek Life Programs*
B.A., The Ohio State University, 2002;
M.A., Bowling Green State University, 2005.
- HEINZ J. RING (1980)
Sergeant, Campus Police
- REGINA A. ROBERTO (2001)
Director/Nurse Practitioner, Health Services
BSN, Northeastern University, 1980
M.S., Regis College, 1998
- CHRISTOPHER M. ROBERTSON (1999)
*Head Baseball Coach/Assistant Football Coach/
PE Instructor*
B.A., University of Albany, 1996; M.S., 1998.
- GREGORY A. SNODDY (1996)
*Associate Dean of Students & Director of
PERA Student Programs*
B.S., Ohio University, 1983;
M.Ed., Bowling Green State University, 1985;
Ed.D., West Virginia University, 1996.
- ROBERT SOUTHALL (2005)
Assistant Men's Basketball Coach
B.S., Springfield College, 2002; M.Ed., 2004.
- NEIL SPELLMAN (2001)
Police Officer
B.S. Westfield State College
- JASON R. STEELE (1999)
*Head Women's Varsity Crew Coach and
Facilities Coordinator*
B.A., Emory University, 1994.
- TOM H. THOMSEN (1986)
Director of International Students and Scholars
M.S.W., Copenhagen School of Social Work, 1981;
C.A.G.S., Clark University, 1994.
- ROBERT J. VANDAL
Police Officer, Campus Police
- DONNA J. WELCH
Police Officer, Campus Police
- EDMOND ZALOOM (1998)
Head Football Coach
B.S., Cortland State University, 1975;
M.S., University of Albany, 1980.

**OFFICE OF THE VICE PRESIDENT FOR
ADMINISTRATION, TREASURER AND SECRETARY
OF THE CORPORATION; SECRETARY-TREASURER,
WPI ALUMNI ASSOCIATION**

JEFFREY S. SOLOMON (2005)

*Vice President for Finance and Operations;
Secretary and Treasurer of the Corporation*
B.S., Bentley College, 1985;
M.S., Brandeis University, 2001.

JOHN E. MILLER (1982)

*Associate Vice President for Business Affairs;
Director of Physical Plant*
B.S.M.E., Clarkson University, 1966; M.S., 1971.

JENIFER AMEDY (2005)

Manager, Bookstore
B.S., Bryant College, 2001.

GARY L. ANTINARELLA (1996)

Supervisor of Custodians-Night

BARRY E. CARMEL (1985)

Senior Staff Accountant
A.S., Central New England College, 1972.

FRANK P. CONTI (1981)

Controller and Assistant Secretary
B.S.A., Bentley College, 1967; CPA, 1975.

LORI A. COSTELLO (2005)

Payroll Manager
A.S., Quinsigamond Community College, 1985.

DANIELLE L. COVE (1996)

Associate Treasurer
B.A., Clark University, 2000.

CHAD FARRELL (1983)

Supervisor, Printing Services

SADIE C. GOESCH (1990)

Administrative Services Manager

YVONNE D. HARRIS (1988)

Senior Accounting Manager
B.S., Central Connecticut State University, 1985
M.B.A., Nichols College, 1997.

A. TRACY HASSETT (1998)

*Associate Vice President of Human Resources, and
Assistant to the President*
B.S., Roger Williams University, 2002.

NORMAN F. HUTCHINS (2001)

Mechanical Operations Supervisor

JAMES F. KENARY (1981)

Events Program Manager

RONALD F. KLOCEK (1988)

Manager of Grounds and Properties
A.A., Central New England College, 1983.

JOSEPH M. KRASKOUSKAS (1995)

Director, Dining Services
(Chartwell's)

CELIA McLAREN (1987)

Supervisor, Mail Services

DAVID H. MESSIER (1982)

Environmental & Occupational Safety Manager
A.S., Quinsigamond Community College, 1993.

THOMAS MOREAU (1986)

Supervisor of Custodians
A.S., Becker Junior College, 1977.

MARLYN MYERS (1976)

Plant Services-Manager of Properties

CYNTHIA PELLEGRINO (2001)

Assistant Director of Human Resources
M.B.A., Nichols College, 2005.

TERRENCE J. PELLERIN (1981)

Associate Director of Physical Plant

ROBERT C. PEPIN (1985)

Supervisor of Custodians

CLARENCE PLANT (1985)

Property Administrator
CPPM, CF

RICHARD J. ROGAN

Associate Controller/Director of Accounting Operations
B.B.A., UMass, 1981;
M.S., Bentley, 1981; CPA, 1984.

DENISE ROULEAU (1996)

Manager, Sponsored Research Accounting
B.S., Nichols College, 1990.

CHRISTOPHER L. SALTER (1998)

Associate Director of Physical Plant
B.S., University of Massachusetts, 1974.

ANN S. SCHLICKMANN (1982)

Director of Administrative Services
B.A., Regis College, 1963.

ELISIA R. STAFFORD (1993)

Manager, Student Loans

ELIZABETH TOMASZEWSKI (2003)

Information Systems Supervisor
M.B.A., Bentley College, 1983.

JUDITH L. TRAINOR (1987)

Director of Budget and Institutional Research
B.A., Smith College, 1971;
M.A., University of Connecticut, 1973;
M.B.A., Babson College, 1983; CPA, 1986.

JANET L. WHITTIER (1964)

Accounts Receivable Manager
Salter Secretarial School, 1964.

LUANNE ZINGARELLI (1998)

Treasury Administrator

**OFFICE OF THE VICE PRESIDENT FOR
INFORMATION TECHNOLOGY**

THOMAS J. LYNCH III (1998)

*Vice President for Information Technology and
Chief Information Officer*

B.S., University of Cincinnati, 1972;
S.M., Massachusetts Institute of Technology, 1974;
E.E., 1975; Ph.D., 1981.

CHARLES R. ANDERSON (1999)

Network Engineer

B.S., Worcester Polytechnic Institute, 1999.

JON BARTELSON (1998)

Assistant Director of Computing Services

B.S., Worcester Polytechnic Institute, 2001.

JOANNE BELLER (1980)

Reference Coordinator

B.S.Ed., Framingham State College, 1975;
M.L.S., Simmons College, 1980.

WALTER G. BERTRAND (1994)

Manager of Telecommunications

DEBORAH A. BOCKUS (1989)

Access Services Manager

A.A., Mount Wachusett Community College, 1986;
B.S., Worcester State College, 1989;
M.L.S., Simmons College, 2002.

JOSHUA T. BRANDT (2000)

Senior Unix Systems Administrator

ALEX BRELSFOARD (2004)

Web Applications Developer

B.A., Beloit College, 2001.

JUSTIN W. BROOKS (2001)

Systems Administrator

B.S., Rensselaer Polytechnic Institute, 2000.

LORA T. BRUECK (1974)

Assistant Director, Collections

B.A., University of Massachusetts, 1969;
M.L.S., Spalding College, 1970.

THOMAS L. COLLINS, III (2001)

Windows System Administrator

B.S., Worcester Polytechnic Institute, 2001.

PAULA M. DELANEY (2001)

Administrative Applications Manager

B.S., Worcester Polytechnic Institute, 1976.

PHILLIP G. DENECAULT (2004)

Security Officer

DEBRA L. DEXTER (1995)

Software Applications Instructor

B.A., University of Massachusetts, Amherst, 1992.

MARIE DIRUZZA (1997)

Assistant Director, Desktop Support

B.A., Our Lady of the Elms College, 1992.

ROGER A. DONAHUE (1987)

Database Administrator

A.A., Worcester Industrial Technical Institute, 1974.

CHRISTINE DREW (2004)

Instruction Coordinator

B.A., Worcester State College, 1992

M.L.S., Southern Connecticut State University, 1994.

BRUCE M. FIENE (2000)

Assistant Manager, Campus Media Services

B.F.A., Massachusetts College of Art, 1989.

PATRICIA FLANAGAN (2003)

Director of User Services, Assistant Library Director

B.A., University of Delaware, 1981;

M.L.S., Columbia University, 1989.

DAVID W. GALVIN (1973)

Administrative Database Technical &

Project Support Specialist

MARTHA GUNNARSON (1987)

Assistant Director, Serials

A.B., Clark University, 1972;

M.L.S., Simmons College, 1976.

MARY BETH HARRITY (1989)

Assistant Director of Computing Services

A.B., College of the Holy Cross, 1979;

M.Ed., University of Massachusetts, 1984.

STEPHEN W. HEMMING (2002)

Manager, Campus Media Services

B.A., Ithaca College, 1981.

ALLAN E. JOHANNESSEN (1970)

Director of Internetworking and Telecommunications

B.S., Worcester Polytechnic Institute, 1968.

JOSEPH M. KRZESZEWSKI (2000)

Network Engineer

B.S., Worcester Polytechnic Institute, 2000.

MATTHEW LALIBERTE (2004)

Instructional Technologist

M.S., Syracuse University, 2002;

B.A., University of New Hampshire, 1998.

VICKI LYNN (2000)

Sr. Project Manager

B.S., Bates College, 1972;

M.S., Central Connecticut State College, 1978;

M.B.A., University of Connecticut, 1984.

AMY L. MARR (1996)

Director of Web Development

B.S., Worcester Polytechnic Institute, 1996; M.S., 2000.

SIA M. NAJAFI (1995)

Manager of Academic Computing and Departmental

Technology Support

B.S., Worcester Polytechnic Institute, 1984; M.S., 1990.

- RODNEY G. OBIEN (2000)
University Archivist and Curator of Special Collections
B.A., Virginia Wesleyan College, 1992;
M.L.I.S., Catholic University of America, 1996.
- CHRISTOPHER M. O'CONNOR (2000)
Senior Windows System Administrator
A.S., Community College of the Air Force, 1989;
B.A., Ohio State University, 1992;
MCSE Certification, Worcester Polytechnic Institute, 2000.
- KERRIE O'CONNOR (1997)
Office Operations Computer Support Services
B.A., College of the Holy Cross, 1992.
- SEAN M. O'CONNOR (1997)
Director of Network Operations and Security
B.S., Worcester Polytechnic Institute, 1994;
M.S., Rensselaer Polytechnic Institute, 1998.
- MARIE D. OPRICA (2003)
Help Desk Support Coordinator
B.S., Worcester Polytechnic Institute, 2001.
- AMY E. PARTRIDGE (1984)
Programmer/Analyst
A.A., Colby-Sawyer College, 1978.
- CINDY PHILBRICK (2002)
Marketing & Student Services Coordinator
- MIN QUI (2003)
Assistant Data Base Administrator
B.S., Xiangtan University, China, 1993; M.S., 1996.
- AMY RICCI (2005)
Manager, Faculty Support Services
B.A., Syracuse University, 1992;
M.B.A., Rochester Institute of Technology, 1995;
M.A., George Washington University, 2005.
- DONALD G. RICHARDSON (1976)
Assistant Director, Library Systems
B.A., Colby College, 1974;
M.L.S., Simmons College, 1976.
- LYNNE RILEY (2005)
Access Services Librarian
B.S., Worcester State College, 2001
M.L.I.S., University of Pittsburgh, 2005
- CARLA RISI (2000)
Administrative User Support Specialist
- LAURA ROBINSON (2005)
Interlibrary Loan/Reference Librarian
B.A., University of Connecticut, 1996
M.S. Simmons College, 2002
- JEFFREY D. SCAMACCA (2000)
Administrative Computer Specialist
B.A., Wesleyan University, 1990.
- KEVIN R. SHANAHAN (1978)
Programmer/Analyst
A.A., Worcester Industrial Technical Institute, 1978.
- ROBERT M. SHEEHAN (1995)
Programmer/Analyst
- PAMELA SHELLEY (2000)
Assistant Director, Advanced Distance Learning Network (ADLN)
B.A., University of Massachusetts, 1971;
M.B.A., Suffolk University, 1981.
- HELEN M. SHUSTER (1975)
Director, Library Services
M.A., Edinburgh University, 1958;
M.L.S., Syracuse University, 1974.
- GREG SMITH (2005)
Information Systems Specialist
B.S. Tufts University, 1991
- ANDREW M. STONE (2001)
New Technologies and Project Specialist
B.S., Worcester Polytechnic Institute, 2001.
- FRANK E. SWEETSER (1998)
Network Engineer
B.S., Worcester Polytechnic Institute, 2001.
- DAVID TARANTO (2002)
Manager, Media Production Services
B.S., N.N. Institute of Technology, 1999.
- MARK J. TAYLOR (2001)
UNIX Systems Administrator
UNIX Certification, Worcester Polytechnic Institute, 1996;
Technology Certification, Worcester Polytechnic Institute, 1998.
- SARAH THEMME (2003)
Web Developer
- BENJAMIN R. THOMPSON (1975)
Director of Computing Services
B.S., Worcester Polytechnic Institute, 1973
- ANNE M. VALERIO (1996)
Office Operations Computer Support Specialist
B.A., University of Massachusetts, North Dartmouth, 1985.
- SARAH WALKOWIAK (2000)
Online Delivery Coordinator
B.S., Worcester Polytechnic Institute, 2000.
- KATE E. WRIGLEY (2005)
Instructional Technology Specialist
B.A., University of Connecticut, 2002.

**OFFICE OF THE VICE PRESIDENT FOR
ADVANCEMENT**

- STEPHEN J. HEBERT '66 (1969)
University Vice President
B.S., Worcester Polytechnic Institute, 1966.
- TERRY SCHMIDT ADAMS (1997)
Director of Corporate Relations
B.S., Worcester Polytechnic Institute, 1992;
M.B.A., New Hampshire College, 1997.
- LAURIE W. BOWATER (1997)
Associate Director of Planned Giving
B.S., Worcester State College, 1990.
- PATTI-LYNNE M. CAMPOMIZZI (1997)
Director of Advancement Services
B.S., Worcester State College, 1977.
- ANNE CARRAHER (2004)
Assistant Director of Annual Giving and Alumni Programs
B.A., Regis College, 2000.
- AMANDA K. COLGAN (2005)
Manager of Donor Relations
B.S., Vanderbilt University, 2005.
- PAMELA A. DISCIPIO (1990)
Associate Director of Alumni Relations
B.S., Eastern Nazarene College, 2002.
- ADAM M. EPSTEIN (2005)
Assistant Director of Alumni Relations
- HEATHER L. GELARDI (2004)
Associate Director of Annual Giving
B.A., Brandeis University, 1995.
- LISA C. MAIZITE (1996)
Executive Director of Major Gifts
B.A., University of Vermont, 1992.
- JAMES C. MONTANO (2005)
Director of the President's Advisory Council
B.A., University of Connecticut, 1995; B.S., 1996.
- REBECCA NORMAN (2005)
Manager of Donor Research Systems
B.S., University of Wisconsin-Oshkosh, 1997.
- ROBERT A. OBORNE (2001)
Senior Advancement Researcher
B.A., UMass Amherst 1974;
M.B.A., Rivier College, 1984.
- DENISE R. RODINO (1979)
Executive Director of Corporate and Foundation Relations
B.A., Rutgers University, 1971.
- ELIZABETH B. SILADI (1986-1991) (1996)
Executive Director of Planned Giving
B.A., Colby College, 1981.

ELIZABETH T. WALKER (2005)
Associate Director of Foundation Relations
B.A., Nazareth College of Rochester, 1974;
M.A., University of New Mexico, 1981.

BARBARA R. ZIFF (1976)
Executive Director, Advancement Operations and Research
B.F.A., Boston University, 1964.

**OFFICE OF THE VICE PRESIDENT FOR
MARKETING AND COMMUNICATIONS**

CHRISTOPHER J. HARDWICK (2005)
Vice President, Marketing and Communications
B.A., University of Wisconsin, 1979;
M.A., University of Maryland, 1980.

AMY E. DEAN (2004)
Assistant Vice President, Communications
B.A., Skidmore College, 1975.

MICHAEL W. DORSEY (1985)
Marketing Communications Director
B.A., University of Connecticut, 1976.

PEGGY L. ISAACSON (1974)
Graphic Designer
Salter Secretarial School, 1958.

SARAH JAY (2003)
Web Developer

JOAN KILLOUGH-MILLER (1993)
Alumni Editor
B.A., Hamilton College, 1979;
M.A., Syracuse University, 1986.

AMY L. MARR (1996)
Director of Web Development
B.S., Worcester Polytechnic Institute, 1996;
M.S., 2000.

ELEANOR M. MCCREA (1995)
Production Manager
B.S., Worcester State College, 1964;
M.A.T., Assumption College, 1969.

TARA MYERS (2002)
E-Marketing Director
B.A., Boston University, 1997;
M.A.

MICHAEL J. SHERMAN, (1987)
Design Director
B.F.A., Johnson State College, 1983.

CHARNA WESTERVELT
Magazine Editor
B.A., Ithica College, 2000.

KEVIN WYNN (2002)
Associate Director of Media Relations
B.S., University of Massachusetts, 1992;
M.A., Emerson College, 1995.

ADMINISTRATORS EMERITI

WILLIAM R. GROGAN (1946-1990)
*Dean of Undergraduate Studies Emeritus
and Professor Emeritus*

ROBERT J. HALL (1956-1990)
Professor Emeritus

OWEN W. KENNEDY, JR. (1946-1987)
Dean of Academic Computing Emeritus and Professor Emeritus

DAVID A. LUCHT (1978-)
Director Emeritus, Center for Firesafety Studies

DONALD N. ZWIEP (1957-1990)
Professor and Department Head Emeritus

ACADEMIC DEPARTMENT HEADS

LTC EDWARD N. IRELAND
Air Force Aerospace Studies

ERIC W. OVERSTRÖM
Biology and Biotechnology

CHRISTOPHER H. SOTAK
Biomedical Engineering

DAVID DiBIASIO (Interim)
Chemical Engineering

JAMES W. PAVLIK (Interim)
Chemistry and Biochemistry

FREDERICK L. HART
Civil and Environmental Engineering

MICHAEL A. GENNERT
Computer Science

FRED J. LOOFT III
Electrical and Computer Engineering

KATHY A. NOTARIANNI
Fire Protection Engineering

PATRICK J. M. QUINN
Humanities and Arts

McRAE C. BANKS
Management

BOGDAN M. VERNESCU
Mathematical Sciences

GRETAR TRYGGVASON
Mechanical Engineering

MAJ RANDALL K. BROWN
Military Science

DANA L. HARMON
Physical Education

JOHN W. NORBURY
Physics

KHALID SAEED
Social Science and Policy Studies

FACULTY

(As of December 1, 2005)

Numerals following name indicate year(s) of initial appointment.

DAVID S. ADAMS (1984)
Professor, Biology and Biotechnology
B.S., Oklahoma State University, 1974;
M.S., University of Houston, 1976;
Ph.D., University of Texas, 1979.

WILLIAM A. B. ADDISON, JR. (1986)
Associate Professor of History; Humanities and Arts
B.A., University of South Carolina, 1965;
M.A., University of Virginia, 1967;
M.Phil., Columbia University, 1974; Ph.D., 1986.

EMMANUEL O. AGU (2002)
Assistant Professor, Computer Science
B.Eng., University of Benin, Nigeria, 1994;
M.S., University of Massachusetts/Amherst, 1996;
Ph.D., 2001.

LEONARD D. ALBANO (1992)
Associate Professor, Civil and Environmental Engineering
Associate Professor, Fire Protection Engineering
B.S., Tufts University, 1982;
M.S., Northwestern University, 1983;
Ph.D., Massachusetts Institute of Technology, 1992, P.E.

DIRAN APELIAN (1990)
Professor, Mechanical Engineering;
Howmet Professor of Engineering;
Director, Metal Processing Institute
B.S., Drexel University, 1968;
Sc.D., Massachusetts Institute of Technology, 1972.

PADMANABHAN K. ARAVIND (1984)
Professor, Physics
B.S., Delhi University (India), 1971; M.S., 1973;
Ph.D., Northwestern University, 1980.

JOSÉ M. ARGÜELLO (1996)
Associate Professor, Chemistry and Biochemistry
B.S., National University of Cordoba, 1979;
Ph.D., National University of Rio Cuarto, Argentina, 1986.

HOLLY K. AULT (1983)
Associate Professor, Mechanical Engineering;
Co-Director Design Studio
B.S., Worcester Polytechnic Institute, 1974;
M.S., 1983; Ph.D., 1988.

JOSEPH C. BAGSHAW (1984)
Professor, Biology and Biotechnology
B.A., Johns Hopkins University, 1965;
Ph.D., University of Tennessee - Oak Ridge Graduate
School, 1969.

- WILLIAM A. BALLER (1986)
Adjunct Assistant Professor of History;
Humanities and Arts
B.A., Marquette University, 1971;
M.A., Providence College, 1975;
M.S., Columbia University, 1976;
M.A., State University of New York at Albany, 1982;
Ph.D., Clark University, 1994.
- McRAE C. BANKS (1995)
Professor, Management, and Head of Department
Director, Collaborative for Entrepreneurship and Innovation
B.A., Virginia Tech, 1972;
M.A., Northwestern University, 1973;
Ph.D., Virginia Tech, 1987.
- JONATHAN R. BARNETT (1979)
Professor, Fire Protection Engineering;
Professor, Mechanical Engineering
B.S., Worcester Polytechnic Institute, 1974;
M.S., 1976; Ph.D., 1989.
- ISA BAR-ON (1982)
Professor, Mechanical Engineering
B.S., Hebrew University of Jerusalem, 1974;
M.S., 1977; Ph.D., 1984.
- LT. KELLY BENDER (2005)
Assistant Professor, Air Force Aerospace Studies
B.S., University of Maryland, 1998.
- JOHN A. BERGENDAHL (2000)
Assistant Professor, Civil and Environmental Engineering
Assistant Professor, Chemical Engineering
B.S., University of Connecticut, 1985; M.S., 1996;
Ph.D., 1998.
- FREDERICK BIANCHI (1994)
Professor of Music; Humanities and Arts
B.A., Cleveland State University, 1980;
M.S., Ball State University, 1982; Ph.D., 1985.
- KRISTEN L. BILLIAR (2002)
Assistant Professor, Biomedical Engineering
Assistant Professor, Mechanical Engineering
B.S., Cornell University, 1991;
M.S., University of Pennsylvania, 1992; Ph.D., 1998.
- JOHN J. BLANDINO (2001)
Assistant Professor, Mechanical Engineering
B.S., Rensselaer Polytechnic Institute, 1987;
M.S., Massachusetts Institute of Technology, 1989;
Ph.D., California Institute of Technology, 2001.
- IVAN BLANK (2004)
Assistant Professor, Mathematical Sciences
A.B., Princeton University, 1993;
Ph.D., New York University, 2000.
- YEVGENIY BOGDANOV (2002)*
Research Assistant Professor, Bioengineering Institute
B.S., Worcester Polytechnic Institute, 1997; M.S., 1998;
Ph.D., 2002.
- JOEL J. BRATTIN (1990)
Professor of English; Humanities and Arts
A.B., University of Michigan, 1978;
Ph.D., Stanford University, 1985.
- CHRISTOPHER A. BROWN (1989)
Professor, Mechanical Engineering
B.A., University of Vermont, 1975;
M.S., 1979; Ph.D., 1983.
- DAVID C. BROWN (1980)
Professor, Computer Science; Professor,
Mechanical Engineering
B.S., North Staffordshire Polytechnic, 1970;
M.S., University of Kent at Canterbury, 1974;
M.S., Ohio State University, 1976; Ph.D., 1984.
- DONALD R. BROWN (2000)
Assistant Professor, Electrical and Computer Engineering;
B.S., University of Connecticut, 1992; M.S., 1996;
Ph.D., Cornell University, 2000.
- STEVEN C. BULLOCK (1989)
Professor of History; Humanities and Arts
B.A., Houghton College, 1978;
M.A., SUNY-Binghamton, 1980;
A.M., Brown University, 1982; Ph.D., 1986.
- NANCY A. BURNHAM (2000)
Associate Professor, Physics
B.A., Colgate University, 1980;
M.S., University of Colorado, 1985; Ph.D., 1987.
- TERRI ANNE CAMESANO (2000)
Assistant Professor, Chemical Engineering
Assistant Professor, Civil and Environmental Engineering
B.S., University of Rochester, 1995;
M.S., University of Arizona, 1997;
Ph.D., Pennsylvania State University, 2000.
- RONALD D. CHEETHAM (1973)
Professor, Biology and Biotechnology
B.A., University of Minnesota, 1965; M.S., 1967;
Ph.D., Purdue University, 1970.
- PETER R. CHRISTOPHER (1963)
Professor, Mathematical Sciences
A.B., Clark University, 1959; M.A., 1963; Ph.D., 1982.
- MICHAEL J. CIARALDI (1999)
Professor of Practice, Computer Science
B.A., Cornell University, 1973;
M.S., Rochester Institute of Technology, 1979;
M.S., University of Rochester, 1983.
- EDWARD A. CLANCY (2000)
Associate Professor, Electrical and Computer Engineering
Associate Professor, Biomedical Engineering
B.S., Worcester Polytechnic Institute, 1983;
M.S., Massachusetts Institute of Technology, 1987;
Ph.D., 1991.
- WILLIAM M. CLARK (1986)
Associate Professor, Chemical Engineering
B.S., Clemson University, 1979;
Ph.D., Rice University, 1984.

- MARK L. CLAYPOOL (1998)
Associate Professor, Computer Science, and Director, Interactive Media and Game Development
B.A., Colorado College, 1990;
M.S., University of Minnesota, 1993; Ph.D., 1996.
- KEVIN A. CLEMENTS (1970)
Professor, Electrical and Computer Engineering
B.E.E., Manhattan College, 1963;
M.S., Polytechnic Institute of Brooklyn, 1966; Ph.D., 1970.
- EBEN C. COBB (1995)
Visiting Assistant Professor, Mechanical Engineering
B.S., Norwich University, 1977;
M.S., University of Wisconsin, 1978;
M.S., Boston University, 1981;
Ph.D., University of Connecticut, 1985.
- ROBERT E. CONNORS (1976)
Professor, Chemistry and Biochemistry
B.S., University of Massachusetts, 1967;
Ph.D., Northeastern University, 1972.
- THEODORE C. CRUSBERG (1969)
Associate Professor, Biology and Biotechnology
B.A., University of Connecticut, 1963;
M.S., Yale University, 1964;
Ph.D., Clark University, 1968.
- DAVID CYGANOSKI (1976)
Professor, Electrical and Computer Engineering
B.S., Worcester Polytechnic Institute, 1975;
M.S., 1976; Ph.D., 1981.
- ERWIN DANNEELS (2000)
Assistant Professor, Management
B.A., University of Ghent (Belgium), 1990; M.B.A., 1991;
M.S., University of California/Davis, 1994;
Ph.D., Pennsylvania State University, 1998.
- RAVINDRA DATTA (1998)
Professor, Chemical Engineering
B.T., Indian Institute of Technology (India), 1972;
Ph.D., University of California, 1981.
- PAUL W. DAVIS (1970)
*Professor, Mathematical Sciences;
Dean, Interdisciplinary and Global Studies Division*
B.S., Rensselaer Polytechnic Institute, 1966;
M.S., 1967; Ph.D., 1970.
- NICHOLAS A. DEMBSEY (1995)
Associate Professor, Fire Protection Engineering
B.S., University of Michigan, 1986
M.S., University of California at Berkeley, 1988; Ph.D., 1995.
- MICHAEL A. DEMETRIOU (1997)
Associate Professor, Mechanical Engineering
B.S., University of Southern California, 1987; M.S., 1989;
M.S., 1990; Ph.D., 1993.
- CHRYSANTHE DEMETRY (1993)
Associate Professor, Mechanical Engineering
B.S., Worcester Polytechnic Institute, 1988;
Ph.D., Massachusetts Institute of Technology, 1993.
- DAVID DIBIASIO (1980)
Associate Professor, Chemical Engineering, and Interim Head of Department
B.S., Purdue University, 1972; M.S., 1977; Ph.D., 1980.
- MIKHAIL F. DIMENTBERG (1994)
Professor, Mechanical Engineering
M.S.C., Moscow Institute of Power Engineering, 1958;
Ph.D., 1963; Doctor of Technical Sciences, 1971.
- JAMES P. DITTAMI (1985)
Professor, Chemistry and Biochemistry
B.A., College of The Holy Cross, 1975;
M.S., Boston College, 1978;
Ph.D., Rensselaer Polytechnic Institute, 1983.
- ANTHONY G. DIXON (1980)
Professor, Chemical Engineering
B.S., Edinburgh University, 1975; Ph.D., 1978.
- SOUSSAN DJAMASBI (2004)
Assistant Professor, Management
B.S., Christian Albert University (Germany), 1988;
M.S., University of New Mexico, 1991;
Ph.D., University of Hawaii, 2004.
- DAVID B. DOLLENMAYER (1990)
Professor of German; Humanities and Arts
B.A., Princeton University, 1967; Ph.D., 1977.
- DANIEL J. DOUGHERTY (2002)
Professor, Computer Science
B.A., University of Maryland, 1974; Ph.D., 1982.
- JAMES K. DOYLE (1992)
Associate Professor, Social Science and Policy Studies
B.A., University of California/Berkeley, 1982;
M.A., University of Colorado/Boulder, 1990; Ph.D., 1991.
- R. JAMES DUCKWORTH (1987)
Associate Professor, Electrical and Computer Engineering
B. Eng., Bradford University, 1981;
Ph.D., Nottingham University, 1984.
- WILLIAM W. DURGIN (1971)
Professor, Mechanical Engineering; Associate Provost for Academic Affairs and Vice President for Research
Sc.B., Brown University, 1964;
M.S., University of Rhode Island, 1966;
Ph.D., Brown University, 1970. P.E.
- TAHAR EL-KORCHI (1987)
Professor, Civil and Environmental Engineering
B.S., University of New Hampshire, 1980,
M.S., 1982; Ph.D., 1986.
- MICHAEL B. ELMES (1990)
Professor, Management
B.S., Union College, 1975;
M.A., Colgate University, 1979;
Ph.D., Syracuse University, 1989.
- ALEXANDER E. EMANUEL (1974)
Professor, Electrical and Computer Engineering
B.S., Technion, Israel Institute of Technology (Haifa),
1963; M.S., 1965; D.Sc., 1969. P.E.

- MICHELLE EPHRAIM (1999)
Assistant Professor of English; Humanities and Arts
B.A., Tufts University, 1991;
M.A., University of Wisconsin, Madison, 1993;
Ph.D., 1998.
- WILLIAM W. FARR (1989)
Associate Professor, Mathematical Sciences
B.S., University of California - Davis, 1975;
M.A., University of California - Los Angeles, 1981;
Ph.D., University of Minnesota, 1986.
- JOSEPH D. FEHRIBACH (1992)
Associate Professor, Mathematical Sciences;
Associate Professor, Chemical Engineering
B.A., Centre College, 1980;
M.A., Duke University 1982; Ph.D., 1985.
- DAVID FINKEL (1988)
Professor, Computer Science, and
Associate Head of Department
B.A., Temple University, 1966;
M.S., University of Chicago, 1967; Ph.D., 1971.
- KATHRYN FISLER (2000)
Assistant Professor, Computer Science
B.A., Williams College, 1991;
M.S., Indiana University, 1992; Ph.D., 1996.
- MALCOLM S. FITZPATRICK (1977)
Associate Professor, Civil and Environmental Engineering
B.S., Yale University, 1959, B.E., 1960;
M.S., Stanford University, 1961;
M.S., Harvard University, 1965; M.C.P., 1968, Ph.D., 1975.
- MUSTAPHA S. FOFANA (1997)
Associate Professor, Mechanical Engineering
B.S./M.S., Budapest Technical University, 1986;
M.A.S., University of Waterloo, 1989; Ph.D., 1993.
- JEFFREY L. FORGENG (1999)
Adjunct Associate Professor of History; Humanities and Arts;
The Paul S. Morgan Curator, The Higgins Armory Museum
B.A., Brown University, 1983;
M.A., Centre for Medieval Studies,
University of Toronto, 1985; Ph.D., 1991.
- COSME FURLONG-VAZQUEZ (1999)
Assistant Professor, Mechanical Engineering
B.Eng., University of the Americas, 1989;
M.S., Worcester Polytechnic Institute, 1992; Ph.D., 1999.
- RAFAEL GARCIA (2003)
Assistant Professor, Physics
B.A., Cornell University, 1988;
M.S., Penn State University, 1995; Ph.D., 1999.
- NIKOLAOS A. GATSONIS (1994)
Associate Professor, Mechanical Engineering;
Director, Aerospace Engineering Program
B.S., Aristotelian University of Thessaloniki, 1983;
M.S., University Michigan, 1986;
M.S., Massachusetts Institute of Technology, 1987;
Ph.D., 1991.
- MAJ NORMAND A. GAUTHIER (2006)
Professor, Military Science, and Head of Department
B.S., Concordia University, 1985;
M.B.A., Canisius College, 1998.
- MICHAEL A. GENNERT (1987)
Associate Professor, Computer Science, and Head of
Department; Associate Professor, Electrical and
Computer Engineering
S.M.E.E., S.B.C.S., S.B.E.E., Massachusetts Institute of
Technology, 1980; Sc.D., 1987.
- ARTHUR GERSTENFELD (1976)
Professor, Management
B.M.E., Rensselaer Polytechnic Institute, 1950;
M.S., Massachusetts Institute of Technology, 1966;
Ph.D., 1967.
- DANIEL G. GIBSON III (1983)
Assistant Professor, Biology and Biotechnology
B.A., Stanford University, 1966;
M.A., College of William and Mary, 1969;
Ph.D., Boston University, 1980.
- ROGER S. GOTTLIEB (1981)
Professor of Philosophy; Humanities and Arts
B.A., Brandeis University, 1968; Ph.D., 1975.
- DEBORAH E. GRAY (1991)
Adjunct Instructor of History; Humanities and Arts
B.A., Elmira College, 1971;
M.A., Clark University, 1989.
- PHILIP J. GREBINAR (1972)
Associate Professor, Physical Education and Athletics
B.S., State University College at Cortland, 1971;
M.S., 1972.
- HOSSEIN HAKIM (1984)
Associate Professor, Electrical and Computer Engineering,
and Associate Head of Department
B.S.E.E., Arya Mehr University (Iran), 1975;
M.S.E.E., Purdue University, 1977; Ph.D., 1982.
- JAMES P. HANLAN (1975)
Professor of History; Humanities and Arts
A.B., College of the Holy Cross, 1967;
M.A., Clark University, 1971; Ph.D., 1979.
- PETER H. HANSEN (1992)
Associate Professor of History; Humanities and Arts
B.A., Carleton College, 1984;
M.A., Harvard University, 1986; Ph.D., 1991.
- FREDERICK L. HART (1974)
Professor, Civil and Environmental Engineering, and
Head of Department
B.S.E., University of Connecticut, 1969;
M.S., 1971; Ph.D., 1974.
- GEORGE HEATON (1986)
Adjunct Associate Professor, Management; Adjunct
Associate Professor, Social Science and Policy Studies
B.S., University of Pennsylvania, 1969;
J.D., Boston university, 1974.

- NEIL T. HEFFERNAN (2002)
Assistant Professor, Computer Science
B.A., Amherst College, 1993;
M.S., Carnegie Mellon University, 1998; Ph.D., 2001.
- GEORGE T. HEINEMAN (1996)
Associate Professor, Computer Science
B.A., Dartmouth College;
M.S., Columbia University; Ph.D., 1996.
- ARTHUR C. HEINRICHER, JR. (1992)
Professor, Mathematical Sciences
B.S., University of Missouri/St. Louis, 1980;
Ph.D., Carnegie Mellon University, 1986.
- HUONG NGO HIGGINS (1998)
Associate Professor, Management
B.A., (French), University of Ho Chi Minh City, 1990;
B.A., (English), 1990;
M.A., Georgia State University, 1996; Ph.D., 1998.
- LORRAINE D. HIGGINS (2003)
Associate Professor of English; Humanities and Arts;
Director of the Center for Communication Across
the Curriculum
B.A., Carnegie Mellon University, 1985; M.A., 1991;
Ph.D., 1992.
- ALLEN H. HOFFMAN (1970)
Professor, Mechanical Engineering
B.S., Worcester Polytechnic Institute, 1963; M.S., 1967;
Ph.D., University of Colorado, 1970. P.E.
- MICHA HOFRI (1998)
Professor, Computer Science
B.S., Technion-IIT (Haifa), 1964; M.S., 1965; D.Sc., 1972.
- ZHIKUN HOU (1991)
Professor, Mechanical Engineering
B.S., Fudan University, 1974;
M.S., Tongji University, 1981;
M.S., California Institute of Technology, 1986;
Ph.D., 1990.
- MAYER HUMI (1971)
Professor, Mathematical Sciences
B.S., Hebrew University of Jerusalem, 1963; M.S., 1964;
Ph.D., Weizmann Institute of Science, 1969.
- GERMANO S. IANNACCHIONE (1998)
Associate Professor, Physics
B.S., University of Akron, 1987; M.S., 1990;
Ph.D., Kent State University, 1993.
- LTC EDWARD N. IRELAND (2003)
Professor, Air Force Aerospace Studies, and
Head of Department
B.A., Warren Wilson College, 1974;
M.P.A., Golden Gate University, 1987.
- STEPHEN N. JASPERSON (1970)
Professor, Physics
B.S., University of Wisconsin, 1963;
M.A., Princeton University, 1965; Ph.D., 1968.
- PARAMASIVAM JAYACHANDRAN (1977)
Associate Professor, Civil and Environmental Engineering
B.E., University of Madras (India), 1966;
M.S., University of Wisconsin, 1971; Ph.D., 1975.
- J. SCOTT JIUSTO (2004)
Assistant Professor, Interdisciplinary and
Global Studies Division
B.S., Empire State College (SUNT), 1992;
M.A., University of Albany (SUNY), 1998;
Ph.D., Clark University, 2004.
- HAMID JOHARI (1989)
Professor, Mechanical Engineering, and
Associate Head of Department
B.S., California Institute of Technology, 1983;
M.S., University of Washington, 1984; Ph.D., 1989.
- SHARON A. JOHNSON (1988)
Associate Professor, Management;
Director of Industrial Engineering Program
B.S., University of Michigan, 1983;
M.S., Cornell University, 1986; Ph.D., 1989.
- CHICKERY J. KASOUF (1990)
Associate Professor, Management
B.A., Providence College, 1975;
M.B.A., Syracuse University, 1985; Ph.D., 1991.
- ROBERT N. KATZ (1990)
Research Professor, Mechanical Engineering
B.S., Massachusetts Institute of Technology, 1961;
M.S., University of Michigan, 1963;
Ph.D., Massachusetts Institute of Technology, 1969.
- NIKOLAOS KAZANTZIS (2001)
Associate Professor, Chemical Engineering
B.S., University of Thessaloniki, Greece, 1990;
M.S., University of Michigan, 1992; M.S.E., 1993;
Ph.D., 1997.
- THOMAS H. KEIL (1967)
Professor, Physics
B.S., California Institute of Technology, 1961;
Ph.D., University of Rochester, 1965.
- BRIAN KING (2002)
Assistant Professor, Electrical and Computer Engineering
B.S., Worcester Polytechnic Institute, 1993; M.S., 1995;
Ph.D., University of Arizona, 2000.
- ROBERT E. KINICKI (1978)
Associate Professor, Computer Science
B.S., Case Western Reserve University, 1968;
M.S., Indiana University, 1975;
Ph.D., Duke University, 1978.
- CAROLANN KOLECI (2001)
Assistant Professor, Physics
B.S., State University of New York/Albany, 1994;
M.S., Brown University, 1996; M.S., 1998; Ph.D., 2001.

- J. ROBERT KRUEGER (2004)
Assistant Professor, Interdisciplinary and Global Studies Division
B.S., Oklahoma State University, 1991;
M.S.L., Vermont Law School, 1992;
M.A., Clark University, 1998; Ph.D., 2004.
- ROBERT C. LABONTÉ (1997)
Professor of Practice, Electrical and Computer Engineering
B.S., Worcester Polytechnic Institute, 1954; M.S., 1960.
- CHRISTOPHER J. LARSEN (1996)
Associate Professor, Mathematical Sciences
B.S., Carnegie Mellon University, 1989;
J.D., University of Maryland School of Law, 1992;
M.S., Carnegie Mellon University; Ph.D., 1996.
- KAREN A. LEMONE (1981)
Associate Professor, Computer Science
B.A., Tufts University, 1964;
M.S., Boston College, 1972;
Ph.D., Northeastern University, 1979.
- JIANYU LIANG (2004)
Assistant Professor, Mechanical Engineering
B.S., Central South University (China), 1995; M.E., 1998;
Ph.D., Brown University, 2004.
- ROBERT W. LINDEMAN (2005)
Assistant Professor, Computer Science
B.A., Brandeis University, 1987;
M.S., University of Southern California, 1992;
D.Sc., The George Washington University, 1999.
- KENT P. LJUNGQUIST (1977)
Professor of English; Humanities and Arts
B.A., Clark University, 1970;
M.A., University of Connecticut, 1972;
Ph.D., Duke University, 1975.
- ELEANOR T. LOIACONO-MELLO (2000)
Assistant Professor, Management
B.A., Boston University, 1992;
M.B.A., Boston College, 1996;
Ph.D., University of Georgia, 2000.
- FRED J. LOOFT III (1980)
Professor, Electrical and Computer Engineering, and Head of Department; Professor, Biomedical Engineering; Professor, Mechanical Engineering
B.S., University of Michigan, 1973;
M.S., 1974, 1976; Ph.D., 1979.
- WENJING LOU (2003)
Assistant Professor, Electrical and Computer Engineering
B.E., Xi'an Jiaotong University, 1993; M.E., 1996;
M.A. Sc., Nanyang Technological University, 1998;
Ph.D., University of Florida, 2003.
- REINHOLD LUDWIG (1986)
Professor, Electrical and Computer Engineering; Professor, Biomedical Engineering; Professor, Mechanical Engineering
Diplom-Ingenieur, University of Wuppertal (West Germany), 1983;
Ph.D., Colorado State University, 1986.
- ROGER YIN-MAN LUI (1983)
Professor, Mathematical Sciences
B.S., University of Minnesota, 1975; Ph.D., 1981.
- KONSTANTIN A. LURIE (1989)
Professor, Mathematical Sciences
M.Sc., Leningrad Polytechnical Institute (USSR), 1959;
Ph.D., A.F. Ioffe Physical-Technical Institute, Academy of Sciences (USSR), 1964; D.Sc., 1972.
- JAMES M. LYNEIS (2002)
Professor of Practice, Social Science and Policy Studies
S.B., Massachusetts Institute of Technology, 1971;
Ph.D., University of Michigan, 1974.
- YI H. MA (1967)
Professor, Chemical Engineering
Frances B. Manning Professorship
B.S., National Taiwan University, 1959;
M.S., University of Notre Dame, 1963;
Sc.D., Massachusetts Institute of Technology, 1967.
- JOHN C. MacDONALD (2001)
Assistant Professor, Chemistry
B.A., Bowdoin College, 1987;
Ph.D., University of Minnesota, 1993.
- SERGEY N. MAKAROV (2000)
Associate Professor, Electrical and Computer Engineering
M.S., St. Petersburg State university (Russia), 1982;
Ph.D., 1986.
- MAKHLOUF M. MAKHLOUF (1989)
Professor, Mechanical Engineering; Director, Aluminum Casting Research Laboratory
B.S., American University (Cairo), 1978;
M.S., New Mexico State University, 1981;
Ph.D., Worcester Polytechnic Institute, 1989.
- RAJIB B. MALLICK (1998)
Associate Professor, Civil & Environmental Engineering
B.S., Jadavpur University (India), 1989;
M.S., Auburn University, 1993; Ph.D., 1997.
- JO ANN MANFRA (1972)
Professor of History; Humanities and Arts
B.S., State University of New York at Cortland, 1963;
M.S., 1967; Ph.D., University of Iowa, 1975;
J.D., Suffolk University Law School, 1977;
LL.M., Harvard Law School, 1979.
- MURALI MANI (2003)
Assistant Professor, Computer Science
B.Tech., Indiana Institute of Technology, 1998;
M.S., University of California, 2000; Ph.D., 2003.
- H. J. MANZARI (2001)
Assistant Professor, Spanish; Humanities & Arts
B.A., Hobart College, 1991;
M.A., Pennsylvania State University, 1993;
M.A., University of Virginia, 1995; Ph.D., 2001.

- WILLIAM J. MARTIN (2000)
Associate Professor, Mathematical Sciences, and
Associate Head of Department;
Associate Professor, Computer Science
B.A., State University of New York/Potsdam, 1986;
M.A., 1986;
Ph.D., University of Waterloo (Canada), 1992.
- PAUL P. MATHISEN (1993)
Professor, Civil and Environmental Engineering
B.S., University of Massachusetts, 1984;
S.M., Massachusetts Institute of Technology, 1989;
Ph.D., 1993.
- LAUREN M. MATHEWS (2003)
Assistant Professor, Biology and Biotechnology
B.A., Connecticut College, 1996;
Ph.D., University of Louisiana/Lafayette, 2001.
- W. GRANT MCGIMPSEY (1989)
Professor, Chemistry and Biochemistry, and Director,
Bioengineering Institute
B.S., Brock University (Canada), 1978; M.S., 1981;
Ph.D., Queen's University (Canada), 1985.
- JOHN A. Mc NEILL (1994)
Associate Professor, Electrical and Computer Engineering
A.B., Dartmouth College, 1983;
M.S., University of Rochester, 1991;
Ph.D., Boston University, 1994.
- YITZHAK MENDELSON (1983)
Associate Professor, Biomedical Engineering
B.S., State University of New York at Buffalo, 1975;
M.S., 1976;
Ph.D., Case Western Reserve University, 1983.
- WILLIAM R. MICHALSON (1992)
Professor, Electrical and Computer Engineering, and
Professor, Computer Science
B.S. E.E., Syracuse University, 1981;
M.S., Worcester Polytechnic Institute, 1985; Ph.D., 1989.
- JAMSHED J. MISTRY (1999)
Assistant Professor, Management
B. Com., Poona University (India), 1976;
B.S., Purdue University, 1983;
M.B.A., University of Utah, 1984;
D.B.A., Boston University, 1999.
- YONG-MO MOON (2002)
Assistant Professor, Mechanical Engineering
B.S., Yonsei University (Seoul, Korea), 1993; M.S., 1995;
Ph.D., University of Michigan, 2000.
- UMBERTO MOSCO (2005)
Professor, Mathematical Sciences; Harold J. Gay
Professorship in Mathematics
Laurea in Mathematical Sciences, University of Rome, 1959;
Laurea in Physics, University of Rome, 1961;
Libera Docenza in Mathematical Methods in Physics,
Italy, 1967.
- WESLEY T. MOTT (1987)
Professor of English; Humanities and Arts
A.B., Boston University, 1968; A.M., 1969; Ph.D., 1974.
- KANKANA MUKHERJEE (2002)
Assistant Professor, Mechanical Engineering
B.A., North Eastern Hill University (India), 1983;
MA, 1985; M.Phil., 1989;
M.A., University of Connecticut, 1992; Ph.D., 1997.
- BALGOBIN NANDRAM (1989)
Professor, Mathematical Sciences
B.Sc., University of Guyana, 1977, Dip. Ed., 1979;
M.Sc., University of London, Imperial College, 1981;
Ph.D., University of Iowa, 1989.
- LARE MATTIAS NILSSON (2005)
Assistant Professor, Management
M.Sc., Stockholm School of Economics (Sweden), 1997;
Ph.D., 2002.
- FRANCIS NOONAN (1978)
Associate Professor, Management;
Associate Professor, Fire Protection Engineering
B.S., Boston College, 1963;
M.S., Northeastern University, 1967;
Ph.D., University of Massachusetts, 1973.
- JOHN W. NORBURY (2004)
Professor, Physics, and Head of Department;
Professor, Mechanical Engineering
B.Sc., University of Melbourne (Australia), 1977;
M.Sc., 1979;
Ph.D., University of Idaho, 1983.
- ROBERT L. NORTON (1981)
Professor, Mechanical Engineering
B.S., Northeastern University, 1967;
M.S., Tufts University, 1970. P.E.
- KATHY A. NOTARIANNI
Associate Professor, Fire Protection Engineering, and
Head of Department; Associate Professor,
Mechanical Engineering
B.S., Worcester Polytechnic Institute, 1986; M.S., 1989;
M.S., Carnegie Mellon University, 1997; Ph.D., 2000.
- JOHN T. O'CONNOR (1970)
Professor, Social Science and Policy Studies;
Professor, Management
A.B., College of the Holy Cross, 1960;
M.B.A., The Wharton School, 1962;
Ph.D., University of Notre Dame, 1970;
M.P.H., Harvard University, 1975.
- DAVID J. OLINGER (1990)
Associate Professor, Mechanical Engineering
B.S., Lafayette College, 1983;
M.S., Rensselaer Polytechnic Institute, 1985;
M.S., Yale University, 1988; Ph.M., 1988; Ph.D., 1990.
- JOHN A. ORR (1977)
Professor, Electrical and Computer Engineering
B.S., University of Illinois, 1969;
M.S., Stanford University, 1970;
Ph.D., University of Illinois, 1977.

- JAMES C. O'SHAUGHNESSY (1986)
Professor, Civil and Environmental Engineering
B.S., University of New Hampshire, 1965;
M.S., Pennsylvania State University, 1970; Ph.D., 1973.
- ERIC W. OVERSTRÖM (2004)
*Professor, Biology and Biotechnology, and
Head of Department*
B. A., College at Oswego (SUNY), 1974;
M.S., University of Massachusetts (Amherst), 1978;
Ph.D., 1981.
- MAJ. FEDENCIA PAGADUAN (2003)
Assistant Professor, Military Science
B.S., Santa Clara University, 1989.
- KAVEH PAHLAVAN (1985)
*Professor, Electrical and Computer Engineering; Professor,
Computer Science*
M.S., University of Teheran, 1975;
Ph.D., Worcester Polytechnic Institute, 1979.
- CAPT THEODORE S. PAINTER (2004)
Assistant Professor, Military Science; Recruiting Officer
B.A., University of Massachusetts (Amherst), 1999.
- E. MALCOLM PARKINSON (1974)
Associate Professor of History; Humanities and Arts
B.S., Queen's University of Belfast, 1963;
Ph.D., Belfast, 1966;
M.A., Princeton University, 1970.
- JAMES W. PAVLIK (1974)
*Professor, Chemistry and Biochemistry, and
Interim Head of Department*
A.B., Carthage College, 1959;
M.S., Virginia Polytechnic and State University, 1961;
Ph.D., George Washington University, 1970.
- OLEG V. PAVLOV (2002)
Assistant Professor, Social Science and Policy Studies
B.S., University of Southern California, 1994; Ph.D., 2000.
- PEDER C. PEDERSEN (1987)
*Professor, Electrical and Computer Engineering;
Professor, Biomedical Engineering*
B.S., Aalborg Engineering College, 1971;
M.E., University of Utah, 1974; Ph.D., 1976.
- CREIGHTON PEET (2000)
*Program Coordinator/Adjunct Assistant Professor,
Interdisciplinary and Global Studies Division*
B.A., Harvard College, 1966;
P.Phil., Columbia University, 1978; Ph.D., 1978.
- JOSEPH D. PETRUCCELLI (1978)
Professor, Mathematical Sciences
A.B., Boston College, 1971;
M.S., Purdue University, 1974; Ph.D., 1978.
- ROBERT A. PEURA (1968)
*Professor, Biomedical Engineering; Professor,
Electrical and Computer Engineering*
B.S., Worcester Polytechnic Institute, 1964;
M.S., Iowa State University, 1967; Ph.D., 1969.
- GEORGE D. J. PHILLIES (1985)
Professor, Physics
S.B., Massachusetts Institute of Technology, 1969,
M.S., 1971; D.Sc., 1973.
- ROBERTO PIETROFORTE (1992)
Associate Professor, Civil and Environmental Engineering
Laurea University of Rome, 1974;
M.S., Massachusetts Institute of Technology, 1987;
M.S., 1987; Ph.D., 1992.
- GEORGE D. PINS (2000)
Assistant Professor, Biomedical Engineering
B.S., Rutgers College of Engineering, 1989;
Ph.D., Rutgers University, 1996.
- JEANINE D. PLUMMER (1999)
Associate Professor, Civil & Environmental Engineering
B.S., Cornell University, 1993;
M.S., University of Massachusetts / Amherst, 1995;
Ph.D., 1999.
- SAMUEL M. POLITZ (1988)
Associate Professor, Biology and Biotechnology
B.S., Louisiana State University, 1973;
Ph.D., University of California at Los Angeles, 1978.
- GARY F. POLLICE (2002)
Professor of Practice, Computer Science
B.A., Rutgers University, 1973;
M.S., University of Massachusetts/Lowell, 1994.
- REETA PRUSTY (2005)
Assistant Professor, Biology and Biotechnology
B.S., Birla Institute of Technology and Science (India), 1991;
M.S., Drexel University, 1994;
Ph.D., Penn State University Medical College, 1999.
- RYSZARD J. PRYPUTNIEWICZ (1978)
*Professor, Mechanical Engineering;
Professor, Electrical and Computer Engineering;
Kenneth G. Merriam Distinguished Professorship*
B.S., University of Hartford, 1972;
M.S., University of Connecticut, 1974; Ph.D., 1976. P.E.
- RICHARD S. QUIMBY (1982)
Associate Professor, Physics
B.S., Clarkson College of Technology, 1975;
Ph.D., University of Wisconsin at Madison, 1979.
- PATRICK J. M. QUINN (2002)
Professor, Humanities and Arts, and Head of Department
B.A., University of Guelph (Canada), 1971;
M.A., University of Ottawa (Canada), 1972;
Ph.D., The University of Warwick (England), 1988.
- MICHAEL J. RADZICKI (1990)
Associate Professor, Social Science and Policy Studies
B.A., St. Norbert College, 1979;
M.A., University of Notre Dame, 1982; Ph.D., 1985.
- L. RAMDAS RAM-MOHAN (1978)
*Professor, Physics; Professor, Electrical and
Computer Engineering*
B.S., Delhi University (India), 1964;
M.S., Purdue University, 1967; Ph.D., 1971.

- MALCOLM H. RAY (1998)
*Professor and White Chair,
 Civil & Environmental Engineering;
 Professor, Mechanical Engineering*
 B.S., University of Vermont, 1983;
 M.S., Carnegie-Mellon University, 1984;
 Ph.D., Vanderbilt University, 1992.
- MARK W. RICHMAN (1985)
Associate Professor, Mechanical Engineering
 B.S., State University of New York at Buffalo;
 M.S., University of Michigan, 1979;
 Ph.D., Cornell University, 1983.
- KENT J. RISSMILLER (1988)
Associate Professor, Social Science and Policy Studies
 A.B., Muhlenberg College, 1976;
 J.D., Franklin Pierce Law Center, 1980;
 M.A., Syracuse University, 1981; Ph.D., 1986.
- ANGEL A. RIVERA (1994)
Associate Professor of Spanish; Humanities and Arts
 B.A., University of Puerto Rico, 1983; M.A., 1987;
 Ph.D., Rutgers University, 1994.
- YIMING RONG (1998)
*Professor, Mechanical Engineering
 John Woodman Higgins Professorship in
 Engineering (2002-2005) (2005-2008), and
 Associate Director of Manufacturing Engineering*
 B.S., Harbin University of Science and
 Technology (China), 1981;
 M.S., Tsinghua University (China), 1984;
 M.S., University of Wisconsin-Madison, 1987;
 Ph.D., University of Kentucky, 1989.
- JOSHUA P. ROSENSTOCK (2005)
Assistant Professor, Humanities and Arts
 B.A., Brown University, 1996;
 M.F.A., School of Art Institute of Chicago, 2004.
- CAROLINA RUIZ (1998)
Associate Professor, Computer Science
 B.S., University of Los Andes, Colombia, 1988; B.S., 1989;
 M.S., 1990;
 Ph.D., University of Maryland, 1996.
- JILL RULFS (1990)
*Associate Professor, Biology and Biotechnology;
 Pre-Health Professions Advisor*
 B.S., University of Massachusetts, 1973;
 Ph.D., Tufts University, 1982.
- ELKE A. RUNDENSTEINER (1996)
Professor, Computer Science
 B.S., Johann Wolfgang Goethe University, Frankfurt,
 West Germany; M.S., 1984;
 M.S., Florida State University, Irvine, 1992.
- ELIZABETH F. RYDER (1996)
Associate Professor, Biology and Biotechnology
 A.B., Princeton University, 1980;
 M.S., Harvard School of Public Health, 1985;
 Ph.D., Harvard Medical School, 1993.
- KHALID SAEED (1997)
*Professor, Social Science and Policy Studies, and
 Head of Department*
 B.S., University of Engineering and Technology,
 Parkistan, 1968;
 M.E., Asian Institute of Technology, Thailand, 1975;
 Ph.D., Massachusetts Institute of Technology, 1981.
- GUILLERMO F. SALAZAR (1983)
Associate Professor, Civil and Environmental Engineering
 B.S., University of La Salle (Mexico), 1971;
 M.Eng., University of Toronto, 1977;
 Ph.D., Massachusetts Institute of Technology, 1983.
- M. DAVID SAMSON (1991)
*Associate Professor of Art History/Architecture;
 Humanities and Arts*
 B.A., University of Chicago, 1980;
 Ph.D., Harvard University, 1988.
- JOHN SANBONMATSU (2003)
Assistant Professor, Humanities and Arts
 B.A., Hampshire College, 1984;
 Ph.D., University of California at Santa Cruz, 2000.
- MARCUS SARKIS (1998)
Associate Professor, Mathematical Sciences
 B.S., Instituto Tecnológico de Aeronáutica (Brazil), 1984;
 M.S., Pontificia Universidade Católica de Rio de Janeiro
 (Brazil), 1989;
 Ph.D., New York University, 1994.
- BRIAN J. SAVILONIS (1981)
*Professor, Mechanical Engineering;
 Professor, Biomedical Engineering;
 Head Coach, Cross-Country*
 B.S., Worcester Polytechnic Institute, 1972; M.S., 1973;
 Ph.D., State University of New York, 1976.
- ALFRED A. SCALA (1966)
Professor, Chemistry and Biochemistry
 B.S., Brooklyn College, 1957; M.S., 1961;
 Ph.D., Polytechnic Institute of Brooklyn, 1965.
- LANCE E. SCHACHERLER (1970)
*Professor of English; Humanities and Arts;
 Associate Provost for Academic Affairs*
 A.B., Haverford College, 1966;
 A.M., University of Pennsylvania, 1968; Ph.D., 1970.
- STANLEY M. SELKOW (1980)
Professor, Computer Science
 B.S., Carnegie Institute of Technology, 1965;
 M.S., University of Pennsylvania, 1967; Ph.D., 1970.
- BRIGITTE I. SERVATIUS (1987)
Professor, Mathematical Sciences
 Magister der Naturwissenschaften der Universität Graz,
 Austria, 1978;
 Ph.D., Syracuse University, 1987.
- EUNMI SHIM (2002)
Assistant Professor, Humanities and Arts
 B.M., Seoul National University (Korea), 1987;
 M.M., University of Illinois at Urbana-Champaign, 1993;
 Ph.D., 1999.

- SATYA SHIVKUMAR (1990)
Professor, Mechanical Engineering;
Professor, Biomedical Engineering
B.S., Regional Engineering College, 1978;
M.S., Indian Institute of Technology, 1980;
M.S., Stevens Institute of Technology, 1987; Ph.D., 1987.
- RICHARD D. SISSON, JR. (1976)
Professor, Mechanical Engineering, and
Director of Manufacturing Engineering
B.S., Virginia Polytechnic Institute, 1969;
M.S., Purdue University, 1971; Ph.D., 1975.
- RUTH L. SMITH (1983)
Associate Professor of Religion; Humanities and Arts
B.A., East Tennessee State University, 1969;
M.A., Ohio University, 1971;
M.T.S., Harvard University Divinity School, 1976;
Ph.D., Boston University, 1982.
- CAPT AUSTIN L. SORENSEN (2004)
Assistant Professor, Air Force Aerospace Studies
B.S., U.S. Air Force Academy, 1998.
- CHRISTOPHER H. SOTAK (1988)
Professor, Biomedical Engineering, and Head of
Department; Professor, Chemistry & Biochemistry
B.A., University of Northern Colorado, 1975; M.A., 1980;
Ph.D., Syracuse University, 1983;
M.B.A., Worcester Polytechnic Institute, 1995.
- DIANE M. STRONG (1995)
Associate Professor, Management
B.S., University of South Dakota, 1974;
M.S., New Jersey Institute of Technology, 1978;
M.S., Carnegie Mellon University, 1983;
Ph.D., Carnegie Mellon University, 1988.
- JOHN M. SULLIVAN, JR. (1987)
Professor, Mechanical Engineering; Professor, Electrical &
Computer Engineering; Professor, Biomedical Engineering;
Professor, Computer Science
B.S., Zoology, University of Massachusetts, 1973;
B.S., Mec.E., 1977; M.S., Mec.E., 1978;
Ph.D., Thayer School of Engineering, Dartmouth
College, 1986.
- BERK SUNAR (2000)
Assistant Professor, Electrical and Computer Engineering
B.S., Middle East Technical University (Turkey), 1995;
Ph.D., Oregon State University, 1998.
- DALIN TANG (1988)
Professor, Mathematical Sciences;
Professor, Biomedical Engineering
B.A., Nanjing Institute of Technology, 1981;
Ph.D., University of Wisconsin at Madison, 1988.
- STEVEN S. TAYLOR (2002)
Assistant Professor, Management
B.S., Massachusetts Institute of Technology, 1982;
M.A., Emerson College, 1993;
Ph.D., Boston College, 2000.
- VENKAT R. THALLADI (2002)
Assistant Professor, Chemistry and Biochemistry
B.S., Kakatiya University (India), 1990; M.S., 1992;
Ph.D., University of Hyderabad (India), 1998.
- ROBERT W. THOMPSON (1976)
Professor, Chemical Engineering
B.S., Clarkson Institute of Technology, 1971; M.S., 1973;
Ph.D., Iowa State University, 1975.
- JOHN M. TRIMBUR (1987)
Professor of English; Humanities and Arts
B.A., Stanford University, 1968;
M.A., State University of New York at Buffalo, 1971;
Ph.D., 1982.
- GRÉTAR TRYGGVASON (2000)
Professor, Mechanical Engineering, and Head of Department
B.S., University of Iceland, 1980;
M.S., Brown University, 1982; Ph.D., 1985.
- HELEN G. VASSALLO (1982)
Professor, Management;
Professor, Biology and Biotechnology
B.S., Tufts University, 1953; M.S., 1955;
Ph.D., Clark University, 1967;
M.B.A., Worcester Polytechnic Institute, 1982.
- RICHARD F. VAZ (1983)
Associate Professor, Electrical and Computer Engineering;
Associate Dean, Interdisciplinary and
Global Studies Division
B.S.E.E., Worcester Polytechnic Institute, 1979;
M.S.E.E., 1984; Ph.D., 1987.
- DOMOKOS VERMES (1990)
Associate Professor, Mathematical Sciences
M.S. (Electrical), Technische Universitat, 1970;
M.S. (Mathematics), 1971; Ph.D., University of Szeged, 1975.
- BOGDAN M. VERNESCU (1991)
Professor, Mathematical Sciences, and Head of Department
B.S., University of Bucharest, 1982; M.S., 1982;
Ph.D., Institute of Mathematics - Bucharest, 1989.
- SUSAN VERNON-GERSTENFELD (1987)
Adjunct Professor, Interdisciplinary and Global Studies
Division; Director of Academic Programs and
Planning for IGSD
B.A., Boston University, 1962; M.S.W., 1974;
Ph.D., Boston College, 1987.
- SUSAN VICK (1981)
Professor of Drama/Theatre, and Director of Theatre;
Humanities and Arts
A.B., Catawba College, 1967;
M.F.A., Southern Methodist University, 1969;
Ph.D., University of Illinois, 1979.
- DARKO VOLKOV (2004)
Assistant Professor, Mathematical Sciences
B.Sc., University of Paris (France), 1993;
Ph.D., Rutgers University, 2001.

HOMER F. WALKER (1997)

Professor, Mathematical Sciences

B.A., Rice University, 1966;

M.S., New York University, 1968; Ph.D., 1970.

MATTHEW O. WARD (1986)

Professor, Computer Science

B.S., Worcester Polytechnic Institute, 1977;

M.S., University of Connecticut, 1979, Ph.D., 1981.

PAMELA J. WEATHERS (1979)

Professor, Biology and Biotechnology

B.S., Marquette University, 1969;

Ph.D., Michigan State University, 1974.

ELISE A. WEAVER (2001)

Assistant Professor, Social Science and Policy Studies

B.S., University of Toronto, 1989; M.A., 1992;

M.A., Duke University, 1996; Ph.D., 1999.

SUZANNE L. WEEKES (1998)

Associate Professor, Mathematical Sciences

B.S., Indiana University, 1989;

M.S., University of Michigan, 1990; Ph.D., 1995.

JAYSON D. WILBUR (2002)

Assistant Professor, Mathematical Sciences

B.S., Worcester Polytechnic Institute, 1997;

M.S., Purdue University, 2000; Ph.D., 2002.

JENNIFER L. WILCOX (2004)

Assistant Professor, Chemical Engineering

B.A., Wellesley College, 1998;

M.A., University of Arizona, 2004; Ph.D., 2004.

JOHN M. WILKES (1975)

Associate Professor, Social Science and Policy Studies

B.A., Bates College, 1970;

M.A., Cornell University, 1973; Ph.D., 1976.

CRAIG E. WILLS (1990)

Associate Professor, Computer Science

B.S., University of Nebraska, 1982;

M.S., Purdue University, 1984; Ph.D., 1988.

KRISTIN NELSON WOBBE (1995)

Associate Professor, Chemistry and Biochemistry

B.A., St. Olaf College, 1983

Ph.D., Harvard University, 1991

JOHN P. WOYCHEESE (2000)

Assistant Professor, Fire Protection Engineering

B.S., University of California/Berkeley, 1994; M.S., 1996;

Ph.D., 2000.

ROBERT G. ZALOSH (1990)

Professor, Fire Protection Engineering

B.M.E., The Cooper Union, 1965;

M.S., University of Rochester, 1966;

Ph.D., Northeastern University, 1970.

Z. AMY ZENG (1999)

Associate Professor, Management

B.S., Beijing University of Aeronautics and
Astronautics, 1990;

M.S., University of Washington, 1992;

Ph.D., The Pennsylvania State University, 1996.

QINGYANG ZHANG (2002)

Research Assistant Professor, Bioengineering Institute

B.S., Shanghai University Industry College, 1981;

M.S., Shanghai University of Technology, 1988;

M.S., Worcester Polytechnic Institute, 1993; Ph.D., 1998.

H. SUSAN ZHOU (2005)

Assistant Professor, Chemical Engineering

B.S., Huazhong University (China), 1996;

M.S., Clarkson University, 1999;

Ph.D., University of California, 2002.

JOE ZHU (1998)

Associate Professor, Management

B.M., Huzhou Normal College (China), 1987;

M.S., Southeast University (China), 1992; Ph.D., 1995;

Ph.D., University of Massachusetts, 1998.

ALEX A. ZOZULYA (1998)

Professor, Physics

B.S., Moscow Engineering Physical Institute, 1978;

Ph.D., Lebedev Physics Institute of the Academy of

Sciences of the USSR, 1984.

FACULTY EMERITI

Numerals following name indicate years of service.

ALLEN BENJAMIN (1963-1980)

Professor Emeritus, Civil Engineering

LADISLAV H. BERKA (1965-2001)

Professor Emeritus, Chemistry and Biochemistry

RONALD R. BIEDERMAN (1968-2004)

Professor Emeritus, Mechanical Engineering

VAN F. W. BLUEMEL (1966-1999)

Professor Emeritus, Physics

ROGER R. BORDEN (1959-1987)

Professor Emeritus, Mechanical Engineering

ROY R. BOURGAULT (1955-1985)

Professor Emeritus, Mechanical Engineering

JOHN M. BOYD (1966-1994)

Professor Emeritus, Mechanical Engineering

GORDON C. BRANCHE (1959-1997)

Professor Emeritus, Mathematical Sciences

ELLIOT R. BUELL (1957-1978)

Professor Emeritus, Mathematics

A. FATTAH CHALABI (1959-1991)

Professor Emeritus, Civil Engineering

EDWARD N. CLARKE (1965-1994)

Professor Emeritus

VINCENT CONNOLLY (1956-1998)

Professor Emeritus, Mathematical Sciences

EDMUND T. CRANCH (1978-1985)

Professor Emeritus and President Emeritus

- LOUIS J. CURRAN, JR. (1966-2004)
Professor Emeritus, Humanities and Arts
- ROBERT A. D'ANDREA (1974-2005)
Professor Emeritus, Civil & Environmental Engineering
- FRANK D. DEFALCO (1960-1999)
Professor Emeritus, Civil & Environmental Engineering
- JAMES S. DEMETRY (1971-2000)
Professor Emeritus, Electrical & Computer Engineering
- RICHARD D. DESROSIERS (1972-1991)
Professor Emeritus, Civil Engineering
- WILHELM H. EGGIMANN (1964-1999)
Professor Emeritus, Electrical & Computer Engineering
- ROBERT W. FITZGERALD (1963-2005)
Professor Emeritus, Civil & Environmental Engineering and Fire Protection Engineering
- LEE FONTANELLA (1993-2002)
Professor and Department Head Emeritus, Humanities and Arts
- LEONARD GOODWIN (1974-1989)
Professor Emeritus, Social Science and Policy Studies
- HARTLEY T. GRANDIN, JR. (1957-1996)
Professor Emeritus, Mechanical Engineering
- LEON S. GRAUBARD (1969-2002)
Professor Emeritus, Management
- WILLIAM R. GROGAN (1946-1990)
Professor Emeritus, Electrical Engineering; Emeritus Dean of Undergraduate Studies
- RAYMOND R. HAGGLUND (1956-2004)
Professor Emeritus, Mechanical Engineering
- ROBERT J. HALL (1956-1990)
Professor Emeritus, Mechanical Engineering and Management; Former Director of Continuing Education
- MARY M. HARDELL (1972-1996)
Professor Emeritus, Computer Science
- WILLIAM J. HARDELL (1960-1994)
Professor Emeritus, Mathematical Sciences
- EDMUND M. HAYES (1964-1997)
Professor Emeritus, Humanities and Arts
- CHARLES R. HEVENTHAL (1963-1990)
Professor Emeritus, Humanities
- HAROLD W. HILSINGER (1962-1998)
Professor Emeritus, Physics
- WILLIAM D. HOBEY (1963-2005)
Professor Emeritus, Chemistry and Biochemistry
- DONALD W. HOWE (1942-1981)
Professor Emeritus, Electrical Engineering
- OWEN W. KENNEDY, JR. (1946-1987)
Professor Emeritus, Electrical Engineering; Emeritus Dean of Academic Computing
- KRISHNASWAMIENGAR KESHAVAN (1967-1998)
Professor Emeritus, Civil & Environmental Engineering
- NICHOLAS K. KILDAHL (1976-2005)
Professor Emeritus, Chemistry and Biochemistry
- WALTER A. KISTLER (1954-1994)
Professor Emeritus, Mechanical Engineering
- DIETER KLEIN (1979-1999)
Professor Emeritus, Management
- MICHAEL W. KLEIN (1979-1995)
Professor Emeritus, Physics
- CARL H. KOONTZ (1952-1986)
Professor Emeritus, Civil Engineering
- H. PETER LANYON (1967-1999)
Professor Emeritus, Electrical & Computer Engineering
- ROBERT LONG, II (1957-1995)
Professor Emeritus, Physics
- J. J. MALONE (1971-2000)
Professor Emeritus, Mathematical Sciences
- JOHN A. MAYER (1956-1990)
Professor Emeritus, Mechanical Engineering
- ARCHIE K. MC CURDY (1955-1994)
Professor Emeritus, Electrical and Computer Engineering
- DAVID P. MC KAY (1956-1993)
Professor Emeritus, Music
- BRUCE C. MC QUARRIE (1960-1990)
Professor Emeritus, Mathematical Sciences
- LAURA J. MENIDES (1976-2005)
Professor Emeritus, Humanities and Arts
- WILLIAM B. MILLER (1963-1989)
Professor Emeritus, Mathematical Sciences
- WILLIAM R. MOSER (1981-2000)
Professor Emeritus, Chemical Engineering
- DONALD F. NELSON (1981-2004)
Professor Emeritus, Physics
- MERL M. NORCROSS (1952-1994)
Professor Emeritus, Physical Education and Athletics
- NICHOLAS L. ONORATO (1955-1994)
Professor Emeritus, Social Science and Policy Studies/Management; Director, School of Industrial Management
- GILBERT H. OWYANG (1961-1990)
Professor Emeritus, Electrical Engineering
- EDWARD A. PARRISH (1995-2004)
Professor Emeritus and President Emeritus
- JOSEPH D. SAGE (1957-1994)
Professor Emeritus, Civil Engineering
- KENNETH E. SCOTT (1948-1991)
Professor Emeritus, Mechanical Engineering

THOMAS A. SHANNON (1973-2005)
Professor Emeritus, Humanities and Arts

MICHAEL M. SOKAL (1970-2005)
Professor Emeritus, Humanities and Arts

GEORGE E. STANNARD (1946-1986)
Professor Emeritus, Electrical Engineering

CARLTON W. STAPLES (1948-1986)
Professor Emeritus, Mechanical Engineering

ROBERT E. WAGNER (1949-1987)
Professor Emeritus, Chemical Engineering

ADRIAAN WALTHER (1972-2001)
Professor Emeritus, Physics

STEPHEN J. WEININGER (1965-2005)
*Professor Emeritus, Chemistry and Biochemistry, and
Interdisciplinary and Global Studies*

ALVIN H. WEISS (1966-1994)
Professor Emeritus, Chemical Engineering

JERALD A. WEISS (1962-1988)
Professor Emeritus, Physics

LESLIE C. WILBUR (1957-1987)
*Professor Emeritus, Mechanical Engineering;
Professor and Chairman of Nuclear Reactor Facility Emeritus*

JOHN F. WILD (1962-1992)
Professor Emeritus, Physics

LYLE E. WIMMERGREN (1969-1994)
Professor Emeritus, Management

DOUGLAS W. WOODS (1970-2000)
Professor Emeritus, Social Science and Policy Studies

JOHN F. ZEUGNER (1971-2005)
Professor Emeritus, Humanities and Arts

DONALD N. ZWIEP (1957-1990)
*Professor and Department Head Emeritus,
Mechanical Engineering*

SPECIAL PROFESSORSHIPS

YI H. MA
Frances B. Manning Professorship

UMBERTO MOSCO
Harold J. Gay Professorship in Mathematics

RYSZARD J. PRYPUTNIEWICZ
*Kenneth G. Merriam Distinguished
Professorship (2004-2007)*

MALCOLM H. RAY
Ralph H. White Family Distinguished Professorship

YIMING (KEVIN) RONG
*John Woodman Higgins Professorship in
Engineering (2002-2005) (2005-2008)*

BOARD OF TRUSTEES' AWARD FOR OUTSTANDING CREATIVE SCHOLARSHIP

1983 LEONARD GOODWIN and DAVID P. MC KAY
1984 ALVIN H. WEISS
1985 LEONARD B. SAND
1986 ALEXANDER E. EMANUEL
1987 MICHAEL W. KLEIN
1988 THOMAS A. SHANNON and MICHAEL M. SOKAL
1989 ALLEN H. HOFFMAN
1990 PAUL W. DAVIS and L. RAMDAS RAM-MOHAN
1991 RYSZARD J. PRYPUTNIEWICZ
1992 GEORGE D. J. PHILLIES
1993 WESLEY T. MOTT
1994 YI H. MA
1995 DONALD F. NELSON
1996 DAVID CYGANSKI
1996 ALBERT SACCO, JR.
1996 CHRISTOPHER H. SOTAK
1997 DAVID C. BROWN
1998 KENT P. LJUNGQUIST
1999 WILLIAM R. MOSER
2000 PAMELA J. WEATHERS
2001 BARBARA E. WYSLOUZIL
2002 W. GRANT McGIMPSEY
2003 STEVEN C. BULLOCK
2004 NIKOLAOS A. GATSONIS
2005 HOMER F. WALKER

**BOARD OF TRUSTEES' AWARD
FOR OUTSTANDING TEACHING**

1968 WILBUR B. BRIDGMAN
 1969 WILLIAM R. GROGAN
 1970 JOHN P. VAN ALSTYNE
 1971 KENNETH E. SCOTT
 1972 ROBERT E. WAGNER
 1973 JAMES HENSEL
 1974 RAYMOND R. HAGGLUND
 1975 ROMEO L. MORUZZI
 1976 JOHN M. BOYD
 1977 FRANK D. DEFALCO
 1978 THOMAS H. KEIL
 1979 CARLTON W. STAPLES
 1980 ALLEN H. HOFFMAN
 1981 JAMES W. PAVLIK
 1982 ALEXANDER E. EMANUEL
 1983 HARTLEY T. GRANDIN, JR.
 1984 DAVID CYGANSKI
 1985 JOHN F. ZEUGNER
 1986 DAN H. WOLAVER
 1987 RICHARD D. SISSON, JR.
 1988 PATRICK P. DUNN
 1989 HAROLD W. HILSINGER
 1990 DAVID S. ADAMS
 1991 ROBERT LONG II
 1992 ANDREAS N. ALEXANDROU
 1993 RICHARD F. VAZ
 1994 L. RAMDAS RAM-MOHAN
 1995 JAMES S. DEMETRY
 1996 VAN BLUEMEL
 1996 NICHOLAS K. KILDAHL
 1997 SUSAN VICK
 1998 LEONARD D. ALBANO
 1999 JOHN A. McNEILL
 2000 STEPHEN J. WEININGER
 2001 STEPHEN N. JASPERSON
 2002 CHRYSANTHE DEMETRY
 2003 HELEN G. VASSALLO
 2004 JUDITH E. MILLER
 2005 ROBERT L. NORTON

**BOARD OF TRUSTEES' AWARD
FOR OUTSTANDING SERVICE**

1989 WILLIAM R. GROGAN

**TRUSTEES' AWARD FOR
OUTSTANDING ACADEMIC
ADVISING** (Formerly Tau Beta Pi Award, 1991-1999)

1991 JOHN F. ZEUGNER
 1992 MARY M. HARDELL
 1993 JOHN GRIFFIN
 1994 KENT P. LJUNGQUIST
 1995 ROBERT A. D'ANDREA
 1996 LEONARD D. ALBANO
 1997 JILL RULFS
 1998 MICHAEL A. GENNERT
 1999 RICHARD F. VAZ
 2000 DAVID S. ADAMS
 2001 ALEXANDER E. EMANUEL
 2002 PHILLIP E. ROBAKIEWICZ
 2003 JONATHAN R. BARNETT
 2004 GEORGE D. PINS
 2004 ANN GARVIN
 2005 JEANINE D. PLUMMER

**DENISE NICOLETTI TRUSTEES'
AWARD FOR SERVICE TO
COMMUNITY**

2003 JAMES P. O'ROURKE
 2004 WILLIAM A. BALLER
 2005 HOLLY K. AULT

- Academic Advising 23
Academic Policies and Procedures 243
Academic Probation 247
Academic Progress 247
Academic Resources Center 18
Academic Suspension 247
Academic Technology Center 17
Academic Warning 247
Accounting (ACC) 222
Accreditation 309
Actuarial Mathematics 27, 156
Actuarial Mathematics Major Program Chart 158
Administration 282
Administrative Obligations 248
Admission 262, 266
Admission, Expenses, Financial Aid and Housing 265
Advanced Casting Research Center 9
Advanced Casting Research Center (ACRC) 9, 10
Advanced Chemistry Courses 198, 199
Advanced Placement 267
Advising and Student Services 17
Aerospace Engineering 27, 65
Aerospace Engineering Program Chart 66
Aerospace Laboratory 11
Aerospace Studies 188, 189
Air Force Aerospace Studies 67
Algebraic and Discrete Mathematics 152
Alternative Financial Programs 275
Analog/Mixed Signal Microelectronics Laboratory 11
Antenna Laboratory 11
Application Fee 266
Application for Degree 249
Application Procedures 271
Applying To WPI 266
Areas for the Sufficiency in Humanities and Arts 54
Art History/Architecture 210
Athletic Programs 168
Australia Project Program 51
Available Projects 36
Awards and Prizes 60
Awards and Scholarships 52
- Bangkok Project Center 50
Basic Sciences 189
Biochemistry 27, 98
Biochemistry Courses 198, 199
Biology and Biotechnology 27, 68, 189
Biology and Biotechnology with Concentration 27
Biomaterials 83
Biomaterials Laboratory 12
Biomechanical Engineering Laboratories 11
Biomechanics 90
Biomechanics/Biofluids Laboratory 12
Biomedical Engineering 28, 72, 193
Biomedical Engineering Program Chart 66, 82
Biomedical Imaging 98
Bioprocess Laboratory 12
Biosensors and Bioinstrumentation 100
Board Charges upon Withdrawal or Suspension 270
Boston Project Program 48
Business (BUS) 222
- Campus Map IBC
Career Development and Graduate School 261
Career Fairs 261
Career Resource Center 261
Career Workshops 261
Center for Communication Across the Curriculum 37
Center for Heat Treating Excellence (CHTE) 9, 11
Center for Holographic Studies and Laser
Technology (CHLST) 10
Center for Sensory and Physiologic Signal
Processing C(SP)2 12
Center for Wireless Information Networking Studies 12
Center of Comparative Neuroimaging (CCNI) 12
Ceramic Processing Laboratory 12
Change of Registration 250
Charge 269
Chemical Engineering 28, 93, 195
Chemical Engineering Suggested Course Sequence 95
Chemistry 28, 99
Chemistry and Biochemistry 97, 197
Chronology of Academic Schedule and Events IFC
City Lab 12
Civil and Environmental Engineering 101, 200
Civil and Environmental Engineering Program Chart 104
Civil Engineering 28
Class Year 247
Coding of Project Advisors 252
College Awards 60
Combined Bachelor's/ Master's Program 263
Commitment to Pluralism 4
Company Presentations 261
Computational and Applied Analysis 153
Computational Gas and Plasma Dynamics Laboratory 13
Computer Classroom 8
Computer Music Laboratories 16
Computer Resources 8
Computer Science 28, 108, 202
Computer Science Course Flow Chart 112
Computer Science Minor 114
Computer Science Program Chart 110
Computer Science Project Laboratories 9
Computerized Resume Database 261
Computers with Applications 29
Concentrations 25
Concentrations for Chemical Engineering Majors 94
Concentrations for Humanities and Arts Majors 128
Convergent Technologies Center 13
Cooperative Education Program 257
Costa Rica Project Center 50
Course Categories 188
Course Changes 249
Course Credit 188
Course Descriptions 187, 188
Course Numbering 188
Courses Qualifying for Engineering Distribution Areas 35
Credit Units 21
Cryptography and Information Security (CRIS)
Laboratory 13
Cumulative Point Average 244
Currency of Information 310

- Data/Knowledge Base Research Laboratory 13
Degree Audits 246
Degree Requirements 21
Degrees and Requirements 263
Denmark Project Center 48
Department and Program Descriptions 64
Department of Management 141
Departmental Descriptions 65
Design Studio 8
Designation of Class Year 247
Designation of Major Area of Study 247
Developing a Sufficiency Program 54
Directions 310
Directory Information and Release of Information 248
Discovery Classroom 9
Distributed Processing Laboratory 13
Double Majors 26, 247
Drama/Theatre Resource Library 16
- Early Action 267
Ecole Polytechnique; Montreal, Quebec, Canada 256
Economic Growth, Stability and Development 44
Economic Science 29, 176
Education in a Technological Society 45
Electrical and Computer Engineering 29, 114, 205
Electrical and Computer Engineering Course
 Flow Chart 121
Energy and Resources 40
Engineering Experimentation Laboratory 10
Engineering Physics 33, 123
Engineering Registration and Licensing 259
Engineering Science Courses 123
Engineering Science Interdisciplinary 208
Engineering Societies 259
English 210
English as a Second Language (ESL) Program 268
Enrollment 249, 269
Entrepreneurship (ETR) 222
Entrepreneurship Minor 145
Environmental Economics and Public Policy 125
Environmental Engineering 124
Environmental Policy and Development 30, 177
Environmental Programs 124
Environmental Sciences 125
Environmental Studies 125
Estimated Expenses 269
Ethical and Professional Conduct 309
Examination 259
Expenses 269
- Faculty 291
Fellowships 262
Finance (FIN) 223
Financial Aid 262, 266, 271
Financial Aid Policies 273
Financial Aid upon Withdrawal/Suspension 270
Fire Protection Engineering 126, 189, 209
Fire Science Laboratory 13
First-Year Advising 23
Fluid Dynamics Laboratory 13
Foreign Language Sufficiency 57
Forms of Aid 272
Fulbright Grants 263
Fundamentals of Engineering Examination 259
Furnishings and Facilities 276
- Gender, Race, and Technology 52
General Chemistry Sequence 198
General Computer Science Department Facilities 8
Geosciences 189, 210
German 213
Getting Started in Humanities and Arts 56
Gillette Company Project Center 38
Global Technological University 6
Goal of Worcester Polytechnic Institute 3
Goals of the Sufficiency 53
Grade System Selection 243
Grades 243
 Grade Appeal and Grade Change Policy 245
 Grades for Completion of Degree Requirements 243
 Incomplete (I) 243
 No Record (NR) 243
 Other Grades 243
 Satisfactory Progress (SP) 243
Graduate Admission 262
Graduate Assistantships 262
Graduate Biology and Biotechnology Courses 192
Graduate Biomedical Engineering Courses 194
Graduate Calendar 2006-2007 ii
Graduate Chemical Engineering Courses 196
Graduate Chemistry Courses 199
Graduate Course Listings 264
Graduate Fire Protection Engineering Courses 209
Graduate Physics Courses 236
Graduate Program 262
Graduate Studies 261
Graduation with Honors 244
Great Hall of Alden 16
Green Room 16
- Haas Technical Center for Computer-Controlled
 Machining 9, 10
Health Care and Technology 41
Historic and Artistic Preservation Technology 46
History 213
Hong Kong, China Project Center 50
Housing 276
Humanistic Studies of Technology 44
Humanities 216
Humanities and Arts 30, 127, 210, 211
Humanities and Arts Minors 130
Hydrodynamics Laboratory 14
- Improvement in Status 248
Independent Study Registration 249
Individual Career Counseling 261
Industrial Engineering 30, 131, 137
Industrial Engineering Program Chart 138
Inorganic and Physical Chemistry Courses 198
Interactive Media and Game Development 30, 131, 220
Interactive Qualifying Project 21, 39
Interdisciplinary 31, 220, 221
Interdisciplinary Programs 132
International Students 268
International Studies 31, 134
International Studies Minor 129
- Job Opportunities 261
Keck Design Center 8

- Laboratories and Facilities 11
 Language Requirements 256
 Laser Laboratories 14
 Law and Technology 46
 Law and Technology Minor 135, 136
 Library 16
 Licensing 259
 Limerick, Ireland 49
 Lincoln Laboratory Project Center 38
 Little Theatre 16
 ing Museums Program 52
 London Humanities Programs 49
 London Project Center 49
- Major Areas of Study 24
 Major Qualifying Project 21, 39
 Major Selection Program 18
 Management 31, 136, 140, 222
 Management Engineering 32, 141
 Management Information Systems 32, 141
 Management Information Systems (MIS) 223
 Management Information Systems Minor 146
 Management Microcomputer Laboratory 9
 Management Minor 146
 Manufacturing Design Studio 9
 Manufacturing Engineering 32, 147
 Manufacturing Engineering Program Chart 148
 Manufacturing Engineering Research Center 9
 Manufacturing Laboratory 14
 Marketing (MKT) 224
 MASH 18
 Master Builder Program 105
 Materials Engineering 150
 Math and Science Help 18
 Mathematical Sciences 32, 151, 225
 Mathematical Sciences Major Program Chart 155
 Mathematics Laboratories 14
 Mathematics Minor 159
 Matriculate 267
 Meals 277
 Mechanical Engineering 33, 160, 229
 Mechanical Engineering Department Concentrations 163
 Mechanical Engineering Program Chart 161
 Mechanical Engineering Project Laboratory 10
 Mechanical Testing Laboratories 14
 Metal Processing Institute (MPI) 10
 Military Science 166, 233
 Military Science Course Flow Chart 167
 Minimum Academic Credit 21
 Minimum Distribution Requirements for Students 27
 Minor in Computer Engineering 123
 Minor in Foreign Language (German or Spanish) 130
 Minor in Manufacturing Engineering 150
 Minor in Materials 150
 Minor in Music 130
 Minor in Writing and Rhetoric 131
 Minors 25
 MIS/OIE Oracle/Lean Lab 9
 Mission of Worcester Polytechnic Institute 3
 Monterrey Institute of Technology; Monterrey, Mexico 256
 Morris (Butch) Boorky Powder Metallurgy
 Research Center 9, 11
 Music 216
 Music and Theater Facilities 16
 Music Ensembles 217
- New Student Orientation 267
 Nondiscriminatory Policy 309
 Notification 266
 Nuclear Magnetic Resonance (NMR) Imaging Facility 14
- Occupancy 276
 Off-Campus Graduate Study 264
 Off-Campus Insurance and Legal Agreements 37
 Off-Campus Living 277
 Off-Campus Sufficiency Option 58
 On-Campus IQP Programs 52
 Operations and Industrial Engineering (OIE) 224
 Operations Research 154
 Optical and Electron Microscopy Laboratories 14
 Organic Chemistry Courses 197, 198
 Organizational Behavior and Change (OBC) 225
 Organizational Leadership Minor 147
 Overload Charges 269
 Overloads of Courses 249
- Part-Time Graduate Program 263
 Pavement Research Laboratory 14
 Payment of Tuition Deposit 269
 Petitions 248
 Philosophy 218
 Physical Education 21, 168, 234
 Physics 33, 169, 235
 Physics and Engineering-Physics Programs 171
 Physics for Nonphysics Majors 172
 Physics Minor 173
 Placement Process 258
 Planning for Professional Development 22
 Planning Process 22
 Policies & Practices 309
 Powder Metallurgy Research Center (PMRC) 9
 Pre-Law Programs 173, 174
 Pre-Mba Program (Dual Degree) 173
 Pre-Medical, Pre-Dental and Pre-Veterinary Program 174
 Preparing for the IQP 39
 President's IQP Awards 52
 Probability and Statistics 156
 Professional Development 22
 Professional Writing 33
 Professionally Accredited Programs 22
 Programs in Asia 50
 Programs in Australia 51
 Programs in Europe 48
 Programs in Latin America 50
 Programs in the United States 47
 Project Advisors 36, 250, 252
 Project and Educational Facilities 9
 Project and Independent Study Registration 249
 Project Centers 37
 Project Grading 243
 Project Performance 36
 Project Registration Topic Codes 251
 Project-Based Learning Community Option 175, 257
 Projects 35
 Projects Program 37
 Provost's MQP Awards 52
 Psychological Science 177
 Puerto Rico Project Center 51

- Qualifications 266
Qualifying Project Documentation 36
- Readmission 267
Readmission after Suspension 248
Registration 249
Registration and Tuition Payment 262
Registration Policy for Degree Requirements 250
Rehabilitation Engineering Laboratory 12
Release of Information 248
Religion 218
Research Centers and Institutes 10
Research Laboratories and Facilities 11
Reserve Officer Training Corps (ROTC) Scholarships 273
Residence Halls/Staff 276
Residency Requirement 21
Residential Programs 47
Residential Project Programs 47
Resources Available To Undergraduates 8
Resources in Fuller Laboratories 8
Resources in Higgins Laboratories 8
Resources in the Washburn Laboratories 9
Rhetoric and Writing 220
Rhodes Scholarships 262
Robotics 175
Room Charges 276
Room Charges upon Withdrawal or Suspension 270
Roommates 276
Royal Institute of Technology; Stockholm, Sweden 256
- Safety Analysis and Liability 43
Satellite Navigation Laboratory 15
Satisfactory Academic Progress 247
Scholarships and Grants for Graduate Study Abroad 262
Science and Technology: Policy and Management 42
Signal Processing and Information Networking Laboratory 15
Silicon Valley Project Center 48
Social and Human Services 45
Social Science and Policy Studies 175, 237
Social Science Minors 186
Social Science Requirement 60
Social Studies of Science and Technology 42
Societies, Registration and Licensing 259
Society of Actuaries (SOA) Examinations 159
Society, Technology and Policy 34, 178
Software Engineering Research Lab 15
Spanish 219
Spaulding Recital Hall 16
Special (SU, SX) Students 270
Special Awards 61
Special Students 248, 250
Standardized Tests 266
Statement of Values for Undergraduate Education at WPI 3
Statistics Minor 159
Student Absence Due To Religious Beliefs 309
Student Development and Counseling Center 17
Student Disability Services Office 18
Student Exchanges 255
Students Tuition Charges upon Withdrawal or Suspension 269
Sufficiency 21, 53
Sufficiency for International Students 58
Sufficiency Program for Humanities and Arts Majors 57
Summer Bridge Program 248
Summer Study (Term E) 258
Surface Metrology Laboratory (Surf Met Lab) 15
System Dynamics 34, 176
- Teacher Licensing 134
Technical College; Munich, Germany 256
Technical University; Darmstadt, Germany 256
Technology and Environment 40
Term E Review Period 248
Terms 21
Tissue Engineering 102
Transcript 246
Transfer Agreement 268
Transfer and 3-2 Students 268
Transfer Credit 57, 244
Transfer Students 246, 267
Transfer Students and the Sufficiency Requirement 53
Trustees 279
Trustees, Administration and Faculty 278
Tufts School of Veterinary Medicine Project Center 38
Tuition 269
Tuition Deposit 269
Two Towers Tradition 5
- Ultrasound Research Laboratory 15
Undergraduate Calendar 2006-2007 i
Undergraduate Learning Outcomes 4
Unique Opportunities 254
Units 21
University of Massachusetts Medical School 38
Upperclass Advising 23
Urban and Environmental Planning 41
- Venice Project Center 49
Vibrations/Control/Dynamics Laboratory 15
Visiting the Campus 266
Visualization and Image Science Laboratory 15
VLSI Design Laboratory 15
- Wait Lists 249
Washington Project Center 47
Withdrawal From Courses 249
Withdrawal From WPI 249
Worcester Community Project Center 48
Worcester Consortium Course Cross-Registration 257
World Wide Web 19
WPI Plan 5, 20
Writing 220
Writing Courses and Advisors 19
Writing Workshop 19
- X-Ray Diffraction Laboratory 16

Worcester Polytechnic Institute is accredited by the New England Association of Schools and Colleges, Inc., a non-governmental, nationally recognized organization whose affiliated institutions include elementary schools through collegiate institutions offering post-graduate instruction.

Accreditation of an institution by the New England Association indicates that it meets or exceeds criteria for the assessment of institutional quality periodically applied through a peer group review process. An accredited school or college is one which has available the necessary resources to achieve its stated purposes through appropriate educational programs, is substantially doing so, and gives reasonable evidence that it will continue to do so in the foreseeable future. Institutional integrity is also addressed through accreditation.

Accreditation by the New England Association is not partial but applies to the institution as a whole. As such, it is not a guarantee of the quality of every course or program offered, or the competence of individual graduates. Rather, it provides reasonable assurance about the quality of opportunities available to students who attend the institution.

In addition, the programs leading to majors in biomedical engineering, chemical engineering, civil engi-

neering, electrical and computer engineering, industrial engineering, manufacturing engineering and mechanical engineering are accredited by the Engineering Accreditation Commission of ABET.

The Chemistry and Biochemistry Department and its program at WPI are approved by the American Chemical Society for a major in chemistry or biochemistry. Those chemistry majors who complete a program satisfying the guidelines established by the American Chemical Society are certified to that organization as having received an undergraduate professional education in chemistry or biochemistry.

The Computer Science program has been accredited by the Computing Accreditation Commission of ABET.

The undergraduate and graduate business offerings in the Department of Management are accredited by AACSB International, the Association to Advance Collegiate Schools of Business. AACSB International is a not-for-profit organization consisting of more than 900 educational organizations and corporations. Its mission is excellence in management education in colleges and universities. Headquartered in Tampa, Florida, AACSB International is the premier accrediting agency and service organization for business schools.

POLICIES & PRACTICES

NOTICE OF NONDISCRIMINATORY POLICY AS TO STUDENTS

It is the policy of Worcester Polytechnic Institute that each qualified individual, regardless of race, color, sex, religion, sexual orientation, national origin, age as defined by law, or handicap, shall have equal opportunity in education, employment or services of Worcester Polytechnic Institute. It is the policy of WPI to follow U.S. federal government eligibility guidelines in the administration of its institutional financial aid program.

STUDENT RESPONSIBILITIES FOR ETHICAL AND PROFESSIONAL CONDUCT

WPI expects all its students to demonstrate the highest sense of honor in respecting academic and professional traditions such as acknowledging the borrowing or use of other people's ideas. Willful violations (like plagiarism) of such academic traditions or of legal restrictions (like those regarding copyright) will be considered violations of the "Campus Code" as described in the *Student Planner*.

WPI education is strongly committed to project-based learning, to providing students with access to state-of-the-art technology, and to working with professionals, on and off campus. Therefore, when students are exposed to proprietary and/or confidential information, they must accept responsibilities appropriate to their preparation for life-long careers in which codes of ethics govern professional conduct.

Facilities such as the off-campus projects, employment sites, and those listed in "Resources Available to Undergraduates" (pages 8-16) permit students to gain experi-

ence with techniques at the forefront of industrial and research development. With this access comes the added responsibility of safeguarding students of any agreements they sign regarding conditions or restrictions for access to certain equipment or information will also be considered a violation of the "Campus Code" as described in the *Student Planner*.

Record of any penalties assigned by the WPI Campus Judicial System which result from violation of standards of ethical conduct will become a permanent part of that student's disciplinary record.

STUDENT ABSENCE DUE TO RELIGIOUS BELIEFS

Section 2B, Chapter 151C of the General Laws of the Commonwealth of Massachusetts: "Any student in an educational or vocational training institution, other than a religious or denominational educational or vocational training institution, who is unable, because of his/her religious beliefs, to attend classes or to participate in any examination, study, or work requirement on a particular day shall be excused from any such examination or study or work requirement, and shall be provided with an opportunity to make up such examination, study, or work requirement which he/she may have missed because of such absence on any particular day; provided, however, that such makeup examination or work shall not create an unreasonable burden upon such school. No fees or any kind shall be charged by the institution for making available to the said student such opportunity. No adverse or prejudicial effects shall result to any students because of his/her availing himself/herself of the provisions of this section."

The information contained in this *Undergraduate Catalog* is not a complete statement of all the policies, practices, rules and regulations of Worcester Polytechnic Institute. Any statement made in this publication is for current informational purposes only and is subject to change by the governing body of WPI or its duly authorized representatives. Certain policies, rules and regulations are not published in this publication but are promulgated directly by the appropriate department. Members of the WPI community are expected to abide by the current policies,

practices, rules and regulations of the college, even though they may not be contained in this publication or may not be consistent with the information contained in this publication, whether due to a properly authorized change or to a printing error.

Changes, deletions, and additions authorized by the governing body of WPI, after the printing of this catalog, are posted on WPI's web page at www.wpi.edu/ as a supplement to the undergraduate catalog, and includes the effective date of the action.

DIRECTIONS

DRIVING TO WPI

FROM THE EAST:

Take Mass. Turnpike (I-90) to Exit 11A (I-495). Proceed north to I-290, then west into Worcester. Take Exit 18, turn right at end of ramp, then an immediate right before next traffic light. At next light, proceed straight through, bearing to the right on Salisbury St. At the WPI sign, turn left onto Boynton St., then right onto Institute Rd., then right onto West St. Visitor parking is on the left after footbridge.

FROM THE NORTH:

Take I-495 south to I-290. Follow directions as from east.

FROM THE SOUTH AND WEST:

Take Mass. Turnpike (I-90) to Exit 10 (Auburn). Proceed east on I-290 into Worcester. Take Exit 17, turn left at end of ramp, follow Rte. 9 west through Lincoln Sq., straight onto Highland St., then right at light onto West St. and through first intersection. Visitor parking is on the left after footbridge.

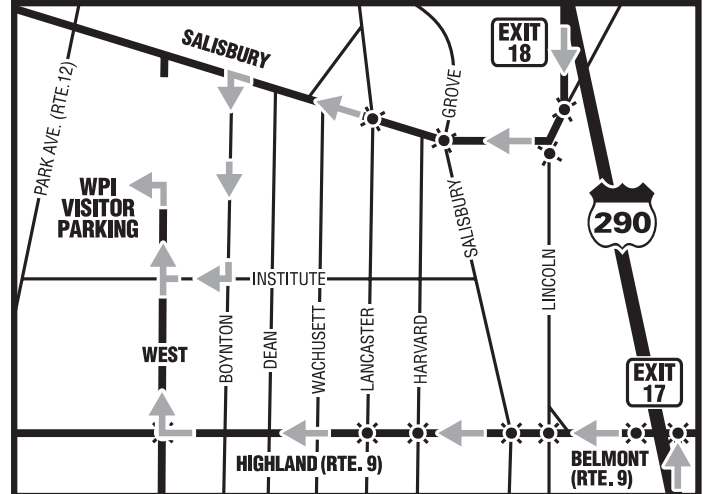
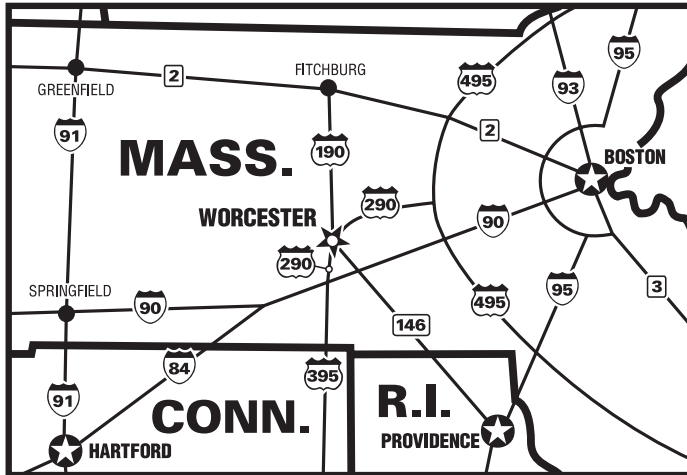

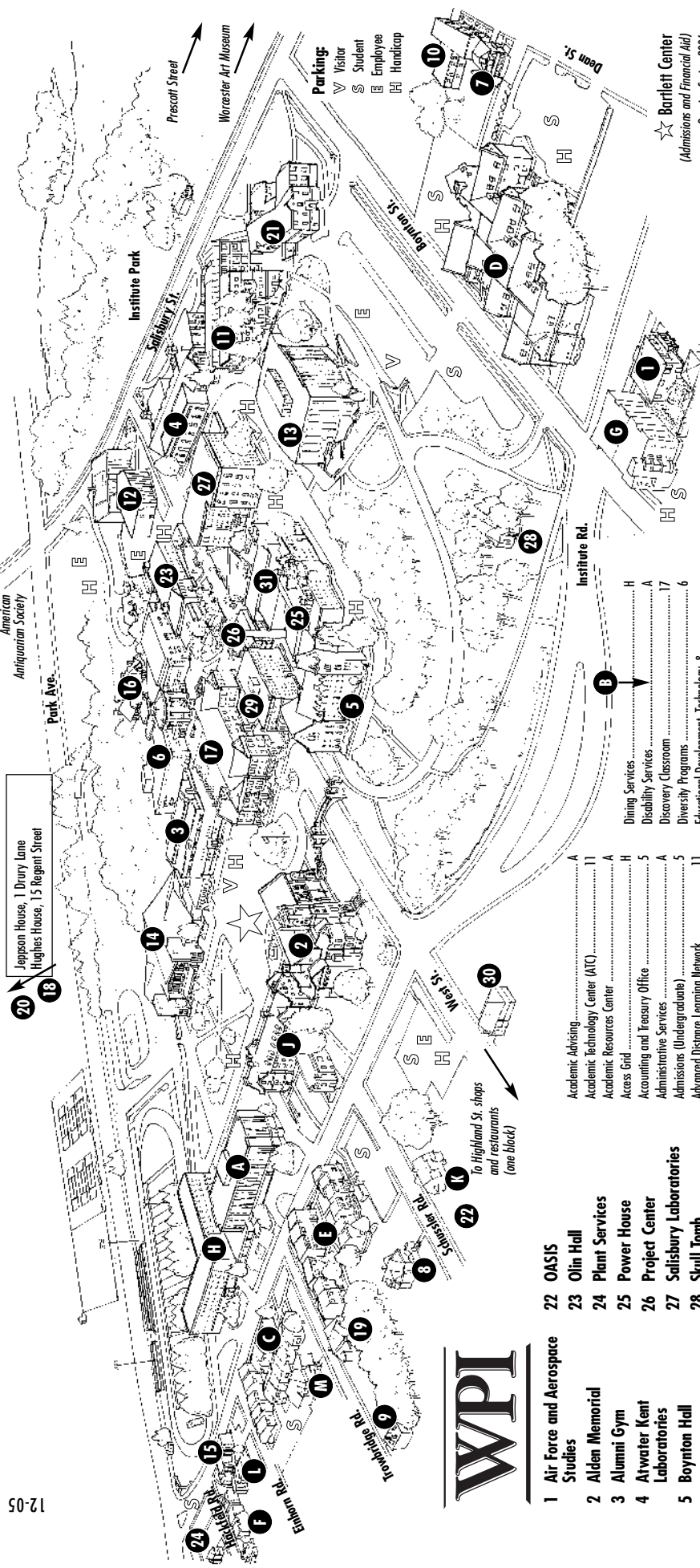

- 1 Air Force and Aerospace Studies
- 2 Alden Memorial Alumni Gym
- 3 Atwater Kent Laboratories
- 5 Boynton Hall
- 6 Campus Center
- 7 Campus Police
- 8 Collegiate Religious Center
- 9 20 Trowbridge Road
- 10 39 Dean Street
- 11 Fuller Laboratories
- 12 Goddard Hall
- 13 Gordon Library
- 14 Harrington Auditorium
- 15 Health Center
- 16 Higgins House
- 17 Higgins Laboratories
- 18 Hughes House
- 19 International House
- 20 Jeppson House
- 21 Kaven Hall
- 22 OASIS
- 23 Olin Hall
- 24 Plant Services
- 25 Power House
- 26 Project Center
- 27 Salisbury Laboratories
- 28 Skull Tomb
- 29 Stratton Hall
- 30 Student Development and Counseling Center
- 31 Washburn Shops and Stoddard Laboratories
- A Daniels Hall
- B 16 Elbridge
- C Elsworth Apartments
- D Founders Hall
- E Fuller Apartments
- F Unity House
- G Institute Hall
- H Morgan Hall
- J Sanford Riley Hall
- K 22 Schussler
- L Stoddard Complex
- M 25 Trowbridge

Massachusetts Academy of Math & Science is located at Gateway Park, 89 Prescott St., Worcester

Dining Services.....	H
Disability Services.....	A
Discovery (Classroom).....	17
Diversity Programs.....	6
Educational Development, Technology, & Assessment, Center for.....	10
Electrical & Computer Engineering Dept.....	4
Emergency Medical Service.....	7
Entrepreneurship & Innovation, Collaborative for.....	31
ESL Program.....	19
Events Office.....	6
Extended Education, Division of.....	10*
Faculty Governance.....	H
Financial Aid.....	29
Fire Protection Engineering Dept.....	17
Fitness Center.....	3
Food Court.....	6
Government & Community Relations.....	16
Graduate Studies & Enrollment.....	10
Health Alternatives.....	3
Health Center.....	L
Higgins Club (dining room).....	16
Higgins Lecture Hall.....	31
Human Resources.....	10
Humanities & Arts Dept.....	11
Information Technology (IT).....	27
Interdisciplinary & Global Studies.....	26
International Students & Scholars.....	19
K-12 Outreach Programs.....	17
Kinnicart Lecture Hall.....	27
Lens & Lights.....	6
Little Theatre.....	J

Mail Services.....	6
Major Selection Program.....	26
Management Dept.....	31
Manufacturing Engineering.....	31
Marketing & Communications.....	5
Masque Office.....	2
Materials Science & Engineering.....	31
Mathematical Sciences Dept.....	29
Mechanical Engineering Dept.....	17
Media Relations.....	5
Metal Processing Institute.....	31
Military Science Dept.....	14
Network Operations.....	H
Newell Lecture Hall.....	14
Nuclear Reactor Facility.....	31
Odeum.....	6
Parvill.....	10
Peddler (yearbook).....	6
Perreault Lecture Hall.....	11
Physical Education, Recreation, & Athletics.....	3
Physics Dept.....	5, 9, 16
Telecommunications.....	25
Tech News (student newspaper).....	6
Wedge, The.....	H
Women's Programs.....	3
Wrestling Facility.....	3

Property Administration.....	A
Provost's Office.....	5
Racquetball Courts.....	14
Radio Station WWPI.....	6
Registrar's Office.....	5
Research Administration.....	A
Residential Services.....	C
Riley Commons.....	J
School of Industrial Management.....	*
Social Committee (SocComm).....	6
Social Science & Policy Studies Dept.....	4
Sports Information.....	3
Squash Courts.....	14
Student Activities.....	6
Student Affairs and Campus Life.....	6
Student Development & Counseling Ctr.....	30
Swimming Pool.....	3
Tech News (student newspaper).....	6
Telecommunications.....	25
University Advancement.....	5, 9, 16
Wedge, The.....	H
Women's Programs.....	3
Wrestling Facility.....	3

Bartlett Center
(Admissions and Financial Aid)
Opening Spring 2006

* 85 Prescott Street

Worcester Polytechnic Institute

100 Institute Road
Worcester, MA 01609-2280